



## COMOSAR E-Field Probe Calibration Report

Ref : ACR.60.10.22.MVGB. B

Cancel and replace the report ACR.60.10.22.MVGB.A

**SHENZHEN STS TEST SERVICES CO., LTD.**  
**1/F, BUILDING 2, ZHUOKE SCIENCE PARK, CHONGQING**  
**ROAD**  
**FUYONG, BAO' AN DISTRICT, SHENZHEN, CHINA**  
**MVG COMOSAR DOSIMETRIC E-FIELD PROBE**  
**SERIAL NO.: SN 07/21 EPGO352**

**Calibrated at MVG**  
**Z.I. de la pointe du diable**  
**Technopôle Brest Iroise – 295 avenue Alexis de Rochon**  
**29280 PLOUZANE - FRANCE**

**Calibration date: 28/02/2022**



Accreditations #2-6789 and #2-6814  
Scope available on [www.cofrac.fr](http://www.cofrac.fr)

### *Summary:*

This document presents the method and results from an accredited COMOSAR E-Field Probe calibration performed at MVG, using the CALIPROBE test bench, for use with a MVG COMOSAR system only. The test results covered by accreditation are traceable to the International System of Units (SI).



	<i>Name</i>	<i>Function</i>	<i>Date</i>	<i>Signature</i>
<i>Prepared by :</i>	Jérôme Luc	Technical Manager	2/28/2022	<i>JL</i>
<i>Checked by :</i>	Jérôme Luc	Technical Manager	2/28/2022	<i>JL</i>
<i>Approved by :</i>	Yann Toutain	Laboratory Director	2/28/2022	<i>Yann TOUTAIN</i>

Mode d'emploi  
2022.02.2  
8 10:36:50  
+01'00'

PHILIPS

	<i>Customer Name</i>
<i>Distribution :</i>	Shenzhen STS Test Services Co., Ltd.

<i>Issue</i>	<i>Name</i>	<i>Date</i>	<i>Modifications</i>
A	Jérôme Luc	2/28/2022	Initial release

## TABLE OF CONTENTS

1	Device Under Test .....	4
2	Product Description .....	4
2.1	General Information .....	4
3	Measurement Method .....	4
3.1	Linearity .....	4
3.2	Sensitivity .....	5
3.3	Lower Detection Limit .....	5
3.4	Isotropy .....	5
3.1	Boundary Effect .....	5
4	Measurement Uncertainty .....	6
5	Calibration Measurement Results .....	6
5.1	Sensitivity in air .....	6
5.2	Linearity .....	7
5.3	Sensitivity in liquid .....	8
5.4	Isotropy .....	9
6	List of Equipment .....	10

## 1 DEVICE UNDER TEST

Device Under Test	
Device Type	COMOSAR DOSIMETRIC E FIELD PROBE
Manufacturer	MVG
Model	SSE2
Serial Number	SN 07/21 EPGO352
Product Condition (new / used)	Used
Frequency Range of Probe	0.15 GHz-6GHz
Resistance of Three Dipoles at Connector	Dipole 1: R1=0.227 MΩ Dipole 2: R2=0.203 MΩ Dipole 3: R3=0.195 MΩ

## 2 PRODUCT DESCRIPTION

### 2.1 GENERAL INFORMATION

MVG's COMOSAR E field Probes are built in accordance to the IEEE 1528, FCC KDB865664 D01, CENELEC EN62209 and CEI/IEC 62209 standards.



**Figure 1** – MVG COMOSAR Dosimetric E field Dipole

Probe Length	330 mm
Length of Individual Dipoles	2 mm
Maximum external diameter	8 mm
Probe Tip External Diameter	2.5 mm
Distance between dipoles / probe extremity	1 mm

## 3 MEASUREMENT METHOD

The IEEE 1528, FCC KDB865664 D01, CENELEC EN62209 and CEI/IEC 62209 standards provide recommended practices for the probe calibrations, including the performance characteristics of interest and methods by which to assess their affect. All calibrations / measurements performed meet the fore mentioned standards.

### 3.1 LINEARITY

The evaluation of the linearity was done in free space using the waveguide, performing a power sweep to cover the SAR range 0.01W/kg to 100W/kg.



### 3.2 SENSITIVITY

The sensitivity factors of the three dipoles were determined using a two step calibration method (air and tissue simulating liquid) using waveguides as outlined in the standards.

### 3.3 LOWER DETECTION LIMIT

The lower detection limit was assessed using the same measurement set up as used for the linearity measurement. The required lower detection limit is 10 mW/kg.

### 3.4 ISOTROPY

The axial isotropy was evaluated by exposing the probe to a reference wave from a standard dipole with the dipole mounted under the flat phantom in the test configuration suggested for system validations and checks. The probe was rotated along its main axis from 0 to 360 degrees in 15-degree steps. The hemispherical isotropy is determined by inserting the probe in a thin plastic box filled with tissue-equivalent liquid, with the plastic box illuminated with the fields from a half wave dipole. The dipole is rotated about its axis (0°–180°) in 15° increments. At each step the probe is rotated about its axis (0°–360°).

### 3.1 BOUNDARY EFFECT

The boundary effect is defined as the deviation between the SAR measured data and the expected exponential decay in the liquid when the probe is oriented normal to the interface. To evaluate this effect, the liquid filled flat phantom is exposed to fields from either a reference dipole or waveguide. With the probe normal to the phantom surface, the peak spatial average SAR is measured and compared to the analytical value at the surface.

The boundary effect uncertainty can be estimated according to the following uncertainty approximation formula based on linear and exponential extrapolations between the surface and  $d_{be} + d_{step}$  along lines that are approximately normal to the surface:

$$SAR_{uncertainty} [\%] = \Delta SAR_{be} \frac{(d_{be} + d_{step})^2}{2d_{step}} \frac{(e^{-d_{be}/\delta})}{\delta/2} \quad \text{for } (d_{be} + d_{step}) < 10 \text{ mm}$$

where

- $SAR_{uncertainty}$  is the uncertainty in percent of the probe boundary effect
- $d_{be}$  is the distance between the surface and the closest *zoom-scan* measurement point, in millimetre
- $\Delta_{step}$  is the separation distance between the first and second measurement points that are closest to the phantom surface, in millimetre, assuming the boundary effect at the second location is negligible
- $\delta$  is the minimum penetration depth in millimetres of the head tissue-equivalent liquids defined in this standard, i.e.,  $\delta \approx 14$  mm at 3 GHz,
- $\Delta SAR_{be}$  in percent of SAR is the deviation between the measured SAR value, at the distance  $d_{be}$  from the boundary, and the analytical SAR value.

The measured worst case boundary effect SARuncertainty[%] for scanning distances larger than 4mm is 1.0% Limit ,2%).

#### 4 MEASUREMENT UNCERTAINTY

The guidelines outlined in the IEEE 1528, OET 65 Bulletin C, CENELEC EN50361 and CEI/IEC 62209 standards were followed to generate the measurement uncertainty associated with an E-field probe calibration using the waveguide technique. All uncertainties listed below represent an expanded uncertainty expressed at approximately the 95% confidence level using a coverage factor of k=2, traceable to the Internationally Accepted Guides to Measurement Uncertainty.

Uncertainty analysis of the probe calibration in waveguide					
ERROR SOURCES	Uncertainty value (%)	Probability Distribution	Divisor	ci	Standard Uncertainty (%)
Expanded uncertainty 95 % confidence level k = 2					14 %

#### 5 CALIBRATION MEASUREMENT RESULTS

Calibration Parameters	
Liquid Temperature	20 +/- 1 °C
Lab Temperature	20 +/- 1 °C
Lab Humidity	30-70 %

##### 5.1 SENSITIVITY IN AIR

Normx dipole 1 (µV/(V/m) <sup>2</sup> )	Normy dipole 2 (µV/(V/m) <sup>2</sup> )	Normz dipole 3 (µV/(V/m) <sup>2</sup> )
1.08	1.02	0.93

DCP dipole 1 (mV)	DCP dipole 2 (mV)	DCP dipole 3 (mV)
111	111	111

Calibration curves  $e_i=f(V)$  (i=1,2,3) allow to obtain E-field value using the formula:

$$E = \sqrt{E_1^2 + E_2^2 + E_3^2}$$

### Calibration curves

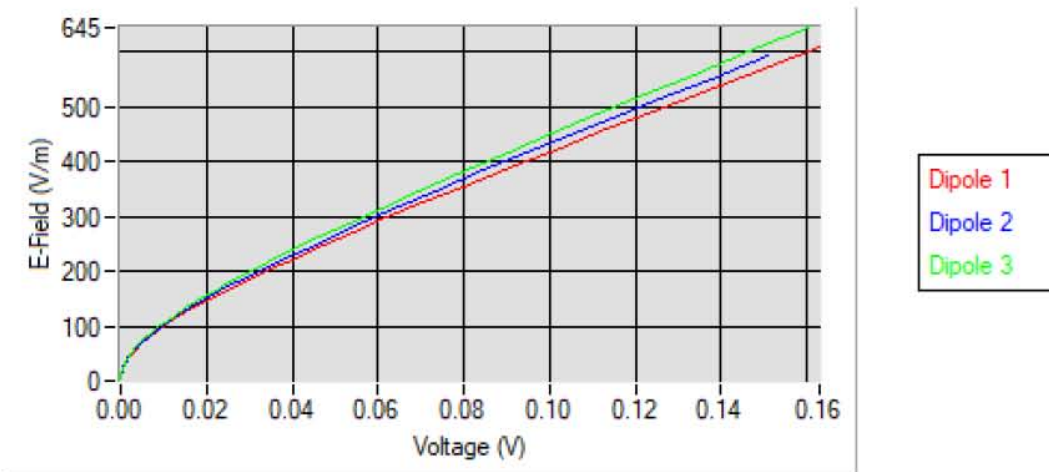

### 5.2 LINEARITY

#### Linearity

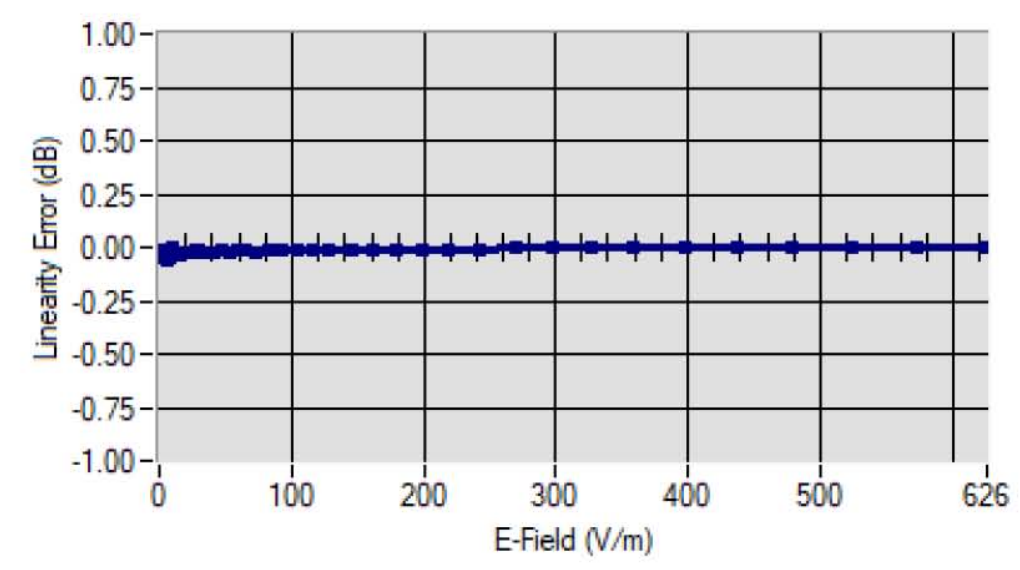

Linearity: +/-1.27% (+/-0.06dB)

5.3 SENSITIVITY IN LIQUID

<u>Liquid</u>	<u>Frequency (MHz +/- 100MHz)</u>	<u>ConvF</u>
HL750	750	1.58
HL850	835	1.57
HL900	900	1.68
HL1800	1800	1.60
HL1900	1900	1.78
HL2300	2300	1.71
HL2450	2450	1.75
HL2600	2600	1.63
HL3300	3300	1.56
HL3500	3500	1.59
HL3700	3700	1.57
HL3900	3900	1.71
HL4200	4200	1.87
HL4600	4600	1.86
HL4900	4900	1.68
HL5200	5200	1.47
HL5400	5400	1.65
HL5600	5600	1.74
HL5800	5800	1.64

LOWER DETECTION LIMIT: 9mW/kg



5.4 ISOTROPY

HL1800 MHz

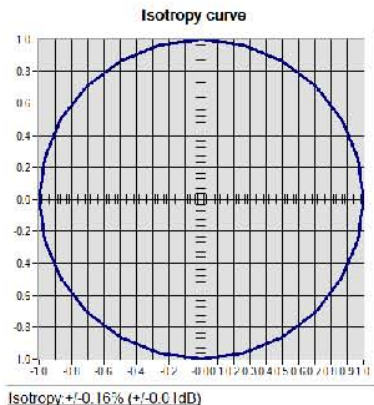

## 6 LIST OF EQUIPMENT

Equipment Summary Sheet				
Equipment Description	Manufacturer / Model	Identification No.	Current Calibration Date	Next Calibration Date
Flat Phantom	MVG	SN-20/09-SAM71	Validated. No cal required.	Validated. No cal required.
COMOSAR Test Bench	Version 3	NA	Validated. No cal required.	Validated. No cal required.
Network Analyzer	Rohde & Schwarz ZVM	100203	05/2019	05/2022
Network Analyzer – Calibration kit	Rohde & Schwarz ZV-Z235	101223	05/2019	05/2022
Multimeter	Keithley 2000	1160271	02/2020	02/2023
Signal Generator	Rohde & Schwarz SMB	106589	04/2019	04/2022
Amplifier	Aethercomm	SN 046	Characterized prior to test. No cal required.	Characterized prior to test. No cal required.
Power Meter	NI-USB 5680	170100013	05/2019	05/2022
Directional Coupler	Narda 4216-20	01386	Characterized prior to test. No cal required.	Characterized prior to test. No cal required.
Waveguide	Mega Industries	069Y7-158-13-712	Validated. No cal required.	Validated. No cal required.
Waveguide Transition	Mega Industries	069Y7-158-13-701	Validated. No cal required.	Validated. No cal required.
Waveguide Termination	Mega Industries	069Y7-158-13-701	Validated. No cal required.	Validated. No cal required.
Temperature / Humidity Sensor	Testo 184 H1	44220687	05/2020	05/2023



## SAR Reference Dipole Calibration Report

Ref : ACR.262.10.20.MVGB.A

**SHENZHEN STS TEST SERVICES CO., LTD.**  
**1/F., BUILDING B, ZHUOKE SCIENCE PARK, No.190,**  
**CHONGQING ROAD, FUYONG STREET,**  
**BAO' AN DISTRICT, SHENZHEN, GUANGDONG, CHINA**  
**MVG COMOSAR REFERENCE DIPOLE**  
**FREQUENCY: 2450 MHZ**  
**SERIAL NO.: SN 30/14 DIP2G450-335**

**Calibrated at MVG**  
**Z.I. de la pointe du diable**  
**Technopôle Brest Iroise - 295 avenue Alexis de Rochon**  
**29280 PLOUZANE - FRANCE**



**Calibration date: 07/14/2020**



Accreditations #2-6789 and #2-6814  
Scope available on [www.cofrac.fr](http://www.cofrac.fr)

### *Summary:*

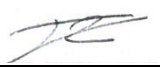
This document presents the method and results from an accredited SAR reference dipole calibration performed in MVG. using the CALIPROBE test bench. for use with a MVG COMOSAR system only. The test results covered by accreditation are traceable to the International System of Units(SI).

	<i>Name</i>	<i>Function</i>	<i>Date</i>	<i>Signature</i>
<i>Prepared by :</i>	Jérôme LUC	Technical Manager	7/28/2020	
<i>Checked by :</i>	Jérôme LUC	Technical Manager	7/28/2020	
<i>Approved by :</i>	Yann Toutain	Laboratory Director	7/28/2020	

	<i>Customer Name</i>
<i>Distribution :</i>	Shenzhen STS Test Services Co., Ltd.

<i>Issue</i>	<i>Name</i>	<i>Date</i>	<i>Modifications</i>
A	Jérôme LUC	7/28/2020	Initial release



**TABLE OF CONTENTS**

1 Introduction.....4

2 Device Under Test .....4

3 Product Description .....4

    3.1 General Information ..... 4

4 Measurement Method ..... 5

    4.1 Return Loss Requirements ..... 5

    4.2 Mechanical Requirements ..... 5

5 Measurement Uncertainty ..... 5

    5.1 Return Loss ..... 5

    5.2 Dimension Measurement ..... 5

    5.3 Validation Measurement ..... 5

6 Calibration Measurement Results ..... 6

    6.1 Return Loss and Impedance In Head Liquid ..... 6

    6.2 Return Loss and Impedance In Body Liquid ..... 6

    6.3 Mechanical Dimensions ..... 6

7 Validation measurement ..... 7

    7.1 Head Liquid Measurement ..... 7

    7.2 SAR Measurement Result With Head Liquid ..... 8

    7.3 Body Liquid Measurement ..... 9

    7.4 SAR Measurement Result With Body Liquid ..... 10

8 List of Equipment ..... 11

## 1 INTRODUCTION

This document contains a summary of the requirements set forth by the IEEE 1528, OET 65 Bulletin C and CEI/IEC 62209 standards for reference dipoles used for SAR measurement system validations and the measurements that were performed to verify that the product complies with the fore mentioned standards.

## 2 DEVICE UNDER TEST

Device Under Test	
Device Type	COMOSAR 2450 MHz REFERENCE DIPOLE
Manufacturer	MVG
Model	SID2450
Serial Number	SN 30/14 DIP2G450-335
Product Condition (new / used)	Used

A yearly calibration interval is recommended.

## 3 PRODUCT DESCRIPTION

### 3.1 GENERAL INFORMATION

MVG's COMOSAR Validation Dipoles are built in accordance to the IEEE 1528, OET 65 Bulletin C and CEI/IEC 62209 standards. The product is designed for use with the COMOSAR test bench only.



**Figure 1 – MVG COMOSAR Validation Dipole**

## 4 MEASUREMENT METHOD

The IEEE 1528, OET 65 Bulletin C and CEI/IEC 62209 standards provide requirements for reference dipoles used for system validation measurements. The following measurements were performed to verify that the product complies with the fore mentioned standards.

### 4.1 RETURN LOSS REQUIREMENTS

The dipole used for SAR system validation measurements and checks must have a return loss of -20 dB or better. The return loss measurement shall be performed against a liquid filled flat phantom, with the phantom constructed as outlined in the fore mentioned standards.

### 4.2 MECHANICAL REQUIREMENTS

The IEEE Std. 1528 and CEI/IEC 62209 standards specify the mechanical components and dimensions of the validation dipoles, with the dimensions frequency and phantom shell thickness dependent. The COMOSAR test bench employs a 2 mm phantom shell thickness therefore the dipoles sold for use with the COMOSAR test bench comply with the requirements set forth for a 2 mm phantom shell thickness.

## 5 MEASUREMENT UNCERTAINTY

All uncertainties listed below represent an expanded uncertainty expressed at approximately the 95% confidence level using a coverage factor of k=2, traceable to the Internationally Accepted Guides to Measurement Uncertainty.

### 5.1 RETURN LOSS

The following uncertainties apply to the return loss measurement:

Frequency band	Expanded Uncertainty on Return Loss
400-6000MHz	0.1 dB

### 5.2 DIMENSION MEASUREMENT

The following uncertainties apply to the dimension measurements:

Length (mm)	Expanded Uncertainty on Length
3 - 300	0.05 mm

### 5.3 VALIDATION MEASUREMENT

The guidelines outlined in the IEEE 1528, OET 65 Bulletin C, CENELEC EN50361 and CEI/IEC 62209 standards were followed to generate the measurement uncertainty for validation measurements.

Scan Volume	Expanded Uncertainty
1 g	20.3 %
10 g	20.1 %

## 6 CALIBRATION MEASUREMENT RESULTS

### 6.1 RETURN LOSS AND IMPEDANCE IN HEAD LIQUID

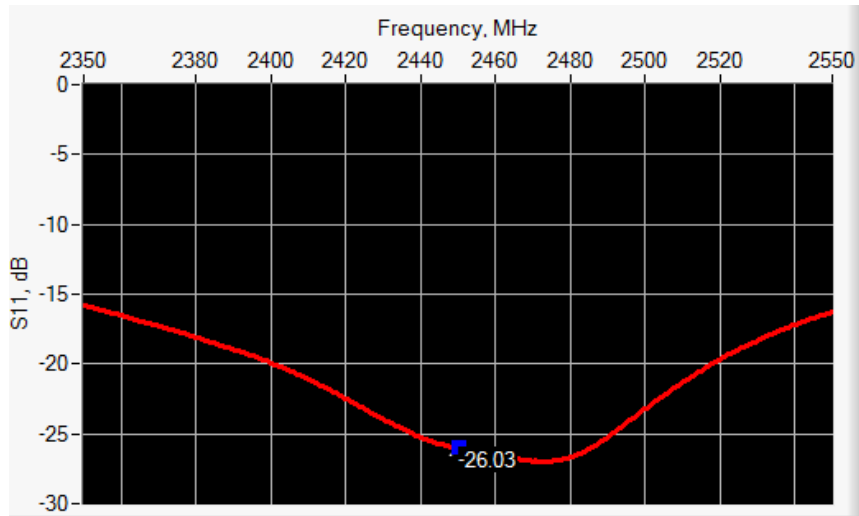

Frequency (MHz)	Return Loss (dB)	Requirement (dB)	Impedance
2450	-26.03	-20	46.3 $\Omega$ + 3.2 j $\Omega$

### 6.2 RETURN LOSS AND IMPEDANCE IN BODY LIQUID

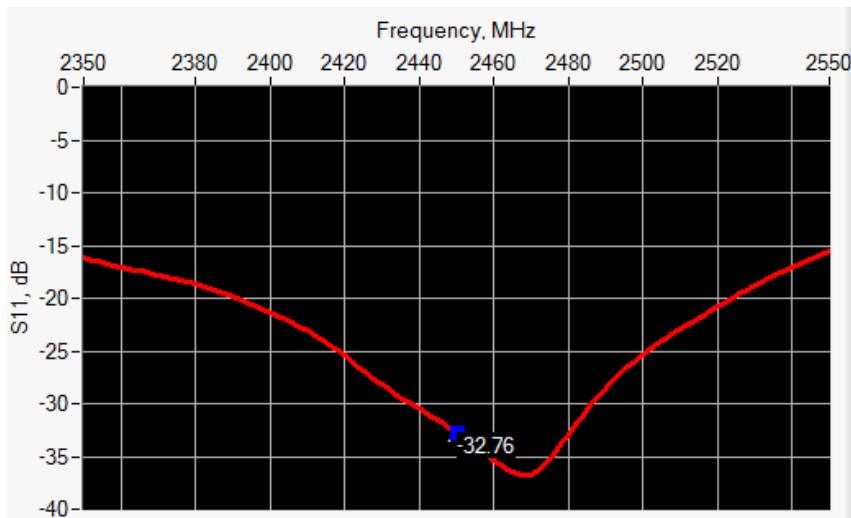

Frequency (MHz)	Return Loss (dB)	Requirement (dB)	Impedance
2450	-32.76	-20	48.7 $\Omega$ + 1.9 j $\Omega$

### 6.3 MECHANICAL DIMENSIONS

Frequency MHz	L mm		h mm		d mm	
	required	measured	required	measured	required	measured
750	176.0 $\pm$ 1 %.		100.0 $\pm$ 1 %.		6.35 $\pm$ 1 %.	
835	161.0 $\pm$ 1 %.		89.8 $\pm$ 1 %.		3.6 $\pm$ 1 %.	



900	149.0 ±1 %.		83.3 ±1 %.		3.6 ±1 %.	
1450	89.1 ±1 %.		51.7 ±1 %.		3.6 ±1 %.	
1500	80.5 ±1 %.		50.0 ±1 %.		3.6 ±1 %.	
1640	79.0 ±1 %.		45.7 ±1 %.		3.6 ±1 %.	
1750	75.2 ±1 %.		42.9 ±1 %.		3.6 ±1 %.	
1800	72.0 ±1 %.		41.7 ±1 %.		3.6 ±1 %.	
1900	68.0 ±1 %.		39.5 ±1 %.		3.6 ±1 %.	
1950	66.3 ±1 %.		38.5 ±1 %.		3.6 ±1 %.	
2000	64.5 ±1 %.		37.5 ±1 %.		3.6 ±1 %.	
2100	61.0 ±1 %.		35.7 ±1 %.		3.6 ±1 %.	
2300	55.5 ±1 %.		32.6 ±1 %.		3.6 ±1 %.	
2450	51.5 ±1 %.	PASS	30.4 ±1 %.	PASS	3.6 ±1 %.	PASS
2600	48.5 ±1 %.		28.8 ±1 %.		3.6 ±1 %.	
3000	41.5 ±1 %.		25.0 ±1 %.		3.6 ±1 %.	
3500	37.0 ±1 %.		26.4 ±1 %.		3.6 ±1 %.	
3700	34.7 ±1 %.		26.4 ±1 %.		3.6 ±1 %.	

## 7 VALIDATION MEASUREMENT

The IEEE Std. 1528, OET 65 Bulletin C and CEI/IEC 62209 standards state that the system validation measurements must be performed using a reference dipole meeting the fore mentioned return loss and mechanical dimension requirements. The validation measurement must be performed against a liquid filled flat phantom, with the phantom constructed as outlined in the fore mentioned standards. Per the standards, the dipole shall be positioned below the bottom of the phantom, with the dipole length centered and parallel to the longest dimension of the flat phantom, with the top surface of the dipole at the described distance from the bottom surface of the phantom.

### 7.1 HEAD LIQUID MEASUREMENT

Frequency MHz	Relative permittivity ( $\epsilon_r'$ )		Conductivity ( $\sigma$ ) S/m	
	required	measured	required	measured
750	41.9 ±5 %		0.89 ±5 %	
835	41.5 ±5 %		0.90 ±5 %	
900	41.5 ±5 %		0.97 ±5 %	
1450	40.5 ±5 %		1.20 ±5 %	
1500	40.4 ±5 %		1.23 ±5 %	
1640	40.2 ±5 %		1.31 ±5 %	
1750	40.1 ±5 %		1.37 ±5 %	
1800	40.0 ±5 %		1.40 ±5 %	
1900	40.0 ±5 %		1.40 ±5 %	
1950	40.0 ±5 %		1.40 ±5 %	
2000	40.0 ±5 %		1.40 ±5 %	

2100	39.8 ±5 %		1.49 ±5 %	
2300	39.5 ±5 %		1.67 ±5 %	
2450	39.2 ±5 %	PASS	1.80 ±5 %	PASS
2600	39.0 ±5 %		1.96 ±5 %	
3000	38.5 ±5 %		2.40 ±5 %	
3500	37.9 ±5 %		2.91 ±5 %	

7.2 SAR MEASUREMENT RESULT WITH HEAD LIQUID

The IEEE Std. 1528 and CEI/IEC 62209 standards state that the system validation measurements should produce the SAR values shown below (for phantom thickness of 2 mm), within the uncertainty for the system validation. All SAR values are normalized to 1 W forward power. In bracket, the measured SAR is given with the used input power.

Software	OPENSAR V4
Phantom	SN 20/09 SAM71
Probe	SN 18/11 EPG122
Liquid	Head Liquid Values: eps' : 39.0 sigma : 1.77
Distance between dipole center and liquid	10.0 mm
Area scan resolution	dx=8mm/dy=8mm
Zoon Scan Resolution	dx=8mm/dy=8mm/dz=5mm
Frequency	2450 MHz
Input power	20 dBm
Liquid Temperature	21 °C
Lab Temperature	21 °C
Lab Humidity	45 %

Frequency MHz	1 g SAR (W/kg/W)		10 g SAR (W/kg/W)	
	required	measured	required	measured
750	8.49		5.55	
835	9.56		6.22	
900	10.9		6.99	
1450	29		16	
1500	30.5		16.8	
1640	34.2		18.4	
1750	36.4		19.3	
1800	38.4		20.1	
1900	39.7		20.5	
1950	40.5		20.9	
2000	41.1		21.1	
2100	43.6		21.9	
2300	48.7		23.3	

2450	52.4	54.70 (5.47)	24	24.11 (2.41)
2600	55.3		24.6	
3000	63.8		25.7	
3500	67.1		25	

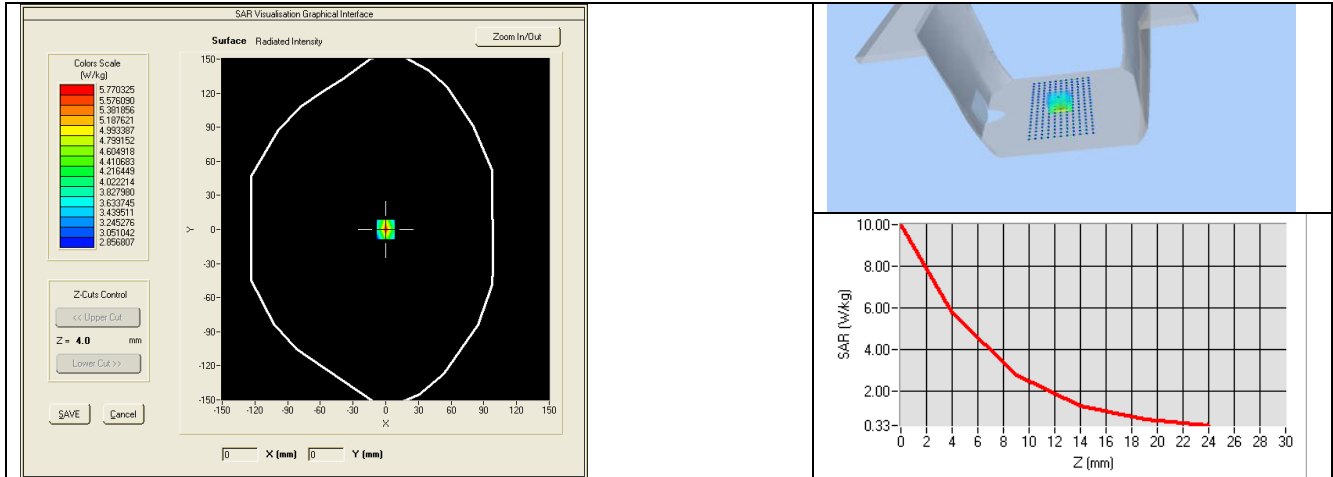

### 7.3 BODY LIQUID MEASUREMENT

Frequency MHz	Relative permittivity ( $\epsilon_r'$ )		Conductivity ( $\sigma$ ) S/m	
	required	measured	required	measured
750	55.5 ±5 %		0.96 ±5 %	
835	55.2 ±5 %		0.97 ±5 %	
900	55.0 ±5 %		1.05 ±5 %	
915	55.0 ±5 %		1.06 ±5 %	
1450	54.0 ±5 %		1.30 ±5 %	
1610	53.8 ±5 %		1.40 ±5 %	
1800	53.3 ±5 %		1.52 ±5 %	
1900	53.3 ±5 %		1.52 ±5 %	
2000	53.3 ±5 %		1.52 ±5 %	
2100	53.2 ±5 %		1.62 ±5 %	
2450	52.7 ±5 %	PASS	1.95 ±5 %	PASS
2600	52.5 ±5 %		2.16 ±5 %	
3000	52.0 ±5 %		2.73 ±5 %	
3500	51.3 ±5 %		3.31 ±5 %	
5200	49.0 ±10 %		5.30 ±10 %	
5300	48.9 ±10 %		5.42 ±10 %	
5400	48.7 ±10 %		5.53 ±10 %	

5500	48.6 ±10 %		5.65 ±10 %	
5600	48.5 ±10 %		5.77 ±10 %	
5800	48.2 ±10 %		6.00 ±10 %	

7.4 SAR MEASUREMENT RESULT WITH BODY LIQUID

Software	OPENSAR V4
Phantom	SN 20/09 SAM71
Probe	SN 18/11 EPG122
Liquid	Body Liquid Values: eps' : 53.0 sigma : 1.93
Distance between dipole center and liquid	10.0 mm
Area scan resolution	dx=8mm/dy=8mm
Zoon Scan Resolution	dx=8mm/dy=8m/dz=5mm
Frequency	2450 MHz
Input power	20 dBm
Liquid Temperature	21 °C
Lab Temperature	21 °C
Lab Humidity	45 %

Frequency MHz	1 g SAR (W/kg/W)	10 g SAR (W/kg/W)
	measured	measured
2450	55.65 (5.57)	24.56 (2.46)

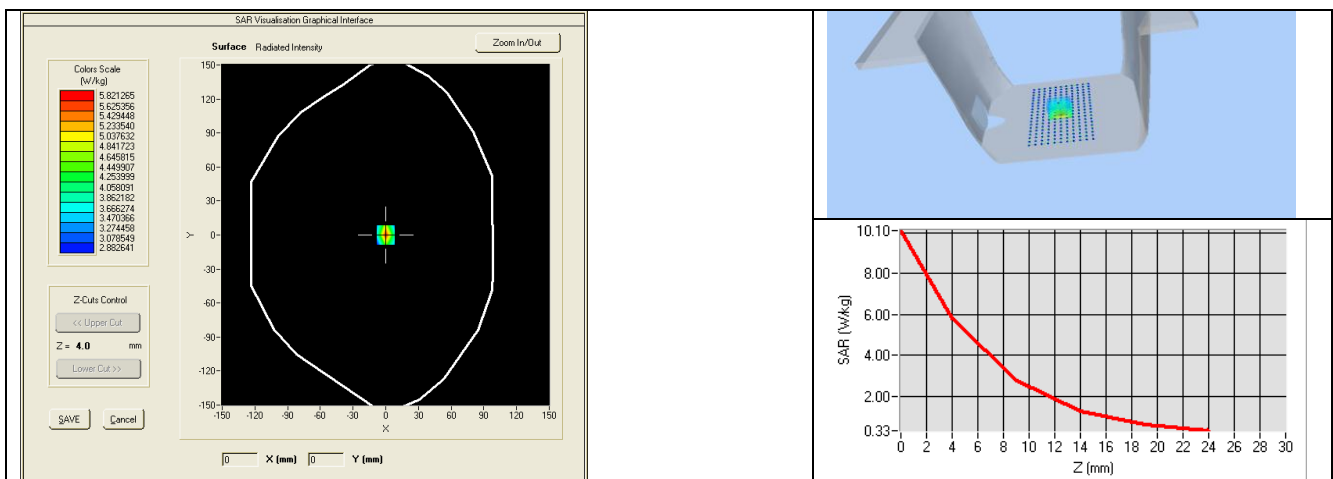



**8 LIST OF EQUIPMENT**

Equipment Summary Sheet				
Equipment Description	Manufacturer / Model	Identification No.	Current Calibration Date	Next Calibration Date
SAM Phantom	MVG	SN-20/09-SAM71	Validated. No cal required.	Validated. No cal required.
COMOSAR Test Bench	Version 3	NA	Validated. No cal required.	Validated. No cal required.
Network Analyzer	Rhode & Schwarz ZVA	SN100132	02/2019	02/2022
Calipers	Carrera	CALIPER-01	01/2020	01/2023
Reference Probe	MVG	EPG122 SN 18/11	10/2019	10/2020
Multimeter	Keithley 2000	1188656	01/2020	01/2023
Signal Generator	Agilent E4438C	MY49070581	01/2020	01/2023
Amplifier	Aethercomm	SN 046	Characterized prior to test. No cal required.	Characterized prior to test. No cal required.
Power Meter	HP E4418A	US38261498	01/2020	01/2023
Power Sensor	HP ECP-E26A	US37181460	01/2020	01/2023
Directional Coupler	Narda 4216-20	01386	Characterized prior to test. No cal required.	Characterized prior to test. No cal required.
Temperature and Humidity Sensor	Control Company	15098832	11/2017	11/2020



## SAR Reference Waveguide Calibration Report

Ref : ACR.262.12.20.MVGB.A

**SHENZHEN STS TEST SERVICES CO., LTD.**  
**1/F., BUILDING B, ZHUOKE SCIENCE PARK, No.190,**  
**CHONGQINGROAD, FUYONG STREET,**  
**BAO' AN DISTRICT, SHENZHEN, GUANGDONG CHINA**  
**MVG COMOSAR REFERENCE WAVEGUIDE**  
**FREQUENCY: 5000-6000 MHZ**  
**SERIAL NO.: SN 13/14 WGA32**

**Calibrated at MVG**  
**Z.I. de la pointe du diable**  
**Technopôle Brest Iroise - 295 avenue Alexis de Rochon**  
**29280 PLOUZANE - FRANCE**



**Calibration date: 07/14/2020**



Accreditations #2-6789 and #2-6814  
Scope available on [www.cofrac.fr](http://www.cofrac.fr)

### *Summary:*

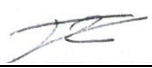
This document presents the method and results from an accredited SAR reference dipole calibration performed in MVG. using the CALIPROBE test bench. for use with a MVG COMOSAR system only. The test results covered by accreditation are traceable to the International System of Units(SI).

	<i>Name</i>	<i>Function</i>	<i>Date</i>	<i>Signature</i>
<i>Prepared by :</i>	Jérôme LUC	Technical Manager	7/28/2020	
<i>Checked by :</i>	Jérôme LUC	Technical Manager	7/28/2020	
<i>Approved by :</i>	Yann Toutain	Laboratory Director	7/28/2020	

	<i>Customer Name</i>
<i>Distribution :</i>	Shenzhen STS Test Services Co., Ltd.

<i>Issue</i>	<i>Name</i>	<i>Date</i>	<i>Modifications</i>
A	Jérôme LUC	7/28/2020	Initial release

**TABLE OF CONTENTS**

1 Introduction.....4

2 Device Under Test .....4

3 Product Description .....4

    3.1 General Information ..... 4

4 Measurement Method .....4

    4.1 Return Loss Requirements .....4

    4.2 Mechanical Requirements .....4

5 Measurement Uncertainty .....5

    5.1 Return Loss .....5

    5.2 Dimension Measurement .....5

    5.3 Validation Measurement .....5

6 Calibration Measurement Results .....5

    6.1 Return Loss .....5

    6.2 Mechanical Dimensions .....6

7 Validation measurement .....6

    7.1 Head Liquid Measurement .....7

    7.2 Measurement Result .....7

    7.3 Body Measurement Result .....10

8 List of Equipment .....13



## 1 INTRODUCTION

This document contains a summary of the requirements set forth by the IEEE 1528 and CEI/IEC 62209 standards for reference waveguides used for SAR measurement system validations and the measurements that were performed to verify that the product complies with the fore mentioned standards.

## 2 DEVICE UNDER TEST

<b>Device Under Test</b>	
Device Type	COMOSAR 5000-6000 MHz REFERENCE WAVEGUIDE
Manufacturer	MVG
Model	SWG5500
Serial Number	SN 13/14 WGA32
Product Condition (new / used)	Used

A yearly calibration interval is recommended.

## 3 PRODUCT DESCRIPTION

### 3.1 GENERAL INFORMATION

MVG's COMOSAR Validation Waveguides are built in accordance to the IEEE 1528 and CEI/IEC 62209 standards.

## 4 MEASUREMENT METHOD

The IEEE 1528 and CEI/IEC 62209 standards provide requirements for reference waveguides used for system validation measurements. The following measurements were performed to verify that the product complies with the fore mentioned standards.

### 4.1 RETURN LOSS REQUIREMENTS

The waveguide used for SAR system validation measurements and checks must have a return loss of -8 dB or better. The return loss measurement shall be performed with matching layer placed in the open end of the waveguide, with the waveguide and matching layer in direct contact with the phantom shell as outlined in the fore mentioned standards.

### 4.2 MECHANICAL REQUIREMENTS

The IEEE 1528 and CEI/IEC 62209 standards specify the mechanical dimensions of the validation waveguide, the specified dimensions are as shown in Section 6.2. Figure 1 shows how the dimensions relate to the physical construction of the waveguide.

## 5 MEASUREMENT UNCERTAINTY

All uncertainties listed below represent an expanded uncertainty expressed at approximately the 95% confidence level using a coverage factor of k=2, traceable to the Internationally Accepted Guides to Measurement Uncertainty.

### 5.1 RETURN LOSS

The following uncertainties apply to the return loss measurement:

Frequency band	Expanded Uncertainty on Return Loss
400-6000MHz	0.1 dB

### 5.2 DIMENSION MEASUREMENT

The following uncertainties apply to the dimension measurements:

Length (mm)	Expanded Uncertainty on Length
3 - 300	0.05 mm

### 5.3 VALIDATION MEASUREMENT

The guidelines outlined in the IEEE 1528 and CEI/IEC 62209 standards were followed to generate the measurement uncertainty for validation measurements.

Scan Volume	Expanded Uncertainty
1 g	20.3 %
10 g	20.1 %

## 6 CALIBRATION MEASUREMENT RESULTS

### 6.1 RETURN LOSS IN HEAD LIQUID

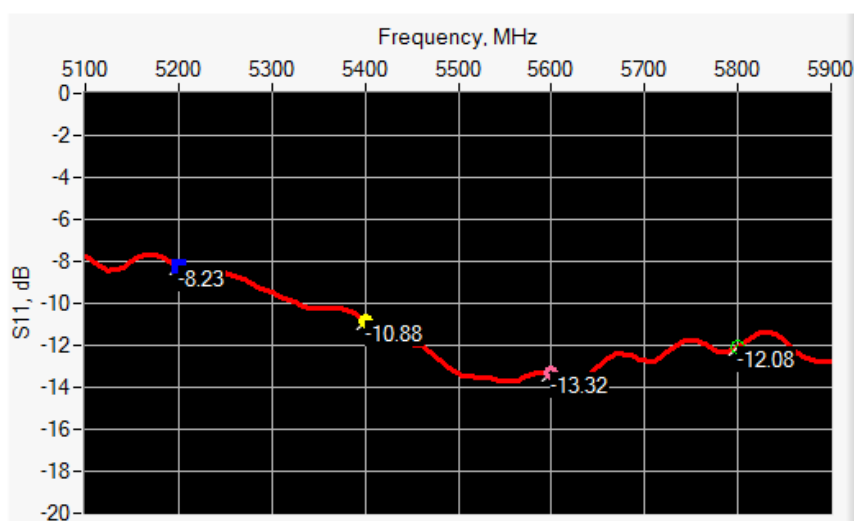

Frequency (MHz)	Return Loss (dB)	Requirement (dB)
5000-6000	< -8.23	-8

## 6.2 RETURN LOSS IN BODY LIQUID

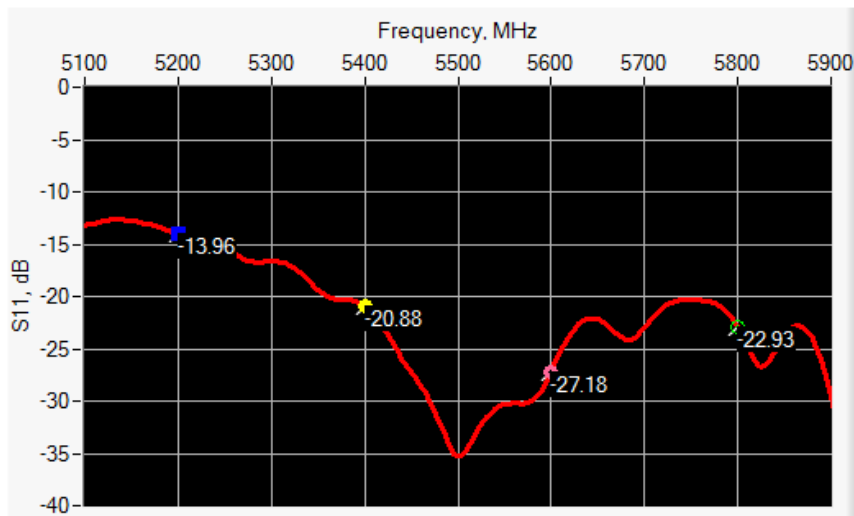

Frequency (MHz)	Return Loss (dB)	Requirement (dB)
5000-6000	< -13.96	-8

## 6.3 MECHANICAL DIMENSIONS

Frequency (MHz)	L (mm)		W (mm)		L <sub>r</sub> (mm)		W <sub>f</sub> (mm)		T (mm)	
	Required	Measured	Required	Measured	Required	Measured	Required	Measured	Required	Measured
5200	40.39 ± 0.13	PASS	20.19 ± 0.13	PASS	81.03 ± 0.13	PASS	61.98 ± 0.13	PASS	5.3*	PASS
5800	40.39 ± 0.13	PASS	20.19 ± 0.13	PASS	81.03 ± 0.13	PASS	61.98 ± 0.13	PASS	4.3*	PASS

\* The tolerance for the matching layer is included in the return loss measurement.

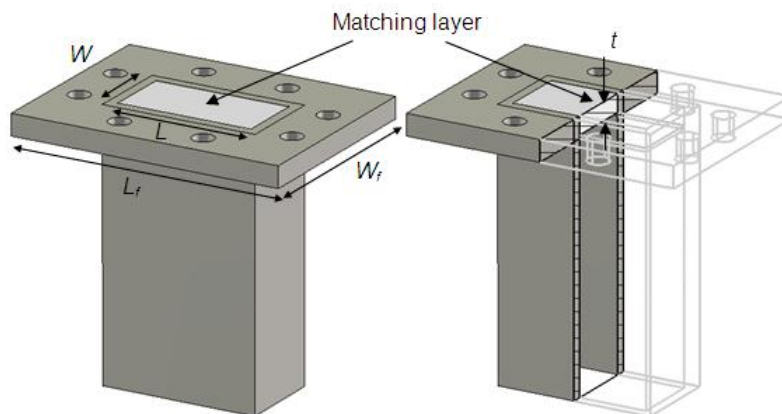

Figure 1: Validation Waveguide Dimensions

## 7 VALIDATION MEASUREMENT

The IEEE Std. 1528 and CEI/IEC 62209 standards state that the system validation measurements must be performed using a reference waveguide meeting the fore mentioned return loss and mechanical dimension requirements. The validation measurement must be performed with the matching layer placed in the open end of the waveguide, with the waveguide and matching layer in direct contact with the phantom shell.

7.1 HEAD LIQUID MEASUREMENT

Frequency MHz	Relative permittivity ( $\epsilon_r'$ )		Conductivity ( $\sigma$ ) S/m	
	required	measured	required	measured
5000	36.2 $\pm$ 10 %		4.45 $\pm$ 10 %	
5100	36.1 $\pm$ 10 %		4.56 $\pm$ 10 %	
5200	36.0 $\pm$ 10 %	PASS	4.66 $\pm$ 10 %	PASS
5300	35.9 $\pm$ 10 %		4.76 $\pm$ 10 %	
5400	35.8 $\pm$ 10 %	PASS	4.86 $\pm$ 10 %	PASS
5500	35.6 $\pm$ 10 %		4.97 $\pm$ 10 %	
5600	35.5 $\pm$ 10 %	PASS	5.07 $\pm$ 10 %	PASS
5700	35.4 $\pm$ 10 %		5.17 $\pm$ 10 %	
5800	35.3 $\pm$ 10 %	PASS	5.27 $\pm$ 10 %	PASS
5900	35.2 $\pm$ 10 %		5.38 $\pm$ 10 %	
6000	35.1 $\pm$ 10 %		5.48 $\pm$ 10 %	

7.2 SAR MEASUREMENT RESULT WITH HEAD LIQUID

At those frequencies, the target SAR value can not be generic. Hereunder is the target SAR value defined by MVG, within the uncertainty for the system validation. All SAR values are normalized to 1 W net power. In bracket, the measured SAR is given with the used input power.

Software	OPENSAR V4
Phantom	SN 20/09 SAM71
Probe	SN 18/11 EPG122
Liquid	Head Liquid Values 5200 MHz: $\epsilon_r'$ :36.62 sigma : 4.93 Head Liquid Values 5400 MHz: $\epsilon_r'$ :35.95 sigma : 5.18 Head Liquid Values 5600 MHz: $\epsilon_r'$ :36.08 sigma : 5.60 Head Liquid Values 5800 MHz: $\epsilon_r'$ :34.73 sigma : 5.74
Distance between dipole waveguide and liquid	0 mm
Area scan resolution	dx=8mm/dy=8mm
Zoon Scan Resolution	dx=4mm/dy=4m/dz=2mm
Frequency	5200 MHz 5400 MHz 5600 MHz 5800 MHz
Input power	20 dBm
Liquid Temperature	21 °C
Lab Temperature	21 °C
Lab Humidity	45 %

Frequency (MHz)	1 g SAR (W/kg)		10 g SAR (W/kg)	
	required	measured	required	measured
5200	159.00	163.88 (16.39)	56.90	57.29 (5.73)
5400	166.40	172.23 (17.22)	58.43	59.16 (5.92)
5600	173.80	181.28 (18.13)	59.97	61.57 (6.16)
5800	181.20	188.95 (18.90)	61.50	63.45 (6.35)

### SAR MEASUREMENT PLOTS @ 5200 MHz

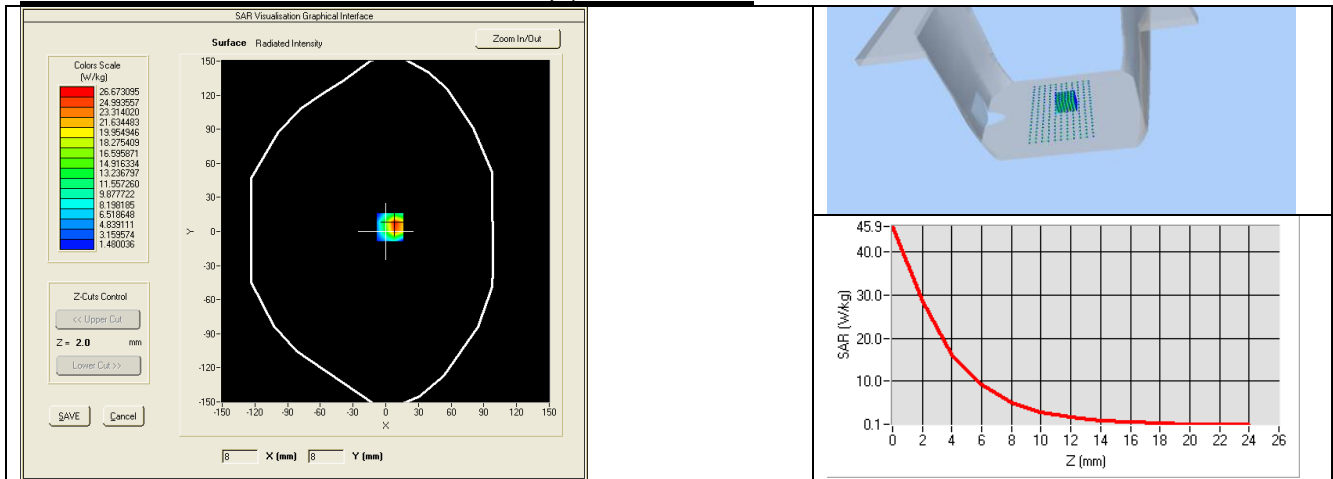

### SAR MEASUREMENT PLOTS @ 5400 MHz

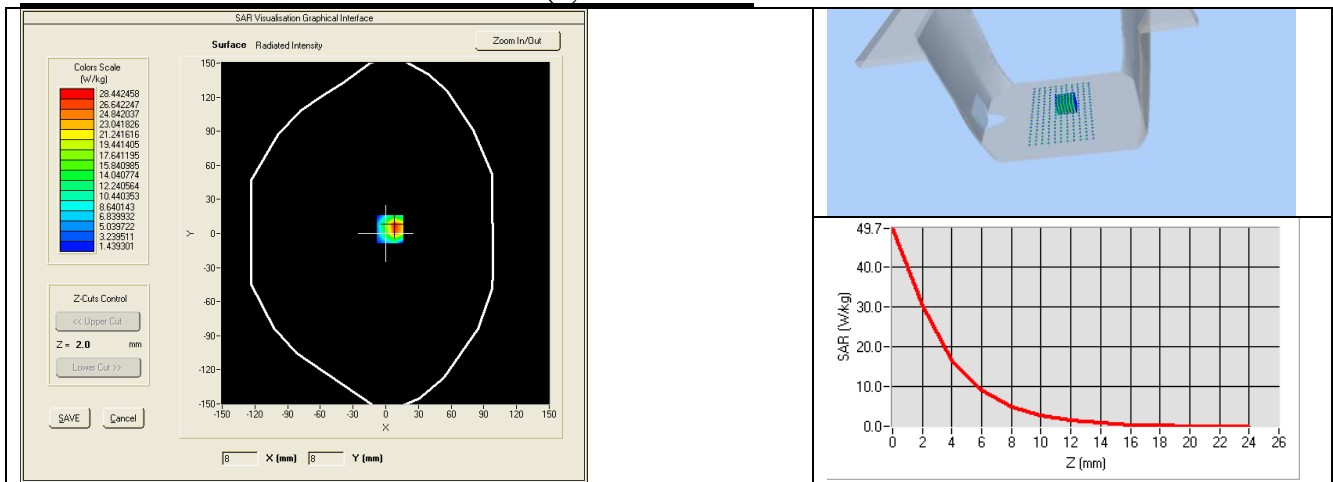

### SAR MEASUREMENT PLOTS @ 5600 MHz

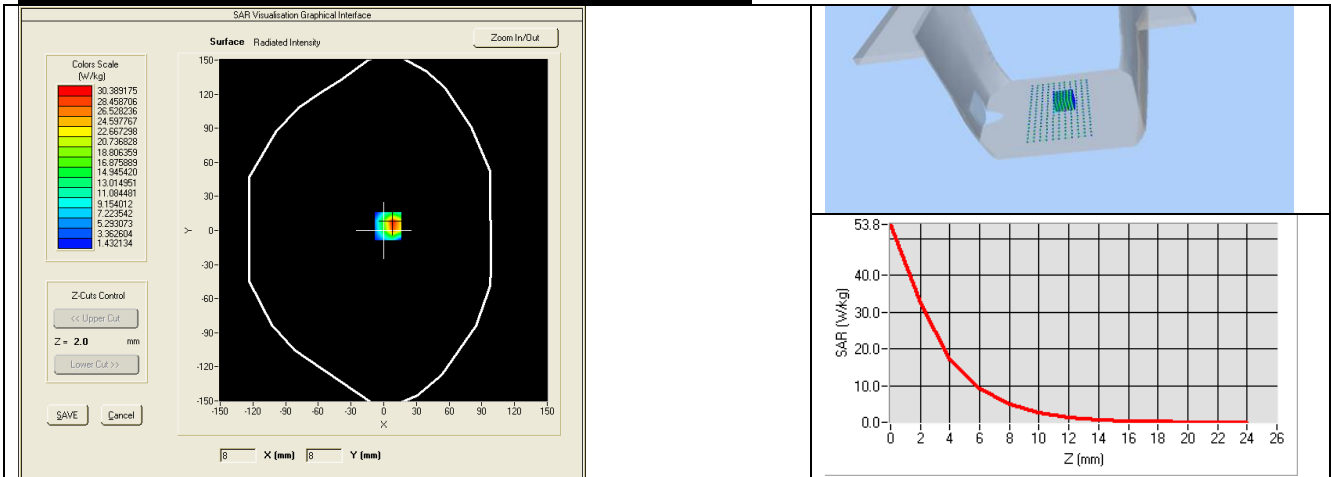

### SAR MEASUREMENT PLOTS @ 5800 MHz

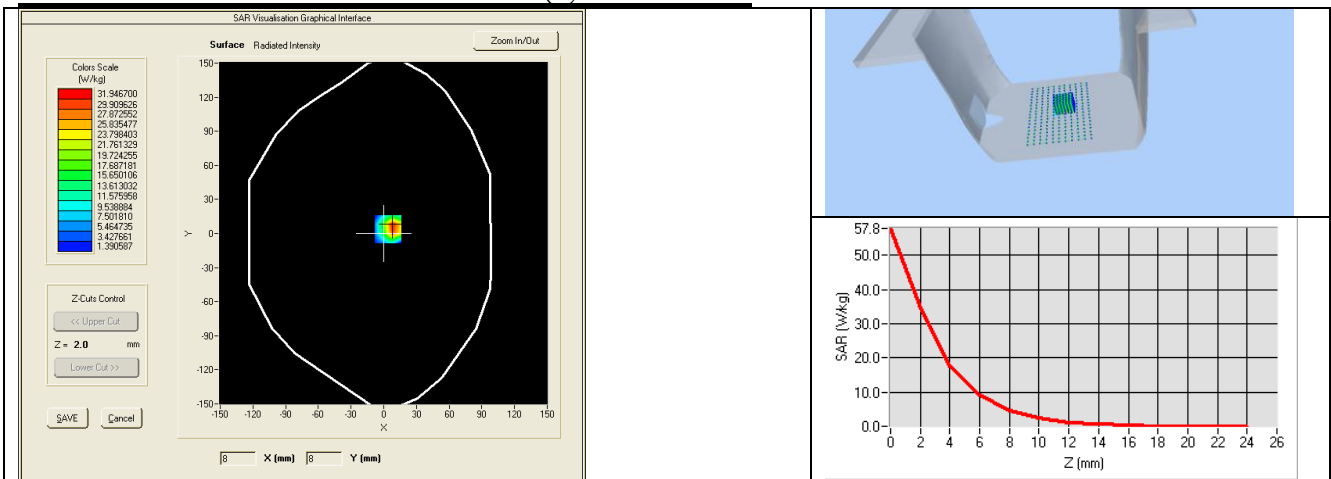

7.3 BODY LIQUID MEASUREMENT

Frequency MHz	Relative permittivity ( $\epsilon_r'$ )		Conductivity ( $\sigma$ ) S/m	
	required	measured	required	measured
5200	49.0 ±10 %	PASS	5.30 ±10 %	PASS
5300	48.9 ±10 %		5.42 ±10 %	
5400	48.7 ±10 %	PASS	5.53 ±10 %	PASS
5500	48.6 ±10 %		5.65 ±10 %	
5600	48.5 ±10 %	PASS	5.77 ±10 %	PASS
5800	48.2 ±10 %	PASS	6.00 ±10 %	PASS

7.4 SAR MEASUREMENT RESULT WITH BODY LIQUID

Software	OPENSAR V4
Phantom	SN 20/09 SAM71
Probe	SN 18/11 EPG122
Liquid	Body Liquid Values 5200 MHz: eps' :50.69 sigma : 4.98 Body Liquid Values 5400 MHz: eps' :48.45 sigma : 5.82 Body Liquid Values 5600 MHz: eps' :50.57 sigma : 6.37 Body Liquid Values 5800 MHz: eps' :48.19 sigma : 6.45
Distance between dipole waveguide and liquid	0 mm
Area scan resolution	dx=8mm/dy=8mm
Zoon Scan Resolution	dx=4mm/dy=4m/dz=2mm
Frequency	5200 MHz 5400 MHz 5600 MHz 5800 MHz
Input power	20 dBm
Liquid Temperature	21 °C
Lab Temperature	21 °C
Lab Humidity	45 %

Frequency (MHz)	1 g SAR (W/kg)	10 g SAR (W/kg)
	measured	measured
5200	158.49 (15.85)	55.40 (5.54)
5400	167.20 (16.72)	57.39 (5.74)
5600	175.65 (17.57)	59.48 (5.95)
5800	183.06 (18.31)	61.62 (6.16)



### BODY SAR MEASUREMENT PLOTS @ 5200 MHz

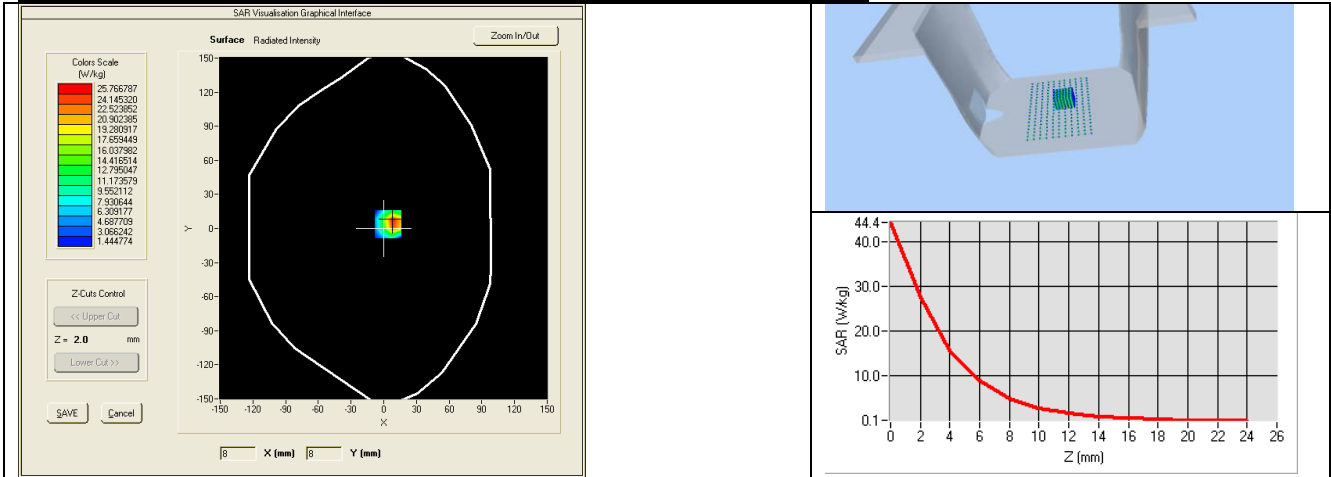

### BODY SAR MEASUREMENT PLOTS @ 5400 MHz

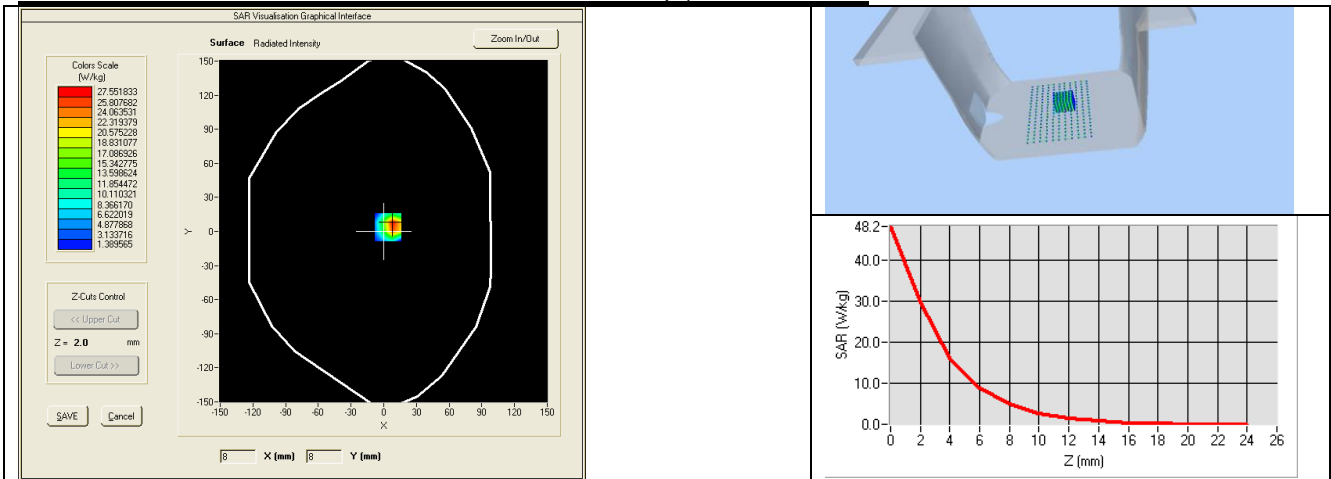

### BODY SAR MEASUREMENT PLOTS @ 5600 MHz

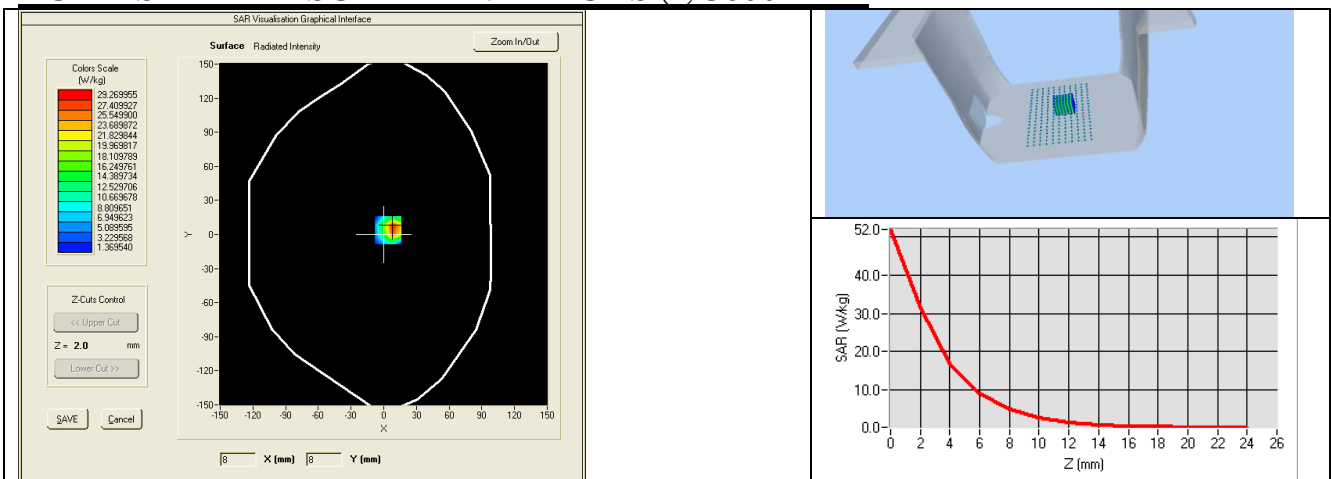

## BODY SAR MEASUREMENT PLOTS @ 5800 MHz

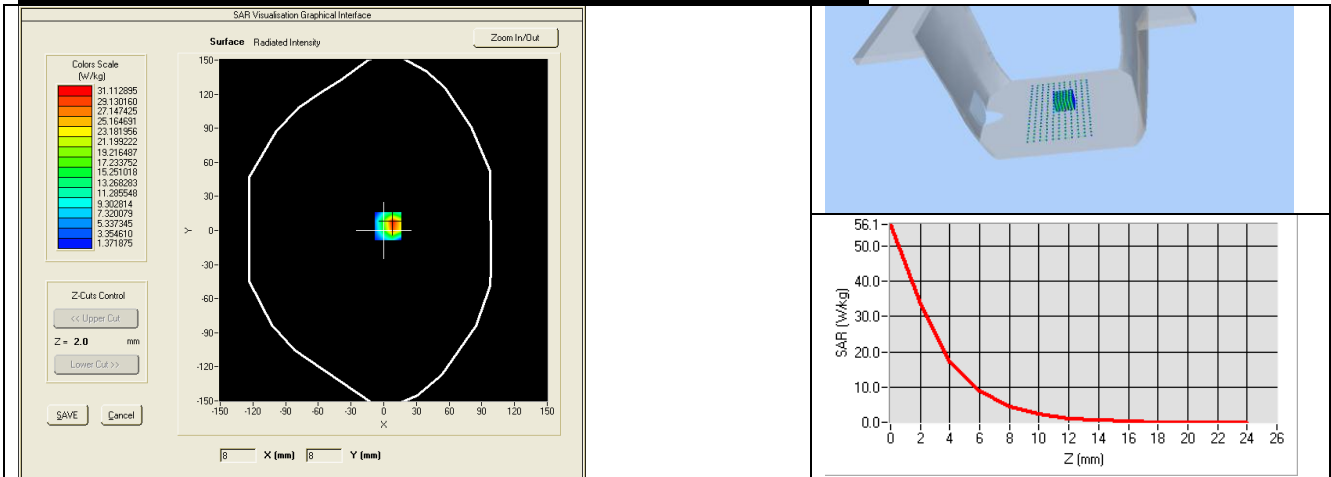

## 8 LIST OF EQUIPMENT

Equipment Summary Sheet				
Equipment Description	Manufacturer / Model	Identification No.	Current Calibration Date	Next Calibration Date
SAM Phantom	MVG	SN-20/09-SAM71	Validated. No cal required.	Validated. No cal required.
COMOSAR Test Bench	Version 3	NA	Validated. No cal required.	Validated. No cal required.
Network Analyzer	Rhode & Schwarz ZVA	SN100132	02/2019	02/2022
Calipers	Carrera	CALIPER-01	01/2020	01/2023
Reference Probe	MVG	EPG122 SN 18/11	10/2019	10/2020
Multimeter	Keithley 2000	1188656	01/2020	01/2023
Signal Generator	Agilent E4438C	MY49070581	01/2020	01/2023
Amplifier	Aethercomm	SN 046	Characterized prior to test. No cal required.	Characterized prior to test. No cal required.
Power Meter	HP E4418A	US38261498	01/2020	01/2023
Power Sensor	HP ECP-E26A	US37181460	01/2020	01/2023
Directional Coupler	Narda 4216-20	01386	Characterized prior to test. No cal required.	Characterized prior to test. No cal required.
Temperature and Humidity Sensor	Control Company	15098832	11/2017	11/2020