

# TEST REPORT

**Product Name** : Automotive Diagnostic Tool  
**Model Number** : TKT04,TKT05  
**FCC ID** : 2AUARTKTOOL10

Prepared for : THINKCAR TECH CO., LTD.  
Address : 2606, building 4, phase II, TiananYungu, Gangtou  
community, Bantian, Longgang District, Shenzhen

Prepared by : EMTEK (SHENZHEN) CO., LTD.  
Address : Building 69, Majialong Industry Zone, Nanshan District,  
Shenzhen, Guangdong, China

Tel: (0755) 26954280  
Fax: (0755) 26954282

Report Number : ENS2302080082W00303R  
Date(s) of Tests : February 09, 2023 to March 3, 2023  
Date of issue : March 7, 2023

## Table of Contents

<b>1 TEST RESULT CERTIFICATION .....</b>	<b>3</b>
<b>2 EUT TECHNICAL DESCRIPTION .....</b>	<b>4</b>
<b>3 SUMMARY OF TEST RESULT .....</b>	<b>5</b>
<b>4 TEST METHODOLOGY .....</b>	<b>6</b>
4.1 General Description Of Applied Standards .....	6
4.2 Measurement Equipment Used .....	6
4.3 Description Of Test Modes .....	7
4.4 Test Software .....	7
<b>5 FACILITIES AND ACCREDITATIONS .....</b>	<b>8</b>
5.1 Facilities .....	8
5.2 Laboratory Accreditations And Listings .....	8
<b>6 TEST SYSTEM UNCERTAINTY .....</b>	<b>9</b>
<b>7 SETUP OF EQUIPMENT UNDER TEST .....</b>	<b>10</b>
7.1 Radio Frequency Test Setup 1 .....	10
7.2 Radio Frequency Test Setup 2 .....	10
7.3 Conducted Emission Test Setup .....	12
7.4 Block Diagram Configuration Of Test System .....	13
7.5 Support Equipment .....	13
<b>8 FREQUENCY HOPPING SYSTEM REQUIREMENTS .....</b>	<b>14</b>
8.1 Standard Applicable .....	14
8.2 Eut Pseudorandom Frequency Hopping Sequence .....	14
8.3 Equal Hopping Frequency Use .....	15
8.4 Frequency Hopping System .....	15
<b>9 TEST REQUIREMENTS .....</b>	<b>16</b>
9.1 20db Bandwidth .....	16
9.2 Carrier Frequency Separation .....	20
9.3 Number Of Hopping Frequencies .....	24
9.4 Average Time Of Occupancy (Dwell Time) .....	26
9.5 Maximum Peak Conducted Output Power .....	28
9.6 Conducted Spurious Emission .....	32
9.7 Radiated Spurious Emission .....	43
9.8 Conducted Emission Test .....	56
9.9 Antenna Application .....	59

# 1 TEST RESULT CERTIFICATION

Applicant : THINKCAR TECH CO., LTD.  
 Address : 2606, building 4, phase II, TiananYungu, Gangtou community, Bantian, Longgang District, Shenzhen  
 Manufacturer : THINKCAR TECH CO., LTD.  
 Address : 2606, building 4, phase II, TiananYungu, Gangtou community, Bantian, Longgang District, Shenzhen  
 EUT : Automotive Diagnostic Tool  
 Model Name : TKT04,TKT05  
 Trademark : THINKCAR, XHINKCAR, MUCAR

Measurement Procedure Used:

APPLICABLE STANDARDS	
STANDARD	TEST RESULT
FCC 47 CFR Part 2, Subpart J FCC 47 CFR Part 15, Subpart C	PASS

The above equipment was tested by EMTEK (SHENZHEN) CO., LTD. The test data, data evaluation, test procedures, and equipment configurations shown in this report were made in accordance with the procedures given in ANSI C63.10 (2013) and the energy emitted by the sample EUT tested as described in this report is in compliance with the requirements of FCC Rules Part 2 and Part 15.247

The test results of this report relate only to the tested sample identified in this report

Date of Test : February 09, 2023 to March 3, 2023

Prepared by : Una Yu  
 Una Yu /Editor

Reviewer : Joe Xia  
 Joe Xia /Supervisor

Approve & Authorized Signer : Lisa Wang  
 Lisa Wang/Manager



## 2 EUT TECHNICAL DESCRIPTION

Characteristics	Description
<b>Product:</b>	Automotive Diagnostic Tool
<b>Model Number:</b>	TKT04,TKT05
<b>Sample number:</b>	2#
<b>Data Rate:</b>	1Mbps for BT GFSK modulation 2Mbps for BT pi/4-DQPSK modulation 3Mbps for BT 8DPSK modulation
<b>Modulation:</b>	GFSK modulation for BT (1Mbps) pi/4-DQPSK modulation for BT (2Mbps) 8DPSK modulation for BT (3Mbps)
<b>Operating Frequency Range(s):</b>	2402-2480MHz
<b>Number of Channels:</b>	79 channels
<b>Transmit Power Max:</b>	10.56 dBm
<b>Antenna Type:</b>	Internal Antenna
<b>Antenna Gain:</b>	0.98 dBi
<b>Power supply:</b>	DC7.6V from internal battery DC 5V from adapter
<b>Data of received:</b>	February 08, 2023
<b>Temperature Range:</b>	0°C ~ +50°C

*Note: for more details, please refer to the User's manual of the EUT.*

### 3 SUMMARY OF TEST RESULT

FCC Part Clause	Test Parameter	Verdict	Remark
15.247(a)(1)	20 dB Bandwidth	PASS	
15.247(a)(1)	Carrier Frequency Separation	PASS	
15.247(a)(1)	Number of Hopping Frequencies	PASS	
15.247(a)(1)	Average Time of Occupancy (Dwell Time)	PASS	
15.247(b)(1)	Maximum Peak Conducted Output Power	PASS	
15.247(c)	Conducted Spurious Emissions	PASS	
15.247(d)	Radiated Spurious Emissions	PASS	
15.209			
15.207	Conducted Emission	PASS	
15.203	Antenna Application	PASS	
15.247 (a) (1)/g/h	Frequency Hopping System	PASS	
NOTE1: N/A (Not Applicable)			

RELATED SUBMITTAL(S) / GRANT(S):

This submittal(s) (test report) is intended for FCC ID: 2AUARTKTOOL10 filing to comply with Section 15.247 of the FCC Part 15, Subpart C Rules.

## 4 TEST METHODOLOGY

### 4.1 GENERAL DESCRIPTION OF APPLIED STANDARDS

According to its specifications, the EUT must comply with the requirements of the following standards:

FCC 47 CFR Part 2, Subpart J

FCC 47 CFR Part 15, Subpart C

FCC KDB 558074 D01 15.247 Meas Guidance v05r02

### 4.2 MEASUREMENT EQUIPMENT USED

#### 4.2.1 Conducted Emission Test Equipment

EQUIPMENT TYPE	MFR	MODEL NUMBER	SERIAL NUMBER	LAST CAL.	DUE CAL.
Test Receiver	Rohde & Schwarz	ESCI	101045	2022/5/14	05/13/2023
AMN	Schwarzbeck	NNLK 8129	8129203	2022/5/15	05/14/2023
AMN	Rohde & Schwarz	ESH3-Z5	100191	2022/5/15	05/14/2023
Pulse Limiter	Rohde & Schwarz	ESH3-Z2	100107	2022/5/14	05/13/2023

#### 4.2.2 Radiated Emission Test Equipment

EQUIPMENT TYPE	MFR	MODEL NUMBER	SERIAL NUMBER	LAST CAL.	DUE CAL.
EMI Test Receiver	Rohde & Schwarz	ESCI	101414	2022/5/14	05/13/2023
Pre-Amplifier	HP	8447F	2944A07999	2022/5/14	05/13/2023
Bilog Antenna	Schwarzbeck	VULB9163	712	7/5/2021	07/4/2023
Loop Antenna	ARA	FMZB1519	1519-012	6/12/2021	06/11/2023
Horn Antenna	Schwarzbeck	BBHA 9170	9170-399	6/12/2021	06/11/2023
Horn Antenna	Schwarzbeck	BBHA9120D	9120D-1198	6/15/2021	06/14/2023
Cable	Schwarzbeck	AK9513	ACRX1	2022/5/14	05/13/2023
Cable	Rosenberger	N/A	FP2RX2	2022/5/14	05/13/2023
Cable	Schwarzbeck	AK9513	CRPX1	2022/5/14	05/13/2023
Cable	Schwarzbeck	AK9513	CRRX2	2022/5/14	05/13/2023

#### 4.2.3 Radio Frequency Test Equipment

EQUIPMENT TYPE	MFR	MODEL NUMBER	SERIAL NUMBER	LASTCAL.	Cal. Interval
Wideband Radio Communication Tester	R&S	CMW500	171168	2022/5/3	05/02/2023
Frequency Extender	R&S	CMW-Z800A	100430	2022/5/16	05/15/2023
Spectrum Analyzer	R&S	FSV3044	MY60242456	2022/4/11	04/10/2023
Analog Signal Generator	R&S	SMB100A	MY61252625	2022/4/22	04/21/2023
Vector Signal Generator	R&S	SMM100A	MY61252674	2022/5/9	05/08/2023
RF Control Unit	Tonscend	JS0806-2	22C8060567	2022/7/20	N/A
Temperature&Humidity Chamber	ESPEC	EL-02KA	12107166	2022/7/2	07/01/2023

**Remark:** Each piece of equipment is scheduled for calibration once a year.

### 4.3 DESCRIPTION OF TEST MODES

The EUT has been tested under its typical operating condition.

The EUT configuration for testing is installed on RF field strength measurement to meet the Commissions requirement and operating in a manner which intends to maximize its emission characteristics in a continuous normal application.

The Transmitter was operated in the normal operating mode. The TX frequency was fixed which was for the purpose of the measurements.

Test of channel included the lowest and middle and highest frequency to perform the test, then record on this report.

Those data rates (1Mbps for Bluetooth GFSK modulation; 2Mbps for Bluetooth pi/4-DQPSK modulation; 3Mbps for Bluetooth 8DPSK modulation ) were used for all test.

Pre-defined engineering program for regulatory testing used to control the EUT for staying in continuous transmitting and receiving mode is programmed.

Frequency and Channel list for Bluetooth

Channel	Frequency (MHz)	Channel	Frequency (MHz)	Channel	Frequency (MHz)
0	2402	39	2441	...	...
1	2403	40	2442	76	2478
2	2404	41	2443	77	2479
...	...	...	...	78	2480

Note:  $f_c = 2402\text{MHz} + (k-1) \times 1\text{MHz}$  k=1 to 79

Test Frequency and channel for Bluetooth

Lowest Frequency		Middle Frequency		Highest Frequency	
Channel	Frequency (MHz)	Channel	Frequency (MHz)	Channel	Frequency (MHz)
0	2402	39	2441	78	2480

### 4.4 TEST SOFTWARE

Item	Software
Conducted Emission :	EMTEK(Ver.CON-03A1)-Shenzhen
Radiated Emission :	EMTEK(Ver.RA-03A1)-Shenzhen

## 5 FACILITIES AND ACCREDITATIONS

### 5.1 FACILITIES

All measurement facilities used to collect the measurement data are located at

Building 69, Majialong Industry Zone District, Nanshan District, Shenzhen, China

The sites are constructed in conformance with the requirements of ANSI C63.7, ANSI C63.4 and CISPR Publication 22.

### 5.2 LABORATORY ACCREDITATIONS AND LISTINGS

#### Site Description

EMC Lab.	: <b>Accredited by CNAS</b> The Certificate Registration Number is L2291. The Laboratory has been assessed and proved to be in compliance with CNAS-CL01 (identical to ISO/IEC 17025:2017)
	<b>Accredited by FCC</b> Designation Number: CN1204 Test Firm Registration Number: 882943
	<b>Accredited by A2LA</b> The Certificate Number is 4321.01.
	<b>Accredited by Industry Canada</b> The Conformity Assessment Body Identifier is CN0008
Name of Firm	: EMTEK (SHENZHEN) CO., LTD.
Site Location	: Building 69, Majialong Industry Zone, Nanshan District, Shenzhen, Guangdong, China



## 6 TEST SYSTEM UNCERTAINTY

The following measurement uncertainty levels have been estimated for tests performed on the apparatus:

Parameter	Uncertainty
Radio Frequency	$\pm 1 \times 10^{-5}$
Maximum Peak Output Power Test	$\pm 1.0\text{dB}$
Conducted Emissions Test	$\pm 2.0\text{dB}$
Radiated Emission Test	$\pm 2.0\text{dB}$
Occupied Bandwidth Test	$\pm 1.0\text{dB}$
Band Edge Test	$\pm 3\text{dB}$
All emission, radiated	$\pm 3\text{dB}$
Antenna Port Emission	$\pm 3\text{dB}$
Temperature	$\pm 0.5^\circ\text{C}$
Humidity	$\pm 3\%$

Measurement Uncertainty for a level of Confidence of 95%

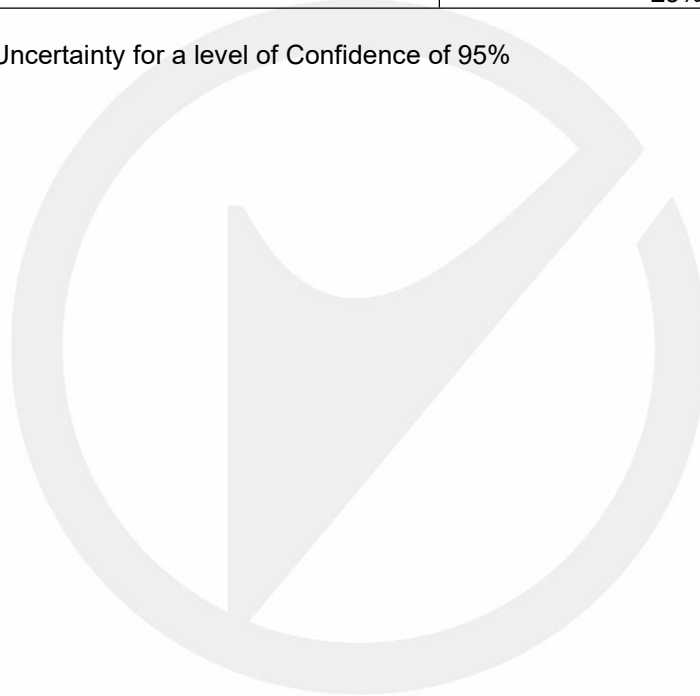

## 7 SETUP OF EQUIPMENT UNDER TEST

### 7.1 RADIO FREQUENCY TEST SETUP 1

The Bluetooth component's antenna ports(s) of the EUT are connected to the measurement instrument per an appropriate attenuator. The EUT is controlled by PC/software to emit the specified signals for the purpose of measurements.

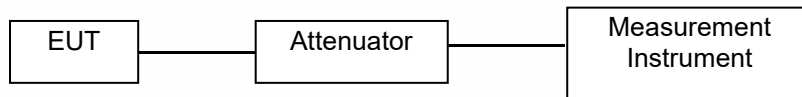

### 7.2 RADIO FREQUENCY TEST SETUP 2

The test site semi-anechoic chamber has met the requirement of NSA tolerance 4 dB according to the standards: ANSI C63.10. The test distance is 3m. The setup is according to the requirements in Section 13.1.4.1 of ANSI C63.10-2013 and CAN/CSA-CEI/IEC CISPR 22.

Below 30MHz:

The EUT is placed on a turntable 0.8meters above the ground in the chamber, 3 meter away from the antenna (loop antenna). The Antenna should be positioned with its plane vertical at the specified distance from the EUT and rotated about its vertical axis for maximum response at each azimuth about the EUT. The center of the loop shall be 1 m above the ground. For certain applications, the loop antenna plane may also need to be positioned horizontally at the specified distance from the EUT.

Above 30MHz:

The EUT is placed on a turntable 0.8meters above the ground in the chamber, 3 meter away from the antenna. The maximal emission value is acquired by adjusting the antenna height, polarisation and turntable azimuth. Normally, the height range of antenna is 1 m to 4 m, the azimuth range of turntable is 0° to 360°, and the receive antenna has two polarizations Vertical (V) and Horizontal (H).

Above 1GHz:

(Note: the FCC's permission to use 1.5m as an alternative per TCBC Conf call of Dec. 2, 2014.)

The EUT is placed on a turntable 1.5 meters above the ground in the chamber, 3 meter away from the antenna. The maximal emission value is acquired by adjusting the antenna height, polarisation and turntable azimuth. Normally, the height range of antenna is 1 m to 4 m, the azimuth range of turntable is 0° to 360°, and the receive antenna has two polarizations Vertical (V) and Horizontal (H).

(a) Radiated Emission Test Set-Up, Frequency Below 30MHz

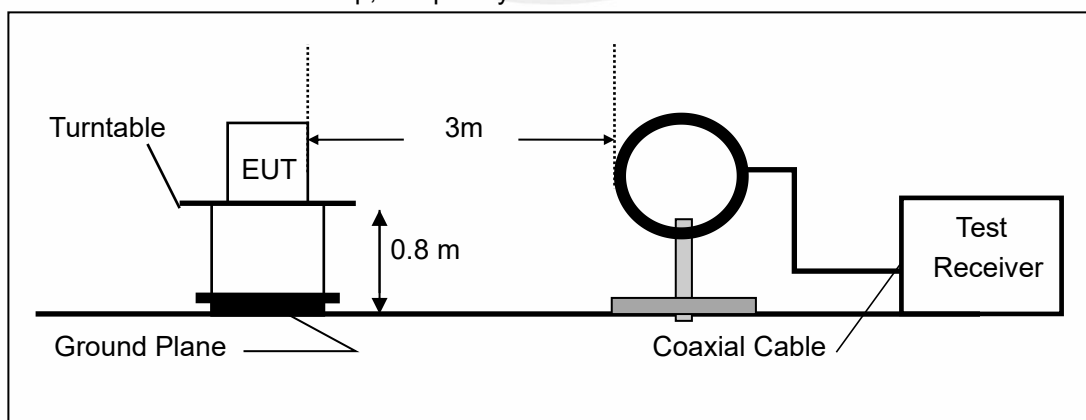

(b) Radiated Emission Test Set-Up, Frequency Below 1000MHz

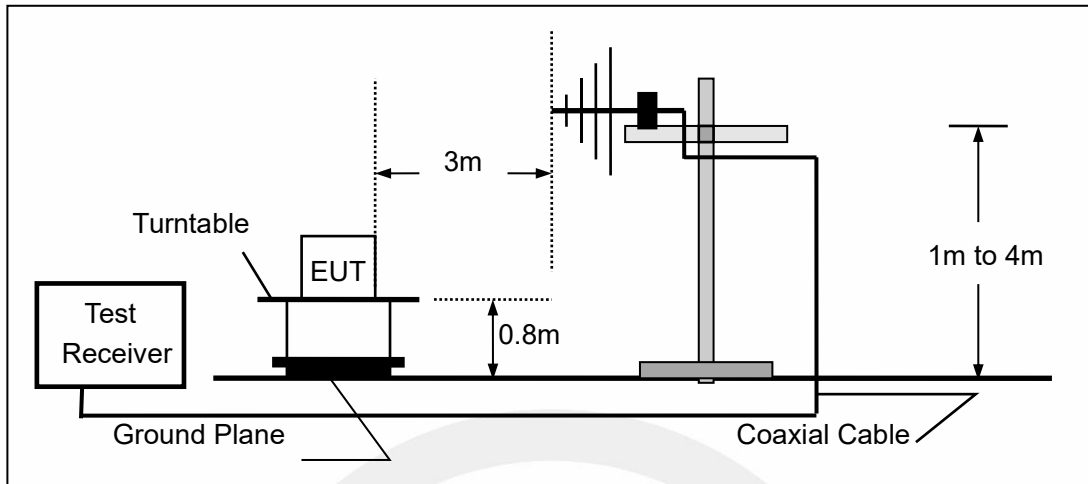

(c) Radiated Emission Test Set-Up, Frequency above 1000MHz

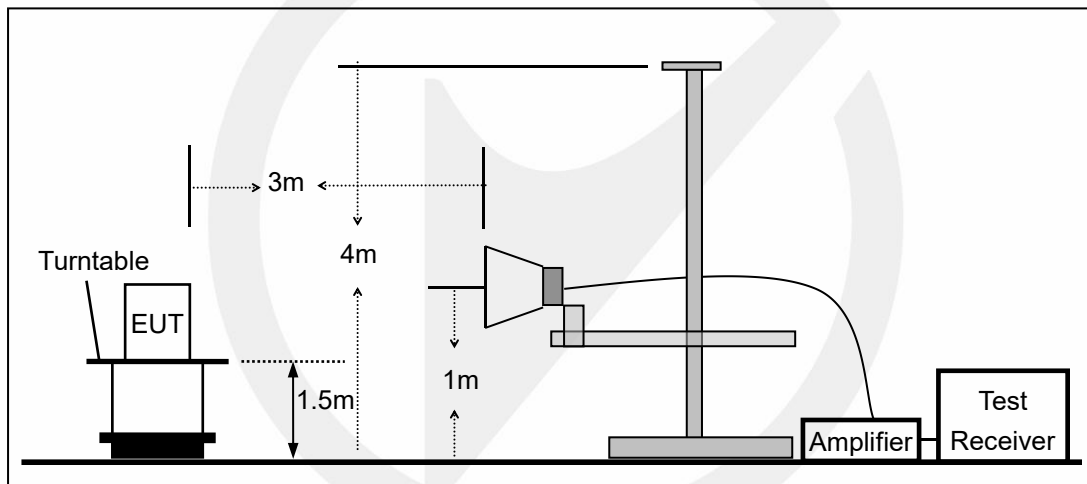

### 7.3 CONDUCTED EMISSION TEST SETUP

The mains cable of the EUT (Perfect Share Mini) must be connected to LISN. The LISN shall be placed 0.8m from the boundary of EUT and bonded to a ground reference plane for LISN mounted on top of the ground reference plane. This distance is between the closest points of the LISN and the EUT. All other units of the EUT and associated equipment shall be at least 0.8m from the LISN.

Ground connections, where required for safety purposes, shall be connected to the reference ground point of the LISN and, where not otherwise provided or specified by the manufacturer, shall be of same length as the mains cable and run parallel to the mains connection at a separation distance of not more than 0.1m.

According to the requirements in Section 13.1.4.1 of ANSI C63.10-2013 Conducted emissions from the EUT measured in the frequency range between 0.15 MHz and 30 MHz using CISPR Quasi-Peak and average detector mode.

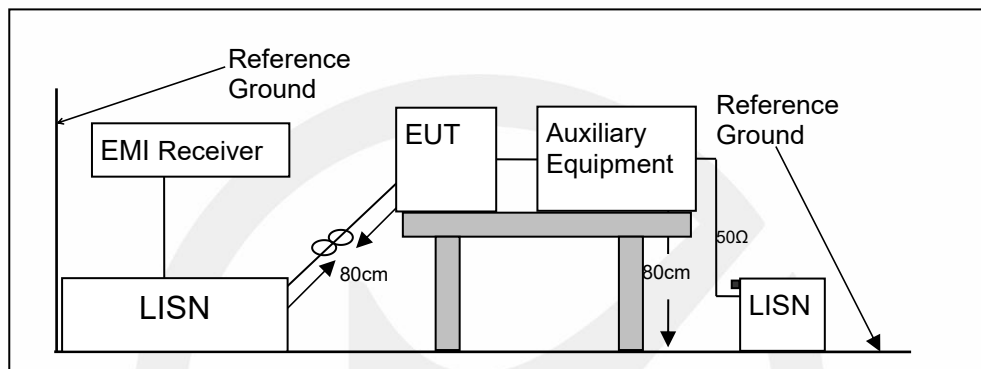

#### 7.4 BLOCK DIAGRAM CONFIGURATION OF TEST SYSTEM



#### 7.5 SUPPORT EQUIPMENT

EUT Cable List and Details			
Cable Description	Length (m)	Shielded/Unshielded	With / Without Ferrite
/	/	/	/

Auxiliary Cable List and Details			
Cable Description	Length (m)	Shielded/Unshielded	With / Without Ferrite
/	/	/	/

Auxiliary Equipment List and Details			
Description	Manufacturer	Model	Serial Number
Notebook	acer	ZR1	LXTECOCO76643158 372500

**Notes:**

1. All the equipment/cables were placed in the worst-case configuration to maximize the emission during the test.
2. Grounding was established in accordance with the manufacturer's requirements and conditions for the intended use.

## 8 FREQUENCY HOPPING SYSTEM REQUIREMENTS

### 8.1 Standard Applicable

According to FCC Part 15.247(a)(1), The system shall hop to channel frequencies that are selected at the system hopping rate from a pseudo randomly ordered list of hopping frequencies. Each frequency must be used equally on the average by each transmitter. The system receivers shall have input bandwidths that match the hopping channel bandwidths of their corresponding transmitters and shall shift frequencies in synchronization with the transmitted signals.

(g) Frequency hopping spread spectrum systems are not required to employ all available hopping channels during each transmission. However, the system, consisting of both the transmitter and the receiver, must be designed to comply with all of the regulations in this section should the transmitter be presented with a continuous data (or information) stream. In addition, a system employing short transmission bursts must comply with the definition of a frequency hopping system and must distribute its transmissions over the minimum number of hopping channels specified in this section.

(h) The incorporation of intelligence within a frequency hopping spread spectrum system that permits the system to recognize other users within the spectrum band so that it individually and independently chooses and adapts its hopsets to avoid hopping on occupied channels is permitted. The coordination of frequency hopping systems in any other manner for the express purpose of avoiding the simultaneous occupancy of individual hopping frequencies by multiple transmitters is not permitted.

### 8.2 EUT Pseudorandom Frequency Hopping Sequence

The channel is represented by a pseudo-random hopping sequence hopping through the 79 RF channels.

The hopping sequence is unique for the piconet and is determined by the Bluetooth device address of the master; the phase in the hopping sequence is determined by the Bluetooth clock of the master. The channel is divided into time slots where each slot corresponds to an RF hop frequency. Consecutive hops correspond to different RF hop frequencies. The normal hop is 1 600 hops/s.

The pseudorandom sequence may be generated in a nine-stage shift register whose 5th and 9th stage outputs are added in a modulo-two addition stage, and the result is fed back to the input of the first stage. The sequence begins with the first ONE of 9 consecutive ONES; i.e. the shift register is initialized with nine ones. Number of shift register stages: 9

Length of pseudo-random sequence:  $2^9 - 1 = 511$  bits

Longest sequence of zeros: 8 (non-inverted signal)

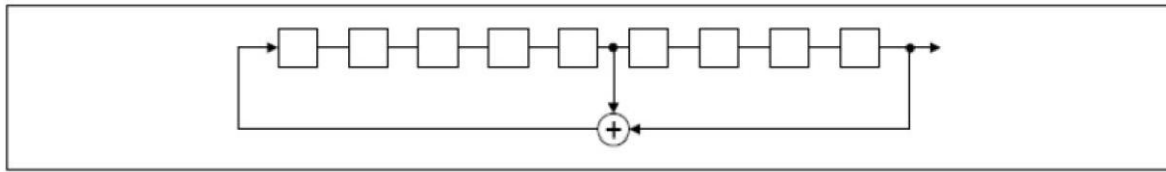

Linear Feedback Shift Register for Generation of the PRBS sequence

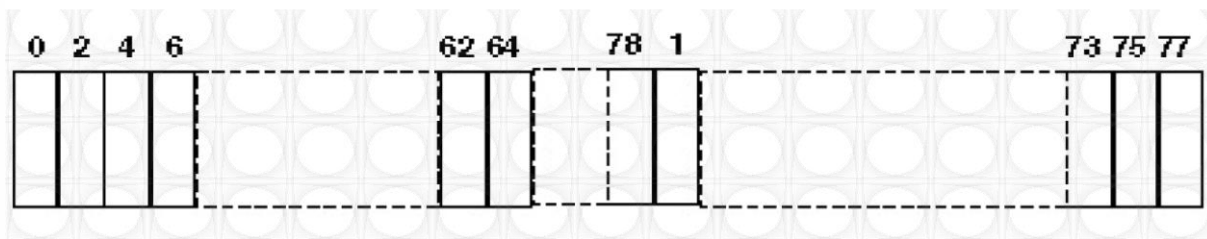

Each frequency used equally on the average by each transmitter. The system receiver have input bandwidths that match the hopping channel bandwidths of their corresponding transmitters and shift frequencies in synchronization with the transmitted signals.

### 8.3 Equal Hopping Frequency Use

All Bluetooth units participating in the piconet are time and hop-synchronized to the channel.

Example of a 79 hopping sequence in data mode:

35, 27, 6, 44, 14, 61, 74, 32, 1, 11, 23, 2, 55, 65, 29, 3, 9, 52, 78, 58, 40, 25, 0, 7, 18, 26, 76, 60, 47, 50, 2, 5, 16, 37, 70, 63, 66, 54, 20, 13, 4, 8, 15, 21, 26, 10, 73, 77, 67, 69, 43, 24, 57, 39, 46, 72, 48, 33, 17, 31, 75, 19, 41, 62, 68, 28, 51, 66, 30, 56, 34, 59, 71, 22, 49, 64, 38, 45, 36, 42, 53

Each Frequency used equally on the average by each transmitter

### 8.4 Frequency Hopping System

This transmitter device is frequency hopping device, and complies with FCC part 15.247 rule.

This device uses Bluetooth radio which operates in 2400-2483.5 MHz band. Bluetooth uses a radio technology called frequency-hopping spread spectrum, which chops up the data being sent and transmits chunks of it on up to 79 bands (1 MHz each; centred from 2402 to 2480 MHz) in the range 2,400-2,483.5 MHz. The transmitter switches hop frequencies 1,600 times per second to assure a high degree of data security. All Bluetooth devices participating in a given piconet are synchronized to the frequency-hopping channel for the piconet. The frequency hopping sequence is determined by the master's device address and the phase of the hopping sequence (the frequency to hop at a specific time) is determined by the master's internal clock. Therefore, all slaves in a piconet must know the master's device address and must synchronize their clocks with the master's clock.

Adaptive Frequency Hopping (AFH) was introduced in the Bluetooth specification to provide an effective way for a Bluetooth radio to counteract normal interference. AFH identifies "bad" channels, where either other wireless devices are interfering with the Bluetooth signal or the Bluetooth signal is interfering with another device. The AFH-enabled Bluetooth device will then communicate with other devices within its piconet to share details of any identified bad channels. The devices will then switch to alternative available "good" channels, away from the areas of interference, thus having no impact on the bandwidth used.

## 9 TEST REQUIREMENTS

### 9.1 20DB BANDWIDTH

#### 9.1.1 Applicable Standard

According to FCC Part 15.247(a)(1) and KDB 558074 D01 15.247 meas guidance v05r02

#### 9.1.2 Conformance Limit

No limit requirement.

#### 9.1.3 Test Configuration

Test according to clause 7.1 radio frequency test setup 1

#### 9.1.4 Test Procedure

The EUT was operating in Bluetooth mode and controlled its channel. Printed out the test result from the spectrum by hard copy function.

The RF output of EUT was connected to the spectrum analyzer by RF cable and attenuator. The path loss was compensated to the results for each measurement.

Set to the maximum power setting and enable the EUT transmit continuously

Set RBW = 30 kHz.

Set the video bandwidth (VBW) =100 kHz.

Set Span= approximately 2 to 3 times the 20 dB bandwidth

Set Detector = Peak.

Set Trace mode = max hold.

Set Sweep = auto couple.

The EUT should be transmitting at its maximum data rate. Allow the trace to stabilize. Use the marker-to-peak function to set the marker to the peak of the emission. Use the marker-delta function to measure 20 dB down one side of the emission. Reset the markerdelta function, and move the marker to the other side of the emission, until it is (as close as possible to) even with the reference marker level. The marker-delta reading at this point is the 20 dB bandwidth of the emission.

If this value varies with different modes of operation (e.g., data rate, modulation format, etc.), repeat this test for each variation.

Measure and record the results in the test report.

#### Test Results

Temperature:	25° C
Relative Humidity:	45%
ATM Pressure:	1011 mbar

TestMode	Antenna	Frequency[MHz]	20db EBW[MHz]	FL[MHz]	FH[MHz]	Limit[MHz]	Verdict
DH5	Ant1	2402	0.87	2401.55	2402.41	---	---
		2441	0.86	2440.55	2441.41	---	---
		2480	0.86	2479.55	2480.41	---	---
2DH5	Ant1	2402	1.27	2401.37	2402.64	---	---
		2441	1.25	2440.37	2441.63	---	---
		2480	1.25	2479.37	2480.63	---	---
3DH5	Ant1	2402	1.26	2401.36	2402.62	---	---
		2441	1.25	2440.37	2441.62	---	---
		2480	1.25	2479.37	2480.62	---	---



## DH5\_Ant1\_2402

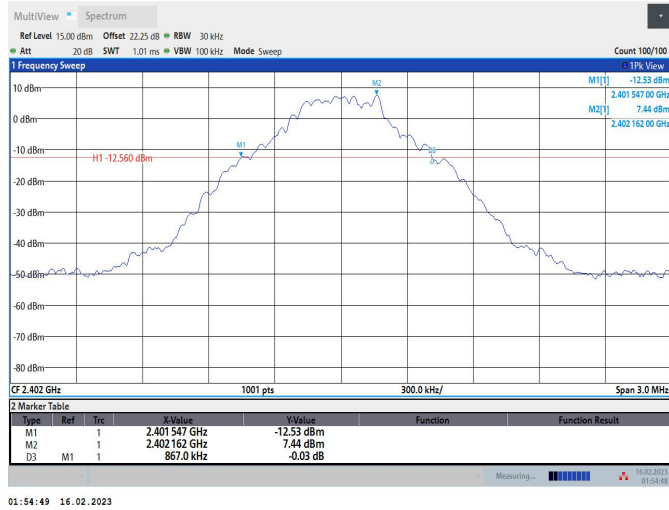

## DH5\_Ant1\_2441



## DH5\_Ant1\_2480



### 2DH5\_Ant1\_2402

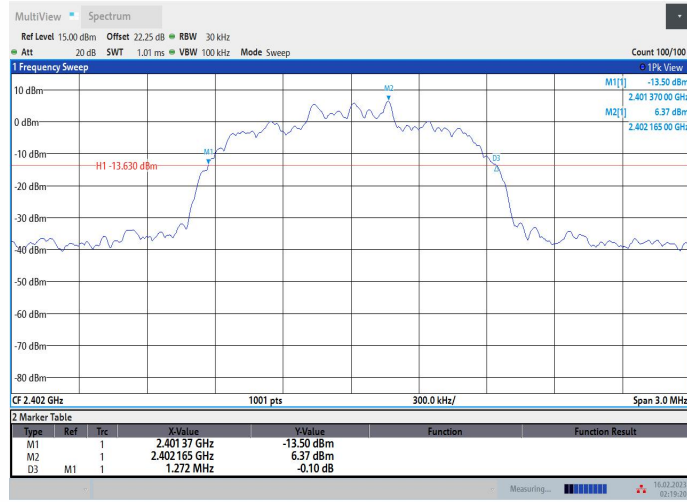

02:19:21 16.02.2023

### 2DH5\_Ant1\_2441



02:21:43 16.02.2023

### 2DH5\_Ant1\_2480



02:25:16 16.02.2023

### 3DH5\_Ant1\_2402

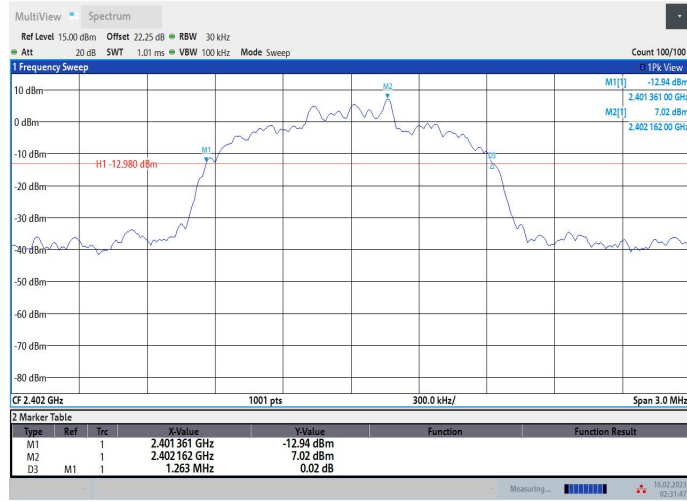

02:31:48 16.02.2023

### 3DH5\_Ant1\_2441



02:36:34 16.02.2023

### 3DH5\_Ant1\_2480



02:39:50 16.02.2023

## 9.2 CARRIER FREQUENCY SEPARATION

### 9.2.1 Applicable Standard

According to FCC Part 15.247(a)(1) and KDB 558074 D01 15.247 meas guidance v05r02

### 9.2.2 Conformance Limit

Frequency hopping systems operating in the 2400-2483.5MHz band shall have hopping channel carrier frequencies separated by a minimum of 25kHz or the 20dB bandwidth of the hopping channel, whichever is greater.

In case of an output power less than 125mW, the frequency hopping system may have channels separated by a minimum of 25kHz or two-thirds of the 20dB bandwidth of the hopping channel, whichever is greater.

### 9.2.3 Test Configuration

Test according to clause 7.1 radio frequency test setup 1

### 9.2.4 Test Procedure

■ According to FCC Part15.247(a)(1)

The EUT must have its hopping function enabled. Use the following spectrum analyzer settings:

Set the RBW =100kHz. Set VBW =300kHz.

Set the span = wide enough to capture the peaks of two adjacent channels

Set Sweep time = auto couple.

Set Detector = peak. Set Trace mode = max hold.

Allow the trace to stabilize. Use the marker-delta function to determine the separation between the peaks of the adjacent channels. The limit is specified in one of the subparagraphs of this Section. Submit this plot.

### Test Results

Temperature:	25° C
Relative Humidity:	45%
ATM Pressure:	1011 mbar

TestMode	Antenna	Frequency[MHz]	Result[MHz]	Limit[MHz]	Verdict
DH5	Ant1	Hop_2402	0.994	≥0.870	PASS
		Hop_2441	1.016	≥0.870	PASS
		Hop_2480	1.018	≥0.870	PASS
2DH5	Ant1	Hop_2402	1.006	≥0.847	PASS
		Hop_2441	1.014	≥0.847	PASS
		Hop_2480	1.006	≥0.847	PASS
3DH5	Ant1	Hop_2402	0.992	≥0.840	PASS
		Hop_2441	0.996	≥0.840	PASS
		Hop_2480	1.014	≥0.840	PASS

## DH5\_Ant1\_Hop\_2402

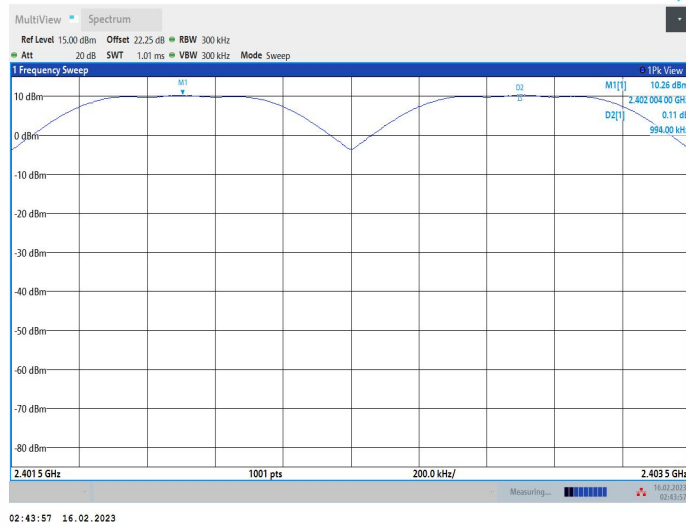

02:43:57 16.02.2023

## DH5\_Ant1\_Hop\_2441

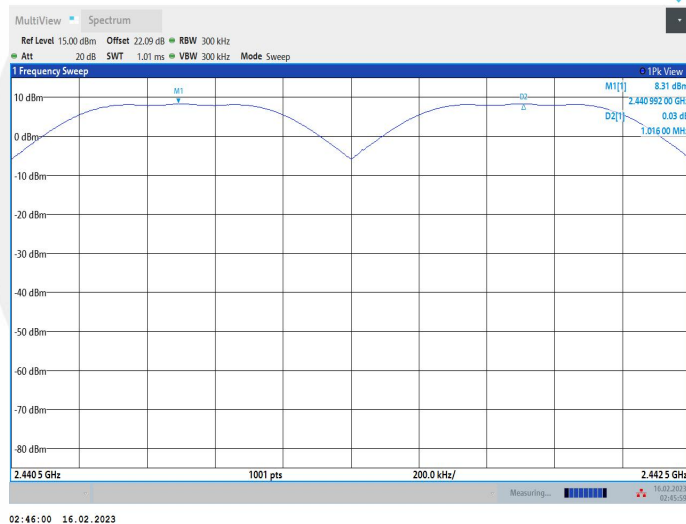

02:46:00 16.02.2023

## DH5\_Ant1\_Hop\_2480

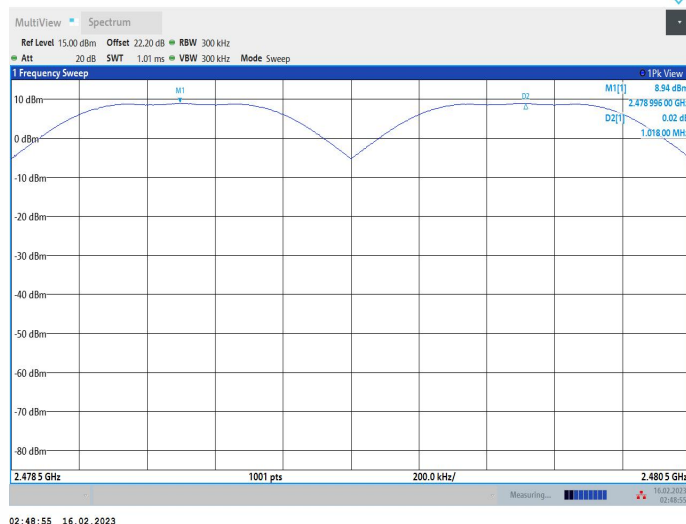

02:48:55 16.02.2023

## 2DH5\_Ant1\_Hop\_2402

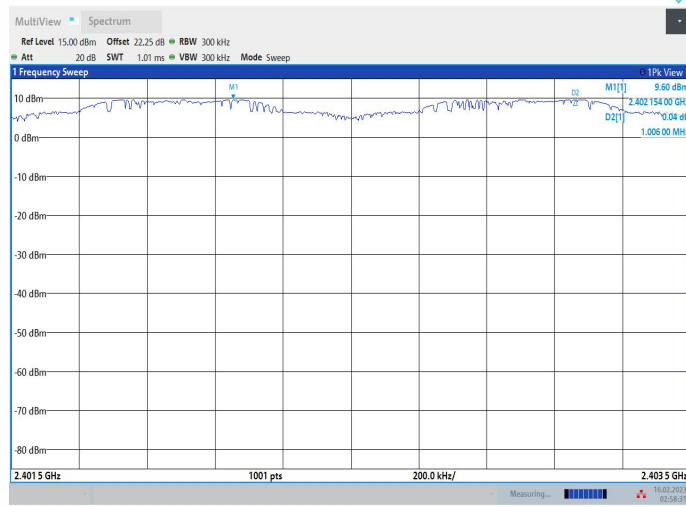

## 2DH5\_Ant1\_Hop\_2441

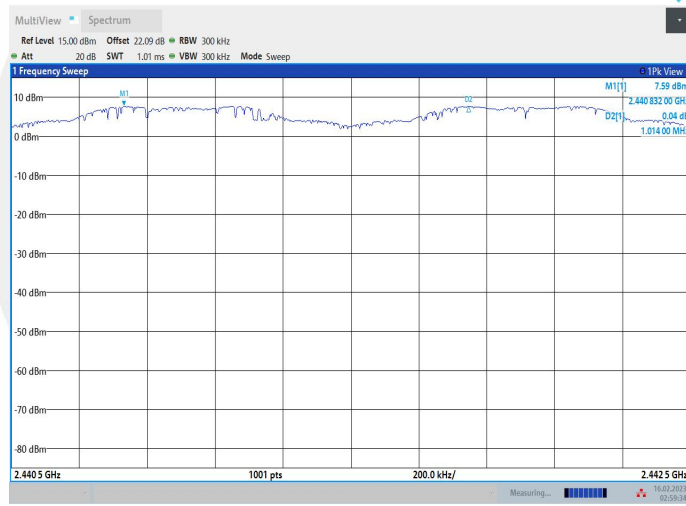

## 2DH5\_Ant1\_Hop\_2480

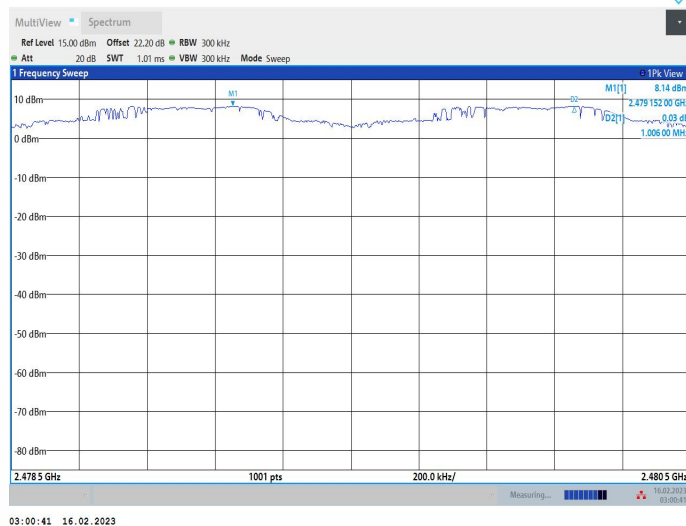

## 3DH5\_Ant1\_Hop\_2402

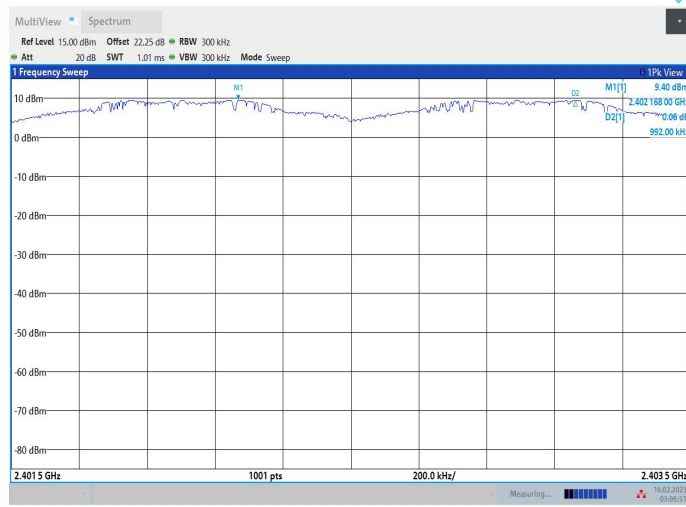

## 3DH5\_Ant1\_Hop\_2441

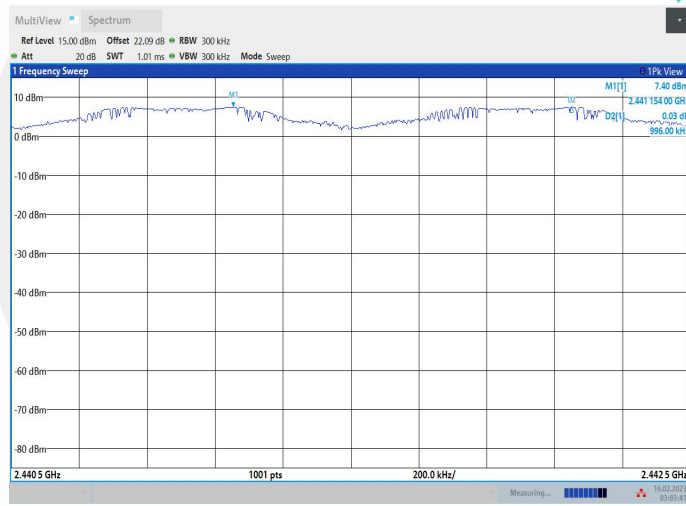

## 3DH5\_Ant1\_Hop\_2480

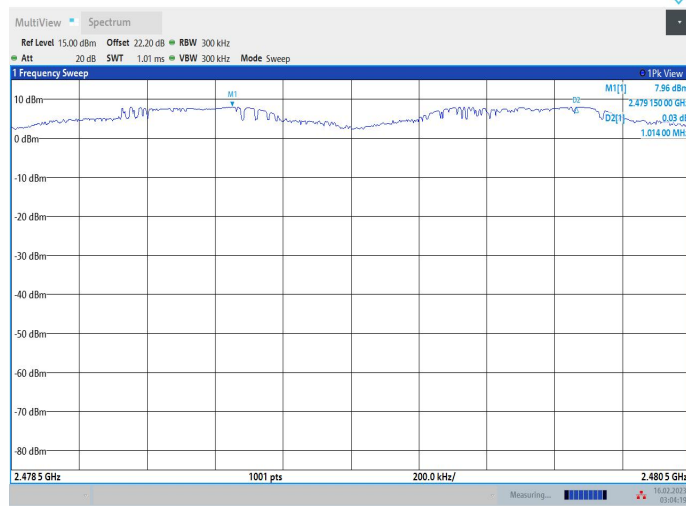

### 9.3 NUMBER OF HOPPING FREQUENCIES

#### 9.3.1 Applicable Standard

According to FCC Part 15.247(a)(1) (iii) and KDB 558074 D01 15.247 meas guidance v05r02

#### 9.3.2 Conformance Limit

Frequency hopping systems operating in the 2400-2483.5MHz band shall use at least 15 channels.

#### 9.3.3 Test Configuration

Test according to clause 7.1 radio frequency test setup 1

#### 9.3.4 Test Procedure

- According to FCC Part 15.247(a)(1)(iii)

The EUT must have its hopping function enabled. Use the following spectrum analyzer settings:

Span = the frequency band of operation (2400-2483.5MHz)

RBW  $\geq$  100KHz

VBW  $\geq$  RBW

Sweep = auto

Detector function = peak

Trace = max hold

Allow the trace to stabilize. It may prove necessary to break the span up to sections, in order to clearly show all of the hopping frequencies.

#### Test Results

Temperature:	25° C
Relative Humidity:	45%
ATM Pressure:	1011 mbar

TestMode	Antenna	Frequency[MHz]	Result[Num]	Limit[Num]	Verdict
DH5	Ant1	Hop	79	$\geq 15$	PASS
2DH5	Ant1	Hop	79	$\geq 15$	PASS
3DH5	Ant1	Hop	79	$\geq 15$	PASS



## DH5\_Ant1\_Hop

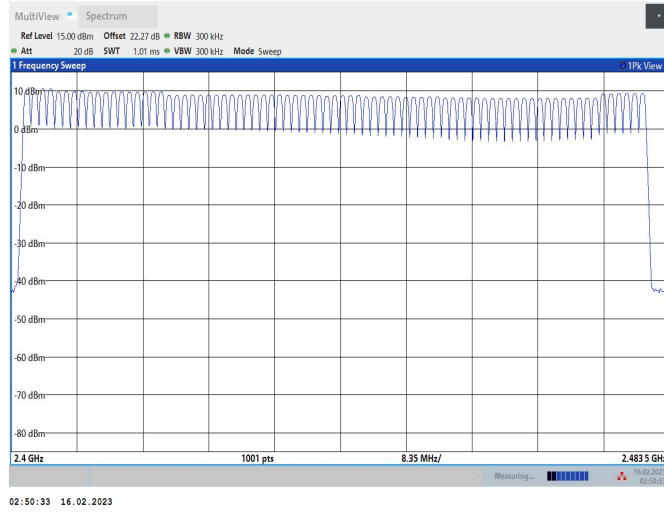

02:50:33 16.02.2023

## 2DH5\_Ant1\_Hop

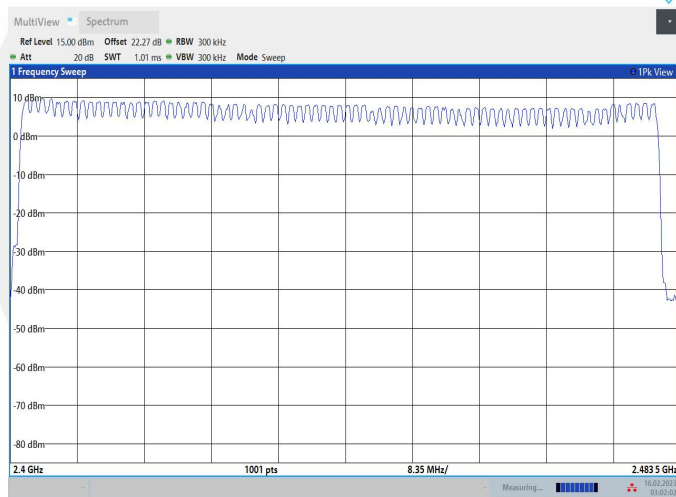

03:02:03 16.02.2023

## 3DH5\_Ant1\_Hop

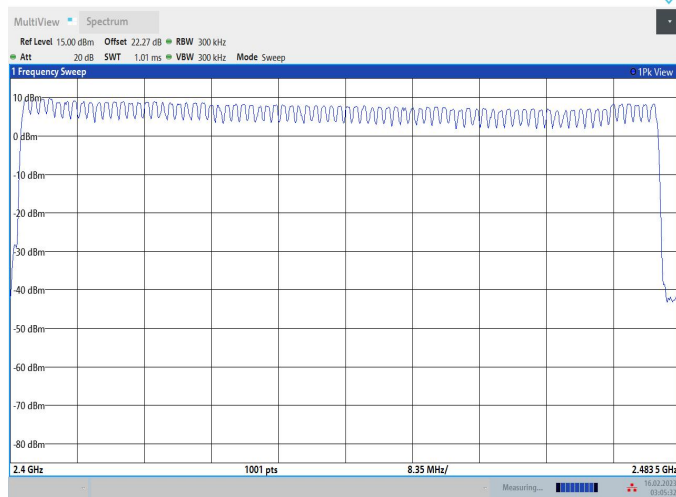

03:05:33 16.02.2023

## 9.4 AVERAGE TIME OF OCCUPANCY (DWELL TIME)

### 9.4.1 Applicable Standard

According to FCC Part 15.247(a)(1)(iii) and KDB 558074 D01 15.247 meas guidance v05r02

### 9.4.2 Conformance Limit

For frequency hopping systems operating in the 2400-2483.5MHz band, the average time of occupancy on any channel shall not be greater than 0.4s within a period of 0.4s multiplied by the number of hopping channels employed.

### 9.4.3 Test Configuration

Test according to clause 7.1 radio frequency test setup 1

### 9.4.4 Test Procedure

■ According to FCC Part15.247(a)(1)(iii)

The EUT must have its hopping function enabled. Use the following spectrum analyzer settings:

Span = zero span, centered on a hopping channel

RBW = 1 MHz

VBW  $\geq$  RBW

Sweep = as necessary to capture the entire dwell time per hopping channel

Detector function = peak

Trace = max hold

If possible, use the marker-delta function to determine the dwell time. If this value varies with different modes of operation (e.g., data rate, modulation format, etc.), repeat this test for each variation. The limit is specified in one of the subparagraphs of this Section.

### 9.4.5 Test Results

Temperature:	25° C
Relative Humidity:	45%
ATM Pressure:	1011 mbar

Bluetooth (GFSK, pi/4-DQPSK, 8DPSK) mode have been tested, and the worst result(GFSK) was report as below:

TestMode	Antenna	Frequency[MHz]	BurstWidth [ms]	TotalHops [Num]	Result[s]	Limit[s]	Verdict
DH1	Ant1	Hop	0.360	320	0.115	$\leq 0.4$	PASS
DH3	Ant1	Hop	1.610	160	0.258	$\leq 0.4$	PASS
DH5	Ant1	Hop	2.870	106.67	0.306	$\leq 0.4$	PASS

## DH1\_Ant1\_Hop

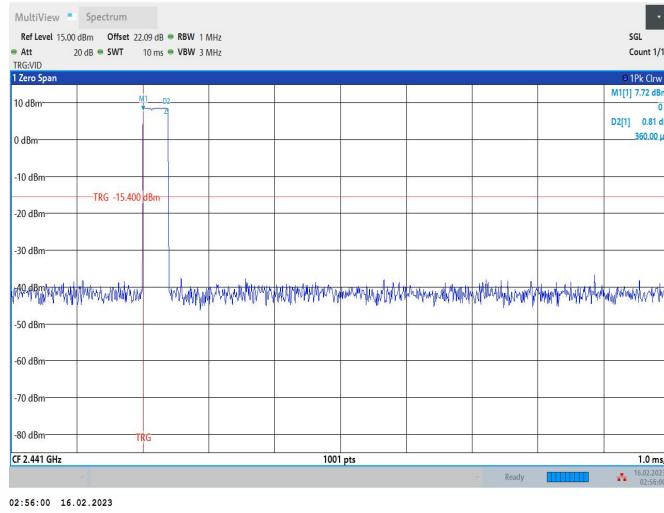

## DH3\_Ant1\_Hop

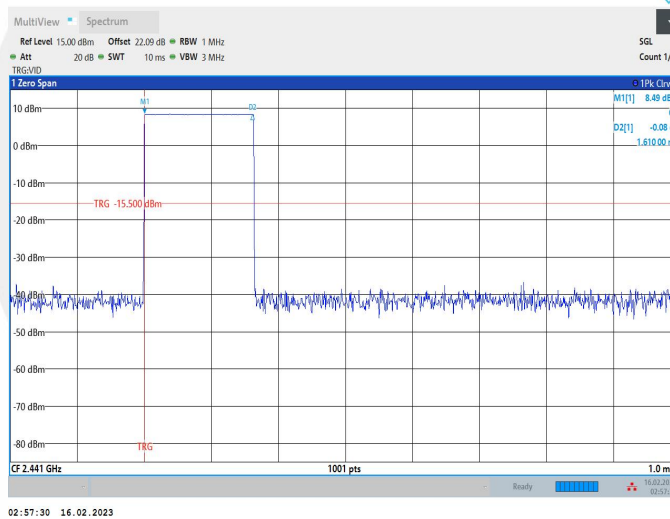

## DH5\_Ant1\_Hop

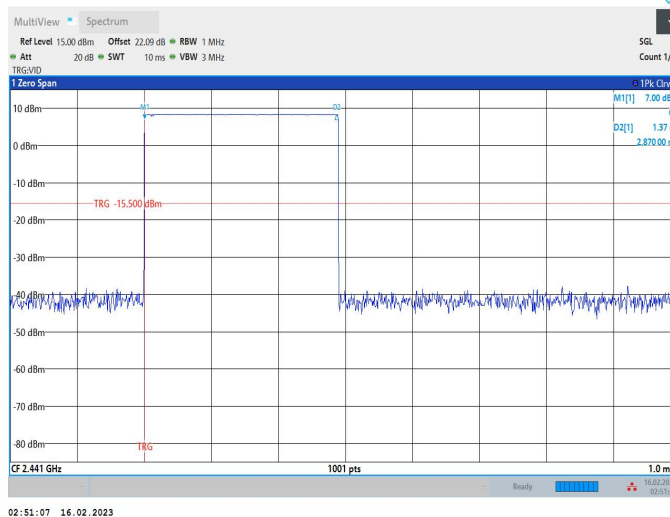

## 9.5 MAXIMUM PEAK CONDUCTED OUTPUT POWER

### 9.5.1 Applicable Standard

According to FCC Part 15.247(b)(1) and KDB 558074 D01 15.247 meas guidance v05r02

### 9.5.2 Conformance Limit

The max For frequency hopping systems operating in the 2400-2483.5 MHz band employing at least 75 non-overlapping hopping channels: 1 watt. For all other frequency hopping systems in the 2400-2483.5 MHz band: 0.125 watts.

### 9.5.3 Test Configuration

Test according to clause 7.1 radio frequency test setup 1

### 9.5.4 Test Procedure

■ According to FCC Part15.247(b)(1)

As an alternative to a peak power measurement, compliance with the limit can be based on a measurement of the maximum conducted output power.

Use the following spectrum analyzer settings:

Set Span = approximately 5 times the 20 dB bandwidth, centered on a hopping channel (about 10MHz)

Set RBW > the 20 dB bandwidth of the emission being measured (about 3MHz)

Set VBW ≥ RBW

Set Sweep = auto

Set Detector function = peak

Set Trace = max hold

Allow the trace to stabilize. Use the marker-to-peak function to set the marker to the peak of the emission to determine the peak amplitude level.

### Test Results

Temperature:	25° C
Relative Humidity:	45%
ATM Pressure:	1011 mbar

Test Mode	Antenna	Frequency[MHz]	Conducted Peak Power[dBm]	Conducted Limit[dBm]	Verdict
DH5	Ant1	2402	10.56	≤30	PASS
		2441	8.63	≤30	PASS
		2480	9.17	≤30	PASS
2DH5	Ant1	2402	9.93	≤30	PASS
		2441	7.8	≤30	PASS
		2480	8.39	≤30	PASS
3DH5	Ant1	2402	9.81	≤30	PASS
		2441	7.67	≤30	PASS
		2480	8.23	≤30	PASS

## DH5\_Ant1\_2402

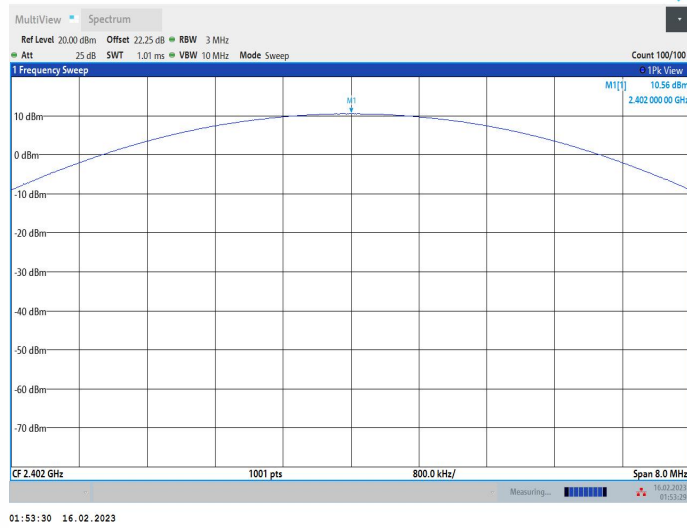

## DH5\_Ant1\_2441

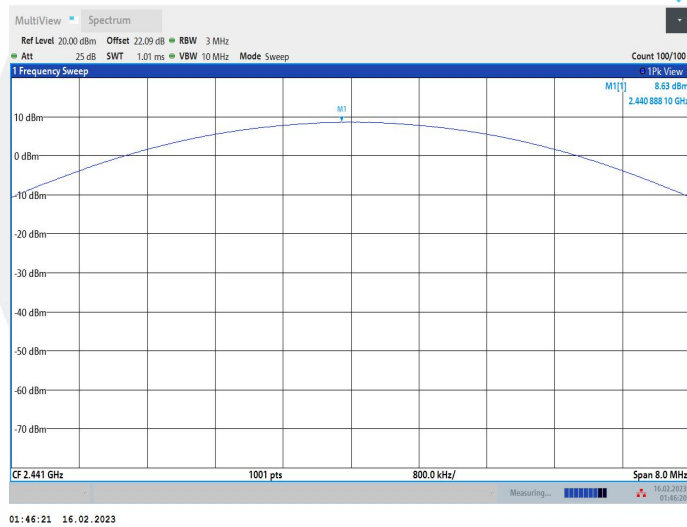

## DH5\_Ant1\_2480

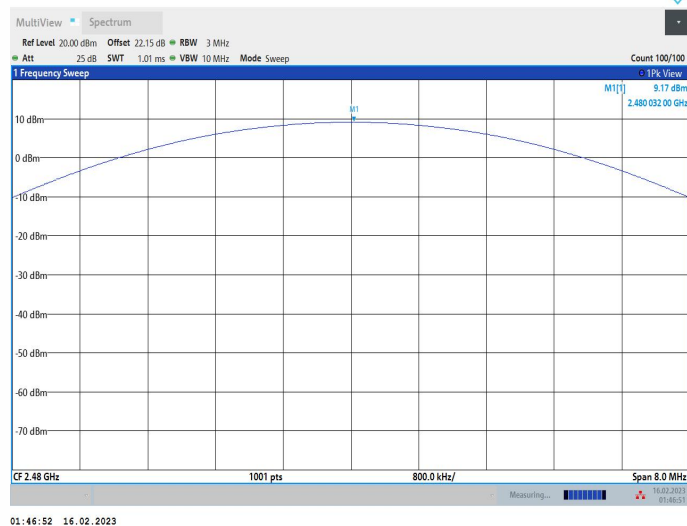

## 2DH5\_Ant1\_2402

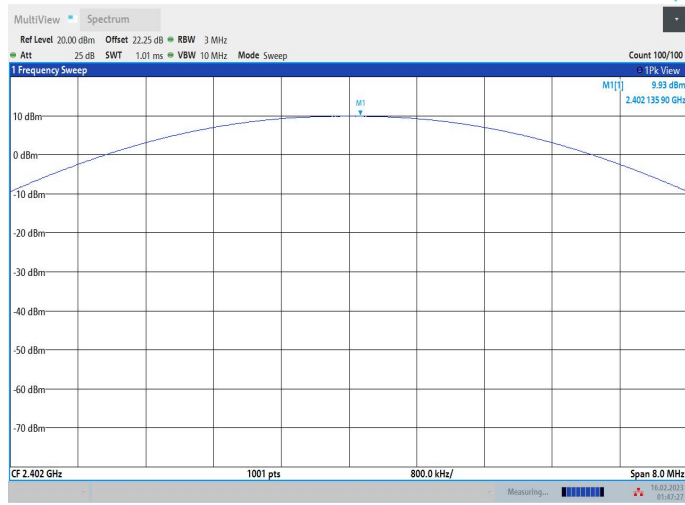

01:47:28 16.02.2023

## 2DH5\_Ant1\_2441

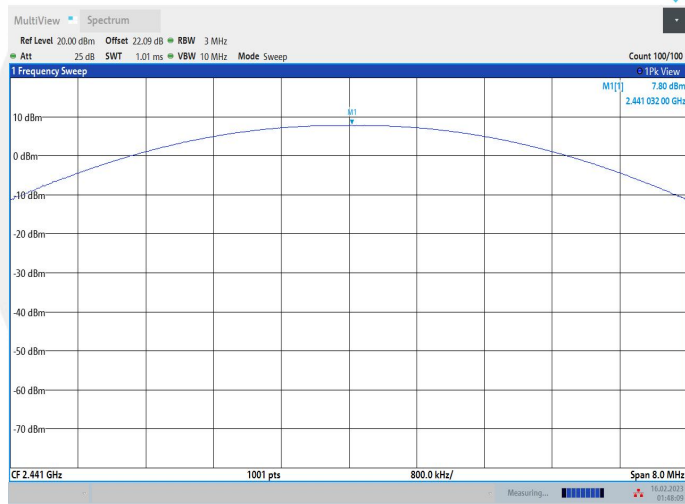

01:48:09 16.02.2023

## 2DH5\_Ant1\_2480

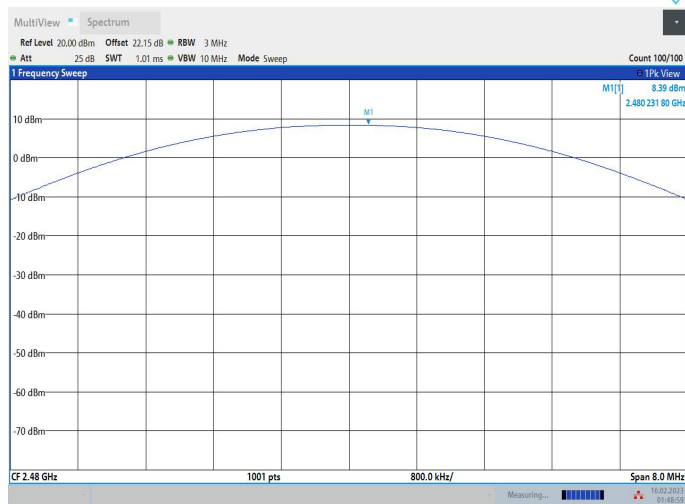

01:48:59 16.02.2023

## 3DH5\_Ant1\_2402

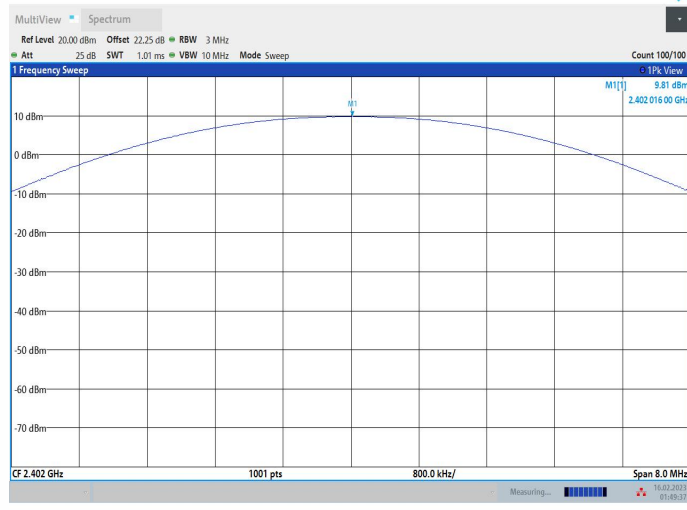

## 3DH5\_Ant1\_2441

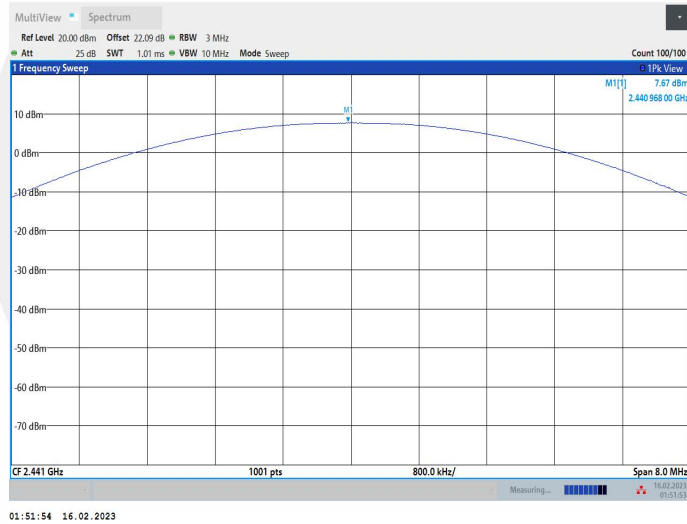

## 3DH5\_Ant1\_2480

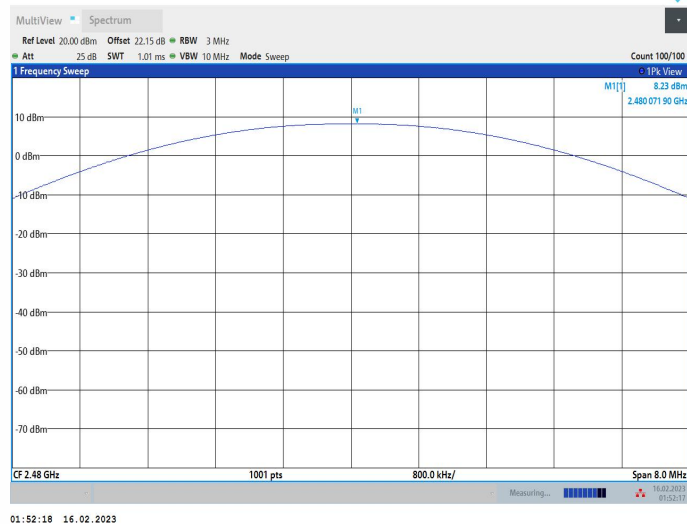

## 9.6 CONDUCTED SUPRIIOUS EMISSION

### 9.6.1 Applicable Standard

According to FCC Part 15.247(d) and KDB 558074 D01 15.247 meas guidance v05r02

### 9.6.2 Conformance Limit

According to FCC Part 15.247(d):

In any 100 kHz bandwidth outside the frequency band in which the spread spectrum intentional radiator is operating, the radio frequency power that is produced by the intentional radiator shall be at least 20 dB below that in the 100 kHz bandwidth within the band that contains the highest level of the desired power, based on either an RF conducted, provided the transmitter demonstrates compliance with the peak conducted power limits.

### 9.6.3 Test Configuration

Test according to clause 7.1 radio frequency test setup 1

### 9.6.4 Test Procedure

The transmitter output (antenna port) was connected to the spectrum analyzer

#### ■ Reference level measurement

Establish a reference level by using the following procedure:

Set instrument center frequency to DSS channel center frequency.

Set Span = approximately 5 times the 20 dB bandwidth, centered on a hopping channel.

Set the RBW = 100 kHz. Set the VBW  $\geq 3 \times$  RBW.

Set Detector = peak. Set Sweep time = auto couple.

Set Trace mode = max hold. Allow trace to fully stabilize.

Use the peak marker function to determine the maximum Maximum conduceted level.

Note that the channel found to contain the maximum conduceted level can be used to establish the reference level.

#### ■ Band-edge Compliance of RF Conducted Emissions

Use the following spectrum analyzer settings:

Span = wide enough to capture the peak level of the emission operating on the channel closest to the band-edge, as well as any modulation products which fall outside of the authorized band of operation

Set RBW  $\geq 1\%$  of the span=100kHz Set VBW  $\geq$  RBW

Set Sweep = auto Set Detector function = peak Set Trace = max hold

Allow the trace to stabilize. Set the marker on the emission at the bandedge, or on the highest modulation product outside of the band, if this level is greater than that at the bandedge. Enable the marker-delta function, then use the marker-to-peak function to move the marker to the peak of the in-band emission. The marker-delta value now displayed must comply with the limit specified in this Section.

Now, using the same instrument settings, enable the hopping function of the EUT. Allow the trace to stabilize. Follow the same procedure listed above to determine if any spurious emissions caused by the hopping function also comply with the specified limit.

#### ■ Conduceted Spurious RF Conducted Emission

Use the following spectrum analyzer settings:

Span = wide enough to capture the peak level of the in-band emission and all spurious emissions (e.g., harmonics) from the lowest frequency generated in the EUT up through the 10th harmonic.(30MHz to 25GHz). Set RBW = 100 kHz Set VBW  $\geq$  RBW

Set Sweep = auto Set Detector function = peak Set Trace = max hold

Allow the trace to stabilize. Set the marker on the peak of any spurious emission recorded. The level displayed must comply with the limit specified in this Section.



### 9.6.5 Test Results

Bluetooth (GFSK, pi/4-DQPSK, 8DPSK) mode have been tested, and the worst result(GFSK) was report as below:

#### Band edge measurements

TestMode	Antenna	ChName	Frequency[MHz]	RefLevel [dBm]	Result [dBm]	Limit [dBm]	Verdict
DH5	Ant1	Low	2402	9.94	-46.21	≤-10.06	PASS
		High	2480	8.66	-45.79	≤-11.34	PASS
		Low	Hop_2402	9.97	-45.58	≤-10.03	PASS
		High	Hop_2480	8.47	-45.99	≤-11.53	PASS
2DH5	Ant1	Low	2402	9.42	-44.51	≤-10.58	PASS
		High	2480	8.05	-45.88	≤-11.95	PASS
3DH5	Ant1	Low	2402	9.34	-45.55	≤-10.66	PASS
		High	2480	7.96	-45.73	≤-12.04	PASS

#### Conducted Spurious Emission

TestMode	Antenna	Frequency[MHz]	FreqRange [MHz]	RefLevel [dBm]	Result [dBm]	Limit [dBm]	Verdict
DH5	Ant1	2402	30~1000	9.94	-41.41	≤-10.06	PASS
			1000~26500	9.94	-40.01	≤-10.06	PASS
		2441	30~1000	8.10	-42.78	≤-11.9	PASS
			1000~26500	8.10	-38.93	≤-11.9	PASS
		2480	30~1000	8.66	-42.24	≤-11.34	PASS
			1000~26500	8.66	-38.54	≤-11.34	PASS
2DH5	Ant1	2402	30~1000	9.42	-43.12	≤-10.58	PASS
			1000~26500	9.42	-40.16	≤-10.58	PASS
		2441	30~1000	7.48	-43.96	≤-12.52	PASS
			1000~26500	7.48	-39.61	≤-12.52	PASS
		2480	30~1000	8.05	-43.68	≤-11.95	PASS
			1000~26500	8.05	-40.02	≤-11.95	PASS
3DH5	Ant1	2402	30~1000	9.34	-42.57	≤-10.66	PASS
			1000~26500	9.34	-39.76	≤-10.66	PASS
		2441	30~1000	7.40	-42.86	≤-12.6	PASS
			1000~26500	7.40	-40.09	≤-12.6	PASS
		2480	30~1000	7.96	-41.97	≤-12.04	PASS
			1000~26500	7.96	-39.47	≤-12.04	PASS

### Band edge measurements

DH5\_Ant1\_Low\_2402

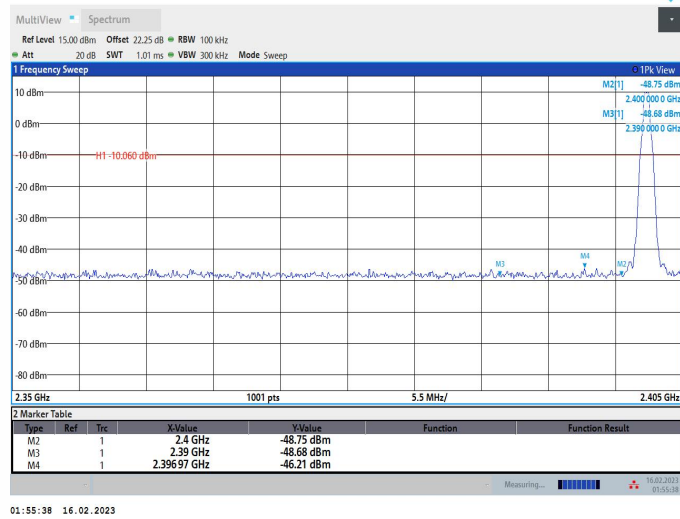

01:55:38 16.02.2023

DH5\_Ant1\_High\_2480

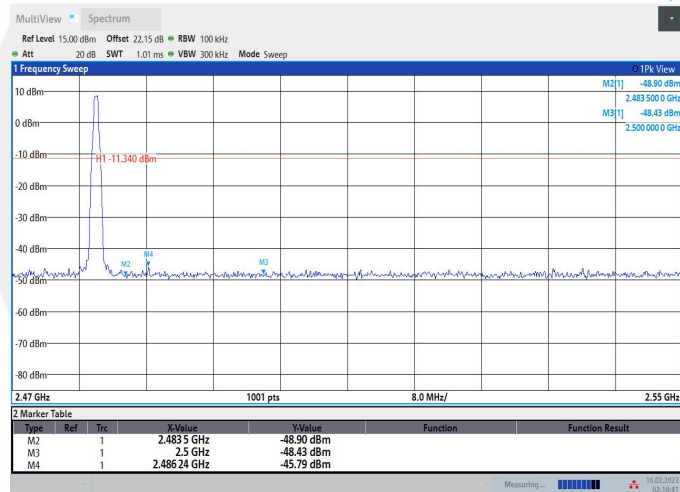

02:10:42 16.02.2023

DH5\_Ant1\_Low\_Hop\_2402

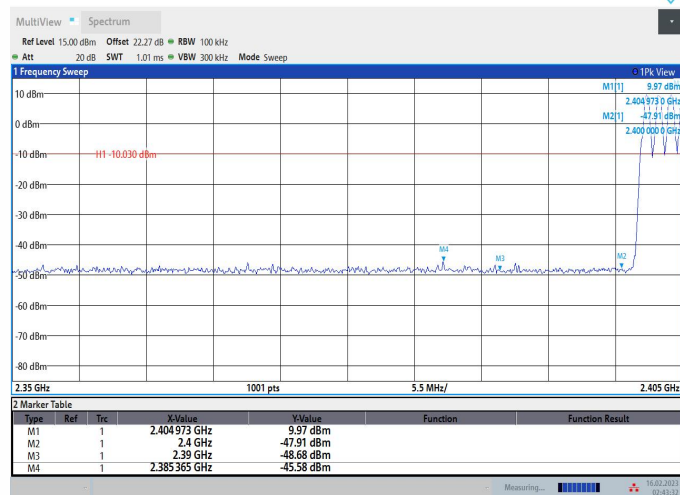

02:43:32 16.02.2023

## DH5\_Ant1\_High\_Hop\_2480

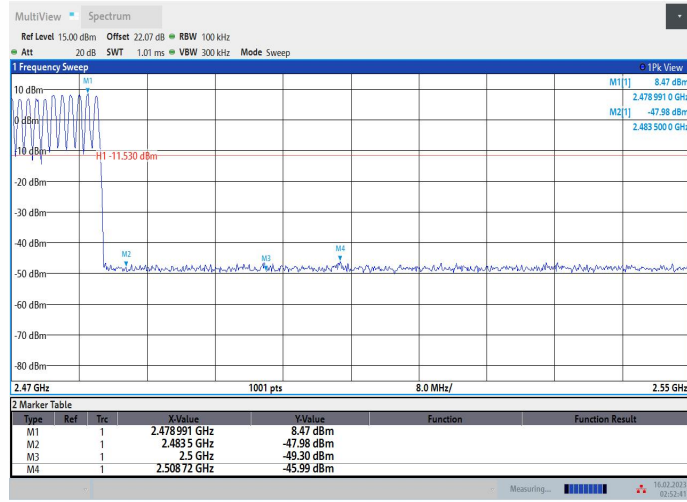

02:52:41 16.02.2023

## 2DH5\_Ant1\_Low\_2402

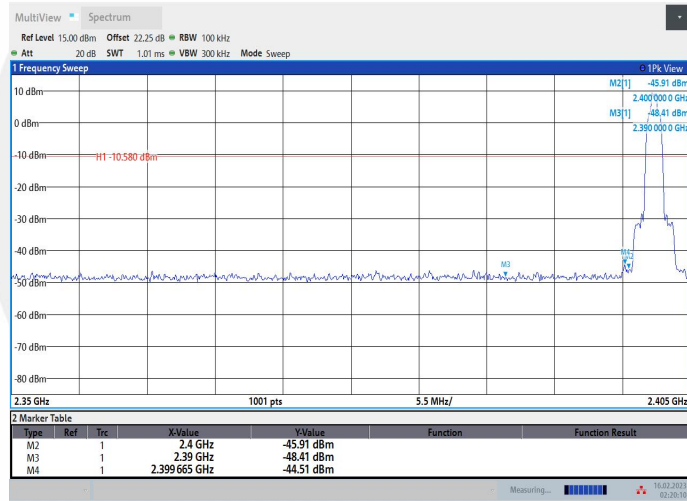

02:20:10 16.02.2023

## 2DH5\_Ant1\_High\_2480

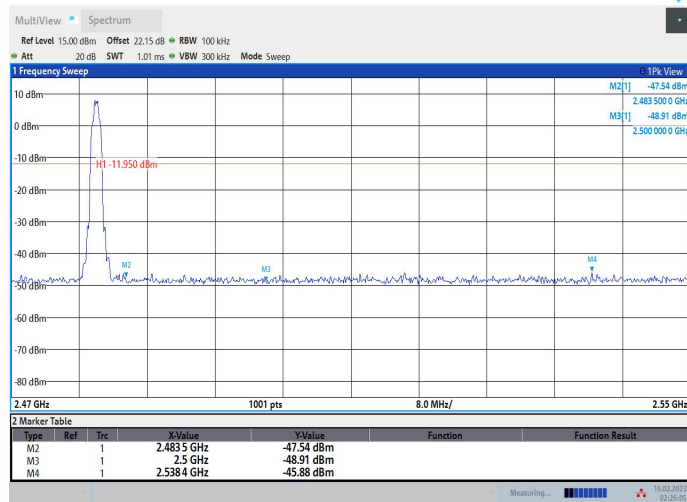

02:26:05 16.02.2023