

# TEST REPORT

**Product Name** : Automotive Diagnostic Tool  
**Model Number** : TKT03  
**FCC ID** : 2AUARTKTOOL08

Prepared for : THINKCAR TECH CO., LTD.  
Address : 2606, building 4, phase II, TiananYungu, Gangtou  
community, Bantian, Longgang District, Shenzhen

Prepared by : EMTEK (SHENZHEN) CO., LTD.  
Address : Building 69, Majialong Industry Zone, Nanshan District,  
Shenzhen, Guangdong, China

Tel: (0755) 26954280  
Fax: (0755) 26954282

Report Number : ENS2302080082W00401R  
Date(s) of Tests : February 09, 2023 to March 3, 2023  
Date of issue : March 7, 2023

## TABLE OF CONTENTS

<b>1 TEST RESULT CERTIFICATION .....</b>	<b>3</b>
<b>2 EUT TECHNICAL DESCRIPTION .....</b>	<b>4</b>
<b>3 SUMMARY OF TEST RESULT .....</b>	<b>5</b>
<b>4 TEST METHODOLOGY .....</b>	<b>6</b>
4.1 GENERAL DESCRIPTION OF APPLIED STANDARDS .....	6
4.2 MEASUREMENT EQUIPMENT USED .....	6
4.3 DESCRIPTION OF TEST MODES .....	7
<b>5 FACILITIES AND ACCREDITATIONS .....</b>	<b>8</b>
5.1 FACILITIES .....	8
5.2 LABORATORY ACCREDITATIONS AND LISTINGS .....	8
<b>6 TEST SYSTEM UNCERTAINTY .....</b>	<b>9</b>
<b>7 SETUP OF EQUIPMENT UNDER TEST .....</b>	<b>10</b>
7.1 RADIO FREQUENCY TEST SETUP 1 .....	10
7.2 RADIO FREQUENCY TEST SETUP 2 .....	10
7.3 CONDUCTED EMISSION TEST SETUP .....	11
7.4 BLOCK DIAGRAM CONFIGURATION OF TEST SYSTEM .....	12
7.5 SUPPORT EQUIPMENT .....	12
<b>8 TEST REQUIREMENTS .....</b>	<b>13</b>
8.1 DTS (6DB) BANDWIDTH .....	13
8.2 MAXIMUM PEAK CONDUCTED OUTPUT POWER .....	18
8.3 MAXIMUM POWER SPECTRAL DENSITY .....	19
8.4 UNWANTED EMISSIONS IN NON-RESTRICTED FREQUENCY BANDS .....	24
8.5 RADIATED SPURIOUS EMISSION .....	41
8.6 CONDUCTED EMISSIONS TEST .....	53
8.7 ANTENNA APPLICATION .....	56

# 1 TEST RESULT CERTIFICATION

Applicant : THINKCAR TECH CO., LTD.  
 Address : 2606, building 4, phase II, TiananYungu, Gangtou community, Bantian, Longgang District, Shenzhen  
 Manufacturer : THINKCAR TECH CO., LTD.  
 Address : 2606, building 4, phase II, TiananYungu, Gangtou community, Bantian, Longgang District, Shenzhen  
 EUT : Automotive Diagnostic Tool  
 Model Name : TKT03  
 Trademark : THINKCAR, XHINKCAR, MUCAR

Measurement Procedure Used:

APPLICABLE STANDARDS	
STANDARD	TEST RESULT
FCC 47 CFR Part 2 , Subpart J FCC 47 CFR Part 15 , Subpart C	PASS

The above equipment was tested by EMTEK (SHENZHEN) CO., LTD. The test data, data evaluation, test procedures, and equipment configurations shown in this report were made in accordance with the procedures given in ANSI C63.10 (2013) and the energy emitted by the sample EUT tested as described in this report is in compliance with the requirements of FCC Rules Part 2 and Part 15.247

The test results of this report relate only to the tested sample identified in this report.

Date of Test : February 09, 2023 to March 3, 2023

Prepared by :   
 Una Yu /Editor

Reviewer :   
 Joe Xia /Supervisor

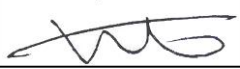
Approve & Authorized Signer :   
 Lisa Wang/Manager



## 2 EUT TECHNICAL DESCRIPTION

Characteristics	Description
<b>Product</b>	Automotive Diagnostic Tool
<b>Model Number</b>	TKT03
<b>Sample Number</b>	2#
<b>IEEE 802.11 WLAN Mode Supported</b>	<input checked="" type="checkbox"/> 802.11b <input checked="" type="checkbox"/> 802.11g <input checked="" type="checkbox"/> 802.11n(20MHz channel bandwidth) <input checked="" type="checkbox"/> 802.11n(40MHz channel bandwidth)
<b>Modulation</b>	DSSS with DBPSK/DQPSK/CCK for 802.11b; OFDM with BPSK/QPSK/16QAM/64QAM for 802.11g/n;
<b>Operating Frequency Range</b>	<input checked="" type="checkbox"/> 2412-2462MHz for 802.11b/g/n(HT20); <input checked="" type="checkbox"/> 2422-2452MHz for 802.11n(HT40);
<b>Number of Channels</b>	<input checked="" type="checkbox"/> 11 channels for 802.11b/g n(HT20); <input checked="" type="checkbox"/> 7 Channels for 802.11n(HT40);
<b>Transmit Power Max</b>	17.50 dBm
<b>Antenna Type</b>	Internal Antenna
<b>Antenna Gain</b>	0.92 dBi
<b>Power supply</b>	DC7.6V from internal battery DC 5V from adapter
<b>Date of Received</b>	February 08, 2023

*Note: for more details, please refer to the User's manual of the EUT.*

### 3 SUMMARY OF TEST RESULT

FCC PartClause	Test Parameter	Verdict	Remark
15.247(a)(2)	DTS (6dB) Bandwidth	PASS	
15.247(b)(3)	Maximum Peak Conducted Output Power	PASS	
15.247(e)	Maximum Power Spectral Density Level	PASS	
15.247(d)	Unwanted Emission Into Non-Restricted Frequency Bands	PASS	
15.247(d) 15.209	Unwanted Emission Into Restricted Frequency Bands (conducted)	PASS	
15.247(d) 15.209	Radiated Spurious Emission	PASS	
15.207	Conducted Emission Test	PASS	
15.247(b)	Antenna Application	PASS	
	NOTE1:N/A (Not Applicable) NOTE2: According to FCC OET KDB 558074, the report use radiated measurements in the restricted frequency bands. In addition, the radiated test is also performed to ensure the emissions emanating from the device cabinet also comply with the applicable limits.		

RELATED SUBMITTAL(S) / GRANT(S):

This submittal(s) (test report) is intended for FCC ID: 2AUARTKTOOL08 filing to comply with Section 15.247 of the FCC Part 15, Subpart C Rules.

## 4 TEST METHODOLOGY

### 4.1 GENERAL DESCRIPTION OF APPLIED STANDARDS

According to its specifications, the EUT must comply with the requirements of the following standards:

FCC 47 CFR Part 2, Subpart J

FCC 47 CFR Part 15, Subpart C

FCC KDB 558074 D01 15.247 Meas Guidance v05r02

### 4.2 MEASUREMENT EQUIPMENT USED

#### 4.2.1 Conducted Emission Test Equipment

EQUIPMENT TYPE	MFR	MODEL NUMBER	SERIAL NUMBER	LASTCAL.	Cal. Interval
EMI Test Receiver	Rohde & Schwarz	ESCI	101384	2022/5/14	1Year
AMN	Rohde & Schwarz	ESH3-Z5	100191	2022/5/15	1Year
AMN	Schwarzbeck	NNLK 8129	8129203	2022/5/15	1Year
Pulse Limiter	Rohde & Schwarz	ESH3-Z2	100107	2022/5/14	1Year
Capacitive Voltage Probe	TESEQ	CVP 2200 A	47173	2022/5/15	1Year

#### 4.2.2 Radiated Emission Test Equipment

EQUIPMENT TYPE	MFR	MODEL NUMBER	SERIAL NUMBER	LAST CAL.	Cal. Interval
EMI Test Receiver	Rohde & Schwarz	ESCI	101414	2022/5/14	1Year
Pre-Amplifier	HP	8447F	2944A07999	2022/5/14	1Year
Bilog Antenna	Schwarzbeck	VULB9163	712	2021/7/5	2Year
Loop Antenna	Schwarzbeck	FMZB1519	1519-012	2021/6/12	2Year
Horn Antenna	Schwarzbeck	BBHA 9170	9170-399	2021/6/12	2Year
Horn Antenna	Schwarzbeck	BBHA9120D	9120D-1198	2021/6/15	2Year
Cable	Schwarzbeck	AK9513	ACRX1	2022/5/14	1Year
Cable	Rosenberger	N/A	FP2RX2	2022/5/14	1Year
Cable	Schwarzbeck	AK9513	CRPX1	2022/5/14	1Year
Cable	Schwarzbeck	AK9513	CRRX2	2022/5/14	1Year

#### 4.2.3 Radio Frequency Test Equipment

EQUIPMENT TYPE	MFR	MODEL NUMBER	SERIAL NUMBER	LASTCAL.	Cal. Interval
Wideband Radio Communication Tester	R&S	CMW500	171168	2022/5/3	1Year
Frequency Extender	R&S	CMW-Z800A	100430	2022/5/16	1Year
Spectrum Analyzer	R&S	FSV3044	MY60242456	2022/4/11	1Year
Analog Signal Generator	R&S	SMB100A	MY61252625	2022/4/22	1Year
Vector Signal Generator	R&S	SMM100A	MY61252674	2022/5/9	1Year
RF Control Unit	Tonscend	JS0806-2	22C8060567	2022/7/20	N/A
Temperature&Humidity Chamber	ESPEC	EL-02KA	12107166	2022/7/2	1 Year

**Remark:** Each piece of equipment is scheduled for calibration once a year.

### 4.3 DESCRIPTION OF TEST MODES

The EUT has been tested under its typical operating condition.

The EUT configuration for testing is installed on RF field strength measurement to meet the Commissions requirement and operating in a manner which intends to maximize its emission characteristics in a continuous normal application.

The Transmitter was operated in the normal operating mode. The TX frequency was fixed which was for the purpose of the measurements.

Test of channel included the lowest and middle and highest frequency to perform the test, then record on this report.

Those data rates ( 802.11b:1 Mbps;  802.11g: 6 Mbps;  802.11n(HT20): MCS0;  802.11n(HT40): MCS0) were used for all test.

Pre-defined engineering program for regulatory testing used to control the EUT for staying in continuous transmitting and receiving mode is programmed.

Frequency and Channel list for 802.11b/g/n (HT20):

Channel	Frequency (MHz)	Channel	Frequency (MHz)	Channel	Frequency (MHz)
1	2412	6	2437	11	2462
2	2417	7	2442		
3	2422	8	2447		
4	2427	9	2452		
5	2432	10	2457		

Frequency and Channel list for 802.11n (HT40):

Channel	Frequency (MHz)	Channel	Frequency (MHz)	Channel	Frequency (MHz)
		6	2437		
		7	2442		
3	2422	8	2447		
4	2427	9	2452		
5	2432				

Test Frequency and Channel for 802.11b/g/n (HT20):

Lowest Frequency		Middle Frequency		Highest Frequency	
Channel	Frequency (MHz)	Channel	Frequency (MHz)	Channel	Frequency (MHz)
1	2412	6	2437	11	2462

Test Frequency and channel for 802.11n (HT40):

Lowest Frequency		Middle Frequency		Highest Frequency	
Channel	Frequency (MHz)	Channel	Frequency (MHz)	Channel	Frequency (MHz)
3	2422	6	2437	9	2452

## 5 FACILITIES AND ACCREDITATIONS

### 5.1 FACILITIES

All measurement facilities used to collect the measurement data are located at

Building 69, Majialong Industry Zone District, Nanshan District, Shenzhen, China

The sites are constructed in conformance with the requirements of ANSI C63.7, ANSI C63.10 and CISPR Publication 22.

### 5.2 LABORATORY ACCREDITATIONS AND LISTINGS

Site Description

EMC Lab.

: **Accredited by CNAS**

The Certificate Registration Number is L2291.

The Laboratory has been assessed and proved to be in compliance with CNAS-CL01 (identical to ISO/IEC 17025:2017)

**Accredited by FCC**

Designation Number: CN1204

Test Firm Registration Number: 882943

**Accredited by A2LA**

The Certificate Number is 4321.01.

**Accredited by Industry Canada**

The Conformity Assessment Body Identifier is CN0008

Name of Firm

: EMTEK (SHENZHEN) CO., LTD.

Site Location

: Building 69, Majialong Industry Zone, Nanshan District, Shenzhen, Guangdong, China



## 6 TEST SYSTEM UNCERTAINTY

The following measurement uncertainty levels have been estimated for tests performed on the apparatus:

Parameter	Uncertainty
Radio Frequency	$\pm 1 \times 10^{-5}$
Maximum Peak Output Power Test	$\pm 1.0\text{dB}$
Conducted Emissions Test	$\pm 2.0\text{dB}$
Radiated Emission Test	$\pm 2.0\text{dB}$
Power Density	$\pm 2.0\text{dB}$
Occupied Bandwidth Test	$\pm 1.0\text{dB}$
Band Edge Test	$\pm 3\text{dB}$
All emission, radiated	$\pm 3\text{dB}$
Antenna Port Emission	$\pm 3\text{dB}$
Temperature	$\pm 0.5^\circ\text{C}$
Humidity	$\pm 3\%$

Measurement Uncertainty for a level of Confidence of 95%

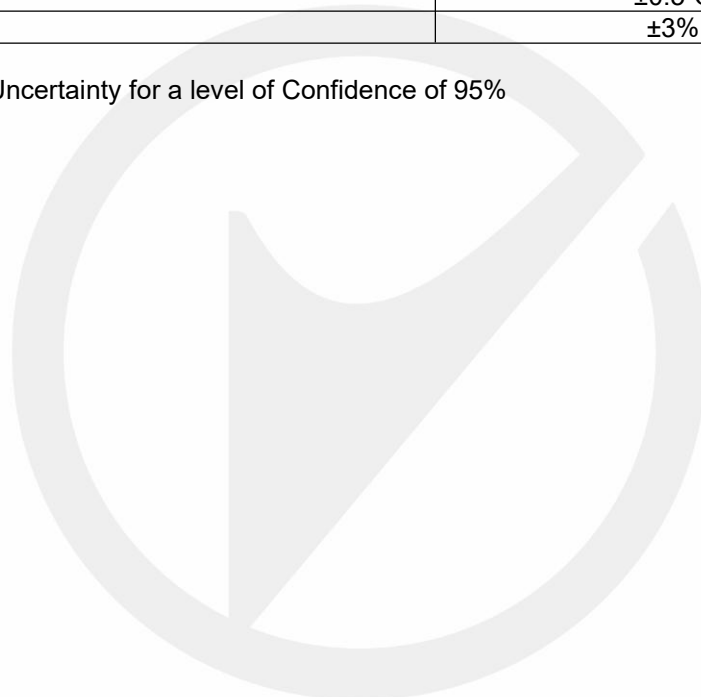

## 7 SETUP OF EQUIPMENT UNDER TEST

### 7.1 RADIO FREQUENCY TEST SETUP 1

The WLAN component's antenna ports(s) of the EUT are connected to the measurement instrument per an appropriate attenuator. The EUT is controlled by PC/software to emit the specified signals for the purpose of measurements.

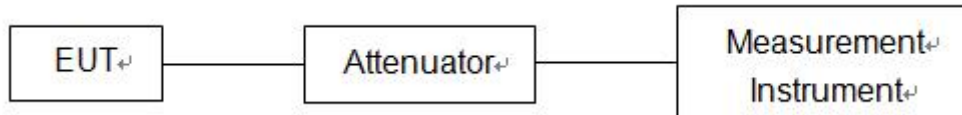

### 7.2 RADIO FREQUENCY TEST SETUP 2

The test site semi-anechoic chamber has met the requirement of NSA tolerance 4 dB according to the standards: ANSI C63.10. The test distance is 3m. The setup is according to the requirements in Section 13.1.4.1 of ANSI C63.10-2013 and CAN/CSA-CEI/IEC CISPR 22.

Below 30MHz:

The EUT is placed on a turntable 0.8 meters above the ground in the chamber, 3 meter away from the antenna (loop antenna). The Antenna should be positioned with its plane vertical at the specified distance from the EUT and rotated about its vertical axis for maximum response at each azimuth about the EUT. The center of the loop shall be 1 m above the ground. For certain applications, the loop antenna plane may also need to be positioned horizontally at the specified distance from the EUT.

30MHz-1GHz:

The EUT is placed on a turntable 0.8 meters above the ground in the chamber, 3 meter away from the antenna. The maximal emission value is acquired by adjusting the antenna height, polarisation and turntable azimuth. Normally, the height range of antenna is 1 m to 4 m, the azimuth range of turntable is 0° to 360°, and the receive antenna has two polarizations Vertical (V) and Horizontal (H).

Above 1GHz:

The EUT is placed on a turntable 1.5 meters above the ground in the chamber, 3 meter away from the antenna. The maximal emission value is acquired by adjusting the antenna height, polarisation and turntable azimuth. Normally, the height range of antenna is 1 m to 4 m, the azimuth range of turntable is 0° to 360°, and the receive antenna has two polarizations Vertical (V) and Horizontal (H).

(a) Radiated Emission Test Set-Up, Frequency Below 30MHz

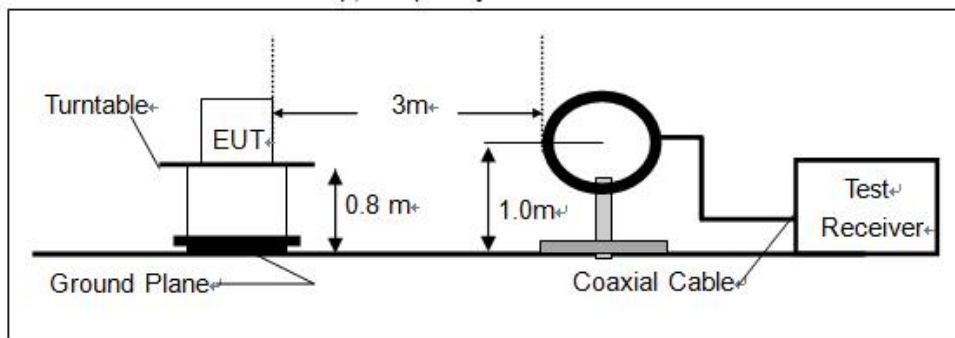

(b) Radiated Emission Test Set-Up, Frequency Below 1000MHz

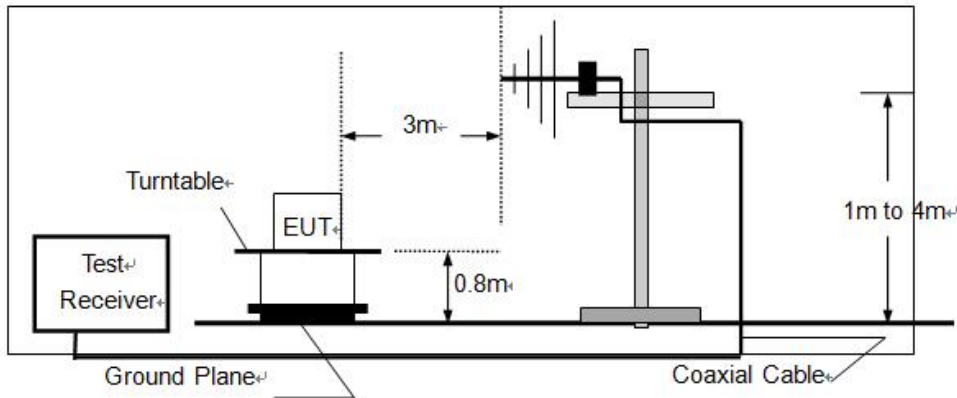

(c) Radiated Emission Test Set-Up, Frequency above 1000MHz

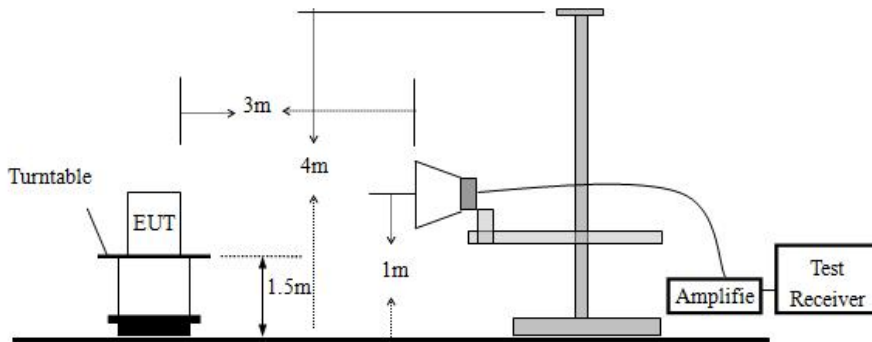

**7.3 CONDUCTED EMISSION TEST SETUP**

The mains cable of the EUT (maybe per AC/DC Adapter) must be connected to LISN. The LISN shall be placed 0.8 m from the boundary of EUT and bonded to a ground reference plane for LISN mounted on top of the ground reference plane. This distance is between the closest points of the LISN and the EUT. All other units of the EUT and associated equipment shall be at least 0.8m from the LISN.

Ground connections, where required for safety purposes, shall be connected to the reference ground point of the LISN and, where not otherwise provided or specified by the manufacturer, shall be of same length as the mains cable and run parallel to the mains connection at a separation distance of not more than 0.1 m.

According to the requirements in Section 13.1.4.1 of ANSI C63.10-2013 Conducted emissions from the EUT measured in the frequency range between 0.15 MHz and 30 MHz using CISPR Quasi-Peak and average detector mode.

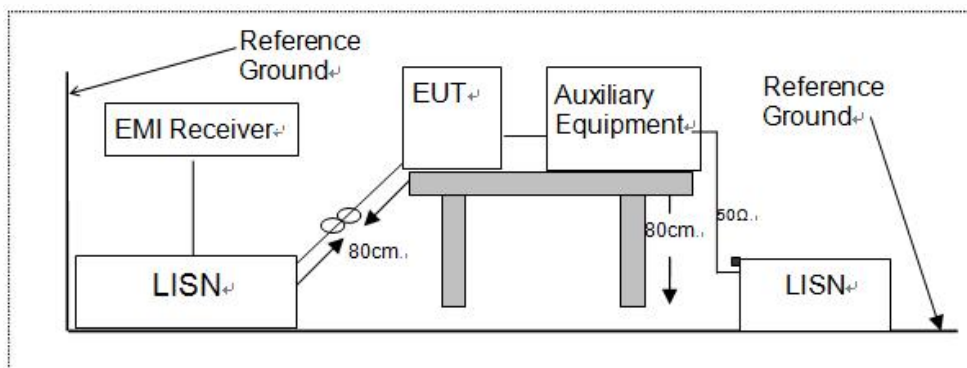

#### 7.4 BLOCK DIAGRAM CONFIGURATION OF TEST SYSTEM

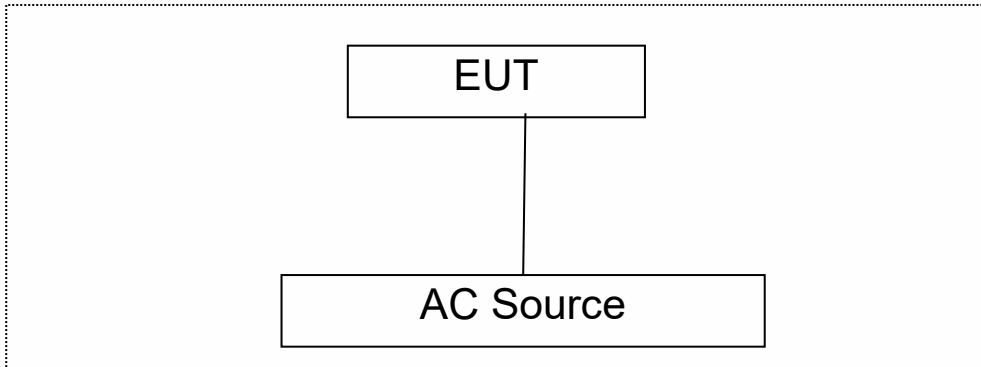

#### 7.5 SUPPORT EQUIPMENT

EUT Cable List and Details			
Cable Description	Length (m)	Shielded/Unshielded	With / Without Ferrite
/	/	/	/

Auxiliary Cable List and Details			
Cable Description	Length (m)	Shielded/Unshielded	With / Without Ferrite
/	/	/	/

Auxiliary Equipment List and Details			
Description	Manufacturer	Model	Serial Number
Notebook	acer	ZR1	LXTECOCO76643158 372500

**Notes:**

1. All the equipment/cables were placed in the worst-case configuration to maximize the emission during the test.
2. Grounding was established in accordance with the manufacturer’s requirements and conditions for the intended use.
3. Unless otherwise denoted as EUT in [Remark] column , device(s) used in tested system is a support equipment

## 8 TEST REQUIREMENTS

### 8.1 DTS (6DB) BANDWIDTH

#### 8.1.1 Applicable Standard

According to FCC Part15.247 (a)(2) and KDB 558074 D01 15.247 Meas Guidance v05r02

#### 8.1.2 Conformance Limit

The minimum -6 dB bandwidth shall be at least 500 kHz.

#### 8.1.3 Test Configuration

Test according to clause 7.1 radio frequency test setup 1

#### 8.1.4 Test Procedure

The EUT was operating in IEEE 802.11b/g/n mode and controlled its channel. Printed out the test result from the spectrum by hard copy function.

The RF output of EUT was connected to the spectrum analyzer by RF cable and attenuator. The path loss was compensated to the results for each measurement.

Set to the maximum power setting and enable the EUT transmit continuously

Set RBW = 100 kHz.

Set the video bandwidth (VBW) =300kHz.

Set Span=2 times OBW

Set Detector = Peak.

Set Trace mode = max hold.

Set Sweep = auto couple.

Allow the trace to stabilize.

Measure the maximum width of the emission that is constrained by the frequencies associated with the two outermost amplitude points (upper and lower frequencies) that are attenuated by 6 dB relative to the maximum level measured in the fundamental emission.

Measure and record the results in the test report.

#### 8.1.5 Test Results

Temperature:	25° C
Relative Humidity:	45%
ATM Pressure:	1011 mbar

TestMode	Antenna	Frequency[MHz]	DTS BW [MHz]	FL[MHz]	FH[MHz]	Limit[MHz]	Verdict
11B	Ant1	2412	7.56	2408.44	2416.00	0.5	PASS
		2437	8.08	2432.96	2441.04	0.5	PASS
		2462	8.04	2457.96	2466.00	0.5	PASS
11G	Ant1	2412	15.32	2404.44	2419.76	0.5	PASS
		2437	15.12	2429.44	2444.56	0.5	PASS
		2462	15.16	2454.40	2469.56	0.5	PASS
11N20SISO	Ant1	2412	15.72	2404.40	2420.12	0.5	PASS
		2437	15.16	2429.40	2444.56	0.5	PASS
		2462	16.04	2454.44	2470.48	0.5	PASS
11N40SISO	Ant1	2422	35.12	2404.48	2439.60	0.5	PASS
		2437	35.12	2419.48	2454.60	0.5	PASS
		2452	35.12	2434.48	2469.60	0.5	PASS

## 11B\_Ant1\_2412

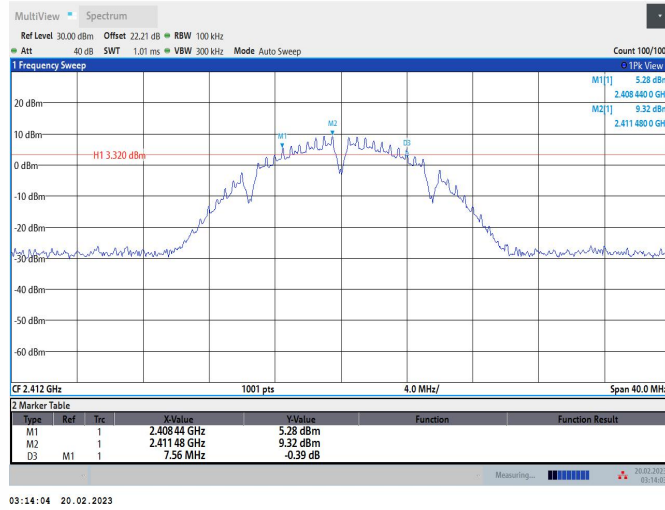

## 11B\_Ant1\_2437

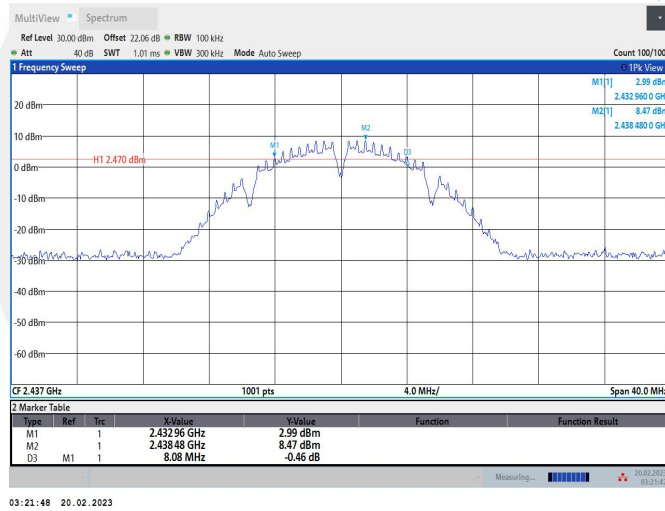

## 11B\_Ant1\_2462

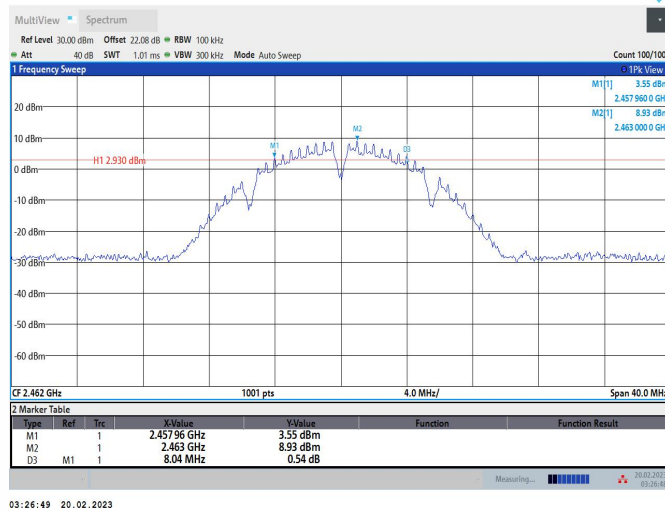

## 11G\_Ant1\_2412

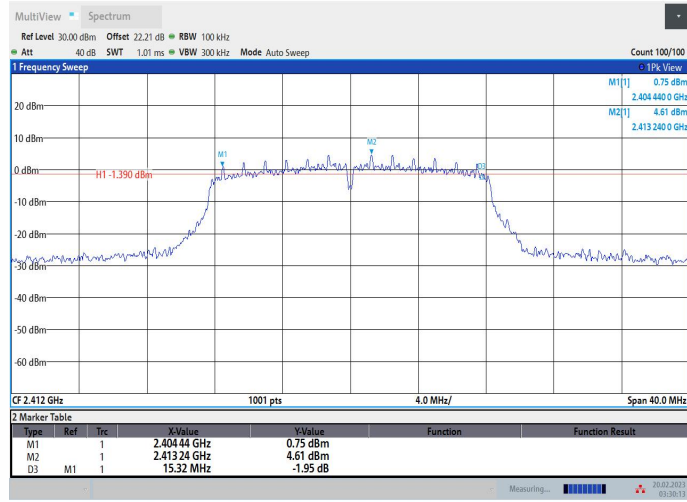

03:30:14 20.02.2023

## 11G\_Ant1\_2437

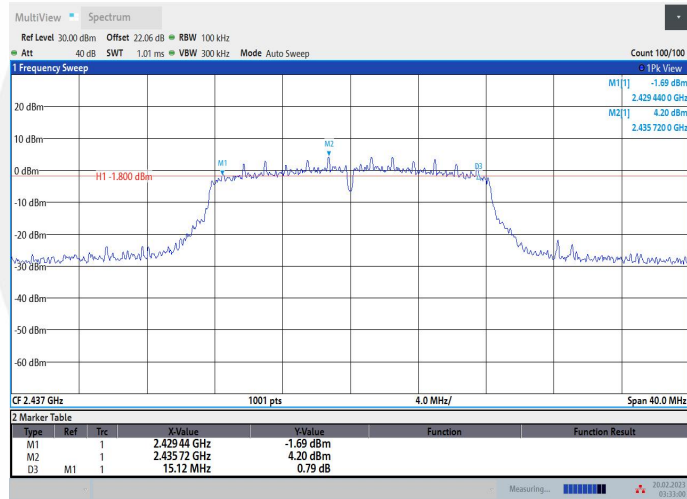

03:33:01 20.02.2023

## 11G\_Ant1\_2462

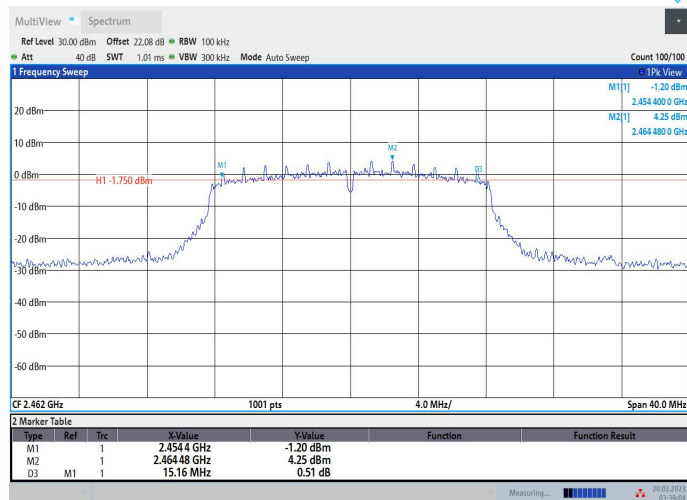

03:39:05 20.02.2023



## 11N20SISO\_Ant1\_2412

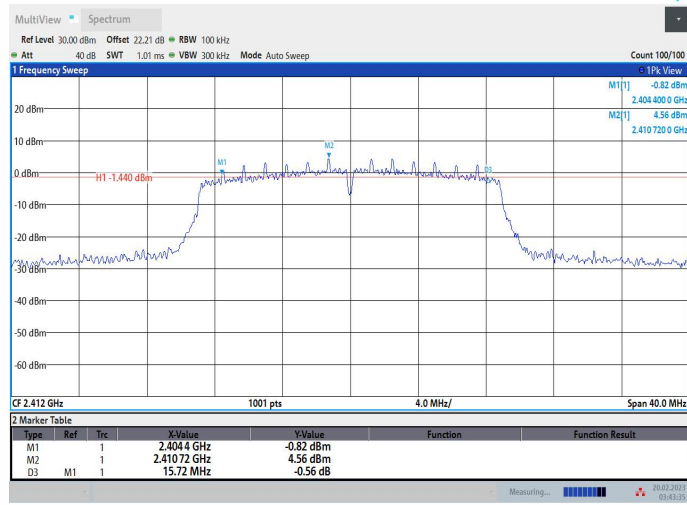

## 11N20SISO\_Ant1\_2437

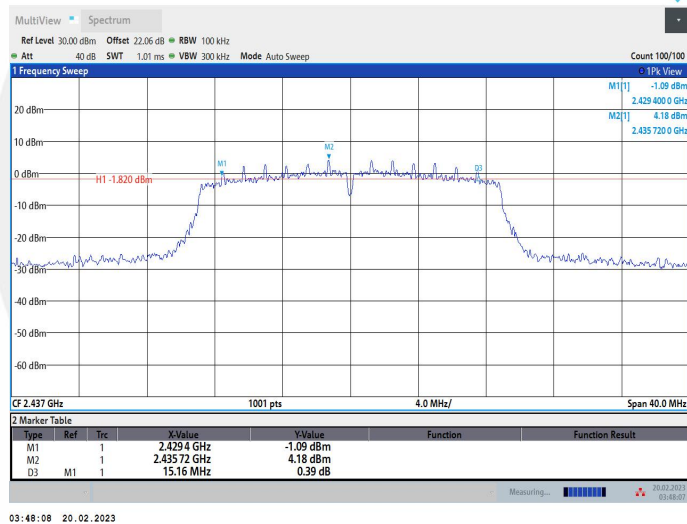

## 11N20SISO\_Ant1\_2462

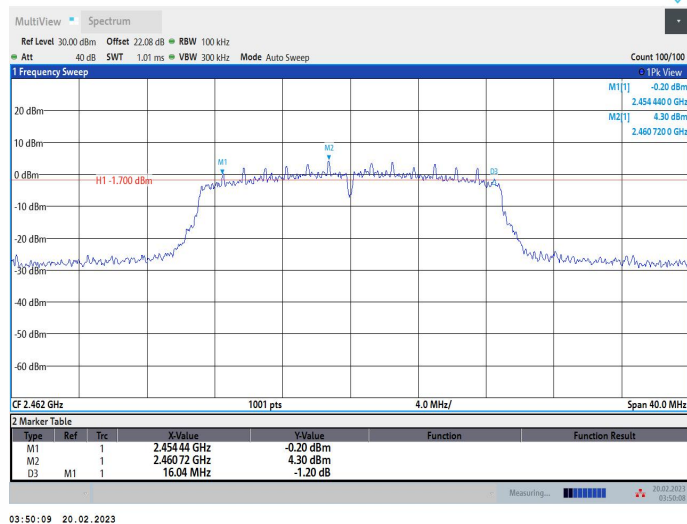



## 11N40SISO\_Ant1\_2422

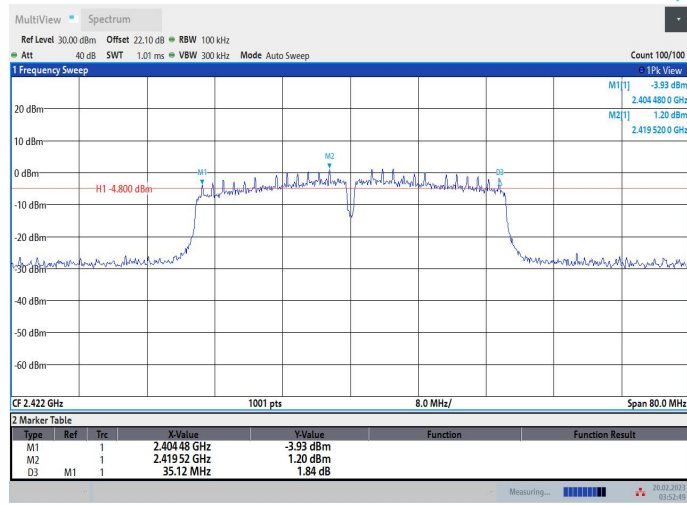

03:52:50 20.02.2023

## 11N40SISO\_Ant1\_2437

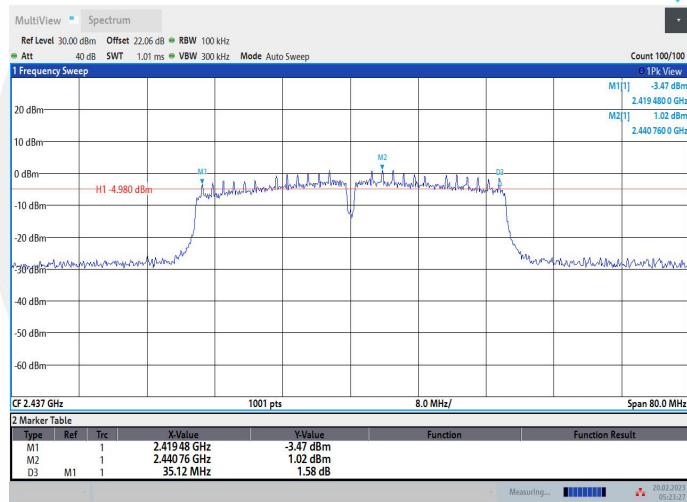

05:23:28 20.02.2023

## 11N40SISO\_Ant1\_2452

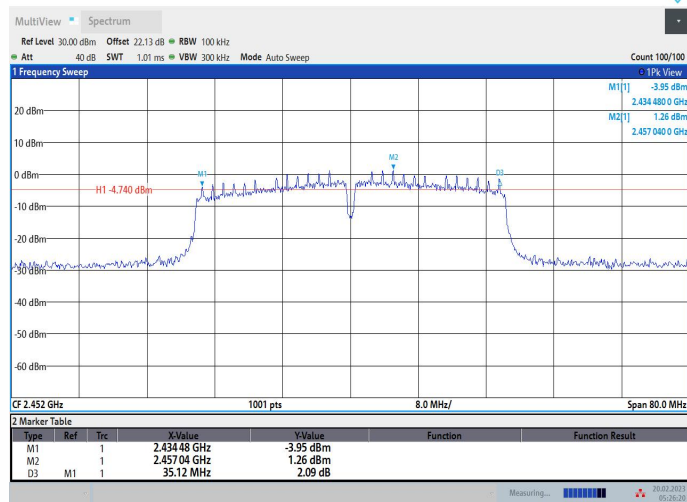

05:26:20 20.02.2023

## 8.2 MAXIMUM PEAK CONDUCTED OUTPUT POWER

### 8.2.1 Applicable Standard

According to FCC Part15.247 (b)(3) and KDB 558074 D01 15.247 Meas Guidance v05r02

### 8.2.2 Conformance Limit

The maximum peak conducted output power of the intentional radiator for systems using digital modulation in the 2400 - 2483.5 MHz bands shall not exceed: 1 Watt (30dBm).

### 8.2.3 Test Configuration

Test according to clause 7.1 radio frequency test setup 1

### 8.2.4 Test Procedure

■ According to FCC Part15.247(b)(3)

The maximum peak conducted output power may be measured using a broadband peak RF power meter. The power meter shall have a video bandwidth that is greater than or equal to the DTS bandwidth and shall utilize a fast-responding diode detector.

The testing follows FCC public Notice DA 00-705 Measurement Guidelines.

The RF output of EUT was connected to the power meter by RF cable and attenuator. The path loss was compensated to the results for each measurement.

Set to the maximum output power setting and enable the EUT transmit continuously.

Measure the conducted output power with cable loss and record the results in the test report.

Measure and record the results in the report.

■ According to FCC Part 15.247(b)(4):

Conducted output power limit specified in paragraph (b) of this section is based on the use of antennas with directional gains that do not exceed 6 dBi. If transmitting antennas of directional gain greater than 6 dBi are used, the conducted output power from the intentional radiator shall be reduced below the stated values in paragraphs (b)(3) of this section, as appropriate, by the amount in dB that the directional gain of the antenna exceeds 6 dBi.

Note: If antenna Gain exceeds 6 dBi, then Output power Limit=30-(Gain- 6)

### 8.2.5 Test Results

Temperature:	25° C
Relative Humidity:	45%
ATM Pressure:	1011 mbar

TestMode	Antenna	Frequen cy[MHz]	Peak Power[dBm]	Conducted Limit[dBm]	EIRP [dBm]	EIRP Limit[dBm]	Verdict
11B	Ant1	2412	17.50	≤30.00	18.42	≤36.00	PASS
		2437	17.00	≤30.00	17.92	≤36.00	PASS
		2462	17.05	≤30.00	17.97	≤36.00	PASS
11G	Ant1	2412	15.25	≤30.00	16.17	≤36.00	PASS
		2437	14.78	≤30.00	15.70	≤36.00	PASS
		2462	14.80	≤30.00	15.72	≤36.00	PASS
11N20SIS O	Ant1	2412	15.13	≤30.00	16.05	≤36.00	PASS
		2437	14.70	≤30.00	15.62	≤36.00	PASS
		2462	14.68	≤30.00	15.60	≤36.00	PASS
11N40SIS O	Ant1	2422	14.31	≤30.00	15.23	≤36.00	PASS
		2437	14.29	≤30.00	15.21	≤36.00	PASS
		2452	14.37	≤30.00	15.29	≤36.00	PASS

### 8.3 MAXIMUM POWER SPECTRAL DENSITY

#### 8.3.1 Applicable Standard

According to FCC Part15.247(e) and KDB 558074 D01 15.247 Meas Guidance v05r02

#### 8.3.2 Conformance Limit

The transmitter power spectral density conducted from the transmitter to the antenna shall not be greater than 8 dBm in any 3 kHz band during any time interval of continuous transmission.

#### 8.3.3 Test Configuration

Test according to clause 7.1 radio frequency test setup 1

#### 8.3.4 Test Procedure

This procedure shall be used if maximum peak conducted output power was used to demonstrate compliance

The transmitter output (antenna port) was connected to the spectrum analyzer

Set analyzer center frequency to DTS channel center frequency.

Set the span to 1.5 times the DTS bandwidth.

Set the RBW to: 3 kHz

Set the VBW to:10 kHz.

Set Detector = peak.

Set Sweep time = auto couple.

Set Trace mode = max hold.

Allow trace to fully stabilize.

Use the peak marker function to determine the maximum amplitude level within the RBW.

Note: If antenna Gain exceeds 6 dBi, then PSD Limit=8-(Gain- 6)

#### 8.3.5 Test Results

Temperature:	25° C
Relative Humidity:	45%
ATM Pressure:	1011 mbar

TestMode	Antenna	Frequency[MHz]	Result[dBm/3-100kHz]	Limit[dBm/3kHz]	Verdict
11B	Ant1	2412	-13.17	≤8.00	PASS
		2437	-13.56	≤8.00	PASS
		2462	-13.6	≤8.00	PASS
11G	Ant1	2412	-17.24	≤8.00	PASS
		2437	-17.5	≤8.00	PASS
		2462	-17.72	≤8.00	PASS
11N20SISO	Ant1	2412	-17.34	≤8.00	PASS
		2437	-17.49	≤8.00	PASS
		2462	-17.9	≤8.00	PASS
11N40SISO	Ant1	2422	-19.15	≤8.00	PASS
		2437	-19.79	≤8.00	PASS
		2452	-19.18	≤8.00	PASS

## 11B\_Ant1\_2412

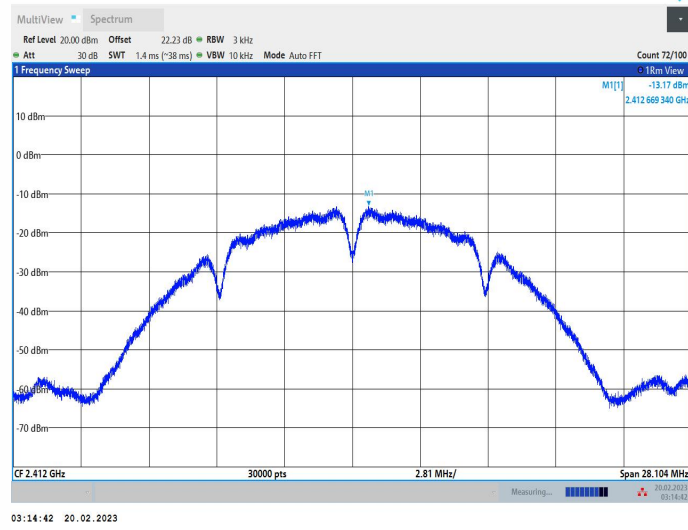

## 11B\_Ant1\_2437

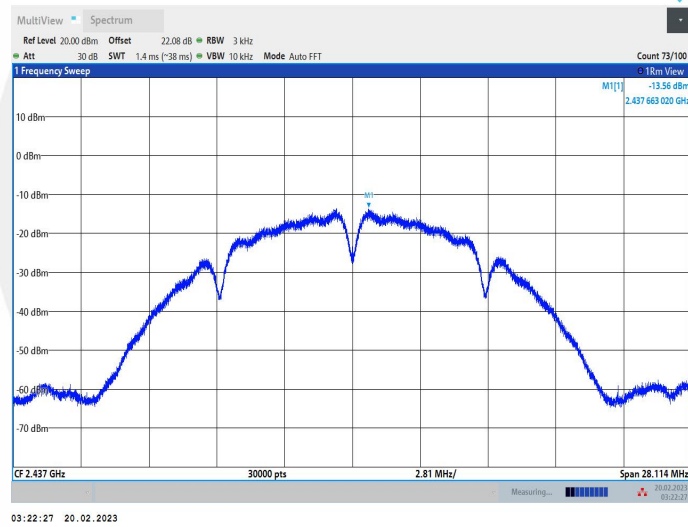

## 11B\_Ant1\_2462

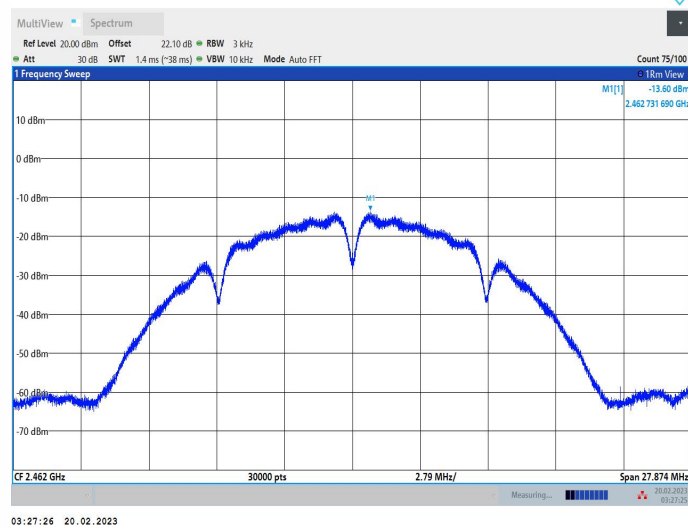

## 11G\_Ant1\_2412

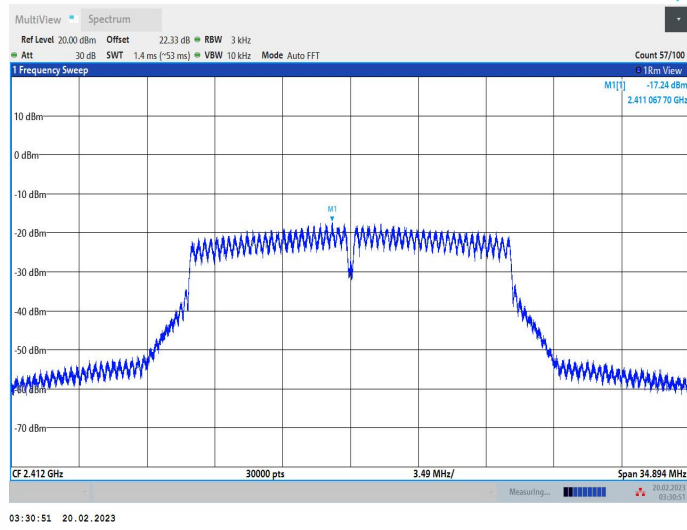

## 11G\_Ant1\_2437

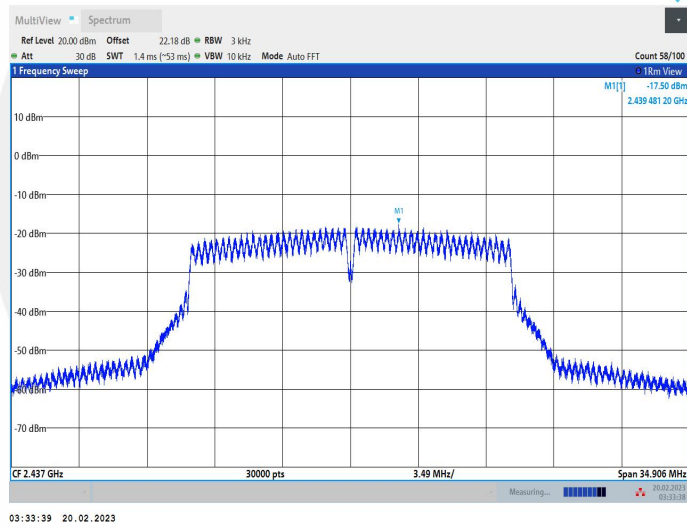

## 11G\_Ant1\_2462

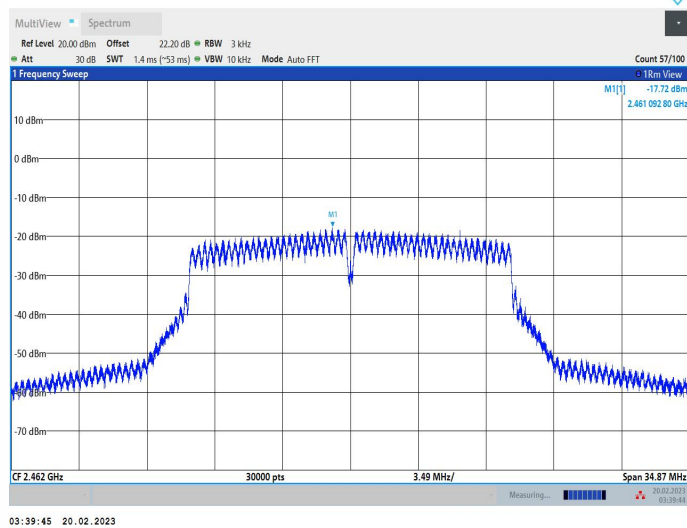

## 11N20SISO\_Ant1\_2412

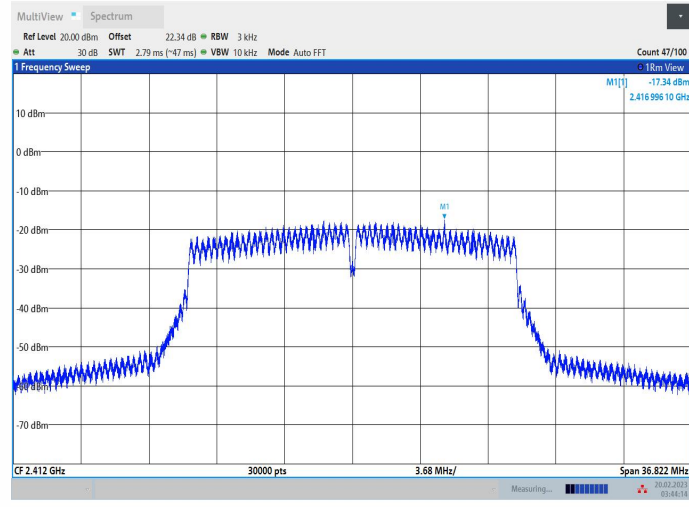

## 11N20SISO\_Ant1\_2437

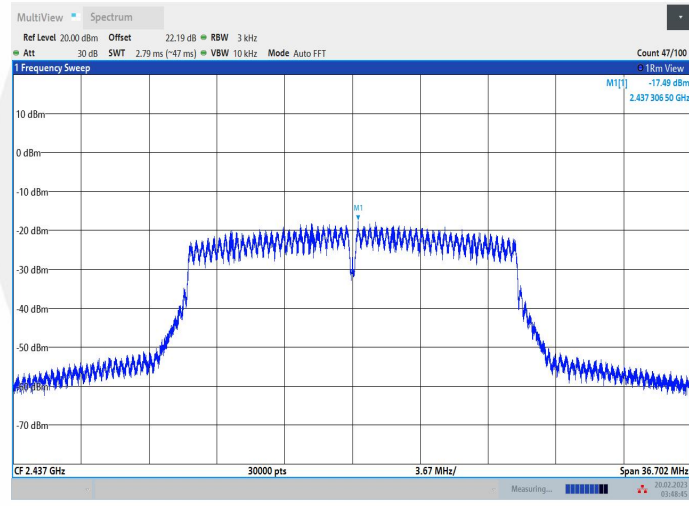

## 11N20SISO\_Ant1\_2462

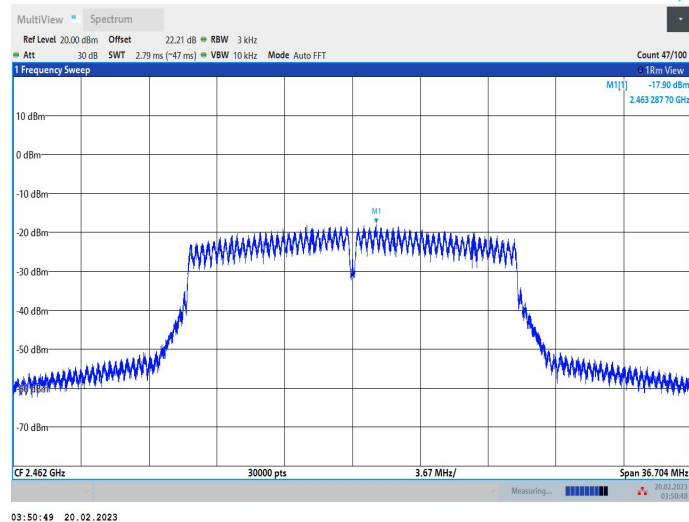

## 11N40SISO\_Ant1\_2422

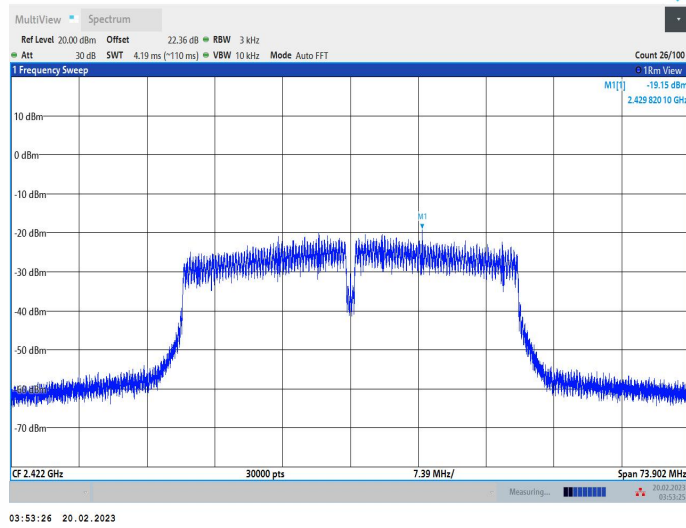

## 11N40SISO\_Ant1\_2437

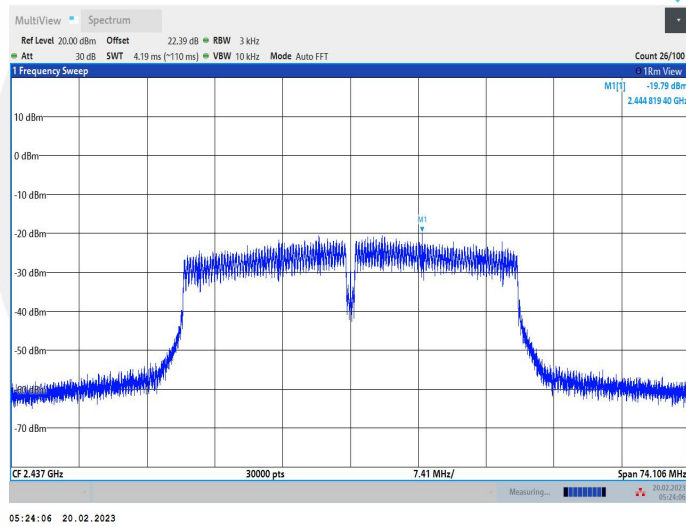

## 11N40SISO\_Ant1\_2452

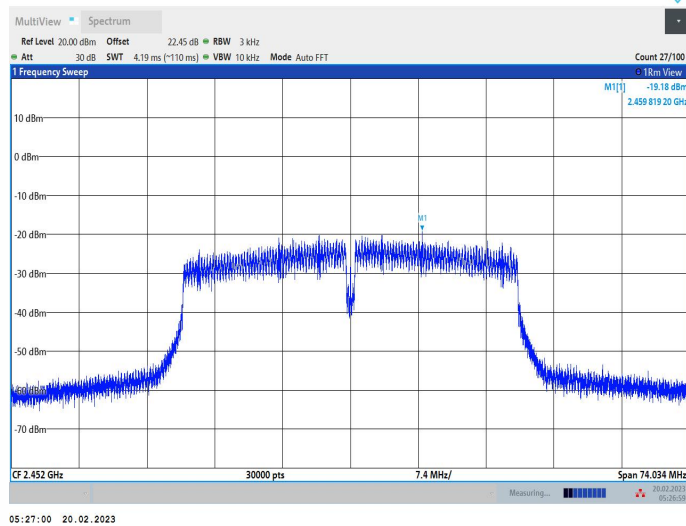



## 8.4 UNWANTED EMISSIONS IN NON-RESTRICTED FREQUENCY BANDS

### 8.4.1 Applicable Standard

According to FCC Part 15.247(d) and KDB 558074 D01 15.247 Meas Guidance v05r02

### 8.4.2 Conformance Limit

According to FCC Part 15.247(d):

In any 100 kHz bandwidth outside the frequency band in which the spread spectrum or digitally modulated intentional radiator is operating, the radio frequency power that is produced by the intentional radiator shall be at least 20 dB below that in the 100 kHz bandwidth within the band that contains the highest level of the desired power, based on either an RF conducted or a radiated measurement, provided the transmitter demonstrates compliance with the peak conducted power limits. If the transmitter complies with the conducted power limits based on the use of RMS averaging over a time interval, as permitted under paragraph (b)(3) of this section, the attenuation required under this paragraph shall be 30 dB instead of 20 dB.

### 8.4.3 Test Configuration

Test according to clause 7.1 radio frequency test setup 1

### 8.4.4 Test Procedure

The transmitter output (antenna port) was connected to the spectrum analyzer

#### ■ Reference level measurement

Establish a reference level by using the following procedure:

Set instrument center frequency to DTS channel center frequency.

Set the span to  $\geq 1.5$  times the DTS bandwidth.

Set the RBW = 100 kHz.

Set the VBW  $\geq 3 \times$  RBW.

Set Detector = peak.

Set Sweep time = auto couple.

Set Trace mode = max hold.

Allow trace to fully stabilize.

Use the peak marker function to determine the maximum PSD level.

Note that the channel found to contain the maximum PSD level can be used to establish the reference level.

#### ■ Emission level measurement

Set the center frequency and span to encompass frequency range to be measured.

Set the RBW = 100 kHz.

Set the VBW = 300 kHz.

Set Detector = peak

Sweep time = auto couple.

Trace mode = max hold.

Allow trace to fully stabilize.

Use the peak marker function to determine the maximum amplitude level.

Ensure that the amplitude of all unwanted emissions outside of the authorized frequency band (excluding restricted frequency bands) are attenuated by at least the minimum requirements. Report the three highest emissions relative to the limit.

### 8.4.5 Test Results



All the antennas and modulation modes were tested, and the worst data is shown in the table below.

### Band edge measurements

TestMode	Antenna	ChName	Frequency [MHz]	RefLevel[dBm]	Result[dBm]	Limit[dBm]	Verdict
11B	Ant1	Low	2412	9.09	-33.27	≤-20.91	PASS
		High	2462	9.12	-36.21	≤-20.88	PASS
11G	Ant1	Low	2412	4.45	-27.22	≤-25.55	PASS
		High	2462	4.19	-35.64	≤-25.81	PASS
11N20SISO	Ant1	Low	2412	4.46	-25.58	≤-15.54	PASS
		High	2462	4.17	-35.25	≤-15.83	PASS
11N40SISO	Ant1	Low	2422	1.21	-30.74	≤-18.79	PASS
		High	2452	1.13	-30.47	≤-18.87	PASS

### Conducted Spurious Emission

TestMode	Antenna	Frequency[MHz]	FreqRange [Mhz]	RefLevel [dBm]	Result [dBm]	Limit [dBm]	Verdict
11B	Ant1	2412	Reference	9.27	9.27	---	PASS
			30~1000	9.27	-42.73	≤-20.73	PASS
			1000~26500	9.27	-38.9	≤-20.73	PASS
		2437	Reference	9.09	9.09	---	PASS
			30~1000	9.09	-43.43	≤-20.91	PASS
			1000~26500	9.09	-38.51	≤-20.91	PASS
		2462	Reference	9.18	9.18	---	PASS
			30~1000	9.18	-42.11	≤-20.82	PASS
			1000~26500	9.18	-39.71	≤-20.82	PASS
11G	Ant1	2412	Reference	4.56	4.56	---	PASS
			30~1000	4.56	-43.06	≤-25.44	PASS
			1000~26500	4.56	-39.95	≤-25.44	PASS
		2437	Reference	4.22	4.22	---	PASS
			30~1000	4.22	-42.57	≤-25.78	PASS
			1000~26500	4.22	-39.05	≤-25.78	PASS
		2462	Reference	4.23	4.23	---	PASS
			30~1000	4.23	-43.2	≤-25.77	PASS
			1000~26500	4.23	-39.88	≤-25.77	PASS
11N20SISO	Ant1	2412	Reference	4.50	4.50	---	PASS
			30~1000	4.50	-42.13	≤-25.5	PASS
			1000~26500	4.50	-39.25	≤-25.5	PASS
		2437	Reference	4.19	4.19	---	PASS
			30~1000	4.19	-43.5	≤-25.81	PASS
			1000~26500	4.19	-39.59	≤-25.81	PASS
		2462	Reference	4.25	4.25	---	PASS
			30~1000	4.25	-42.39	≤-25.75	PASS
			1000~26500	4.25	-40.14	≤-25.75	PASS
11N40SISO	Ant1	2422	Reference	1.19	1.19	---	PASS
			30~1000	1.19	-42.91	≤-28.81	PASS
			1000~26500	1.19	-39.85	≤-28.81	PASS
		2437	Reference	0.99	0.99	---	PASS
			30~1000	0.99	-43.9	≤-29.01	PASS
			1000~26500	0.99	-39.91	≤-29.01	PASS
		2452	Reference	1.23	1.23	---	PASS
			30~1000	1.23	-41.59	≤-28.77	PASS
			1000~26500	1.23	-39.66	≤-28.77	PASS

## Band edge measurements

11B\_Ant1\_Low\_2412

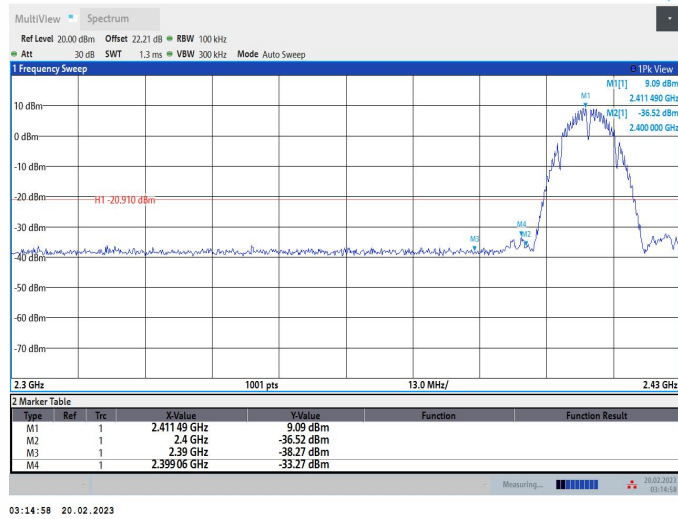

03:14:58 20.02.2023

11B\_Ant1\_High\_2462

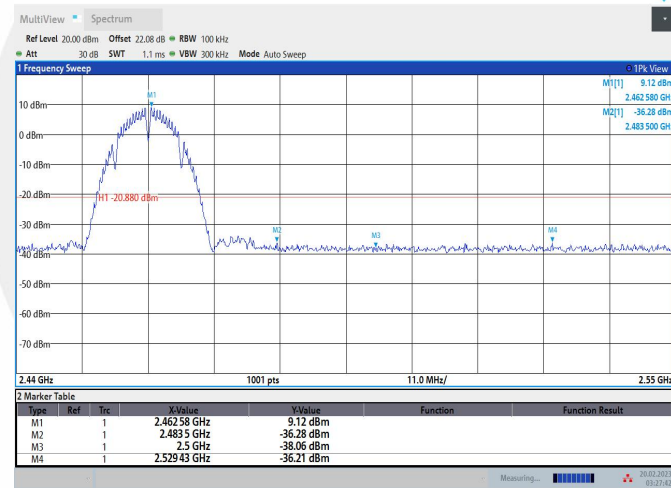

03:27:43 20.02.2023

11G\_Ant1\_Low\_2412

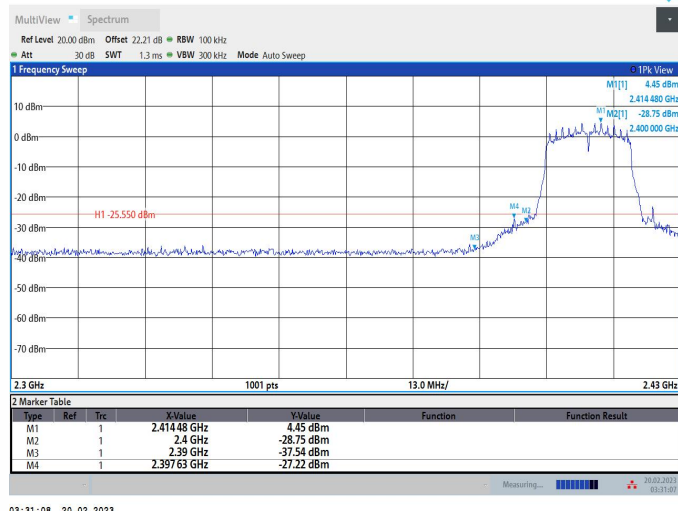

03:31:08 20.02.2023

## 11G\_Ant1\_High\_2462

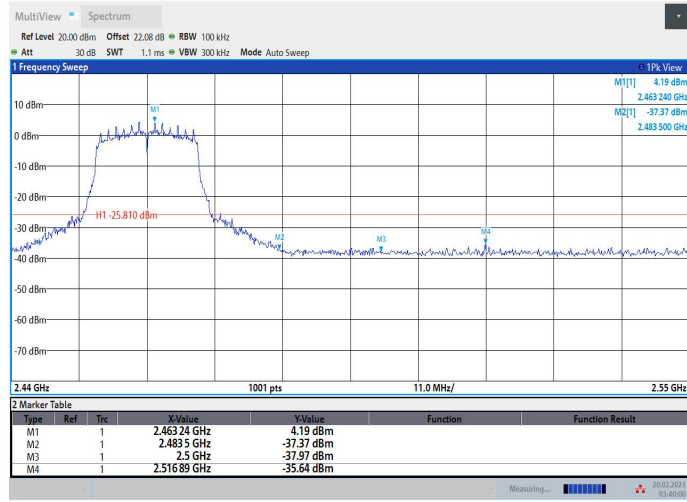

## 11N20SISO\_Ant1\_Low\_2412

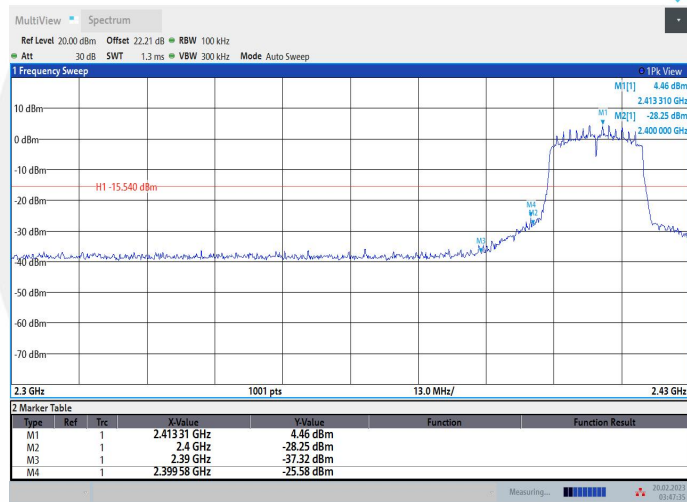

## 11N20SISO\_Ant1\_High\_2462

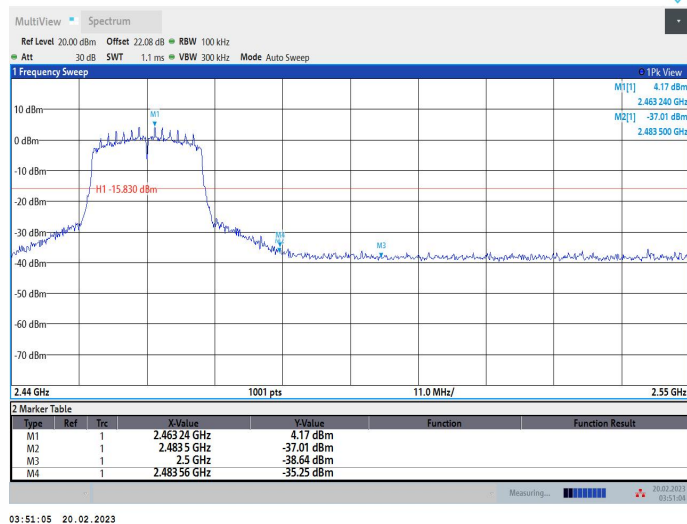

## 11N40SISO\_Ant1\_Low\_2422

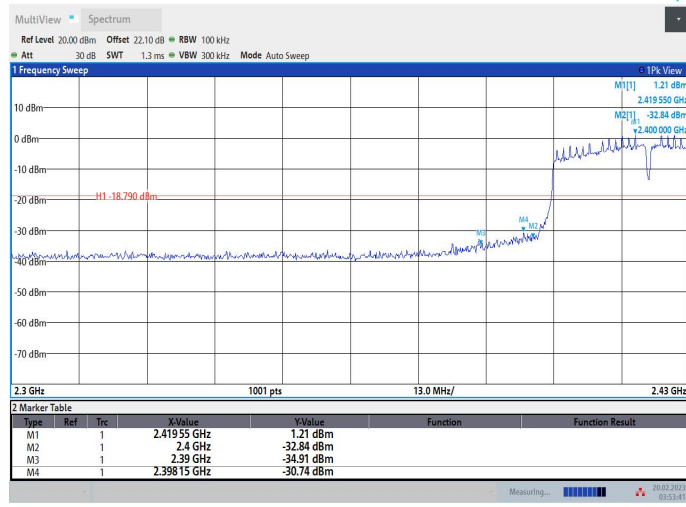

03:53:42 20.02.2023

## 11N40SISO\_Ant1\_High\_2452

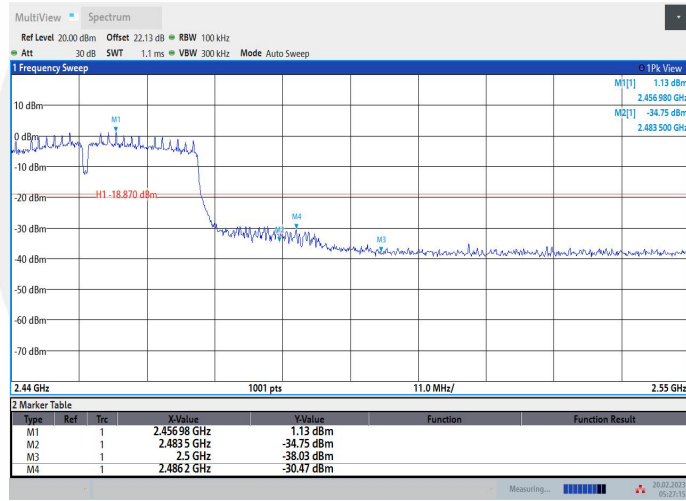

05:27:16 20.02.2023

## Conducted Spurious Emission

11B\_Ant1\_2412\_0~Reference

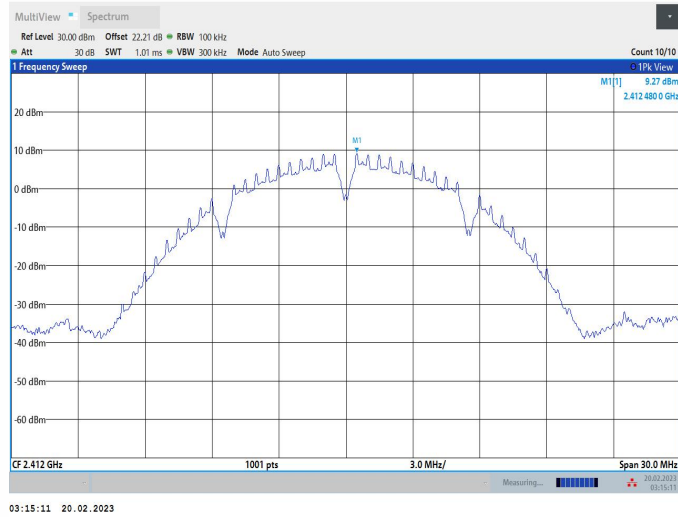

11B\_Ant1\_2412\_30~1000

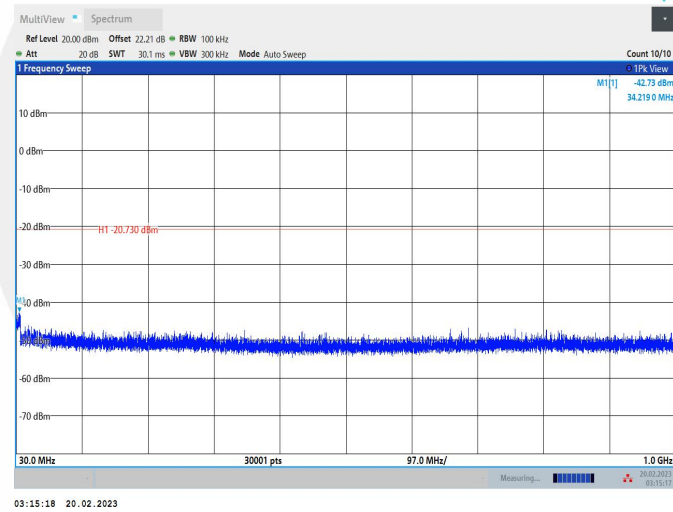

11B\_Ant1\_2412\_1000~26500

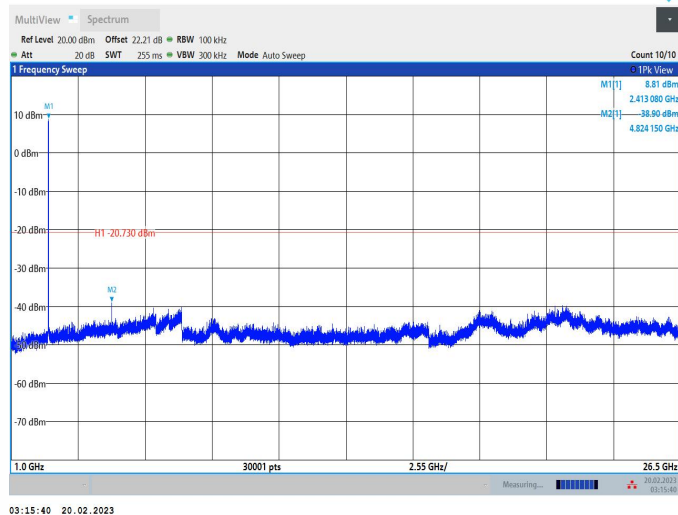

## 11B\_Ant1\_2437\_0~Reference

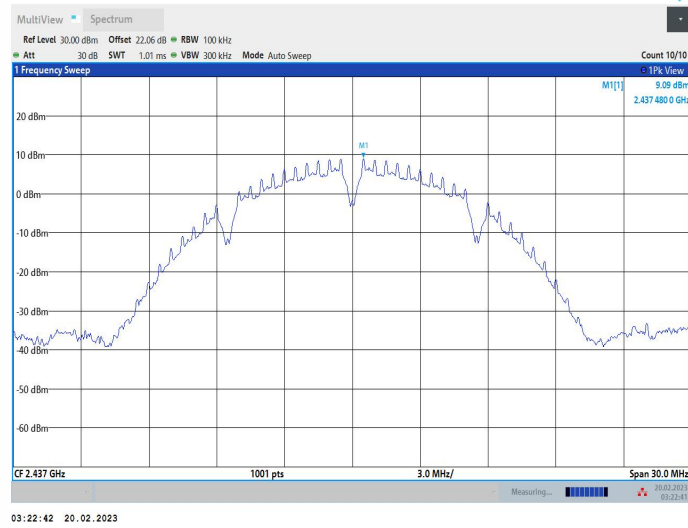

## 11B\_Ant1\_2437\_30~1000

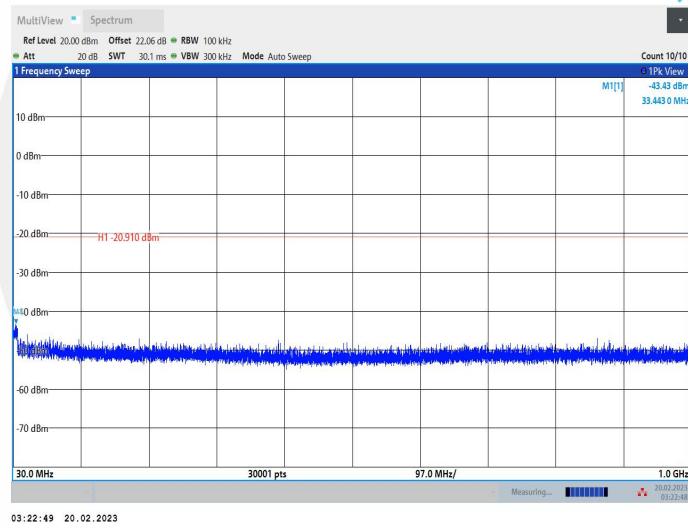

## 11B\_Ant1\_2437\_1000~26500

