

THINKCAR

Version: V1.00.001

Statement: **THINKCAR** owns the complete intellectual property rights for the software used by this product. For any reverse engineering or cracking actions against the software, THINKCAR will block the use of this product and reserve the right to pursue their legal liabilities.

Table of Contents

1 Product Descriptions.....	1
2 Technical Specifications	2
3 How To Use.....	2
3.1 Turn on the device.....	3
3.2 Language Setting.....	3
3.3 Connect Wi-Fi.....	4
3.4 Choose Time Zone	4
3.5 Register terms	5
3.6 Login.....	5
4 Function Descriptions.....	6
4.1 Diagnose.....	6
4.2 Maintenance & Service.....	7
4.3 OBD.....	7
4.4 Module.....	8
4.5 Feedback.....	8
4.6 Upgrade.....	9
4.7 Repair Info.....	9
4.8 File.....	10
4.9 Remote Assistance.....	10
4.10 Settings.....	11
5 Q&A.....	11



1 Product Descriptions

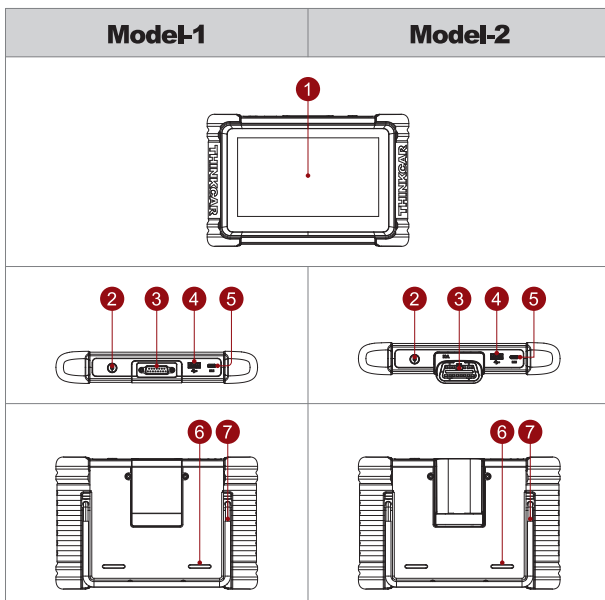

1. Touch Screen: 7 inches.
2. Power/Screen Lock Button:
When the host is off, turn it on by pressing the button for 3 seconds.
When the host is on, press the button to wake up the screen or turn off the screen;
Turn off the host by pressing the button for over 3 seconds; force a shut down by pressing the button for over 8 seconds.
3. Diagnostic cable interface (Model-1): Plug in the diagnostic cable interface to connect to the car OBD connector;
Diagnostic dongle(Model-2).
4. USB expansion port.
5. Power inlet: Connect a charger for charging or data transmission.
6. Loudspeaker.
7. Bracket.

2 Technical Specifications

THINKTOOL Host Computer

Display: 7" display

Resolution: 1024*600 pixel

Working Environment: 0°C ~ 50°C (32°F ~ 122°F)

Storage Environment: -20°C ~ 60°C (-4°F ~ 140°F)

Working voltage: 5V

Working current: ≤2.5A

THINKTOOL VCI

Working Voltage: 9~18V

Working Current: ≤130mA

Working Environment: 0°C ~ 50°C (32°F ~ 122°F)

Storage Environment: -20°C ~ 60°C (-4°F ~ 140°F)

Supported Protocols:

SAE J1850 PWM, SAE J1850 VPW, ISO 9141-2 ISO, ISO 14230-4 KWP, ISO 15765-4 CAN, CANFD and DoIP.

3 How To Use

Data Link Connector (DLC) Location

The DLC (Data Link Connector or Diagnostic Link Connector) is typically a 16 pin connector where diagnostic code readers interface with the vehicle's onboard computer. The DLC is usually located 12 inches from the center of the instrument panel (dash), under or around the driver's side for most vehicles. If Data Link Connector is not located under dashboard, a label should be there telling location. For some Asian and European vehicles, the DLC is located behind the ashtray and the ashtray must be removed to access the connector. If the DLC cannot be found, refer to the vehicle's service manual for the location.

Connect the THINKTOOL host computer with your vehicle through the OBDII port/diagnostic connector. Usually, the OBD port is located under the dashboard, above the pedal on the driver's side. The five locations shown in the picture are common OBDII port locations.

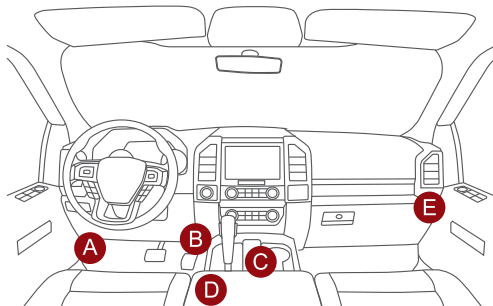

3.1 Turn on the device

After pressing the power button, image will be shown on the screen as follow.



3.2 Language Setting

Select the tool language from the languages displayed on the page.



3.3 Connect Wi-Fi

The system will automatically search all available Wi-Fi networks and you can choose the Wi-Fi needed. If the chosen network is open, you can connect it directly; If the chosen network is encrypted, you must enter the correct password. Then you can connect Wi-Fi after clicking "connect". when the Wi-Fi is connected, click "Next" to continue.

Tips: Wi-Fi must be set. If no Wi-Fi network is available nearby, you can enable "Portable Mobile Hotspot".

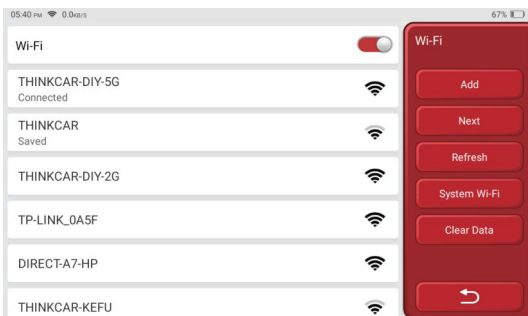

3.4 Choose Time Zone

Choose the time zone of the current location, then the system will automatically configure the time according to the time zone you chose.

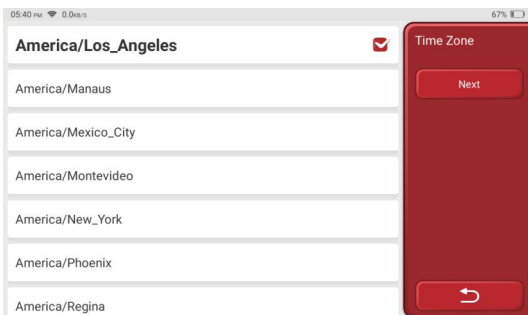

3.5 Register terms

Please read all the terms and conditions of the user agreement carefully. Choose "Agree with above terms", and click the "Next" button to complete the registration process. Then the page will jump to the "Login" page.

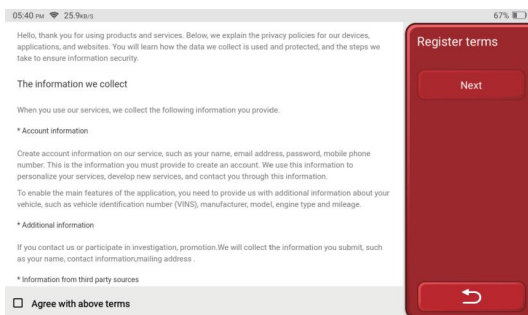

3.6 Login

The registration process will be different for different models of products. If your model is a wired device, the built-in diagnostic module is automatically activated and you do not need to log in when you use it for the first time. If you are using a device with a Bluetooth diagnostic connector, you need to log in to your account when you use it for the first time.

If you have owned other products of THINK series, you can directly log in by using the account available. You can click the trial button to skip the login page and experience the functions, but some functions in trial mode require registration before you can experience them.

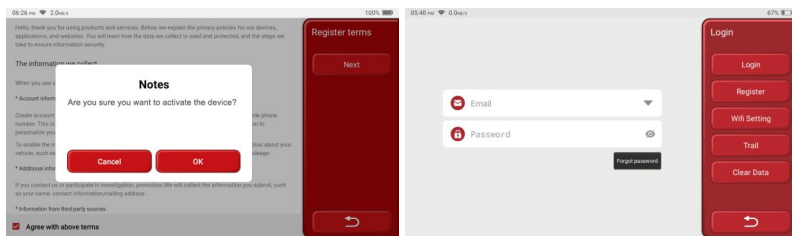

Model-1

Model-2

If you don't have an account for THINK products yet, please use your email address to register an account before using it.

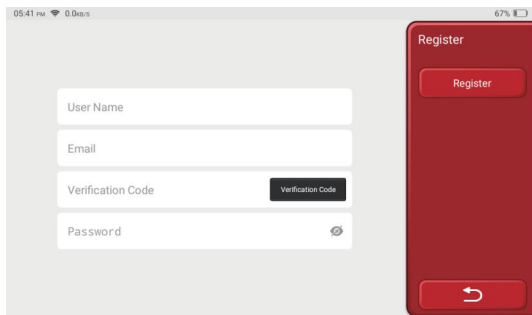

4 Function Descriptions

The THINKTOOL host computer have 10 functions, namely, Diagnose, Maintenance & Service, Module, Upgrade, File, OBD, Feedback, Repair Info, Remote Assistance and Settings.



Tips: Different models of products display different product names.

4.1 Diagnose

Full system diagnosis: it supports more than 160 automobile brands, smart diagnosis , full-system and full-function diagnosis: read fault codes, clear fault codes, read real-time data streams, special functions, action tests, etc. A diagnostic report will be automatically generated after the diagnosis.

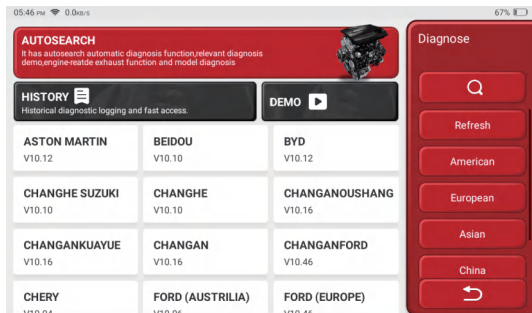

4.2 Maintenance & Service

The reset function in car maintenance refers to the ability to reset certain maintenance indicators or parameters in a vehicle's onboard computer system. This feature allows users to clear or restart specific maintenance-related notifications or tracking systems.

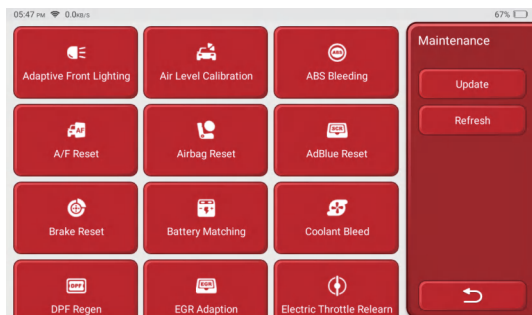

4.3 OBD

OBD (On-Board Diagnostics) is a system found in most modern vehicles that monitors and diagnoses the performance of various components. It allows mechanics and car owners to access real-time data and troubleshoot issues more efficiently. OBD can provide information about engine speed, fuel efficiency, emission levels, and sensor readings. Additionally, it can detect and display fault codes, enabling technicians to identify and fix problems quickly. Overall, OBD plays a crucial role in vehicle maintenance and helps ensure optimal performance and reduced emissions.

When you click the OBD button, the connection will automatically start. After the connection is successful, you will enter the OBD diagnostic page.

Item	Value
VIN(Vehicle Identification Number)	N/A
MIL Status	OFF
DTCs In This ECU	108
Readiness Completed	5
Readiness Not Completed	2
Readiness Not Supported	4
Datastream Supported	313
Ignition	Spark

4.4 Module

It is the entry to use modular function components. On the screen, you can find and use functional modules already connected to the host, check functional modules already bought or buy functional modules needed. Supports USB printer, USB oscilloscope, Bluetooth battery tester, tire pressure stick(TPMS), etc.



Tips: You can buy them on the official website or contact dealer.

4.5 Feedback

You can feedback the diagnostic software/app bugs to us for analysis and improvements.

Your submitted questions will be analyzed and provided with solutions by professionals.

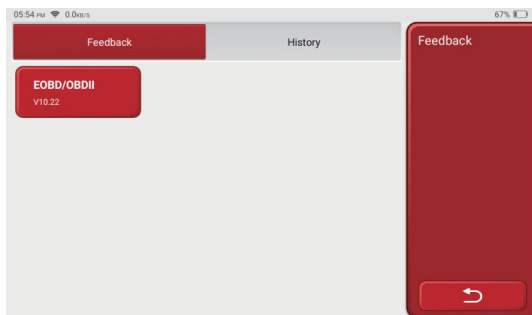

4.6 Upgrade

This module allows you to update the diagnostic software & App and set frequently used software. If you did not download the software in process of product registration or a pop-up message prompting you that some new software can be updated, you may use this option to download it or keep it synchronized with the latest version.

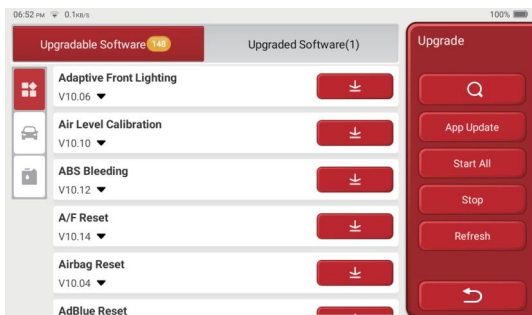

4.7 Repair Info

Contains product electronic manuals, obd fault code library, vehicle model coverage list, Calculator, file manager, and other useful gadgets.

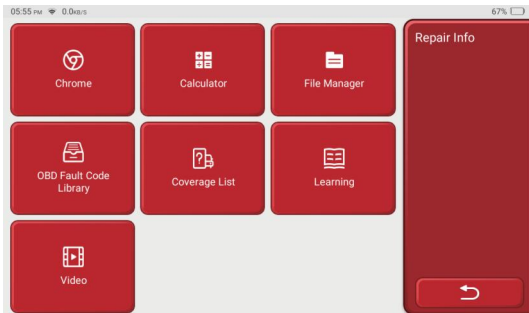

4.8 File

It is used to record and establish the file of the diagnosed vehicles. The file is created based on the vehicle VIN and check time, including all diagnostic-related data such as diagnostic reports, data stream records, thermal images, endoscopic pictures and videos.

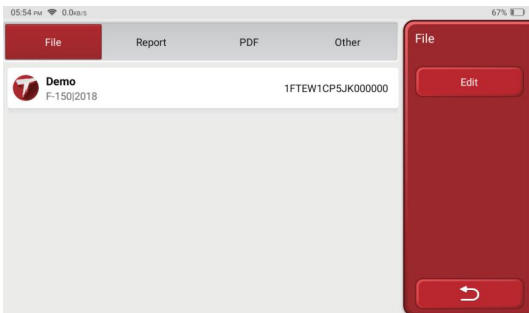

4.9 Remote Assistance

Provide service support through the use of remote assistance software. Different regions can choose different remote assistance software according to their needs.

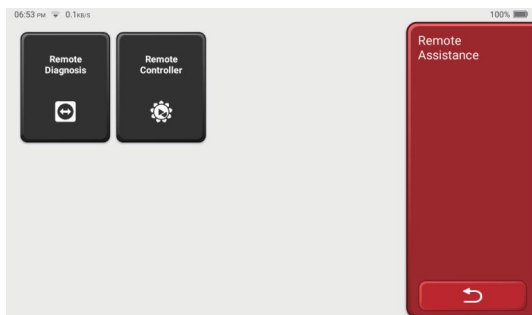

4.10 Settings

System settings for the product host. After the initial setting is completed, the user can modify or add related information here. More detailed information on settings can be viewed in the electronic manual at: Repair Info.

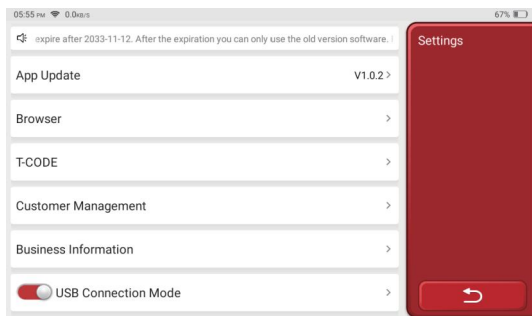

Tips: You can buy them on the official website or contact dealer.

5 Q&A

Here we list some common questions and answers related to this tool.

Q: Why does it have no responses when connected to a car computer?

A: Check whether the connection with the vehicle diagnostic seat is normal, whether the ignition switch is on, and whether the car supports the tool.

Q: Why does the system stop while reading the data stream?

A: This may be caused by loose connectors. Please turn off the tool, connect the connector firmly, and then turn it on again.

Q: Why does the host screen flash when the engine ignition starts?

A: It is normal and caused by electromagnetic interference.

Q: How to upgrade the system software?

A: 1. Start the tool and ensure a stable Internet connection.

2. Set up: select "System Version", and then click "Check Version" to enter the system upgrade interface.

3. Complete the process by following the instructions on the screen step by step. It may take a few minutes depending on the internet speed. Please be patient. After successfully completing the upgrade, the tool will automatically restart and enter the main interface.

Q: How to add function modules?

A: THINKCAR TECH INC offers 5 other functional modules. You can buy them on the official website or contact dealer.

Warranty Terms

This warranty applies only to users and distributors who purchase THINKTOOL products through normal procedures. Provide free warranty within one year. THINKTOOL warranty including electronic products for damages caused by defects in materials or workmanship. Damages to the equipment or components caused by abusing, unauthorized modification, using for non-designed purposes, operation in a manner not specified in the instructions, etc. are not covered by this warranty. The compensation for dashboard damage caused by the defect of this equipment is limited to repair or replacement. THINKCAR does not bear any indirect and incidental losses. THINKTOOL will judge the nature of the equipment damage according to its prescribed inspection methods.

Service Line: 1-909-757-1959

Customer Service Email: support@thinkcar.com

Official Website: www.thinkcar.com

Products tutorial, videos, Q&A and coverage list are available on THINKCAR official website.

Follow us on



[@thinkcar.official](https://www.facebook.com/thinkcar.official)



[@ObdThinkcar](https://twitter.com/ObdThinkcar)

FCC Requirement

Any changes or modifications not expressly approved by the party responsible for compliance could void the user's authority to operate the equipment.

This device complies with Part 15 of the FCC Rules. Operation is subject to the following two conditions:

- (1) this device may not cause harmful interference, and
- (2) this device must accept any interference received, including interference that may cause undesired operation.

Note: This equipment has been tested and found to comply with the limits for a Class B digital device, pursuant to Part 15 of the FCC Rules. These limits are designed to provide reasonable protection against harmful interference in a residential installation. This equipment generates, uses, and can radiate radio frequency energy, and if not installed and used in accordance with the instructions, may cause harmful interference to radio communications. However, there is no guarantee that interference will not occur in a particular installation. If this equipment does cause harmful interference to radio or television reception, which can be determined by turning the equipment off and on, the user is encouraged to try to correct the interference by one or more of the following measures:

- Reorient or relocate the receiving antenna.
- Increase the separation between the equipment and receiver.
- Connect the equipment into an outlet on a circuit different from that to which the receiver is connected.
- Consult the dealer or an experienced radio/TV technician for help.

This device contains licence-exempt transmitter(s)/receiver(s) that comply with Innovation, Science and Economic Development Canada 's licence-exempt RSS(s). Operation is subject to the following two conditions:

- (1) This device may not cause interference.
- (2) This device must accept any interference, including interference that may cause undesired operation of the device.

L'émetteur/récepteur exempt de licence contenu dans le présent appareil est conforme aux CNR d'Innovation, Sciences et Développement économique Canada applicables aux appareils radio exempts de licence. L'exploitation est autorisée aux deux conditions suivantes :

- 1) L'appareil ne doit pas produire de brouillage;
- 2) L'appareil doit accepter tout brouillage radioélectrique subi, même si le brouillage est susceptible d'en compromettre le fonctionnement.