

KC.IA.00500(DIAG MINI)

Antenna Specification

1. Application:

This application shall apply for antenna unit which shall be used such as automotive, conventional communications, smart home, etc..

2. Electrical Specification:

Those specifications were specially defined for customer's model, and all characteristics were measured under the model's handset testing jig .

2-1. Frequency Band:

Frequency Band	MHz
BT	2400~2500MHz

2-2. Impedance

50 ohm nominal

2-3. VSWR

2-3-1. Measurement frequency points and VSWR value

Frequency Band(MHz)	2400	2500
Typical Value: (VSWR)	1.2	1.5

UNLESS OTHER SPECIFIED TOLERANCES ON: X=± X.X=± X.XX=± ANGLES=± HOLEDIA=±		 TOXU TECHNOLOGY CO., LTD.
SCALE:	UNIT: mm	
DRAWN BY: LI	CHECKED BY: YS	THIS DRAWINGS AND SPECIFICATIONS ARE THE PROPERTY OF TOXU TECHNOLOGY CO.,LTD.AND SHALL NOT BE REPRODUCED OR USED AS THE BASIS FOR THE MANUFACTURE OR SALE OF APPARATUS OR DEVICES WITHOUT PERMISSION
DESIGNED BY: De wen	APPROVED BY: YS	
TITLE: KC.IA.00500 Antenna Specification		SPEC REV. P0

<p>2-3-4 Measuring Method</p>	<ol style="list-style-type: none"> 1. A 50 Ω coaxial cable is connected to the antenna. Then this cable is connected to a network analyzer to measure the VSWR. 2. Keeping this jig away from metal at least 20 cm
<p>2-3-5 Picture</p>	

<p>UNLESS OTHER SPECIFIED TOLERANCES ON: X=± X.X=± X.XX=± ANGLES=± HOLEDIA=±</p>		<p>TOXU 同讯技术 TOXU TECHNOLOGY CO., LTD.</p>
<p>SCALE:</p>	<p>UNIT: mm</p>	
<p>DRAWN BY: LI</p>	<p>CHECKED BY: YS</p>	<p>THIS DRAWINGS AND SPECIFICATIONS ARE THE PROPERTY OF TOXU TECHNOLOGY CO.,LTD.AND SHALL NOT BE REPRODUCED OR USED AS THE BASIS FOR THE MANUFACTURE OR SALE OF APPARATUS OR DEVICES WITHOUT PERMISSION</p>
<p>DESIGNED BY: De wen</p>	<p>APPROVED BY: YS</p>	
<p>TITLE: KC.IA.00500 Antenna Specification</p>		<p>SPEC REV. P0</p>

2-4. Efficiency and Gain

4-5.1 Measure method

1. Using a low loss coaxial cable to link a standard handset jig
2. Fixed this handset jig on chamber's rotator plane
3. Linking jig into network analyzer port and using a probing horn antenna to collect data.
4. Using another standard gain horn antenna to calibrated those data

4-5.2 Chamber definition

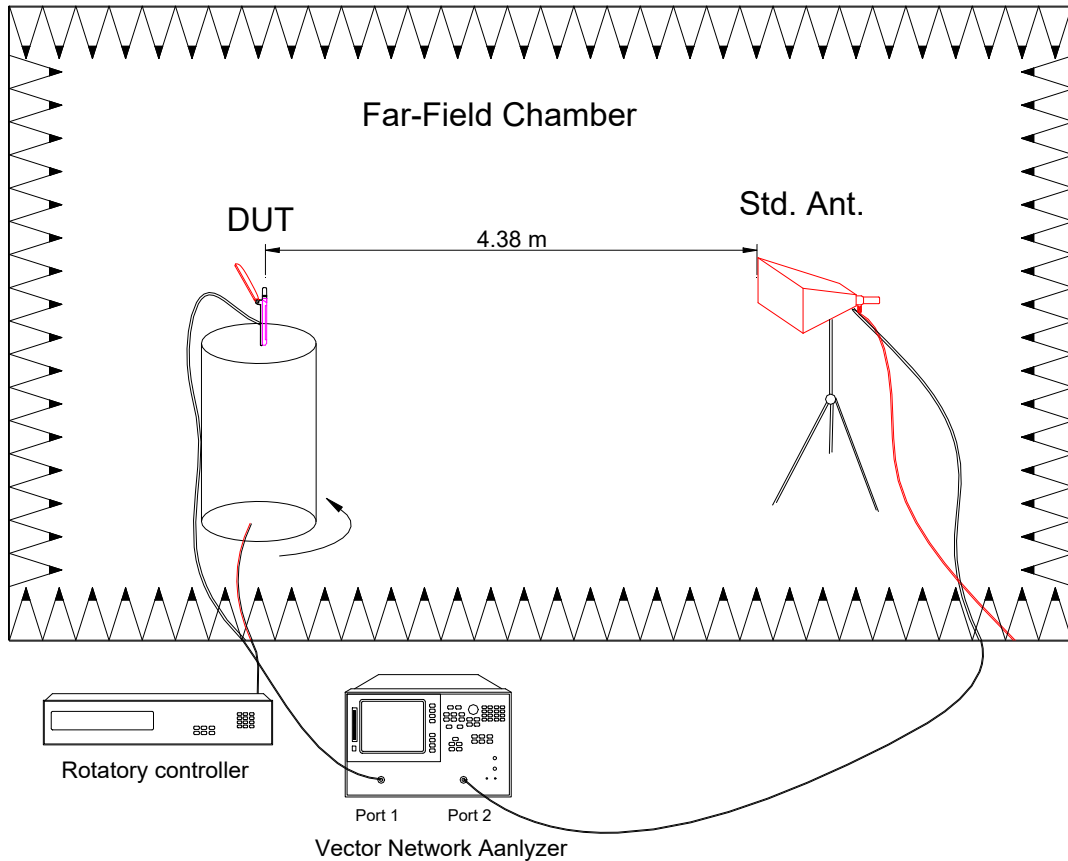

1. An anechoic chamber (7mx4mx3m) which satisfied far-field condition was applied to avoid multi-path effect
2. The quite room region is 40cmx40cmx40cm at the center of rotator
3. The distance between DUT and standard antenna is 4.38 m
4. Probing antenna (9120D horn antenna) and standard gain horn antenna (BBHA9120 LPF 700MHz ~6GHz)

UNLESS OTHER SPECIFIED TOLERANCES ON: X=± X.X=± X.XX=± ANGLES=± HOLEDIA=±		 TOXU TECHNOLOGY CO., LTD.
SCALE:	UNIT: mm	
DRAWN BY: LI	CHECKED BY: YS	<small>THIS DRAWINGS AND SPECIFICATIONS ARE THE PROPERTY OF TOXU TECHNOLOGY CO.,LTD.AND SHALL NOT BE REPRODUCED OR USED AS THE BASIS FOR THE MANUFACTURE OR SALE OF APPARATUS OR DEVICES WITHOUT PERMISSION</small>
DESIGNED BY: De wen	APPROVED BY: YS	
TITLE: KC.IA.00500 Antenna Specification		SPEC REV. P0

2-4-1 Efficiency and Gain and 3D Date

Frequency/Mhz	Efficiency / %	MaxGain/dBi
2400	49.66	1.75
2410	50.35	2.36
2420	49.09	1.99
2430	49.43	2.5
2440	49.77	2.47
2450	49.55	2.29
2460	50.35	2.54
2470	49.09	2.13
2480	51.64	2.72
2490	52.36	2.32
2500	53.58	2.72

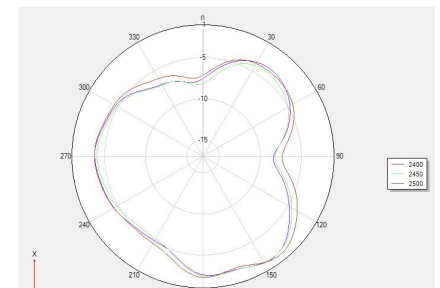
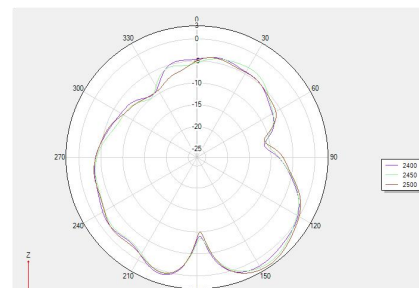
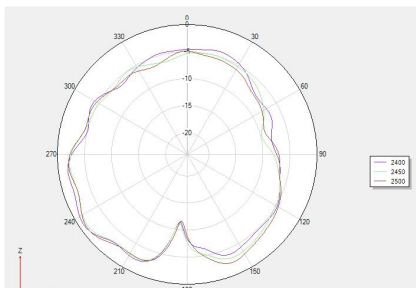
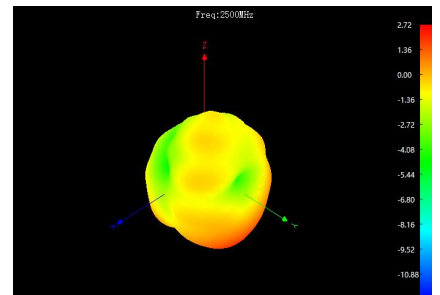
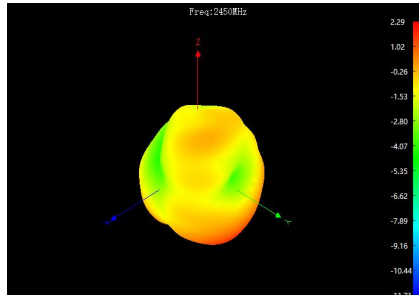
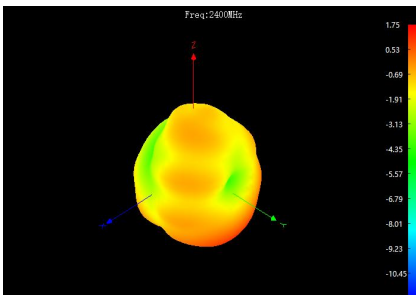

UNLESS OTHER SPECIFIED TOLERANCES ON:

$X = \pm$ $X.X = \pm$ $X.XX = \pm$

ANGLES = \pm HOLEDIA = \pm

TOXU
同讯技术

TOXU TECHNOLOGY CO., LTD.

SCALE:

UNIT: mm

DRAWN BY: LI

CHECKED BY: YS

DESIGNED BY: De wen

APPROVED BY: YS

THIS DRAWINGS AND SPECIFICATIONS ARE THE PROPERTY OF TOXU TECHNOLOGY CO.,LTD.AND SHALL NOT BE REPRODUCED OR USED AS THE BASIS FOR THE MANUFACTURE OR SALE OF APPARATUS OR DEVICES WITHOUT PERMISSION

TITLE: KC.IA.00500 Antenna Specification

SPEC REV.

P0

3. Antenna environm

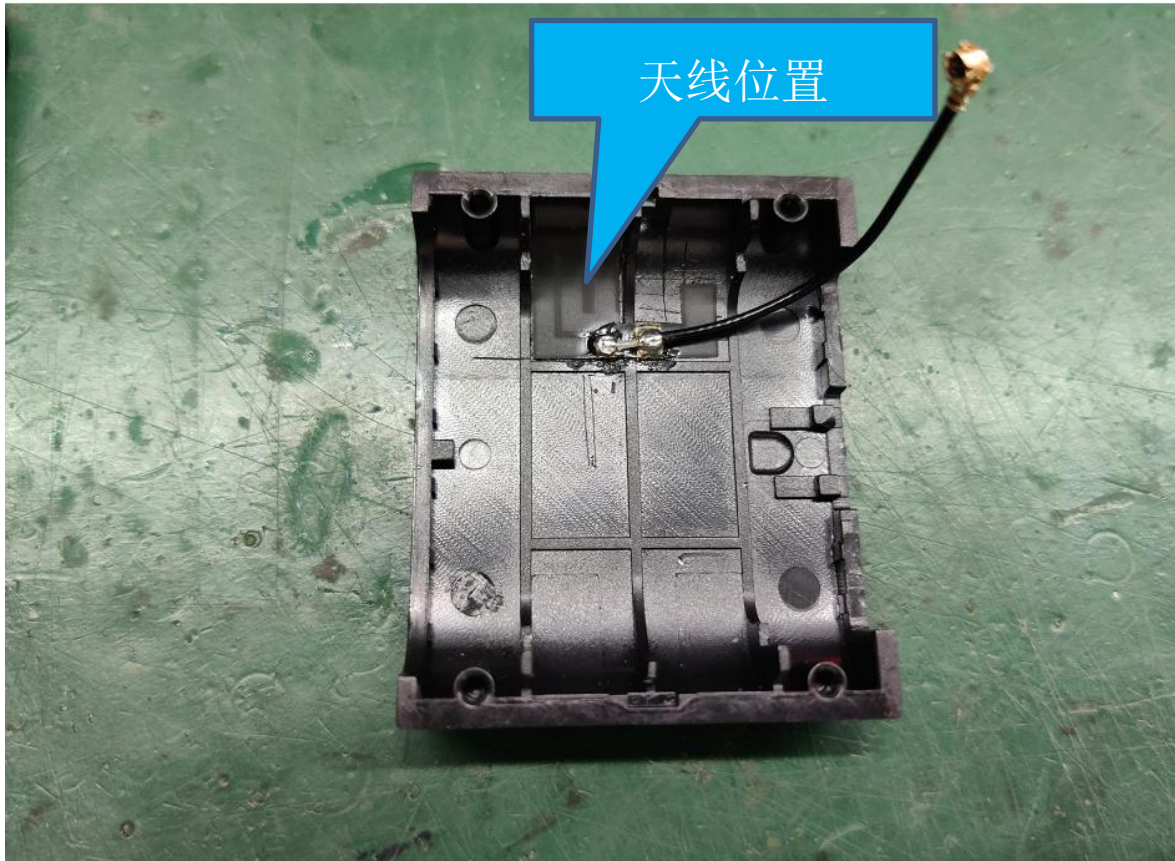

UNLESS OTHER SPECIFIED TOLERANCES ON: $X = \pm$ $X.X = \pm$ $X.XX = \pm$ ANGLES = \pm HOLEDIA = \pm		 TOXU TECHNOLOGY CO., LTD.
SCALE:	UNIT: mm	
DRAWN BY: LI	CHECKED BY: YS	<small>THIS DRAWINGS AND SPECIFICATIONS ARE THE PROPERTY OF TOXU TECHNOLOGY CO.,LTD.AND SHALL NOT BE REPRODUCED OR USED AS THE BASIS FOR THE MANUFACTURE OR SALE OF APPARATUS OR DEVICES WITHOUT PERMISSION</small>
DESIGNED BY: De wen	APPROVED BY: YS	
TITLE: KC.IA.00500 Antenna Specification		SPEC REV. P0

4. Mechanical Specification:

3-1. Mechanical Configuration (Unit: mm)

The appearance of the antenna is according to drawing

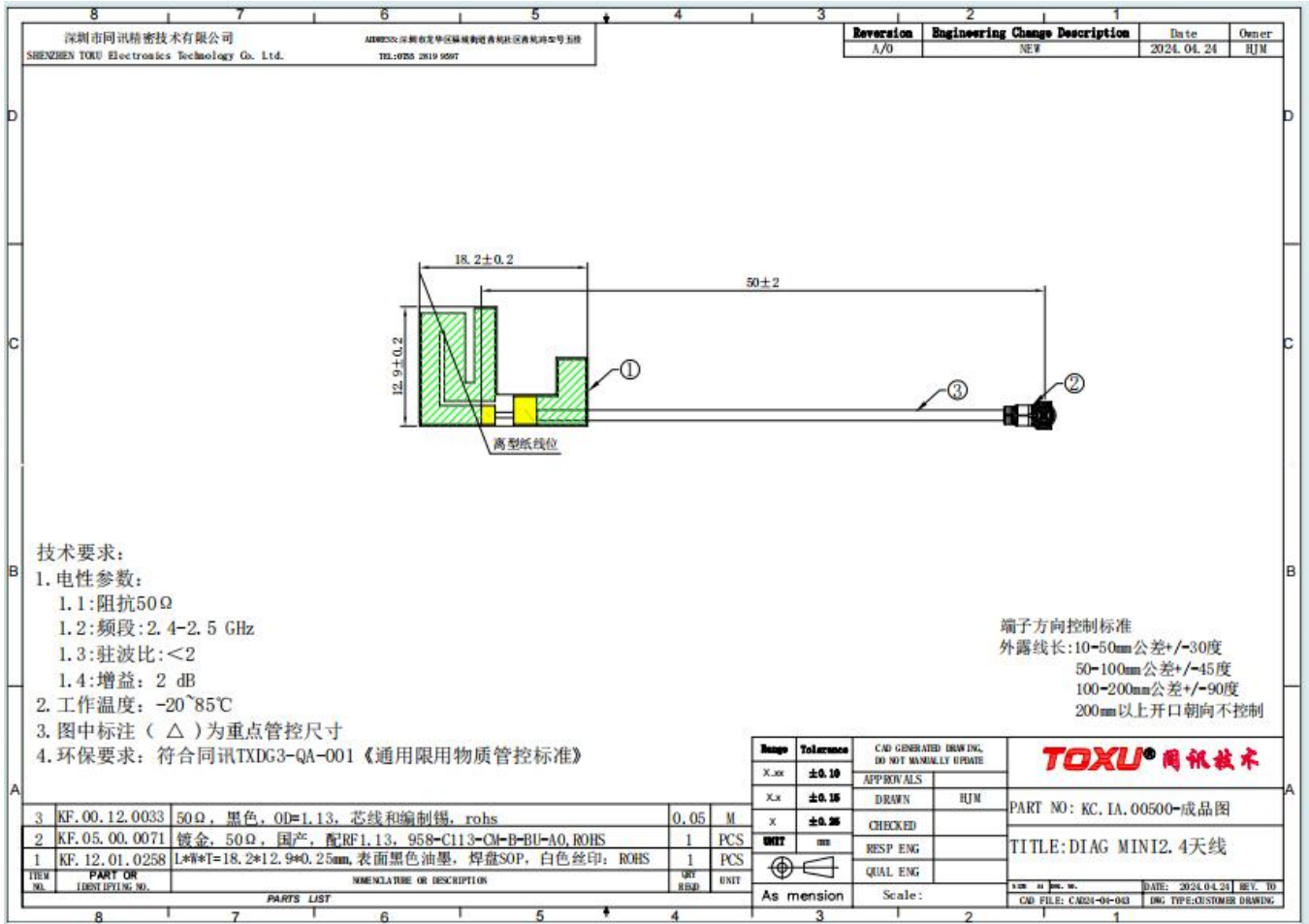

UNLESS OTHER SPECIFIED TOLERANCES ON: X=± X.X=± X.XX=± ANGLES=± HOLEDIA=±		TOXU TECHNOLOGY CO., LTD.
SCALE:	UNIT: mm	
DRAWN BY: LI	CHECKED BY: YS	THIS DRAWINGS AND SPECIFICATIONS ARE THE PROPERTY OF TOXU TECHNOLOGY CO.,LTD.AND SHALL NOT BE REPRODUCED OR USED AS THE BASIS FOR THE MANUFACTURE OR SALE OF APPARATUS OR DEVICES WITHOUT PERMISSION
DESIGNED BY: De wen	APPROVED BY: YS	
TITLE: KC.IA.00500 Antenna Specification		SPEC REV. P0

5 .Packaging specification:

Product number: xxxxx			
Product model: xxxxx			
一、 Label requirements:			
Customer	xxx		
supplier	xxxxx		
Material coding	xx		
Product model	xx		
Number	XXX PCS	Factory date	X X X
Remarks			
二、 Boxing:			
Job description:			
1. Inner packaging:			
XXpcs A bag			
2. External packaging:			
Xx PCS ;			
3. Matters needing attention:			
a. Whether to add partition and pearl cotton;			
b. Label attachments, such as ROHS, etc.;			

PE 袋

纸箱

UNLESS OTHER SPECIFIED TOLERANCES ON: $X = \pm$ $X.X = \pm$ $X.XX = \pm$ ANGLES = \pm HOLEDIA = \pm		 TOXU TECHNOLOGY CO., LTD.		
SCALE:	UNIT: mm	THIS DRAWINGS AND SPECIFICATIONS ARE THE PROPERTY OF TOXU TECHNOLOGY CO.,LTD.AND SHALL NOT BE REPRODUCED OR USED AS THE BASIS FOR THE MANUFACTURE OR SALE OF APPARATUS OR DEVICES WITHOUT PERMISSION		
DRAWN BY: LI	CHECKED BY: YS			
DESIGNED BY: De wen	APPROVED BY: YS			
TITLE: KC.IA.00500 Antenna Specification		<table border="1" style="border-collapse: collapse;"> <tr> <td style="padding: 2px;">SPEC REV.</td> </tr> <tr> <td style="padding: 2px; text-align: center;">P0</td> </tr> </table>	SPEC REV.	P0
SPEC REV.				
P0				