

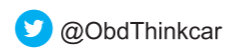

THINKCAR TECH INC

Follow us



XHINKCAR
THINKCAR

LEADING TECH IN DIAGNOSTICS



THINKLINK Video Remote Service Device
User Manual

Catalog

1	Product Instruction	1
2	Product configuration and components	2
3	How to use	3
4	How to carry out remote diagnosis	7
5	Frequently asked questions	9

1 Product Instruction

The THINKLINK video remote service device is an Internet product developed by the THINKCAR Tech for automobile maintenance assistance. With the help of the Internet and Thinklink equipment, you can answer the diagnosis request of customers such as repair shops, and provide service (paid service) for them with your high-end equipment and skills by linking the automobile fault diagnosis instrument held by the customer.

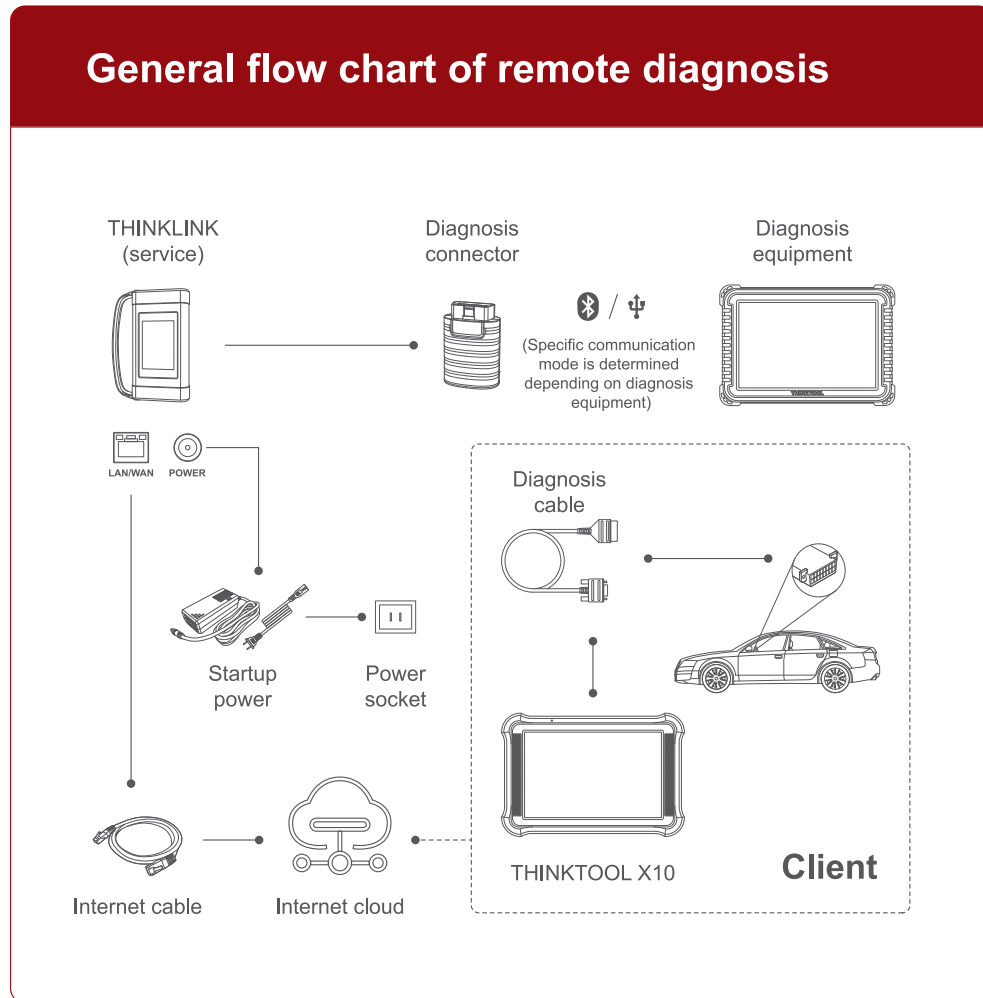

2 Product configuration and components

1. Main control part

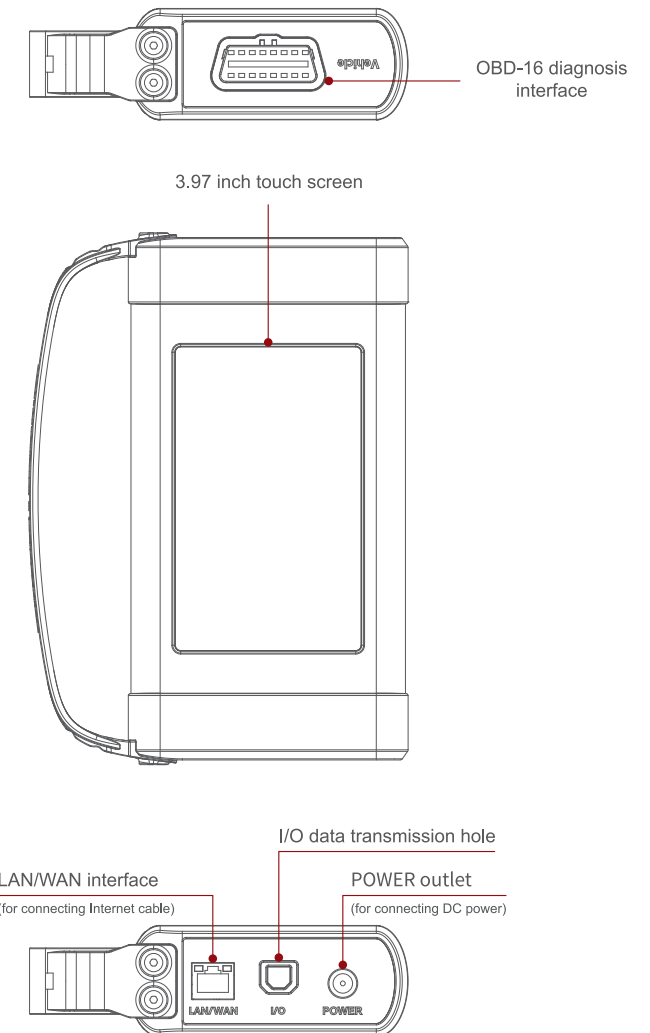

Warning: the THINKLINK video remote service device of the server is powered by DC power, and is strictly prohibited from being directly inserted into the OBD diagnosis base of vehicle. The company bears no liability for economic loss caused by failure of strictly following the method above.

2. List of accessories

General accessories are the same for each machine, but the product configuration varies for different markets. For details, please consult local dealers or use the actual accessories.

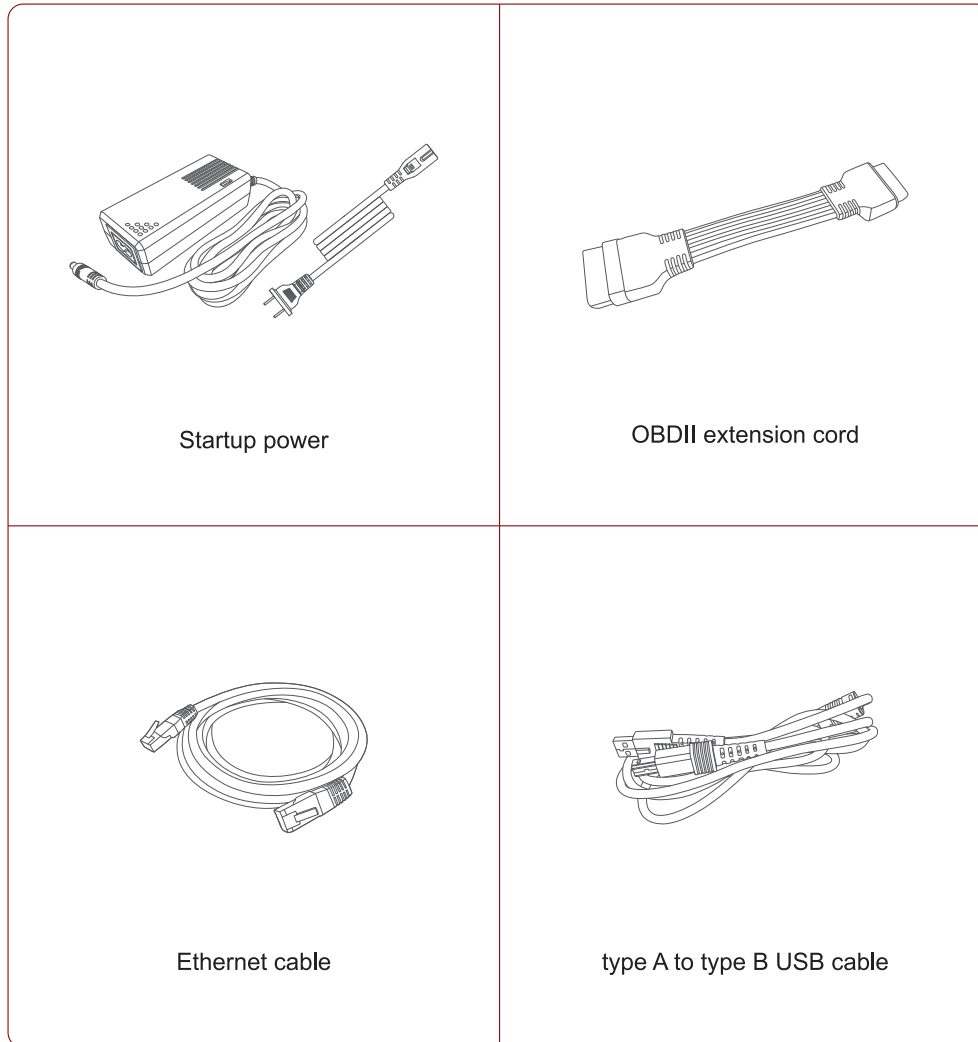

Note: figures above are only for reference, please see the real product for detailed information.

3 How to use

1. Computer login or registration

Input <https://thinklinkus.thinkcar.com/> into the computer browser to enter the interface as follows:

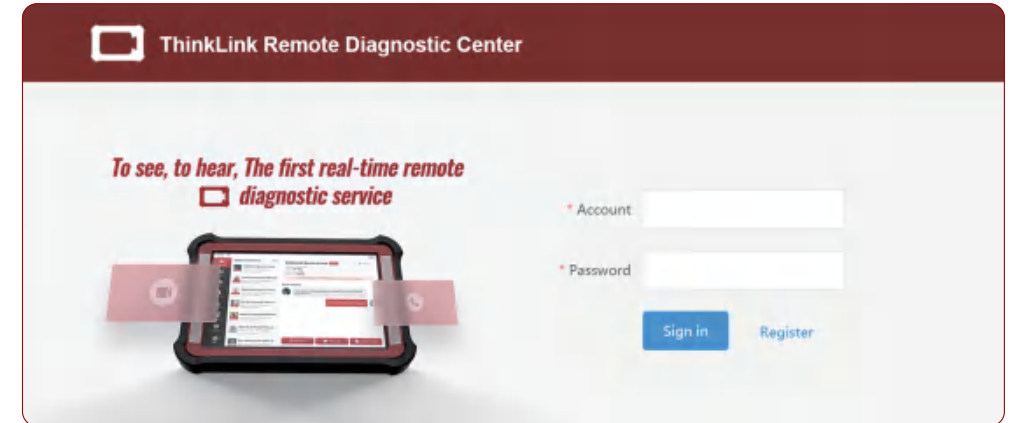

2. Equipment binding and activation

Register an account via email and activate the account, enter the binding interface of the THIN-KLINK service device, as the figure below, and input the 8 activation codes on the accompanying password card.



3. Merchants Management

After your THINKLINK equipment is bound, it directly jumps to the interface on the computer as the figure below, including two interfaces [Workbench] and [Customer Management], and [Customer Management] holds the priority of access. Customer information should be completely filled to provide customer service.

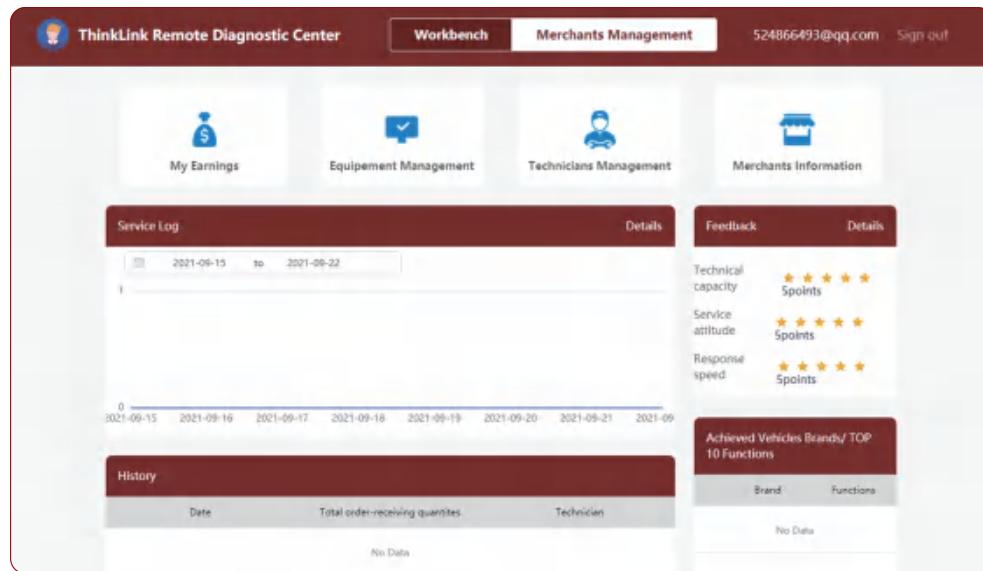

[My Earnings]

To show recent earning details of remote assistance, withdraw record, etc.

[Equipment Management]

To check, configure and unbind all connectors and Thinkcar® Thinlink equipment owned by your account.

[Technician Management]

To face to the customer, if the account of the customer owns multiple Thinkcar® Thinlink equipment and personnel.

[Merchants Information]

To list all information of the customer in detail, for remote assistance of customer query, e.g. customer’s name, star rating, address, etc.

4. Remote communication interface

Click [Workbench] to enter the workbench management interface, where all items of remote assistance are summarized.

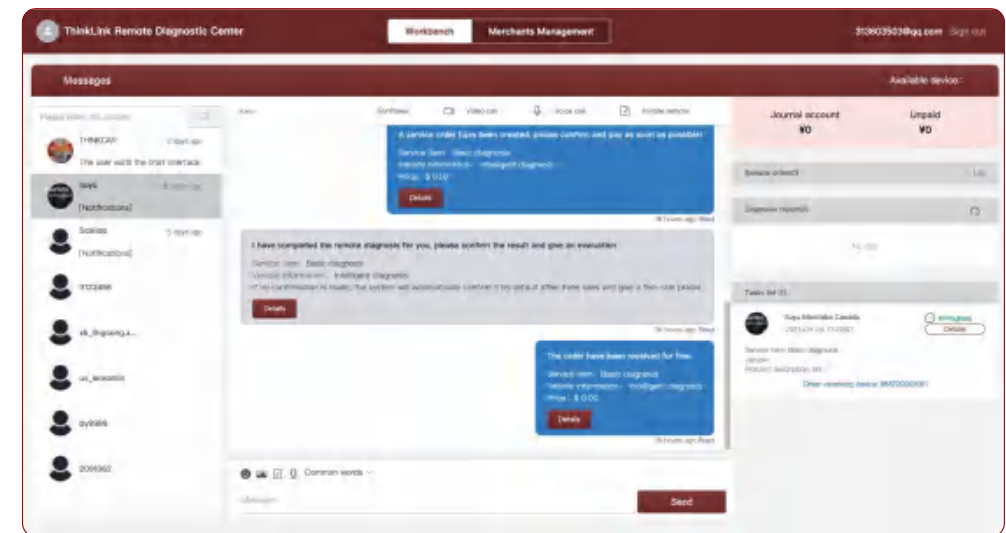

[My Message]

Consist of four parts, namely contact device, communication tool bar, information device and input device The contact device lists all the people who asked for your assistance; when a remote linking order is required, choose a contact, and click the symbol [Remote Assistance].

[Earning Flow]

To prompt earnings after assistance service.

[Remote order]

To list the latest requests, click to unfold details of the requests, and you can choose appropriate items and create a “remote diagnosis” order after communicating with the person requiring diagnosis.

[Diagnosis Report]

Five reports are listed at most; after selecting a service target, you can remotely acquire five latest diagnosis records of the diagnosis instrument held by the customer. (Generally the customer has made local diagnosis for times before seeking for assistance).

[Task List]

To list information of remote diagnosis requests, including task name, vehicle model description, service instrument information, etc.

4 How to carry out remote diagnosis

1. After the customer (the person seeking for assistance) transmits the remote diagnosis request, and designates you to provide the service, [My Message] prompts the new information, like a chat tool such as WeChat; if no person is designated, the message is shown in the [Request] , check and pick it, and you can start and create an order after preliminary communication with the customer.
2. After the customer agrees, click the button [Remote Diagnosis] to create an order in the popped interface as follows; the price is set as 0, then it is acceptable by default, and directly enter into remote service; when the price is greater than 0, a payment two-dimensional code is generated.
3. The customer can follow the prompts to pay by credit card to enter into remote diagnosis. At the moment, you should connect all equipment according to the following figure.

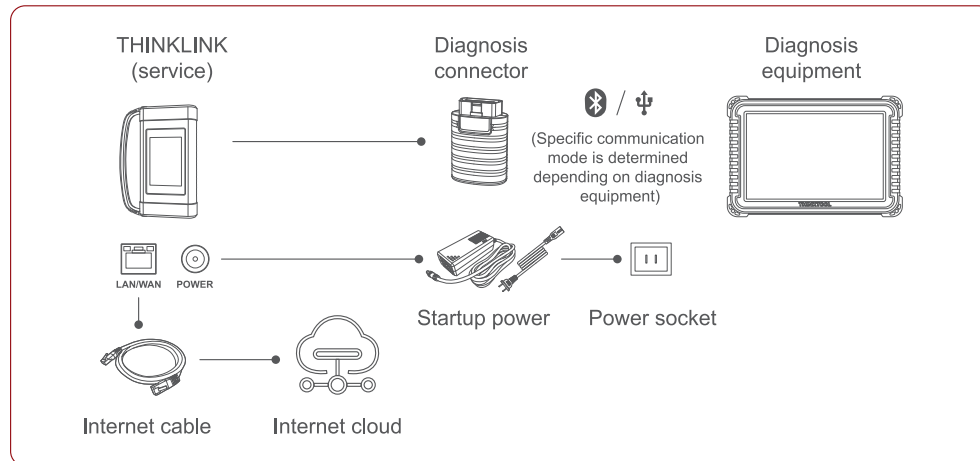

4. After the network is connected, the screen of the Thinkcar® Thinklink service device prompts [you have a remote diagnosis task uncompleted];

*One remote service device can only accept remote service once.

*Another remote service can be accepted only if the previous one is completed.

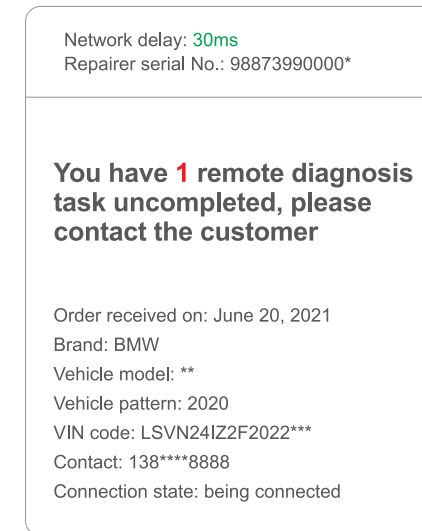

5. Contact the customer (the person who poses the request), tell him to ensure that the vehicle has been connected with the diagnosis device, and the vehicle is ignited to the state [ON] or [START]. In case of normal connection of both parties, the THINKLINK service device shows the following information.

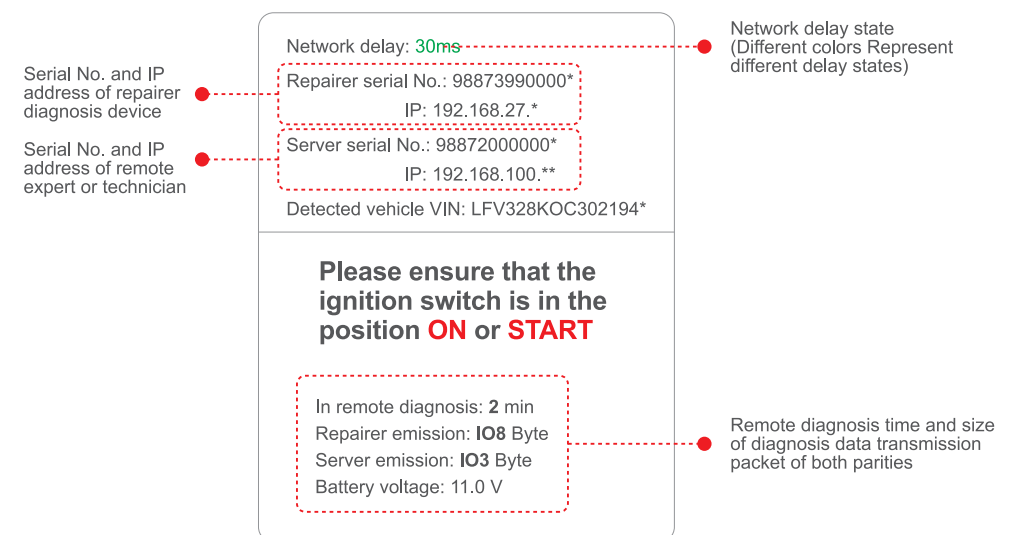

6. At the moment, video remote diagnosis can be started, its operation method is same as the local vehicle diagnosis operation procedure, please refer to the user manual of the diagnosis equipment for specific operation methods.

- *During video remote diagnosis, do not cut off vehicle connection and network connection.
 - *During remote on-line programming, ensure that it is carried out in the network state of green.
7. When a fault code is found in video remote diagnosis, solve the problem with your professional knowledge, or take your advantages to implement special functions such as matching and calibration, so as to complete a remote diagnosis task, for benefits of both parties.
 8. After remote diagnosis, do remember to click completed for corresponding tasks in the [Workbench] on the computer.

5 Frequently asked questions

1. Are there network requirements for video remote diagnosis?

Yes, the video remote diagnosis system requires a bandwidth of 100M or greater, the faster, the better.

2. What is the meaning of network delay displayed on the THINKLINK service device during video remote diagnosis?

Network delay represents the current network state, and it includes the following states:

Green: indicating normal network, ensure that on-line programming is carried out at the green state.

Yellow: indicating unstable network, please keep stable, and it is inappropriate for operations such as matching and calibration/

Red: indicating poor network, and it is inappropriate for remote diagnosis.

3. Why does it show poor network?

There are reasons for poor network, maybe because the local network is crowded, someone is downloading something, and it suggests that a stable network be adopted for remote diagnosis.

4. Does original diagnosis equipment or third party diagnosis equipment cooperate with the THINKLINK equipment for video remote diagnosis?

Yes, THINKLINK supports most third party manufacturers to serve customers.

5. Why can't the electric control system of some old vehicles be tested?

This product only supports CANBUS or Dolp communication vehicles, some old models use K line communication, and thus connection errors may be caused.

6. Can a heavy truck be tested?

Due to the difference of 24V power supply, this product only supports a part of heavy vehicles, so it suggests that a heavy vehicle should not be connected.

7. Whether the THINLINK video remote service device can get power from the vehicle OBD port?

No, the THINKLINK video remote service device can only be powered by adapter provided by

the company, it is forbidden to get power from the vehicle diagnosis base, and the company bears no liability for damage or economic loss caused by failure of following the agreement.

8.Can the server be connected with multiple diagnosis requests?

To ensure uniqueness of the equipment, the server can only serve one customer each time.

9.Why does the request in the request plaza disappear automatically?

Requests in the request plaza have a time limit, and then disappear over due.

10.How to upgrade the THINKLINK service device system?

When the equipment is powered and networked, and a new software version is detected, the screen prompts to upgrade, and click [Yes] to start upgrading. Please do remember to upgrade timely so as to get the best service.

Warranty Terms

- This warranty applies only to users and distributors who purchase THINKCAR products through normal procedures.
- Within one year from the date of delivery, THINKCAR warrants its electronic products for damages caused by defects in materials or workmanship.
- Damages to the equipment or components because of abuse, unauthorized modification, use for non-designed purposes, operation in a manner not specified in the instructions, etc. are not covered by this warranty.
- The compensation for dashboard damage caused by the defect of this equipment is limited to repair or replacement. THINKCAR does not bear any indirect and incidental losses.
- THINKCAR will judge the nature of the equipment damage according to its prescribed inspection methods. No agents, employees or business representatives of THINKCAR are authorized to make any confirmation, notice or promise related to THINKCAR products.

Thinkcar Tech Inc

Service Line: 1-909-757-1959

Customer Service Email: support@thinkcar.com

Official Website: www.thinkcar.com

Products tutorial, videos, Q&A and coverage list are available on Thinkcar official website.

Follow us on

**FCC Requirement**

Changes or modifications not expressly approved by the party responsible for compliance could void the user's

authority to operate the equipment. This device complies with Part 15 of the FCC Rules.

Operation is subject to the following two conditions:

- (1) this device may not cause harmful interference, and
- (2) this device must accept any interference received, including interference that may cause undesired operation.

Note: This equipment has been tested and found to comply with the limits for a Class B digital device, pursuant to Part 15 of the FCC Rules. These limits are designed to provide reasonable protection against harmful interference in a residential installation. This equipment generates, uses, and can radiate radio frequency energy, and if not installed and used in accordance with the instructions, may cause harmful interference to radio communications. However, there is no guarantee that interference will not occur in a particular installation. If this equipment does cause harmful interference to radio or television reception,

which can be determined by turning the equipment off and on, the user is encouraged to try to correct the interference by one or more of the following measures:

- Reorient or relocate the receiving antenna.
- Increase the separation between the equipment and receiver.
- Connect the equipment into an outlet on a circuit different from that to which the receiver is connected.
- Consult the dealer or an experienced radio/TV technician for help

IC Requirement

This device contains licence-exempt transmitter(s)/receiver(s) that comply with Innovation, Science and Economic Development Canada's licence-exempt RSS(s). Operation is subject to the following two conditions:

(1) This device may not cause interference.

(2) This device must accept any interference, including interference that may cause undesired operation of the device.

L'émetteur/récepteur exempt de licence contenu dans le présent appareil est conforme aux CNR d'Innovation, Sciences et Développement économique Canada applicables aux appareils radio exempts de licence. L'exploitation est autorisée aux deux conditions suivantes :

1) L'appareil ne doit pas produire de brouillage;

2) L'appareil doit accepter tout brouillage radioélectrique subi, même si le brouillage est susceptible d'en compromettre le fonctionnement.

IC WARNING

Cet équipement est conforme aux limites d'exposition aux rayonnements ISED établies pour un environnement non contrôlé. L'utilisateur final doit suivre les instructions spécifiques pour satisfaire les normes. Cet émetteur ne doit pas être co-implanté ou fonctionner en conjonction avec toute autre antenne ou transmetteur.

Le dispositif portatif est conçu pour répondre aux exigences d'exposition aux ondes radio établie par le développement énergétique DURABLE. Ces exigences un SAR limite de 1,6 W/kg en moyenne pour un gramme de tissu. La valeur SAR la 0.48 W/kg plus élevée signalée en vertu de cette norme lors de la certification de produit à utiliser lorsqu'il est correctement porté sur le corps.

Operation in the band 5150– 5250 MHz is only for indoor use to reduce the potential for harmful interference to co-channel mobile satellite systems.