

Test Report

Product: dollarfix DF51, ECHO
Trade Mark: dollarfix, DND, THINKCAR,
XHINKCAR, MUCAR
Model Number: TDFD
FCC ID: 2AUARTDFD

Prepared for

THINKCAR TECH CO., LTD.
2606, building 4, phase II, TiananYungu, Gangtou community, Bantian,
Longgang District, Shenzhen, China

Prepared by

Shenzhen HongBiao Certification& Testing Co., Ltd
Room 102, 201, Building 2, Yuanwanggu RFID Industrial Park, Tongguan
Road, Tianliao Community, Yutang Street, Guangming District, Shenzhen,
China
Tel.: +86-755-2998 9321 Fax.: +86-755-2998 5110
Website: <http://www.sz-hongbiao.com>

Table of Contents

| | | |
|----------|---|-----------|
| 1 | GENERAL DESCRIPTION | 6 |
| 1.1 | DESCRIPTION OF EUT..... | 6 |
| 1.2 | TEST MODE..... | 6 |
| 1.3 | OPERATION CHANNEL LIST | 6 |
| 1.4 | TEST SETUP | 7 |
| 1.5 | ANCILLARY EQUIPMENT | 7 |
| 2 | SUMMARY OF TEST RESULT | 8 |
| 3 | TEST FACILITIES AND ACCREDITATIONS | 9 |
| 3.1 | TEST LABORATORY | 9 |
| 3.2 | ENVIRONMENTAL CONDITIONS | 9 |
| 3.3 | MEASUREMENT UNCERTAINTY | 9 |
| 3.4 | TEST SOFTWARE | 9 |
| 4 | LIST OF TEST EQUIPMENT | 10 |
| 5 | TEST ITEM AND RESULTS..... | 12 |
| 5.1 | ANTENNA REQUIREMENT | 12 |
| 5.1.1 | <i>Standard Requirement</i> | 12 |
| 5.1.2 | <i>Test Result</i> | 12 |
| 5.2 | CONDUCTED EMISSION..... | 13 |
| 5.2.1 | <i>Limits</i> | 13 |
| 5.2.2 | <i>Test Procedures</i> | 13 |
| 5.2.3 | <i>Test Setup</i> | 14 |
| 5.2.4 | <i>Test Result</i> | 14 |
| 5.3 | RADIATED EMISSION | 15 |
| 5.3.1 | <i>Limits</i> | 15 |
| 5.3.2 | <i>Test Procedures</i> | 15 |
| 5.3.3 | <i>Test Setup</i> | 15 |
| 5.3.4 | <i>Test Result</i> | 16 |
| 5.3.5 | <i>Radiated Band Edge</i> | 21 |
| 5.4 | PEAK OUTPUT POWER..... | 22 |
| 5.4.1 | <i>Limit</i> | 22 |
| 5.4.2 | <i>Test Procedure</i> | 22 |
| 5.4.3 | <i>Test Setup</i> | 22 |
| 5.4.4 | <i>Test Results</i> | 22 |
| 5.5 | 20DB OCCUPIED CHANNEL BANDWIDTH..... | 24 |
| 5.5.1 | <i>Limit</i> | 24 |
| 5.5.2 | <i>Test Procedure</i> | 24 |
| 5.5.3 | <i>Test Setup</i> | 24 |
| 5.5.4 | <i>Test results</i> | 24 |
| 5.6 | CARRIER FREQUENCY SEPARATION | 30 |
| 5.6.1 | <i>Limit</i> | 30 |
| 5.6.2 | <i>Test Procedure</i> | 30 |
| 5.6.3 | <i>Test Setup</i> | 30 |
| 5.6.4 | <i>Test Results</i> | 30 |
| 5.7 | HOPPING CHANNEL NUMBER | 36 |
| 5.7.1 | <i>Limit</i> | 36 |
| 5.7.2 | <i>Test Procedure</i> | 36 |
| 5.7.3 | <i>Test Setup</i> | 36 |
| 5.7.4 | <i>Test Results</i> | 36 |
| 5.8 | DWELL TIME..... | 39 |
| 5.8.1 | <i>Limit</i> | 39 |
| 5.8.2 | <i>Test Procedure</i> | 39 |

TEST RESULT CERTIFICATION

Applicant's Name..... : THINKCAR TECH CO., LTD.
Address : 2606, building 4, phase II, TiananYungu, Gangtou community,
Bantian, Longgang District, Shenzhen, China
Manufacturer's Name : THINKCAR TECH CO., LTD.
Address : 2606, building 4, phase II, TiananYungu, Gangtou community,
Bantian, Longgang District, Shenzhen, China

Product description

Product name : dollarfix DF51, ECHO
Model Number : TDFD
Standards..... : FCC Part 15.247
Test procedure..... : IEEE/ANSI C63.10-2020

This device described above has been tested by Shenzhen HongBiao Certification& Testing Co., Ltd and the test results show that the equipment under test (EUT) is in compliance with the EMC requirements. And it is applicable only to the tested sample identified in the report.

Date of Test

Date (s) of performance of tests..... : November 07, 2023 ~ November 17, 2023
Test Result..... : **Pass**

Testing Engineer : 

(Z o e S u)

Technical Manager : 

(G a r y L u)

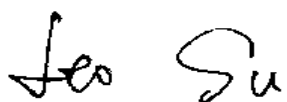
Authorized Signatory : 

(L e o S u)

1 General Description

1.1 Description of EUT

| | |
|----------------------------|-----------------------------|
| Product name: | dollarfix DF51, ECHO |
| Model name: | TDFD |
| Series Model: | / |
| Different of series model: | N/A |
| Operation frequency: | 2402-2480MHz |
| Modulation type: | GFSK, $\pi/4$ -DQPSK, 8DPSK |
| Bit Rate of transmitter: | 1 Mbps, 2Mbps, 3Mbps |
| Antenna type: | FPCB Antenna |
| Antenna gain: | 2.18dBi |
| Max. output power: | -1.96dBm |
| Hardware version: | V1.0 |
| Software version: | V1.0 |
| Power supply: | DC 8~24V |
| Adapter information: | N/A |

1.2 Test Mode

| Test Mode | Channel | Frequency (MHz) |
|-----------|---------|-----------------|
| 1 | 00 | 2402 |
| 2 | 39 | 2441 |
| 3 | 78 | 2480 |

1.3 Operation Channel List

| Channel | Frequency (MHz) | Channel | Frequency (MHz) | Channel | Frequency (MHz) |
|---------|-----------------|---------|-----------------|---------|-----------------|
| 00 | 2402 | 27 | 2429 | 54 | 2456 |
| 01 | 2403 | 28 | 2430 | 55 | 2457 |
| 02 | 2404 | 29 | 2431 | 56 | 2458 |
| 03 | 2405 | 30 | 2432 | 57 | 2459 |
| 04 | 2406 | 31 | 2433 | 58 | 2460 |
| 05 | 2407 | 32 | 2434 | 59 | 2461 |

| | | | | | |
|----|------|----|------|----|------|
| 06 | 2408 | 33 | 2435 | 60 | 2462 |
| 07 | 2409 | 34 | 2436 | 61 | 2463 |
| 08 | 2410 | 35 | 2437 | 62 | 2464 |
| 09 | 2411 | 36 | 2438 | 63 | 2465 |
| 10 | 2412 | 37 | 2439 | 64 | 2466 |
| 11 | 2413 | 38 | 2440 | 65 | 2467 |
| 12 | 2414 | 39 | 2441 | 66 | 2468 |
| 13 | 2415 | 40 | 2442 | 67 | 2469 |
| 14 | 2416 | 41 | 2443 | 68 | 2470 |
| 15 | 2417 | 42 | 2444 | 69 | 2471 |
| 16 | 2418 | 43 | 2445 | 70 | 2472 |
| 17 | 2419 | 44 | 2446 | 71 | 2473 |
| 18 | 2420 | 45 | 2447 | 72 | 2474 |
| 19 | 2421 | 46 | 2448 | 73 | 2475 |
| 20 | 2422 | 47 | 2449 | 74 | 2476 |
| 21 | 2423 | 48 | 2450 | 75 | 2477 |
| 22 | 2424 | 49 | 2451 | 76 | 2478 |
| 23 | 2425 | 50 | 2452 | 77 | 2479 |
| 24 | 2426 | 51 | 2453 | 78 | 2480 |
| 25 | 2427 | 52 | 2454 | -- | -- |
| 26 | 2428 | 53 | 2455 | -- | -- |

1.4 Test Setup

See photographs of the test setup in the report for the actual setup and connections between EUT and support equipment.

1.5 Ancillary Equipment

| Equipment | Model | S/N | Manufacturer |
|-------------------------|-------------|-----|--------------|
| Vehicle simulation unit | THINKCAR-01 | / | THINKCAR |

| Equipment | Length (cm) | Shielded/Unshielded | With/Without Ferrite |
|-----------|-------------|---------------------|----------------------|
| | | | |

2 Summary of Test Result

| No. | Standard Section | Test Item | Result | Remark |
|-----|------------------|---------------------------------|--------|--------|
| 1 | 15.203 | Antenna requirement | Pass | |
| 2 | 15.207 | Conducted emission | N/A | |
| 3 | 15.247(d) | Band edge | Pass | |
| 4 | 15.205/15.209 | Spurious emission | Pass | |
| 5 | 15.247(b)(1) | Peak output power | Pass | |
| 6 | 15.247(a)(1) | 20dB occupied bandwidth | Pass | |
| 7 | 15.247(a)(1) | Carrier Frequencies Separation | Pass | |
| 8 | 15.247(a)(1) | Hopping channel number | Pass | |
| 9 | 15.247(a)(1) | Dwell time | Pass | |
| 10 | 15.247(d) | Spurious RF Conducted Emissions | Pass | |

3 Test Facilities and Accreditations

3.1 Test Laboratory

| | |
|-----------------------|---|
| Test Site | Shenzhen HongBiao Certification& Testing Co., Ltd |
| Test Site Location | Room 102, 201, Building 2, Yuanwanggu RFID Industrial Park, Tongguan Road, Tianliao Community, Yutang Street, Guangming District, Shenzhen, China |
| Telephone: | (86-755) 2998 9321 |
| Fax: | (86-755) 2998 5110 |
| FCC Registration No.: | CN1341 |
| A2LA Certificate No.: | 6765.01 |

3.2 Environmental Conditions

During the measurement the environmental conditions were within the listed ranges:

| | |
|--------------------|--------------|
| Temperature: | 15°C~35°C |
| Relative Humidity: | 20%~75% |
| Air Pressure: | 98kPa~101kPa |

3.3 Measurement Uncertainty

The reported uncertainty of measurement $y \pm U$, where expanded uncertainty U is based on a standard uncertainty multiplied by a coverage factor of $k=2$, providing a level of confidence of approximately 95 %.

| Measurement Frequency Range | U, (dB) | Note |
|----------------------------------|--------------------|------|
| RF frequency | 2×10^{-5} | |
| RF power, conducted | ± 0.57 dB | |
| Conducted emission(150kHz~30MHz) | ± 2.5 dB | |
| Radiated emission(30MHz~1GHz) | ± 4.2 dB | |
| Radiated emission (above 1GHz) | ± 4.7 dB | |
| Temperature | ± 1 degree | |
| Humidity | ± 5 % | |

3.4 Test Software

| Software name | Manufacturer | Model | Version |
|-----------------------|--------------|----------|----------|
| EMI Measurement | Farad | EZ-EMC | V1.1.4.2 |
| Conducted test system | MWRF-test | MTS 8310 | V2.0.0 |

4 List of Test Equipment

| Radiation emission | | | | | | | |
|---------------------|---------------|--|--------------|-------------|--------------|------------------|------------|
| Item | Equipment No. | Equipment name | Manufacturer | Model | Serial No. | Calibration date | Due date |
| 1 | HB-E001 | Horn Antenna | Schwarzbeck | BBHA 9120D | 02592 | 2022-04-02 | 2024-04-01 |
| 2 | HB-E002 | Biconical log-periodic composite antenna | Schwarzbeck | VULB 9168 | 01340 | 2022-04-06 | 2024-04-05 |
| 3 | HB-E003 | SHF-EHF Horn | Schwarzbeck | BBHA 91270 | 01193 | 2022-04-02 | 2024-04-01 |
| 4 | HB-E004 | Preamplifier | Noyetec | LAN-0910 | NYCM1420101 | 2023-05-11 | 2024-05-10 |
| 5 | HB-E005 | Preamplifier | Noyetec | LAN-0118 | NYCM1420102 | 2023-05-12 | 2024-05-11 |
| 6 | HB-E006 | Preamplifier | Noyetec | LAN-1840 | NYCM1420103 | 2023-06-11 | 2024-06-10 |
| 7 | HB-E007 | EMI TEST RECEIVER | R&S | ESR7 | 102520 | 2023-05-12 | 2024-05-11 |
| 8 | HB-E009 | POSITINAL COTROLLE R | Noyetec | N/A | N/A | / | / |
| 9 | HB-E013 | RF switch | Noyetec | NY-RF4 | NY0CM1420204 | / | / |
| 10 | HB-E066 | Illuminance Tester | TASI | TA8121 | N/A | 2023-05-11 | 2024-05-10 |
| 11 | HB-E075 | Active loop antenna | Schwarzbeck | FMZB 1519B | 1519B-245 | 2022-07-24 | 2024-07-23 |
| Conduction emission | | | | | | | |
| Item | Equipment No. | Equipment name | Manufacturer | Model | Serial No. | Calibration date | Due date |
| 1 | HB-E014 | 4 Path V-LISN | Schwarzbeck | NNLK 8121 | 00770 | 2023-05-12 | 2024-05-11 |
| 2 | HB-E015 | Pulse Limiter | Schwarzbeck | VTSD 9561-F | 00949 | 2023-05-12 | 2024-05-11 |
| 3 | HB-E016 | ZN23201 | Noyetec | ZN23201 | N/A | 2023-05-11 | 2024-05-10 |
| 4 | HB-E059 | Attenuator | Xianghua | TS2-6-1 | 220215166 | 2023-05-12 | 2024-05-11 |
| 5 | HB-E069 | EMI TEST RECEIVER | R&S | ESCI | N/A | 2023-05-12 | 2024-05-11 |
| RF | | | | | | | |
| Item | Equipment No. | Equipment name | Manufacturer | Model | Serial No. | Calibration date | Due date |
| 1 | HB-E041 | MXG Anaioq Signal Generator | Agilent | N5181A | MY47070421 | 2023-05-11 | 2024-05-10 |
| 2 | HB-E042 | WIDEBAND RADIO COMMUNICA | R&S | CMW500 | 132108 | 2023-05-11 | 2024-05-10 |

| | | TION TESTER | | | | | |
|---|---------|--|---------|----------------|------------|------------|------------|
| 3 | HB-E043 | MXG Anaio Signal Generator | Agilent | N5182A | US46240335 | 2023-05-11 | 2024-05-10 |
| 4 | HB-E044 | Signal& spectrum Analyzer | R&S | FSV3044 | 101264 | 2023-05-11 | 2024-05-10 |
| 5 | HB-E045 | RF Control Box | Noyetec | NY100-R FCB | N/A | / | / |
| 6 | HB-E058 | Thermometer Clock Humidity Monitor | N/A | HTC-1 | N/A | / | / |
| 7 | HB-E077 | PXA Signal Analyzer | Agilent | N9030A | N/A | 2023-05-11 | 2024-05-10 |

Note: the calibration interval of the above test instruments is 12&24 months and the calibrations are traceable to international system unit (SI).

5 Test Item And Results

5.1 Antenna Requirement

5.1.1 Standard Requirement

15.203 requirement: For intentional device, according to 15.203: an intentional radiator shall be designed to ensure that no antenna other than that furnished by the responsible party shall be used with the device

5.1.2 Test Result

The EUT antenna is FPCB Antenna. It comply with the standard requirement. In case of replacement of broken antenna the same antenna type must be used.

5.2 Conducted Emission

5.2.1 Limits

| Limits – Class B | | |
|------------------|--------------------|-----------|
| Frequency (MHz) | Limit (dB μ V) | |
| | Quasi-Peak | Average |
| 0.15 to 0.5 | 66 to 56* | 56 to 46* |
| 0.5 to 5 | 56 | 46 |
| 5 to 30 | 60 | 50 |

Note:

- the tighter limit applies at the band edges.
- the limit of " * " marked band means the limitation decreases linearly with the logarithm of the frequency in the range.

5.2.2 Test Procedures

a) EUT Operating Conditions

The EUT was configured for testing in a typical fashion (as a customer would normally use it). The EUT has been programmed to continuously transmit during test. This operating condition was tested and used to collect the included data.

b) The following table is the setting of the receiver

| Receiver Parameters | Setting |
|---------------------|----------|
| Attenuation | 10 dB |
| Start Frequency | 0.15 MHz |
| Stop Frequency | 30 MHz |
| IF Bandwidth | 9 kHz |

- The EUT was placed 0.8 meters from the horizontal ground plane with EUT being connected to the power mains through a line impedance stabilization network (LISN). All other support equipment powered from additional LISN(s). The LISN provide 50 Ohm/ 50uH of coupling impedance for the measuring instrument.
- Interconnecting cables that hang closer than 40 cm to the ground plane shall be folded back and forth in the center forming a bundle 30 to 40 cm long.
- I/O cables that are not connected to a peripheral shall be bundled in the center. The end of the cable may be terminated, if required, using the correct terminating impedance. The overall length shall not exceed 1 m.
- LISN is at least 80 cm from nearest part of EUT chassis.
- For the actual test configuration, please refer to the related Item – photographs of the test setup.

5.2.3 Test Setup

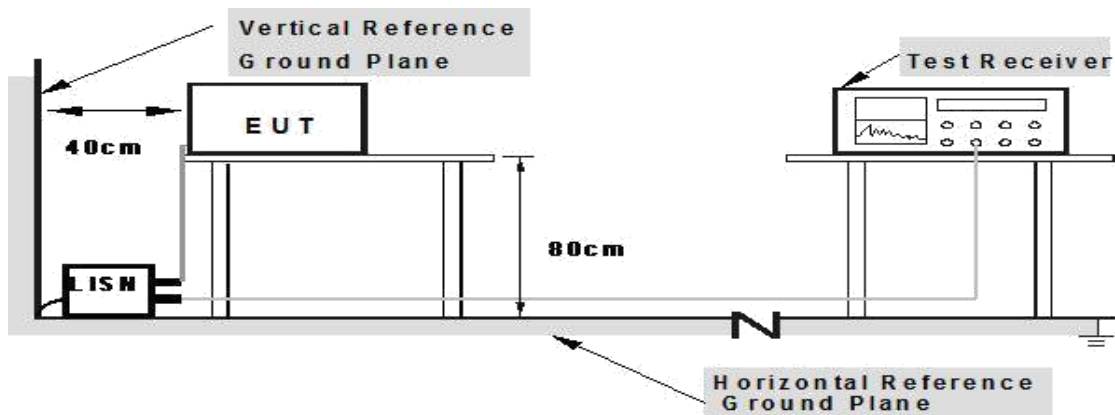

5.2.4 Test Result

Because the product power is supply through DC 8~24V by car, so not applicable.

5.3 Radiated Emission

5.3.1 Limits

| Frequencies (MHz) | Field Strength (micovolts/meter) | Measurement Distance (meters) |
|-------------------|----------------------------------|-------------------------------|
| 0.009~0.490 | 2400/F(KHz) | 300 |
| 0.490~1.705 | 24000/F(KHz) | 30 |
| 1.705~30.0 | 30 | 30 |
| 30~88 | 100 | 3 |
| 88~216 | 150 | 3 |
| 216~960 | 200 | 3 |
| Above 960 | 500 | 3 |

| Receiver Parameter | Setting |
|------------------------|----------------------------------|
| Attenuation | Auto |
| Start ~ Stop Frequency | 9kHz~150kHz / RB 200Hz for QP |
| Start ~ Stop Frequency | 150kHz~30MHz / RB 9kHz for QP |
| Start ~ Stop Frequency | 30MHz~1000MHz / RB 120kHz for QP |

5.3.2 Test Procedures

- a) The radiated emission tests were performed in the 3 meters.
- b) The EUT was placed on the top of a rotating table 0.8 meters above the ground. The table was rotated 360 degrees to determine the position of the highest radiation.
- c) The height of the test antenna shall vary between 1m to 4m. Both horizontal and vertical polarizations of the antenna are set to make the measurement.
- d) If the peak mode measured value compliance with and lower than quasi peak mode limit, the EUT shall be deemed to meet QP limits and then no additional QP mode measurement performed.
- e) If the peak mode measured value compliance with and lower than average mode limit, the EUT shall be deemed to meet average limits and then no additional average mode measurement performed.
- f) For the actual test configuration, please refer to the related item – EUT test photos.

5.3.3 Test Setup

Radiated Emission Test-Up Frequency Below 30MHz

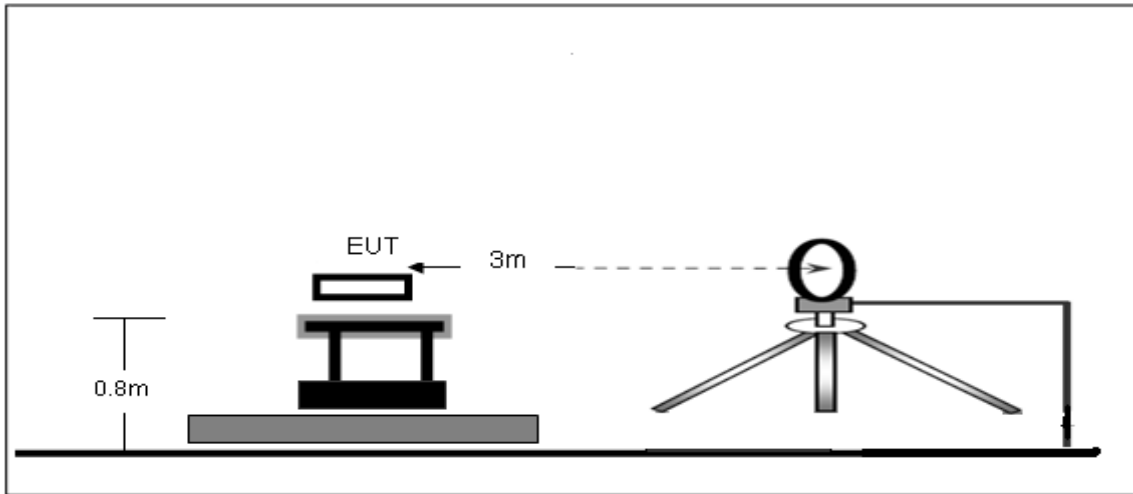

Radiated Emission Test-Up Frequency 30MHz~1GHz

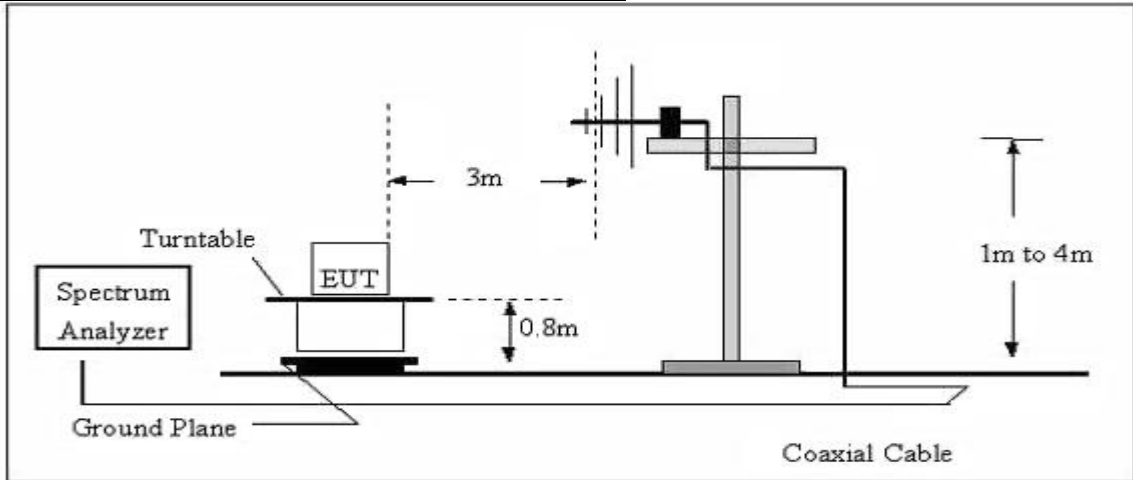

Radiated emission test-up frequency above 1GHz

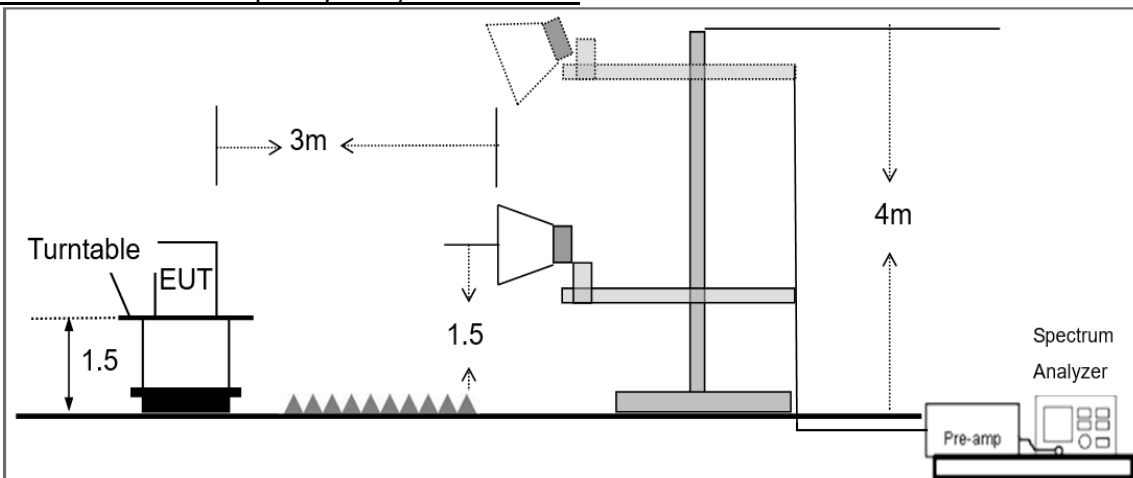

5.3.4 Test Result

Below 30MHz

| | | | |
|------------|----------------------|---------------|--------------|
| EUT: | dollarfix DF51, ECHO | Model Name: | TDFD |
| Pressure: | 1010 hPa | Test Voltage: | AC 120V/60Hz |
| Test Mode: | TX | Polarization: | -- |

| Freq. | Reading | Limit | Margin | State |
|-------|----------|----------|--------|-------|
| (MHz) | (dBuV/m) | (dBuV/m) | (dB) | P/F |
| -- | -- | -- | -- | Pass |
| -- | -- | -- | -- | Pass |

Note:

1. For 9kHz-30MHz, the amplitude of spurious emissions which are attenuated by more than 20dB below the permissible value has no need to be reported.
2. Distance extrapolation factor = $40 \log (\text{specific distance}/\text{test distance})$ (dB);
3. Limit line = specific limits (dBuV) + distance extrapolation factor.

30MHz – 1GHz

| | | | |
|---------------|----------------------|-------------|------------|
| EUT: | dollarfix DF51, ECHO | Model Name: | TDFD |
| Test Mode: | TX | Phase : | Horizontal |
| Test Voltage: | AC 120V/60Hz | | |

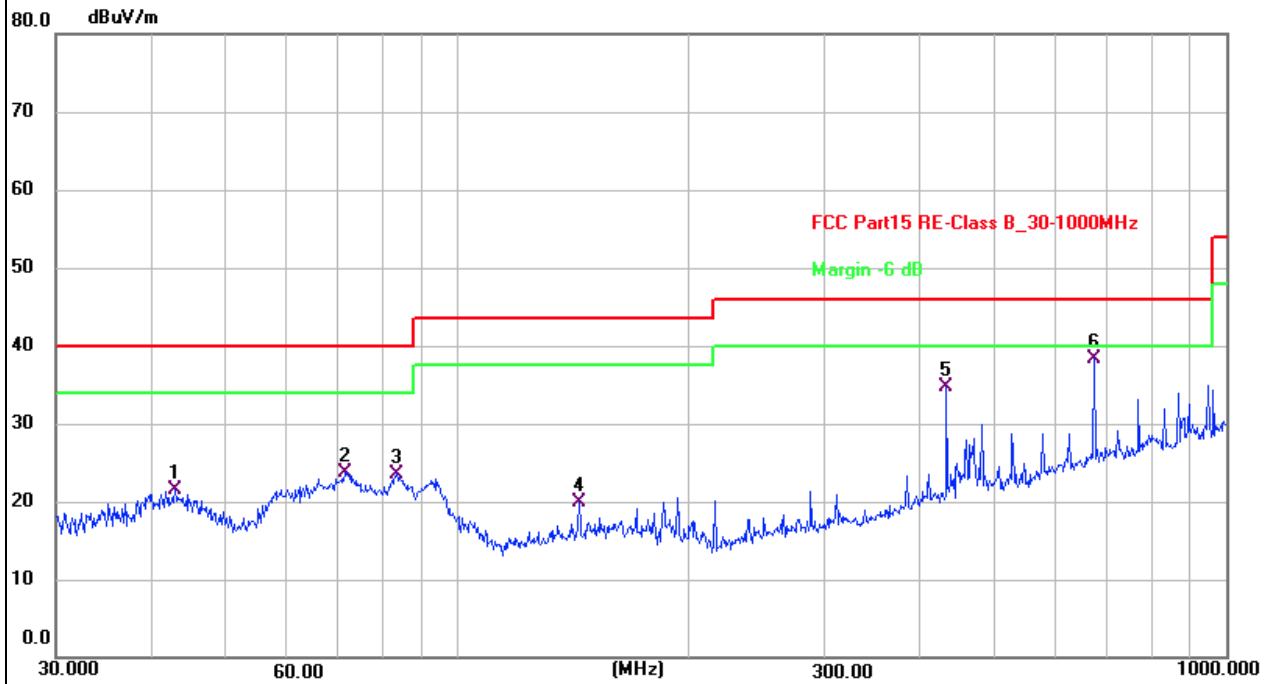

| No. | Frequency (MHz) | Reading (dBuV) | Factor (dB/m) | Level (dBuV/m) | Limit (dBuV/m) | Margin (dB) | Detector | Height (cm) | Azimuth (deg.) | P/F | Remark |
|-----|-----------------|----------------|---------------|----------------|----------------|-------------|----------|-------------|----------------|-----|--------|
| 1 | 42.8998 | 30.28 | -8.84 | 21.44 | 40.00 | -18.56 | QP | 200 | 199 | P | |
| 2 | 71.3300 | 35.05 | -11.27 | 23.78 | 40.00 | -16.22 | QP | 100 | 154 | P | |
| 3 | 83.2298 | 37.01 | -13.41 | 23.60 | 40.00 | -16.40 | QP | 200 | 316 | P | |
| 4 | 143.8295 | 29.07 | -9.12 | 19.95 | 43.50 | -23.55 | QP | 200 | 18 | P | |
| 5 | 432.5457 | 40.16 | -5.41 | 34.75 | 46.00 | -11.25 | QP | 100 | 122 | P | |
| 6 * | 672.8444 | 38.22 | 0.05 | 38.27 | 46.00 | -7.73 | QP | 200 | 348 | P | |

Remarks:

1. Measurement Level = Reading level + Correct Factor, Margin = Measurement Level – Limit.
2. The emission levels of other frequencies are very lower than the limit and not show in test report.
3. All test modes were pre-tested, but we only recorded the worst case in this report.

| | | | |
|---------------|----------------------|-------------|----------|
| EUT: | dollarfix DF51, ECHO | Model Name: | TDFD |
| Test Mode: | TX | Phase : | Vertical |
| Test Voltage: | AC 120V/60Hz | | |

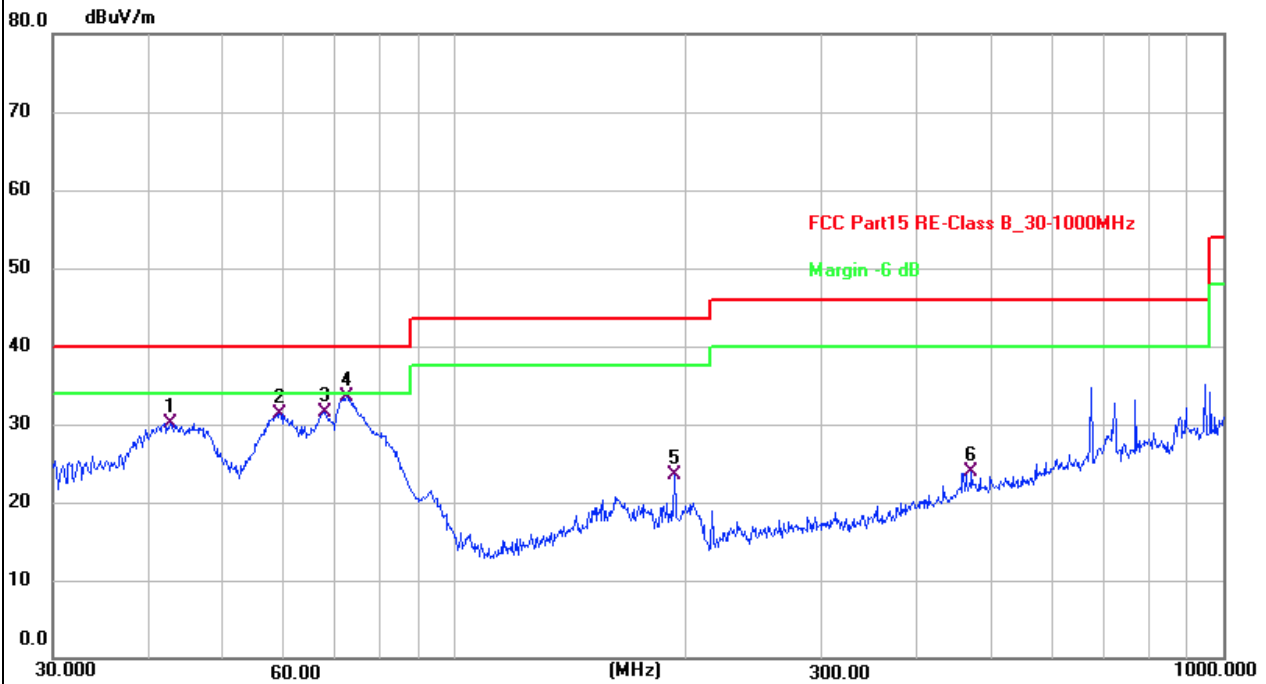

| No. | Frequency (MHz) | Reading (dBuV) | Factor (dB/m) | Level (dBuV/m) | Limit (dBuV/m) | Margin (dB) | Detector | Height (cm) | Azimuth (deg.) | P/F | Remark |
|-----|-----------------|----------------|---------------|----------------|----------------|-------------|----------|-------------|----------------|-----|--------|
| 1 | 42.6000 | 38.89 | -8.77 | 30.12 | 40.00 | -9.88 | QP | 100 | 12 | P | |
| 2 | 59.2325 | 41.21 | -9.84 | 31.37 | 40.00 | -8.63 | QP | 100 | 123 | P | |
| 3 | 67.6751 | 42.27 | -10.70 | 31.57 | 40.00 | -8.43 | QP | 200 | 1 | P | |
| 4 * | 72.3376 | 45.10 | -11.52 | 33.58 | 40.00 | -6.42 | QP | 100 | 353 | P | |
| 5 | 193.0945 | 35.73 | -12.19 | 23.54 | 43.50 | -19.96 | QP | 100 | 32 | P | |
| 6 | 470.5232 | 28.42 | -4.61 | 23.81 | 46.00 | -22.19 | QP | 200 | 348 | P | |

Remarks:

1. Mesurement Level = Reading level + Correct Factor, Margin = Mesurement Level – Limit.
2. The emission levels of other frequencies are very lower than the limit and not show in test report.
3. All test modes were pre-tested, but we only recorded the worst case in this report.

1GHz-25GHz

| Frequency | Read Level | Cable loss | Antenna Factor | Preamp Factor | Emission Level | Limits | Margin | Remark | Comment |
|--|--------------|------------|----------------|---------------|----------------|----------------|--------|--------|------------|
| (MHz) | (dB μ V) | (dB) | dB/m | (dB) | (dB μ V/m) | (dB μ V/m) | (dB) | | |
| Low Channel (2402 MHz)(GFSK)--Above 1G | | | | | | | | | |
| 4804 | 64.91 | 5.21 | 35.59 | 44.30 | 61.41 | 74.00 | -12.59 | Pk | Vertical |
| 4804 | 50.77 | 5.21 | 35.59 | 44.30 | 47.27 | 54.00 | -6.73 | AV | Vertical |
| 7206 | 59.67 | 6.48 | 36.27 | 44.60 | 57.82 | 74.00 | -16.18 | Pk | Vertical |
| 7206 | 44.41 | 6.48 | 36.27 | 44.60 | 42.56 | 54.00 | -11.44 | AV | Vertical |
| 4804 | 65.33 | 5.21 | 35.55 | 44.30 | 61.79 | 74.00 | -12.21 | Pk | Horizontal |
| 4804 | 51.55 | 5.21 | 35.55 | 44.30 | 48.01 | 54.00 | -5.99 | AV | Horizontal |
| 7206 | 59.39 | 6.48 | 36.27 | 44.52 | 57.62 | 74.00 | -16.38 | Pk | Horizontal |
| 7206 | 44.76 | 6.48 | 36.27 | 44.52 | 42.99 | 54.00 | -11.01 | AV | Horizontal |
| Mid Channel (2441 MHz)(GFSK)--Above 1G | | | | | | | | | |
| 4882 | 64.70 | 5.21 | 35.66 | 44.20 | 61.37 | 74.00 | -12.63 | Pk | Vertical |
| 4882 | 51.77 | 5.21 | 35.66 | 44.20 | 48.44 | 54.00 | -5.56 | AV | Vertical |
| 7323 | 59.43 | 7.10 | 36.50 | 44.43 | 58.60 | 74.00 | -15.40 | Pk | Vertical |
| 7323 | 44.19 | 7.10 | 36.50 | 44.43 | 43.36 | 54.00 | -10.64 | AV | Vertical |
| 4882 | 64.90 | 5.21 | 35.66 | 44.20 | 61.57 | 74.00 | -12.43 | Pk | Horizontal |
| 4882 | 49.46 | 5.21 | 35.66 | 44.20 | 46.13 | 54.00 | -7.87 | AV | Horizontal |
| 7323 | 59.77 | 7.10 | 36.50 | 44.43 | 58.94 | 74.00 | -15.06 | Pk | Horizontal |
| 7323 | 44.03 | 7.10 | 36.50 | 44.43 | 43.20 | 54.00 | -10.80 | AV | Horizontal |
| High Channel (2480 MHz)(GFSK)-- Above 1G | | | | | | | | | |
| 4960 | 65.95 | 5.21 | 35.52 | 44.21 | 62.47 | 74.00 | -11.53 | Pk | Vertical |
| 4960 | 49.62 | 5.21 | 35.52 | 44.21 | 46.14 | 54.00 | -7.86 | AV | Vertical |
| 7440 | 59.12 | 7.10 | 36.53 | 44.60 | 58.15 | 74.00 | -15.85 | Pk | Vertical |
| 7440 | 45.93 | 7.10 | 36.53 | 44.60 | 44.96 | 54.00 | -9.04 | AV | Vertical |
| 4960 | 66.74 | 5.21 | 35.52 | 44.21 | 63.26 | 74.00 | -10.74 | Pk | Horizontal |
| 4960 | 51.12 | 5.21 | 35.52 | 44.21 | 47.64 | 54.00 | -6.36 | AV | Horizontal |
| 7440 | 58.75 | 7.10 | 36.53 | 44.60 | 57.78 | 74.00 | -16.22 | Pk | Horizontal |
| 7440 | 45.84 | 7.10 | 36.53 | 44.60 | 44.87 | 54.00 | -9.13 | AV | Horizontal |

Note:

1. All Readings are Peak Value (VBW=3MHz) and AV Value (VBW=10Hz).
2. Emission Level= Antenna Factor + Cable Loss + Read Level - Preamp Factor.
3. All the modulation modes have been tested, and only the worst results are reflected in the report.

5.3.5 Radiated Band Edge

| Frequency | Meter Reading | Cable Loss | Antenna Factor | Preamplifier Factor | Emission Level | Limits | Margin | Detector | Comment |
|--------------------------|---------------|------------|----------------|---------------------|----------------|----------|--------|----------|------------|
| (MHz) | (dBμV) | (dB) | dB/m | (dB) | (dBμV/m) | (dBμV/m) | (dB) | Type | |
| 1Mbps(GFSK)- Non-hopping | | | | | | | | | |
| 2310.00 | 57.38 | 2.40 | 27.70 | 40.40 | 47.08 | 74.00 | -26.92 | Pk | Horizontal |
| 2310.00 | 43.64 | 2.40 | 27.70 | 40.40 | 33.34 | 54.00 | -20.66 | AV | Horizontal |
| 2310.00 | 59.33 | 2.40 | 27.70 | 40.40 | 49.03 | 74.00 | -24.97 | Pk | Vertical |
| 2310.00 | 43.73 | 2.40 | 27.70 | 40.40 | 33.43 | 54.00 | -20.57 | AV | Vertical |
| 2390.00 | 59.78 | 2.44 | 28.30 | 40.10 | 50.42 | 74.00 | -23.58 | Pk | Vertical |
| 2390.00 | 41.91 | 2.44 | 28.30 | 40.10 | 32.55 | 54.00 | -21.45 | AV | Vertical |
| 2390.00 | 59.94 | 2.44 | 28.30 | 40.10 | 50.58 | 74.00 | -23.42 | Pk | Horizontal |
| 2390.00 | 42.89 | 2.44 | 28.30 | 40.10 | 33.53 | 54.00 | -20.47 | AV | Horizontal |
| 2483.50 | 58.66 | 2.48 | 28.70 | 39.80 | 50.04 | 74.00 | -23.96 | Pk | Vertical |
| 2483.50 | 42.14 | 2.48 | 28.70 | 39.80 | 33.52 | 54.00 | -20.48 | AV | Vertical |
| 2483.50 | 57.65 | 2.48 | 28.70 | 39.80 | 49.03 | 74.00 | -24.97 | Pk | Horizontal |
| 2483.50 | 43.19 | 2.48 | 28.70 | 39.80 | 34.57 | 54.00 | -19.43 | AV | Horizontal |
| 2500.00 | 57.80 | 2.48 | 28.70 | 39.80 | 49.18 | 74.00 | -24.82 | Pk | Vertical |
| 2500.00 | 41.06 | 2.48 | 28.70 | 39.80 | 32.44 | 54.00 | -21.56 | AV | Vertical |
| 2500.00 | 58.32 | 2.48 | 28.70 | 39.80 | 49.70 | 74.00 | -24.30 | Pk | Horizontal |
| 2500.00 | 43.95 | 2.48 | 28.70 | 39.80 | 35.33 | 54.00 | -18.67 | AV | Horizontal |

Note:

1. All Readings are Peak Value (VBW=3MHz) and AV Value (VBW=10Hz).
2. Emission Level= Antenna Factor + Cable Loss + Read Level - Preamp Factor.
3. All the modulation modes have been tested, and only the worst results are reflected in the report.

5.4 Peak Output Power

5.4.1 Limit

| FCC Part15 Subpart C | | | |
|----------------------|-------------------|-----------------|-----------------------|
| Section | Test Item | Limit | Frequency Range (MHz) |
| 15.247(b)(1) | Peak output power | Power<1W(30dBm) | 2400-2483.5 |

5.4.2 Test Procedure

- (1) The EUT was directly connected to the spectrum analyzer and antenna output port as show in the block diagram above.
- (2) Spectrum Setting:
 RBW=1MHz, VBW=3MHz, Detector=Peak (If 20dB BW ≤1 MHz)
 RBW=3MHz, VBW=8MHz, Detector=Peak (If 20dB BW > 1 MHz)
- (3) The EUT was set to continuously transmitting in the max power during the test.

5.4.3 Test Setup

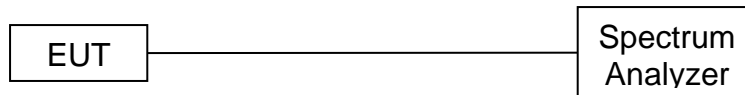

5.4.4 Test Results

| | | | |
|------------|---------------------------|---------------|--------------|
| EUT: | dollarfix DF51, ECHO | Model Name: | TDFD |
| Test Mode: | TX Mode /CH00, CH39, CH78 | Test Voltage: | AC 120V/60Hz |

GFSK

| Test Channel | Frequency (MHz) | Maximum Peak Output Power(dBm) | Limit (dBm) |
|--------------|-----------------|--------------------------------|-------------|
| CH00 | 2402 | -2.48 | 20.97 |
| CH39 | 2441 | -3.16 | 20.97 |
| CH78 | 2480 | -4.01 | 20.97 |

$\pi/4$ -DQPSK

| Test Channel | Frequency (MHz) | Maximum Peak Output Power(dBm) | Limit (dBm) |
|--------------|-----------------|--------------------------------|-------------|
| CH00 | 2402 | -2.25 | 20.97 |
| CH39 | 2441 | -2.86 | 20.97 |
| CH78 | 2480 | -3.83 | 20.97 |

8DPSK

| Test Channel | Frequency (MHz) | Maximum Peak Output Power(dBm) | Limit (dBm) |
|--------------|-----------------|--------------------------------|-------------|
| CH00 | 2402 | -1.96 | 20.97 |
| CH39 | 2441 | -2.55 | 20.97 |
| CH78 | 2480 | -3.52 | 20.97 |

5.5 20dB Occupied Channel Bandwidth

5.5.1 Limit

| FCC Part15 (15.247) , Subpart C | | | |
|---------------------------------|----------------|-------|-----------------------|
| Section | Test Item | Limit | Frequency Range (MHz) |
| 15.247a(1) | 20dB bandwidth | N/A | 2400-2483.5 |

5.5.2 Test Procedure

- (1) The EUT was directly connected to the spectrum analyzer and antenna output port as show in the block diagram above.
- (2) Spectrum Setting:
Bandwidth: RBW=30 kHz, VBW=100 kHz, detector= Peak

5.5.3 Test Setup

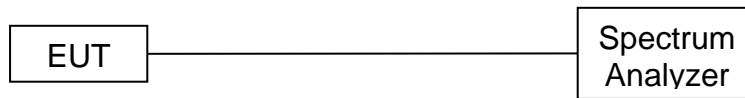

5.5.4 Test results

| | | | |
|------------|---------------------------|---------------|--------------|
| EUT: | dollarfix DF51, ECHO | Model Name: | TDFD |
| Test Mode: | TX Mode /CH00, CH39, CH78 | Test Voltage: | AC 120V/60Hz |

| Mode | Frequency (MHz) | 20dB Bandwidth (MHz) | 99% Occupied Bandwidth (MHz) | Result |
|----------------|-----------------|----------------------|------------------------------|--------|
| GFSK | 2402 | 0.9561 | 0.89029 | Pass |
| | 2441 | 0.9517 | 0.88673 | Pass |
| | 2480 | 0.9546 | 0.8882 | Pass |
| π /4-DQPSK | 2402 | 1.324 | 1.1788 | Pass |
| | 2441 | 1.327 | 1.1925 | Pass |
| | 2480 | 1.307 | 1.1728 | Pass |
| 8DPSK | 2402 | 1.3 | 1.1844 | Pass |
| | 2441 | 1.294 | 1.1861 | Pass |
| | 2480 | 1.294 | 1.1899 | Pass |

Test plots

GFSK mode

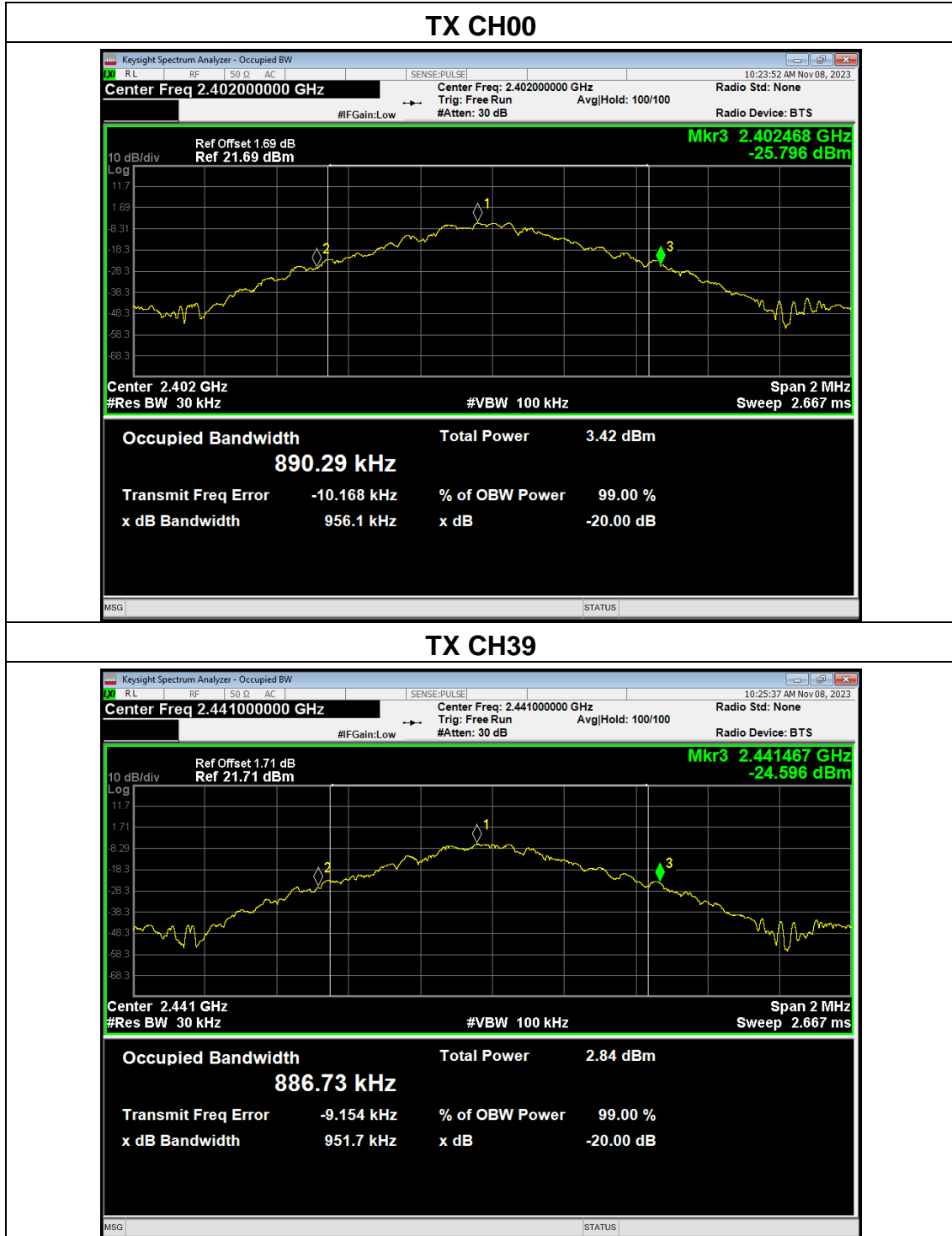

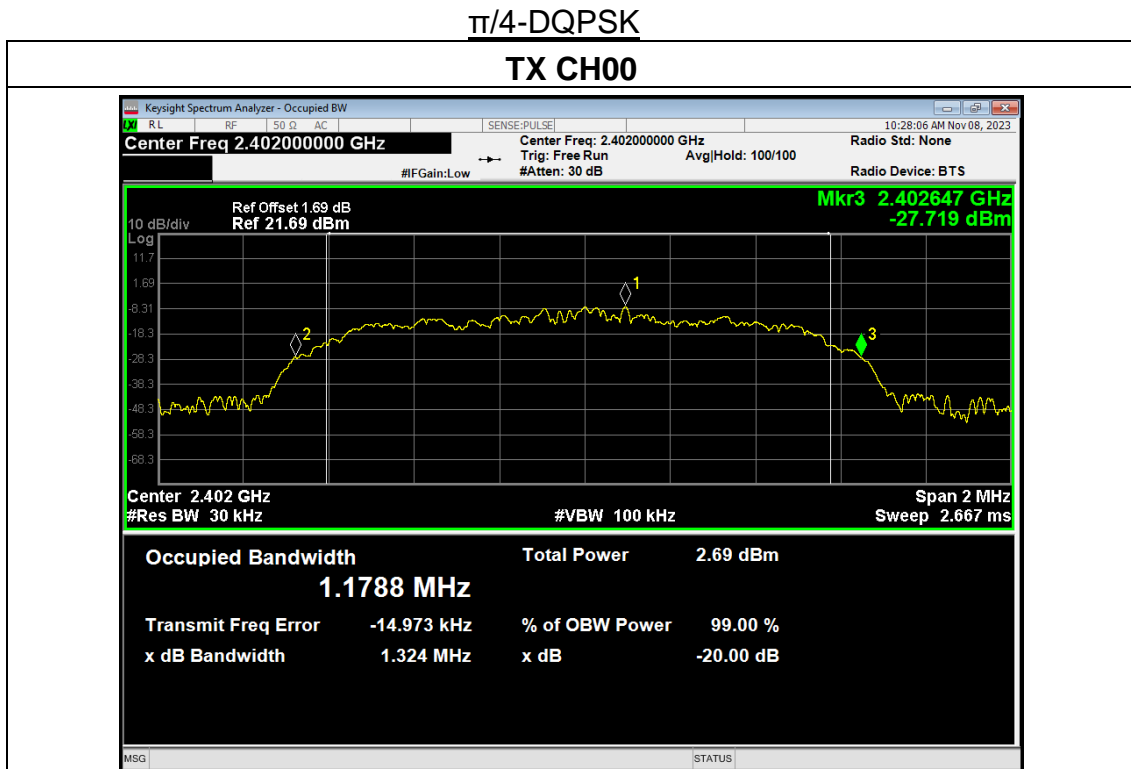
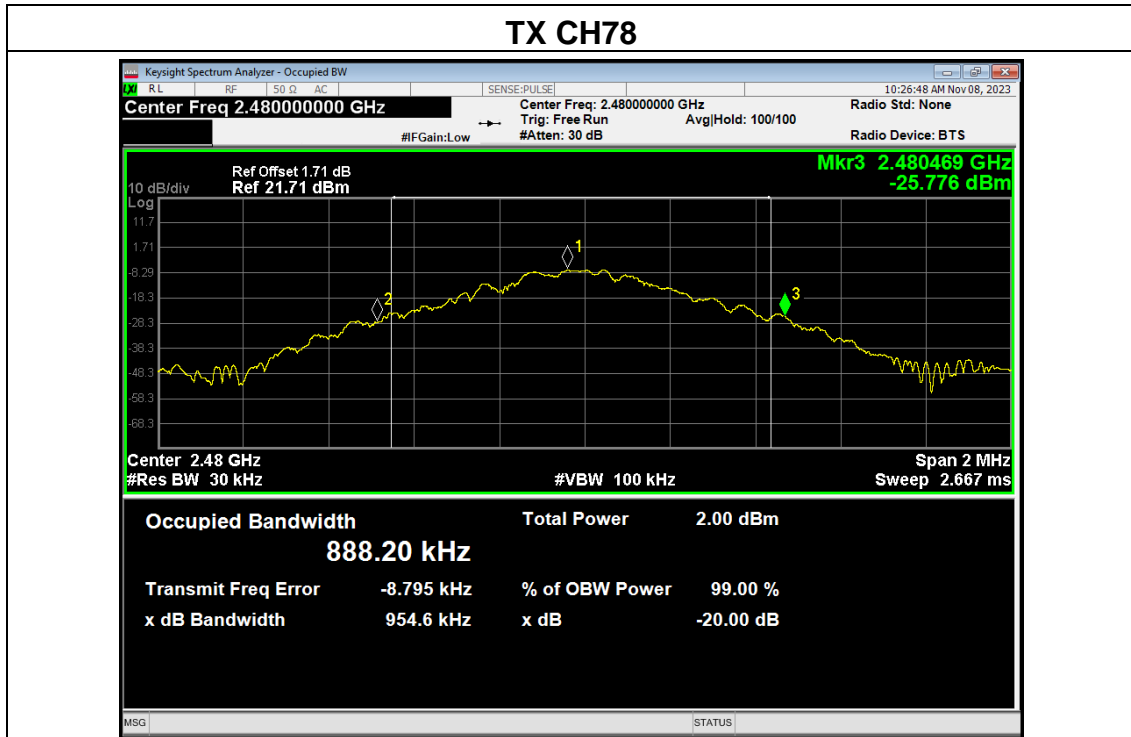

TX CH39

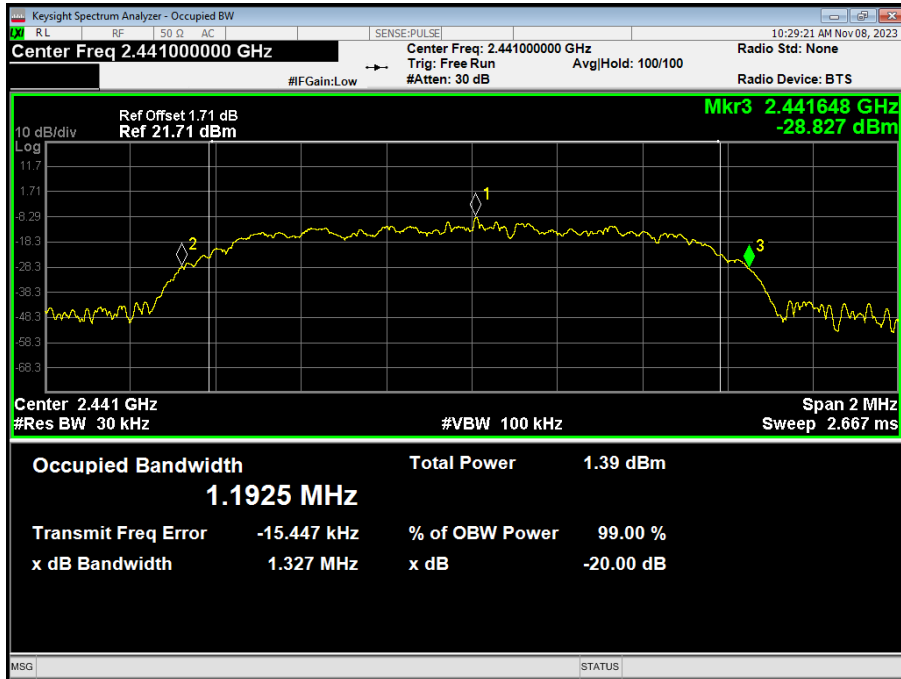

TX CH78

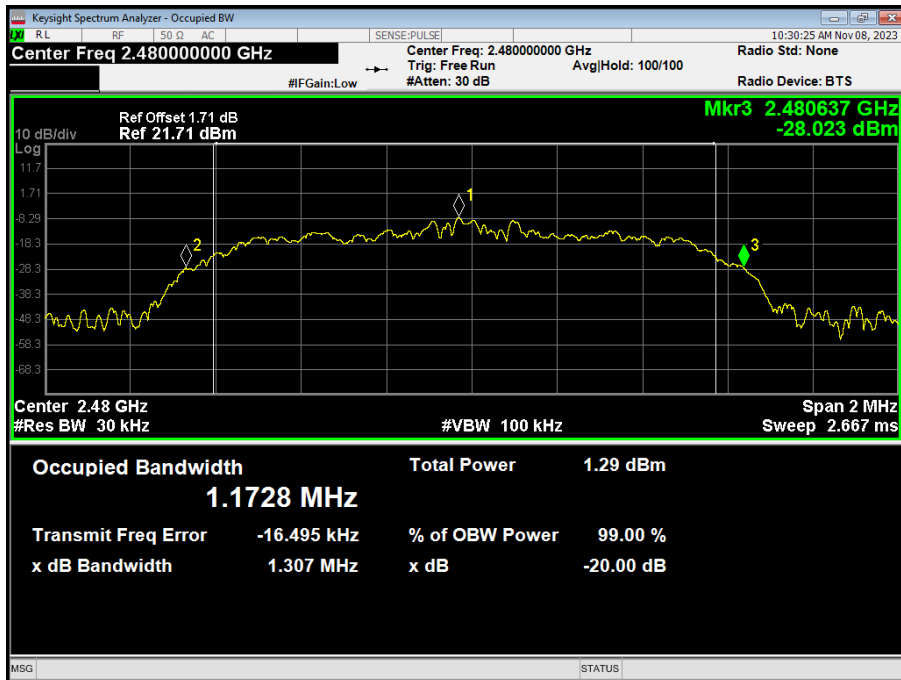

8DPSK mode

TX CH00

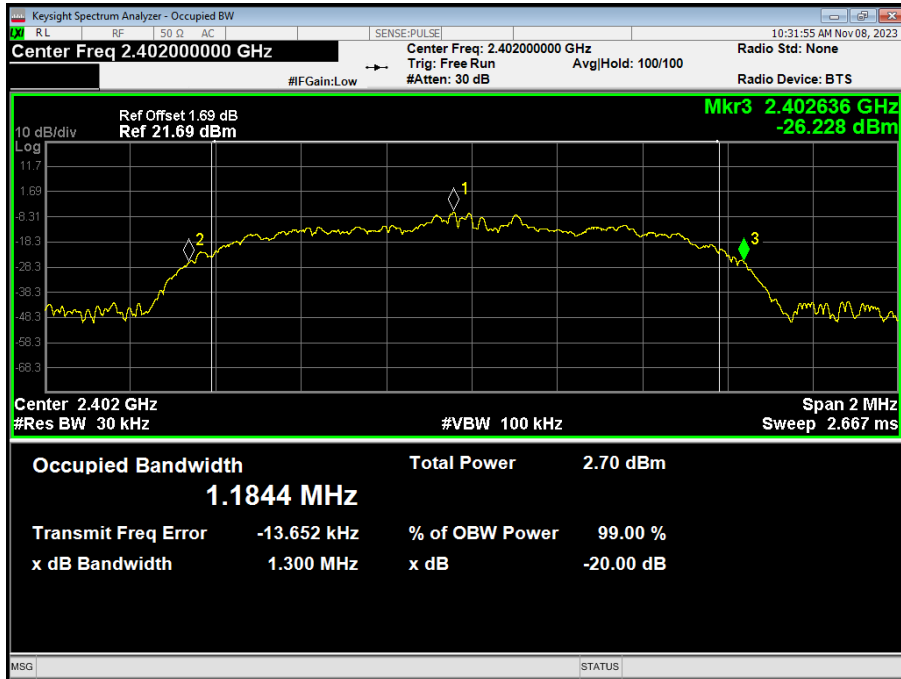

TX CH39

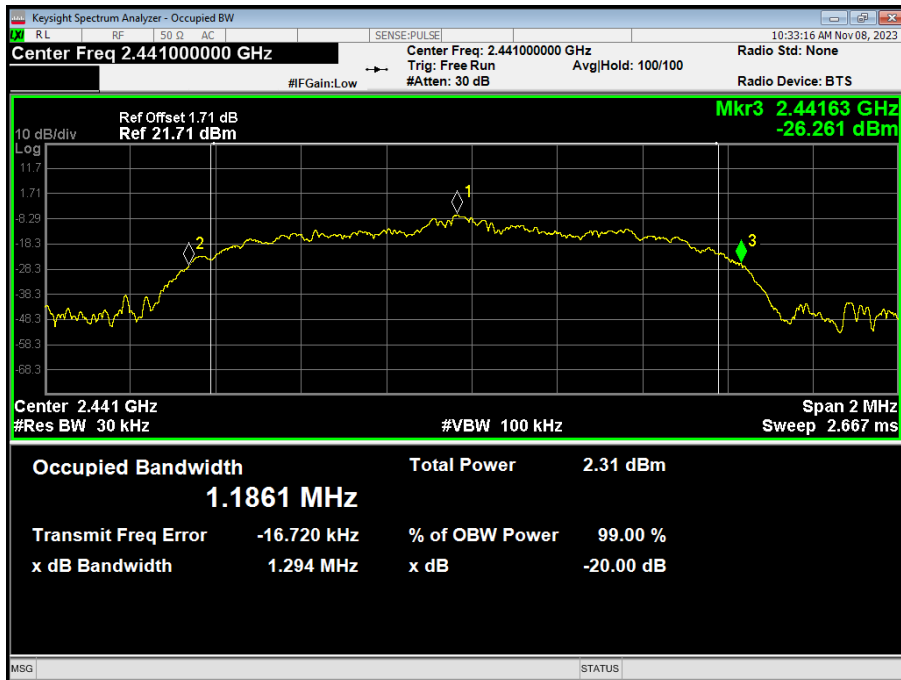

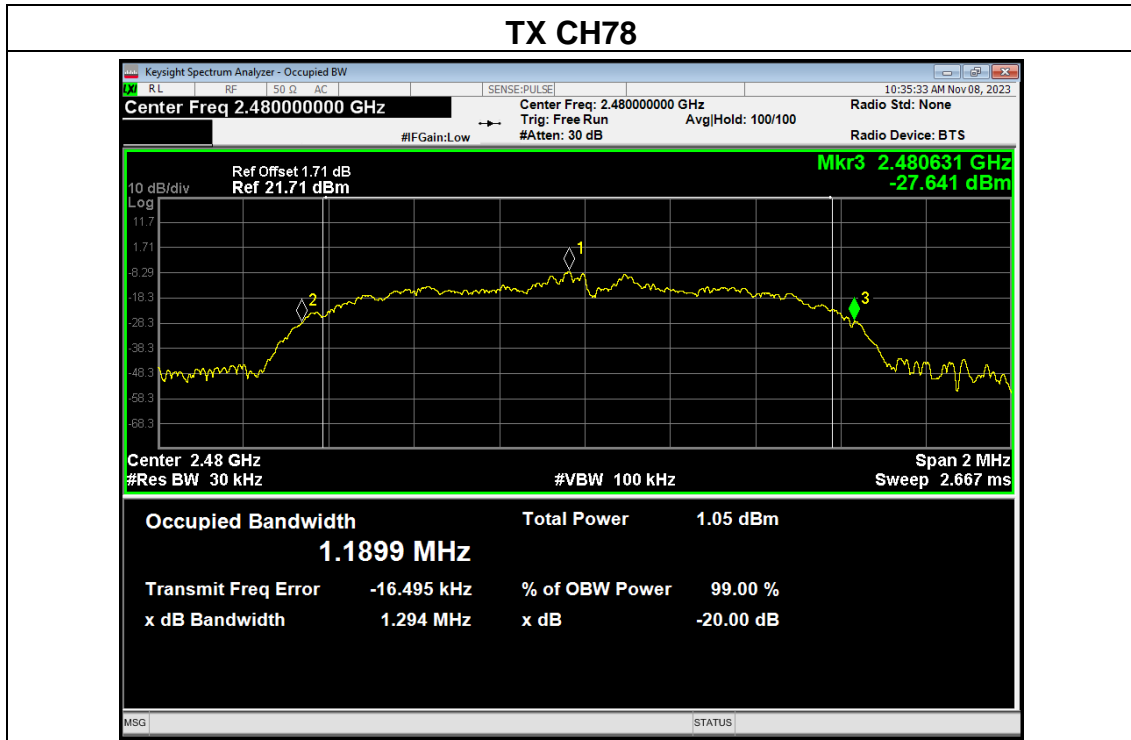

5.6 Carrier Frequency Separation

5.6.1 Limit

| FCC Part15 (15.247) , Subpart C | | | |
|---------------------------------|--------------------|---|-----------------------|
| Section | Test Item | Limit | Frequency Range (MHz) |
| 15.247(a)(1) | Channel Separation | >25kHz or >two-thirds of the 20 dB bandwidth (Which is greater) | 2400-2483.5 |

5.6.2 Test Procedure

- (1) The EUT was directly connected to the spectrum analyzer and antenna output port as show in the block diagram above.
- (2) Spectrum Setting:
RBW=30 kHz, VBW=100 kHz, detector= Peak, Sweep Time =auto.
- (3) The EUT was set to the Hopping Mode for Channel Separation Test and continuously transmitting for the Test.

5.6.3 Test Setup

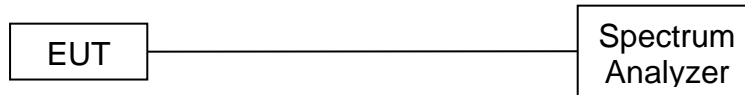

5.6.4 Test Results

| | | | |
|------------|---|---------------|--------------|
| EUT: | dollarfix DF51, ECHO | Model Name: | TDFD |
| Pressure: | 1012 hPa | Test Voltage: | AC 120V/60Hz |
| Test Mode: | GFSK, $\pi/4$ -DQPSK, 8DPSK /CH00, CH39, CH78 | | |

| Mode | Channel | Frequency (MHz) | Test Result (MHz) | Limit | | Result |
|----------------|---------|--------------------|----------------------|-------|----------------|--------|
| | | | | | (MHz) | |
| GFSK | Low | 2402 | 1.032 | 0.637 | 2/3 of 20dB BW | Pass |
| | Middle | 2441 | 1.038 | 0.635 | 2/3 of 20dB BW | Pass |
| | High | 2480 | 0.984 | 0.637 | 2/3 of 20dB BW | Pass |
| $\pi/4$ -DQPSK | Low | 2402 | 0.978 | 0.883 | 2/3 of 20dB BW | Pass |
| | Middle | 2441 | 0.99 | 0.885 | 2/3 of 20dB BW | Pass |
| | High | 2480 | 1.02 | 0.871 | 2/3 of 20dB BW | Pass |
| 8DPSK | Low | 2402 | 1.048 | 0.867 | 2/3 of 20dB BW | Pass |
| | Middle | 2441 | 1.024 | 0.863 | 2/3 of 20dB BW | Pass |
| | High | 2480 | 0.902 | 0.863 | 2/3 of 20dB BW | Pass |

Test plots

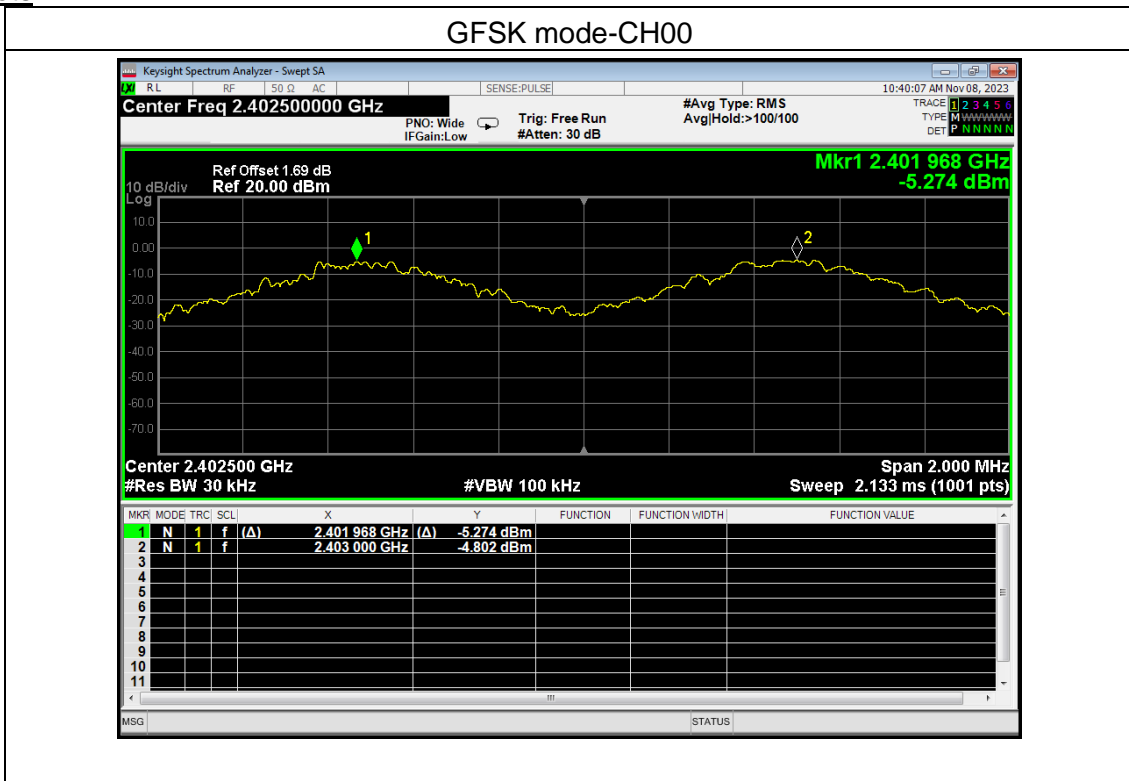

GFSK mode-CH39

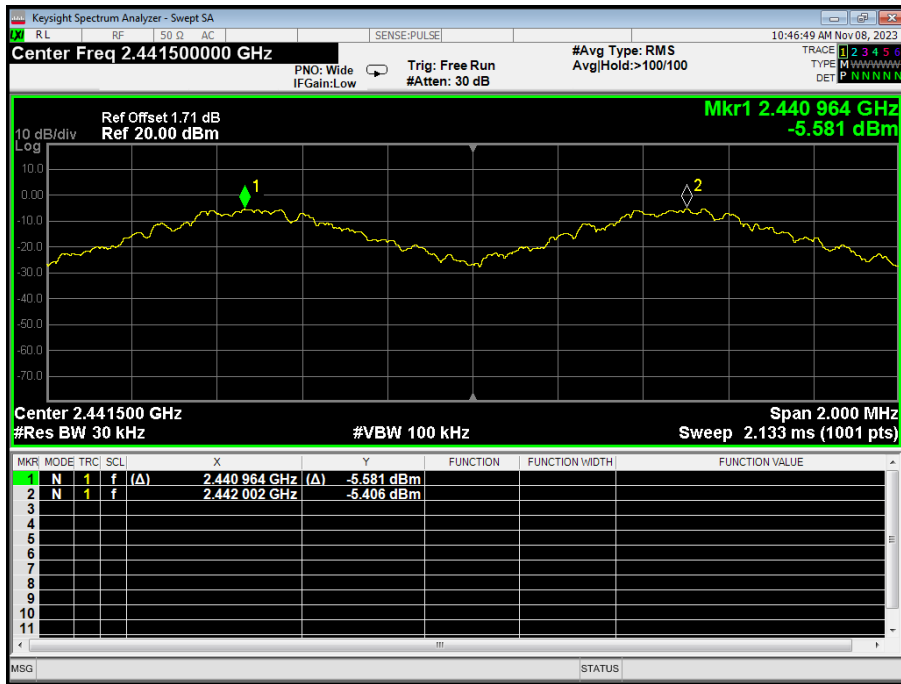

GFSK mode-CH78

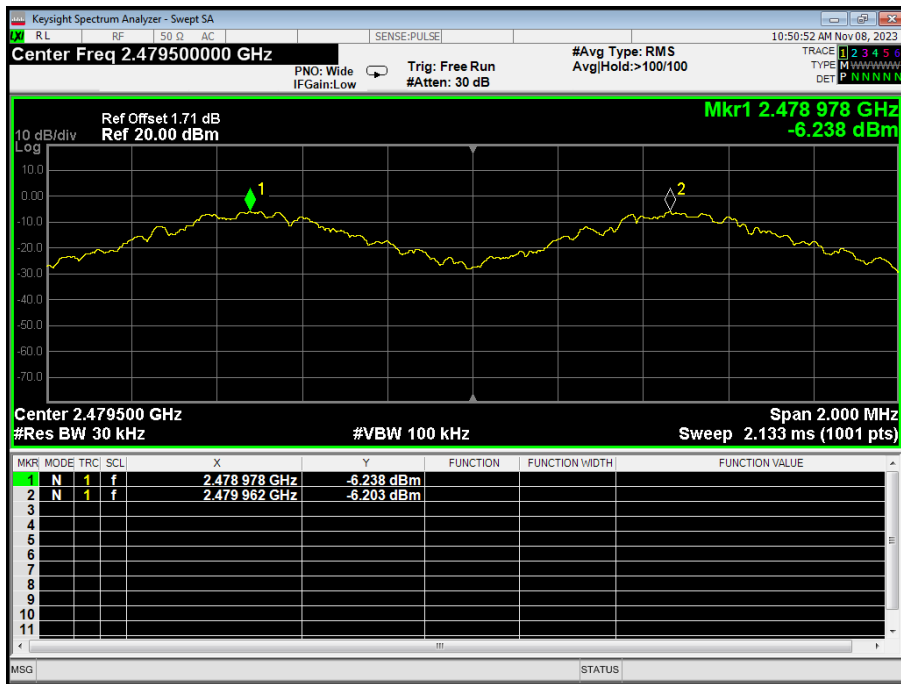

$\pi/4$ -DQPSK mode-CH00

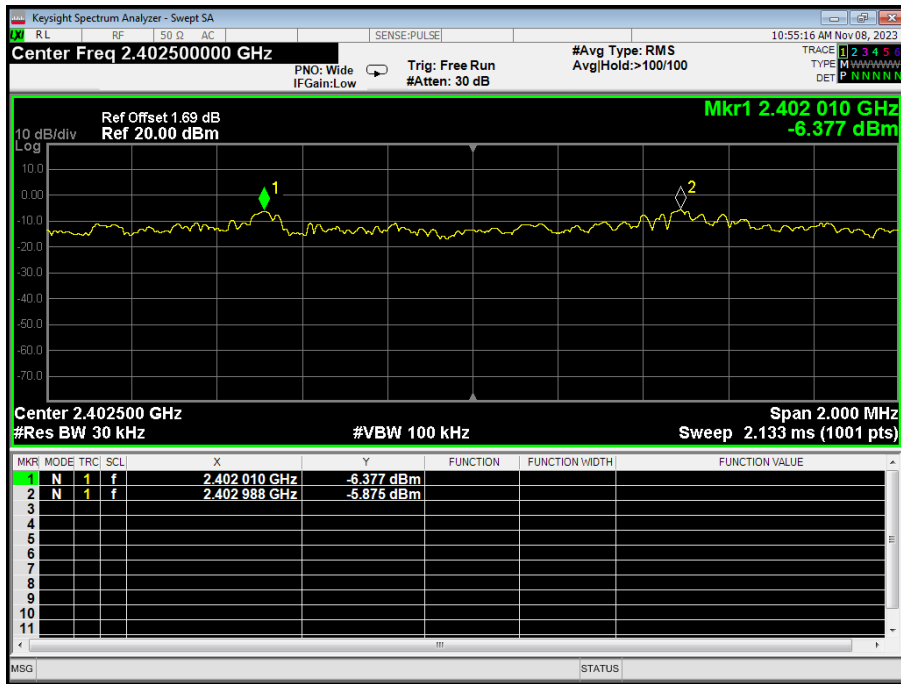

$\pi/4$ -DQPSK mode-CH39

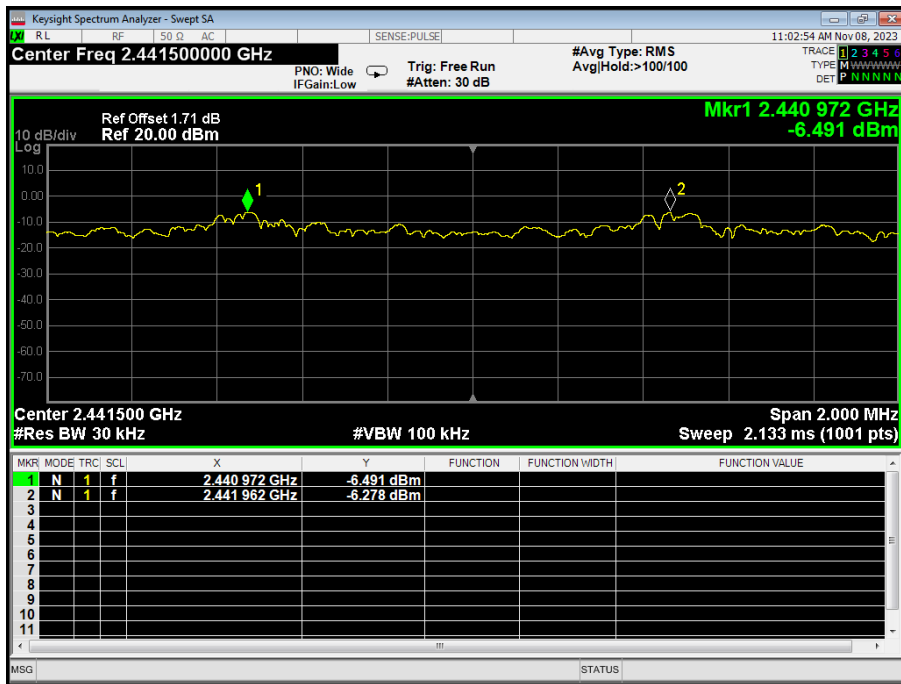

$\pi/4$ -DQPSK mode-CH78

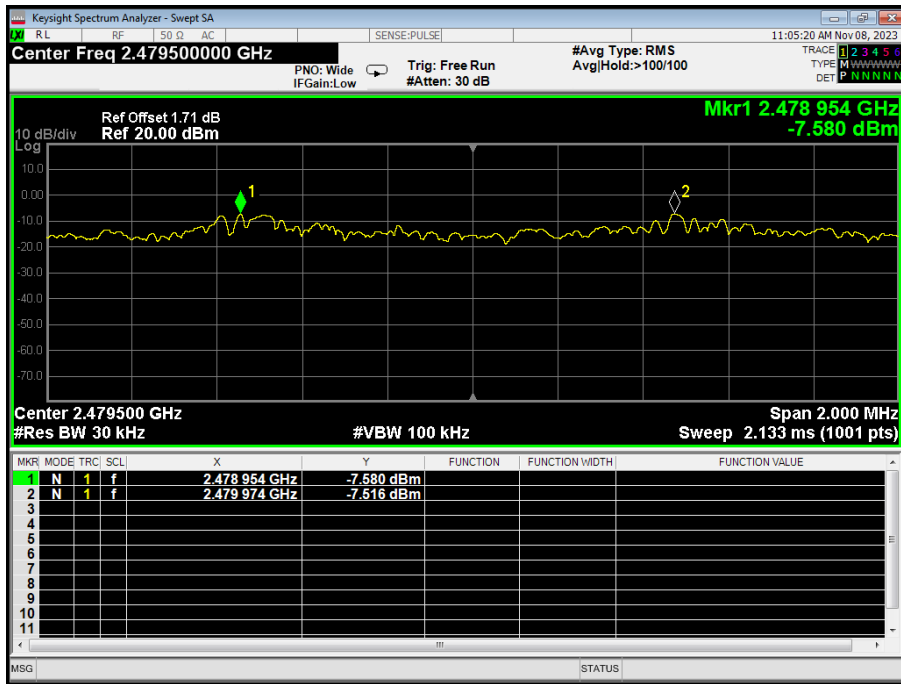

8DPSK mode-CH00

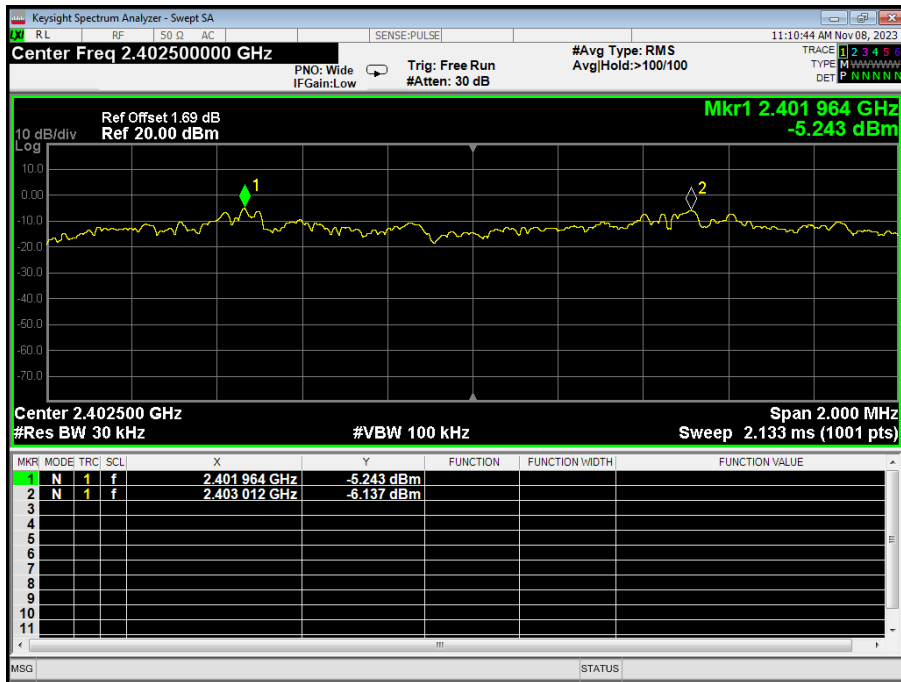

8DPSK mode-CH39

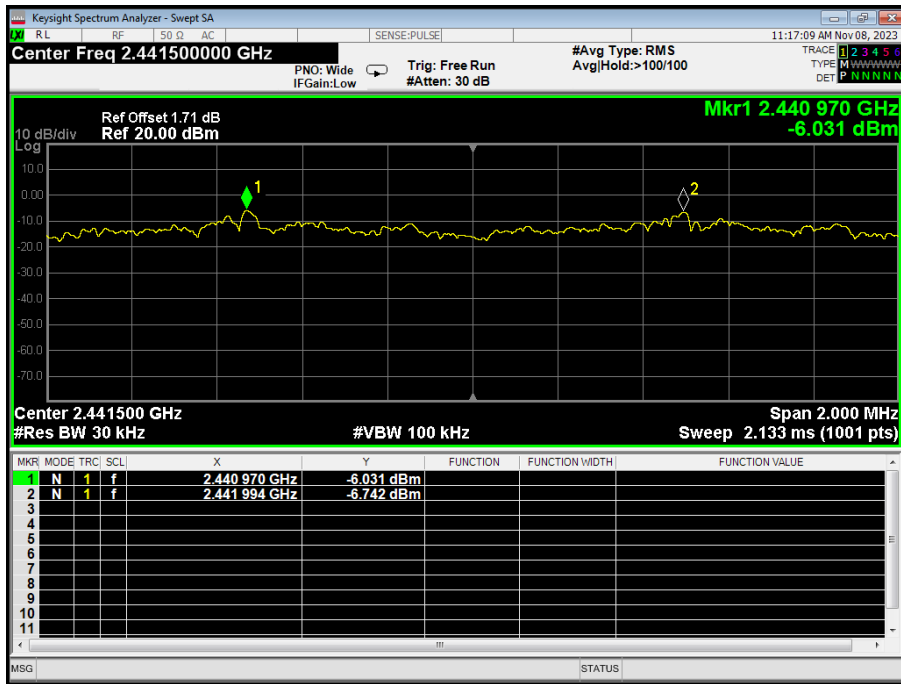

8DPSK mode-CH78

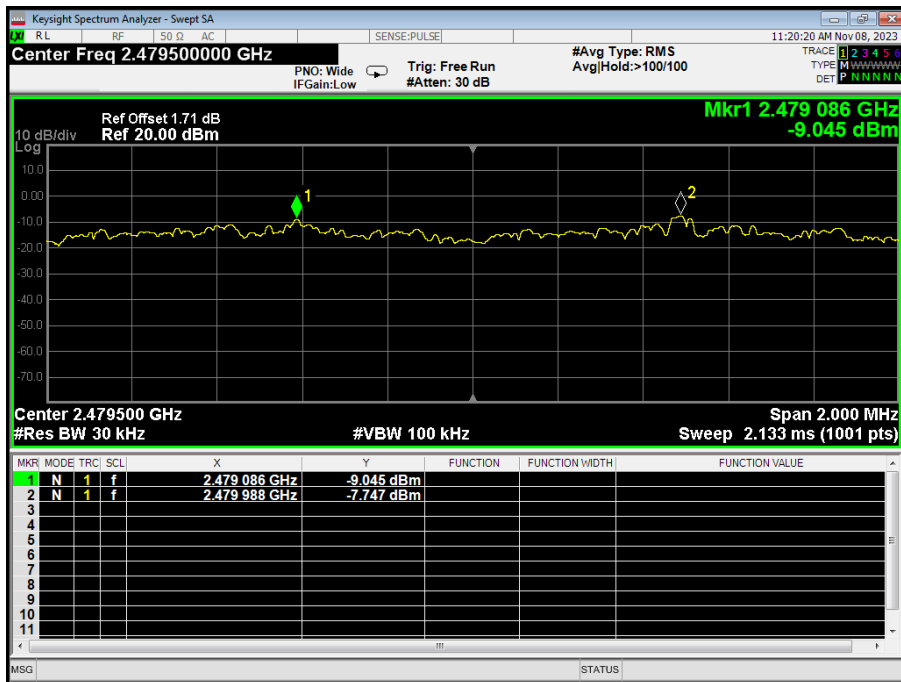

5.7 Hopping Channel Number

5.7.1 Limit

Frequency hopping systems in the 2400-2483.5MHz band shall use at least 15 channels.

5.7.2 Test Procedure

The testing follows IEEE / ANSI C63.10-2020 clause 7.8.3

The RF output of EUT was connected to the spectrum analyzer by RF cable and attenuator.

The path loss was compensated to the results for each measurement.

Set to the maximum power setting and enable the EUT transmit continuously.

The EUT must have its hopping function enabled.

Use the following spectrum analyzer settings:

Span = the frequency band of operation

RBW : To identify clearly the individual channels, set the RBW to less than 30% of the channel spacing or the 20 dB bandwidth, whichever is smaller.

VBW \geq RBW

Sweep = auto

Detector function = peak

Trace = max hold

5.7.3 Test Setup

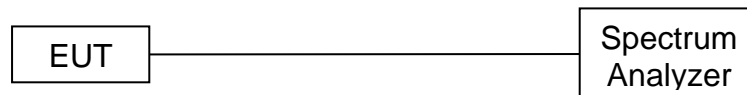

5.7.4 Test Results

| Mode | Quantity of Hopping Channel | Limit | Results |
|-----------------------------|-----------------------------|-------|---------|
| GFSK, $\pi/4$ -DQPSK, 8DPSK | 79 | >15 | Pass |

Test plots

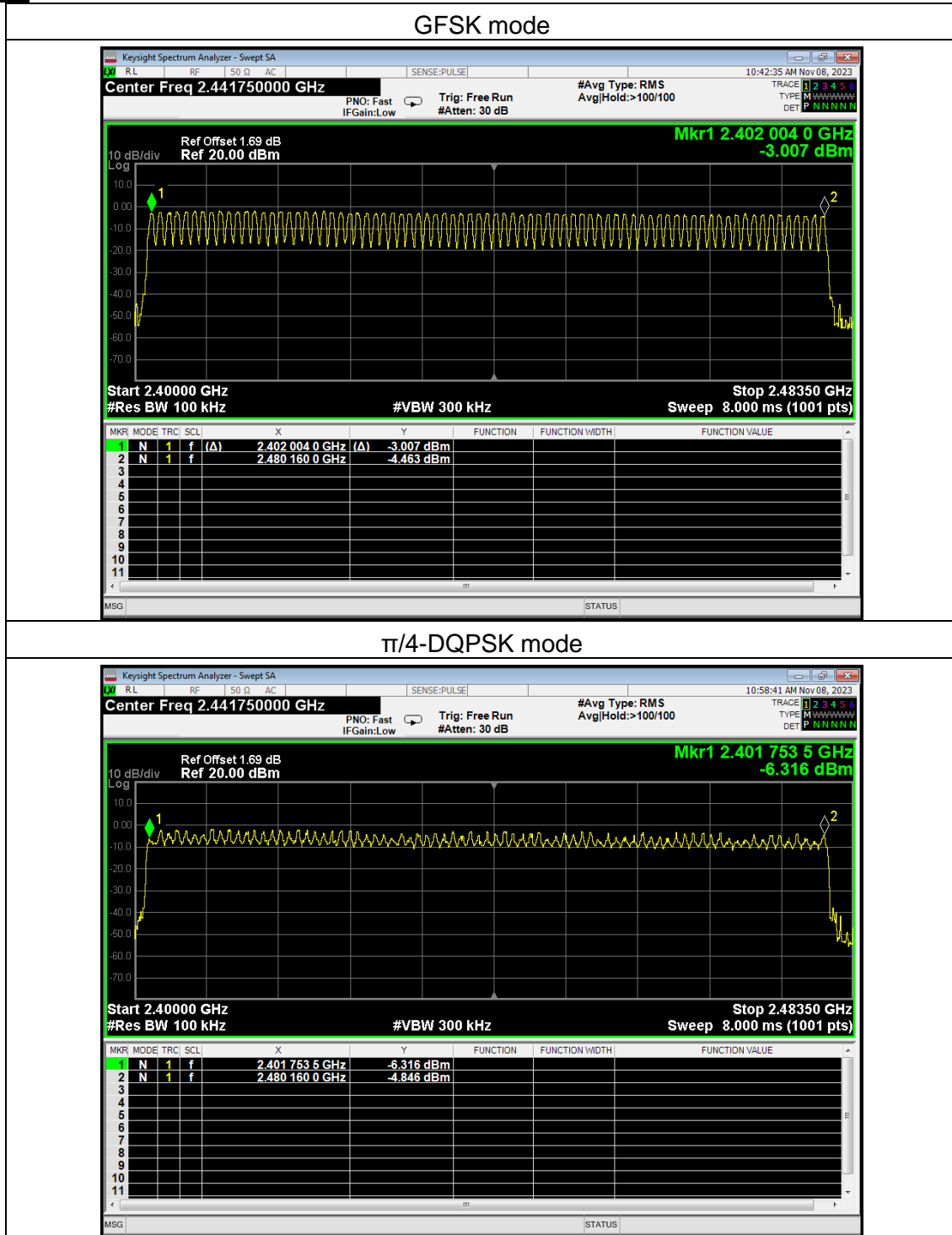

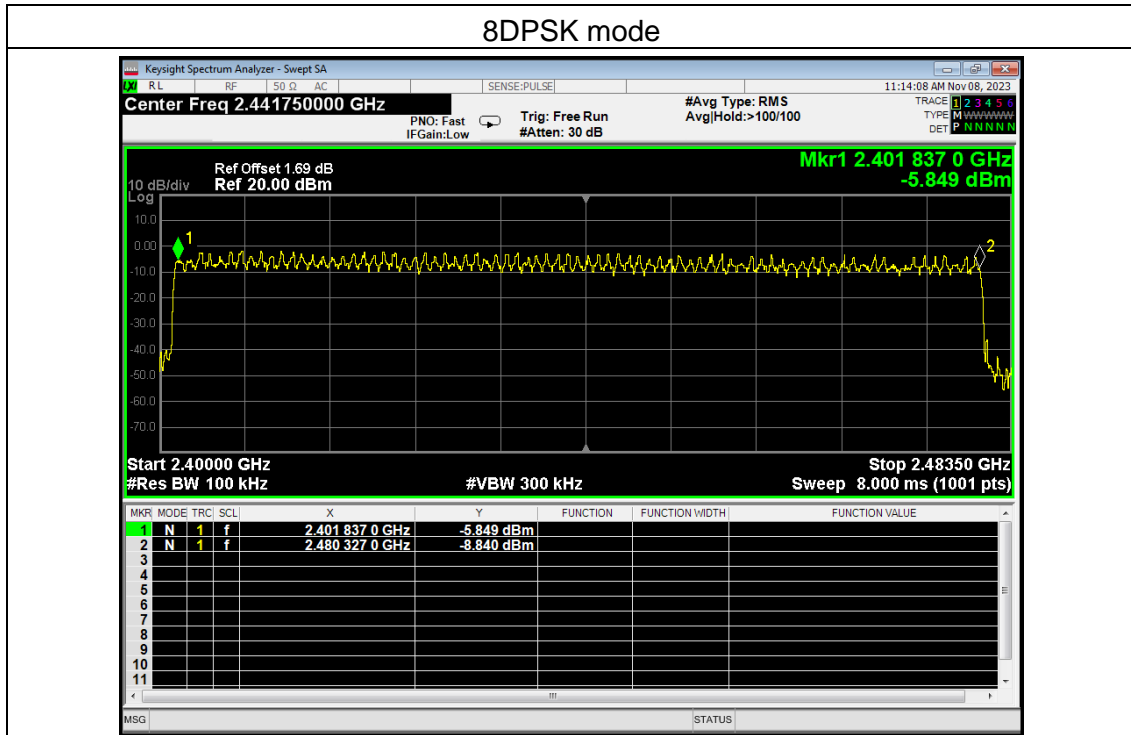

5.8 Dwell Time

5.8.1 Limit

| FCC Part15 (15.247) , Subpart C | | | |
|---------------------------------|------------|---------|-----------------------|
| Section | Test Item | Limit | Frequency Range (MHz) |
| 15.247(a)(1) | Dwell time | 0.4 sec | 2400-2483.5 |

5.8.2 Test Procedure

- (1) The EUT was directly connected to the spectrum analyzer and antenna output port as show in the block diagram above.
- (2) Spectrum Setting: RBW=1MHz, VBW=3MHz, Span=0Hz, Detector=Peak
- (3) Use video trigger with the trigger level set to enable triggering only on full pulses.
- (4) Sweep Time is more than once pulse time.
- (5) Set the center frequency on any frequency would be measure and set the frequency span to zero span.
- (6) Measure the maximum time duration of one single pulse.
- (7) Set the EUT for packet transmitting.
- (8) Measure the maximum time duration of one single pulse.
- (9) The EUT was set to the Hopping Mode for Dwell Time Test.

5.8.3 Test Setup



5.8.4 Test Results

| | | | |
|------------|-----------------------------------|---------------|--------------|
| EUT: | dollarfix DF51, ECHO | Model Name: | TDFD |
| Pressure: | 1012 hPa | Test Voltage: | AC 120V/60Hz |
| Test Mode: | GFSK, $\pi/4$ -DQPSK, 8DPSK /CH39 | | |

| Mode | Data Packet | Frequency (MHz) | Pulse Duration (ms) | Dwell Time (ms) | Limit(s) | Conclusion |
|---------------|-------------|-----------------|---------------------|-----------------|----------|------------|
| GFSK | DH1 | 2441 | 0.431 | 137.92 | <0.4 | Pass |
| | DH3 | 2441 | 1.63 | 260.80 | <0.4 | Pass |
| | DH5 | 2441 | 2.832 | 302.08 | <0.4 | Pass |
| $\pi/4$ DQPSK | 2DH1 | 2441 | 0.491 | 157.12 | <0.4 | Pass |
| | 2DH3 | 2441 | 1.691 | 270.56 | <0.4 | Pass |
| | 2DH5 | 2441 | 2.891 | 308.37 | <0.4 | Pass |
| 8DPSK | 3DH1 | 2441 | 0.418 | 133.76 | <0.4 | Pass |
| | 3DH3 | 2441 | 1.67 | 267.20 | <0.4 | Pass |
| | 3DH5 | 2441 | 2.765 | 294.93 | <0.4 | Pass |

Note:

1. A period time = 0.4 (s) * 79 = 31.6(s)

2. DH1 time slot = Pulse Duration * (1600/(2*79)) * A period time

DH3 time slot = Pulse Duration * (1600/(4*79)) * A period time

DH5 time slot = Pulse Duration * (1600/(6*79)) * A period time

3. For GFSK, $\pi/4$ -DQPSK and 8DPSK: The test period: T= 0.4 Second/Channel x 79 Channel = 31.6 s

Test plots

| | Modulation mode | GFSK mode |
|-----|--|--|
| DH1 |  |  |
| DH3 |  |  |
| DH5 |  |  |

| | Modulation mode | $\pi/4$ -DQPSK mode | | | | | | | | | | | | | | | | | | | | | | | | | | | |
|-------|--|---------------------|-----|------|----------|----------|----------------|----------------|----------|----------------|----------------|---|----|---|---|-----|----------|-----|--|----------|---|---|---|---|-----|----------|-----|--|------------|
| 2-DH1 |  <table border="1" data-bbox="539 674 1246 846"> <thead> <tr> <th>MNR</th> <th>MODE</th> <th>TRC</th> <th>SCL</th> <th>X</th> <th>Y</th> <th>FUNCTION</th> <th>FUNCTION WIDTH</th> <th>FUNCTION VALUE</th> </tr> </thead> <tbody> <tr> <td>1</td> <td>A2</td> <td>1</td> <td>t</td> <td>(Δ)</td> <td>491.0 μs</td> <td>(Δ)</td> <td></td> <td>-5.16 dB</td> </tr> <tr> <td>2</td> <td>F</td> <td>1</td> <td>t</td> <td>(Δ)</td> <td>497.0 μs</td> <td>(Δ)</td> <td></td> <td>-11.71 dBm</td> </tr> </tbody> </table> | | MNR | MODE | TRC | SCL | X | Y | FUNCTION | FUNCTION WIDTH | FUNCTION VALUE | 1 | A2 | 1 | t | (Δ) | 491.0 μs | (Δ) | | -5.16 dB | 2 | F | 1 | t | (Δ) | 497.0 μs | (Δ) | | -11.71 dBm |
| MNR | MODE | TRC | SCL | X | Y | FUNCTION | FUNCTION WIDTH | FUNCTION VALUE | | | | | | | | | | | | | | | | | | | | | |
| 1 | A2 | 1 | t | (Δ) | 491.0 μs | (Δ) | | -5.16 dB | | | | | | | | | | | | | | | | | | | | | |
| 2 | F | 1 | t | (Δ) | 497.0 μs | (Δ) | | -11.71 dBm | | | | | | | | | | | | | | | | | | | | | |
| 2-DH3 |  <table border="1" data-bbox="539 1227 1246 1400"> <thead> <tr> <th>MNR</th> <th>MODE</th> <th>TRC</th> <th>SCL</th> <th>X</th> <th>Y</th> <th>FUNCTION</th> <th>FUNCTION WIDTH</th> <th>FUNCTION VALUE</th> </tr> </thead> <tbody> <tr> <td>1</td> <td>A2</td> <td>1</td> <td>t</td> <td>(Δ)</td> <td>1.691 ms</td> <td>(Δ)</td> <td></td> <td>-7.97 dB</td> </tr> <tr> <td>2</td> <td>F</td> <td>1</td> <td>t</td> <td>(Δ)</td> <td>497.0 μs</td> <td>(Δ)</td> <td></td> <td>-2.49 dBm</td> </tr> </tbody> </table> | | MNR | MODE | TRC | SCL | X | Y | FUNCTION | FUNCTION WIDTH | FUNCTION VALUE | 1 | A2 | 1 | t | (Δ) | 1.691 ms | (Δ) | | -7.97 dB | 2 | F | 1 | t | (Δ) | 497.0 μs | (Δ) | | -2.49 dBm |
| MNR | MODE | TRC | SCL | X | Y | FUNCTION | FUNCTION WIDTH | FUNCTION VALUE | | | | | | | | | | | | | | | | | | | | | |
| 1 | A2 | 1 | t | (Δ) | 1.691 ms | (Δ) | | -7.97 dB | | | | | | | | | | | | | | | | | | | | | |
| 2 | F | 1 | t | (Δ) | 497.0 μs | (Δ) | | -2.49 dBm | | | | | | | | | | | | | | | | | | | | | |
| 2-DH5 |  <table border="1" data-bbox="539 1780 1246 1953"> <thead> <tr> <th>MNR</th> <th>MODE</th> <th>TRC</th> <th>SCL</th> <th>X</th> <th>Y</th> <th>FUNCTION</th> <th>FUNCTION WIDTH</th> <th>FUNCTION VALUE</th> </tr> </thead> <tbody> <tr> <td>1</td> <td>A2</td> <td>1</td> <td>t</td> <td>(Δ)</td> <td>2.891 ms</td> <td>(Δ)</td> <td></td> <td>-3.74 dB</td> </tr> <tr> <td>2</td> <td>F</td> <td>1</td> <td>t</td> <td>(Δ)</td> <td>496.0 μs</td> <td>(Δ)</td> <td></td> <td>-12.75 dBm</td> </tr> </tbody> </table> | | MNR | MODE | TRC | SCL | X | Y | FUNCTION | FUNCTION WIDTH | FUNCTION VALUE | 1 | A2 | 1 | t | (Δ) | 2.891 ms | (Δ) | | -3.74 dB | 2 | F | 1 | t | (Δ) | 496.0 μs | (Δ) | | -12.75 dBm |
| MNR | MODE | TRC | SCL | X | Y | FUNCTION | FUNCTION WIDTH | FUNCTION VALUE | | | | | | | | | | | | | | | | | | | | | |
| 1 | A2 | 1 | t | (Δ) | 2.891 ms | (Δ) | | -3.74 dB | | | | | | | | | | | | | | | | | | | | | |
| 2 | F | 1 | t | (Δ) | 496.0 μs | (Δ) | | -12.75 dBm | | | | | | | | | | | | | | | | | | | | | |

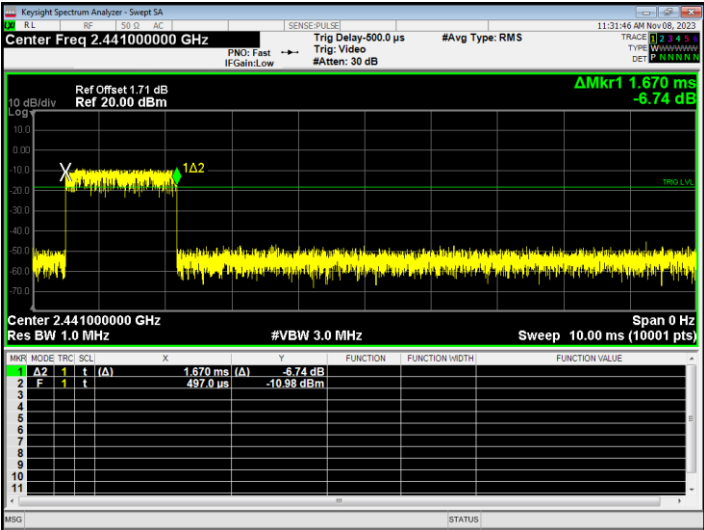
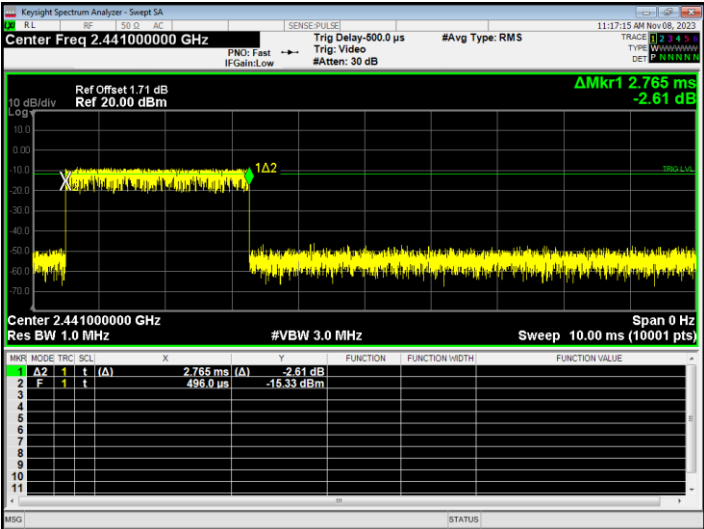
| Modulation mode | 8DPSK mode |
|-----------------|--|
| 3-DH1 |  <p>Key parameters for 3-DH1:</p> <ul style="list-style-type: none"> Center Freq: 2.441000000 GHz Res BW: 1.0 MHz #VBW: 3.0 MHz Sweep: 10.00 ms (10001 pts) Peak 1: 418.0 μs, -8.86 dB Noise Floor: -10.92 dBm |
| 3-DH3 |  <p>Key parameters for 3-DH3:</p> <ul style="list-style-type: none"> Center Freq: 2.441000000 GHz Res BW: 1.0 MHz #VBW: 3.0 MHz Sweep: 10.00 ms (10001 pts) Peak 1: 1.670 ms, -6.74 dB Noise Floor: -10.58 dBm |
| 3-DH5 |  <p>Key parameters for 3-DH5:</p> <ul style="list-style-type: none"> Center Freq: 2.441000000 GHz Res BW: 1.0 MHz #VBW: 3.0 MHz Sweep: 10.00 ms (10001 pts) Peak 1: 2.765 ms, -2.61 dB Noise Floor: -15.33 dBm |

5.9 Conducted Band Edge

5.9.1 Limit

In any 100 kHz bandwidth outside the frequency band in which the spread spectrum or digitally modulated intentional radiator is operating, the radio frequency power that is produced by the intentional radiator shall be at least 20 dB below that in the 100 kHz bandwidth within the band that contains the highest level of the desired power, based on either an RF conducted or a radiated measurement, provided the transmitter demonstrates compliance with the peak conducted power limits. If the transmitter complies with the conducted power limits based on the use of RMS averaging over a time interval, as permitted under paragraph (b)(3) of this section, the attenuation required under this paragraph shall be 30 dB instead of 20 dB. Attenuation below the general limits specified in §15.209(a) is not required. In addition, radiated emissions which fall in the restricted bands, as defined in §15.205(a), must also comply with the radiated emission limits specified in §15.209(a) (see §15.205(c)).

5.9.2 Test Procedure

- a) Check the calibration of the measuring instrument using either an internal calibrator or a known signal from an external generator.
- b) Position the EUT without connection to measurement instrument. Turn on the EUT and connect its antenna terminal to measurement instrument via a low loss cable. Then set it to any one measured frequency within its operating range, and make sure the instrument is operated in its linear range.
- c) Set RBW to 100 kHz and VBW of spectrum analyzer to 300 kHz with a convenient frequency span including 100 kHz bandwidth from band edge.
- d) Measure the highest amplitude appearing on spectral display and set it as a reference level. Plot the graph with marking the highest point and edge frequency.
- e) Repeat above procedures until all measured frequencies were complete.

5.9.3 Test Setup

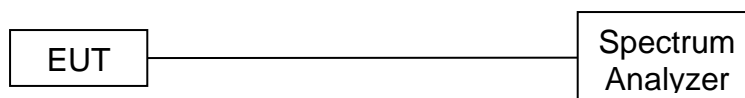

5.9.4 Test Results

| | | | |
|-----------|----------------------|---------------|--------------|
| EUT: | dollarfix DF51, ECHO | Model Name: | TDFD |
| Pressure: | 1012 hPa | Test Voltage: | AC 120V/60Hz |

Test plots

GFSK: Band Edge, Left Side(Non-hopping)

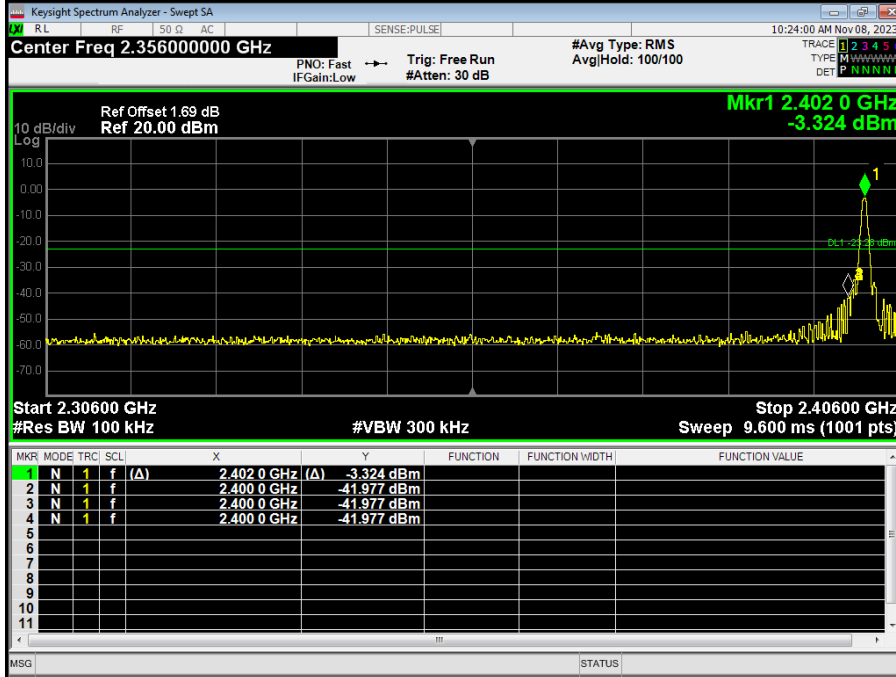

GFSK: Band Edge, Right Side(Non-hopping)

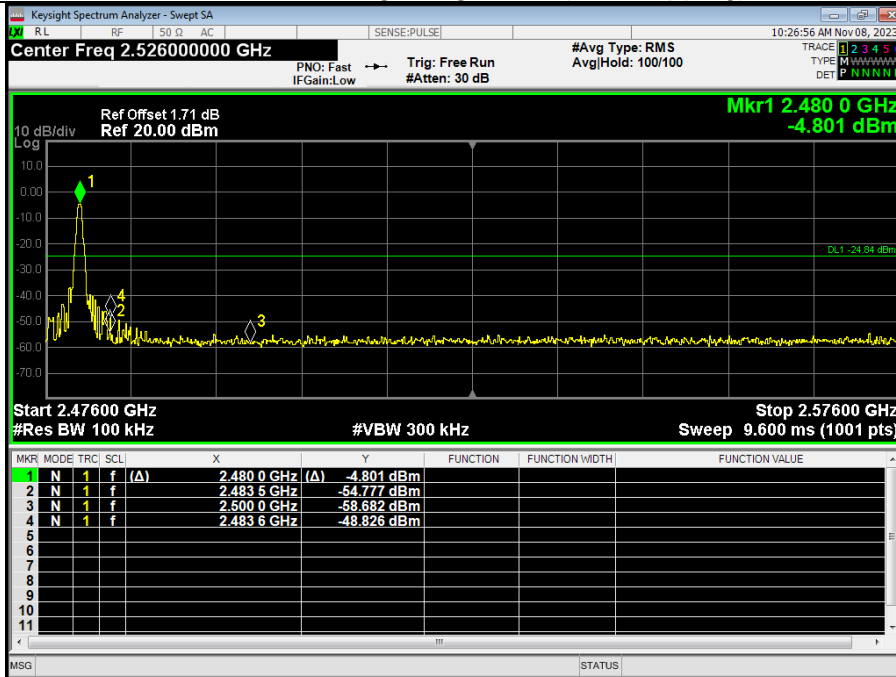

GFSK: Band Edge, Left Side(Hopping)

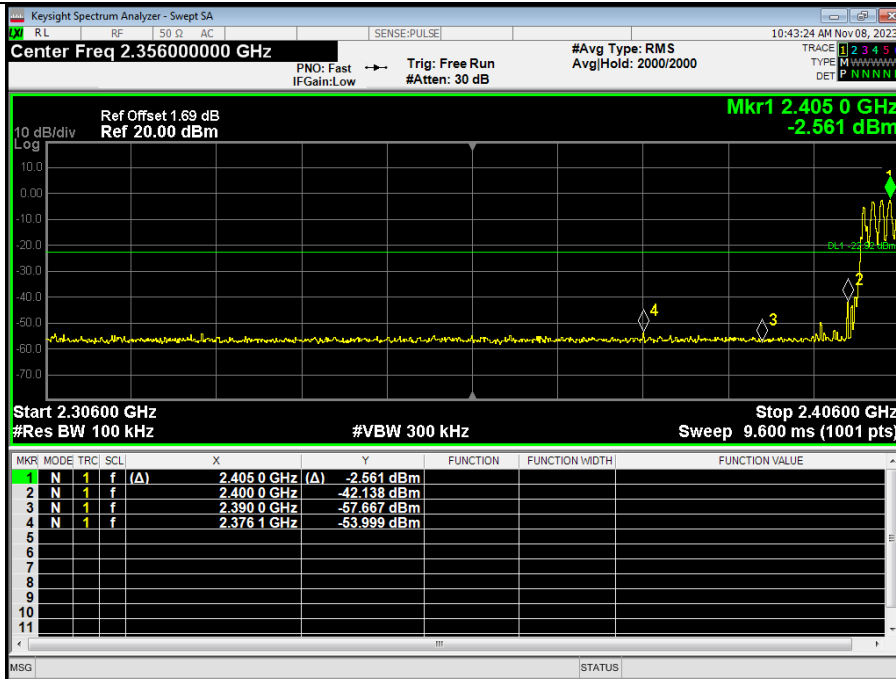

GFSK: Band Edge, Right Side(Hopping)

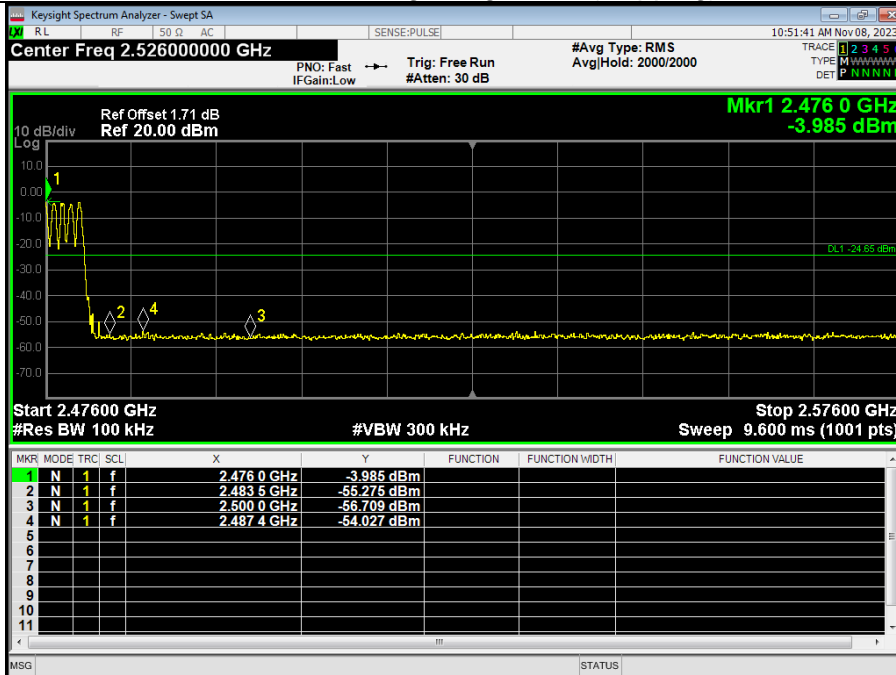

$\pi/4$ -DQPSK: Band Edge, Left Side(Non-hopping)

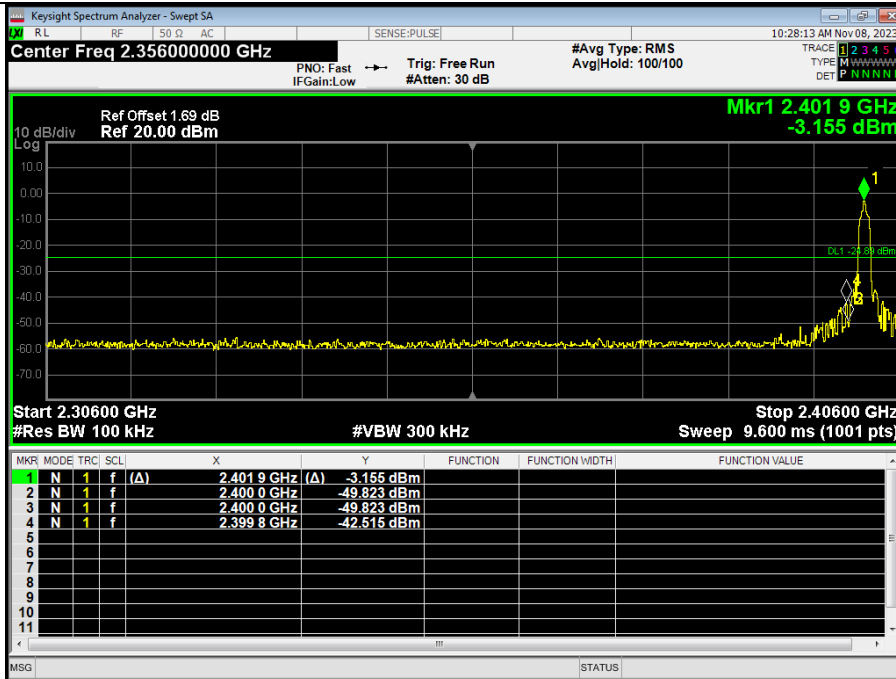

$\pi/4$ -DQPSK: Band Edge, Right Side(Non-hopping)

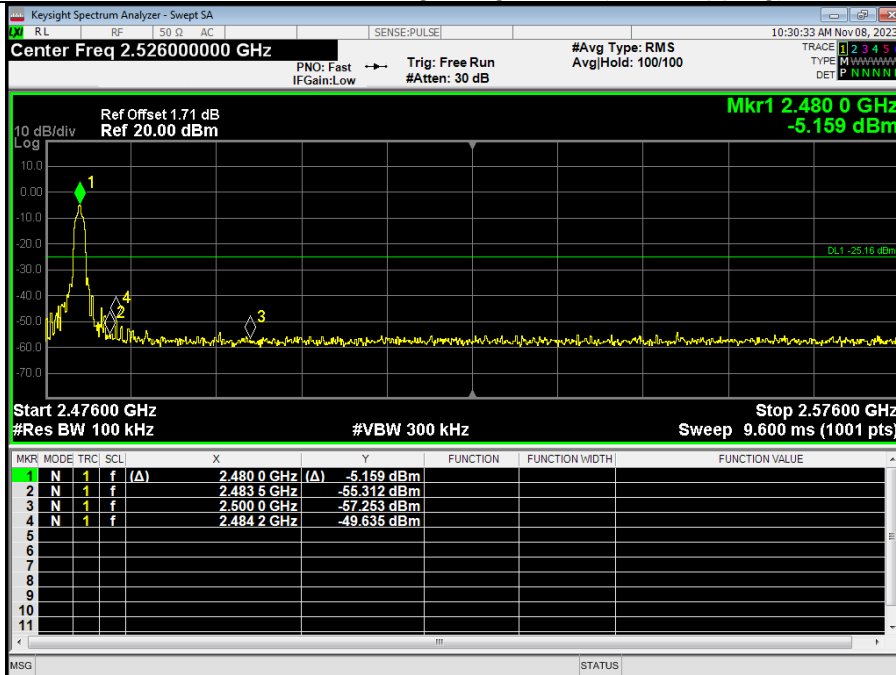

$\pi/4$ -DQPSK: Band Edge, Left Side(Hopping)

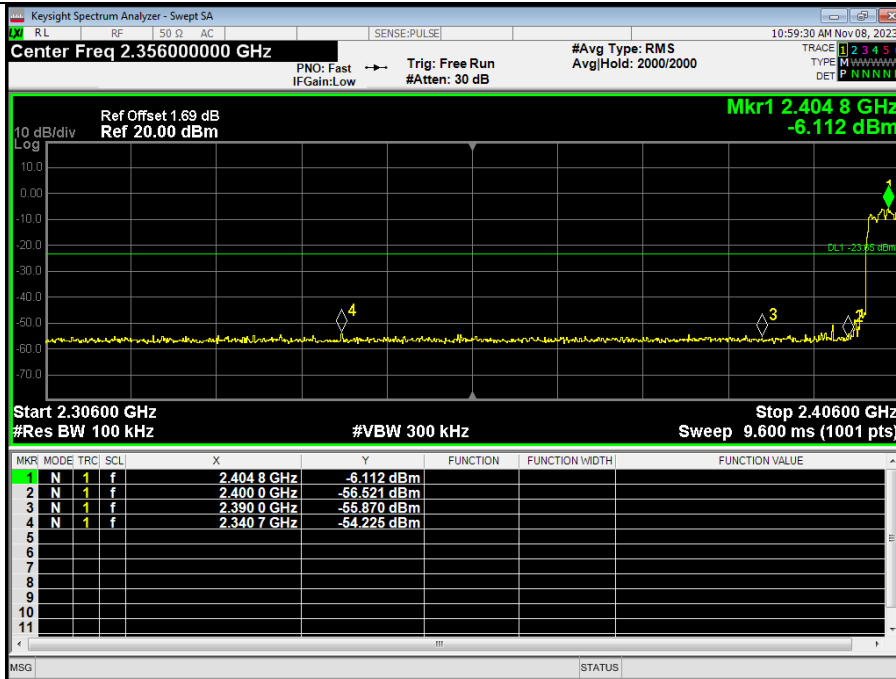

$\pi/4$ -DQPSK: Band Edge, Right Side(Hopping)

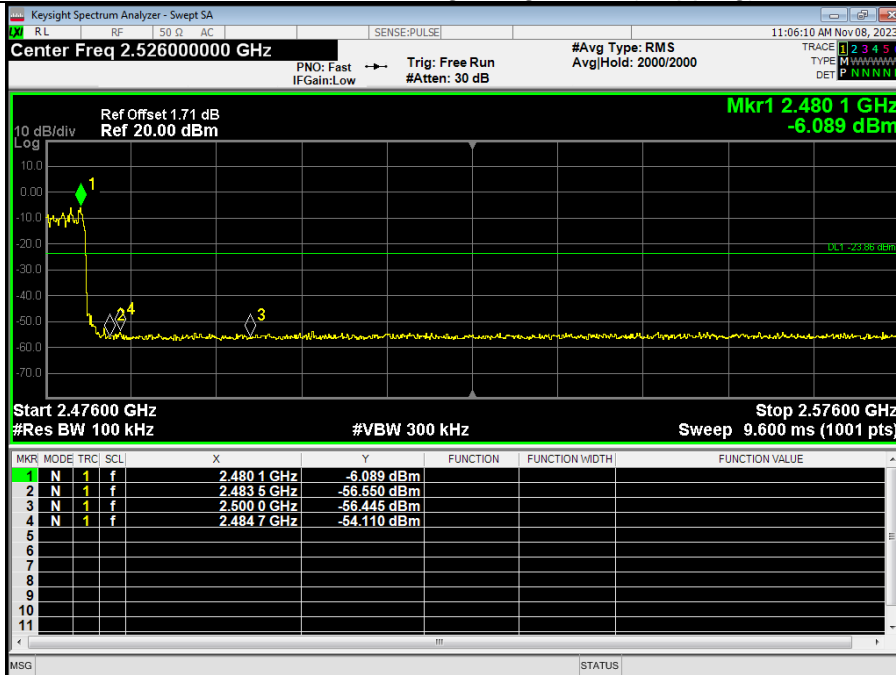

8DPSK: Band Edge, Left Side(Non-hopping)

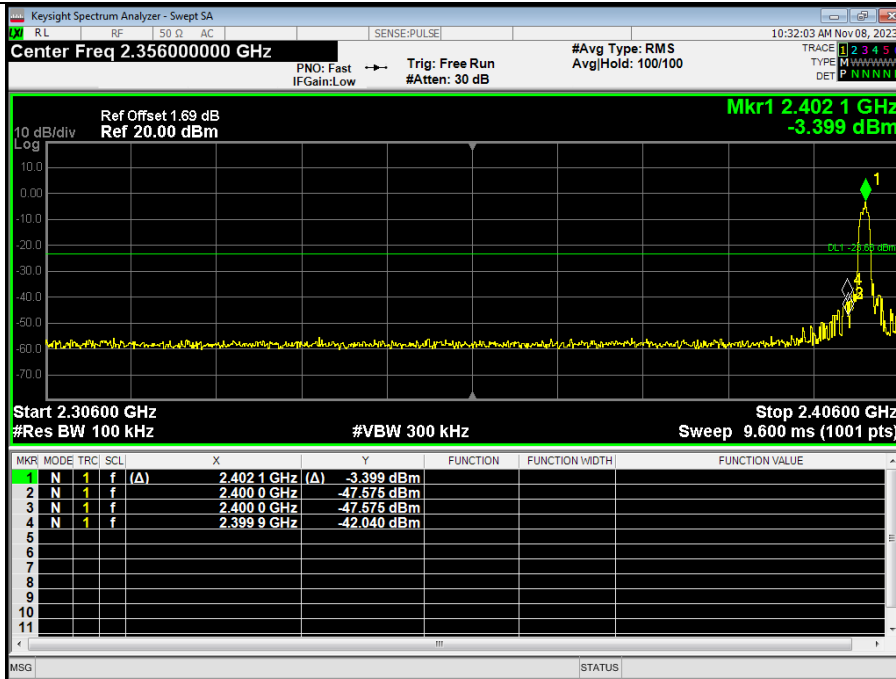

8DPSK: Band Edge, Right Side(Non-hopping)

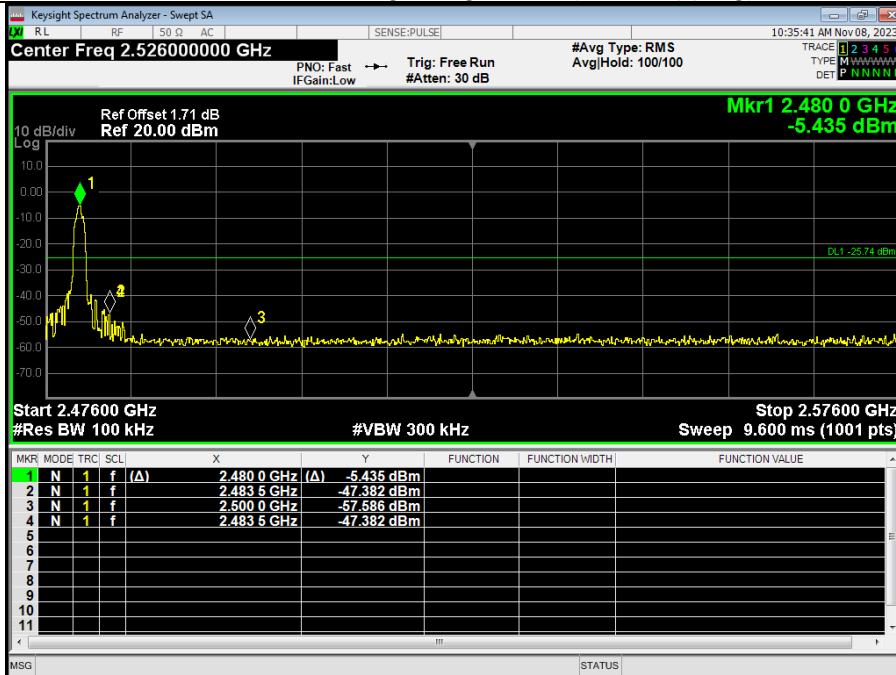

8DPSK: Band Edge, Left Side(Hopping)

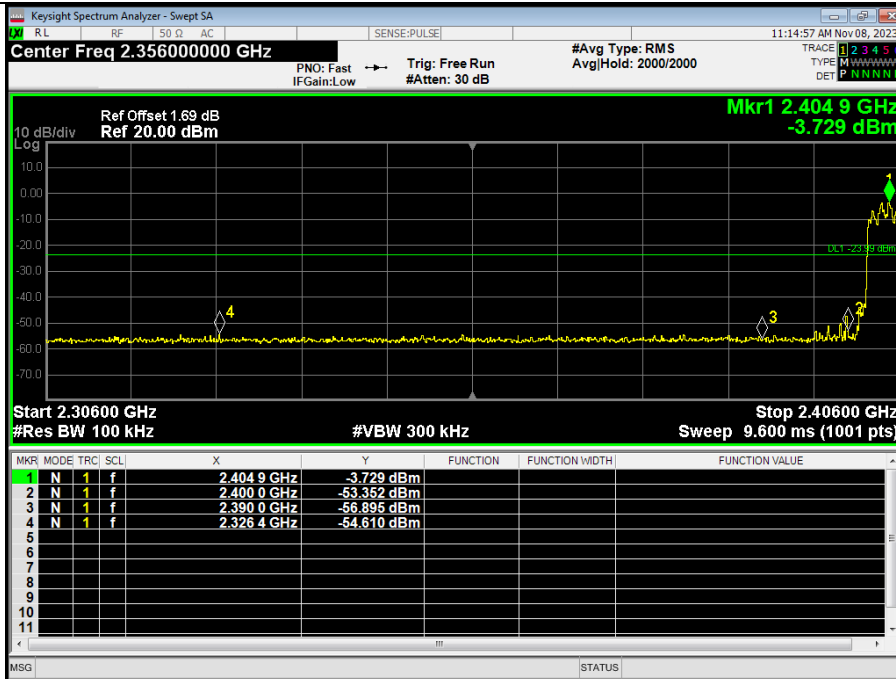

8DPSK: Band Edge, Right Side(Hopping)

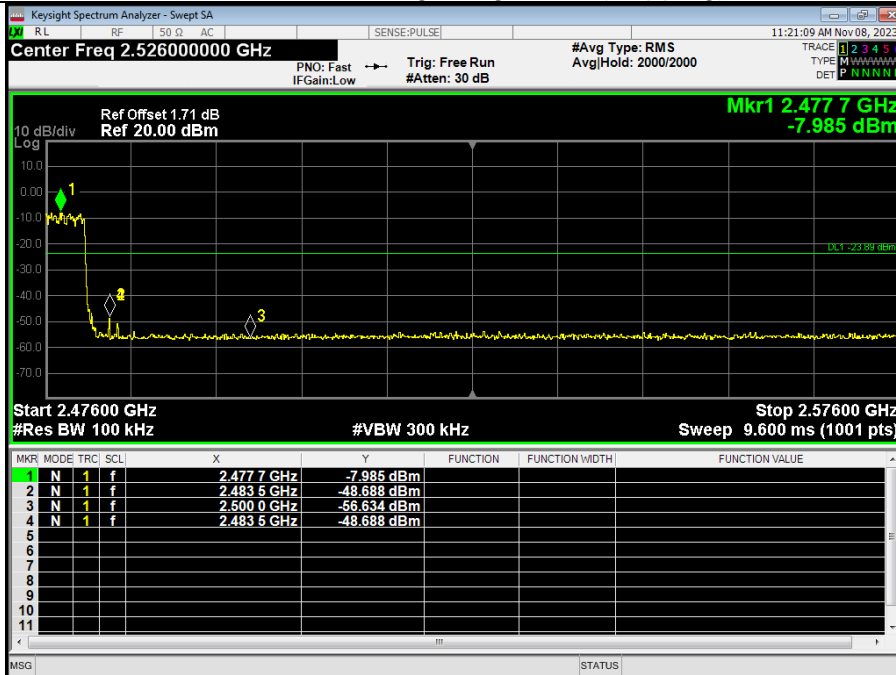

5.10 Spurious RF Conducted Emissions

5.10.1 Limit

Below -20dB of the highest emission level in operating band.

5.10.2 Test Procedure

The Spurious RF conducted emissions compliance of RF radiated emission should be measured by following the guidance in ANSI C63.10-2013 with respect to maximizing the emission by rotating the EUT, measuring the emission while the EUT is situated in three orthogonal planes (if appropriate), adjusting the measurement antenna height and polarization etc. Set RBW=100kHz and VBW=300kHz to measure the peak field strength, and measure frequency range from 9kHz to 26.5GHz.

5.10.3 Test Setup

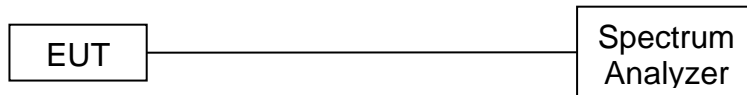

5.10.4 Test Results

Note:

1: The measurement frequency range is from 9kHz to the 10th harmonic of the fundamental frequency. The lowest, middle and highest channels are tested to verify the spurious emissions and band edge measurement data.

GFSK on Channel 00



GFSK on Channel 00

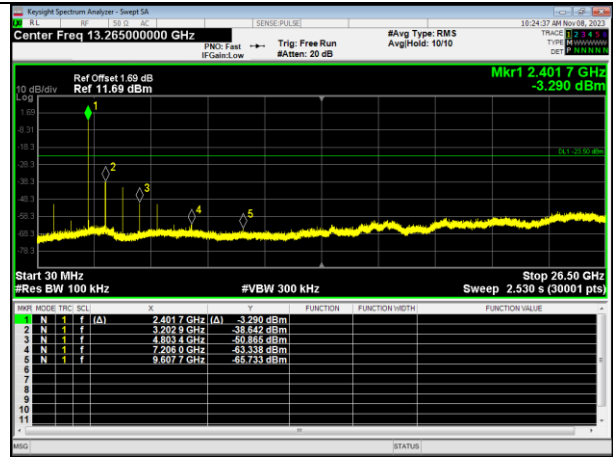

GFSK on Channel 39

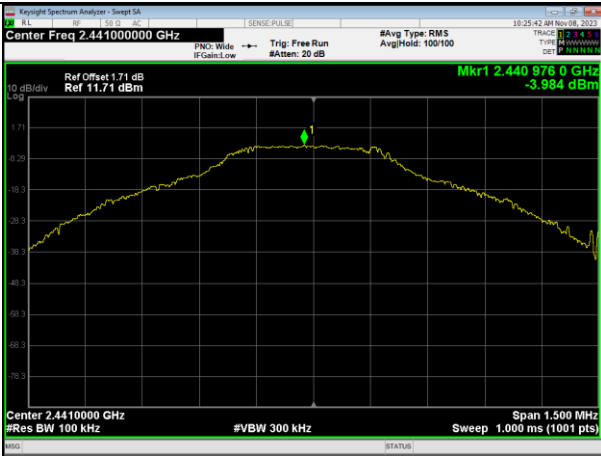

GFSK on Channel 39

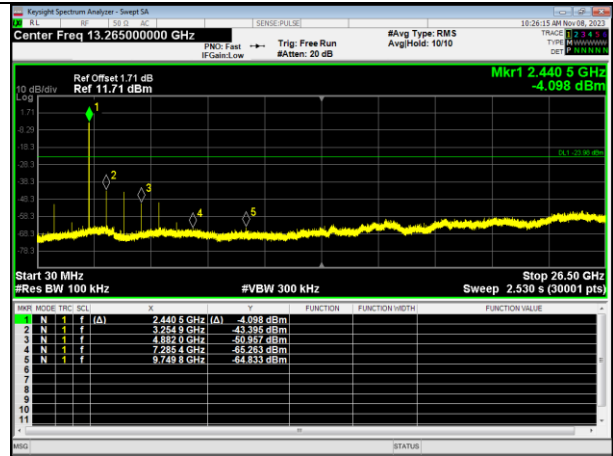

GFSK on Channel 78

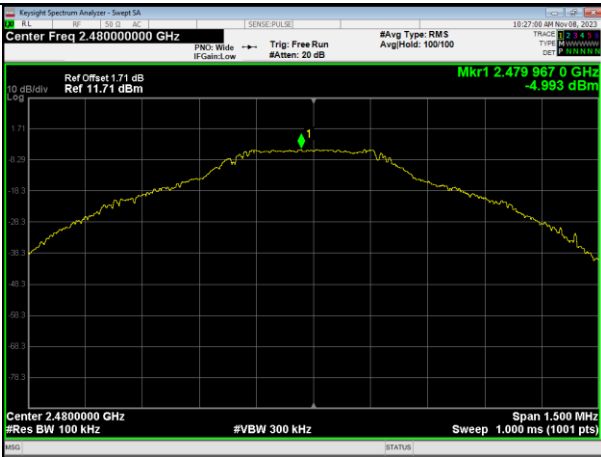

GFSK on Channel 78

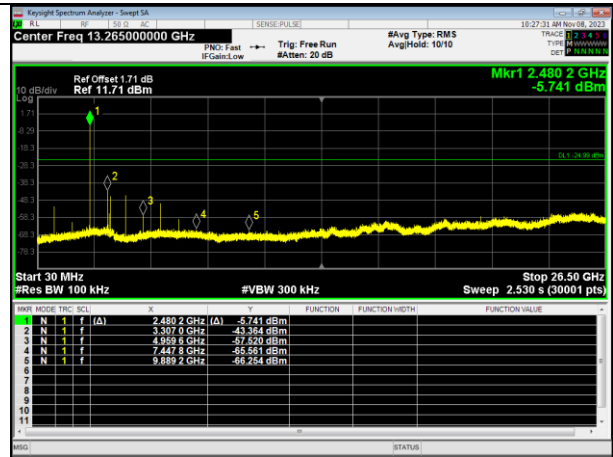

$\pi/4$ -DQPSK on Channel 00

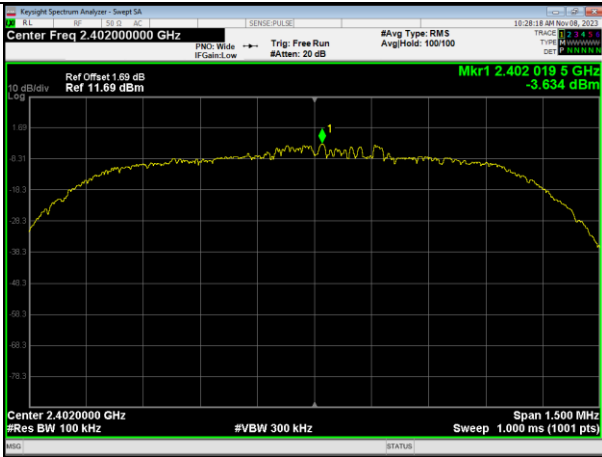

$\pi/4$ -DQPSK on Channel 00

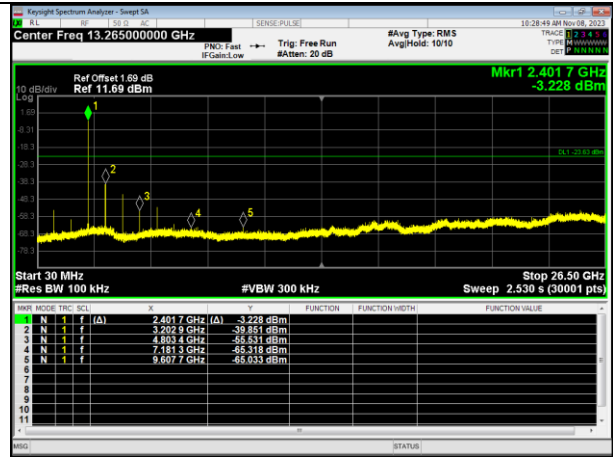

$\pi/4$ -DQPSK on Channel 39

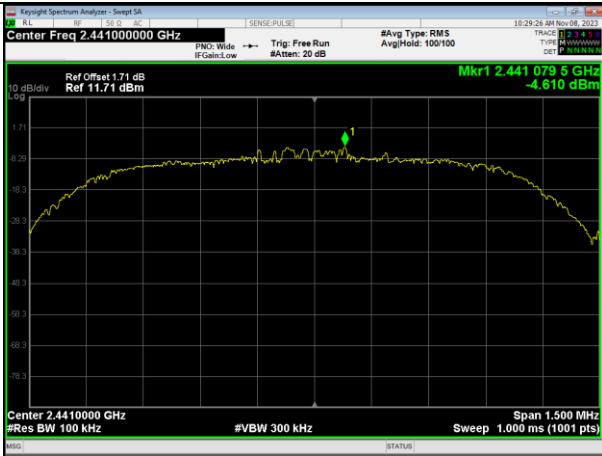

$\pi/4$ -DQPSK on Channel 39

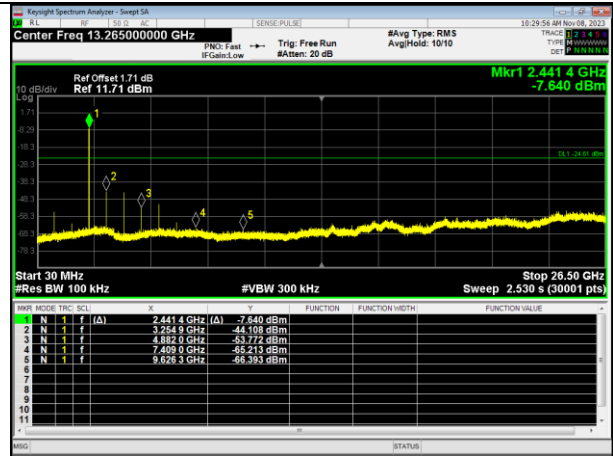

$\pi/4$ -DQPSK on Channel 78

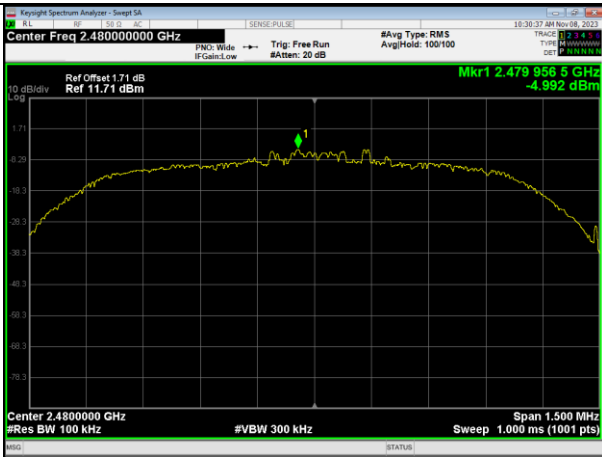

$\pi/4$ -DQPSK on Channel 78

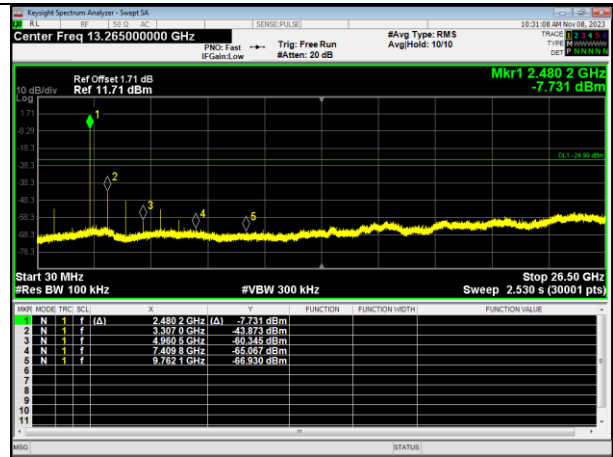

8DPSK on Channel 00

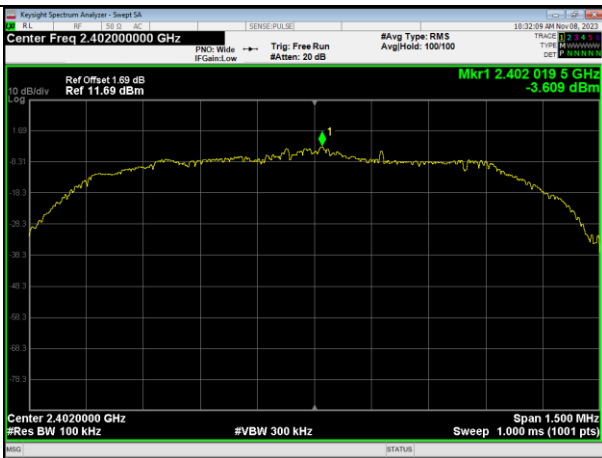

8DPSK on Channel 00

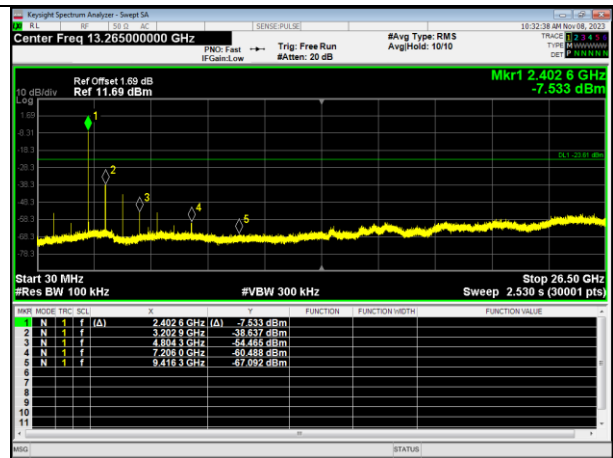

8DPSK on Channel 39

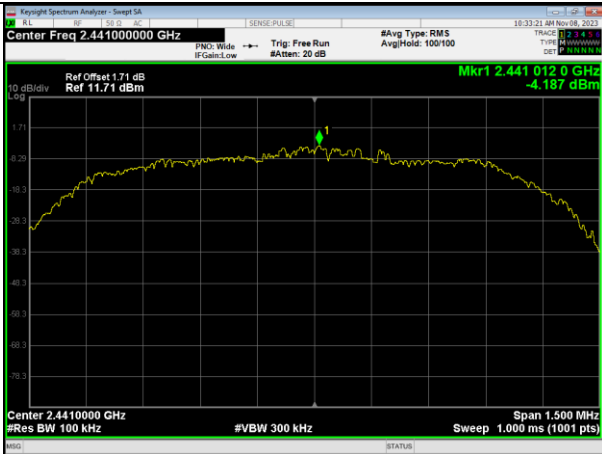

8DPSK on Channel 39

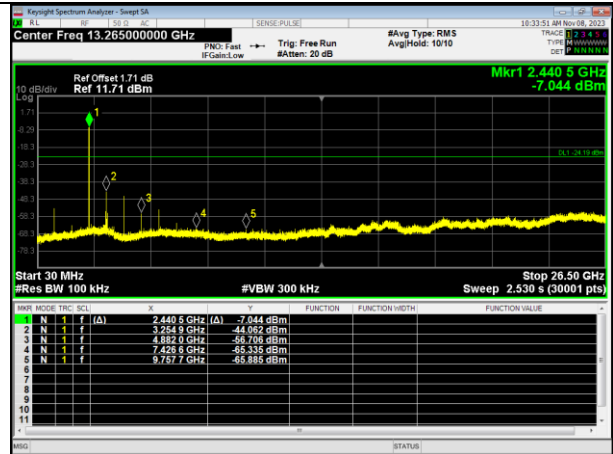

8DPSK on Channel 78

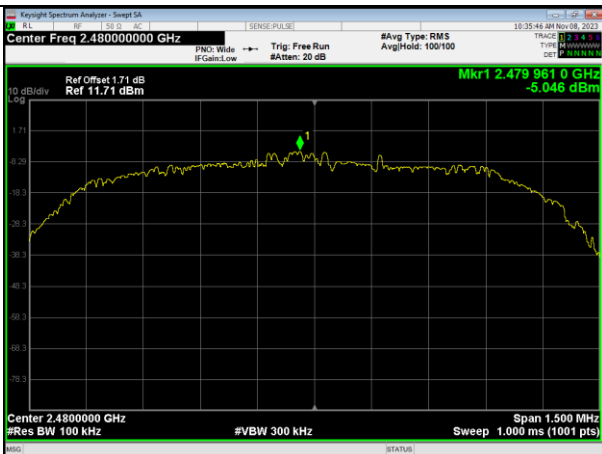

8DPSK on Channel 78

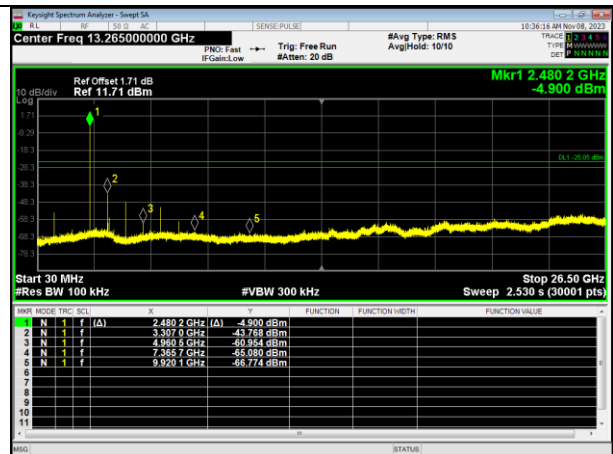

6 Photographs of the Test Setup

Reference to the appendix Test Setup Photos for details.

7 Photographs of the EUT

Reference to the appendix External Photos and Internal Photos for details.

******* END OF REPORT *******