

TEST REPORT

FCC ID	2AUARSCANPLUS	
Test Report No	TCT211020E054	
Date of issue	Nov. 11, 2021	
Testing laboratory	SHENZHEN TONGCE TESTING LAB	
Testing location/ address:	TCT Testing Industrial Park Fuqiao 5th Industrial Zone, Fuhai Street, Bao'an District Shenzhen, Guangdong, 518103, People's Republic of China	
Applicant's name	THINKCAR TECH CO., LTD.	
Address	2606, building 4, phase II, TiananYungu, Gangtou community, Bantian, Longgang District, Shenzhen, China	
Manufacturer's name ...	THINKCAR TECH CO., LTD.	
Address	2606, building 4, phase II, TiananYungu, Gangtou community, Bantian, Longgang District, Shenzhen, China	
Standard(s)	FCC CFR Title 47 Part 15 Subpart C Section 15.247 FCC KDB 558074 D01 15.247 Meas Guidance v05r02 ANSI C63.10:2013	
Test item description	THINKSCAN PLUS	
Trade Mark	THINKCAR	
Model/Type reference	TKPS6, TKPS2, TKPS4, TKPS5, TKPS7, TKPS9	
Rating(s)	Rechargeable Li-ion battery DC 3.7V	
Date of receipt of test item	Oct. 20, 2021	
Date (s) of performance of test	Oct. 20, 2021 ~ Nov. 11, 2021	
Tested by (+signature) ...	Rleo	
Check by (+signature)	Beryl Zhao	
Approved by (+signature) :	Tomsin	

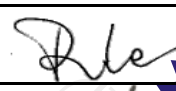
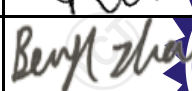
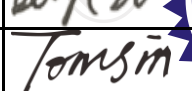

General disclaimer:

This report shall not be reproduced except in full, without the written approval of SHENZHEN TONGCE TESTING LAB. This document may be altered or revised by SHENZHEN TONGCE TESTING LAB personnel only, and shall be noted in the revision section of the document. The test results in the report only apply to the tested sample.

Table of Contents

1. General Product Information	3
1.1. EUT description	3
1.2. Model(s) list.....	3
1.3. Operation Frequency	4
2. Test Result Summary	5
3. General Information.....	6
3.1. Test environment and mode.....	6
3.2. Description of Support Units.....	7
4. Facilities and Accreditations	8
4.1. Facilities	8
4.2. Location	8
4.3. Measurement Uncertainty.....	8
5. Test Results and Measurement Data	9
5.1. Antenna requirement	9
5.2. Conducted Emission.....	10
5.3. Maximum Conducted (Average) Output Power	11
5.4. Emission Bandwidth	15
5.5. Power Spectral Density.....	16
5.6. Conducted Band Edge and Spurious Emission Measurement	17
5.7. Radiated Spurious Emission Measurement.....	19
Appendix A: Test Result of Conducted Test	
Appendix B: Photographs of Test Setup	
Appendix C: Photographs of EUT	

1. General Product Information

1.1. EUT description

Test item description	THINKSCAN PLUS
Model/Type reference.....	TKPS6
Sample Number.....	TCT211020E032-0101
Operation Frequency	2412MHz~2462MHz (802.11b/802.11g/802.11n(HT20)) 2422MHz~2452MHz (802.11n(HT40))
Channel Separation.....	5MHz
Number of Channel	11 for 802.11b/802.11g/802.11n(HT20) 7 for 802.11n(HT40)
Modulation Technology	802.11b: Direct Sequence Spread Spectrum (DSSS) 802.11g/802.11n: Orthogonal Frequency Division Multiplexing(OFDM)
Data speed	802.11b: 1Mbps, 2Mbps, 5.5Mbps, 11Mbps 802.11g: 6Mbps, 9Mbps, 12Mbps, 18Mbps, 24Mbps, 36Mbps, 48Mbps, 54Mbps 802.11n: Up to 150Mbps
Antenna Type.....	Internal Antenna
Antenna Gain.....	1dBi
Rating(s).....	Rechargeable Li-ion battery DC 3.7V

Note: The antenna gain listed in this report is provided by applicant, and the test laboratory is not responsible for this parameter.

1.2. Model(s) list

No.	Model No.	Tested with
1	TKPS6	<input checked="" type="checkbox"/>
Other models	TKPS2, TKPS4, TKPS5, TKPS7, TKPS9	<input type="checkbox"/>

Note: TKPS6 is tested model, other models are derivative models. The models are identical in circuit and PCB layout, different on the model names. So the test data of TKPS6 can represent the remaining models.

1.3. Operation Frequency

For 802.11b/g/n(HT20)

Channel	Frequency	Channel	Frequency	Channel	Frequency	Channel	Frequency
1	2412MHz	4	2427MHz	7	2442MHz	10	2457MHz
2	2417MHz	5	2432MHz	8	2447MHz	11	2462MHz
3	2422MHz	6	2437MHz	9	2452MHz	--	--

For 802.11n (HT40)

Channel	Frequency	Channel	Frequency	Channel	Frequency	Channel	Frequency
--	--	4	2427MHz	7	2442MHz	--	--
--	--	5	2432MHz	8	2447MHz	--	--
3	2422MHz	6	2437MHz	9	2452MHz		

Note:

In section 15.31(m), regards to the operating frequency range over 10 MHz, the Lowest frequency, the middle frequency, and the highest frequency of channel were selected to perform the test, and the selected channel see below:

802.11b/802.11g/802.11n (HT20)

Channel	Frequency
The lowest channel	2412MHz
The middle channel	2437MHz
The Highest channel	2462MHz

802.11n (HT40)

Channel	Frequency
The lowest channel	2422MHz
The middle channel	2437MHz
The Highest channel	2452MHz

2. Test Result Summary

Requirement	CFR 47 Section	Result
Antenna requirement	§15.203/§15.247 (c)	PASS
AC Power Line Conducted Emission	§15.207	PASS
Conducted Peak Output Power	§15.247 (b)(3)	PASS
6dB Emission Bandwidth	§15.247 (a)(2)	PASS
Power Spectral Density	§15.247 (e)	PASS
Band Edge	§15.247(d)	PASS
Spurious Emission	§15.205/§15.209	PASS

Note:

1. PASS: Test item meets the requirement.
2. Fail: Test item does not meet the requirement.
3. N/A: Test case does not apply to the test object.
4. The test result judgment is decided by the limit of test standard.

3. General Information

3.1. Test environment and mode

Operating Environment:		
Condition	Conducted Emission	Radiated Emission
Temperature:	27.5 °C	24.3 °C
Humidity:	56 % RH	54 % RH
Atmospheric Pressure:	1010 mbar	1010 mbar
Test Software:		
Software Information:	Engineering mode	
Power Level:	Default	
Test Mode:		
Conducted Emission:	Charging	
Engineering mode:	Keep the EUT in continuous transmitting by select channel and modulations with Fully-charged battery	
<p>The sample was placed 0.8m & 1.5m for the measurement below & above 1GHz above the ground plane of 3m chamber. Measurements in both horizontal and vertical polarities were performed. During the test, each emission was maximized by: having the EUT continuously working, investigated all operating modes, rotated about all 3 axis (X, Y & Z) and considered typical configuration to obtain worst position, manipulating interconnecting cables, rotating the turntable, varying antenna height from 1m to 4m in both horizontal and vertical polarizations. The emissions worst-case(Z axis) are shown in Test Results of the following pages.</p>		

We have verified the construction and function in typical operation. All the test modes were carried out with the EUT in transmitting operation, which was shown in this test report and defined as follows:

Per-scan all kind of data rate in lowest channel, and found the follow list which it was worst case.

Mode	Data rate
802.11b	1Mbps
802.11g	6Mbps
802.11n(H20)	6.5Mbps
802.11n(H40)	13.5Mbps

3.2. Description of Support Units

The EUT has been tested as an independent unit together with other necessary accessories or support units. The following support units or accessories were used to form a representative test configuration during the tests.

Equipment	Model No.	Serial No.	FCC ID	Trade Name
Adapter	JD-050200	2012010907576735	/	JD

Note:

1. All the equipment/cables were placed in the worst-case configuration to maximize the emission during the test.
2. Grounding was established in accordance with the manufacturer's requirements and conditions for the intended use.
3. For conducted measurements (Output Power, 6dB Emission Bandwidth, Power Spectral Density, Spurious Emissions), the antenna of EUT is connected to the test equipment via temporary antenna connector, the antenna connector is soldered on the antenna port of EUT, and the temporary antenna connector is listed in the Test Instruments.

4. Facilities and Accreditations

4.1. Facilities

The test facility is recognized, certified, or accredited by the following organizations:

- FCC - Registration No.: 645098

SHENZHEN TONGCE TESTING LAB

Designation Number: CN1205

The testing lab has been registered and fully described in a report with the (FCC) Federal Communications Commission. The acceptance letter from the FCC is maintained in our files.

- IC - Registration No.: 10668A-1

SHENZHEN TONGCE TESTING LAB

CAB identifier: CN0031

The testing lab has been registered by Certification and Engineering Bureau of Industry Canada for radio equipment testing.

4.2. Location

SHENZHEN TONGCE TESTING LAB

Address: TCT Testing Industrial Park Fuqiao 5th Industrial Zone, Fuhai Street, Bao'an District Shenzhen, Guangdong, 518103, People's Republic of China

TEL: +86-755-27673339

4.3. Measurement Uncertainty

The reported uncertainty of measurement $y \pm U$, where expanded uncertainty U is based on a standard uncertainty multiplied by a coverage factor of $k=2$, providing a level of confidence of approximately 95 %.

No.	Item	MU
1	Conducted Emission	± 3.10 dB
2	RF power, conducted	± 0.12 dB
3	Spurious emissions, conducted	± 0.11 dB
4	All emissions, radiated(<1 GHz)	± 4.56 dB
5	All emissions, radiated(1 GHz - 18 GHz)	± 4.22 dB
6	All emissions, radiated(18 GHz- 40 GHz)	± 4.36 dB

5. Test Results and Measurement Data

5.1. Antenna requirement

Standard requirement:

FCC Part15 C Section 15.203 /247(c)

15.203 requirement:

An intentional radiator shall be designed to ensure that no antenna other than that furnished by the responsible party shall be used with the device. The use of a permanently attached antenna or of an antenna that uses a unique coupling to the intentional radiator, the manufacturer may design the unit so that a broken antenna can be replaced by the user, but the use of a standard antenna jack or electrical connector is prohibited.

15.247(c) (1)(i) requirement:

(i) Systems operating in the 2400-2483.5 MHz band that is used exclusively for fixed. Point-to-point operations may employ transmitting antennas with directional gain greater than 6dBi provided the maximum conducted output power of the intentional radiator is reduced by 1 dB for every 3 dB that the directional gain of the antenna exceeds 6dBi.

E.U.T Antenna:

The WIFI antenna is Internal antenna which permanently attached, and the best case gain of the antenna is 1dBi.



5.2. Conducted Emission

5.2.1. Test Specification

Test Requirement:	FCC Part15 C Section 15.207														
Test Method:	ANSI C63.10:2013														
Frequency Range:	150 kHz to 30 MHz														
Receiver setup:	RBW=9 kHz, VBW=30 kHz, Sweep time=auto														
Limits:	<table border="1"> <thead> <tr> <th rowspan="2">Frequency range (MHz)</th> <th colspan="2">Limit (dBuV)</th> </tr> <tr> <th>Quasi-peak</th> <th>Average</th> </tr> </thead> <tbody> <tr> <td>0.15-0.5</td> <td>66 to 56*</td> <td>56 to 46*</td> </tr> <tr> <td>0.5-5</td> <td>56</td> <td>46</td> </tr> <tr> <td>5-30</td> <td>60</td> <td>50</td> </tr> </tbody> </table>	Frequency range (MHz)	Limit (dBuV)		Quasi-peak	Average	0.15-0.5	66 to 56*	56 to 46*	0.5-5	56	46	5-30	60	50
Frequency range (MHz)	Limit (dBuV)														
	Quasi-peak	Average													
0.15-0.5	66 to 56*	56 to 46*													
0.5-5	56	46													
5-30	60	50													
Test Setup:	<p><i>Remark</i> E.U.T: Equipment Under Test LISN: Line Impedance Stabilization Network Test table height=0.8m</p>														
Test Mode:	Charging + transmitting with modulation														
Test Procedure:	<ol style="list-style-type: none"> 1. The E.U.T is connected to the main power through a line impedance stabilization network (L.I.S.N.). This provides a 50ohm/50uH coupling impedance for the measuring equipment. 2. The peripheral devices are also connected to the main power through a LISN that provides a 50ohm/50uH coupling impedance with 50ohm termination. (Please refer to the block diagram of the test setup and photographs). 3. Both sides of A.C. line are checked for maximum conducted interference. In order to find the maximum emission, the relative positions of equipment and all of the interface cables must be changed according to ANSI C63.10: 2013 on conducted measurement. 														
Test Result:	PASS														

5.2.2. Test Instruments

Conducted Emission Shielding Room Test Site (843)				
Equipment	Manufacturer	Model	Serial Number	Calibration Due
EMI Test Receiver	R&S	ESCI3	100898	Jul. 07, 2022
Line Impedance Stabilisation Newtork(LISN)	Schwarzbeck	NSLK 8126	8126453	Mar. 11, 2022
Line-5	TCT	CE-05	N/A	Jul. 07, 2022
EMI Test Software	Shurple Technology	EZ-EMC	N/A	N/A

5.2.3. Test data

Please refer to following diagram for individual

Conducted Emission on Line Terminal of the power line (150 kHz to 30MHz)

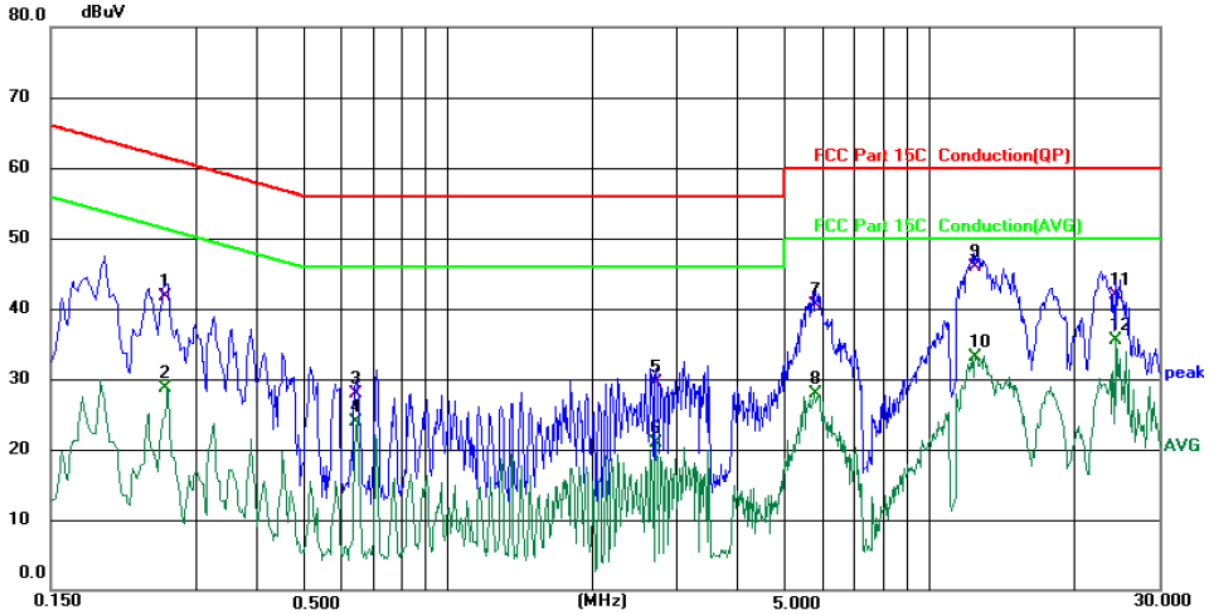

Site 844 Shielding Room Phase: **L1** Temperature: 27.5 (°C) Humidity: 56 %

Limit: FCC Part 15C Conduction(QP) Power: DC 5 V(Adapter Input AC 120 V/60 Hz)

No.	Mk.	Freq.	Reading Level	Correct Factor	Measurement	Limit	Over	Detector	Comment
		MHz	dBuV	dB	dBuV	dBuV	dB		
1		0.2580	32.35	9.35	41.70	61.50	-19.80	QP	
2		0.2580	19.35	9.35	28.70	51.50	-22.80	AVG	
3		0.6460	18.71	9.19	27.90	56.00	-28.10	QP	
4		0.6460	14.80	9.19	23.99	46.00	-22.01	AVG	
5		2.7100	20.00	9.50	29.50	56.00	-26.50	QP	
6		2.7100	11.41	9.50	20.91	46.00	-25.09	AVG	
7		5.8020	31.04	9.56	40.60	60.00	-19.40	QP	
8		5.8020	18.37	9.56	27.93	50.00	-22.07	AVG	
9	*	12.4460	36.27	9.63	45.90	60.00	-14.10	QP	
10		12.4460	23.50	9.63	33.13	50.00	-16.87	AVG	
11		24.3500	32.18	9.82	42.00	60.00	-18.00	QP	
12		24.3500	25.67	9.82	35.49	50.00	-14.51	AVG	

Note:

Freq. = Emission frequency in MHz

Reading level (dBuV) = Receiver reading

Corr. Factor (dB) = LISN factor + Cable loss

Measurement (dBuV) = Reading level (dBuV) + Corr. Factor (dB)

Limit (dBuV) = Limit stated in standard

Margin (dB) = Measurement (dBuV) – Limits (dBuV)

Q.P. =Quasi-Peak

AVG =average

* is meaning the worst frequency has been tested in the frequency range 150 kHz to 30MHz.

Conducted Emission on Neutral Terminal of the power line (150 kHz to 30MHz)

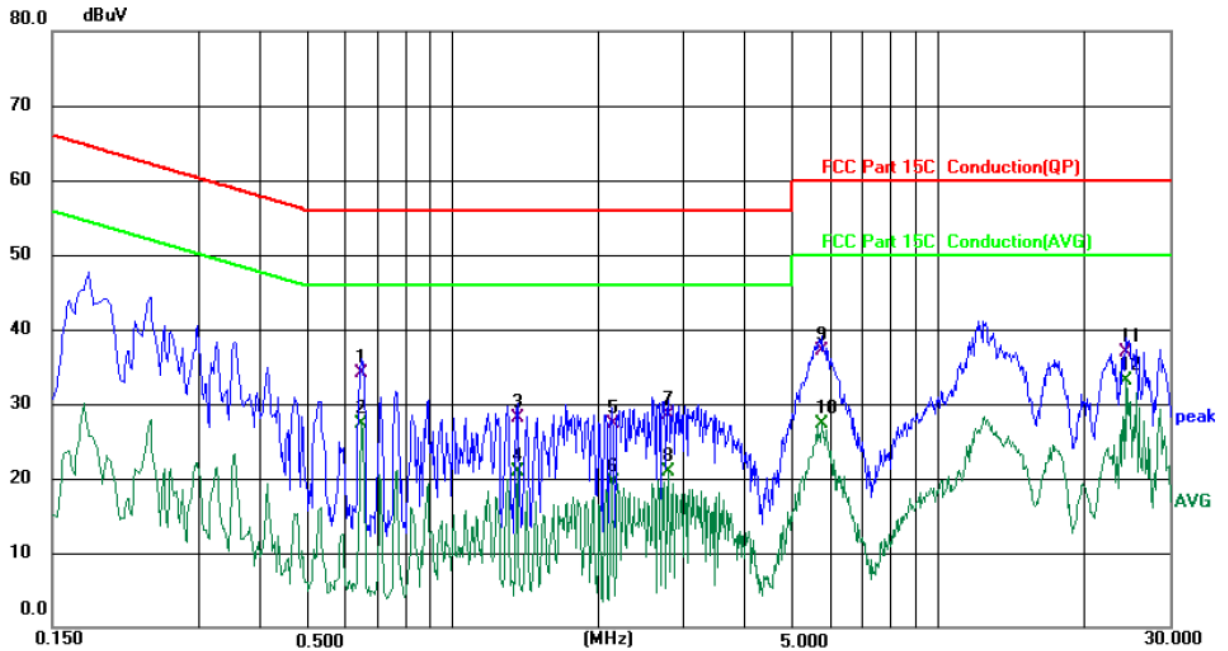

Site 844 Shielding Room Phase: *N* Temperature: 27.5 (°C) Humidity: 56 %
 Limit: FCC Part 15C Conduction(QP) Power: DC 5 V(Adapter Input AC 120 V/60 Hz)

No.	Mk.	Freq. MHz	Reading Level dBuV	Correct Factor dB	Measure- ment dBuV	Limit dBuV	Over dB	Detector	Comment
1		0.6500	24.89	9.21	34.10	56.00	-21.90	QP	
2		0.6500	18.05	9.21	27.26	46.00	-18.74	AVG	
3		1.3619	18.77	9.33	28.10	56.00	-27.90	QP	
4		1.3619	11.58	9.33	20.91	46.00	-25.09	AVG	
5		2.1340	18.02	9.38	27.40	56.00	-28.60	QP	
6		2.1340	10.12	9.38	19.50	46.00	-26.50	AVG	
7		2.7860	19.09	9.41	28.50	56.00	-27.50	QP	
8		2.7860	11.50	9.41	20.91	46.00	-25.09	AVG	
9		5.7460	27.60	9.50	37.10	60.00	-22.90	QP	
10		5.7460	17.71	9.50	27.21	50.00	-22.79	AVG	
11		24.3500	27.08	9.82	36.90	60.00	-23.10	QP	
12	*	24.3500	23.22	9.82	33.04	50.00	-16.96	AVG	

Note:

- Freq. = Emission frequency in MHz
- Reading level (dBuV) = Receiver reading
- Corr. Factor (dB) = LISN factor + Cable loss
- Measurement (dBuV) = Reading level (dBuV) + Corr. Factor (dB)
- Limit (dBuV) = Limit stated in standard
- Margin (dB) = Measurement (dBuV) – Limits (dBuV)
- Q.P. =Quasi-Peak
- AVG =average
- * is meaning the worst frequency has been tested in the frequency range 150 kHz to 30MHz.

5.3. Maximum Conducted (Average) Output Power

5.3.1. Test Specification

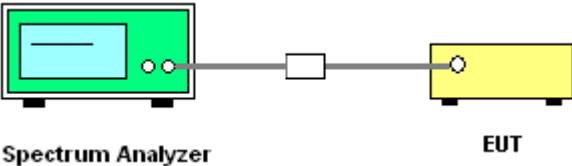
Test Requirement:	FCC Part15 C Section 15.247 (b)(3)
Test Method:	KDB 558074 D01 v05r02
Limit:	30dBm
Test Setup:	 <p>The diagram illustrates the test setup. On the left is a green Spectrum Analyzer. A cable connects it to a white attenuator. Another cable connects the attenuator to a yellow EUT (Equipment Under Test) on the right.</p>
Test Mode:	Transmitting mode with modulation
Test Procedure:	<ol style="list-style-type: none"> 1. The RF output of EUT was connected to the spectrum analyzer by RF cable and attenuator. The path loss was compensated to the results for each measurement. 2. Set to the maximum power setting and enable the EUT transmit continuously. 3. Measure the conducted output power and record the results in the test report.
Test Result:	PASS

5.3.2. Test Instruments

RF Test Room				
Equipment	Manufacturer	Model	Serial Number	Calibration Due
Spectrum Analyzer	Agilent	N9020A	MY49100619	Jul. 18, 2022
RF Cable (9KHz-26.5GHz)	TCT	RE-06	N/A	Jul. 18, 2022
Antenna Connector	TCT	RFC-01	N/A	Jul. 18, 2022

5.4. Emission Bandwidth

5.4.1. Test Specification

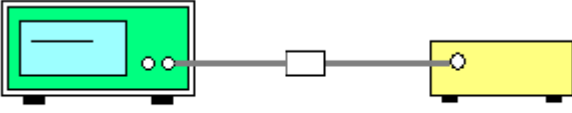
Test Requirement:	FCC Part15 C Section 15.247 (a)(2)
Test Method:	KDB 558074 D01 v05r02
Limit:	>500kHz
Test Setup:	 <p style="text-align: center;">Spectrum Analyzer EUT</p>
Test Mode:	Transmitting mode with modulation
Test Procedure:	<ol style="list-style-type: none"> 1. Set to the maximum power setting and enable the EUT transmit continuously. 2. Make the measurement with the spectrum analyzer's resolution bandwidth (RBW) = 100 kHz. Set the Video bandwidth (VBW) = 300 kHz. In order to make an accurate measurement. The 6dB bandwidth must be greater than 500 kHz. 3. Measure and record the results in the test report.
Test Result:	PASS

5.4.2. Test Instruments

RF Test Room				
Equipment	Manufacturer	Model	Serial Number	Calibration Due
Spectrum Analyzer	Agilent	N9020A	MY49100619	Jul. 18, 2022
RF Cable (9KHz-26.5GHz)	TCT	RE-06	N/A	Jul. 18, 2022
Antenna Connector	TCT	RFC-01	N/A	Jul. 18, 2022

5.5. Power Spectral Density

5.5.1. Test Specification

Test Requirement:	FCC Part15 C Section 15.247 (e)
Test Method:	KDB 558074
Limit:	The average power spectral density shall not be greater than 8dBm in any 3kHz band at any time interval of continuous transmission.
Test Setup:	 <p style="text-align: center;">Spectrum Analyzer EUT</p>
Test Mode:	Transmitting mode with modulation
Test Procedure:	<ol style="list-style-type: none"> 1. The RF output of EUT was connected to the spectrum analyzer by RF cable and attenuator. The path loss was compensated to the results for each measurement. 2. Set to the maximum power setting and enable the EUT transmit continuously. 3. Make the measurement with the spectrum analyzer's resolution bandwidth (RBW): $3 \text{ kHz} \leq \text{RBW} \leq 100 \text{ kHz}$. Video bandwidth $\text{VBW} \geq 3 \times \text{RBW}$. Set the span to at least 1.5 times the OBW. 4. Detector = RMS, Sweep time = auto couple. 5. Employ trace averaging (RMS) mode over a minimum of 100 traces. Use the peak marker function to determine the maximum power level. 6. Measure and record the results in the test report.
Test Result:	PASS

5.5.2. Test Instruments

RF Test Room				
Equipment	Manufacturer	Model	Serial Number	Calibration Due
Spectrum Analyzer	Agilent	N9020A	MY49100619	Jul. 18, 2022
RF Cable (9KHz-26.5GHz)	TCT	RE-06	N/A	Jul. 18, 2022
Antenna Connector	TCT	RFC-01	N/A	Jul. 18, 2022

5.6. Conducted Band Edge and Spurious Emission Measurement

5.6.1. Test Specification

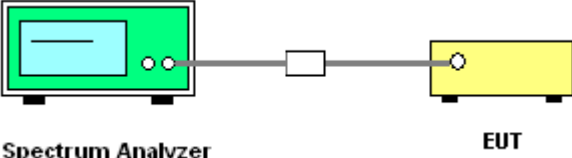
Test Requirement:	FCC Part15 C Section 15.247 (d)
Test Method:	KDB558074
Limit:	In any 100 kHz bandwidth outside of the authorized frequency band, the emissions which fall in the non-restricted bands shall be attenuated at least 20 dB / 30dB relative to the maximum PSD level in 100 kHz by RF conducted measurement and radiated emissions which fall in the restricted bands, as defined in Section 15.205(a), must also comply with the radiated emission limits specified in Section 15.209(a).
Test Setup:	 <p style="text-align: center;">Spectrum Analyzer EUT</p>
Test Mode:	Transmitting mode with modulation
Test Procedure:	<ol style="list-style-type: none"> 1. The RF output of EUT was connected to the spectrum analyzer by RF cable and attenuator. The path loss was compensated to the results for each measurement. 2. Set to the maximum power setting and enable the EUT transmit continuously. 3. Set RBW = 100 kHz, VBW=300 kHz, Peak Detector. Unwanted Emissions measured in any 100 kHz bandwidth outside of the authorized frequency band shall be attenuated by at least 20 dB relative to the maximum in-band peak PSD level in 100 kHz when maximum peak conducted output power procedure is used. If the transmitter complies with the conducted power limits based on the use of RMS averaging over a time interval, the attenuation required under this paragraph shall be 30 dB instead of 20 dB per 15.247(d). 4. Measure and record the results in the test report. 5. The RF fundamental frequency should be excluded against the limit line in the operating frequency band.
Test Result:	PASS

5.6.2. Test Instruments

RF Test Room				
Equipment	Manufacturer	Model	Serial Number	Calibration Due
Spectrum Analyzer	Agilent	N9020A	MY49100619	Jul. 18, 2022
RF Cable (9KHz-26.5GHz)	TCT	RE-06	N/A	Jul. 18, 2022
Antenna Connector	TCT	RFC-01	N/A	Jul. 18, 2022

5.7. Radiated Spurious Emission Measurement

5.7.1. Test Specification

Test Requirement:	FCC Part15 C Section 15.209					
Test Method:	ANSI C63.10: 2013					
Frequency Range:	9 kHz to 25 GHz					
Measurement Distance:	3 m					
Antenna Polarization:	Horizontal & Vertical					
Operation mode:	Transmitting mode with modulation					
Receiver Setup:	Frequency	Detector	RBW	VBW	Remark	
	9kHz- 150kHz	Quasi-peak	200Hz	1kHz	Quasi-peak Value	
	150kHz-30MHz	Quasi-peak	9kHz	30kHz	Quasi-peak Value	
	30MHz-1GHz	Quasi-peak	120KHz	300KHz	Quasi-peak Value	
	Above 1GHz	Peak	1MHz	3MHz	Peak Value	
		Peak	1MHz	10Hz	Average Value	
Limit:	Frequency	Field Strength (microvolts/meter)	Measurement Distance (meters)			
	0.009-0.490	2400/F(KHz)	300			
	0.490-1.705	24000/F(KHz)	30			
	1.705-30	30	30			
	30-88	100	3			
	88-216	150	3			
	216-960	200	3			
	Above 960	500	3			
	Frequency	Field Strength (microvolts/meter)	Measurement Distance (meters)	Detector		
	Above 1GHz	500	3	Average		
	5000	3	Peak			
Test setup:	For radiated emissions below 30MHz					
	<p>Distance = 3m</p> <p>0.8m</p> <p>Turn table</p> <p>1m</p> <p>Ground Plane</p> <p>Computer</p> <p>Pre-Amplifier</p> <p>Receiver</p>					
	30MHz to 1GHz					

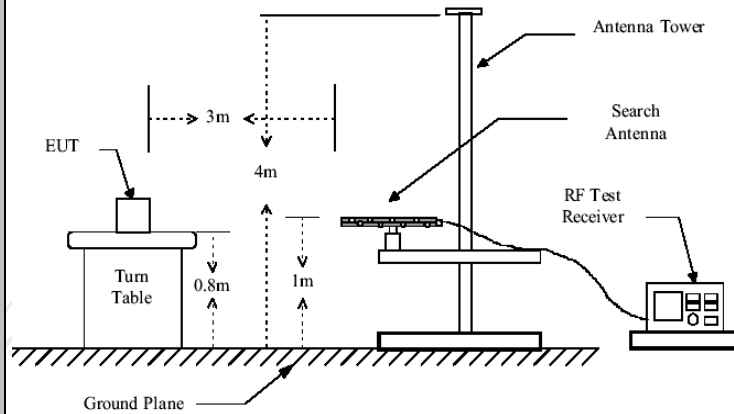

Above 1GHz

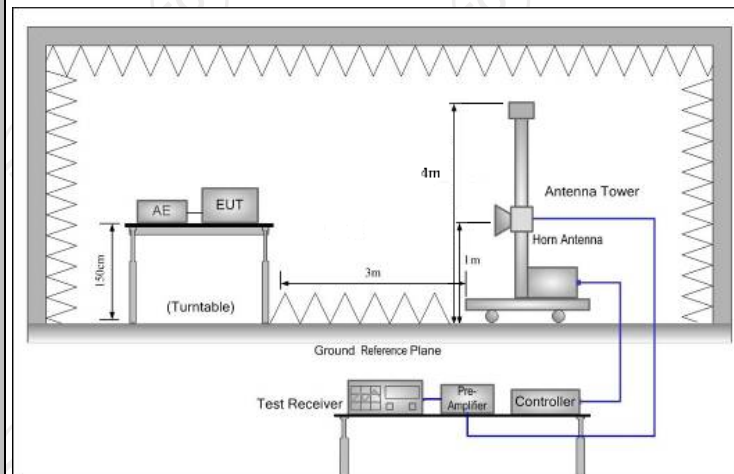

Test Procedure:

1. For the radiated emission test below 1GHz:
The EUT was placed on a turntable with 0.8 meter above ground. The EUT was set 3 meters from the interference receiving antenna, which was mounted on the top of a variable height antenna tower. The EUT was arranged to its worst case and then tune the antenna tower (from 1 m to 4 m) and turntable (from 0 degree to 360 degrees) to find the maximum reading. A pre-amp and a high PASS filter are used for the test in order to get better signal level.
For the radiated emission test above 1GHz:
Place the measurement antenna on a turntable with 1.5 meter above ground, which is away from each area of the EUT determined to be a source of emissions at the specified measurement distance, while keeping the measurement antenna aimed at the source of emissions at each frequency of significant emissions, with polarization oriented for maximum response. The measurement antenna may have to be higher or lower than the EUT, depending on the radiation pattern of the emission and staying aimed at the emission source for receiving the maximum signal. The final measurement antenna elevation shall be that which

	<p>maximizes the emissions. The measurement antenna elevation for maximum emissions shall be restricted to a range of heights of from 1 m to 4 m above the ground or reference ground plane.</p> <p>3. Corrected Reading: Antenna Factor + Cable Loss + Read Level - Preamp Factor = Level</p> <p>4. For measurement below 1GHz, If the emission level of the EUT measured by the peak detector is 3 dB lower than the applicable limit, the peak emission level will be reported. Otherwise, the emission measurement will be repeated using the quasi-peak detector and reported.</p> <p>5. Use the following spectrum analyzer settings:</p> <ul style="list-style-type: none"> (1) Span shall wide enough to fully capture the emission being measured; (2) Set RBW=120 kHz for $f < 1$ GHz; VBW \geq RBW; Sweep = auto; Detector function = peak; Trace = max hold; (3) Set RBW = 1 MHz, VBW= 3MHz for $f > 1$ GHz for peak measurement. <p>For average measurement: VBW = 10 Hz, when duty cycle is no less than 98 percent. VBW $\geq 1/T$, when duty cycle is less than 98 percent where T is the minimum transmission duration over which the transmitter is on and is transmitting at its maximum power control level for the tested mode of operation.</p>
Test results:	PASS

5.7.2. Test Instruments

Radiated Emission Test Site (966)				
Name of Equipment	Manufacturer	Model	Serial Number	Calibration Due
EMI Test Receiver	R&S	ESIB7	100197	Jul. 07, 2022
Spectrum Analyzer	R&S	FSQ40	200061	Jul. 07, 2022
Pre-amplifier	SKET	LNPA_0118G-45	SK2021012102	Mar. 11, 2022
Pre-amplifier	SKET	LNPA_1840G-50	SK202109203500	Apr. 08, 2022
Pre-amplifier	HP	8447D	2727A05017	Jul. 07, 2022
Loop antenna	ZHINAN	ZN30900A	12024	Sep. 05, 2022
Broadband Antenna	Schwarzbeck	VULB9163	340	Sep. 04, 2022
Horn Antenna	Schwarzbeck	BBHA 9120D	631	Sep. 04, 2022
Horn Antenna	Schwarzbeck	BBHA 9170	00956	Apr. 10, 2023
Antenna Mast	Keleto	RE-AM	N/A	N/A
Coaxial cable	SKET	RC_DC18G-N	N/A	Apr. 08, 2022
Coaxial cable	SKET	RC-DC18G-N	N/A	Apr. 08, 2022
Coaxial cable	SKET	RC-DC40G-N	N/A	Jul. 07, 2022
EMI Test Software	Shurple Technology	EZ-EMC	N/A	N/A

5.7.3. Test Data

Please refer to following diagram for individual
Below 1GHz

Horizontal:

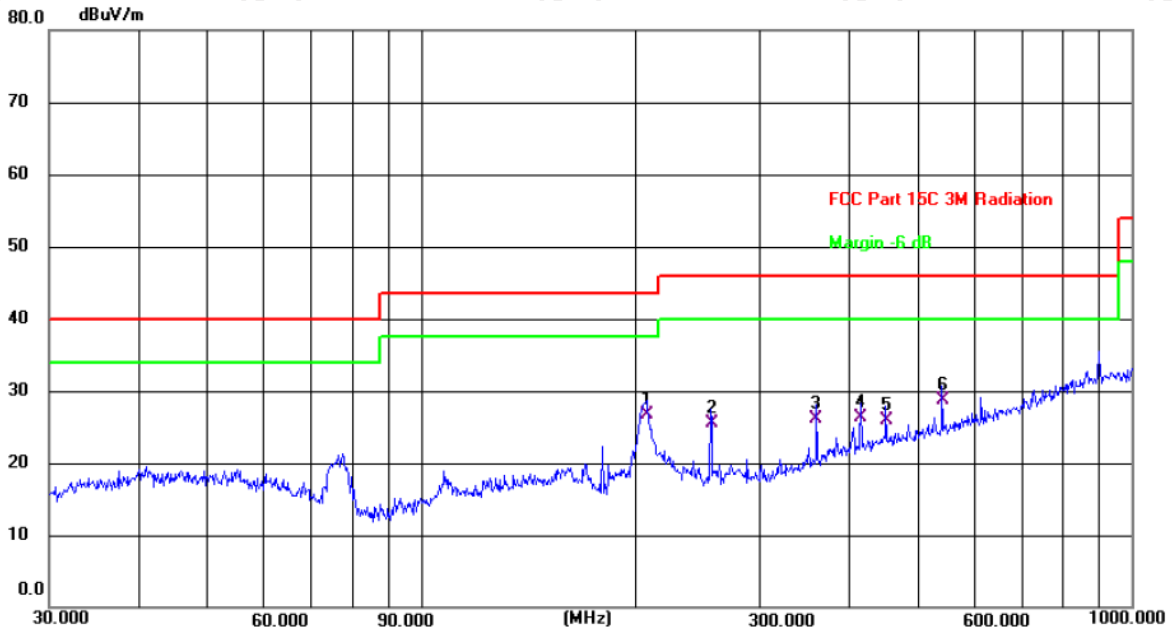

Site #2

Polarization: *Horizontal*

Temperature: 24.3(C)

Limit: FCC Part 15C 3M Radiation

Power: DC 3.7 V

Humidity: 54 %

No.	Frequency (MHz)	Reading (dBuV)	Factor (dB/m)	Level (dBuV/m)	Limit (dBuV/m)	Margin (dB)	Detector	P/F	Remark
1 *	207.8501	15.97	10.73	26.70	43.50	-16.80	QP	P	
2	255.6231	12.99	12.59	25.58	46.00	-20.42	QP	P	
3	360.4476	10.32	15.86	26.18	46.00	-19.82	QP	P	
4	416.1791	8.63	17.61	26.24	46.00	-19.76	QP	P	
5	451.1350	7.65	18.35	26.00	46.00	-20.00	QP	P	
6	541.3725	8.61	20.16	28.77	46.00	-17.23	QP	P	

Vertical:

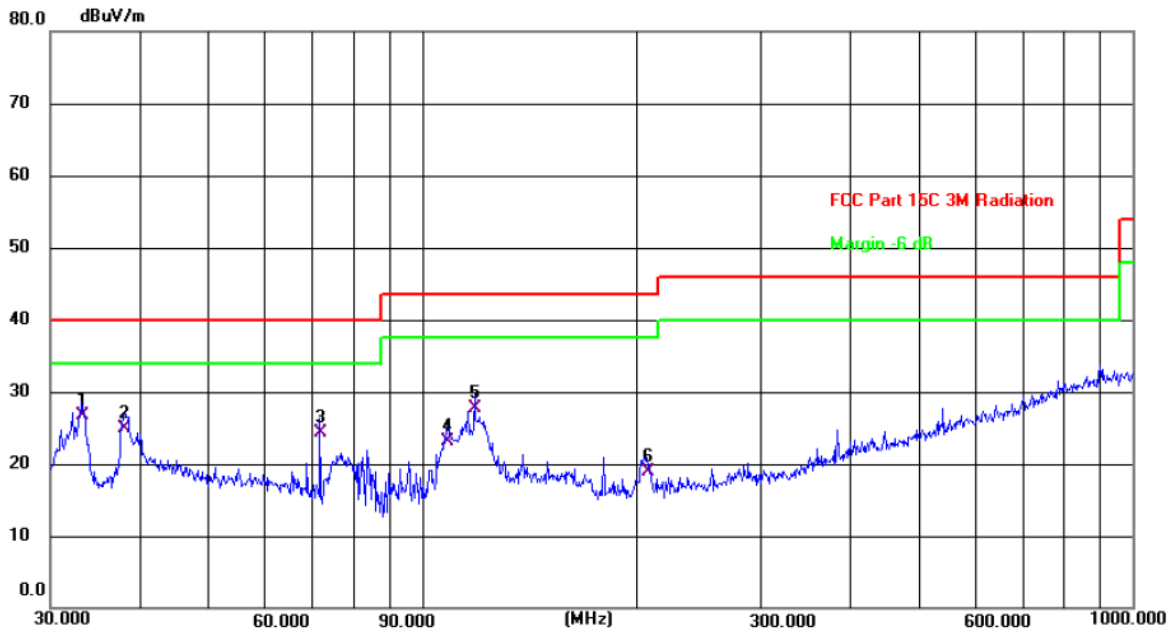

Site #2 Polarization: **Vertical** Temperature: 24.3(C)
 Limit: FCC Part 15C 3M Radiation Power: DC 3.7 V Humidity: 54 %

No.	Frequency (MHz)	Reading (dBuV)	Factor (dB/m)	Level (dBuV/m)	Limit (dBuV/m)	Margin (dB)	Detector	P/F	Remark
1 *	33.2112	13.99	12.74	26.73	40.00	-13.27	QP	P	
2	38.0783	11.18	13.69	24.87	40.00	-15.13	QP	P	
3	71.8320	13.53	10.77	24.30	40.00	-15.70	QP	P	
4	108.6470	12.10	11.06	23.16	43.50	-20.34	QP	P	
5	118.6014	15.89	11.84	27.73	43.50	-15.77	QP	P	
6	207.1226	8.21	10.69	18.90	43.50	-24.60	QP	P	

Note: 1. The low frequency, which started from 9KHz~30MHz, was pre-scanned and the result which was 20dB lower than the limit line per 15.31(o) was not reported

2. Measurements were conducted in all three channels (high, middle, low) and all modulation(802.11b, 802.11g, 802.11n(HT20), 802.11n(HT40)), and the worst case Mode (Highest channel and 802.11b) was submitted only.

3. Freq. = Emission frequency in MHz

Measurement (dBuV/m) = Reading level (dBuV) + Corr. Factor (dB)

Correction Factor= Antenna Factor + Cable loss – Pre-amplifier

Limit (dBuV/m) = Limit stated in standard

Margin (dB) = Measurement (dBuV/m) – Limits (dBuV/m)

* is meaning the worst frequency has been tested in the test frequency range

Test Result of Radiated Spurious at Band edges

Lowest channel 2422:

Horizontal:

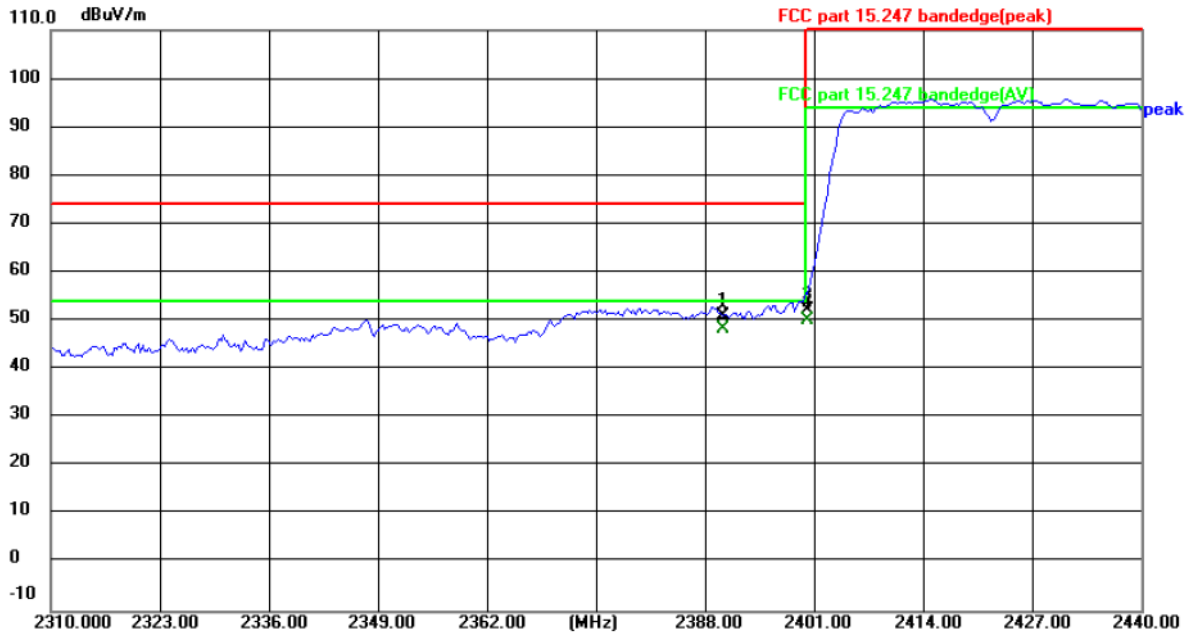

Site: Polarization: *Horizontal* Temperature: 24(°C)
Limit: FCC part 15.247 bandedge(peak) Power: DC 3.7 V Humidity: 52 %

No.	Frequency (MHz)	Reading (dBuV)	Factor (dB/m)	Level (dBuV/m)	Limit (dBuV/m)	Margin (dB)	Detector
1	2390.000	66.02	-14.99	51.03	74.00	-22.97	peak
2	2390.000	63.35	-14.99	48.36	54.00	-5.64	AVG
3	2400.000	67.11	-14.95	52.16	74.00	-21.84	peak
4 *	2400.000	65.01	-14.95	50.06	54.00	-3.94	AVG



Vertical:

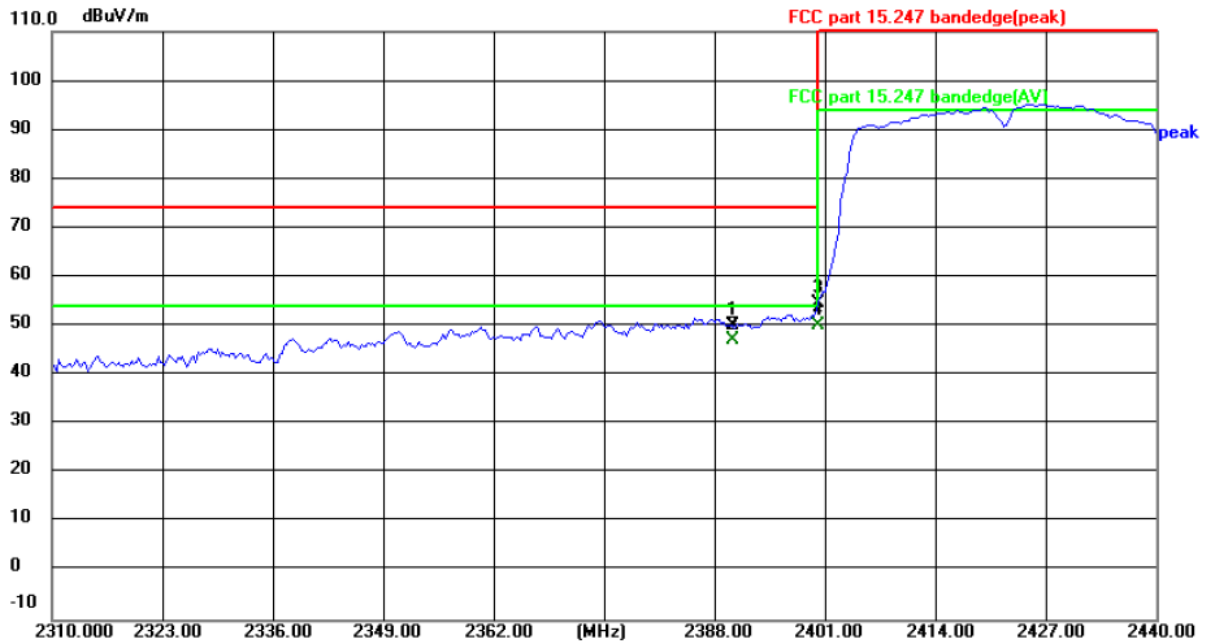

Site: Polarization: **Vertical** Temperature: 24(°C)
 Limit: FCC part 15.247 bandedge(peak) Power: DC 3.7 V Humidity: 52 %

No.	Frequency (MHz)	Reading (dBuV)	Factor (dB/m)	Level (dBuV/m)	Limit (dBuV/m)	Margin (dB)	Detector
1	2390.000	65.06	-14.99	50.07	74.00	-23.93	peak
2	2390.000	62.25	-14.99	47.26	54.00	-6.74	AVG
3	2400.000	69.75	-14.95	54.80	74.00	-19.20	peak
4 *	2400.000	65.11	-14.95	50.16	54.00	-3.84	AVG

Highest channel 2452:

Horizontal:

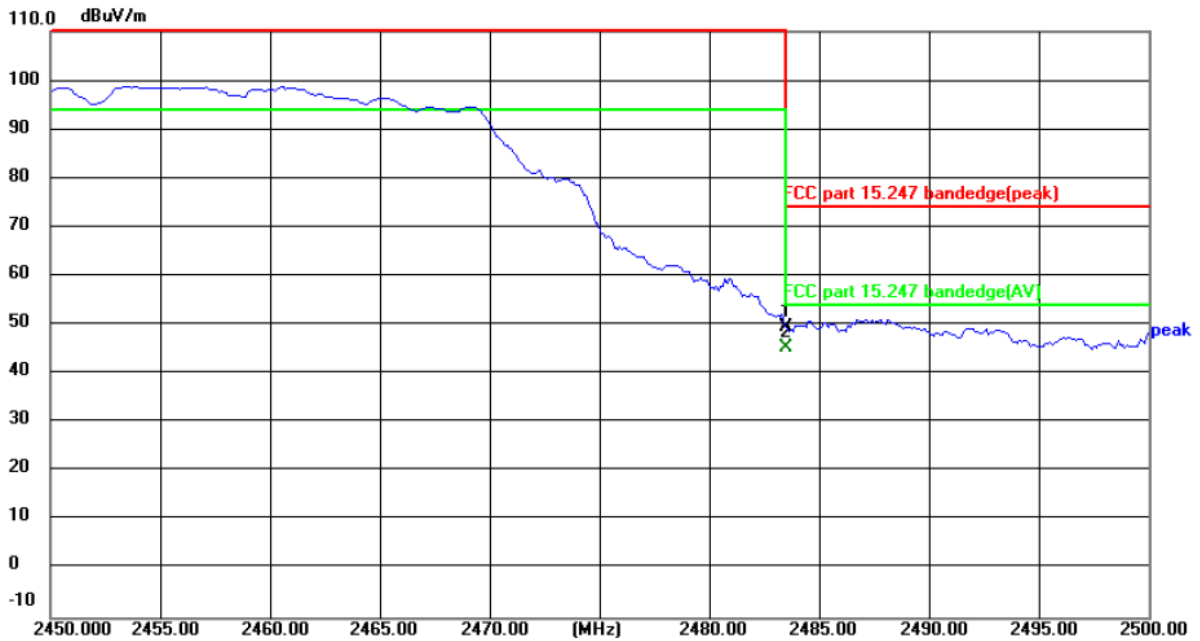

Site: Polarization: **Horizontal** Temperature: 24(°C)
 Limit: FCC part 15.247 bandedge(peak) Power: DC 3.7 V Humidity: 52 %

No.	Frequency (MHz)	Reading (dBuV)	Factor (dB/m)	Level (dBuV/m)	Limit (dBuV/m)	Margin (dB)	Detector
1	2483.500	64.19	-14.58	49.61	74.00	-24.39	peak
2 *	2483.500	59.86	-14.58	45.28	54.00	-8.72	AVG



Vertical:

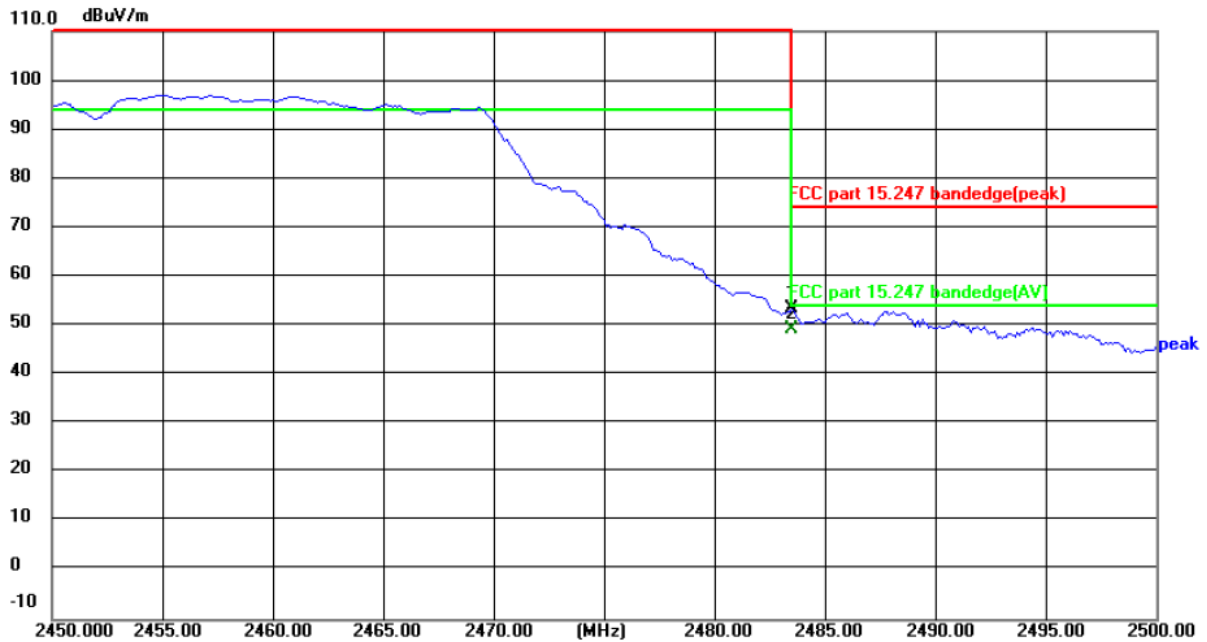

Site: Polarization: **Vertical** Temperature: 24(°C)
 Limit: FCC part 15.247 bandedge(peak) Power: DC 3.7 V Humidity: 52 %

No.	Frequency (MHz)	Reading (dBuV)	Factor (dB/m)	Level (dBuV/m)	Limit (dBuV/m)	Margin (dB)	Detector
1	2483.500	68.09	-14.58	53.51	74.00	-20.49	peak
2 *	2483.500	63.84	-14.58	49.26	54.00	-4.74	AVG

Note:

1. Peak Final Emission Level=Peak Reading + Correction Factor;
2. Correction Factor= Antenna Factor + Cable loss – Pre-amplifier
3. Measurements were conducted in all modulation(802.11b, 802.11g, 802.11n(HT20), 802.11n(HT40)), and the worst case Mode 802.11n(HT40) was submitted only.

Above 1GHz

Modulation Type: 802.11b

Low channel: 2412 MHz

Frequency (MHz)	Ant. Pol. H/V	Peak reading (dB μ V)	AV reading (dB μ V)	Correction Factor (dB/m)	Emission Level		Peak limit (dB μ V/m)	AV limit (dB μ V/m)	Margin (dB)
					Peak (dB μ V/m)	AV (dB μ V/m)			
4824	H	45.40	---	0.75	46.15	---	74	54	-7.85
7236	H	35.98	---	9.87	45.85	---	74	54	-8.15
---	H	---	---	---	---	---	---	---	---
4824	V	44.30	---	0.75	45.05	---	74	54	-8.95
7236	V	33.69	---	9.87	43.56	---	74	54	-10.44
---	V	---	---	---	---	---	---	---	---

Middle channel: 2437MHz

Frequency (MHz)	Ant. Pol. H/V	Peak reading (dB μ V)	AV reading (dB μ V)	Correction Factor (dB/m)	Emission Level		Peak limit (dB μ V/m)	AV limit (dB μ V/m)	Margin (dB)
					Peak (dB μ V/m)	AV (dB μ V/m)			
4874	H	45.09	---	0.97	46.06	---	74	54	-7.94
7311	H	36.01	---	9.83	45.84	---	74	54	-8.16
---	H	---	---	---	---	---	---	---	---
4874	V	45.12	---	0.97	46.09	---	74	54	-7.91
7311	V	35.41	---	9.83	45.24	---	74	54	-8.76
---	V	---	---	---	---	---	---	---	---

High channel: 2462 MHz

Frequency (MHz)	Ant. Pol. H/V	Peak reading (dB μ V)	AV reading (dB μ V)	Correction Factor (dB/m)	Emission Level		Peak limit (dB μ V/m)	AV limit (dB μ V/m)	Margin (dB)
					Peak (dB μ V/m)	AV (dB μ V/m)			
4924	H	44.13	---	1.18	45.31	---	74	54	-8.69
7386	H	34.52	---	10.07	44.59	---	74	54	-9.41
---	H	---	---	---	---	---	---	---	---
4924	V	46.18	---	1.18	47.36	---	74	54	-6.64
7386	V	34.94	---	10.07	45.01	---	74	54	-8.99
---	V	---	---	---	---	---	---	---	---

Note:

1. Emission Level=Peak Reading + Correction Factor; Correction Factor= Antenna Factor + Cable loss – Pre-amplifier
2. Margin (dB) = Emission Level (Peak) (dB μ V/m)-Average limit (dB μ V/m)
3. The emission levels of other frequencies are very lower than the limit and not show in test report.
4. Measurements were conducted from 1 GHz to the 10th harmonic of highest fundamental frequency. The highest test frequency is 25GHz.
5. Data of measurement shown "—" in the above table mean that the reading of emissions is attenuated more than 20 dB below the limits or the field strength is too small to be measured.
6. All the restriction bands are compliance with the limit of 15.209.

Modulation Type: 802.11g

Low channel: 2412 MHz

Frequency (MHz)	Ant. Pol. H/V	Peak reading (dB μ V)	AV reading (dB μ V)	Correction Factor (dB/m)	Emission Level		Peak limit (dB μ V/m)	AV limit (dB μ V/m)	Margin (dB)
					Peak (dB μ V/m)	AV (dB μ V/m)			
4824	H	45.20	---	0.75	45.95	---	74	54	-8.05
7236	H	34.78	---	9.87	44.65	---	74	54	-9.35
---	H	---	---	---	---	---	---	---	---
4824	V	43.86	---	0.75	44.61	---	74	54	-9.39
7236	V	34.22	---	9.87	44.09	---	74	54	-9.91
---	V	---	---	---	---	---	---	---	---

Middle channel: 2437MHz

Frequency (MHz)	Ant. Pol. H/V	Peak reading (dB μ V)	AV reading (dB μ V)	Correction Factor (dB/m)	Emission Level		Peak limit (dB μ V/m)	AV limit (dB μ V/m)	Margin (dB)
					Peak (dB μ V/m)	AV (dB μ V/m)			
4874	H	44.43	---	0.97	45.40	---	74	54	-8.60
7311	H	34.81	---	9.83	44.64	---	74	54	-9.36
---	H	---	---	---	---	---	---	---	---
4874	V	45.15	---	0.97	46.12	---	74	54	-7.88
7311	V	35.78	---	9.83	45.61	---	74	54	-8.39
---	V	---	---	---	---	---	---	---	---

High channel: 2462 MHz

Frequency (MHz)	Ant. Pol. H/V	Peak reading (dB μ V)	AV reading (dB μ V)	Correction Factor (dB/m)	Emission Level		Peak limit (dB μ V/m)	AV limit (dB μ V/m)	Margin (dB)
					Peak (dB μ V/m)	AV (dB μ V/m)			
4924	H	44.75	---	1.18	45.93	---	74	54	-8.07
7386	H	35.94	---	10.07	46.01	---	74	54	-7.99
---	H	---	---	---	---	---	---	---	---
4924	V	45.69	---	1.18	46.87	---	74	54	-7.13
7386	V	34.80	---	10.07	44.87	---	74	54	-9.13
---	V	---	---	---	---	---	---	---	---

Note:

1. Emission Level=Peak Reading + Correction Factor; Correction Factor= Antenna Factor + Cable loss – Pre-amplifier
2. Margin (dB) = Emission Level (Peak) (dB μ V/m)-Average limit (dB μ V/m)
3. The emission levels of other frequencies are very lower than the limit and not show in test report.
4. Measurements were conducted from 1 GHz to the 10th harmonic of highest fundamental frequency. The highest test frequency is 25GHz.
5. Data of measurement shown "---" in the above table mean that the reading of emissions is attenuated more than 20 dB below the limits or the field strength is too small to be measured.
6. All the restriction bands are compliance with the limit of 15.209.

Modulation Type: 802.11n (HT20)

Low channel: 2412 MHz

Frequency (MHz)	Ant. Pol. H/V	Peak reading (dB μ V)	AV reading (dB μ V)	Correction Factor (dB/m)	Emission Level		Peak limit (dB μ V/m)	AV limit (dB μ V/m)	Margin (dB)
					Peak (dB μ V/m)	AV (dB μ V/m)			
4824	H	46.14	---	0.75	46.89	---	74	54	-7.11
7236	H	36.89	---	9.87	46.76	---	74	54	-7.24
---	H	---	---	---	---	---	---	---	---
4824	V	46.07	---	0.75	46.82	---	74	54	-7.18
7236	V	35.36	---	9.87	45.23	---	74	54	-8.77
---	V	---	---	---	---	---	---	---	---

Middle channel: 2437MHz

Frequency (MHz)	Ant. Pol. H/V	Peak reading (dB μ V)	AV reading (dB μ V)	Correction Factor (dB/m)	Emission Level		Peak limit (dB μ V/m)	AV limit (dB μ V/m)	Margin (dB)
					Peak (dB μ V/m)	AV (dB μ V/m)			
4874	H	45.67	---	0.97	46.64	---	74	54	-7.36
7311	H	36.14	---	9.83	45.97	---	74	54	-8.03
---	H	---	---	---	---	---	---	---	---
4874	V	45.25	---	0.97	46.22	---	74	54	-7.78
7311	V	35.09	---	9.83	44.92	---	74	54	-9.08
---	V	---	---	---	---	---	---	---	---

High channel: 2462 MHz

Frequency (MHz)	Ant. Pol. H/V	Peak reading (dB μ V)	AV reading (dB μ V)	Correction Factor (dB/m)	Emission Level		Peak limit (dB μ V/m)	AV limit (dB μ V/m)	Margin (dB)
					Peak (dB μ V/m)	AV (dB μ V/m)			
4924	H	44.88	---	1.18	46.06	---	74	54	-7.94
7386	H	35.90	---	10.07	45.97	---	74	54	-8.03
---	H	---	---	---	---	---	---	---	---
4924	V	43.32	---	1.18	44.50	---	74	54	-9.50
7386	V	34.71	---	10.07	44.78	---	74	54	-9.22
---	V	---	---	---	---	---	---	---	---

Note:

1. Emission Level=Peak Reading + Correction Factor; Correction Factor= Antenna Factor + Cable loss – Pre-amplifier
2. Margin (dB) = Emission Level (Peak) (dB μ V/m)-Average limit (dB μ V/m)
3. The emission levels of other frequencies are very lower than the limit and not show in test report.
4. Measurements were conducted from 1 GHz to the 10th harmonic of highest fundamental frequency. The highest test frequency is 25GHz.
5. Data of measurement shown "---" in the above table mean that the reading of emissions is attenuated more than 20 dB below the limits or the field strength is too small to be measured.
6. All the restriction bands are compliance with the limit of 15.209.

Modulation Type: 802.11n (HT40)

Low channel: 2422 MHz

Frequency (MHz)	Ant. Pol. H/V	Peak reading (dB μ V)	AV reading (dB μ V)	Correction Factor (dB/m)	Emission Level		Peak limit (dB μ V/m)	AV limit (dB μ V/m)	Margin (dB)
					Peak (dB μ V/m)	AV (dB μ V/m)			
4844	H	43.68	---	0.75	44.43	---	74	54	-9.57
7266	H	34.56	---	9.87	44.43	---	74	54	-9.57
---	H	---	---	---	---	---	---	---	---
4824	V	45.91	---	0.75	46.66	---	74	54	-7.34
7236	V	37.07	---	9.87	46.94	---	74	54	-7.06
---	V	---	---	---	---	---	---	---	---

Middle channel: 2437MHz

Frequency (MHz)	Ant. Pol. H/V	Peak reading (dB μ V)	AV reading (dB μ V)	Correction Factor (dB/m)	Emission Level		Peak limit (dB μ V/m)	AV limit (dB μ V/m)	Margin (dB)
					Peak (dB μ V/m)	AV (dB μ V/m)			
4874	H	44.77	---	0.97	45.74	---	74	54	-8.26
7311	H	36.35	---	9.83	46.18	---	74	54	-7.82
---	H	---	---	---	---	---	---	---	---
4874	V	46.59	---	0.97	47.56	---	74	54	-6.44
7311	V	36.04	---	9.83	45.87	---	74	54	-8.13
---	V	---	---	---	---	---	---	---	---

High channel: 2452 MHz

Frequency (MHz)	Ant. Pol. H/V	Peak reading (dB μ V)	AV reading (dB μ V)	Correction Factor (dB/m)	Emission Level		Peak limit (dB μ V/m)	AV limit (dB μ V/m)	Margin (dB)
					Peak (dB μ V/m)	AV (dB μ V/m)			
4904	H	46.13	---	1.18	47.31	---	74	54	-6.69
7356	H	36.96	---	10.07	47.03	---	74	54	-6.97
---	H	---	---	---	---	---	---	---	---
4904	V	45.17	---	1.18	46.35	---	74	54	-7.65
7356	V	34.92	---	10.07	44.99	---	74	54	-9.01
---	V	---	---	---	---	---	---	---	---

Note:

1. Emission Level=Peak Reading + Correction Factor; Correction Factor= Antenna Factor + Cable loss – Pre-amplifier
2. Margin (dB) = Emission Level (Peak) (dB μ V/m)-Average limit (dB μ V/m)
3. The emission levels of other frequencies are very lower than the limit and not show in test report.
4. Measurements were conducted from 1 GHz to the 10th harmonic of highest fundamental frequency. The highest test frequency is 25GHz.
5. Data of measurement shown "---" in the above table mean that the reading of emissions is attenuated more than 20 dB below the limits or the field strength is too small to be measured.
6. All the restriction bands are compliance with the limit of 15.209.

Appendix A: Test Result of Conducted Test

Duty Cycle

Condition	Mode	Frequency (MHz)	Duty Cycle (%)
NVNT	b	2412	100
NVNT	b	2437	100
NVNT	b	2462	100
NVNT	g	2412	100
NVNT	g	2437	100
NVNT	g	2462	100
NVNT	n20	2412	100
NVNT	n20	2437	100
NVNT	n20	2462	100
NVNT	n40	2422	100
NVNT	n40	2437	100
NVNT	n40	2452	100

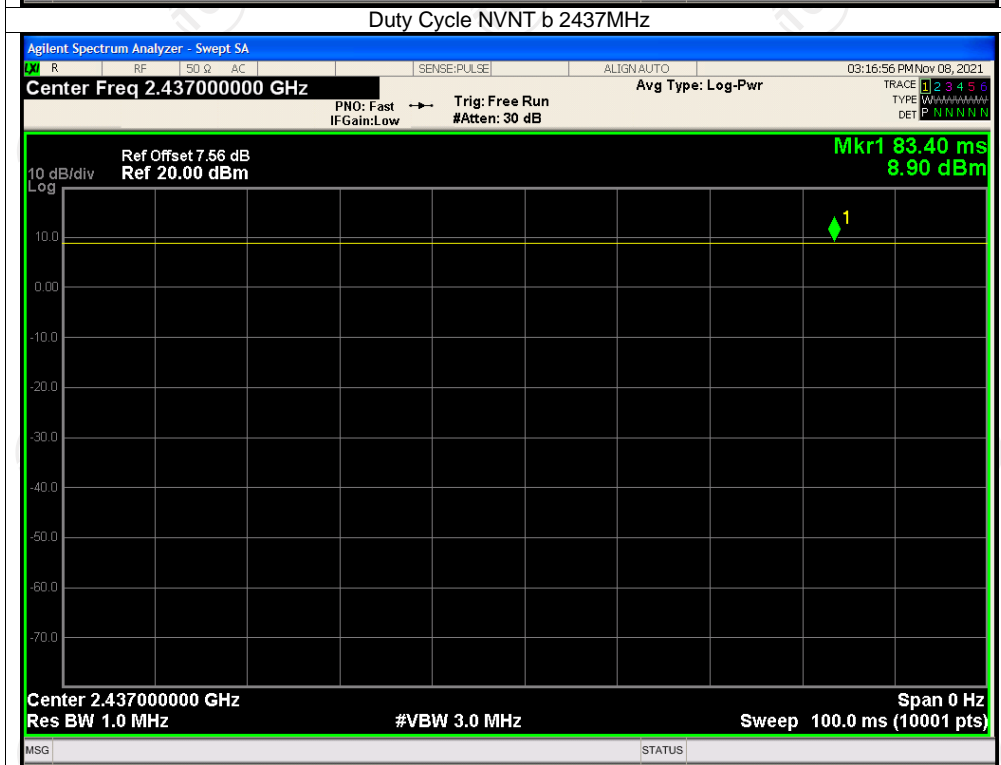
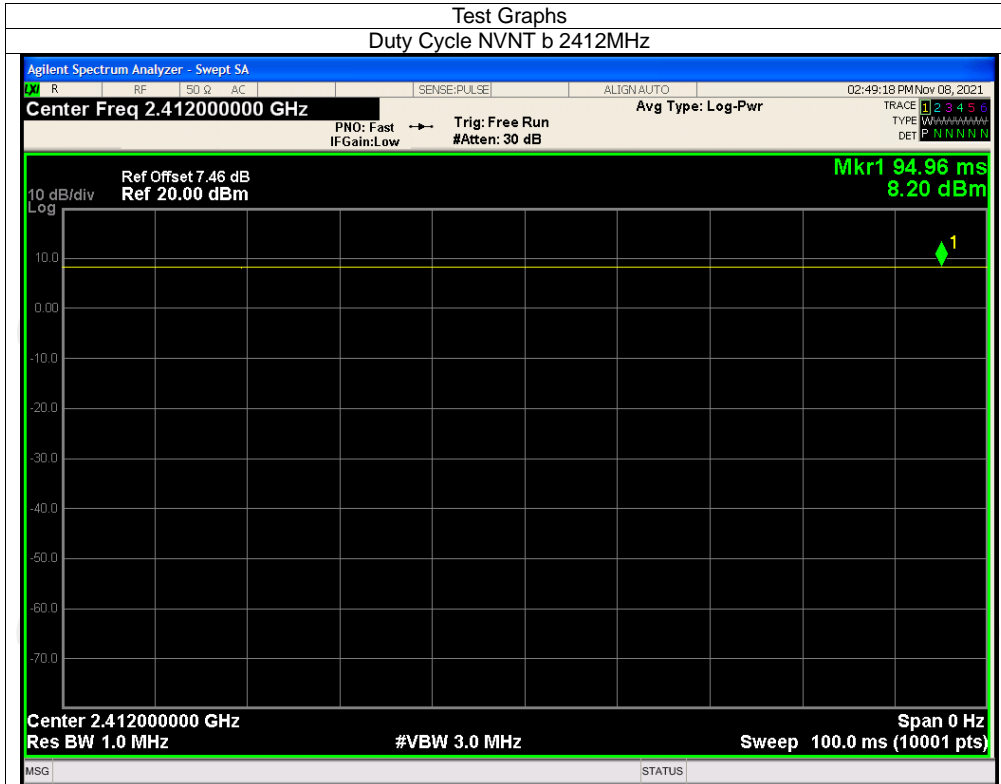

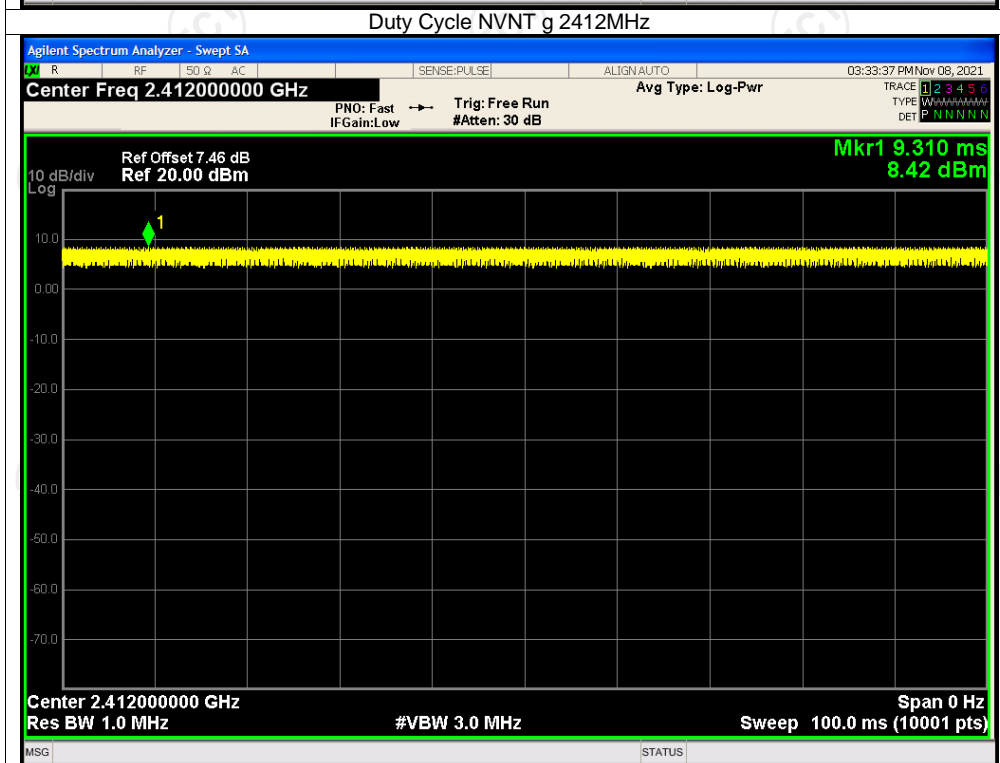
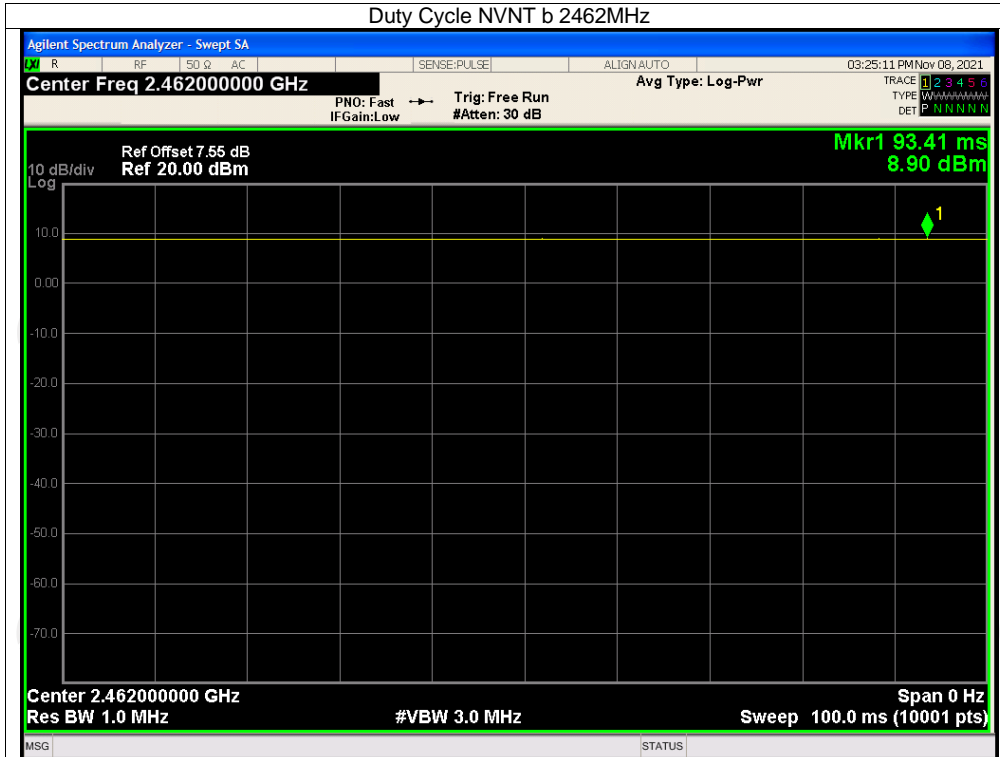

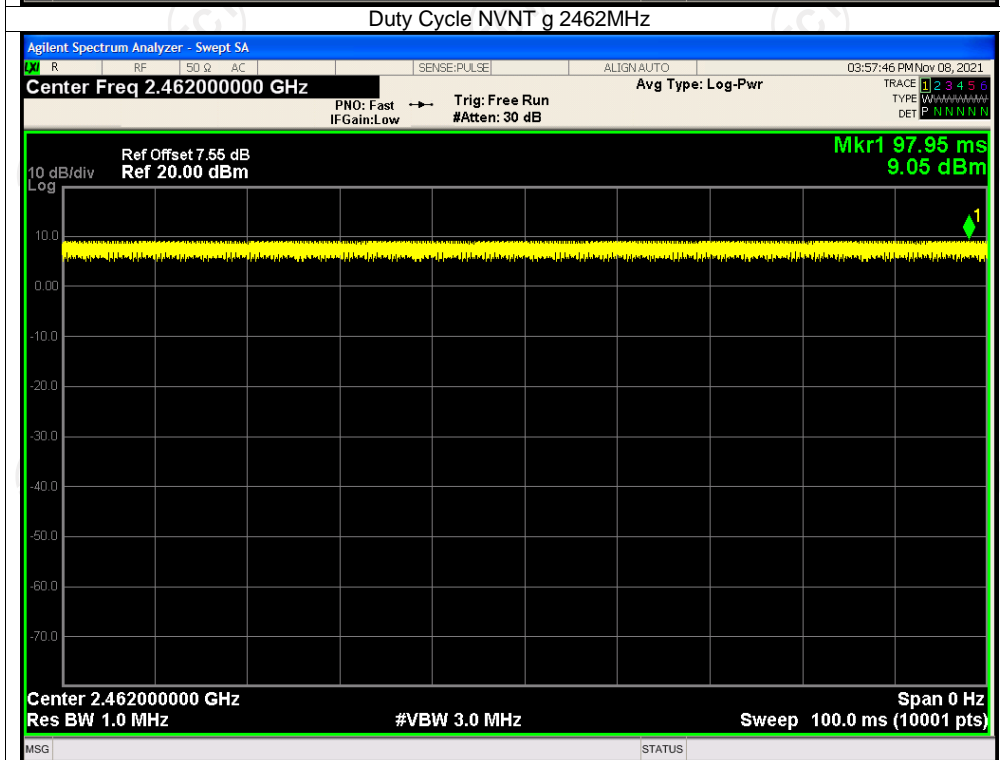
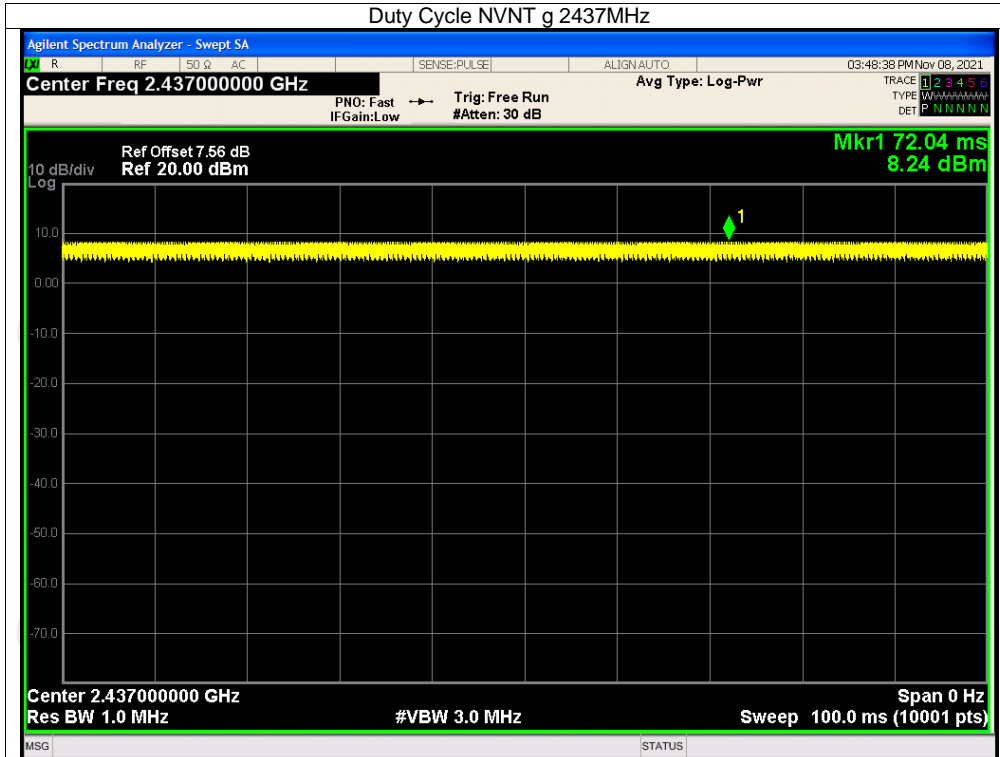

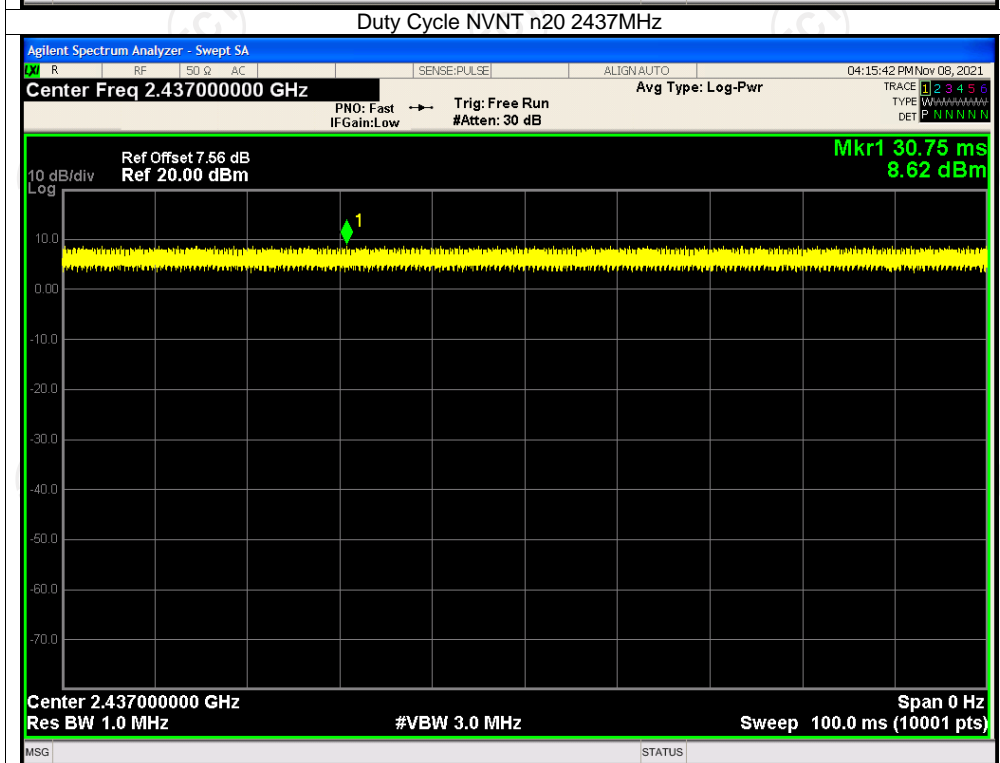
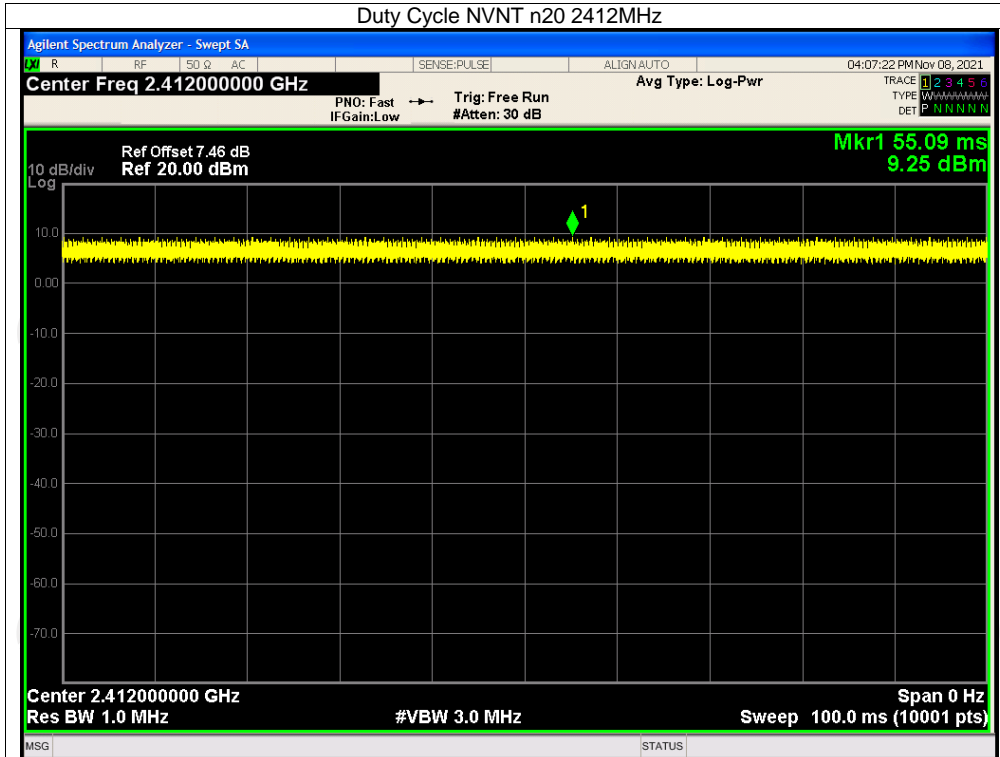

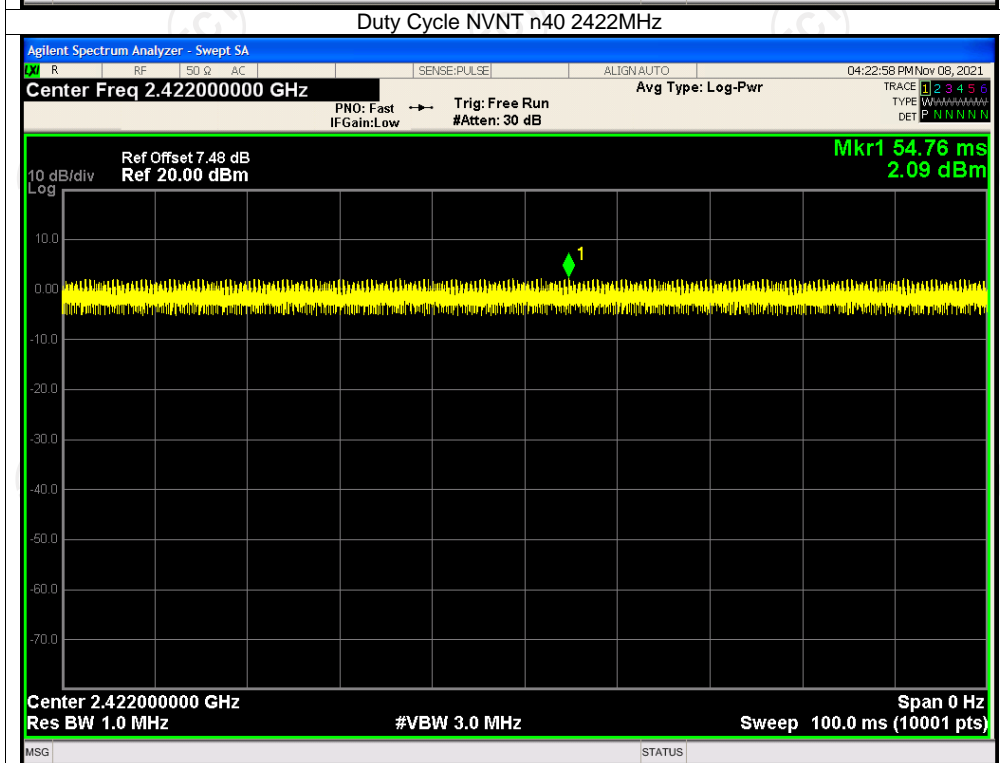
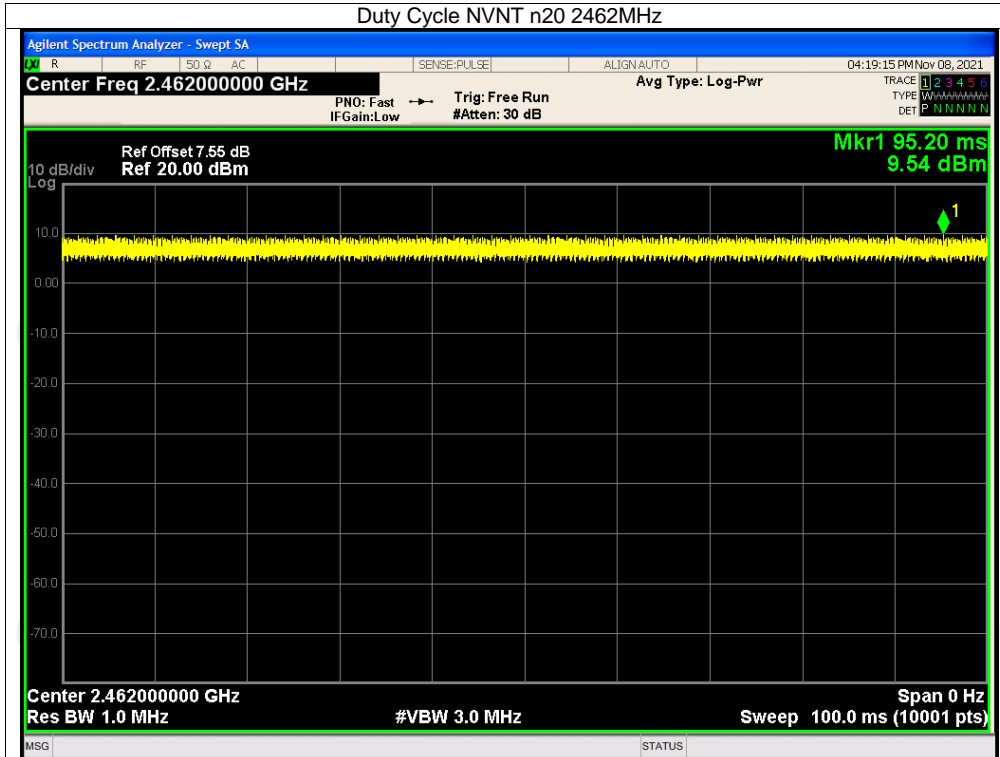

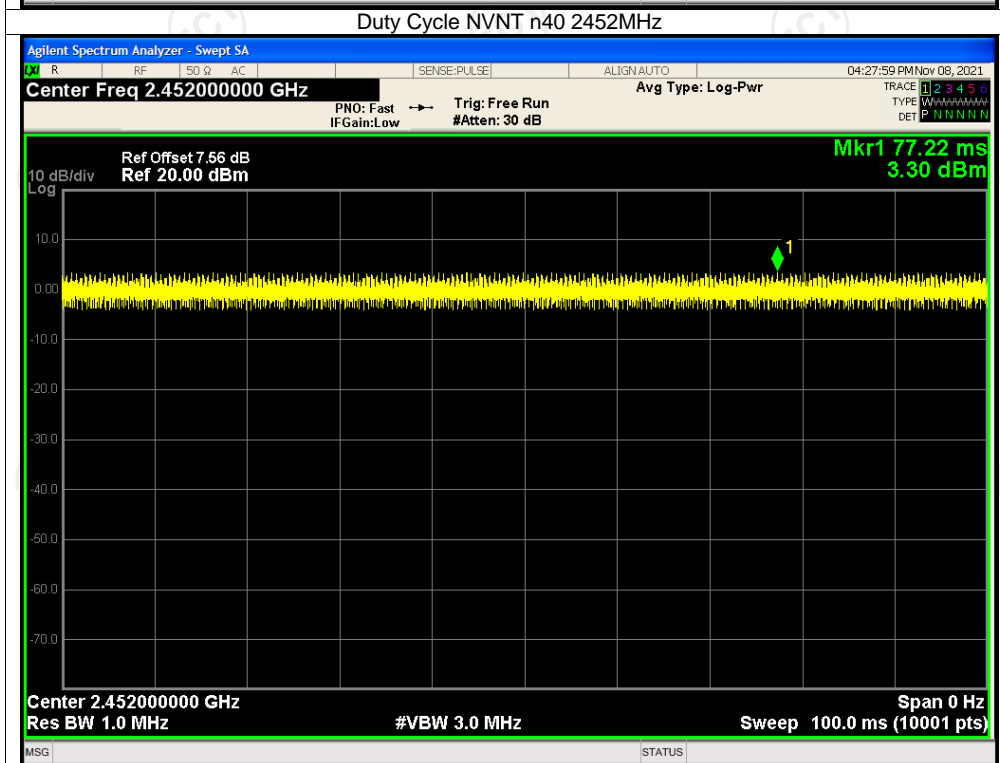
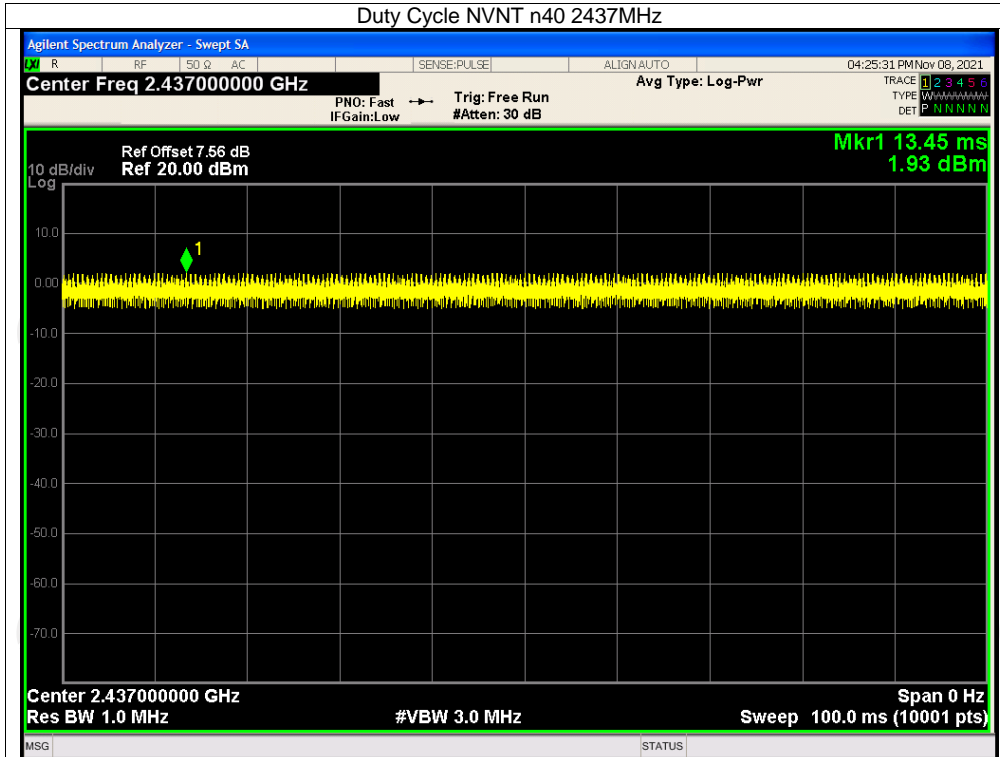

Maximum Conducted Output Power

Condition	Mode	Frequency (MHz)	Conducted Power (dBm)	Limit (dBm)	Verdict
NVNT	b	2412	14.218	30	Pass
NVNT	b	2437	15.174	30	Pass
NVNT	b	2462	15.200	30	Pass
NVNT	g	2412	13.192	30	Pass
NVNT	g	2437	13.178	30	Pass
NVNT	g	2462	13.897	30	Pass
NVNT	n20	2412	13.201	30	Pass
NVNT	n20	2437	12.785	30	Pass
NVNT	n20	2462	13.553	30	Pass
NVNT	n40	2422	12.272	30	Pass
NVNT	n40	2437	12.543	30	Pass
NVNT	n40	2452	12.790	30	Pass

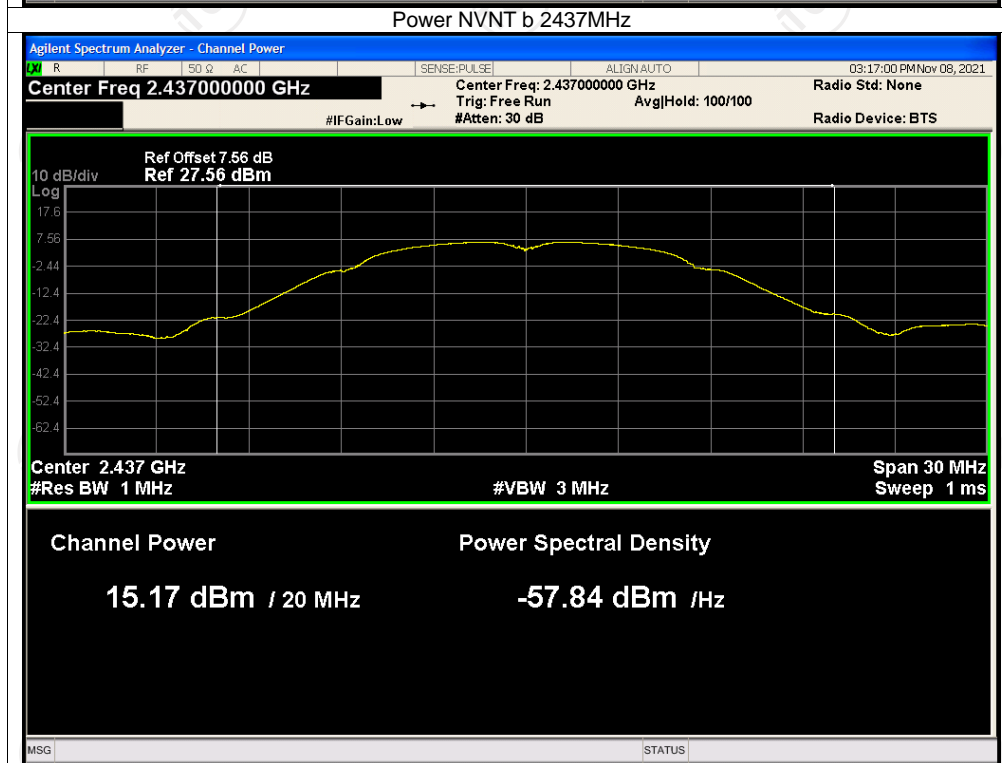
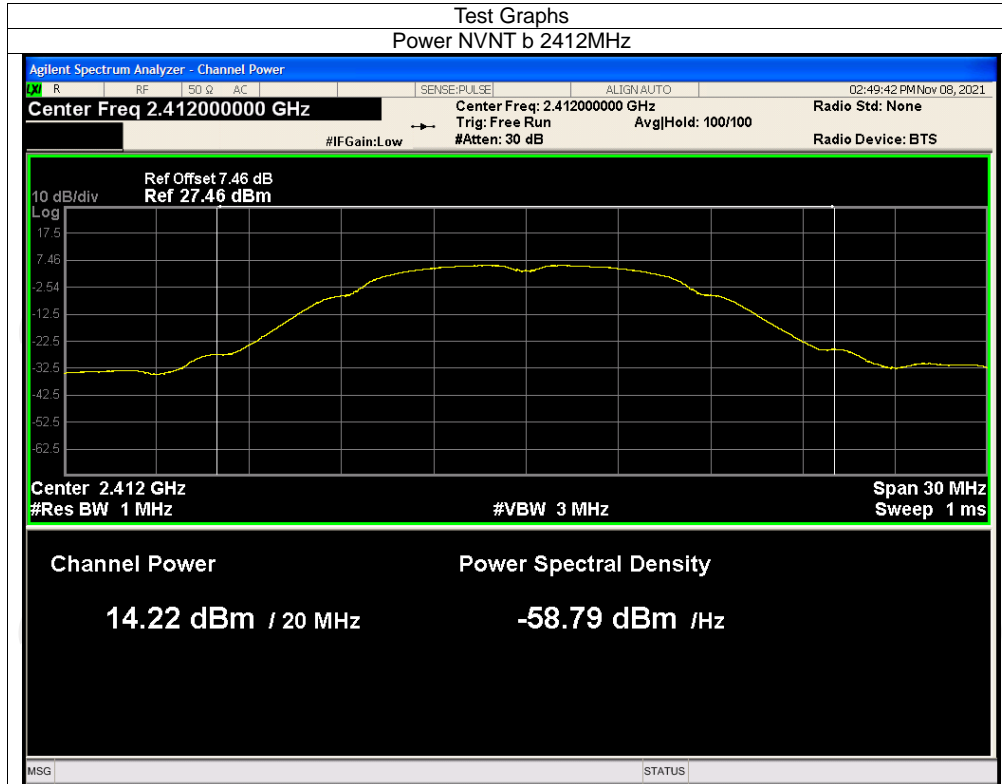

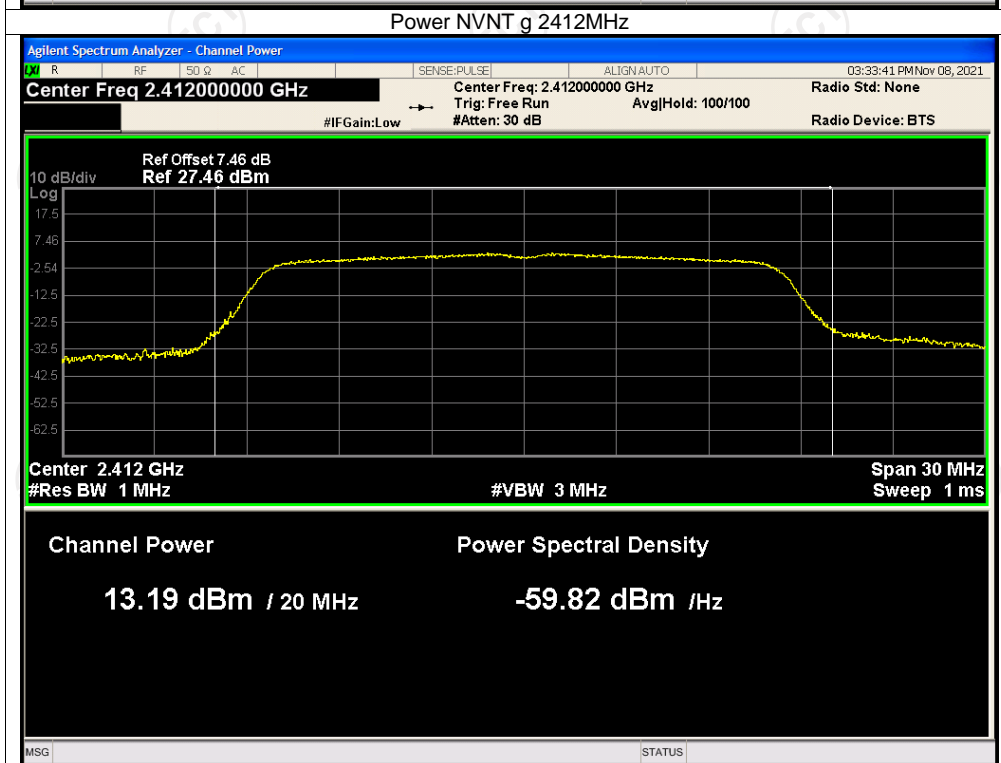
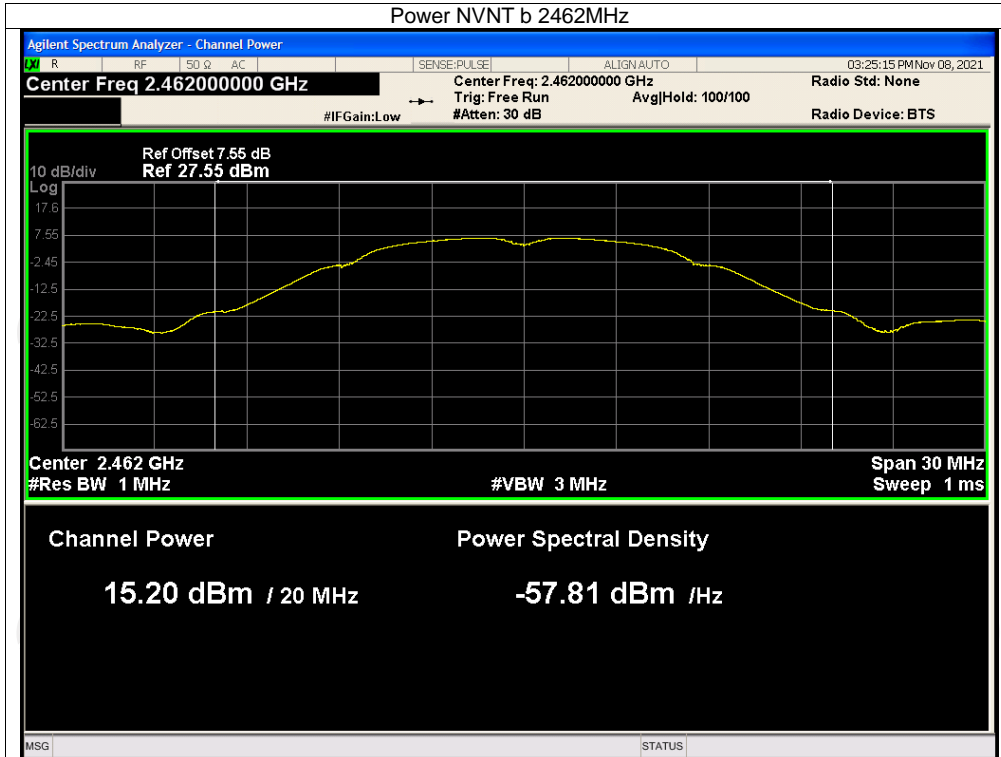

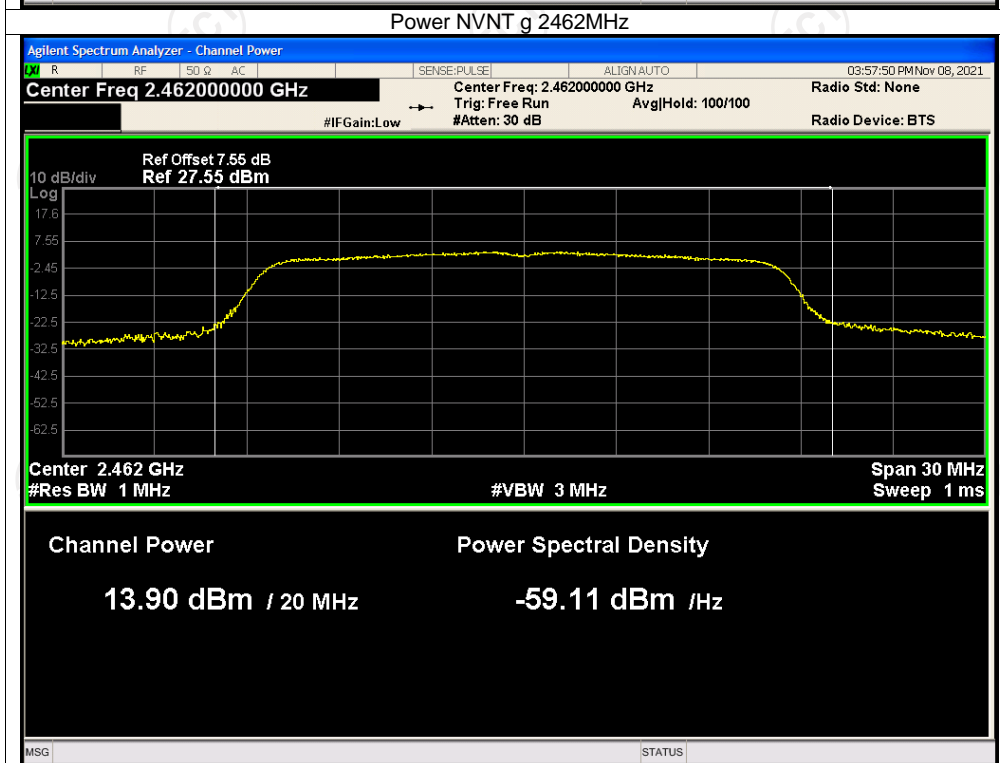
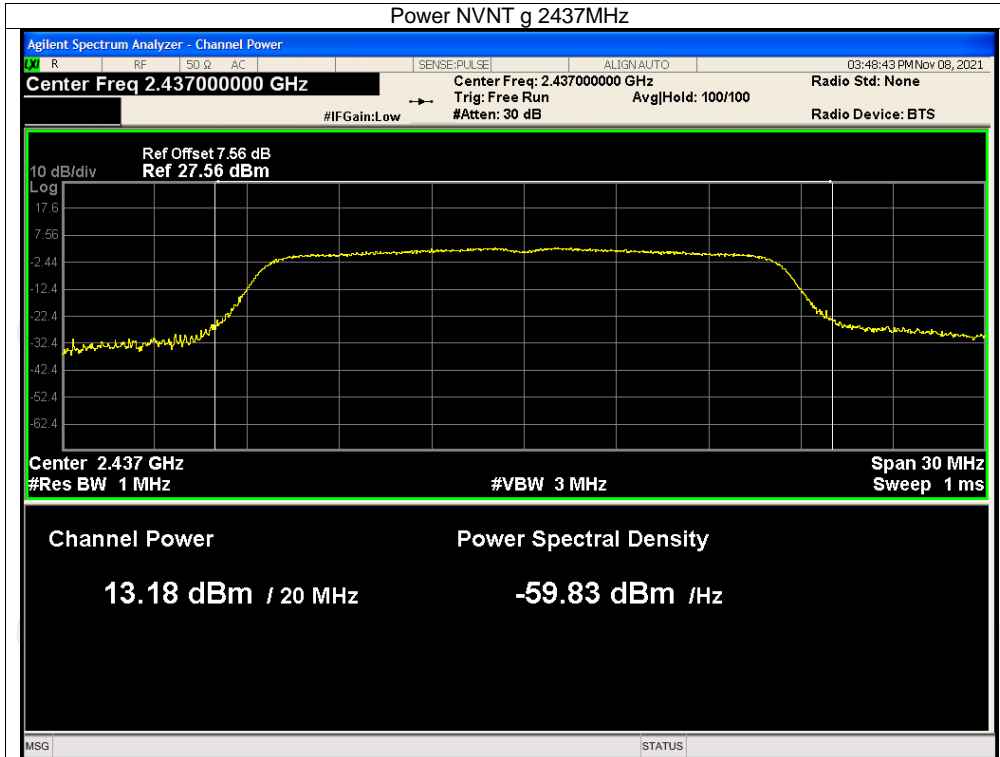

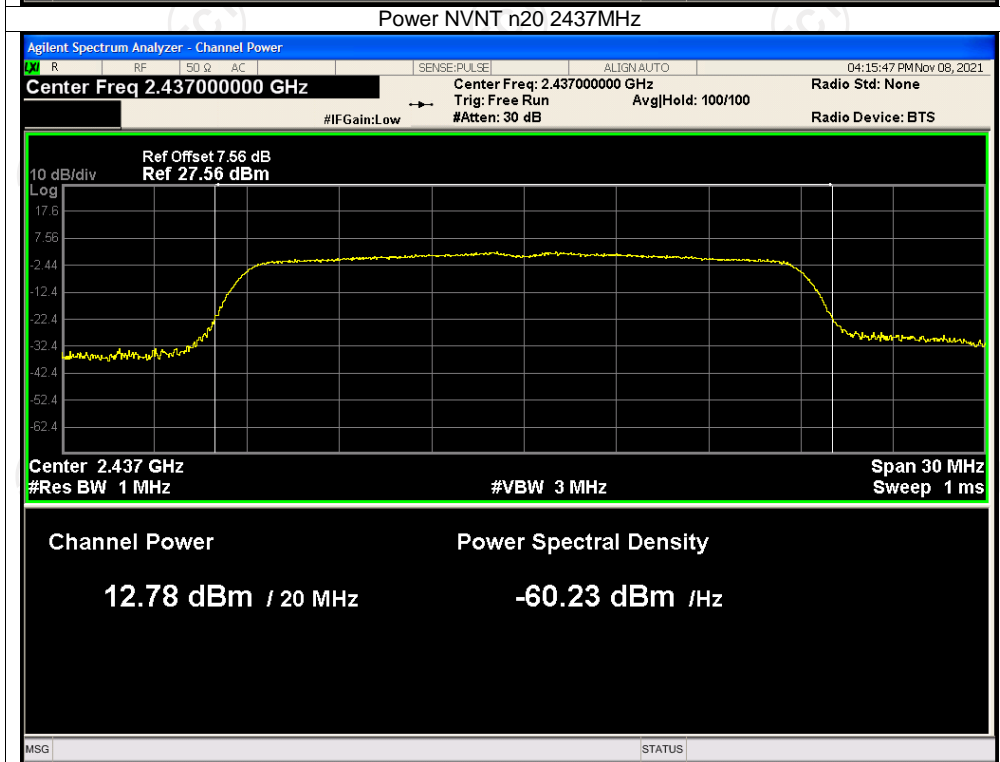
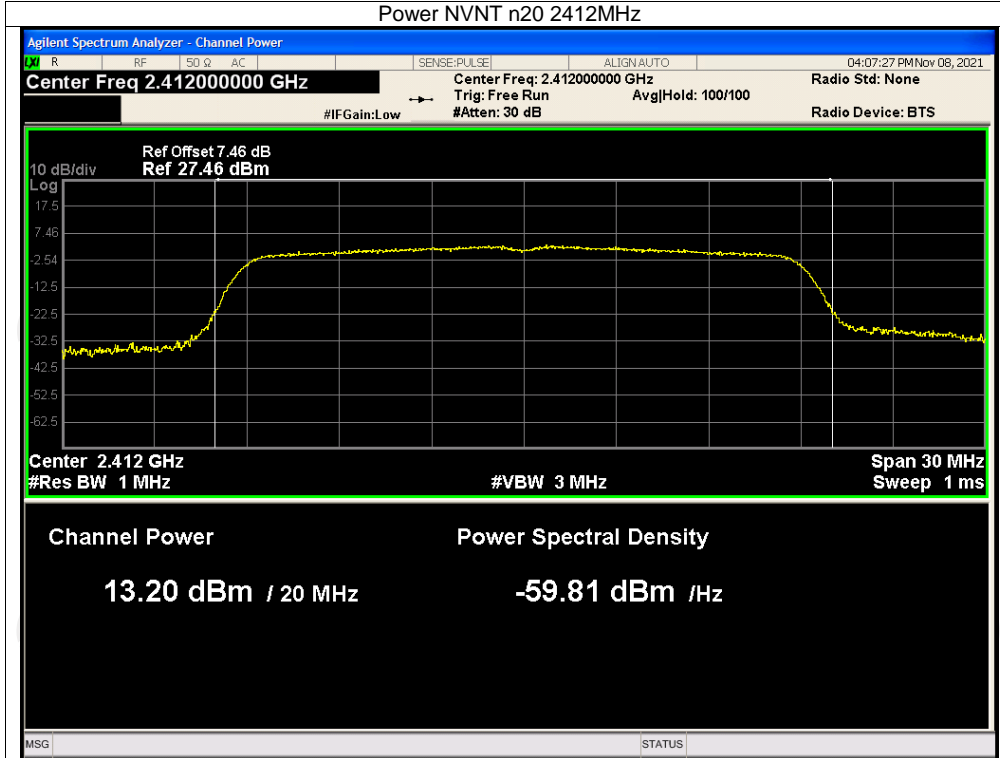

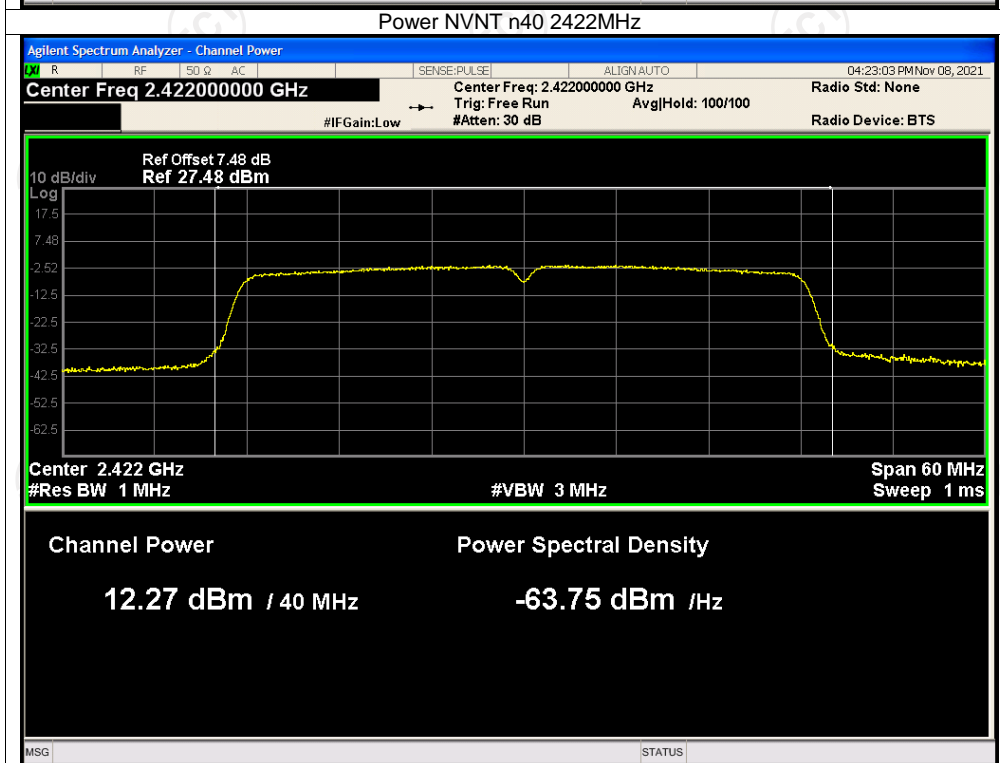
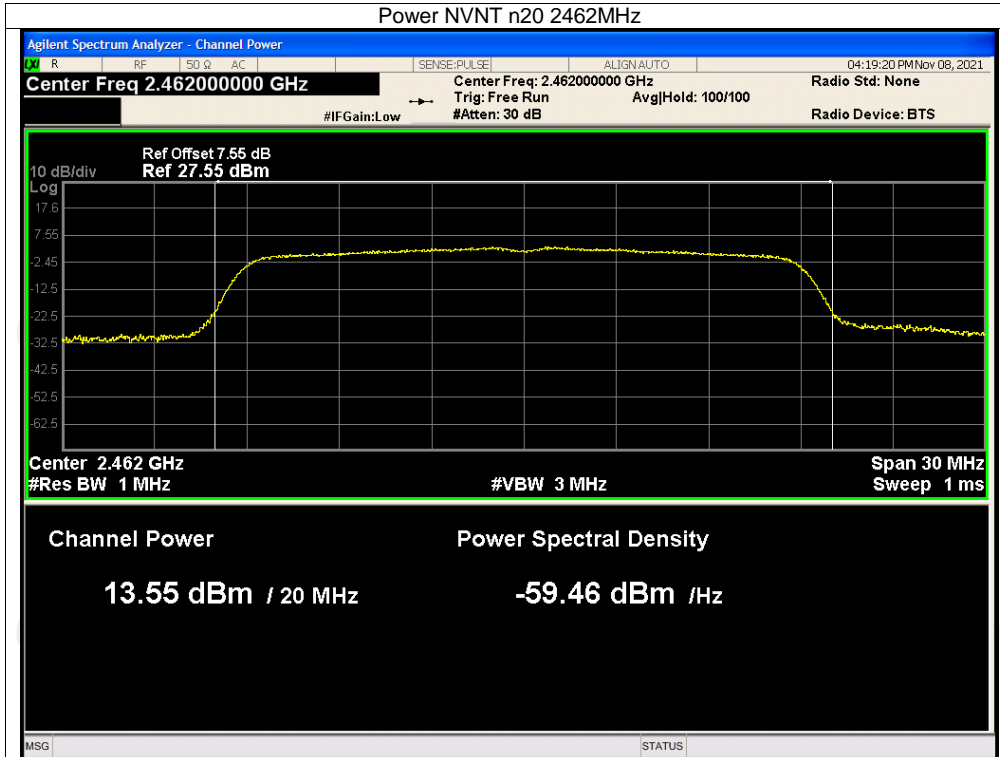

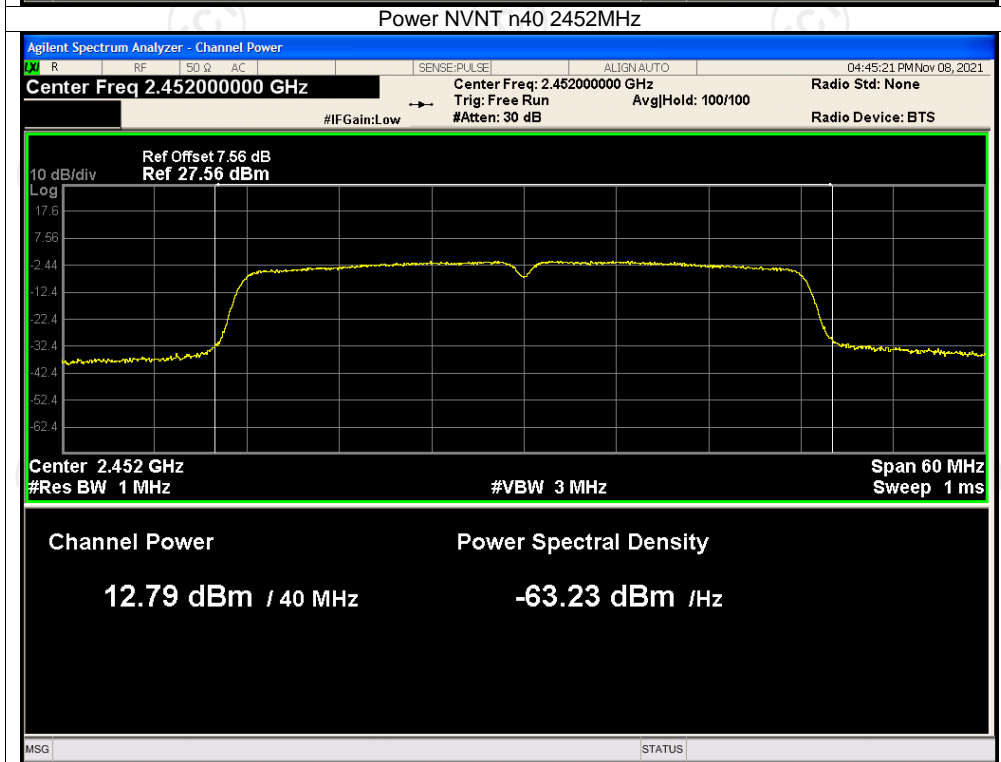
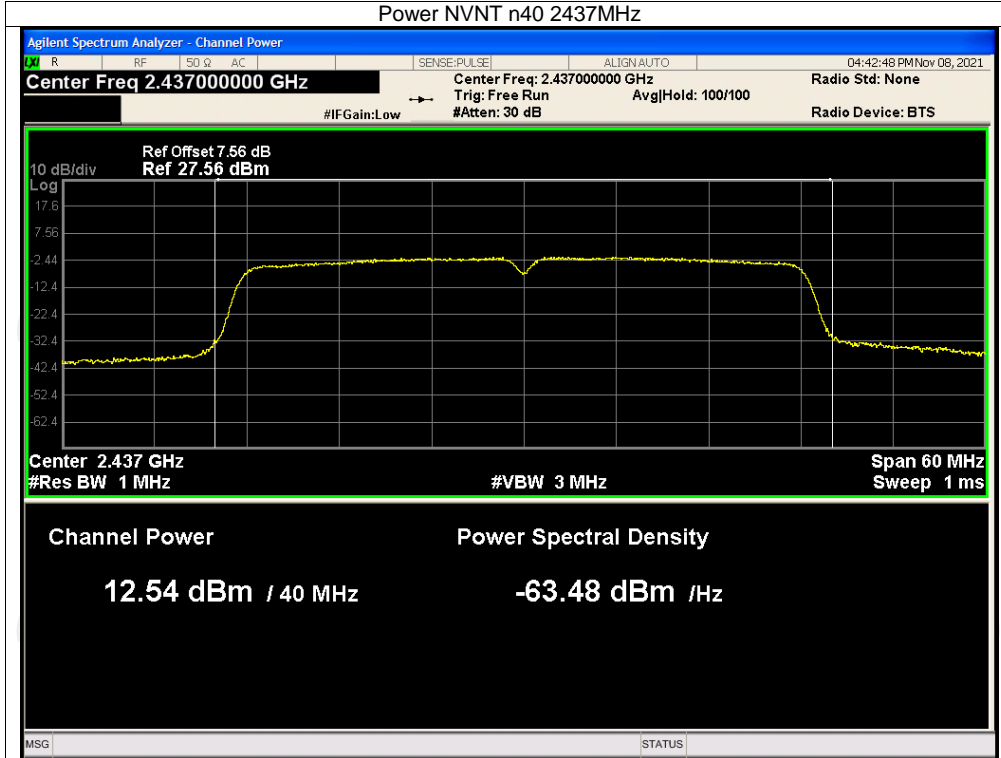

-6dB Bandwidth

Condition	Mode	Frequency (MHz)	-6 dB Bandwidth (MHz)	Limit -6 dB Bandwidth (MHz)	Verdict
NVNT	b	2412	9.126	0.5	Pass
NVNT	b	2437	9.256	0.5	Pass
NVNT	b	2462	9.498	0.5	Pass
NVNT	g	2412	16.365	0.5	Pass
NVNT	g	2437	16.360	0.5	Pass
NVNT	g	2462	16.348	0.5	Pass
NVNT	n20	2412	17.585	0.5	Pass
NVNT	n20	2437	17.611	0.5	Pass
NVNT	n20	2462	17.590	0.5	Pass
NVNT	n40	2422	36.324	0.5	Pass
NVNT	n40	2437	36.324	0.5	Pass
NVNT	n40	2452	36.315	0.5	Pass

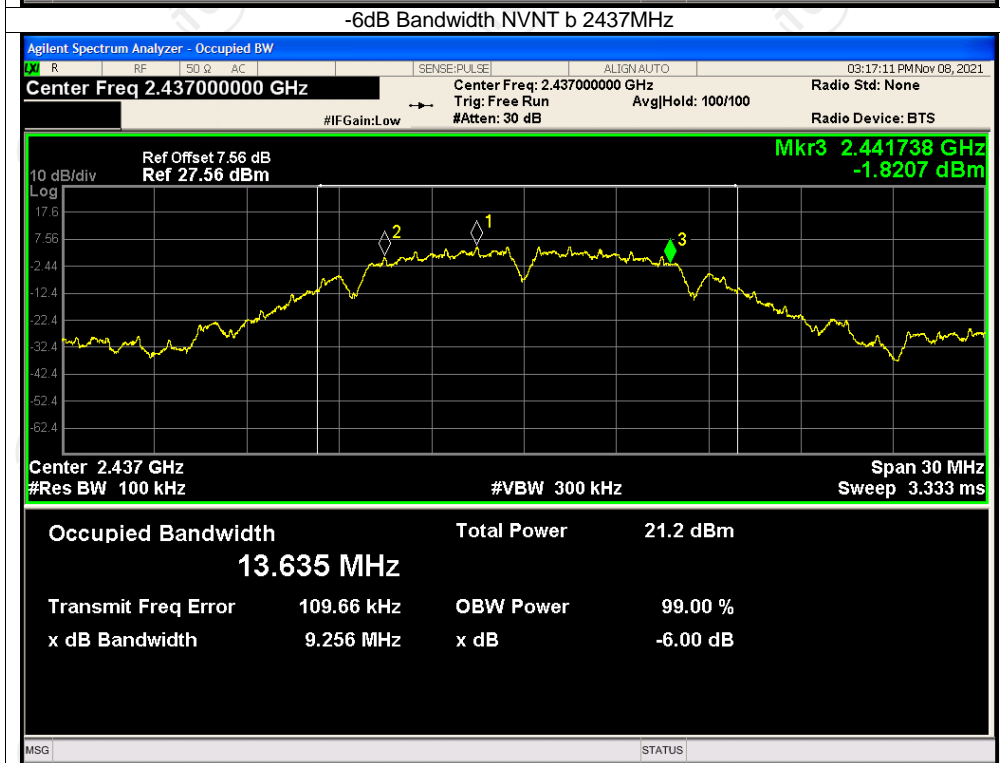
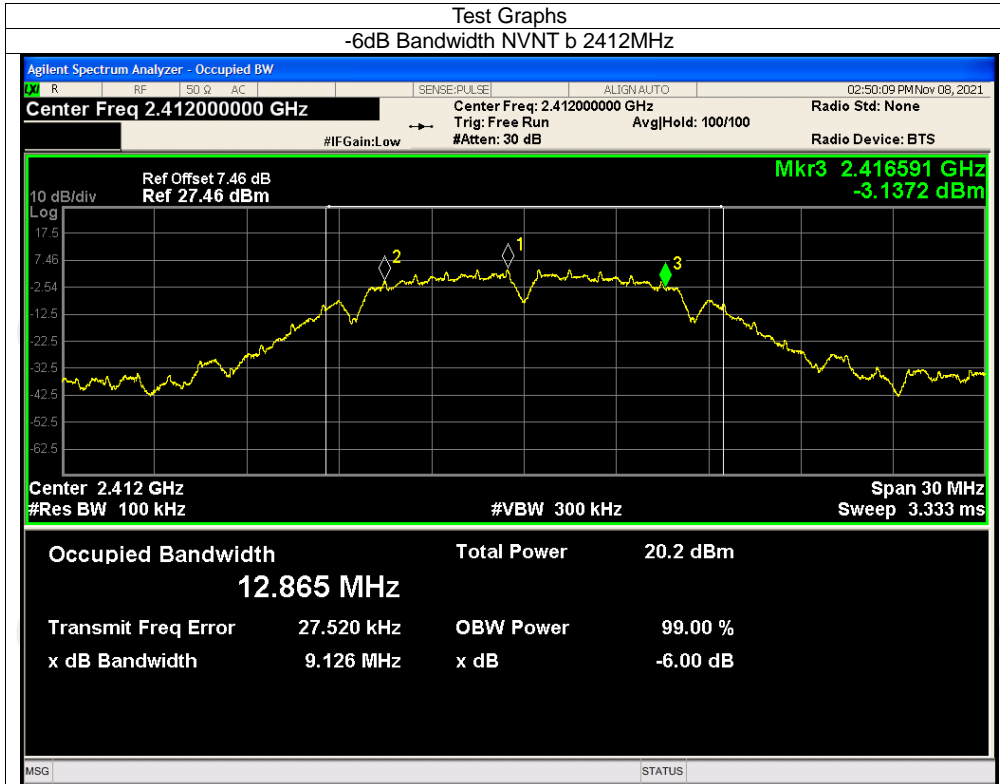

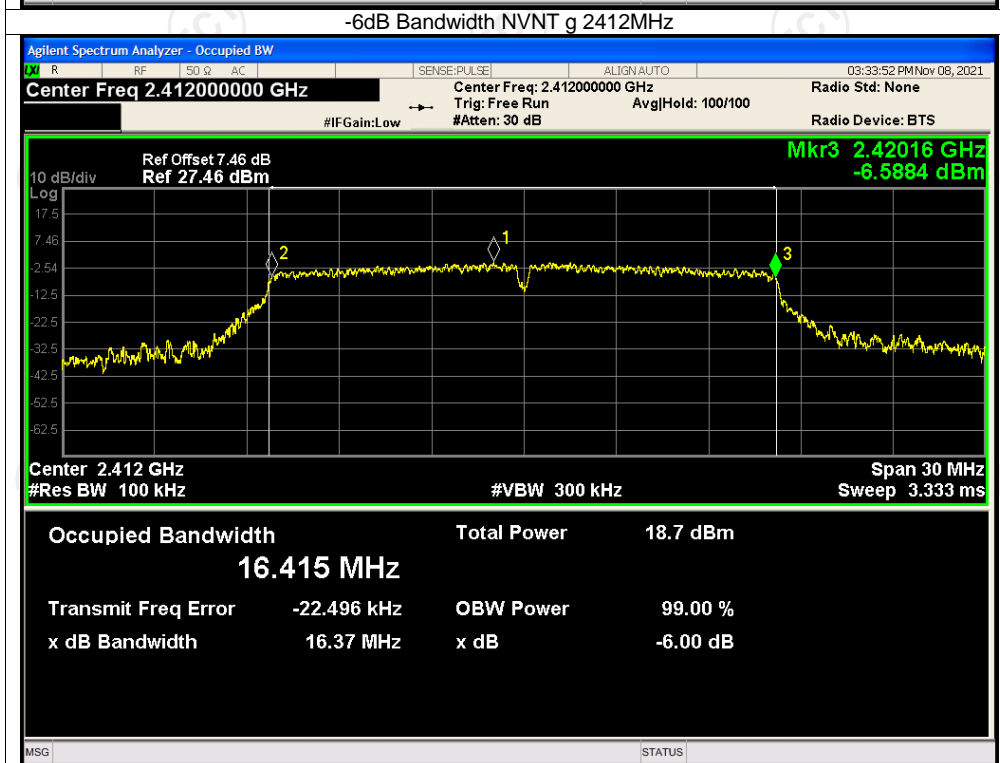
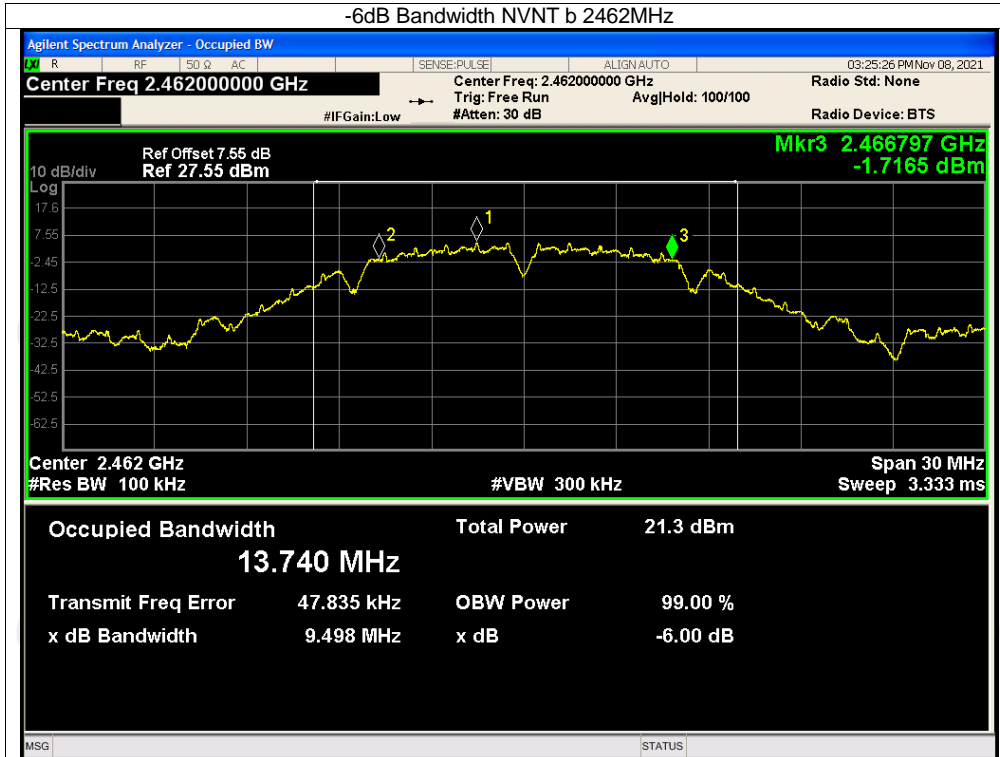

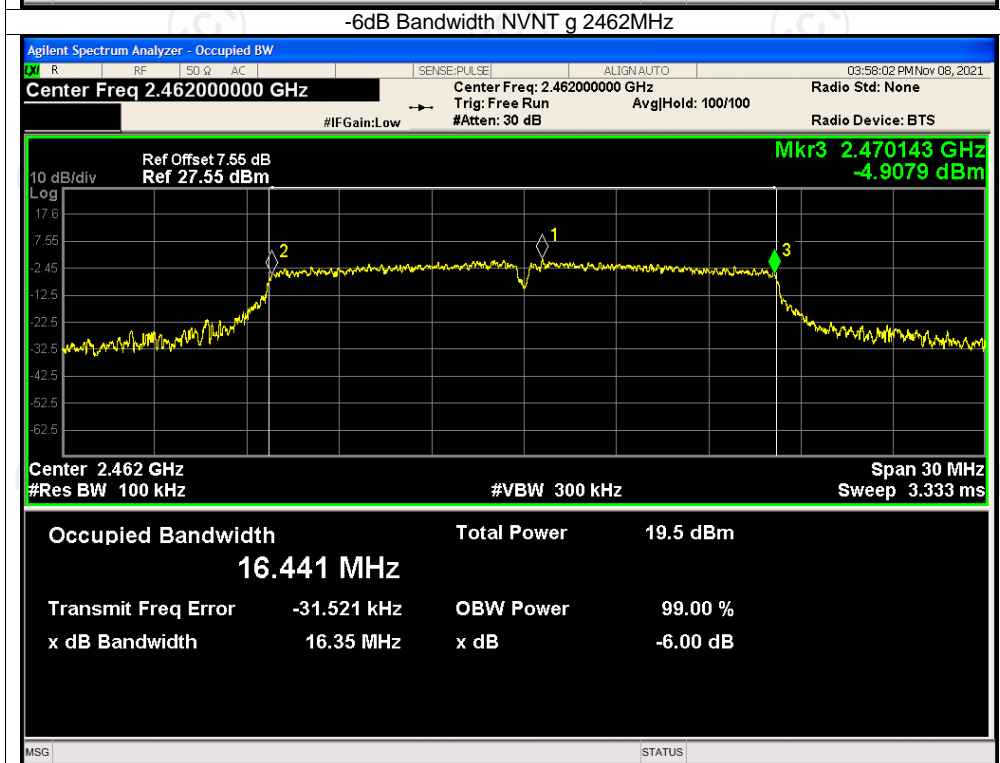
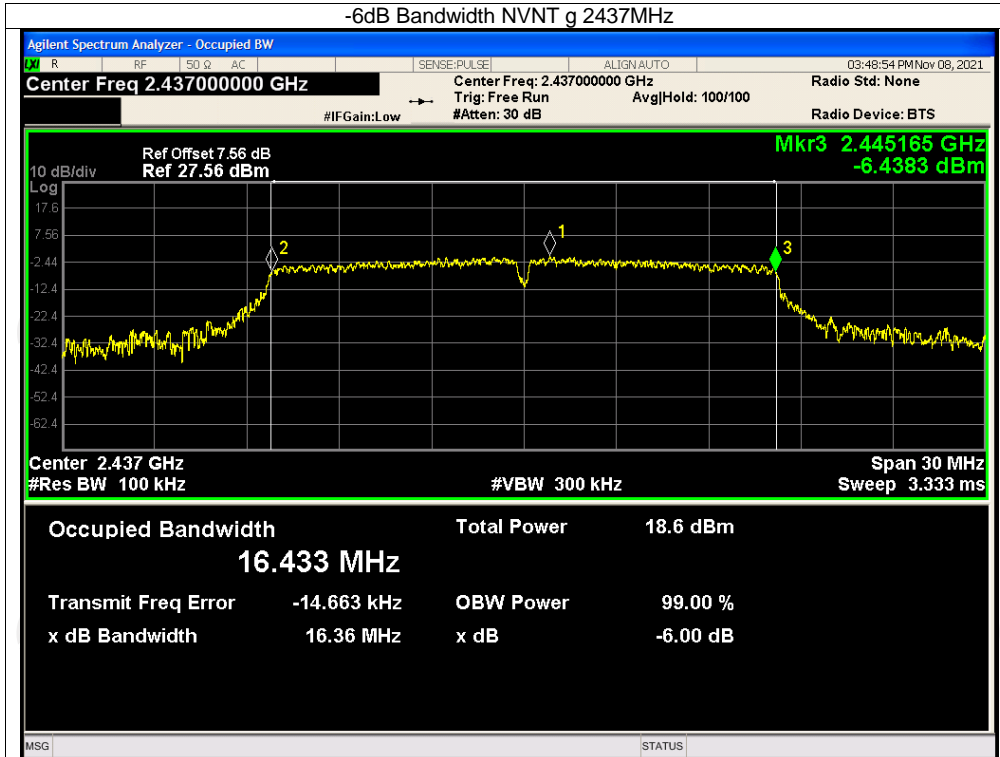

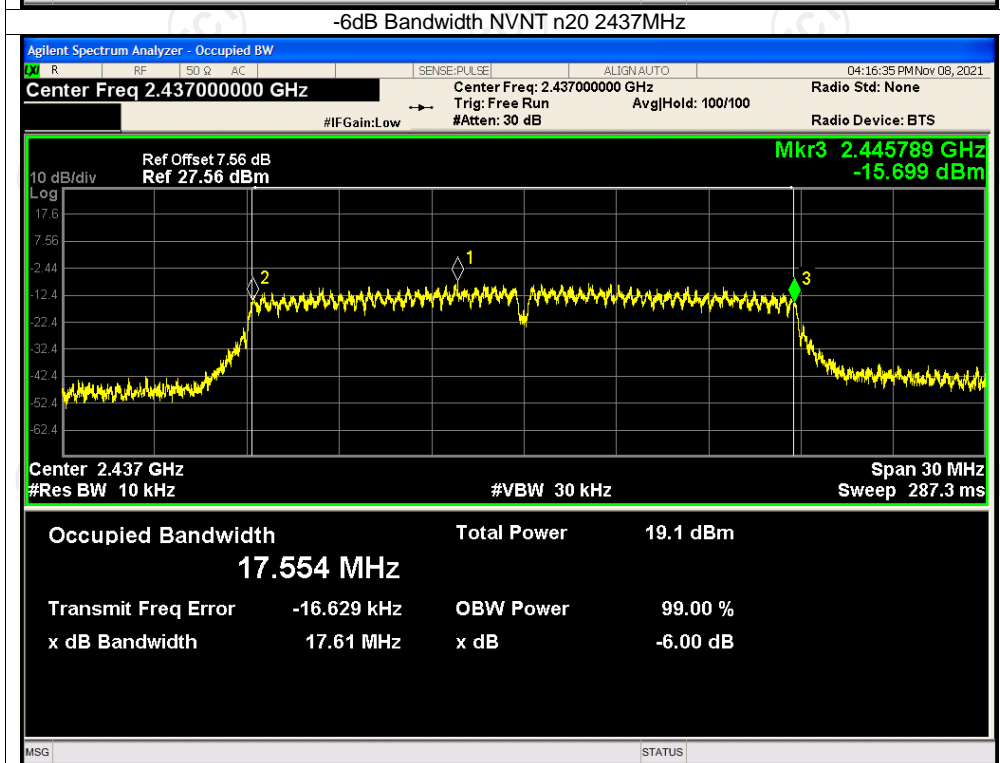
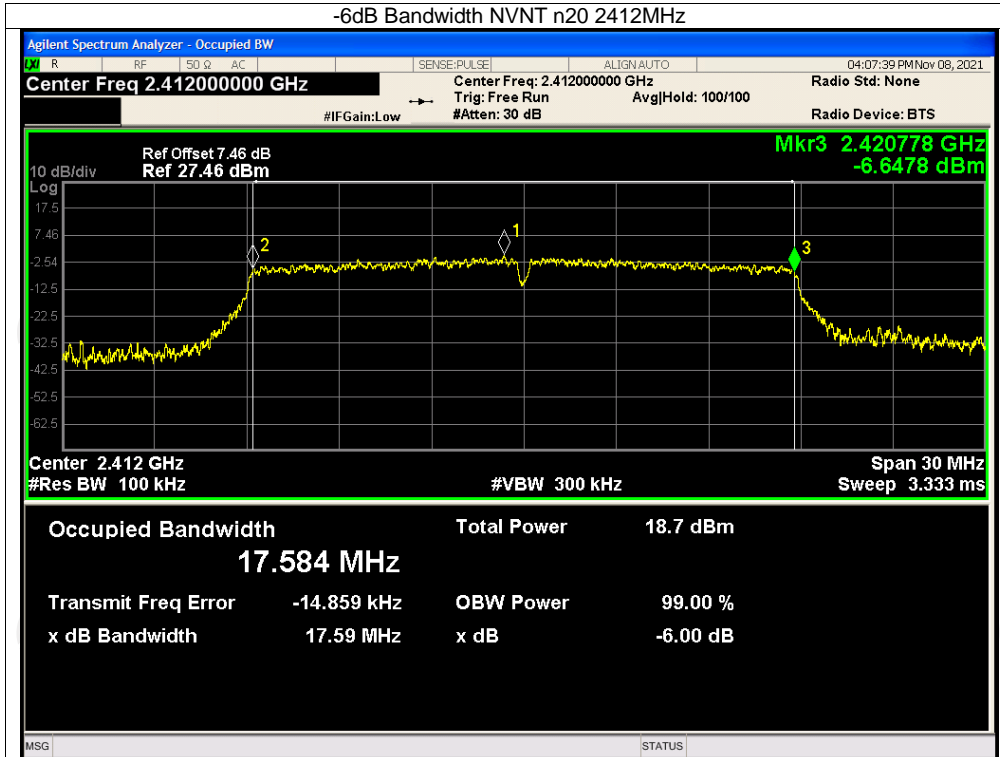

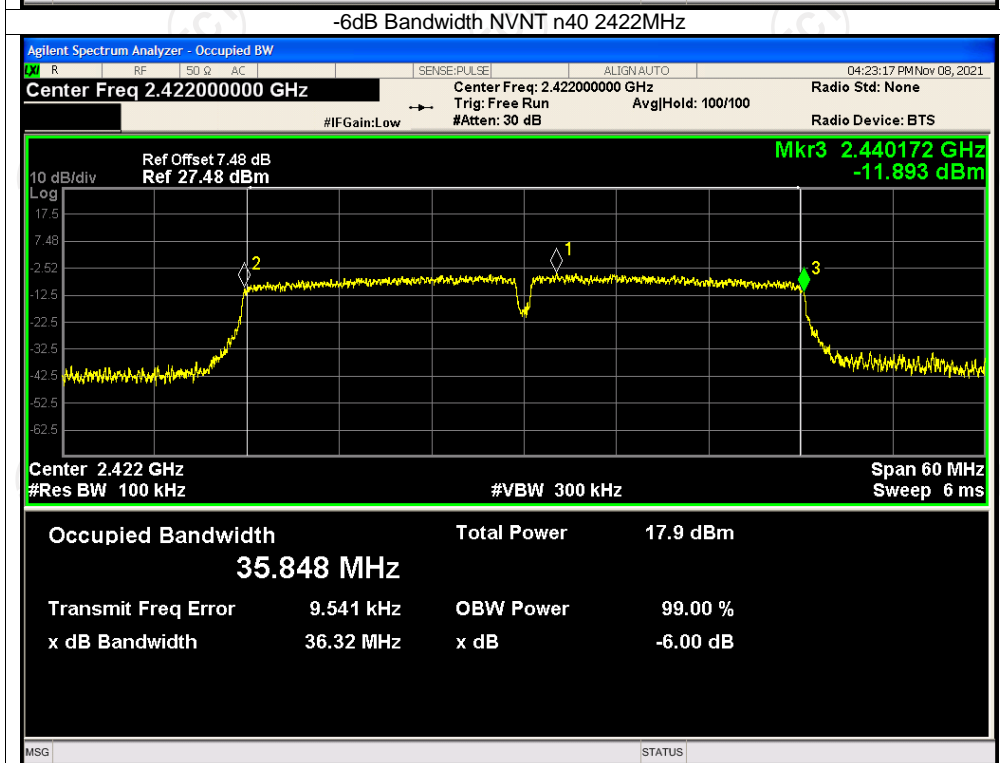
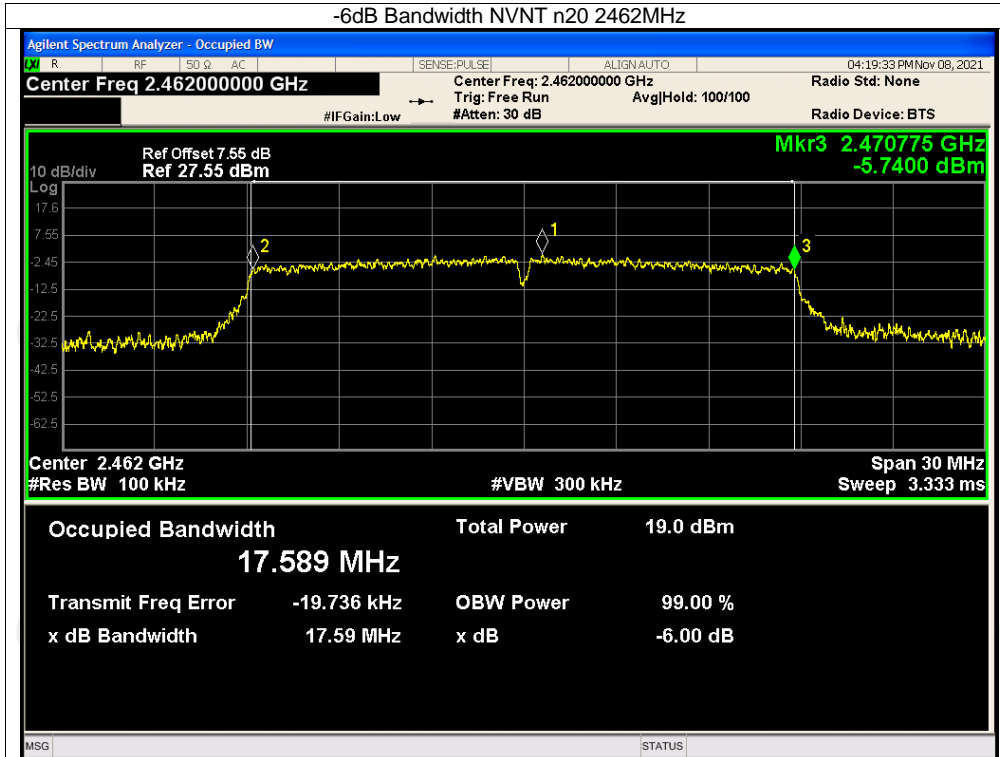

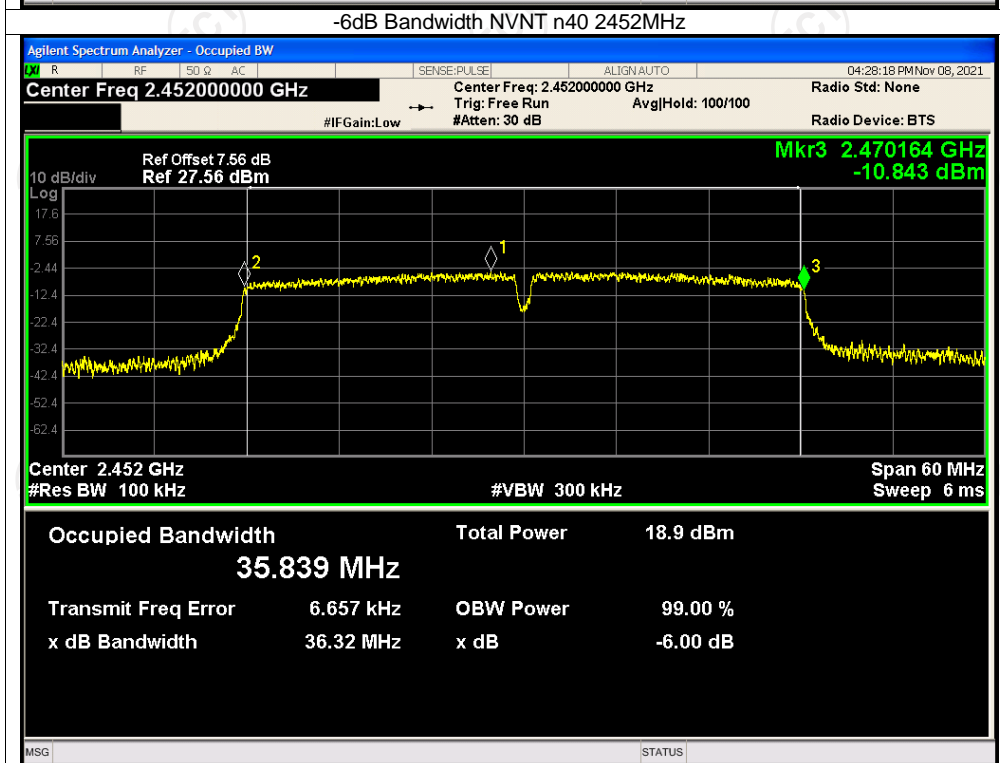
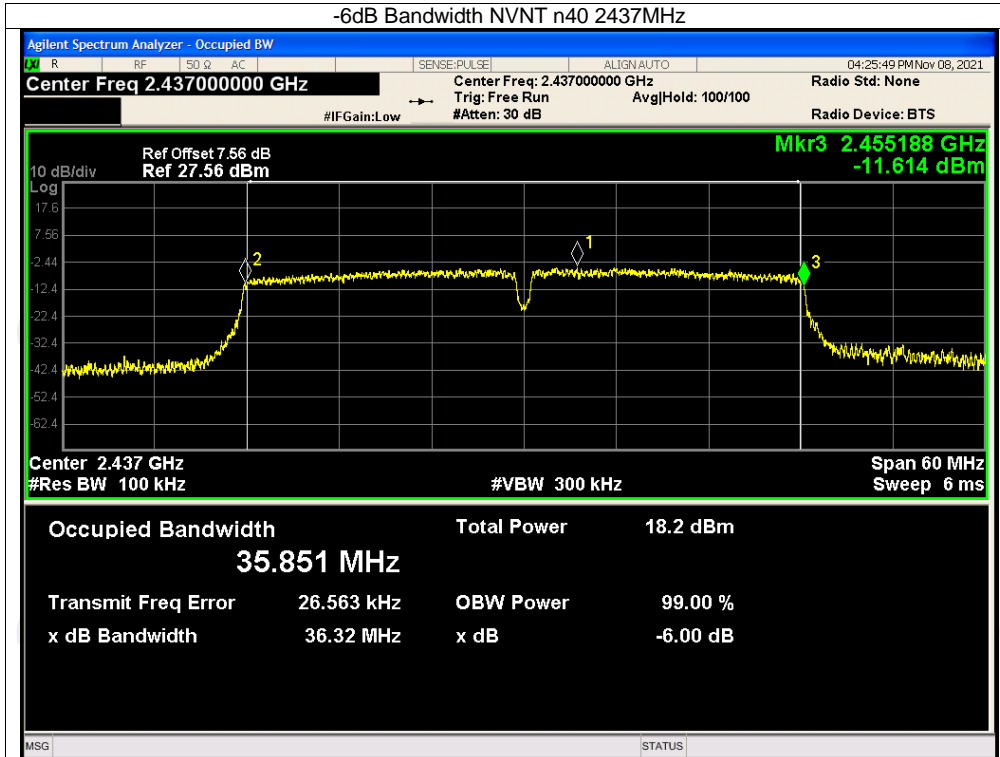

Maximum Power Spectral Density Level

Condition	Mode	Frequency (MHz)	Max PSD (dBm/3kHz)	Limit (dBm/3kHz)	Verdict
NVNT	b	2412	-18.539	8	Pass
NVNT	b	2437	-17.784	8	Pass
NVNT	b	2462	-17.731	8	Pass
NVNT	g	2412	-20.765	8	Pass
NVNT	g	2437	-20.800	8	Pass
NVNT	g	2462	-20.101	8	Pass
NVNT	n20	2412	-20.979	8	Pass
NVNT	n20	2437	-21.285	8	Pass
NVNT	n20	2462	-20.095	8	Pass
NVNT	n40	2422	-25.509	8	Pass
NVNT	n40	2437	-25.179	8	Pass
NVNT	n40	2452	-24.259	8	Pass

Test Graphs

PSD NVNT b 2412MHz

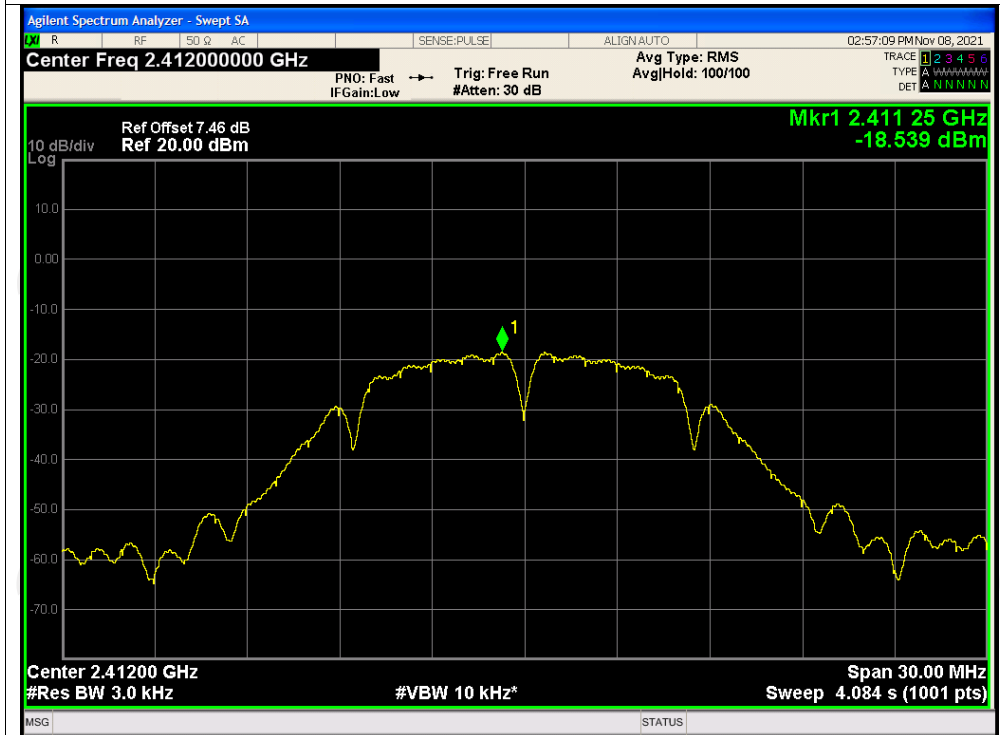

PSD NVNT b 2437MHz



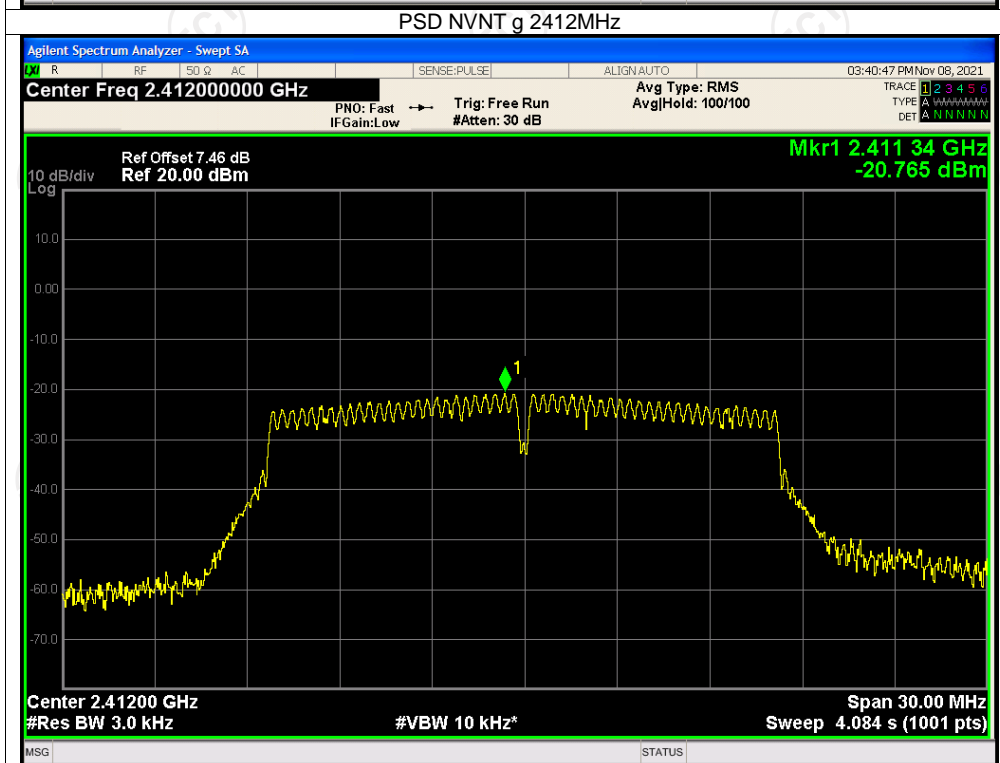
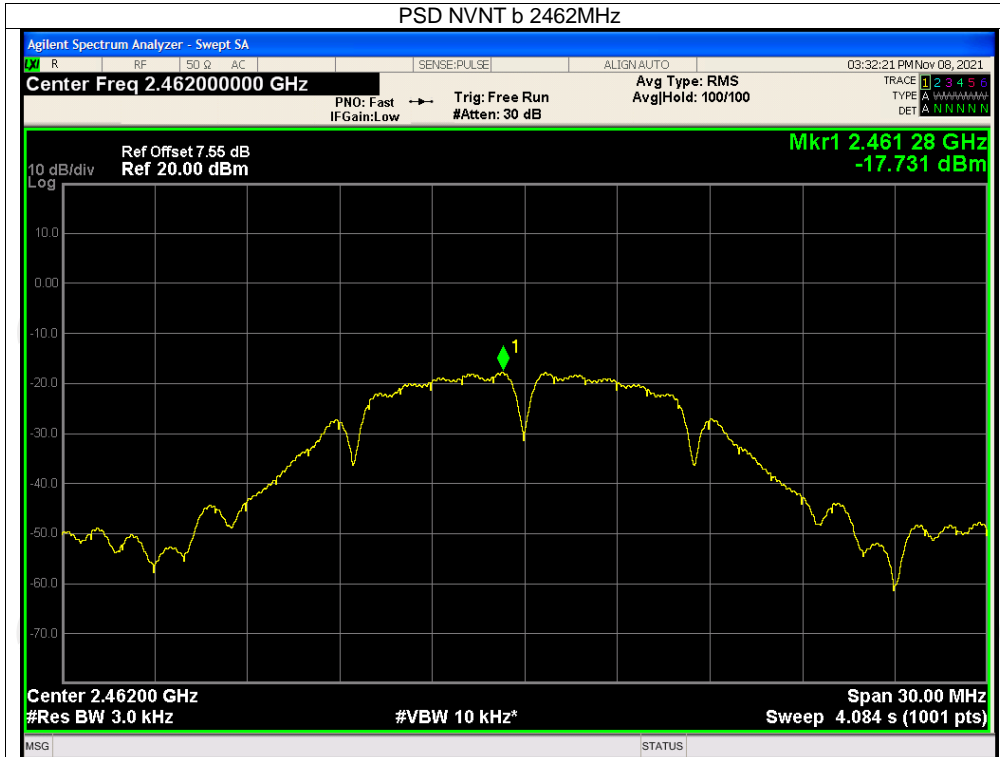

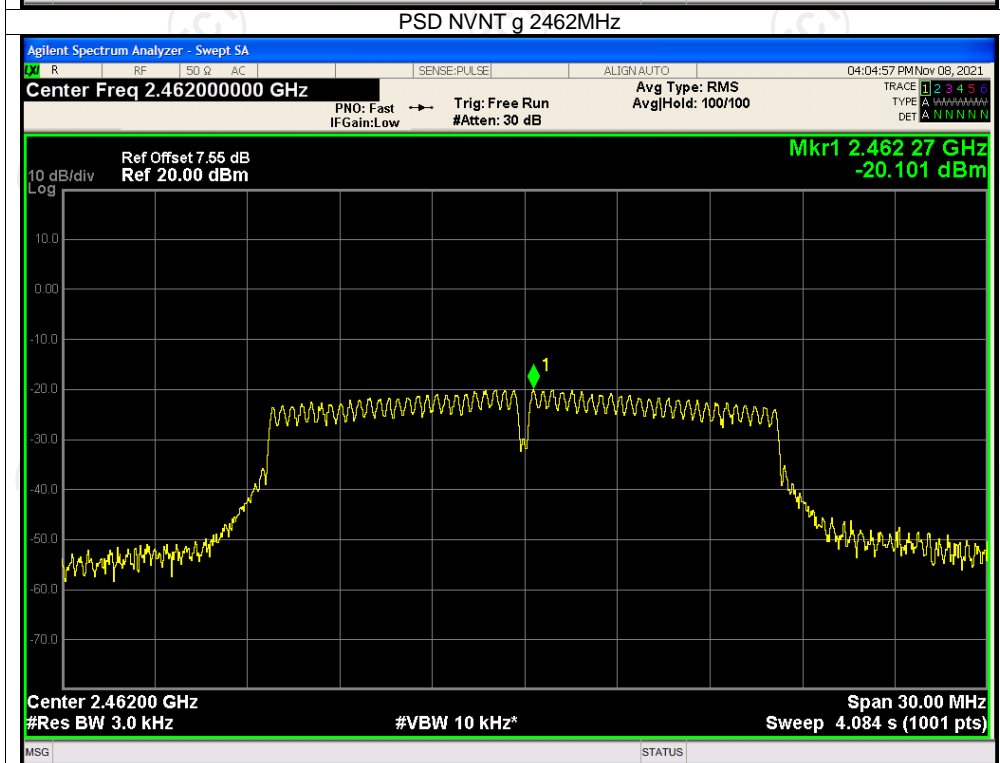
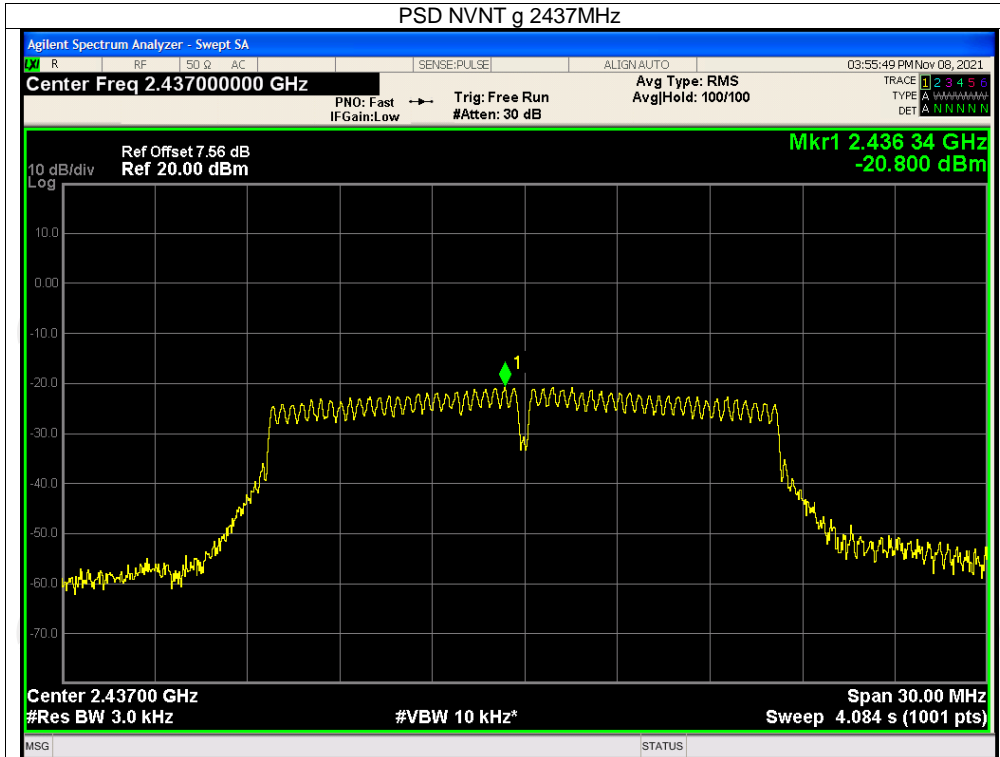

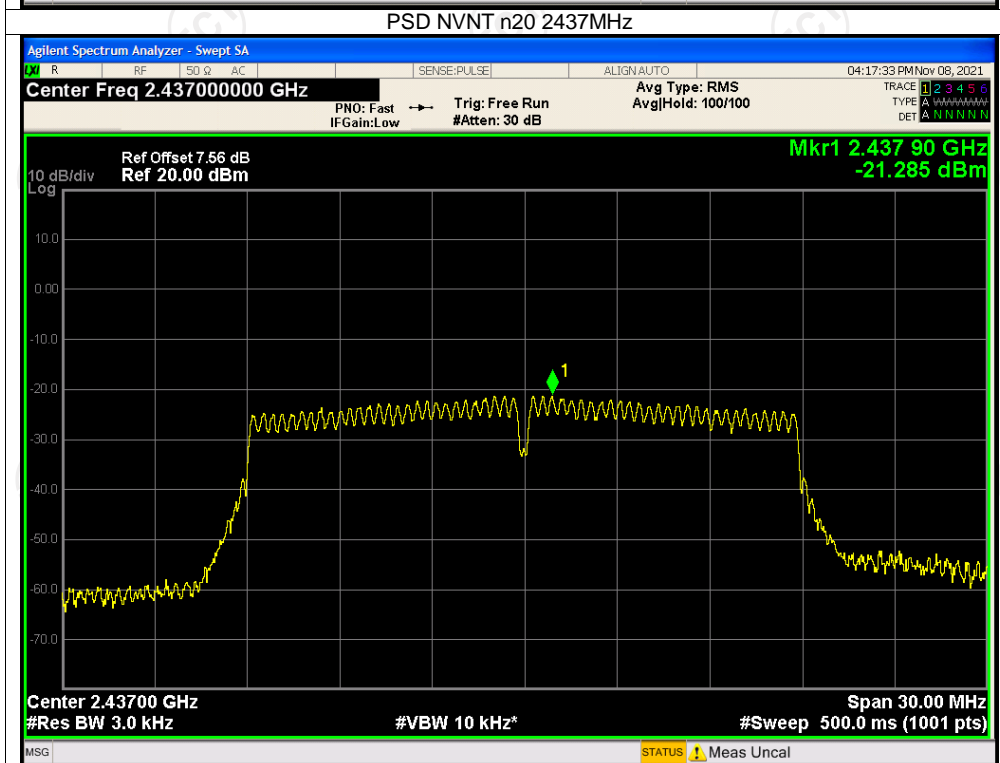
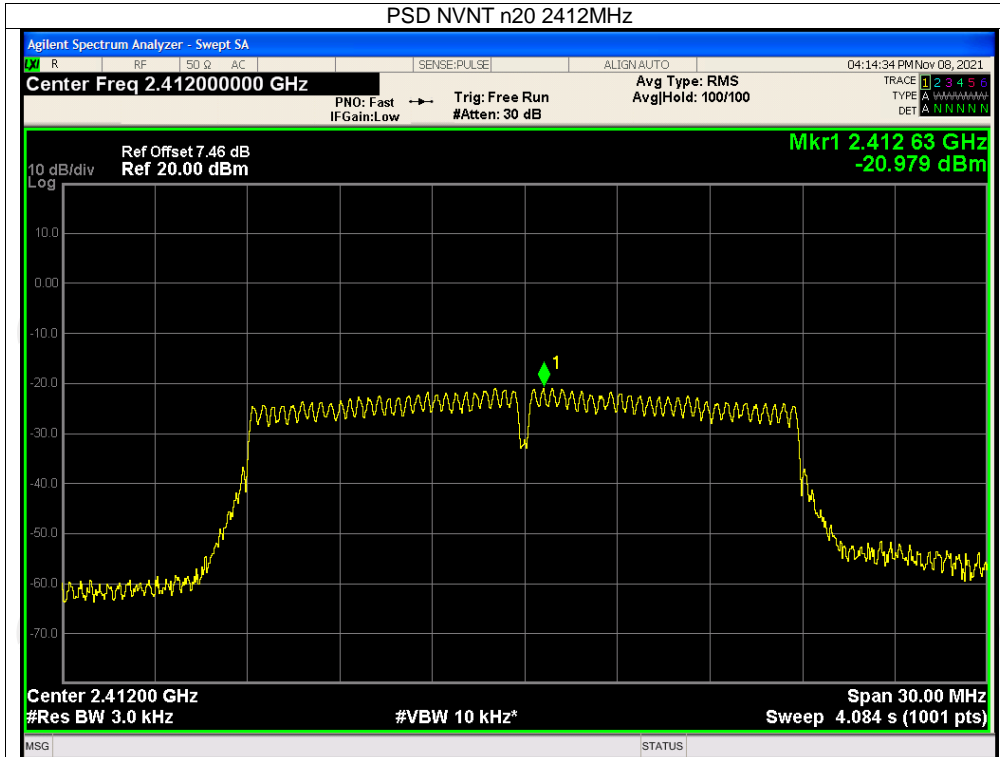

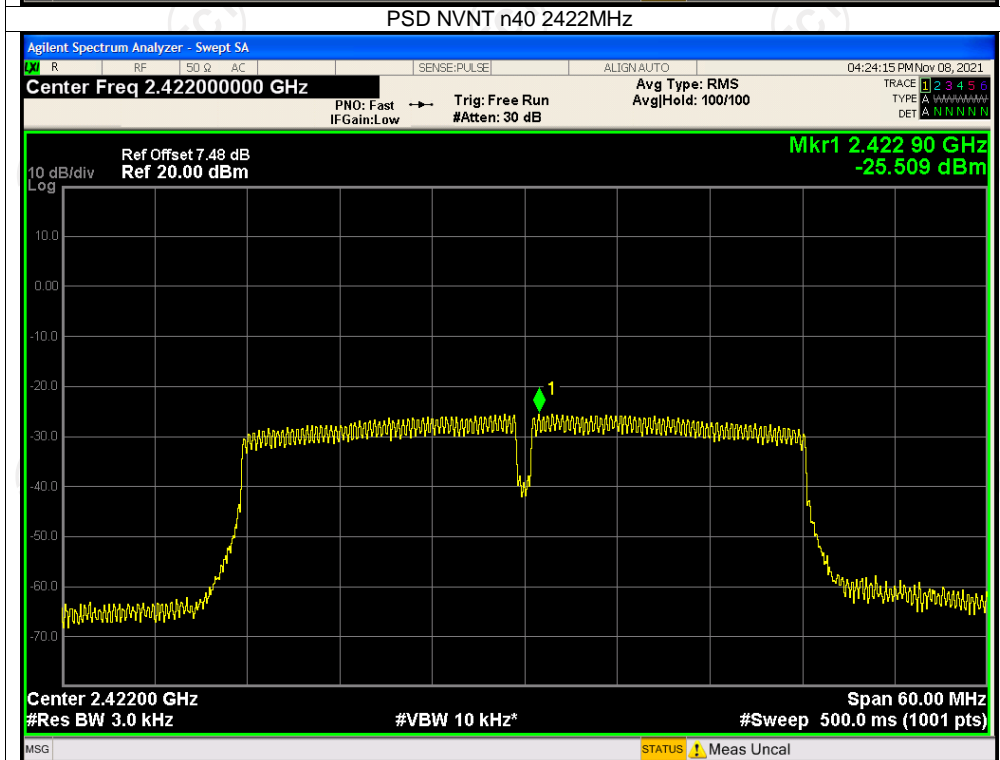
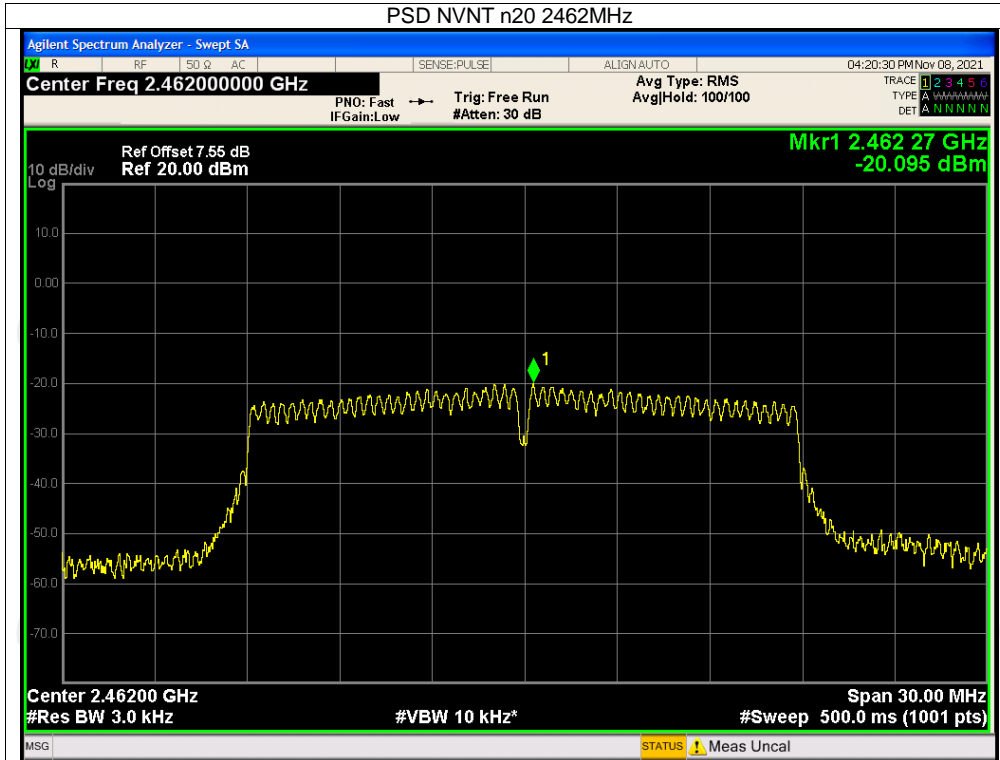

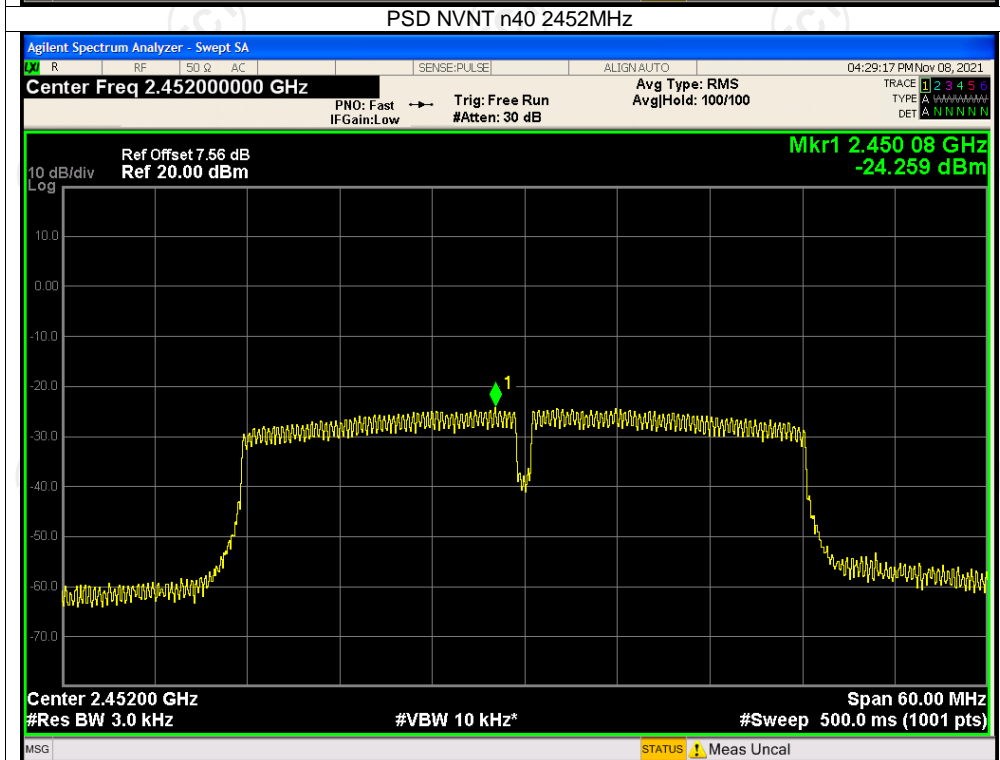
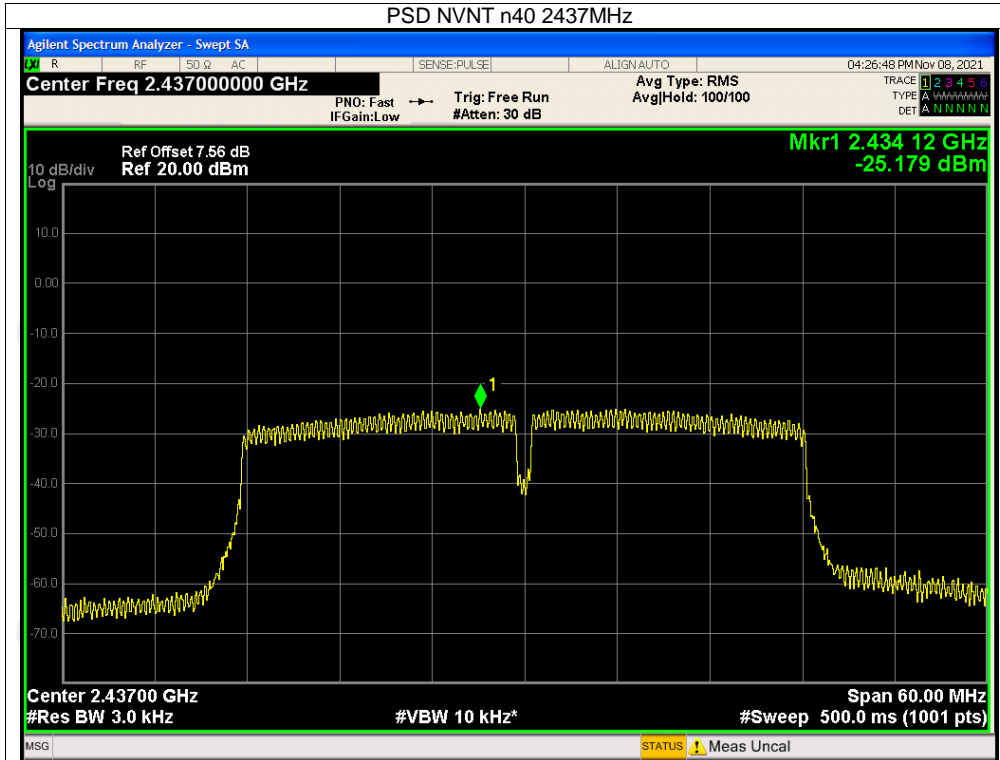

Band Edge

Condition	Mode	Frequency (MHz)	Max Value (dBc)	Limit (dBc)	Verdict
NVNT	b	2412	-54.83	-30	Pass
NVNT	b	2462	-45.42	-30	Pass
NVNT	g	2412	-40.05	-30	Pass
NVNT	g	2462	-36.06	-30	Pass
NVNT	n20	2412	-40.45	-30	Pass
NVNT	n20	2462	-33.83	-30	Pass
NVNT	n40	2422	-33.22	-30	Pass
NVNT	n40	2452	-31.92	-30	Pass

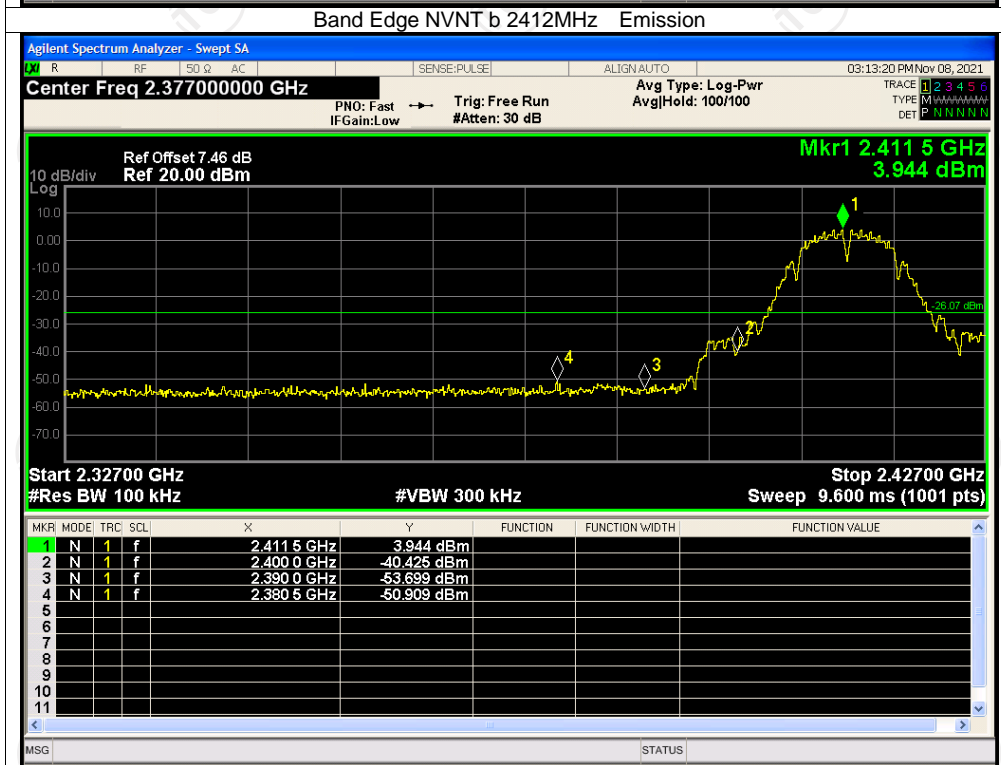

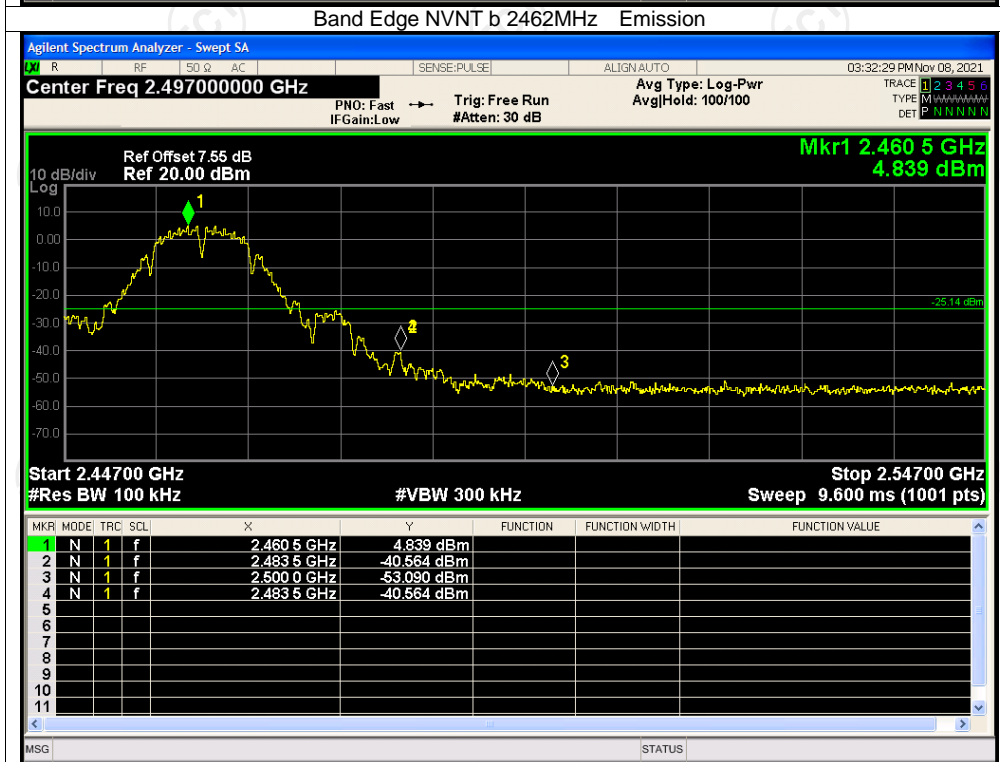
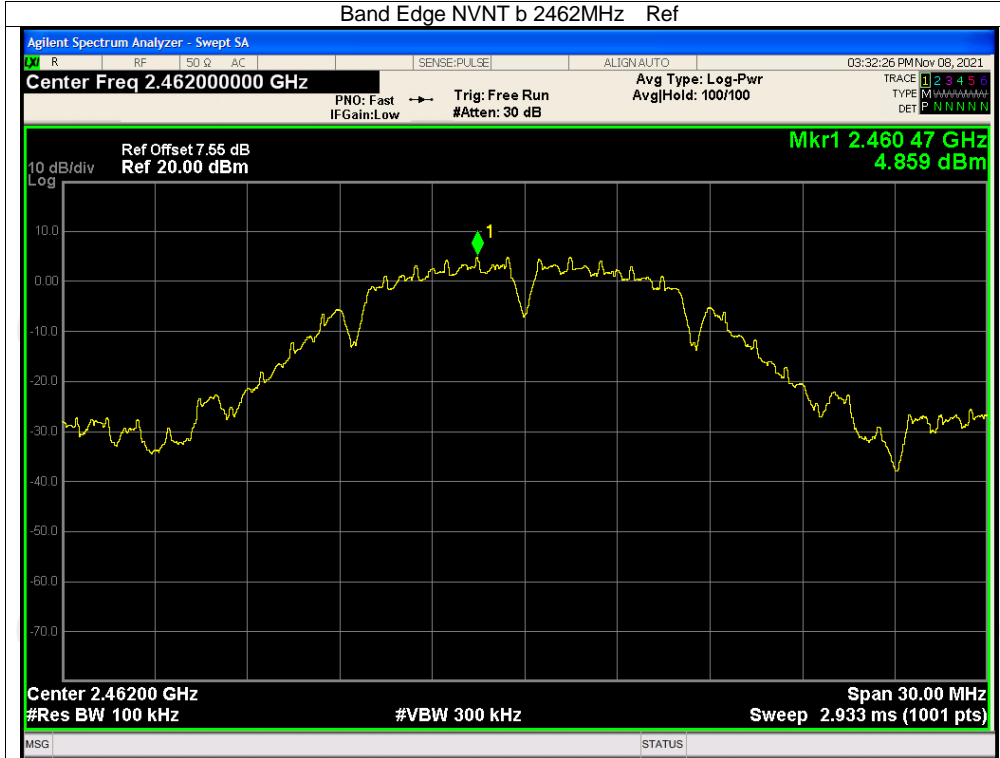

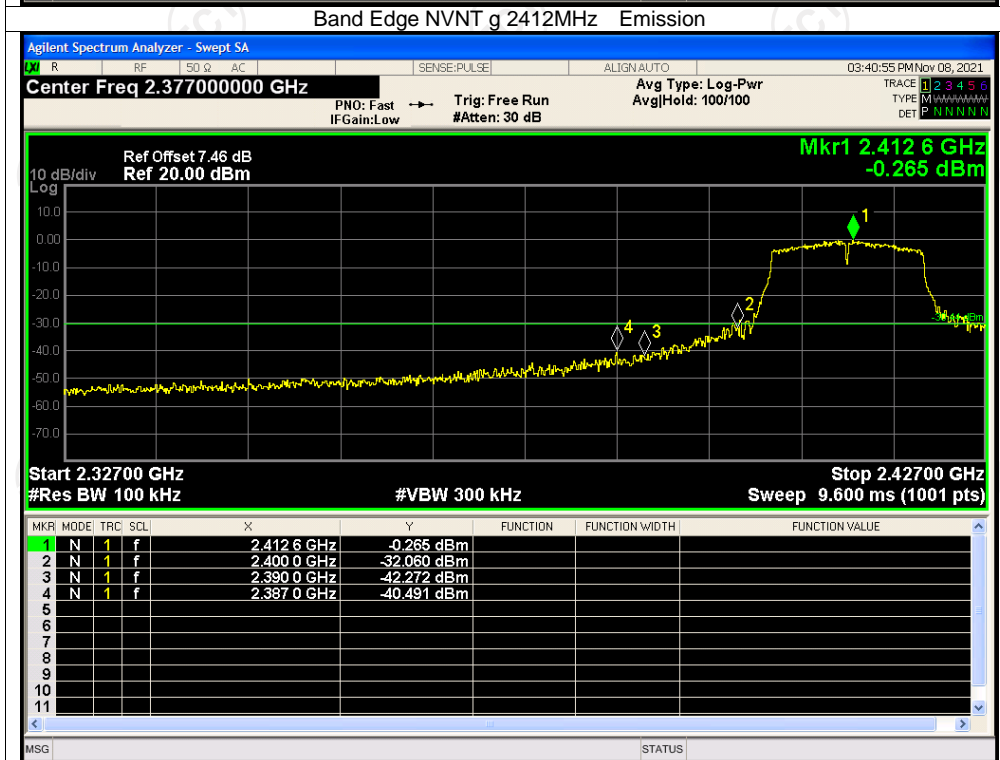
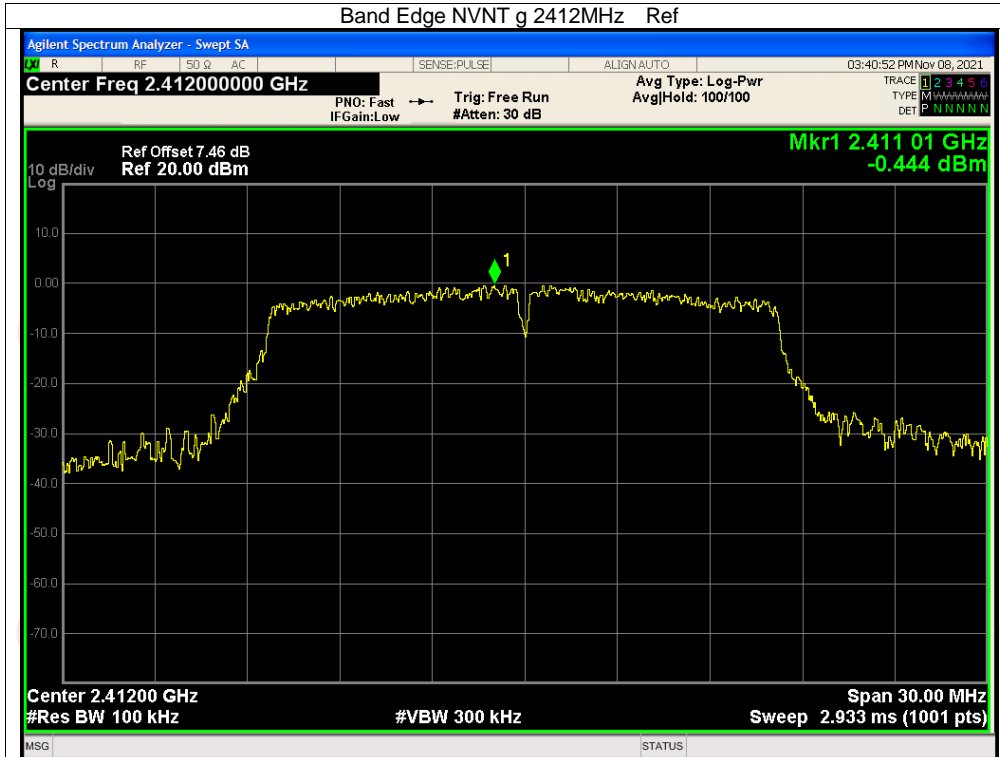

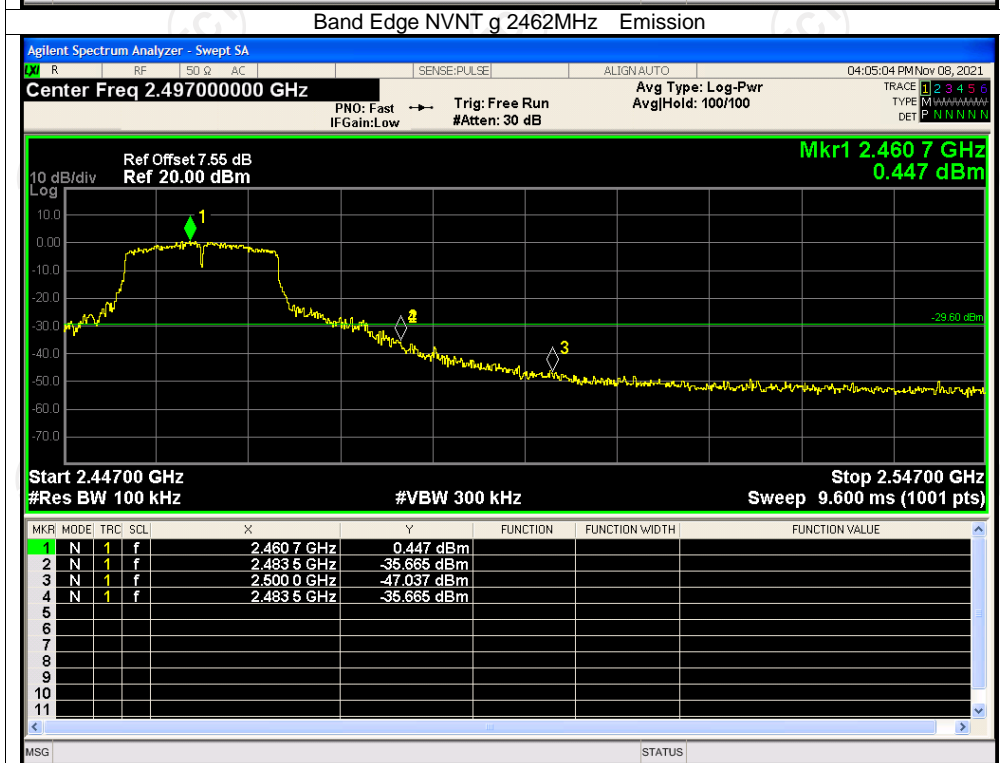
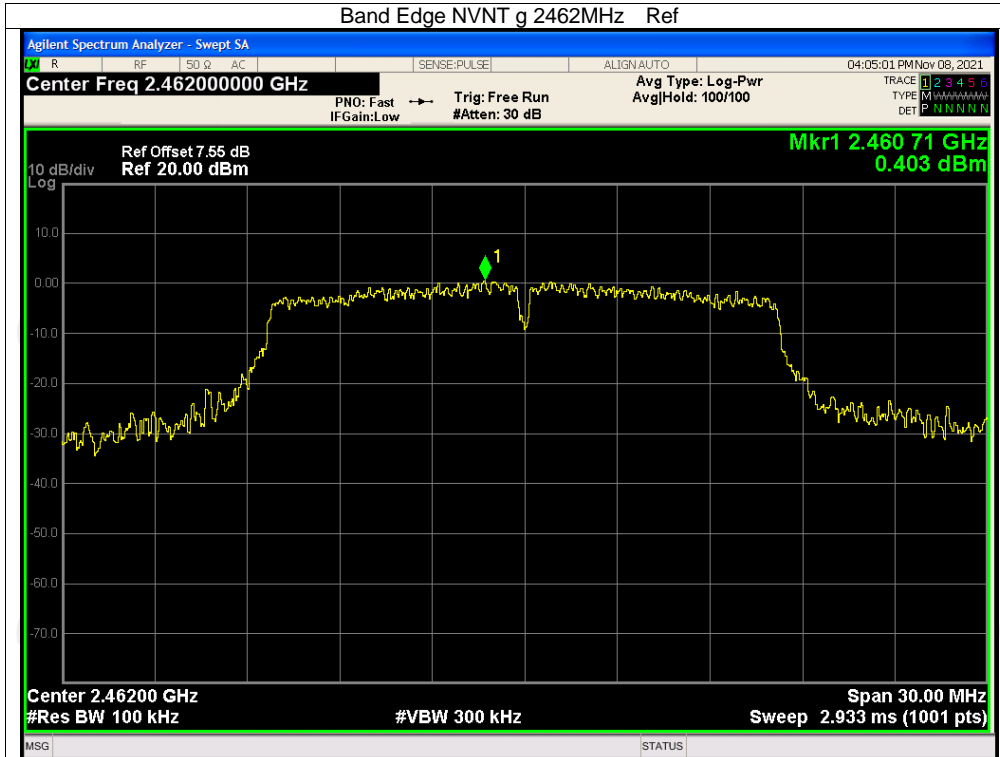

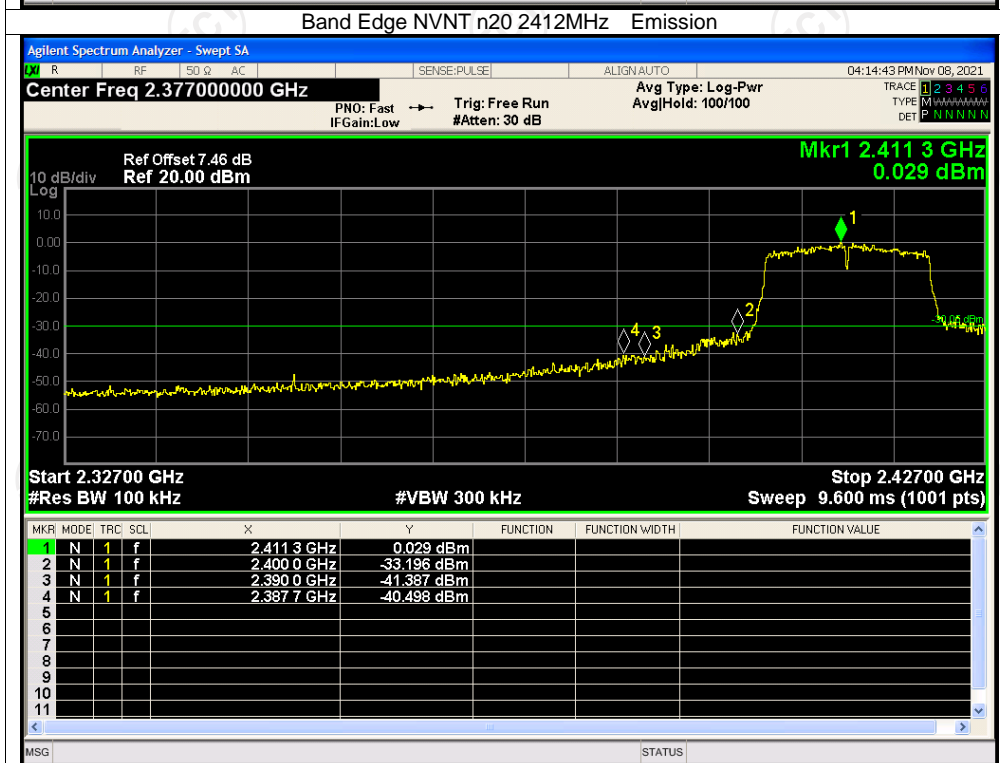
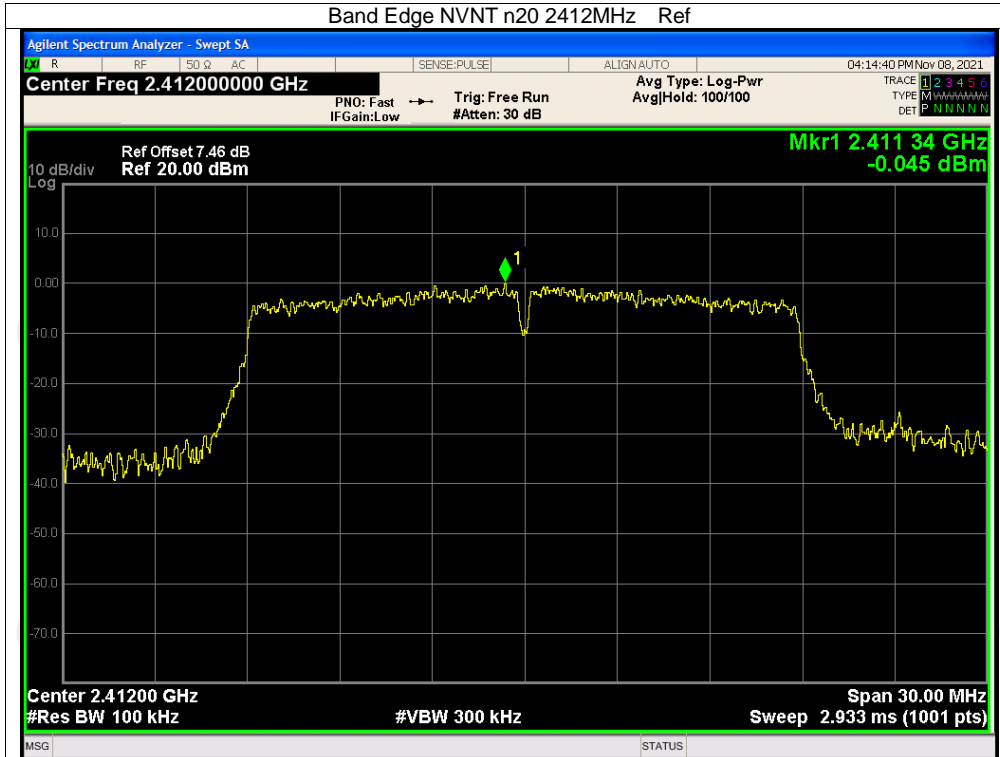

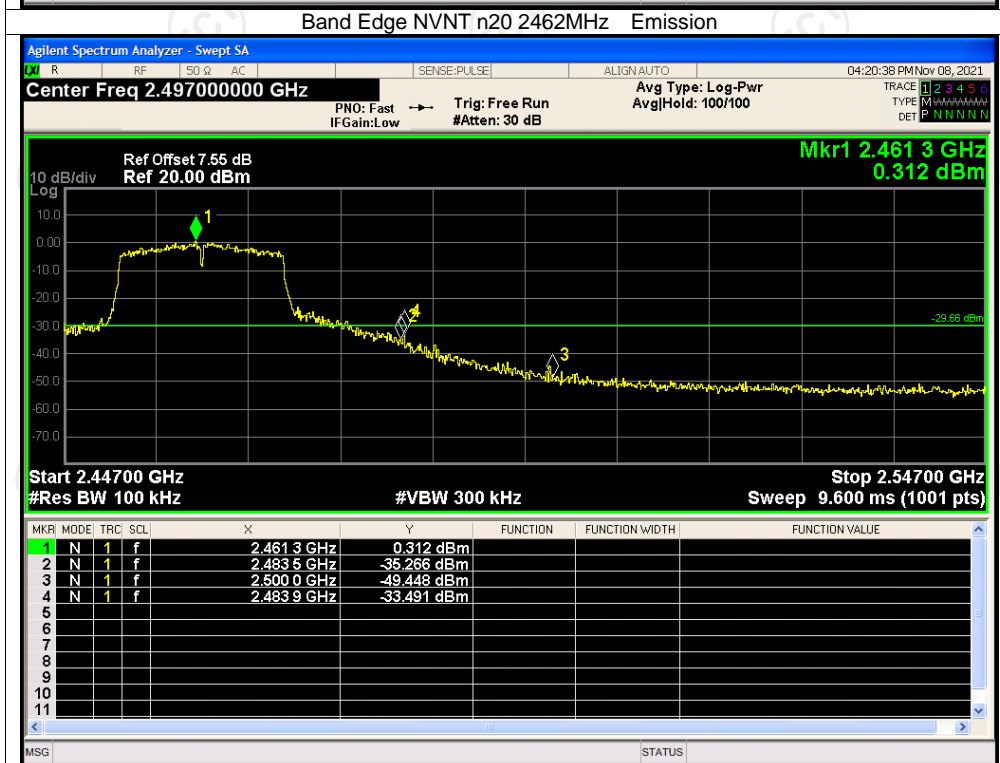
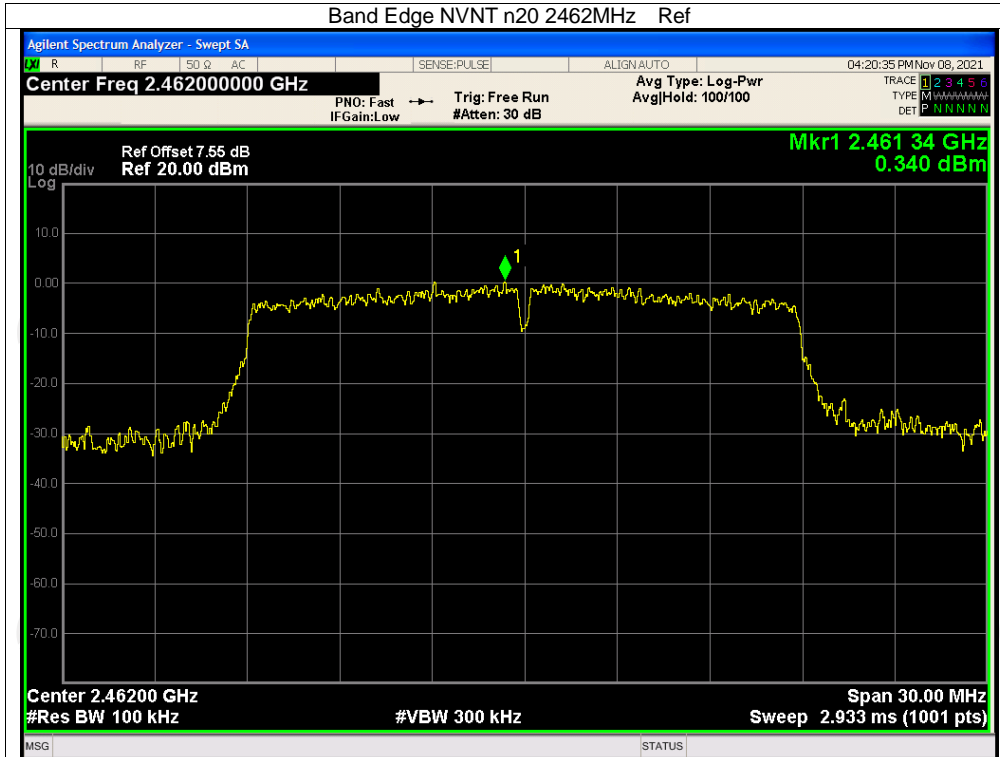

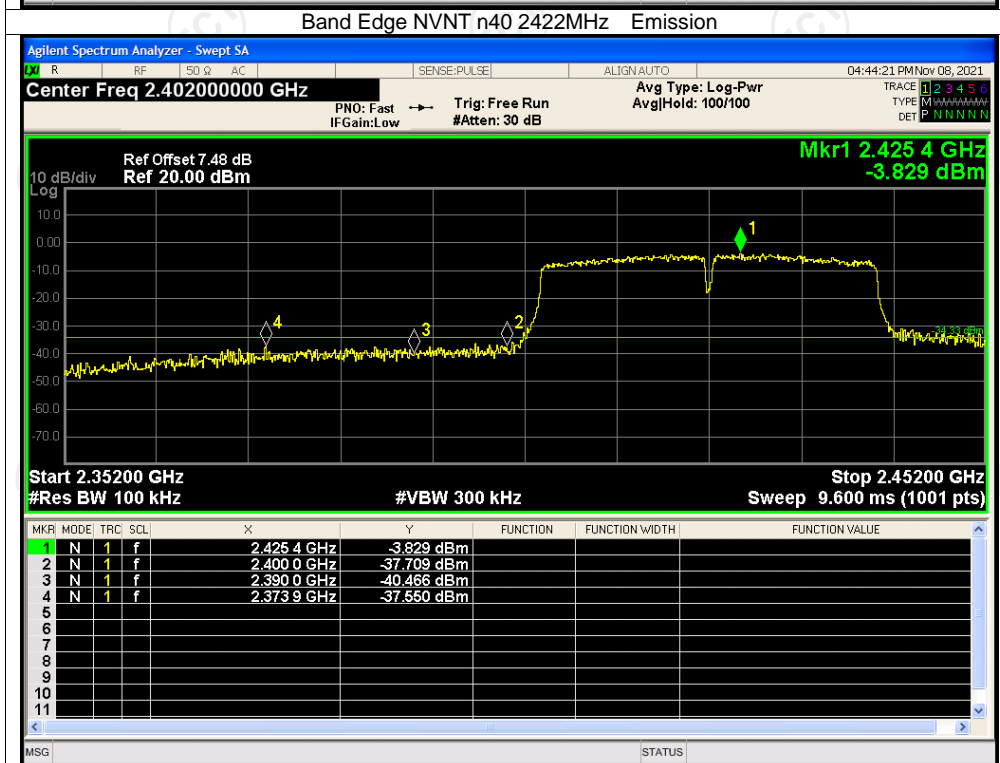
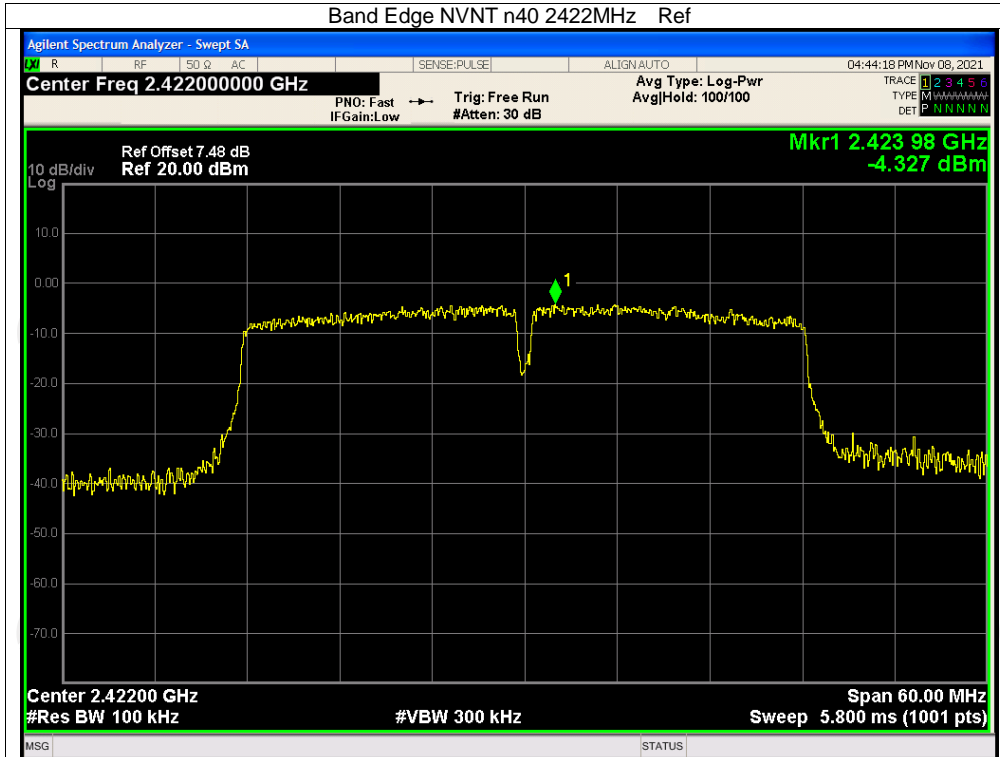

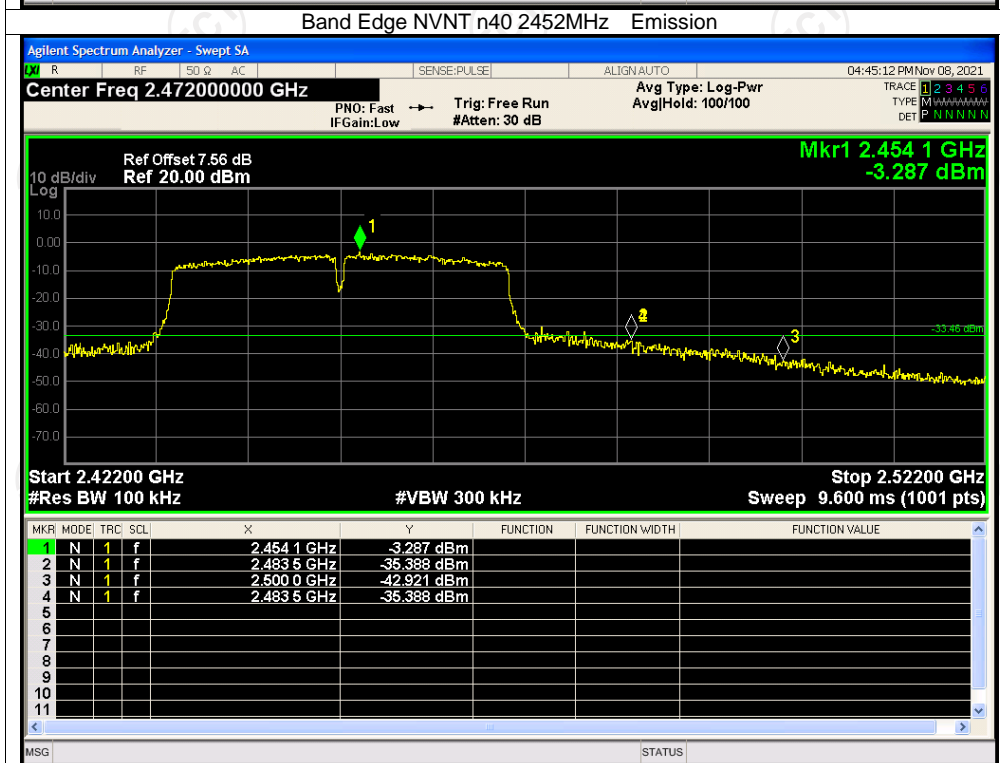
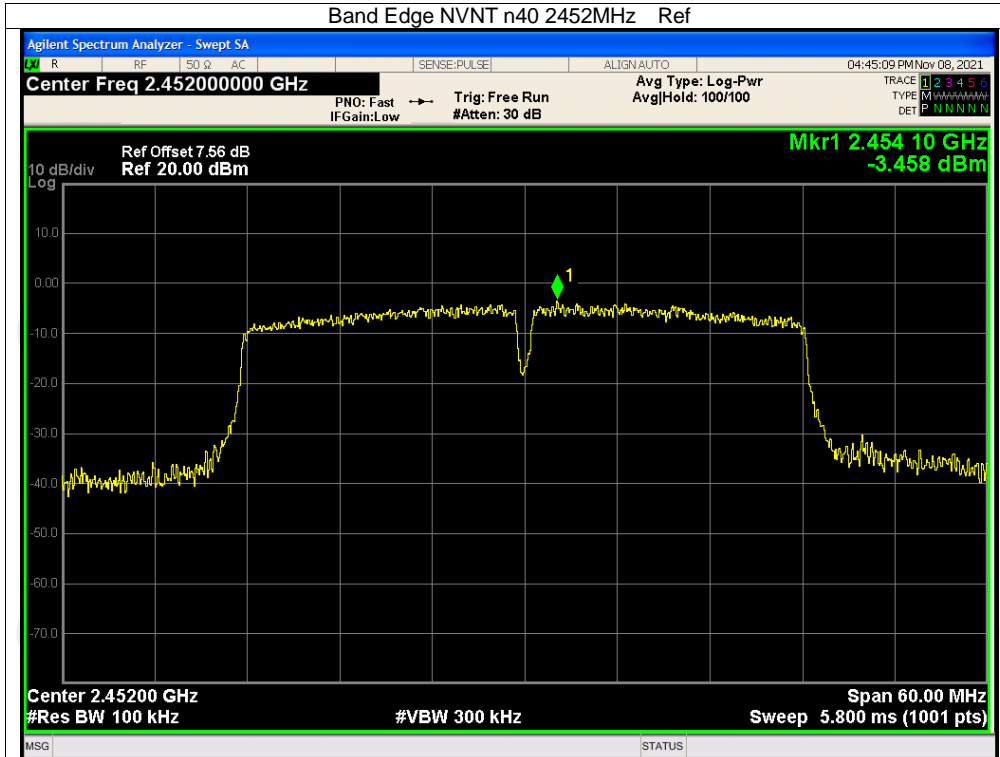

Conducted RF Spurious Emission

Condition	Mode	Frequency (MHz)	Max Value (dBc)	Limit (dBc)	Verdict
NVNT	b	2412	-46.04	-30	Pass
NVNT	b	2437	-47.61	-30	Pass
NVNT	b	2462	-47.96	-30	Pass
NVNT	g	2412	-42.74	-30	Pass
NVNT	g	2437	-42.19	-30	Pass
NVNT	g	2462	-43.96	-30	Pass
NVNT	n20	2412	-42.79	-30	Pass
NVNT	n20	2437	-42.21	-30	Pass
NVNT	n20	2462	-43.24	-30	Pass
NVNT	n40	2422	-38.51	-30	Pass
NVNT	n40	2437	-39.57	-30	Pass
NVNT	n40	2452	-38.24	-30	Pass

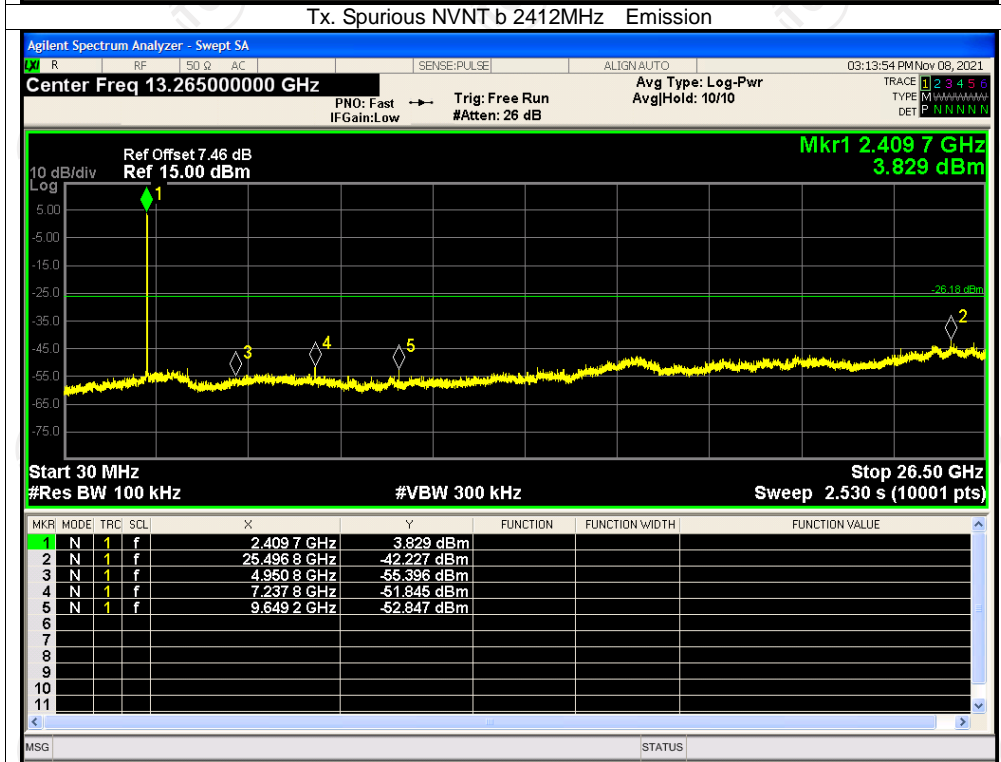
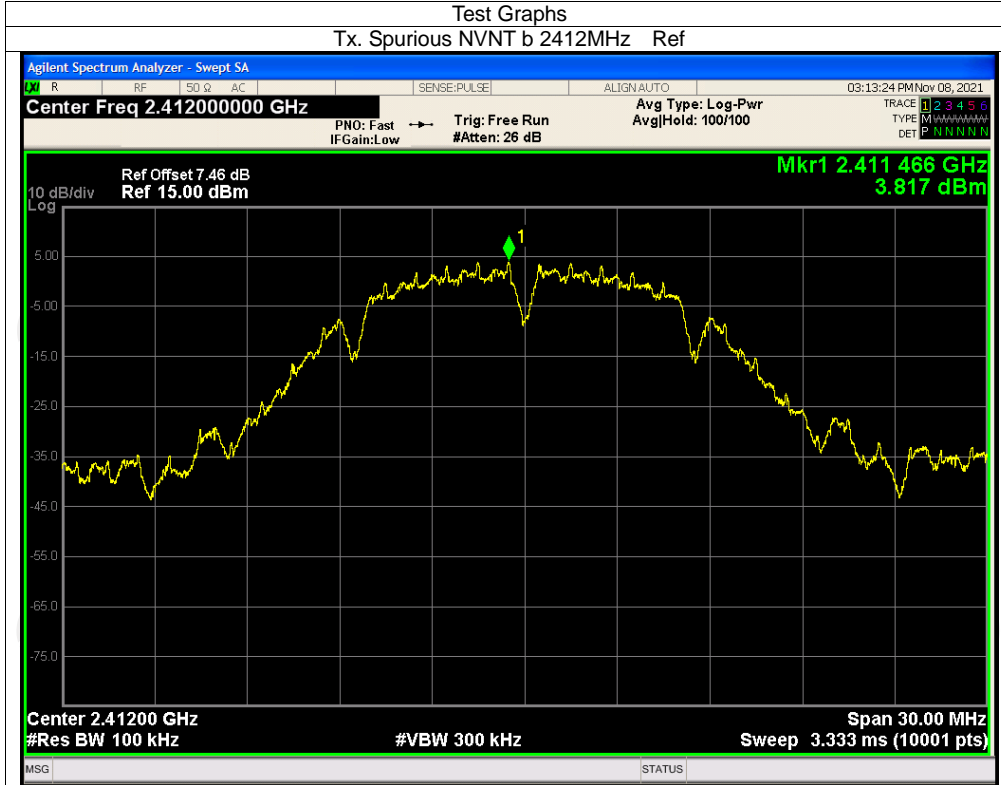

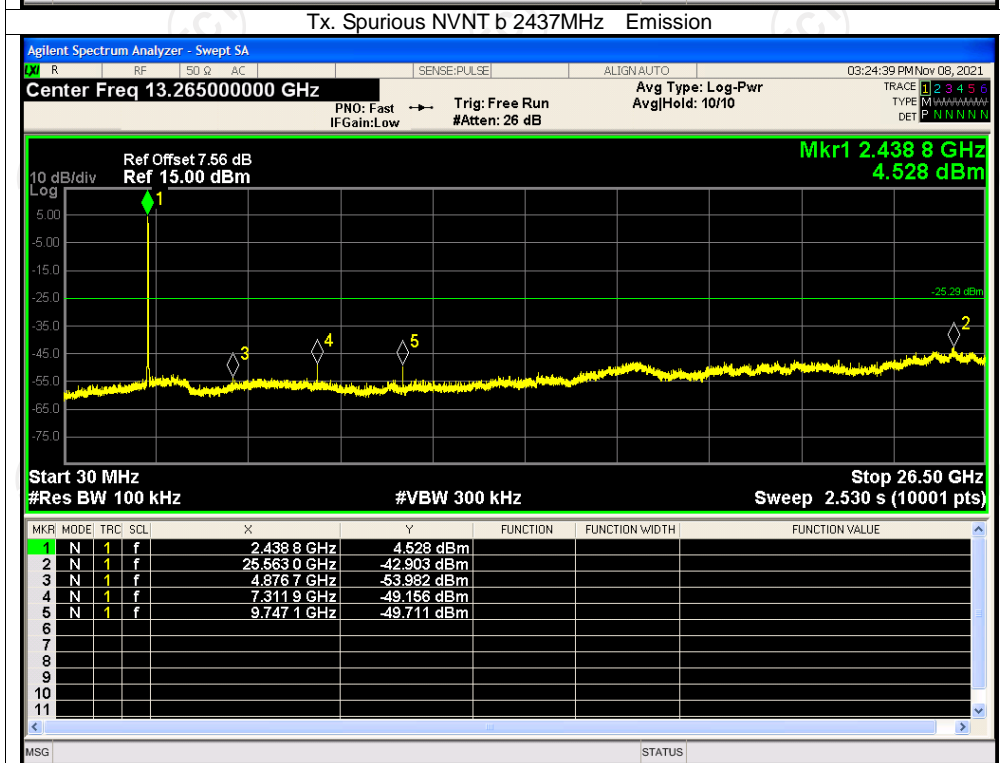
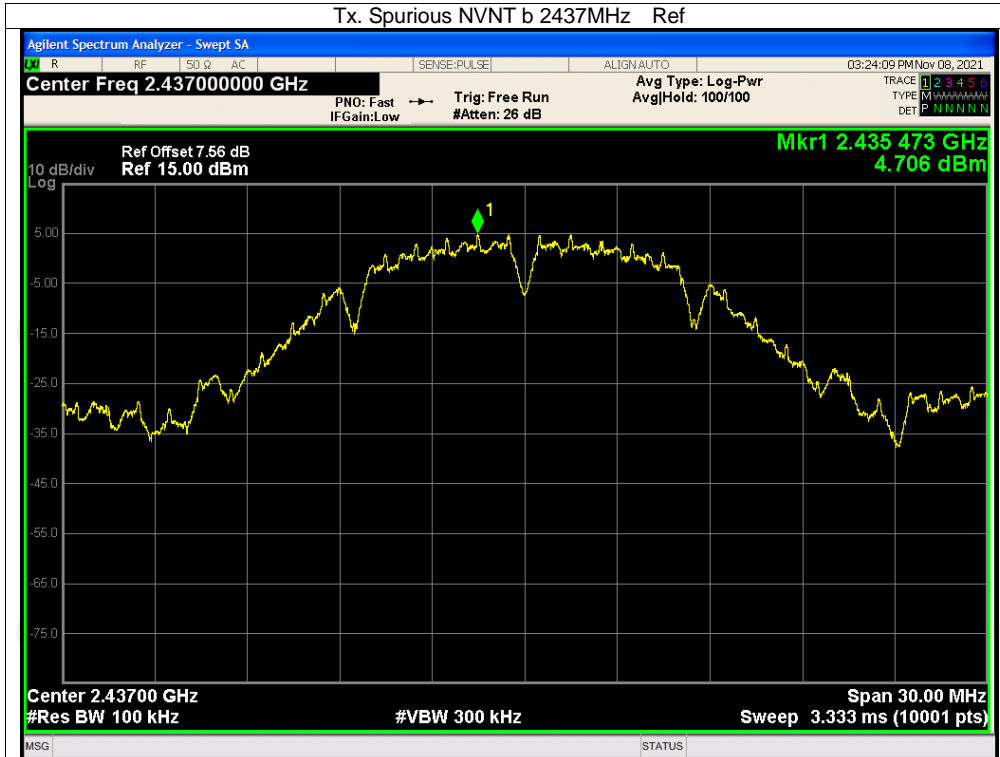

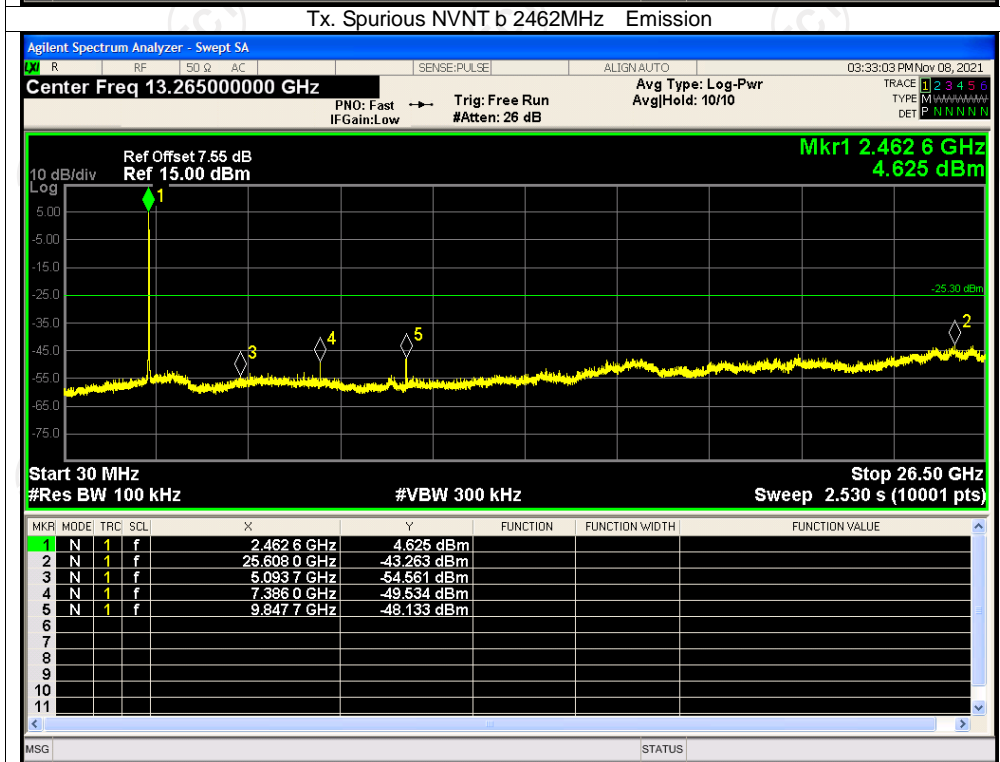
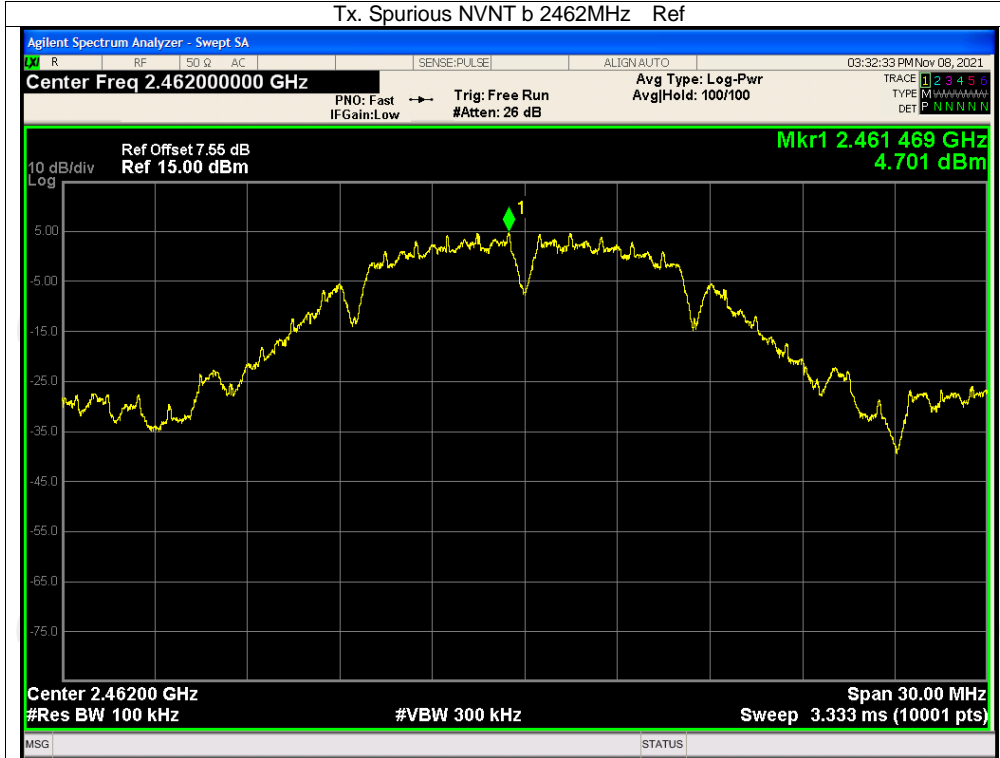

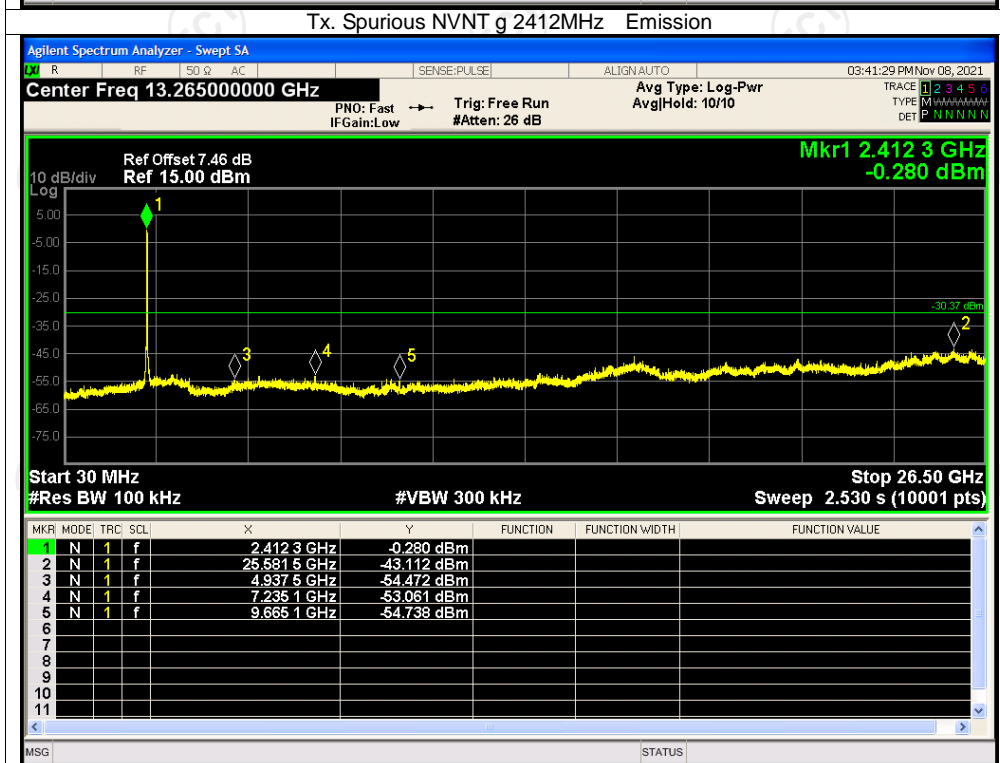
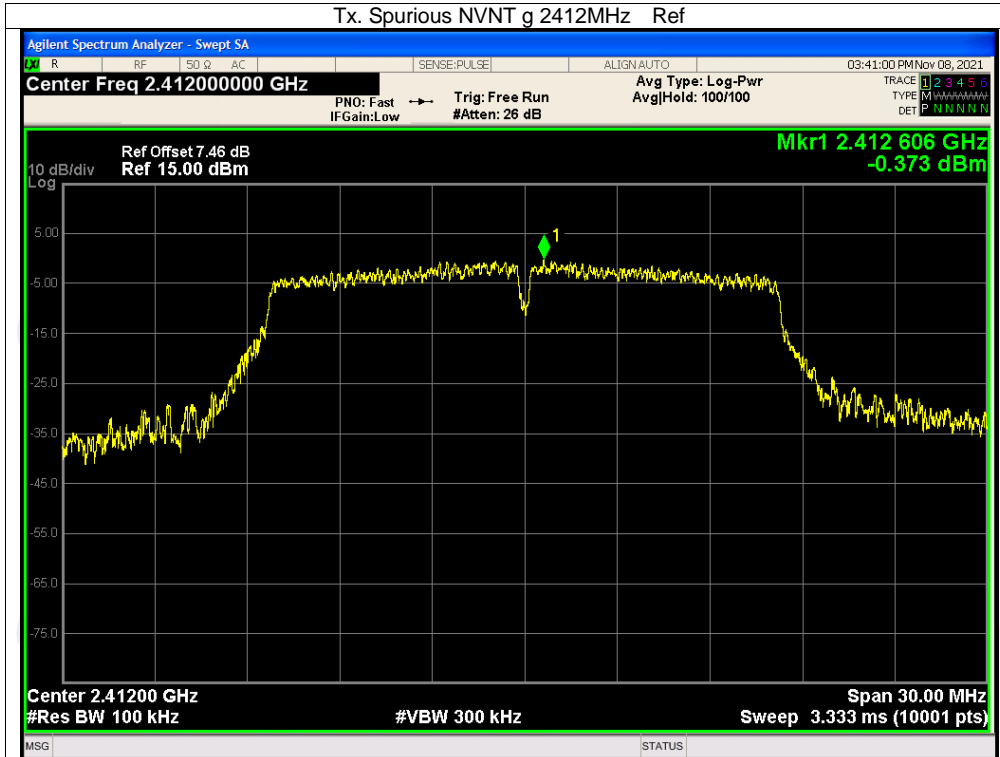

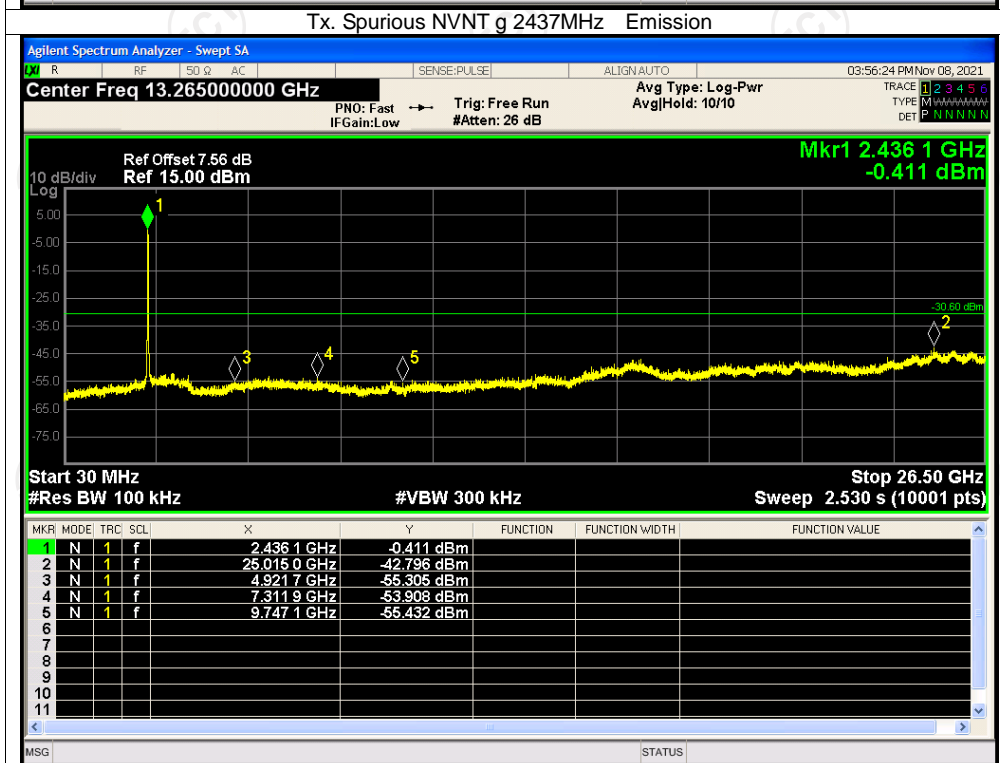
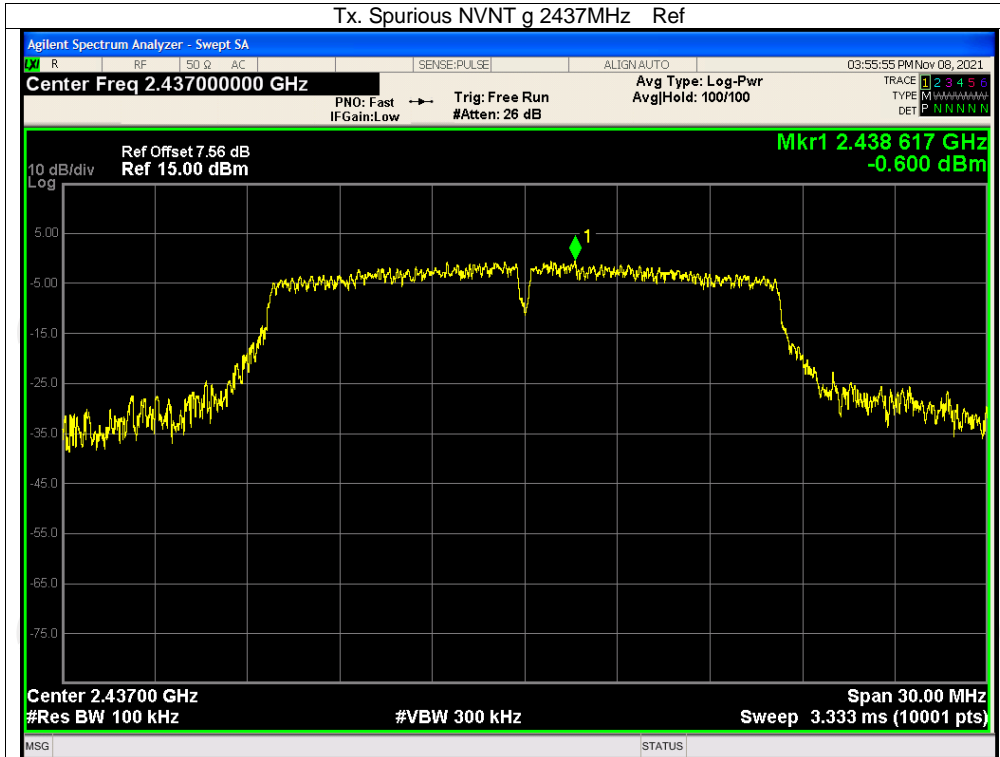

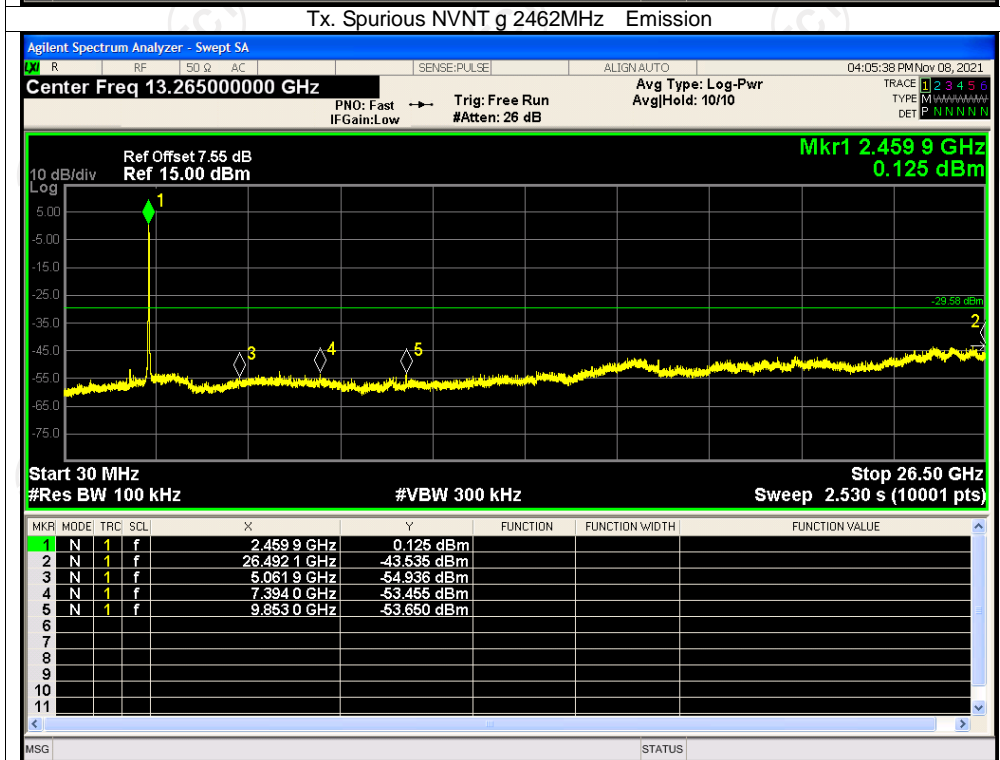
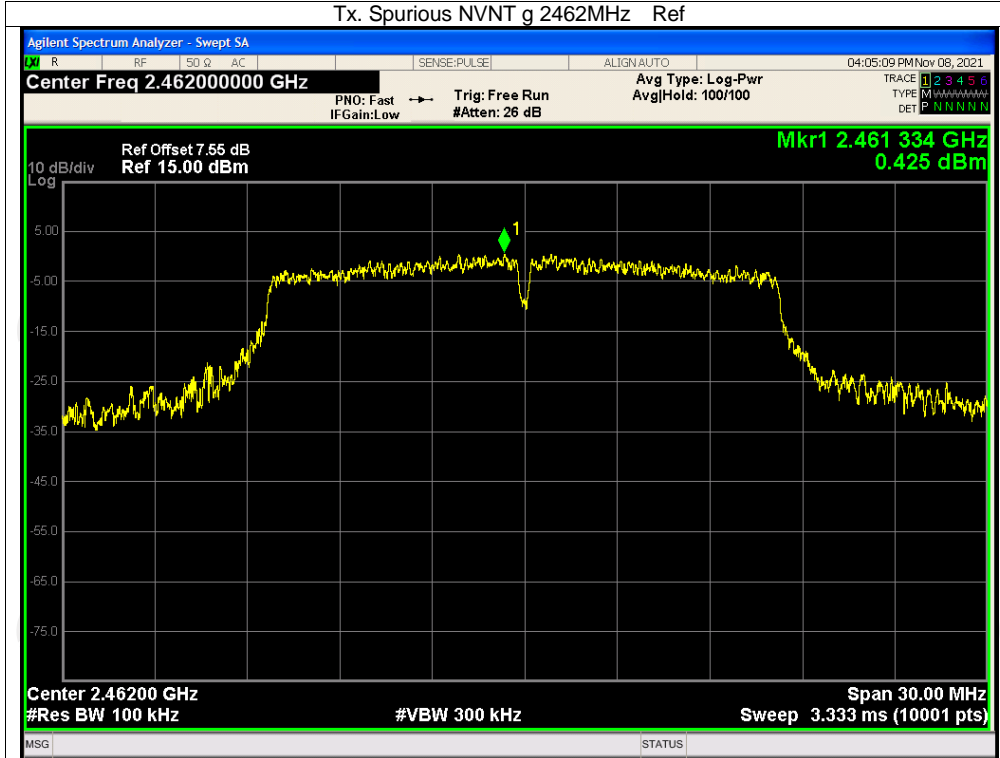

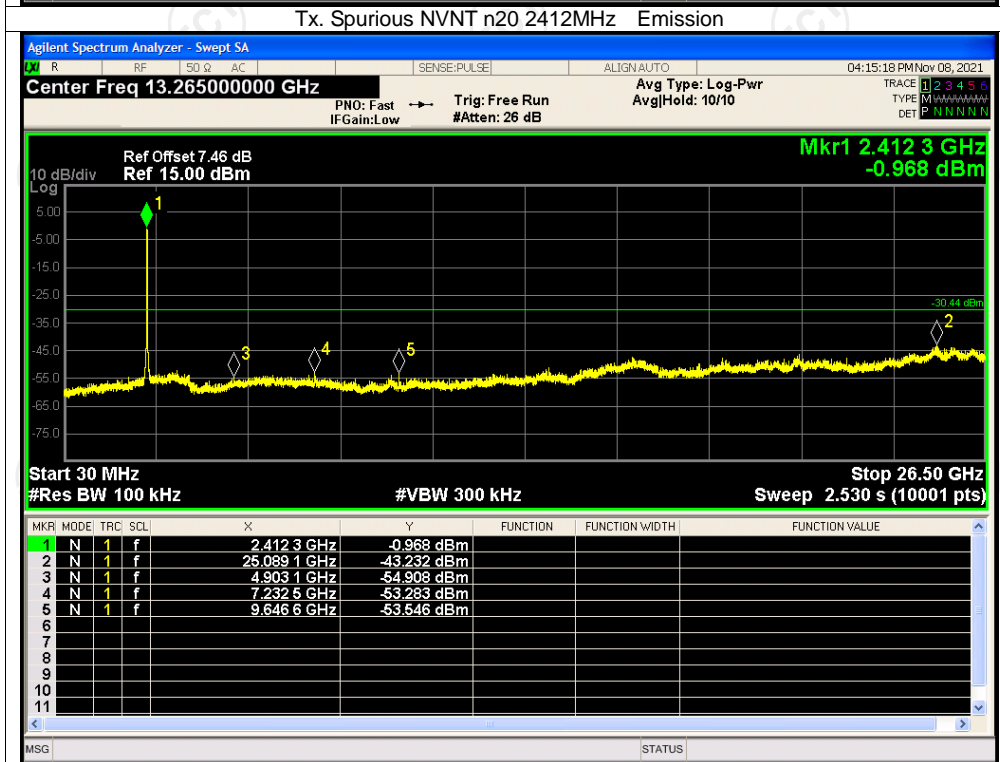
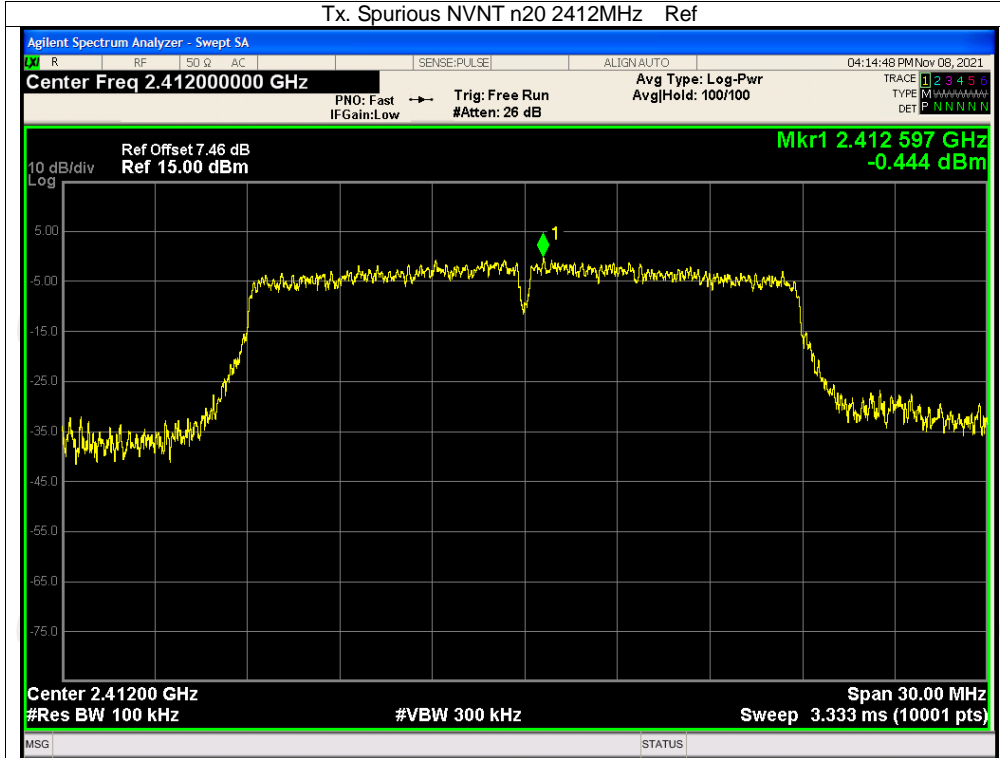

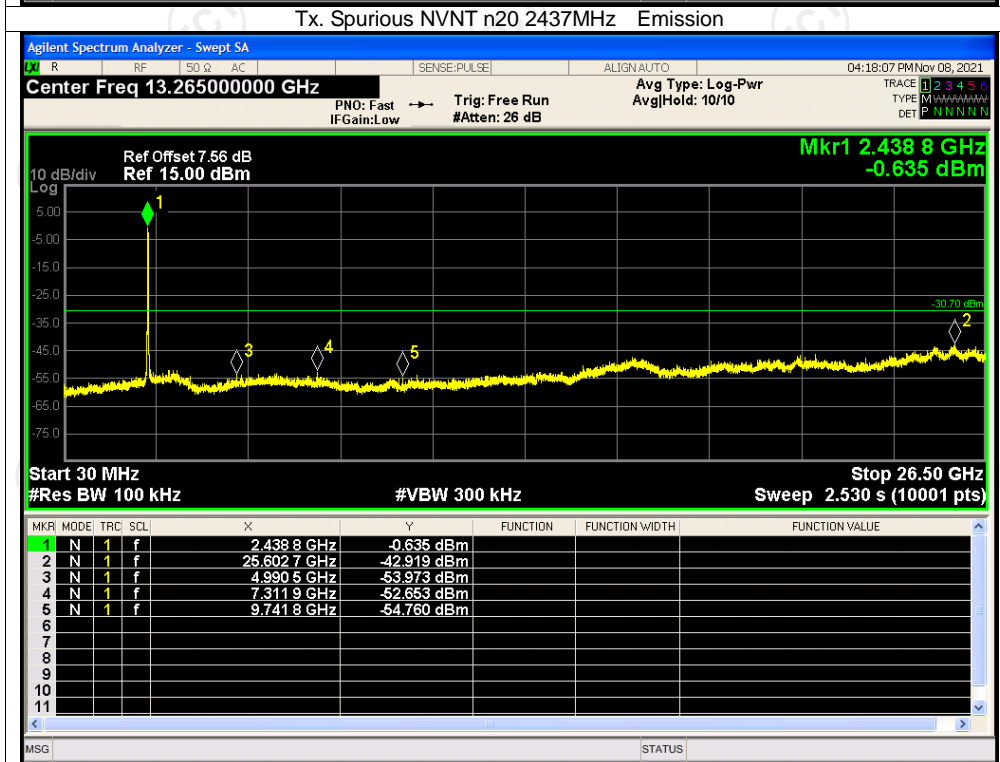
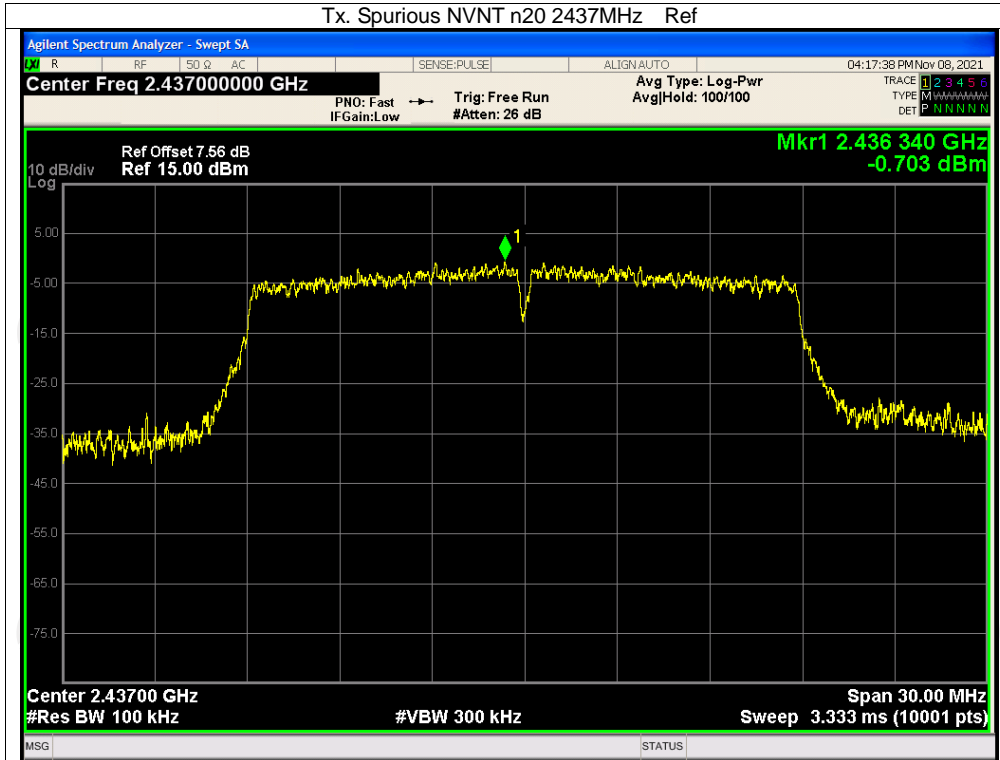

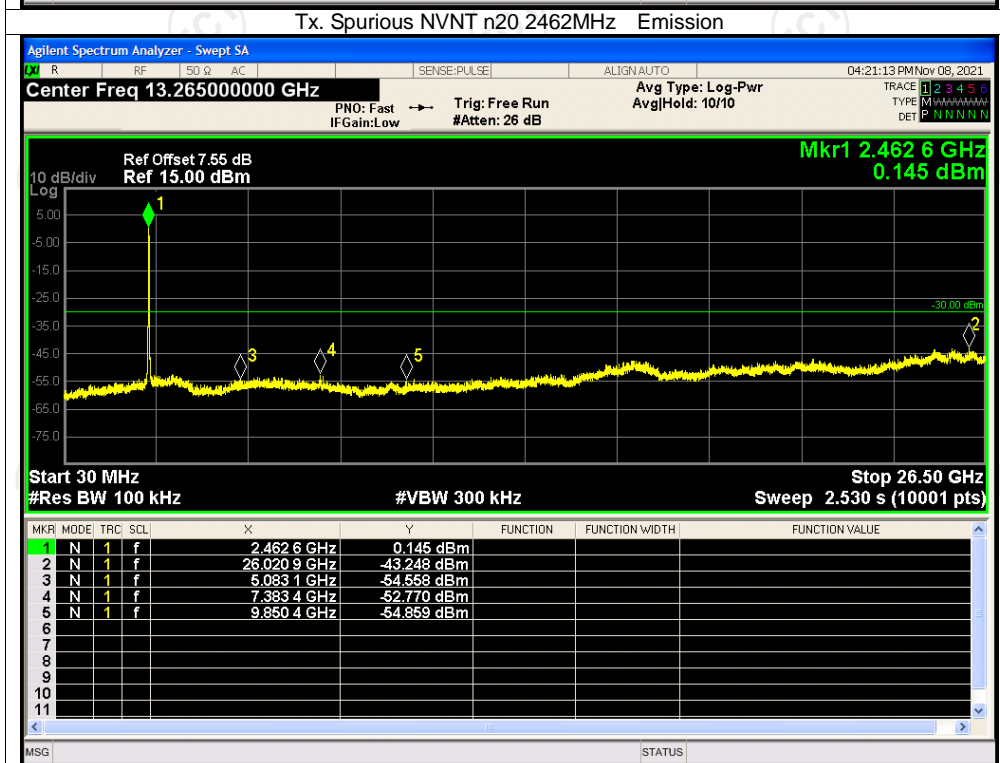
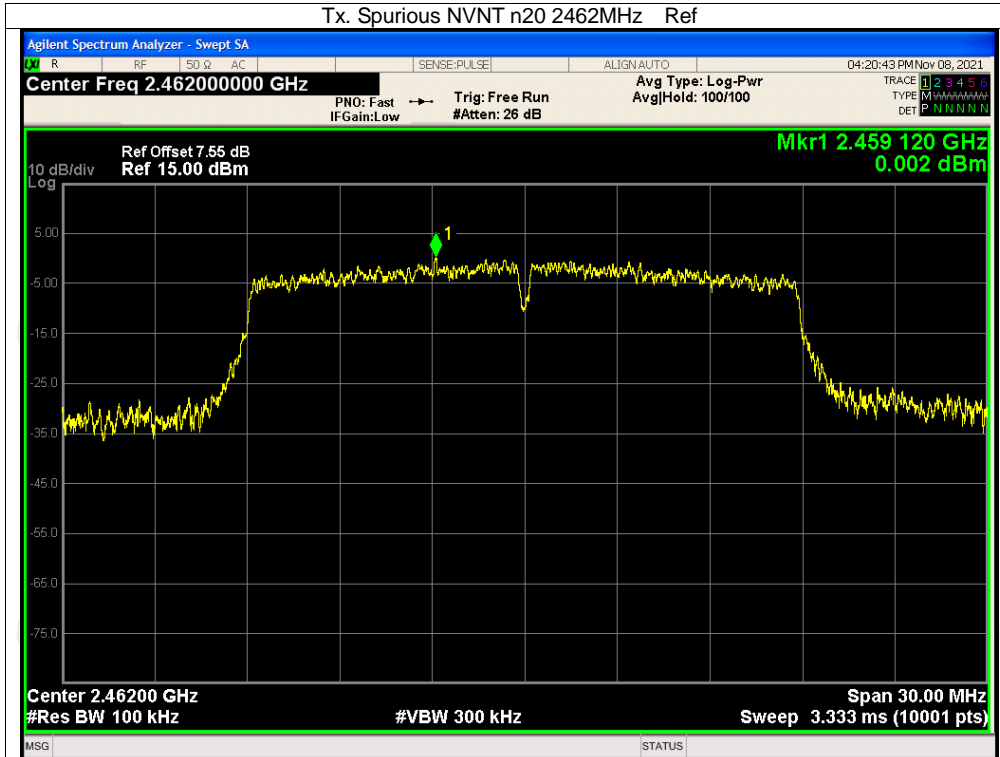

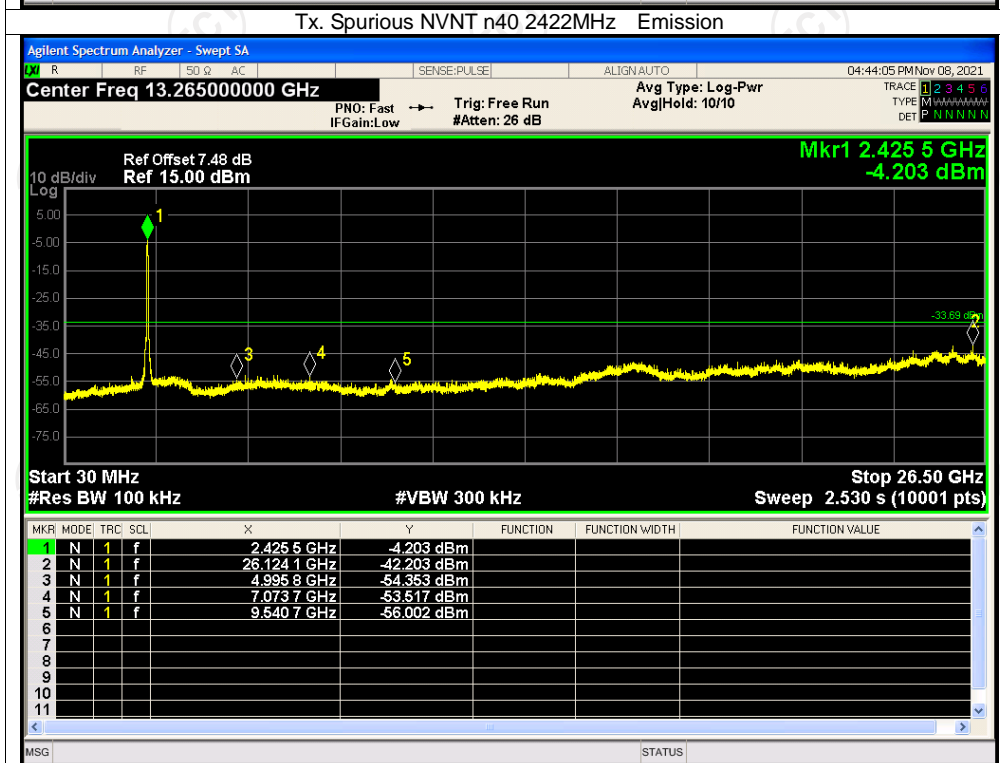
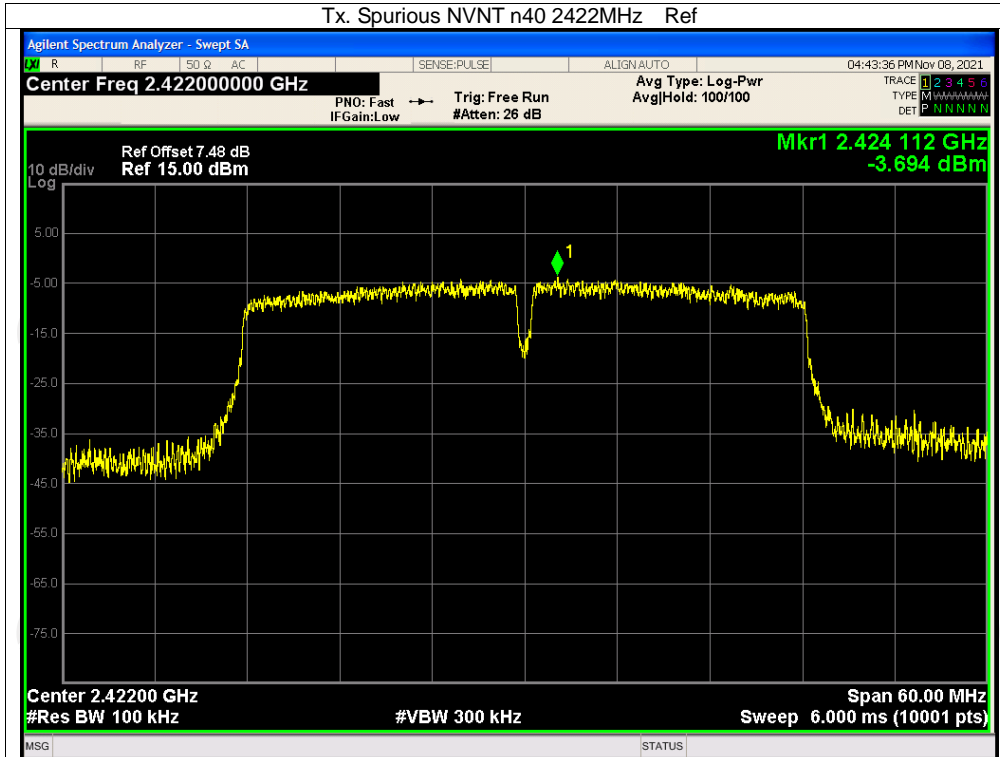

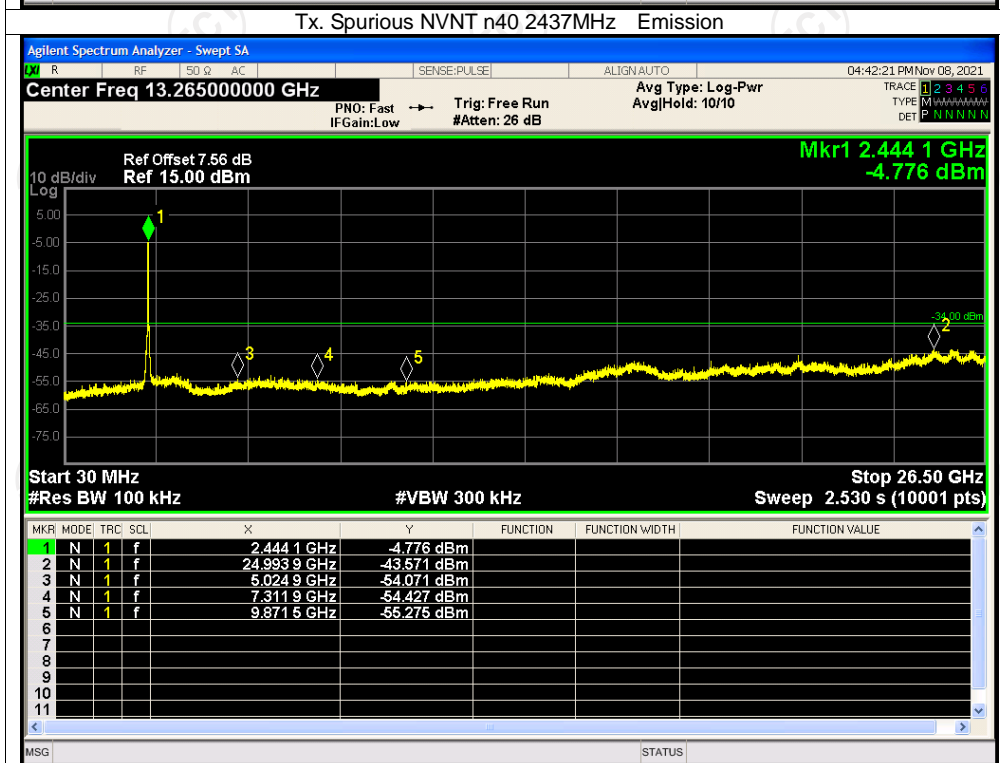
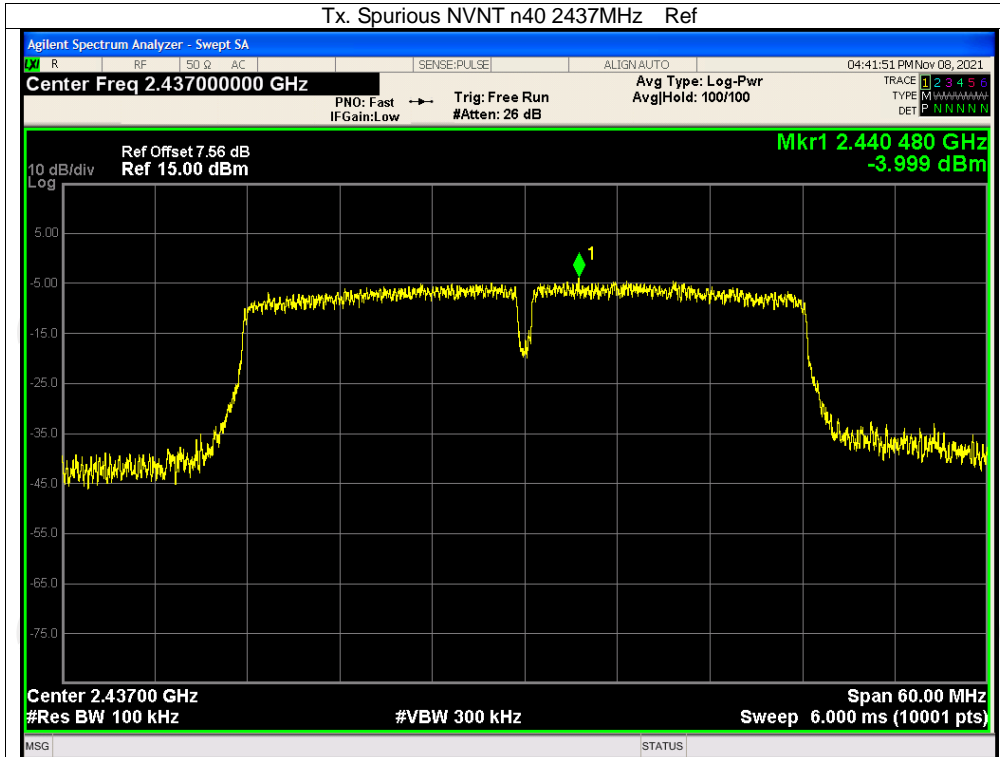

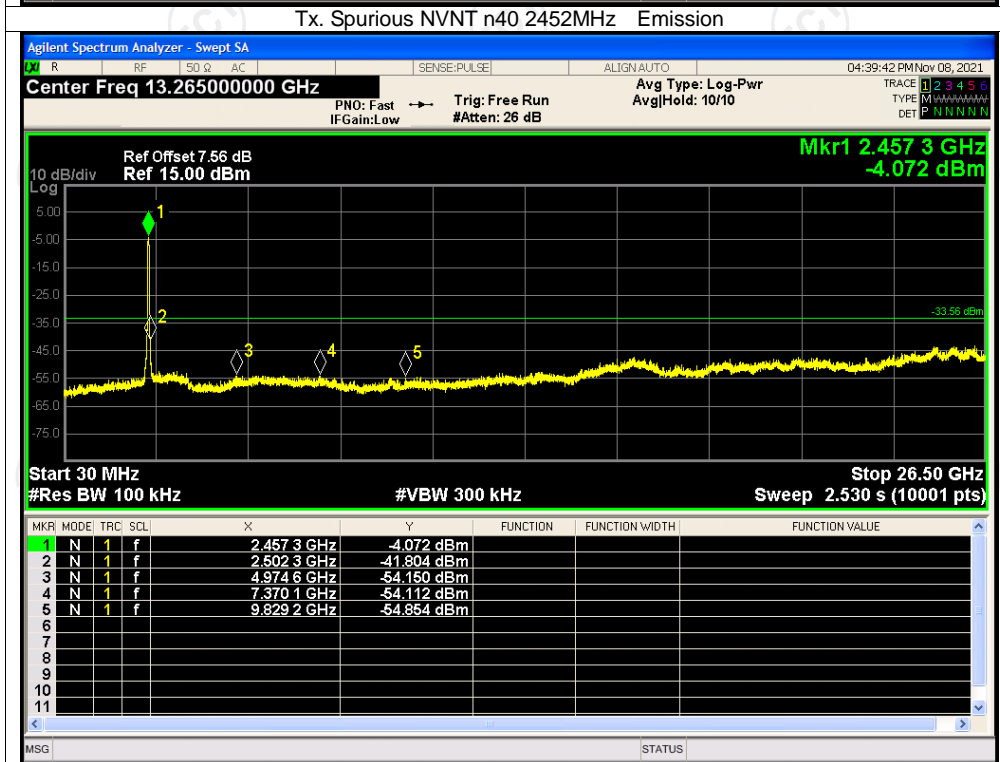
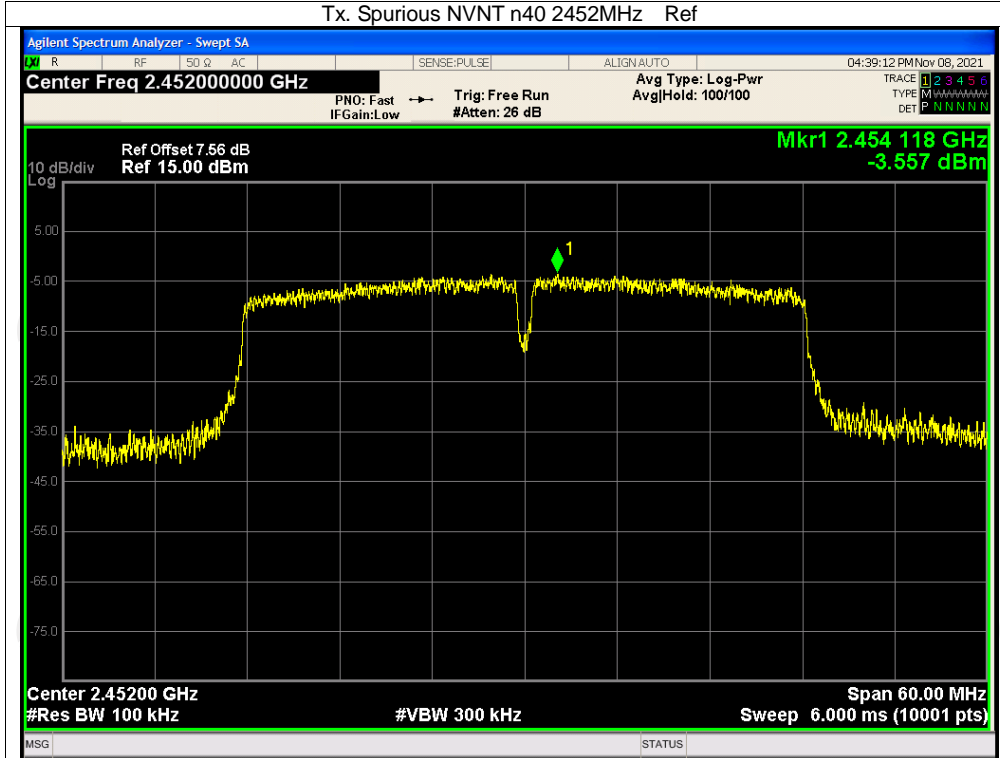

Appendix B: Photographs of Test Setup

Refer to the test report No. TCT211020E032

Appendix C: Photographs of EUT

Refer to the test report No. TCT211020E032

*******END OF REPORT*******