



# FCC TEST REPORT

## FCC ID: 2AUARDIAGMINI2

**Report Number..... : ZKT-230328L2141E-1**

Date of Test..... March 22 2023 to April 08, 2023

Date of issue..... April 08, 2023

Total number of pages ..... 72

Test Result ..... PASS

**Testing Laboratory..... : Shenzhen ZKT Technology Co., Ltd.**

Address ..... 1/F, No. 101, Building B, No. 6, Tangwei Community Industrial Avenue, Fuhai Street, Bao'an District, Shenzhen, China

**Applicant's name ..... : THINKCAR TECH CO., LTD.**

Address ..... 2606, building 4, phase II, TiananYungu, Gangtou community, Bantian, Longgang District, Shenzhen, China

**Manufacturer's name ..... : THINKCAR TECH CO., LTD.**

Address ..... 2606, building 4, phase II, TiananYungu, Gangtou community, Bantian, Longgang District, Shenzhen, China

Test specification:

Standard ..... FCC CFR Title 47 Part 15 Subpart C Section 15.247  
ANSI C63.10:2013

Test procedure ..... /

Non-standard test method ..... N/A

**Test Report Form No. .... : TRF-EL-112\_V0**

**Test Report Form(s) Originator .... : ZKT Testing**

**Master TRF ..... : Dated: 2021-07-06**

This device described above has been tested by ZKT, and the test results show that the equipment under test (EUT) is in compliance with the FCC requirements. And it is applicable only to the tested sample identified in the report.

This report shall not be reproduced except in full, without the written approval of ZKT, this document may be altered or revised by ZKT, personal only, and shall be noted in the revision of the document.

**Product name..... : Automotive Diagnostic Device**

Trademark ..... THINKCAR, XHINKCAR, MUCAR

Model/Type reference..... TKD05, THINKDIAG CAN FD, MUCAR VCI 2, THINKDIAG MINI 2

Ratings..... DC 9V~18V



Testing procedure and testing location:

Testing Laboratory .....: Shenzhen ZKT Technology Co., Ltd.

Address.....: 1/F, No. 101, Building B, No. 6, Tangwei Community Industrial Avenue, Fuhai Street, Bao'an District, Shenzhen, China

Tested by (name + signature) .....: Jim Liu

Reviewer (name + signature).....: Jackson Fang

Approved (name + signature) .....: Lake Xie





## Table of Contents

	Page
<b>1. VERSION</b> .....	5
<b>2. TEST SUMMARY</b> .....	6
2.1 TEST FACILITY .....	7
2.2 MEASUREMENT UNCERTAINTY .....	7
<b>3. GENERAL INFORMATION</b> .....	8
3.1 GENERAL DESCRIPTION OF EUT .....	8
3.2 Test Setup Configuration .....	9
3.3 Support Equipment .....	9
3.4 Test Mode .....	10
3.5 EQUIPMENTS LIST FOR ALL TEST ITEMS .....	11
<b>4. EMC EMISSION TEST</b> .....	13
4.1 Conducted emissions .....	13
4.1.1 POWER LINE CONDUCTED EMISSION Limits .....	13
4.1.2 TEST PROCEDURE .....	13
4.1.3 DEVIATION FROM TEST STANDARD .....	13
4.1.4 TEST SETUP .....	13
4.1.5 EUT OPERATING CONDITIONS .....	14
4.1.6 Test Result .....	14
4.2 Radiated emissions .....	15
4.2.1 Radiated Emission Limits .....	15
4.2.2 TEST PROCEDURE .....	15
4.2.3 DEVIATION FROM TEST STANDARD .....	16
4.2.4 TEST SETUP .....	16
4.2.5 EUT OPERATING CONDITIONS .....	17
4.2.6 TEST RESULTS .....	18
<b>5. RADIATED BAND EMISSION MEASUREMENT</b> .....	27
5.1 Test Requirement: .....	27
5.2 TEST PROCEDURE .....	27
5.3 DEVIATION FROM TEST STANDARD .....	28
5.4 TEST SETUP .....	28
5.5 EUT OPERATING CONDITIONS .....	28
5.6 TEST RESULT .....	29
<b>6. CONDUCTED BAND EDGE AND SPURIOUS EMISSION</b> .....	30
6.1 Limit .....	30
6.2 Test Setup .....	30
6.3 Test procedure .....	30
6.4 DEVIATION FROM STANDARD .....	30
6.5 CSE Test Result .....	31
<b>7. 20DB&amp;99% BANDWIDTH</b> .....	42
7.1 Test Setup .....	42
7.2 Limit .....	42
7.3 Test procedure .....	42
7.4 DEVIATION FROM STANDARD .....	42



7.5 BW Test Result .....	42
<b>8. MAXIMUM PEAK OUTPUT POWER .....</b>	<b>49</b>
8.1 Block Diagram Of Test Setup .....	49
8.2 Limit .....	49
8.3 Test procedure .....	49
8.4 DEVIATION FROM STANDARD .....	49
8.5 Max Power Test Result .....	49
<b>9. HOPPING CHANNEL SEPARATION .....</b>	<b>55</b>
9.1 Test Setup .....	55
9.2 Test procedure .....	55
9.3 DEVIATION FROM STANDARD .....	55
9.4 HCS Test Result .....	56
<b>10.NUMBER OF HOPPING FREQUENCY .....</b>	<b>61</b>
10.1 Test Setup .....	61
10.2 Test procedure .....	61
10.3 DEVIATION FROM STANDARD .....	61
10.4 Number of Hopping Frequency Test Result .....	62
<b>11. DWELL TIME .....</b>	<b>64</b>
11.1 Test Setup .....	64
11.2 Test procedure .....	64
11.3 DEVIATION FROM STANDARD .....	64
11.4 Dwell Time Test Result .....	65
<b>12. ANTENNA REQUIREMENT .....</b>	<b>71</b>
<b>13. TEST SETUP PHOTO .....</b>	<b>72</b>
<b>14. EUT CONSTRUCTIONAL DETAILS .....</b>	<b>72</b>



### 1. VERSION

Report No.	Version	Description	Approved
ZKT-230328L2141E-1	Rev.01	Initial issue of report	April 08, 2023



## 2. TEST SUMMARY

Test procedures according to the technical standards:

FCC Part15 (15.247), Subpart C			
Standard Section	Test Item	Result	Remark
15.203/15.247 (c)	Antenna Requirement	PASS	
15.207	AC Power Line Conducted Emission	N/A	
15.247 (b)(1)	Conducted Peak Output Power	PASS	
15.247 (a)(1)	20dB Occupied Bandwidth 99% OCB	PASS	
15.247 (a)(1)	Carrier Frequencies Separation	PASS	
15.247 (a)(1)(iii)	Hopping Channel Number	PASS	
15.247 (a)(1)(iii)	Dwell Time	PASS	
15.205/15.209	Radiated Emission and Restricted Band	PASS	
15.247(d)	Conducted Unwanted emissions and Band Edge	PASS	

**NOTE:**

(1) "N/A" denotes test is not applicable in this Test Report



## 2.1 TEST FACILITY

Shenzhen ZKT Technology Co., Ltd.  
Add. : 1/F, No. 101, Building B, No. 6, Tangwei Community Industrial Avenue, Fuhai Street,  
Bao'an District, Shenzhen, China

FCC Test Firm Registration Number: 692225  
Designation Number: CN1299  
IC Registered No.: 27033  
Designation Number: CN0110

## 2.2 MEASUREMENT UNCERTAINTY

The reported uncertainty of measurement  $y \pm U$ , where expanded uncertainty  $U$  is based on a standard uncertainty multiplied by a coverage factor of  $k=2$ , providing a level of confidence of approximately 95 %.

No.	Item	Uncertainty
1	3m chamber Radiated spurious emission(9KHz-30MHz)	U=4.5dB
2	3m chamber Radiated spurious emission(30MHz-1GHz)	U=4.8dB
3	3m chamber Radiated spurious emission(1GHz-6GHz)	U=4.9dB
4	3m chamber Radiated spurious emission(6GHz-40GHz)	U=5.0dB
5	Conducted disturbance	U=3.2dB
6	RF Band Edge	U=1.68dB
7	RF power conducted	U=1.86dB
8	RF conducted Spurious Emission	U=2.2dB
9	RF Occupied Bandwidth	U=1.8dB
10	RF Power Spectral Density	U=1.75dB
11	humidity uncertainty	U=5.3%
12	Temperature uncertainty	U=0.59°C



### 3. GENERAL INFORMATION

#### 3.1 GENERAL DESCRIPTION OF EUT

Product Name:	Automotive Diagnostic Device
Model No.:	TKD05, THINKDIAG CAN FD, MUCAR VCI 2, THINKDIAG MINI 2
Model Different.:	The color of appearance and model name of series models listed are different from the main model, but the circuit and the electronic construction are the same, declared by the manufacturer.
Sample ID	ZKT-230328L2141E
Sample(s) Status:	Engineer sample
Channel numbers:	79
Operation Frequency:	2402MHz~2480MHz
Modulation technology:	GFSK, $\pi/4$ -DQPSK, 8-DPSK
Antenna Type:	FPCB ANT
Antenna gain:	0dBi
Power supply:	DC 9V~18V
SWITCHING POWER ADAPTER:	N/A

Operation Frequency each of channel							
Channel	Frequency	Channel	Frequency	Channel	Frequency	Channel	Frequency
1	2402MHz	21	2422MHz	41	2442MHz	61	2462MHz
2	2403MHz	22	2423MHz	42	2443MHz	62	2463MHz
3	2404MHz	23	2424MHz	43	2444MHz	63	2464MHz
4	2405MHz	24	2425MHz	44	2445MHz	64	2465MHz
5	2406MHz	25	2426MHz	45	2446MHz	65	2466MHz
6	2407MHz	26	2427MHz	46	2447MHz	66	2467MHz
7	2408MHz	27	2428MHz	47	2448MHz	67	2468MHz
8	2409MHz	28	2429MHz	48	2449MHz	68	2469MHz
9	2410MHz	29	2430MHz	49	2450MHz	69	2470MHz
10	2411MHz	30	2431MHz	50	2451MHz	70	2471MHz
11	2412MHz	31	2432MHz	51	2452MHz	71	2472MHz
12	2413MHz	32	2433MHz	52	2453MHz	72	2473MHz
13	2414MHz	33	2434MHz	53	2454MHz	73	2474MHz
14	2415MHz	34	2435MHz	54	2455MHz	74	2475MHz
15	2416MHz	35	2436MHz	55	2456MHz	75	2476MHz
16	2417MHz	36	2437MHz	56	2457MHz	76	2477MHz
17	2418MHz	37	2438MHz	57	2458MHz	77	2478MHz
18	2419MHz	38	2439MHz	58	2459MHz	78	2479MHz
19	2420MHz	39	2440MHz	59	2460MHz	79	2480MHz





20	2421MHz	40	2441MHz	60	2461MHz	
----	---------	----	---------	----	---------	--

Note:

In section 15.31(m), regards to the operating frequency range over 10 MHz, the Lowest frequency, the middle frequency, and the highest frequency of channel were selected to perform the test, and the selected channel see below:

Test channel	Frequency
The lowest channel	2402MHz
The middle channel	2441MHz
The Highest channel	2480MHz

### 3.2 Test Setup Configuration

Conducted Emission

N/A

Radiated Emission

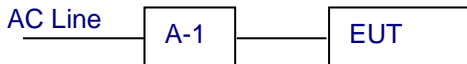

Conducted Spurious



### 3.3 Support Equipment

The EUT has been tested as an independent unit together with other necessary accessories or support units. The following support units or accessories were used to form a representative test configuration during the tests.

Item	Equipment	Mfr/Brand	Model/Type No.	Series No.	Note
E-1	Automotive Diagnostic Device	THINKCAR, XHINKCAR, MUCAR	TKD05	N/A	EUT
A-1	Vehicle simulation unit	THINKCAR	THINKCAR-01	N/A	Auxiliary

Item	Shielded Type	Ferrite Core	Length	Note

Note:

- (1) The support equipment was authorized by Declaration of Confirmation.
- (2) For detachable type I/O cable should be specified the length in cm in 『Length』 column.



### 3.4 Test Mode

Transmitting mode	Keep the EUT in continuously transmitting mode.
Remark: During the test, the test voltage was tuned from 85% to 115% of the nominal rated supply voltage, and found that the worst case was under the nominal rated supply condition. So the report just shows that condition's data.	

Test Software	BT98X FCC Tool V1.2
Power level setup	<0dBm



### 3.5 EQUIPMENTS LIST FOR ALL TEST ITEMS

#### Radiation Test equipment

Item	Equipment	Manufacturer	Type No.	Serial No.	Last calibration	Calibrated until
1	Spectrum Analyzer (9kHz-26.5GHz)	KEYSIGHT	9020A	MY55370835	Oct. 28, 2022	Oct. 27, 2023
2	Spectrum Analyzer (10kHz-39.9GHz)	R&S	FSQ	100363	Oct. 28, 2022	Oct. 27, 2023
3	EMI Test Receiver (9kHz-7GHz)	R&S	ESCI7	101169	Oct. 28, 2022	Oct. 27, 2023
4	Bilog Antenna (30MHz-1500MHz)	Schwarzbeck	VULB9168	N/A	Nov. 02, 2022	Nov. 01, 2023
5	Horn Antenna (1GHz-18GHz)	Agilent	AH-118	071145	Nov. 01, 2022	Oct. 31, 2023
6	Horn Antenna (15GHz-40GHz)	A.H.System	SAS-574	588	Oct. 28, 2022	Oct. 27, 2023
7	Loop Antenna	TESEQ	HLA6121	58357	Nov. 01, 2022	Oct. 31, 2023
8	Amplifier (30-1000MHz)	EM Electronics	EM330 Amplifier	060747	Nov. 15, 2022	Nov. 14, 2023
9	Amplifier (1GHz-26.5GHz)	Agilent	8449B	3008A00315	Oct. 28, 2022	Oct. 27, 2023
10	Amplifier (500MHz-40GHz)	QUANJUDA	DLE-161	097	Oct. 28, 2022	Oct. 27, 2023
11	Test Cable	N/A	R-01	N/A	Oct. 28, 2022	Oct. 27, 2023
12	Test Cable	N/A	R-02	N/A	Oct. 28, 2022	Oct. 27, 2023
13	Test Cable	N/A	R-03	N/A	Oct. 28, 2022	Oct. 27, 2023
14	Test Cable	N/A	RF-01	N/A	Oct. 28, 2022	Oct. 27, 2023
15	Test Cable	N/A	RF-02	N/A	Oct. 28, 2022	Oct. 27, 2023
16	Test Cable	N/A	RF-03	N/A	Oct. 28, 2022	Oct. 27, 2023
17	ESG Signal Generator	Agilent	E4421B	N/A	Oct. 21, 2022	Oct. 20, 2023
18	Signal Generator	Agilent	N5182A	N/A	Oct. 21, 2022	Oct. 20, 2023
19	Magnetic Field Probe Tester	Narda	ELT-400	0-0344	Nov. 15, 2022	Nov. 14, 2023
20	Wideband Radio Communication Test	R&S	CMW500	106504	Oct. 28, 2022	Oct. 27, 2023
21	MW RF Power Meter Test system	MW	MW100-RPCB	N/A	Oct. 21, 2022	Oct. 20, 2023
22	D.C. Power Supply	LongWei	TPR-6405D	N/A	Oct. 21, 2022	Oct. 20, 2023
23	EMC Software	Frad	EZ-EMC	Ver.EMC-CON 3A1.1	\	\
24	RF Software	MW	MTS8310	V2.0.0.0	\	\
25	Turntable	MF	MF-7802BS	N/A	\	\
26	Antenna tower	MF	MF-7802BS	N/A	\	\



Conduction Test equipment

Item	Kind of Equipment	Manufacturer	Type No.	Serial No.	Last calibration	Calibrated until
1	LISN	R&S	ENV216	101471	Oct. 21, 2022	Oct. 20, 2023
2	LISN	CYBERTEK	EM5040A	E185040014 9	Oct. 21, 2022	Oct. 20, 2023
3	Test Cable	N/A	C-01	N/A	Oct. 21, 2022	Oct. 20, 2023
4	Test Cable	N/A	C-02	N/A	Oct. 21, 2022	Oct. 20, 2023
5	Test Cable	N/A	C-03	N/A	Oct. 21, 2022	Oct. 20, 2023
6	EMI Test Receiver	R&S	ESCI3	101393	Oct. 28, 2022	Oct. 27, 2023
7	EMC Software	Frad	EZ-EMC	Ver.EMC-CO N 3A1.1	\	\



#### 4. EMC EMISSION TEST

##### 4.1 Conducted emissions

Test Requirement:	FCC Part15 C Section 15.207
Test Method:	ANSI C63.10:2013
Test Frequency Range:	150KHz to 30MHz
Receiver setup:	RBW=9KHz, VBW=30KHz, Sweep time=auto

##### 4.1.1 POWER LINE CONDUCTED EMISSION Limits

FREQUENCY (MHz)	Limit (dBuV)		Standard
	Quasi-peak	Average	
0.15 -0.5	66 - 56 *	56 - 46 *	FCC
0.50 -5.0	56.00	46.00	FCC
5.0 -30.0	60.00	50.00	FCC

Note:

(1) \*Decreases with the logarithm of the frequency.

##### 4.1.2 TEST PROCEDURE

- a. The EUT was placed 0.8 meters from the horizontal ground plane with EUT being connected to the power mains through a line impedance stabilization network (LISN). All other support equipments powered from additional LISN(s). The LISN provide 50 Ohm/ 50uH of coupling impedance for the measuring instrument.
- b. Interconnecting cables that hang closer than 40 cm to the ground plane shall be folded back and forth in the center forming a bundle 30 to 40 cm long.
- c. I/O cables that are not connected to a peripheral shall be bundled in the center. The end of the cable may be terminated, if required, using the correct terminating impedance. The overall length shall not exceed 1 m.
- d. LISN at least 80 cm from nearest part of EUT chassis.
- e. For the actual test configuration, please refer to the related Item –EUT Test Photos.

##### 4.1.3 DEVIATION FROM TEST STANDARD

No deviation

##### 4.1.4 TEST SETUP

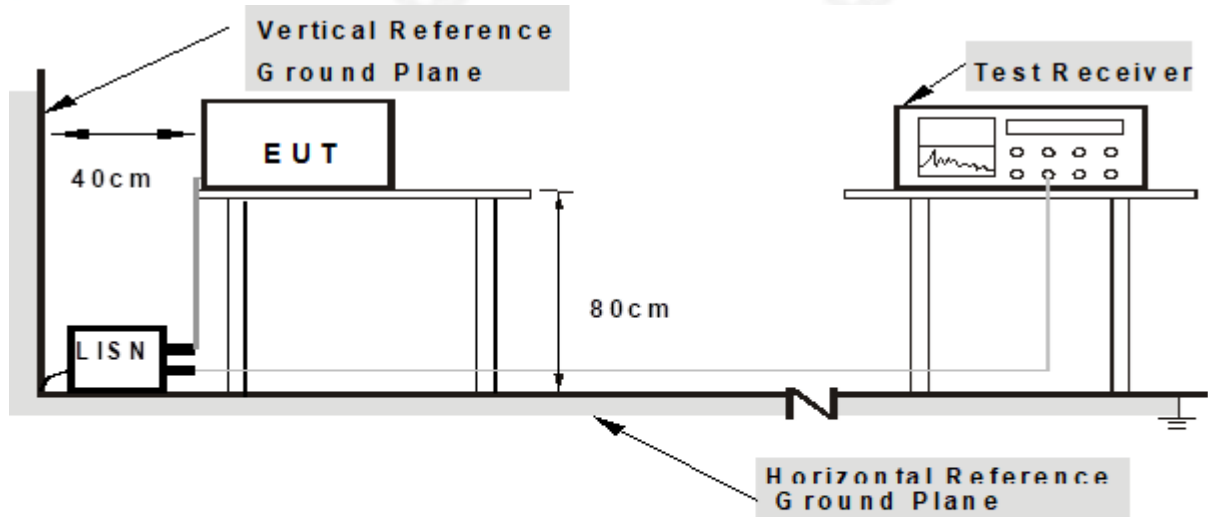

- Note:**
1. Support units were connected to second LISN.
  2. Both of LISNs (AMN) are 80 cm from EUT and at least 80 cm from other units and other metal planes

#### 4.1.5 EUT OPERATING CONDITIONS

The EUT was configured for testing in a typical fashion (as a customer would normally use it). The EUT has been programmed to continuously transmit during test. This operating condition was tested and used to collect the included data.

#### 4.1.6 Test Result

Because the product power is supply through DC 9~18V by car, so not applicable.



#### 4.2 Radiated emissions

Test Requirement:	FCC Part15 C Section 15.209				
Test Method:	ANSI C63.10:2013				
Test Frequency Range:	9kHz to 25GHz				
Test site:	Measurement Distance: 3m				
Receiver setup:	Frequency	Detector	RBW	VBW	Value
	9KHz-150KHz	Quasi-peak	200Hz	MX5Hz	Quasi-peak
	150KHz-30MHz	Quasi-peak	9KHz	30KHz	Quasi-peak
	30MHz-1GHz	Quasi-peak	120KHz	300KHz	Quasi-peak
	Above 1GHz	Peak	1MHz	3MHz	Peak
		Peak	1MHz	10Hz	Average

##### 4.2.1 Radiated Emission Limits

Frequencies (MHz)	Field Strength (micovolts/meter)	Measurement Distance (meters)
0.009~0.490	2400/F(KHz)	300
0.490~1.705	24000/F(KHz)	30
1.705~30.0	30	30
30~88	100	3
88~216	150	3
216~960	200	3
Above 960	500	3

##### LIMITS OF RADIATED EMISSION MEASUREMENT

FREQUENCY (MHz)	Limit (dBuV/m) (at 3M)	
	PEAK	AVERAGE
Above 1000	74	54

Notes:

- (1) The limit for radiated test was performed according to FCC PART 15C.
- (2) The tighter limit applies at the band edges.
- (3) Emission level (dBuV/m)=20log Emission level (uV/m).

##### 4.2.2 TEST PROCEDURE

Below 1GHz test procedure as below:

- a. The EUT was placed on the top of a rotating table 0.8 meters above the ground at a 3 meter semi-anechoic chamber. The table was rotated 360 degrees to determine the position of the highest radiation.
- b. The EUT was set 3 meters away from the interference-receiving antenna, which was mounted on the top of a variable-height antenna tower.
- c. The antenna height is varied from one meter to four meters above the ground to determine the maximum value of the field strength. Both horizontal and vertical polarizations of the antenna are set to make the measurement.



- d. For each suspected emission, the EUT was arranged to its worst case and then the antenna was tuned to heights from 1 meter to 4 meters (for the test frequency of below 30MHz, the antenna was tuned to heights 1 meter) and the rotatable table was turned from 0 degrees to 360 degrees to find the maximum reading.
- e. The test-receiver system was set to Peak Detect Function and Specified Bandwidth with Maximum Hold Mode.
- f. If the emission level of the EUT in peak mode was 10dB lower than the limit specified, then testing could be stopped and the peak values of the EUT would be reported. Otherwise the emissions that did not have 10dB margin would be re-tested one by one using peak, quasi-peak or average method as specified and then reported in a data sheet.

Above 1GHz test procedure as below:

- g. Different between above is the test site, change from Semi- Anechoic Chamber to fully Anechoic Chamber and change form table 0.8 metre to 1.5 metre( Above 18GHz the distance is 1 meter and table is 1.5 metre).
- h. Test the EUT in the lowest channel ,the middle channel ,the Highest channel

Note:

Both horizontal and vertical antenna polarities were tested and performed pretest to three orthogonal axis. The worst case emissions were reported

#### 4.2.3 DEVIATION FROM TEST STANDARD

No deviation

#### 4.2.4 TEST SETUP

(A) Radiated Emission Test-Up Frequency Below 30MHz

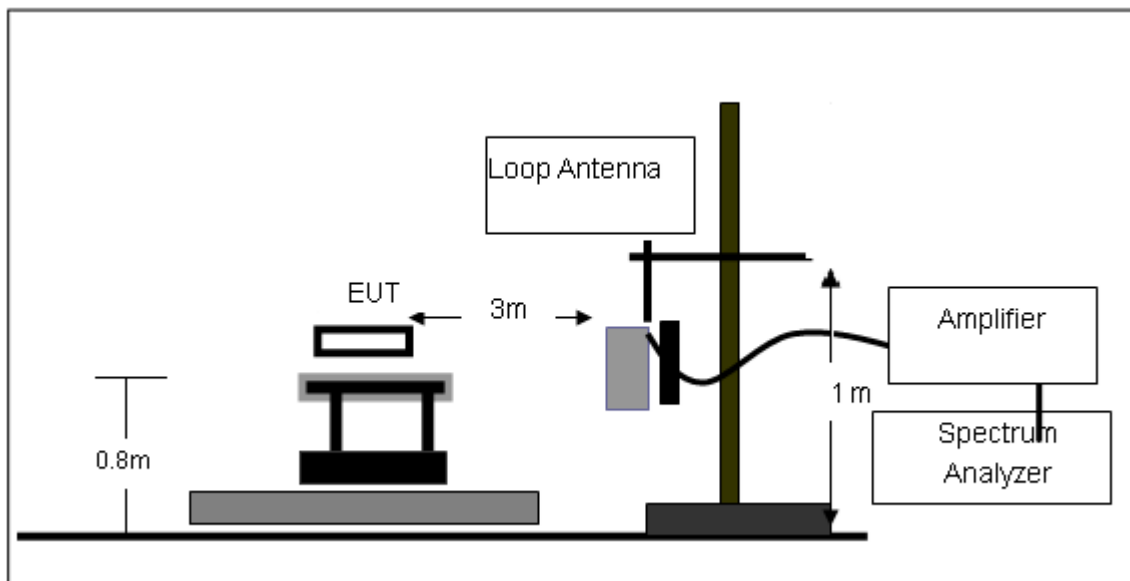





(B) Radiated Emission Test-Up Frequency 30MHz~1GHz

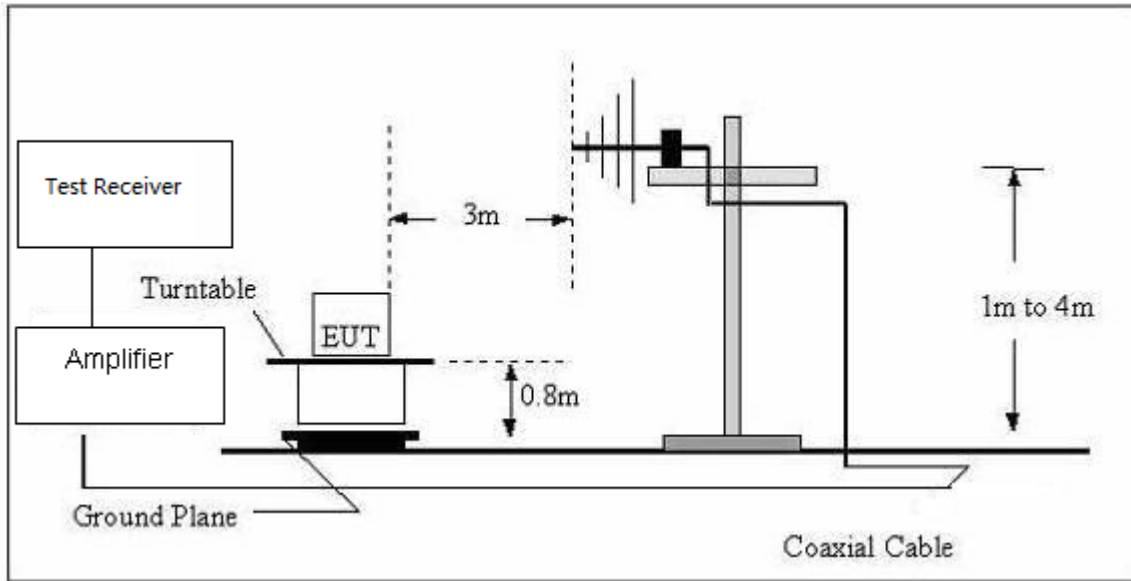

(C) Radiated Emission Test-Up Frequency Above 1GHz

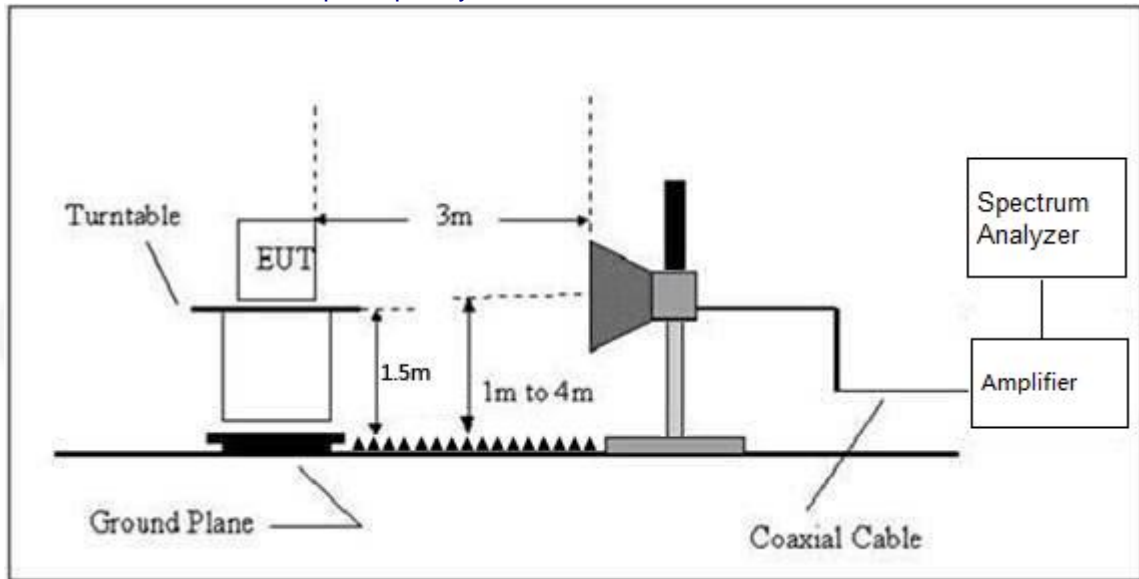

4.2.5 EUT OPERATING CONDITIONS

The EUT tested system was configured as the statements of 2.4 Unless otherwise a special operating condition is specified in the follows during the testing.



#### 4.2.6 TEST RESULTS

Between 9KHz – 30MHz

The emission from 9 kHz to 30MHz was pre-tested and found the result was 20dB lower than the limit, and according to 15.31(o) & RSS-Gen 6.13, the test result no need to reported.



Between 30MHz – 1GHz

Temperature:	26°C	Relative Humidity:	54%
Pressure:	101 kPa	Polarization:	Horizontal
Test Voltage:	DC 18V		

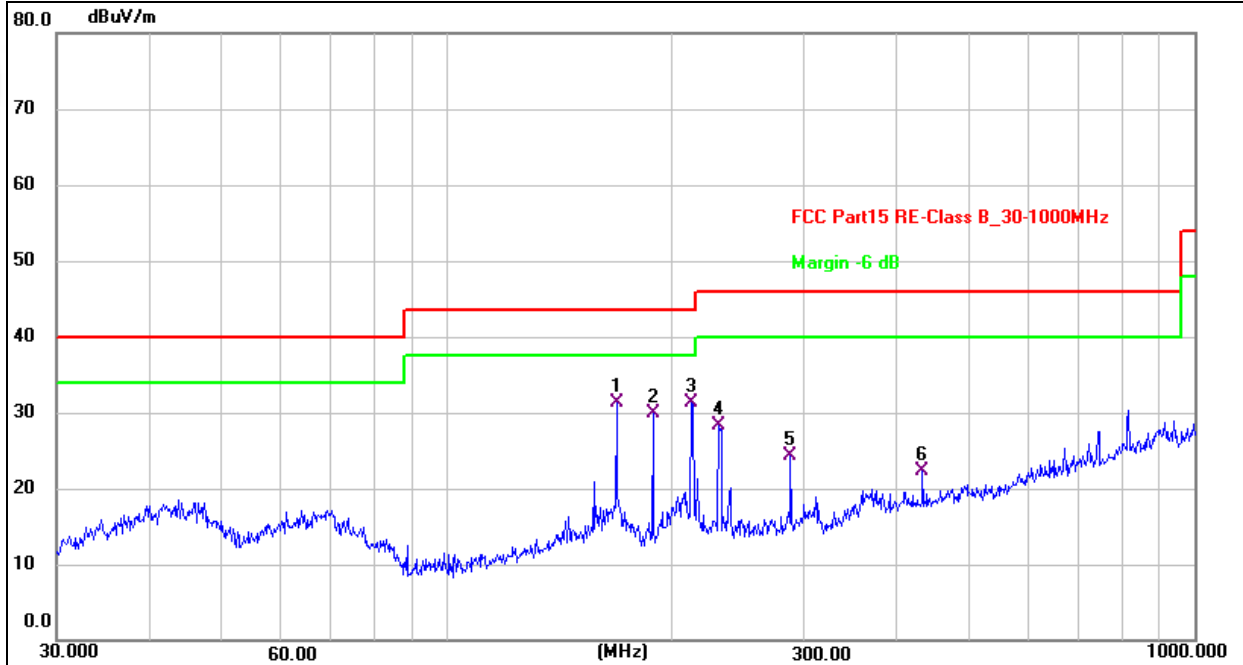

No.	Frequency (MHz)	Reading (dBuV)	Factor (dB/m)	Level (dBuV/m)	Limit (dBuV/m)	Margin (dB)	Detector	Height (cm)	Azimuth (deg.)	P/F	Remark
1	168.4138	40.97	-9.69	31.28	43.50	-12.22	QP	100	196	P	
2	188.4125	42.02	-12.14	29.88	43.50	-13.62	QP	100	196	P	
3 *	212.2695	43.09	-11.80	31.29	43.50	-12.21	QP	100	196	P	
4	230.9068	39.03	-10.74	28.29	46.00	-17.71	QP	100	196	P	
5	287.9904	33.02	-8.75	24.27	46.00	-21.73	QP	100	327	P	
6	432.5457	27.79	-5.48	22.31	46.00	-23.69	QP	100	20	P	



Temperature:	26°C	Relative Humidity:	54%
Pressure:	101kPa	Polarization:	Vertical
Test Voltage:	DC 18V		

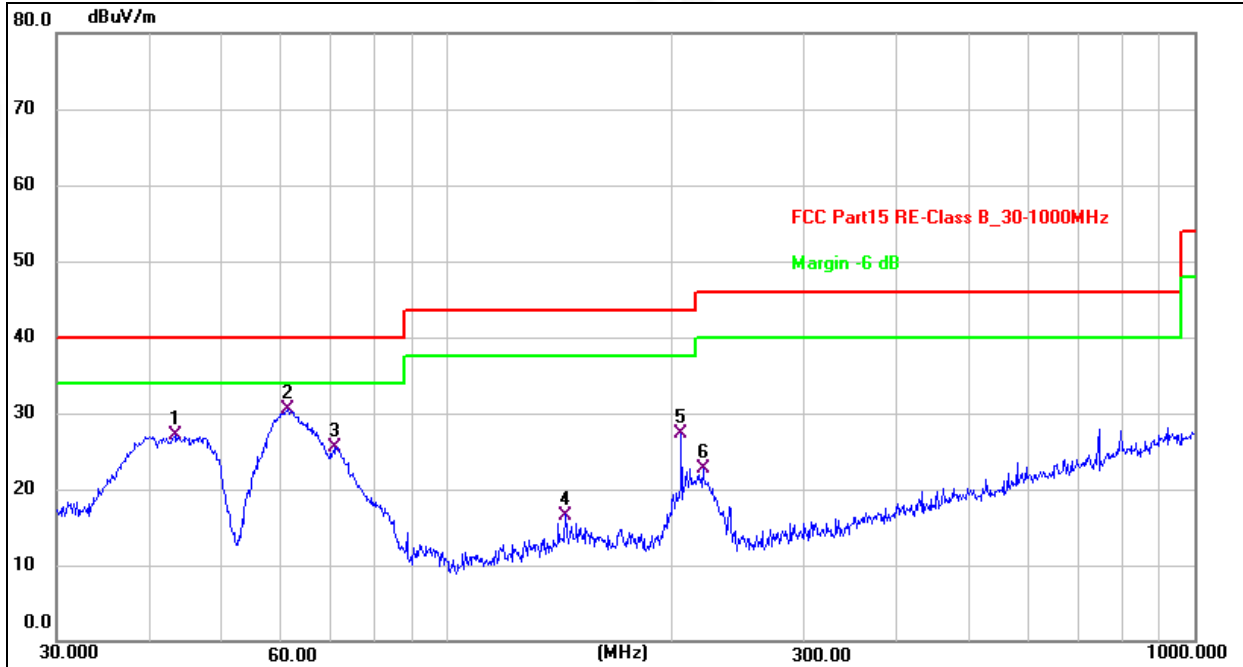

No.	Frequency (MHz)	Reading (dBuV)	Factor (dB/m)	Level (dBuV/m)	Limit (dBuV/m)	Margin (dB)	Detector	Height (cm)	Azimuth (deg.)	P/F	Remark
1	43.2016	36.22	-9.07	27.15	40.00	-12.85	QP	100	278	P	
2 *	61.1315	40.64	-10.14	30.50	40.00	-9.50	QP	100	93	P	
3	70.8315	36.81	-11.26	25.55	40.00	-14.45	QP	100	93	P	
4	143.8295	25.88	-9.28	16.60	43.50	-26.90	QP	100	349	P	
5	205.6750	39.32	-12.03	27.29	43.50	-16.21	QP	100	349	P	
6	219.8448	34.18	-11.48	22.70	46.00	-23.30	QP	100	216	P	

Remarks:

- Final Level = Receiver Read level + Antenna Factor + Cable Loss – Pre-amplifier Factor,  
Margin = Final Level – Limit.
- The emission levels of other frequencies are very lower than the limit and not show in test report.
- The test data shows only the worst case GFSK mode and worst channel 2402MHz.



1GHz~25GHz

GFSK

Polar (H/V)	Frequency	Meter Reading	Pre-amplifier	Cable Loss	Antenna Factor	Emission Level	Limits	Margin	Detector Type
	(MHz)	(dBuV)	(dB)	(dB)	(dB)	(dBuV/m)	(dBuV/m)	(dB)	
Low Channel:2402MHz									
V	4804.00	52.21	30.55	5.77	24.66	52.09	74.00	-21.91	Pk
V	4804.00	45.24	30.55	5.77	24.66	45.12	54.00	-8.88	AV
V	7206.00	51.16	30.33	6.32	24.55	51.70	74.00	-22.30	Pk
V	7206.00	42.55	30.33	6.32	24.55	43.09	54.00	-10.91	AV
V	9608.00	53.32	30.85	7.45	24.69	54.61	74.00	-19.39	Pk
V	9608.00	39.73	30.85	7.45	24.69	41.02	54.00	-12.98	AV
V	12010.00	50.15	31.02	8.99	25.57	53.69	74.00	-20.31	Pk
V	12010.00	38.18	31.02	8.99	25.57	41.72	54.00	-12.28	AV
H	4804.00	55.63	30.55	5.77	24.66	55.51	74.00	-18.49	Pk
H	4804.00	44.30	30.55	5.77	24.66	44.18	54.00	-9.82	AV
H	7206.00	52.98	30.33	6.32	24.55	53.52	74.00	-20.48	Pk
H	7206.00	43.20	30.33	6.32	24.55	43.74	54.00	-10.26	AV
H	9608.00	52.70	30.85	7.45	24.69	53.99	74.00	-20.01	Pk
H	9608.00	41.99	30.85	7.45	24.69	43.28	54.00	-10.72	AV
H	12010.00	49.97	31.02	8.99	25.57	53.51	74.00	-20.49	Pk
H	12010.00	41.20	31.02	8.99	25.57	44.74	54.00	-9.26	AV

Polar (H/V)	Frequency	Meter Reading	Pre-amplifier	Cable Loss	Antenna Factor	Emission Level	Limits	Margin	Detector Type
	(MHz)	(dBuV)	(dB)	(dB)	(dB)	(dBuV/m)	(dBuV/m)	(dB)	
Middle Channel:2441MHz									
V	4882.00	55.80	30.55	5.77	24.66	55.68	74.00	-18.32	Pk
V	4882.00	44.44	30.55	5.77	24.66	44.32	54.00	-9.68	AV
V	7323.00	50.93	30.33	6.32	24.55	51.47	74.00	-22.53	Pk
V	7323.00	41.31	30.33	6.32	24.55	41.85	54.00	-12.15	AV
V	9764.00	51.28	30.85	7.45	24.69	52.57	74.00	-21.43	Pk
V	9764.00	43.02	30.85	7.45	24.69	44.31	54.00	-9.69	AV
V	12205.00	51.78	31.02	8.99	25.57	55.32	74.00	-18.68	Pk
V	12205.00	42.10	31.02	8.99	25.57	45.64	54.00	-8.36	AV
H	4882.00	53.64	30.55	5.77	24.66	53.52	74.00	-20.48	Pk
H	4882.00	42.19	30.55	5.77	24.66	42.07	54.00	-11.93	AV
H	7323.00	52.03	30.33	6.32	24.55	52.57	74.00	-21.43	Pk
H	7323.00	43.89	30.33	6.32	24.55	44.43	54.00	-9.57	AV
H	9764.00	50.56	30.85	7.45	24.69	51.85	74.00	-22.15	Pk
H	9764.00	43.17	30.85	7.45	24.69	44.46	54.00	-9.54	AV
H	12205.00	51.17	31.02	8.99	25.57	54.71	74.00	-19.29	Pk
H	12205.00	41.81	31.02	8.99	25.57	45.35	54.00	-8.65	AV



Polar (H/V)	Frequency	Meter Reading	Pre-amplifier	Cable Loss	Antenna Factor	Emission Level	Limits	Margin	Detector Type
	(MHz)	(dBuV)	(dB)	(dB)	(dB)	(dBuV/m)	(dBuV/m)	(dB)	
High Channel:2480MHz									
V	4960.00	53.95	30.55	5.77	24.66	53.83	74.00	-20.17	Pk
V	4960.00	41.93	30.55	5.77	24.66	41.81	54.00	-12.19	AV
V	7440.00	54.63	30.33	6.32	24.55	55.17	74.00	-18.83	Pk
V	7440.00	40.50	30.33	6.32	24.55	41.04	54.00	-12.96	AV
V	9920.00	49.72	30.85	7.45	24.69	51.01	74.00	-22.99	Pk
V	9920.00	43.68	30.85	7.45	24.69	44.97	54.00	-9.03	AV
V	12400.00	50.48	31.02	8.99	25.57	54.02	74.00	-19.98	Pk
V	12400.00	40.84	31.02	8.99	25.57	44.38	54.00	-9.62	AV
H	4960.00	52.22	30.55	5.77	24.66	52.10	74.00	-21.90	Pk
H	4960.00	43.31	30.55	5.77	24.66	43.19	54.00	-10.81	AV
H	7440.00	53.43	30.33	6.32	24.55	53.97	74.00	-20.03	Pk
H	7440.00	42.27	30.33	6.32	24.55	42.81	54.00	-11.19	AV
H	9920.00	50.33	30.85	7.45	24.69	51.62	74.00	-22.38	Pk
H	9920.00	40.07	30.85	7.45	24.69	41.36	54.00	-12.64	AV
H	12400.00	47.58	31.02	8.99	25.57	51.12	74.00	-22.88	Pk
H	12400.00	41.49	31.02	8.99	25.57	45.03	54.00	-8.97	AV

Remark:

1. Emission Level = Meter Reading + Antenna Factor + Cable Loss – Pre-amplifier,  
Margin= Emission Level - Limit
2. If peak below the average limit, the average emission was no test.
3. The amplitude of spurious emissions which are attenuated by more than 20dB below the permissible value has no need to be reported.



$\pi/4$ -DQPSK

Polar (H/V)	Frequency	Meter Reading	Pre-amplifier	Cable Loss	Antenna Factor	Emission Level	Limits	Margin	Detector Type
	(MHz)	(dBuV)	(dB)	(dB)	(dB)	(dBuV/m)	(dBuV/m)	(dB)	
Low Channel:2402MHz									
V	4804.00	56.10	30.55	5.77	24.66	55.98	74.00	-18.02	Pk
V	4804.00	45.09	30.55	5.77	24.66	44.97	54.00	-9.03	AV
V	7206.00	50.97	30.33	6.32	24.55	51.51	74.00	-22.49	Pk
V	7206.00	41.08	30.33	6.32	24.55	41.62	54.00	-12.38	AV
V	9608.00	51.75	30.85	7.45	24.69	53.04	74.00	-20.96	Pk
V	9608.00	43.51	30.85	7.45	24.69	44.80	54.00	-9.20	AV
V	12010.00	48.60	31.02	8.99	25.57	52.14	74.00	-21.86	Pk
V	12010.00	40.96	31.02	8.99	25.57	44.50	54.00	-9.50	AV
H	4804.00	54.71	30.55	5.77	24.66	54.59	74.00	-19.41	Pk
H	4804.00	42.01	30.55	5.77	24.66	41.89	54.00	-12.11	AV
H	7206.00	53.17	30.33	6.32	24.55	53.71	74.00	-20.29	Pk
H	7206.00	44.79	30.33	6.32	24.55	45.33	54.00	-8.67	AV
H	9608.00	50.83	30.85	7.45	24.69	52.12	74.00	-21.88	Pk
H	9608.00	43.99	30.85	7.45	24.69	45.28	54.00	-8.72	AV
H	12010.00	50.35	31.02	8.99	25.57	53.89	74.00	-20.11	Pk
H	12010.00	38.47	31.02	8.99	25.57	42.01	54.00	-11.99	AV

Polar (H/V)	Frequency	Meter Reading	Pre-amplifier	Cable Loss	Antenna Factor	Emission Level	Limits	Margin	Detector Type
	(MHz)	(dBuV)	(dB)	(dB)	(dB)	(dBuV/m)	(dBuV/m)	(dB)	
Middle Channel:2441MHz									
V	4882.00	54.94	30.55	5.77	24.66	54.82	74.00	-19.18	Pk
V	4882.00	45.20	30.55	5.77	24.66	45.08	54.00	-8.92	AV
V	7323.00	55.45	30.33	6.32	24.55	55.99	74.00	-18.01	Pk
V	7323.00	41.42	30.33	6.32	24.55	41.96	54.00	-12.04	AV
V	9764.00	51.19	30.85	7.45	24.69	52.48	74.00	-21.52	Pk
V	9764.00	43.12	30.85	7.45	24.69	44.41	54.00	-9.59	AV
V	12205.00	47.48	31.02	8.99	25.57	51.02	74.00	-22.98	Pk
V	12205.00	41.93	31.02	8.99	25.57	45.47	54.00	-8.53	AV
H	4882.00	52.18	30.55	5.77	24.66	52.06	74.00	-21.94	Pk
H	4882.00	43.36	30.55	5.77	24.66	43.24	54.00	-10.76	AV
H	7323.00	54.03	30.33	6.32	24.55	54.57	74.00	-19.43	Pk
H	7323.00	44.90	30.33	6.32	24.55	45.44	54.00	-8.56	AV
H	9764.00	54.14	30.85	7.45	24.69	55.43	74.00	-18.57	Pk
H	9764.00	44.21	30.85	7.45	24.69	45.50	54.00	-8.50	AV
H	12205.00	48.85	31.02	8.99	25.57	52.39	74.00	-21.61	Pk
H	12205.00	37.91	31.02	8.99	25.57	41.45	54.00	-12.55	AV



Polar (H/V)	Frequency	Meter Reading	Pre-amplifier	Cable Loss	Antenna Factor	Emission Level	Limits	Margin	Detector Type
	(MHz)	(dBuV)	(dB)	(dB)	(dB)	(dBuV/m)	(dBuV/m)	(dB)	
High Channel:2480MHz									
V	4960.00	55.67	30.55	5.77	24.66	55.55	74.00	-18.45	Pk
V	4960.00	41.82	30.55	5.77	24.66	41.70	54.00	-12.30	AV
V	7440.00	55.02	30.33	6.32	24.55	55.56	74.00	-18.44	Pk
V	7440.00	41.91	30.33	6.32	24.55	42.45	54.00	-11.55	AV
V	9920.00	53.25	30.85	7.45	24.69	54.54	74.00	-19.46	Pk
V	9920.00	43.59	30.85	7.45	24.69	44.88	54.00	-9.12	AV
V	12400.00	47.76	31.02	8.99	25.57	51.30	74.00	-22.70	Pk
V	12400.00	37.65	31.02	8.99	25.57	41.19	54.00	-12.81	AV
H	4960.00	51.14	30.55	5.77	24.66	51.02	74.00	-22.98	Pk
H	4960.00	44.66	30.55	5.77	24.66	44.54	54.00	-9.46	AV
H	7440.00	52.33	30.33	6.32	24.55	52.87	74.00	-21.13	Pk
H	7440.00	40.97	30.33	6.32	24.55	41.51	54.00	-12.49	AV
H	9920.00	54.21	30.85	7.45	24.69	55.50	74.00	-18.50	Pk
H	9920.00	40.53	30.85	7.45	24.69	41.82	54.00	-12.18	AV
H	12400.00	51.25	31.02	8.99	25.57	54.79	74.00	-19.21	Pk
H	12400.00	40.40	31.02	8.99	25.57	43.94	54.00	-10.06	AV

Remark:

1. Emission Level = Meter Reading + Antenna Factor + Cable Loss – Pre-amplifier,  
Margin= Emission Level - Limit
2. If peak below the average limit, the average emission was no test.
3. The amplitude of spurious emissions which are attenuated by more than 20dB below the permissible value has no need to be reported.





8-DPSK

Polar (H/V)	Frequency	Meter Reading	Pre-amplifier	Cable Loss	Antenna Factor	Emission Level	Limits	Margin	Detector Type
	(MHz)	(dBuV)	(dB)	(dB)	(dB)	(dBuV/m)	(dBuV/m)	(dB)	
Low Channel:2402MHz									
V	4804.00	51.95	30.55	5.77	24.66	51.83	74.00	-22.17	Pk
V	4804.00	44.11	30.55	5.77	24.66	43.99	54.00	-10.01	AV
V	7206.00	55.37	30.33	6.32	24.55	55.91	74.00	-18.09	Pk
V	7206.00	41.47	30.33	6.32	24.55	42.01	54.00	-11.99	AV
V	9608.00	52.25	30.85	7.45	24.69	53.54	74.00	-20.46	Pk
V	9608.00	43.43	30.85	7.45	24.69	44.72	54.00	-9.28	AV
V	12010.00	50.38	31.02	8.99	25.57	53.92	74.00	-20.08	Pk
V	12010.00	38.32	31.02	8.99	25.57	41.86	54.00	-12.14	AV
H	4804.00	51.60	30.55	5.77	24.66	51.48	74.00	-22.52	Pk
H	4804.00	45.98	30.55	5.77	24.66	45.86	54.00	-8.14	AV
H	7206.00	52.67	30.33	6.32	24.55	53.21	74.00	-20.79	Pk
H	7206.00	41.18	30.33	6.32	24.55	41.72	54.00	-12.28	AV
H	9608.00	50.03	30.85	7.45	24.69	51.32	74.00	-22.68	Pk
H	9608.00	44.10	30.85	7.45	24.69	45.39	54.00	-8.61	AV
H	12010.00	48.99	31.02	8.99	25.57	52.53	74.00	-21.47	Pk
H	12010.00	38.14	31.02	8.99	25.57	41.68	54.00	-12.32	AV

Polar (H/V)	Frequency	Meter Reading	Pre-amplifier	Cable Loss	Antenna Factor	Emission Level	Limits	Margin	Detector Type
	(MHz)	(dBuV)	(dB)	(dB)	(dB)	(dBuV/m)	(dBuV/m)	(dB)	
Middle Channel:2441MHz									
V	4882.00	55.90	30.55	5.77	24.66	55.78	74.00	-18.22	Pk
V	4882.00	42.83	30.55	5.77	24.66	42.71	54.00	-11.29	AV
V	7323.00	52.60	30.33	6.32	24.55	53.14	74.00	-20.86	Pk
V	7323.00	41.38	30.33	6.32	24.55	41.92	54.00	-12.08	AV
V	9764.00	54.57	30.85	7.45	24.69	55.86	74.00	-18.14	Pk
V	9764.00	41.73	30.85	7.45	24.69	43.02	54.00	-10.98	AV
V	12205.00	50.35	31.02	8.99	25.57	53.89	74.00	-20.11	Pk
V	12205.00	41.16	31.02	8.99	25.57	44.70	54.00	-9.30	AV
H	4882.00	55.04	30.55	5.77	24.66	54.92	74.00	-19.08	Pk
H	4882.00	42.61	30.55	5.77	24.66	42.49	54.00	-11.51	AV
H	7323.00	54.56	30.33	6.32	24.55	55.10	74.00	-18.90	Pk
H	7323.00	44.72	30.33	6.32	24.55	45.26	54.00	-8.74	AV
H	9764.00	51.78	30.85	7.45	24.69	53.07	74.00	-20.93	Pk
H	9764.00	40.22	30.85	7.45	24.69	41.51	54.00	-12.49	AV
H	12205.00	48.16	31.02	8.99	25.57	51.70	74.00	-22.30	Pk
H	12205.00	39.85	31.02	8.99	25.57	43.39	54.00	-10.61	AV



Polar (H/V)	Frequency	Meter Reading	Pre-amplifier	Cable Loss	Antenna Factor	Emission Level	Limits	Margin	Detector Type
	(MHz)	(dBuV)	(dB)	(dB)	(dB)	(dBuV/m)	(dBuV/m)	(dB)	
High Channel:2480MHz									
V	4960.00	52.82	30.55	5.77	24.66	52.70	74.00	-21.30	Pk
V	4960.00	43.46	30.55	5.77	24.66	43.34	54.00	-10.66	AV
V	7440.00	53.11	30.33	6.32	24.55	53.65	74.00	-20.35	Pk
V	7440.00	42.68	30.33	6.32	24.55	43.22	54.00	-10.78	AV
V	9920.00	51.23	30.85	7.45	24.69	52.52	74.00	-21.48	Pk
V	9920.00	44.20	30.85	7.45	24.69	45.49	54.00	-8.51	AV
V	12400.00	51.43	31.02	8.99	25.57	54.97	74.00	-19.03	Pk
V	12400.00	40.57	31.02	8.99	25.57	44.11	54.00	-9.89	AV
H	4960.00	54.40	30.55	5.77	24.66	54.28	74.00	-19.72	Pk
H	4960.00	43.70	30.55	5.77	24.66	43.58	54.00	-10.42	AV
H	7440.00	50.87	30.33	6.32	24.55	51.41	74.00	-22.59	Pk
H	7440.00	42.35	30.33	6.32	24.55	42.89	54.00	-11.11	AV
H	9920.00	52.78	30.85	7.45	24.69	54.07	74.00	-19.93	Pk
H	9920.00	43.63	30.85	7.45	24.69	44.92	54.00	-9.08	AV
H	12400.00	47.80	31.02	8.99	25.57	51.34	74.00	-22.66	Pk
H	12400.00	38.67	31.02	8.99	25.57	42.21	54.00	-11.79	AV

Remark:

1. Emission Level = Meter Reading + Antenna Factor + Cable Loss – Pre-amplifier,  
Margin= Emission Level - Limit
2. If peak below the average limit, the average emission was no test.
3. The amplitude of spurious emissions which are attenuated by more than 20dB below the permissible value has no need to be reported.



## 5. RADIATED BAND EMISSION MEASUREMENT

### 5.1 Test Requirement:

Test Requirement:	FCC Part15 C Section 15.209 and 15.205				
Test Method:	ANSI C63.10: 2013				
Test Frequency Range:	All of the restrict bands were tested, only the worst band's (2310MHz to 2500MHz) data was showed.				
Test site:	Measurement Distance: 3m				
Receiver setup:	Frequency	Detector	RBW	VBW	Value
	Above 1GHz	Peak	1MHz	3MHz	Peak
		Average	1MHz	3MHz	Average

### LIMITS OF RADIATED EMISSION MEASUREMENT (Above 1000MHz)

FREQUENCY (MHz)	Limit (dBuV/m) (at 3M)	
	PEAK	AVERAGE
Above 1000	74	54

#### Notes:

- (1) The limit for radiated test was performed according to FCC PART 15C.
- (2) The tighter limit applies at the band edges.
- (3) Emission level (dBuV/m)=20log Emission level (uV/m).

Spectrum Parameter	Setting
Attenuation	Auto
Start Frequency	2300MHz
Stop Frequency	2520
RB / VB (emission in restricted band)	1 MHz / 1 MHz for Peak, 1 MHz / 10Hz for Average

### 5.2 TEST PROCEDURE

Above 1GHz test procedure as below:

- a. 1. The EUT was placed on the top of a rotating table 1.5 meters above the ground at a 3 meter camber. The table was rotated 360 degrees to determine the position of the highest radiation.
- b. The EUT was set 3 meters away from the interference-receiving antenna, which was mounted on the top of a variable-height antenna tower.
- c. The antenna height is varied from one meter to four meters above the ground to determine the maximum value of the field strength. Both horizontal and vertical polarizations of the antenna are set to make the measurement.
- d. For each suspected emission, the EUT was arranged to its worst case and then the antenna was tuned to heights from 1 meter to 4 meters and the rota table was turned from 0 degrees to 360 degrees to find the maximum reading.
- e. The test-receiver system was set to Peak Detect Function and Specified Bandwidth with Maximum Hold Mode.
- f. If the emission level of the EUT in peak mode was 10dB lower than the limit specified, then testing could be stopped and the peak values of the EUT would be reported. Otherwise the emissions that did not have 10dB margin would be re-tested one by one using peak, quasi-peak or average method as specified and then reported in a data sheet.
- g. Test the EUT in the lowest channel,the Highest channel

#### Note:

Both horizontal and vertical antenna polarities were tested and performed pretest to three orthogonal axis. The worst case emissions were reported



### 5.3 DEVIATION FROM TEST STANDARD

No deviation

### 5.4 TEST SETUP

Radiated Emission Test-Up Frequency Above 1GHz

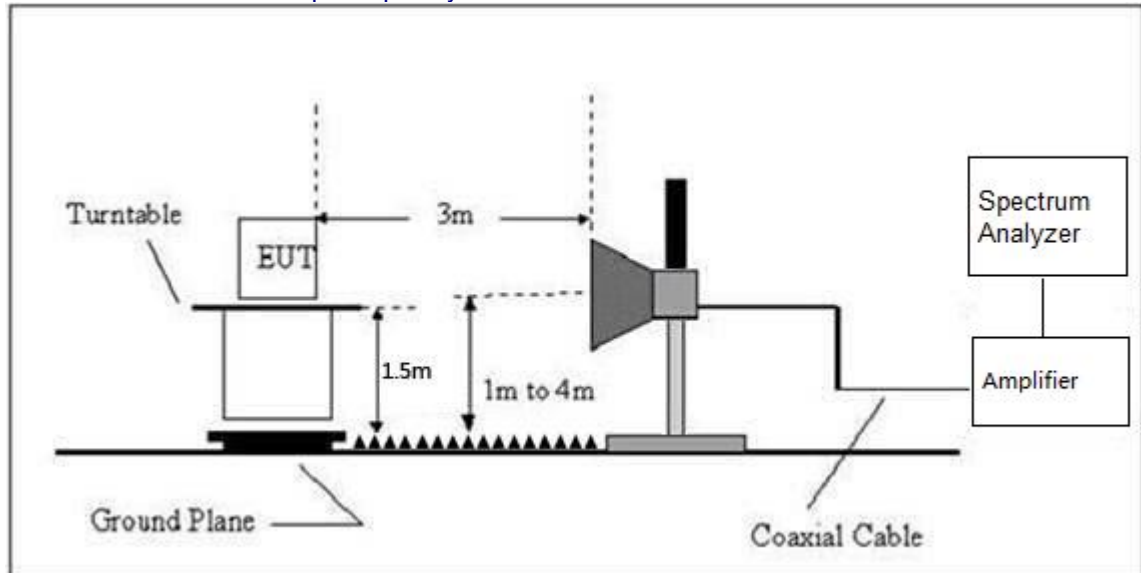

### 5.5 EUT OPERATING CONDITIONS

The EUT tested system was configured as the statements of 2.3 Unless otherwise a special operating condition is specified in the follows during the testing.



5.6 TEST RESULT

	Polar (H/V)	Frequency (MHz)	Meter Reading (dBuV)	Pre-amplifier (dB)	Cable Loss (dB)	Antenna Factor (dB/m)	Emission level (dBuV/m)	Limit (dBuV/m)	Margin (dB)	Detector Type	Result
GFSK	Low Channel: 2402MHz										
	H	2390.00	54.96	30.22	4.85	23.98	53.57	74.00	-20.43	PK	PASS
	H	2390.00	46.18	30.22	4.85	23.98	44.79	54.00	-9.21	AV	PASS
	V	2390.00	56.55	30.22	4.85	23.98	55.16	74.00	-18.84	PK	PASS
	V	2390.00	45.71	30.22	4.85	23.98	44.32	54.00	-9.68	AV	PASS
	High Channel: 2480MHz										
	H	2483.50	56.54	30.22	4.85	23.98	55.15	74.00	-18.85	PK	PASS
	H	2483.50	46.44	30.22	4.85	23.98	45.05	54.00	-8.95	AV	PASS
	H	2500.00	52.78	30.22	4.85	23.98	51.39	74.00	-22.61	PK	PASS
	H	2500.00	47.34	30.22	4.85	23.98	45.95	54.00	-8.05	AV	PASS
	V	2483.50	53.25	30.22	4.85	23.98	51.86	74.00	-22.14	PK	PASS
	V	2483.50	46.57	30.22	4.85	23.98	45.18	54.00	-8.82	AV	PASS
	V	2500.00	56.95	30.22	4.85	23.98	55.56	74.00	-18.44	PK	PASS
	V	2500.00	46.14	30.22	4.85	23.98	44.75	54.00	-9.25	AV	PASS
π/4-DQPSK	Low Channel: 2402MHz										
	H	2390.00	53.88	30.22	4.85	23.98	52.49	74.00	-21.51	PK	PASS
	H	2390.00	46.49	30.22	4.85	23.98	45.10	54.00	-8.90	AV	PASS
	V	2390.00	54.88	30.22	4.85	23.98	53.49	74.00	-20.51	PK	PASS
	V	2390.00	43.89	30.22	4.85	23.98	42.50	54.00	-11.50	AV	PASS
	High Channel: 2480MHz										
	H	2483.50	53.12	30.22	4.85	23.98	51.73	74.00	-22.27	PK	PASS
	H	2483.50	45.68	30.22	4.85	23.98	44.29	54.00	-9.71	AV	PASS
	H	2500.00	52.63	30.22	4.85	23.98	51.24	74.00	-22.76	PK	PASS
	H	2500.00	43.40	30.22	4.85	23.98	42.01	54.00	-11.99	AV	PASS
	V	2483.50	53.89	30.22	4.85	23.98	52.50	74.00	-21.50	PK	PASS
	V	2483.50	45.41	30.22	4.85	23.98	44.02	54.00	-9.98	AV	PASS
	V	2500.00	55.93	30.22	4.85	23.98	54.54	74.00	-19.46	PK	PASS
	V	2500.00	46.36	30.22	4.85	23.98	44.97	54.00	-9.03	AV	PASS
8-DPSK	Low Channel: 2402MHz										
	H	2390.00	57.09	30.22	4.85	23.98	55.70	74.00	-18.30	PK	PASS
	H	2390.00	47.03	30.22	4.85	23.98	45.64	54.00	-8.36	AV	PASS
	V	2390.00	54.94	30.22	4.85	23.98	53.55	74.00	-20.45	PK	PASS
	V	2390.00	46.04	30.22	4.85	23.98	44.65	54.00	-9.35	AV	PASS
	High Channel: 2480MHz										
	H	2483.50	56.21	30.22	4.85	23.98	54.82	74.00	-19.18	PK	PASS
	H	2483.50	47.18	30.22	4.85	23.98	45.79	54.00	-8.21	AV	PASS
	H	2500.00	56.76	30.22	4.85	23.98	55.37	74.00	-18.63	PK	PASS
	H	2500.00	45.36	30.22	4.85	23.98	43.97	54.00	-10.03	AV	PASS
	V	2483.50	57.08	30.22	4.85	23.98	55.69	74.00	-18.31	PK	PASS
	V	2483.50	46.05	30.22	4.85	23.98	44.66	54.00	-9.34	AV	PASS
	V	2500.00	55.96	30.22	4.85	23.98	54.57	74.00	-19.43	PK	PASS
	V	2500.00	43.25	30.22	4.85	23.98	41.86	54.00	-12.14	AV	PASS
<b>Remark:</b>											
1. Emission Level = Meter Reading + Antenna Factor + Cable Loss – Pre-amplifier, Margin= Emission Level - Limit											



## 6. CONDUCTED BAND EDGE AND SPURIOUS EMISSION

Test Requirement:	FCC Part15 C Section 15.247 (d)
Test Method:	KDB558074 D0115.247 Meas Guidancev05r02

### 6.1 Limit

Regulation 15.247 (d), In any 100 kHz bandwidth outside the frequency band in which the spread spectrum or digitally modulated intentional radiator is operating, the radio frequency power that is produced by the intentional radiator shall be at least 20 dB below that in the 100 kHz bandwidth within the band that contains the highest level of the desired power, based on either an RF conducted or a radiated measurement, provided the transmitter demonstrates compliance with the peak conducted power limits. If the transmitter complies with the conducted power limits based on the use of RMS averaging over a time interval, as permitted under paragraph (b)(3) of this section, the attenuation required under this paragraph shall be 30 dB instead of 20 dB. Attenuation below the general limits specified in §15.209(a) is not required. In addition, radiated emissions which fall in the restricted bands, as defined in §15.205(a), must also comply with the radiated emission limits specified in §15.209(a) (see §15.205(c)).

### 6.2 Test Setup

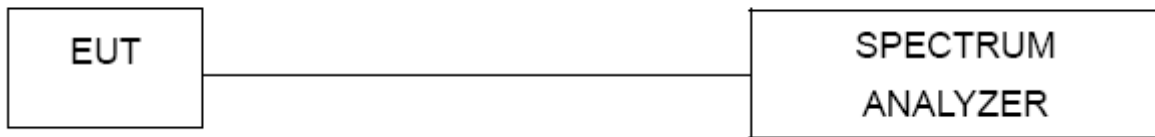

### 6.3 Test procedure

Using the following spectrum analyzer setting:

- A) Set the RBW = 100KHz.
- B) Set the VBW = 300KHz.
- C) Sweep time = auto couple.
- D) Detector function = peak.
- E) Trace mode = max hold.
- F) Allow trace to fully stabilize.

### 6.4 DEVIATION FROM STANDARD

No deviation.



### 6.5 CSE Test Result

GFSK mode:

Test channel:



Lowest channel

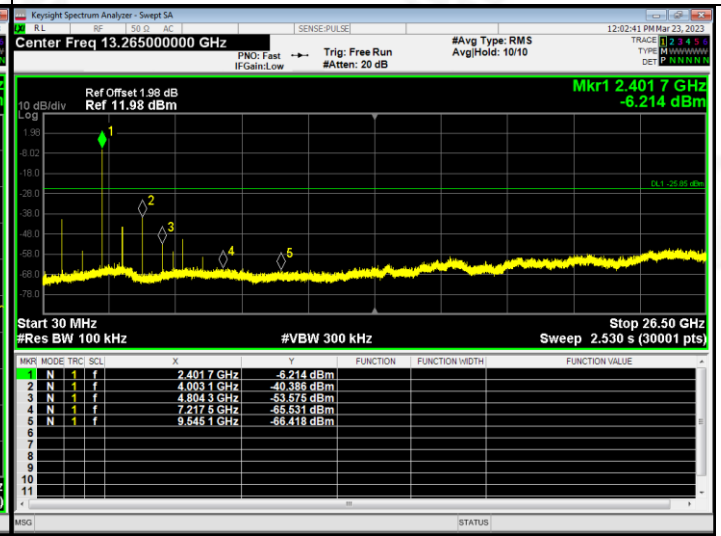

30MHz~26.5GHz

Test channel:



Middle channel

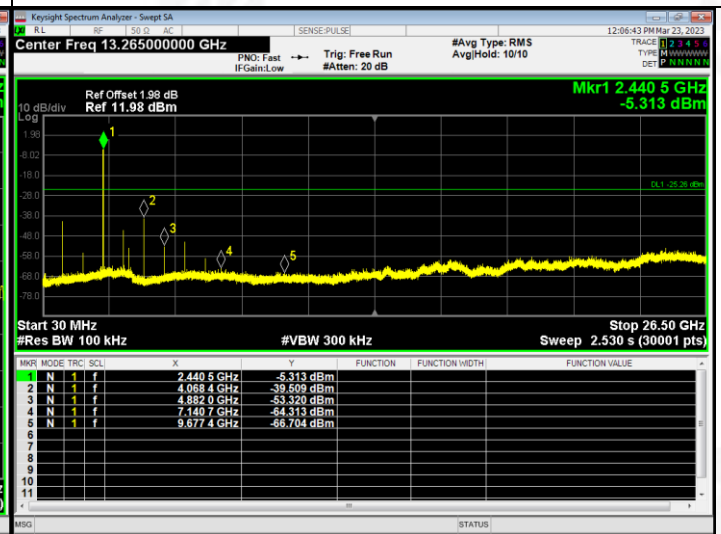

30MHz~26.5GHz



Test channel:

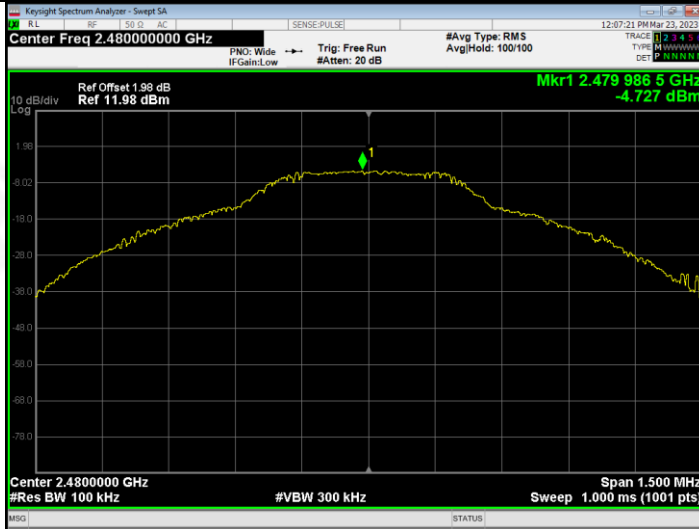

Highest channel

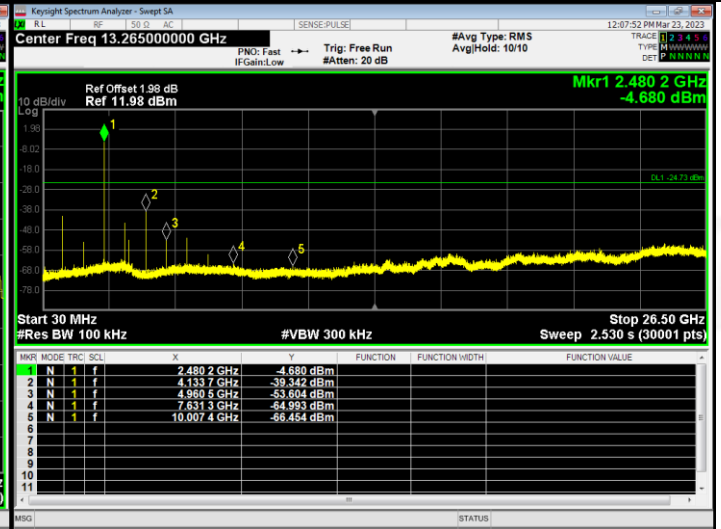

30MHz~26.5GHz





$\pi/4$ -DQPSK mode:

Test channel:

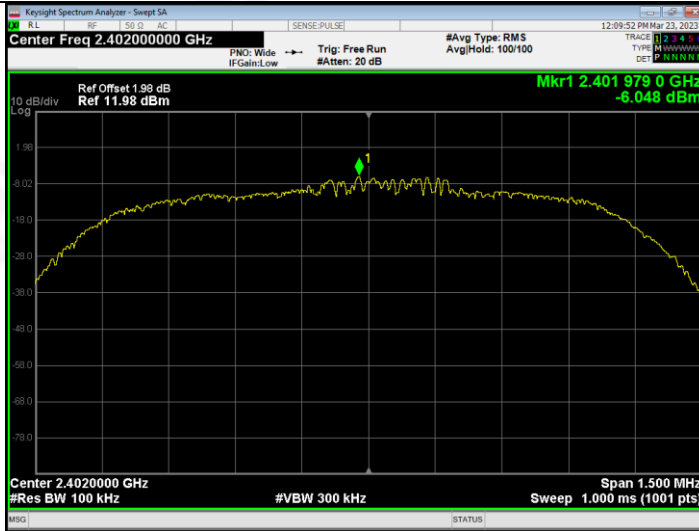

Lowest channel

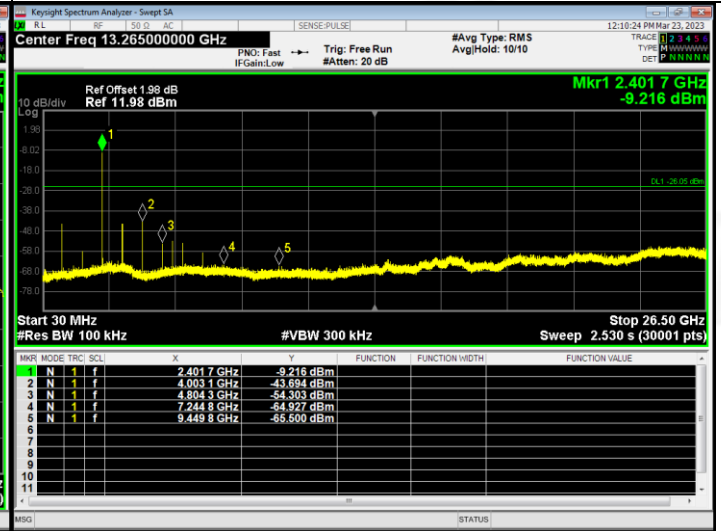

30MHz~26.5GHz

Test channel:

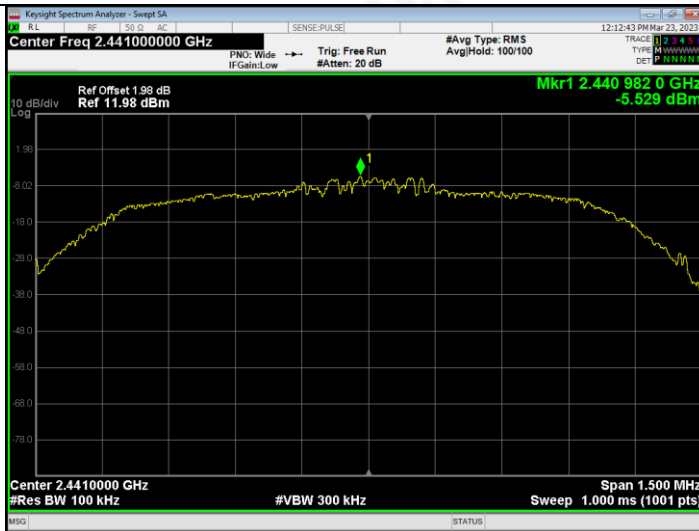

Middle channel

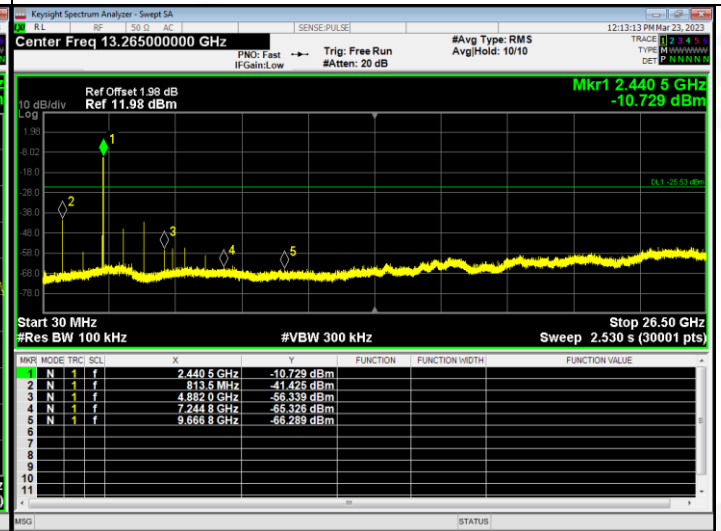

30MHz~26.5GHz



Test channel:

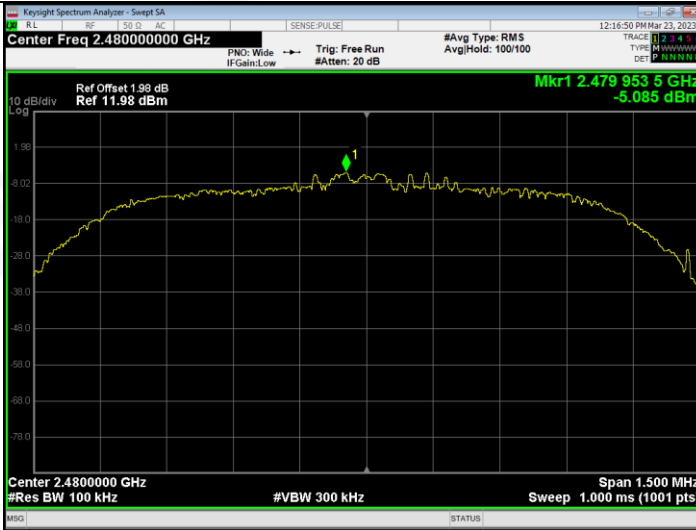

Highest channel

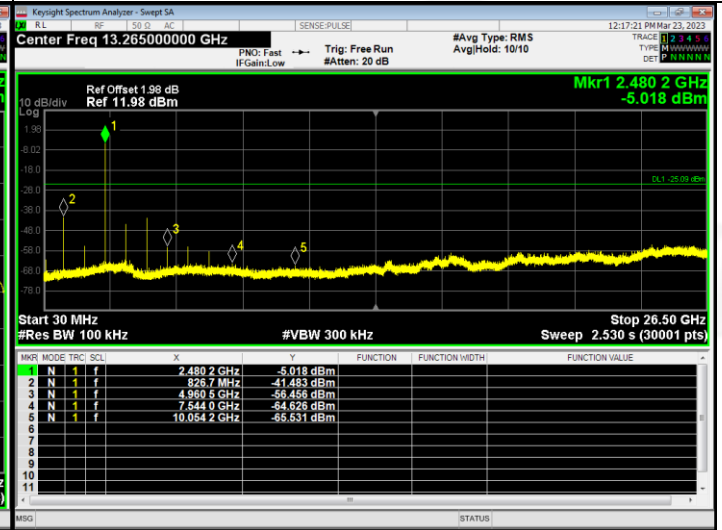

30MHz~26.5GHz

8-DPSK mode:

Test channel:

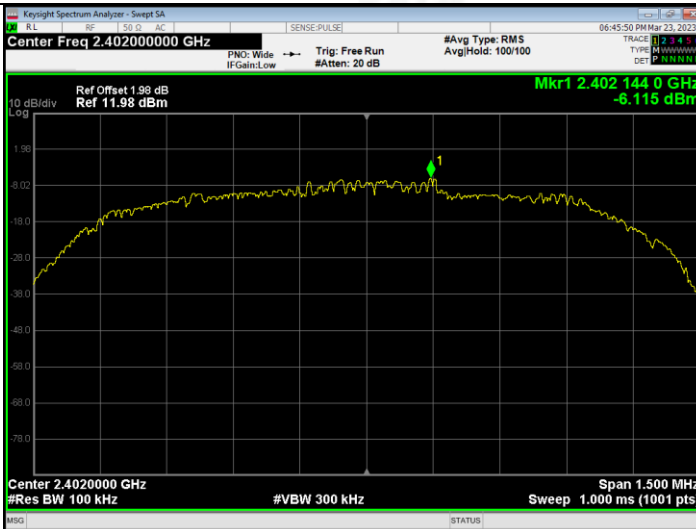

Lowest channel

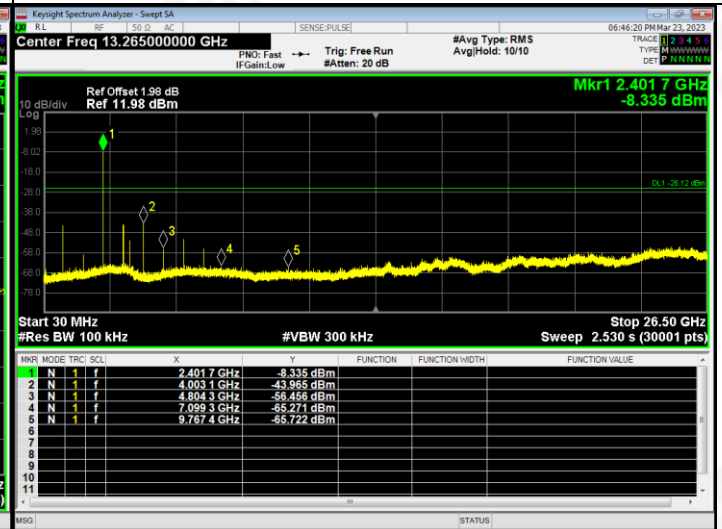

30MHz~26.5GHz



Test channel:

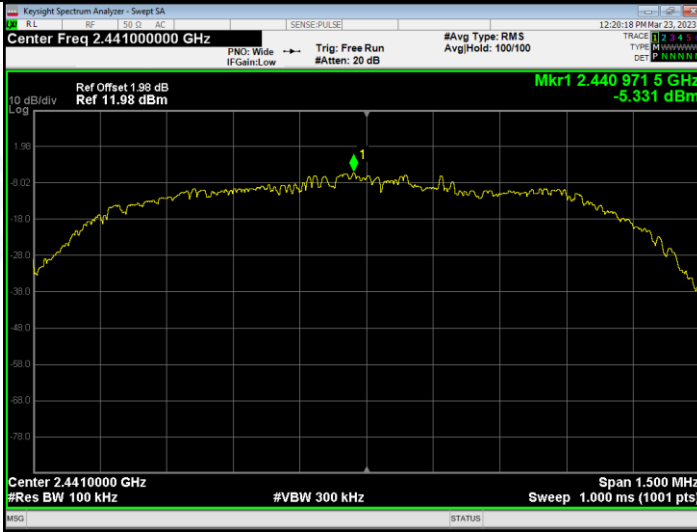

Middle channel

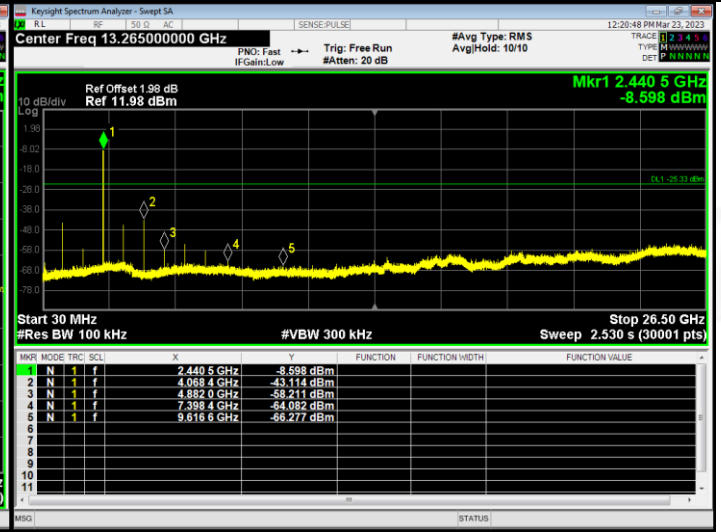

30MHz~26.5GHz

Test channel:

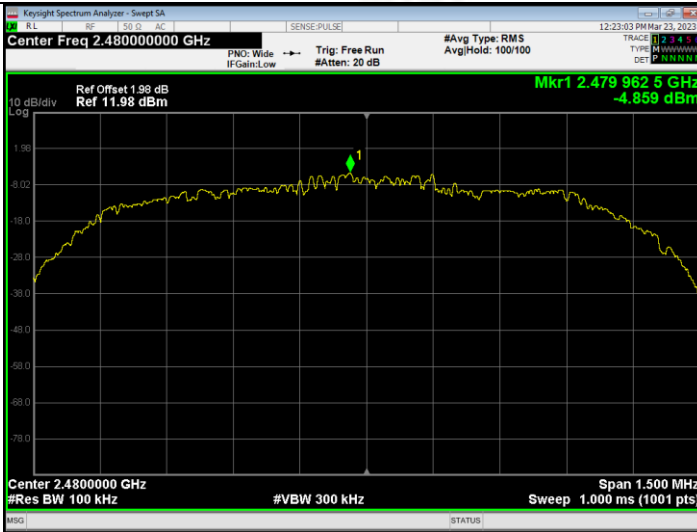

Highest channel

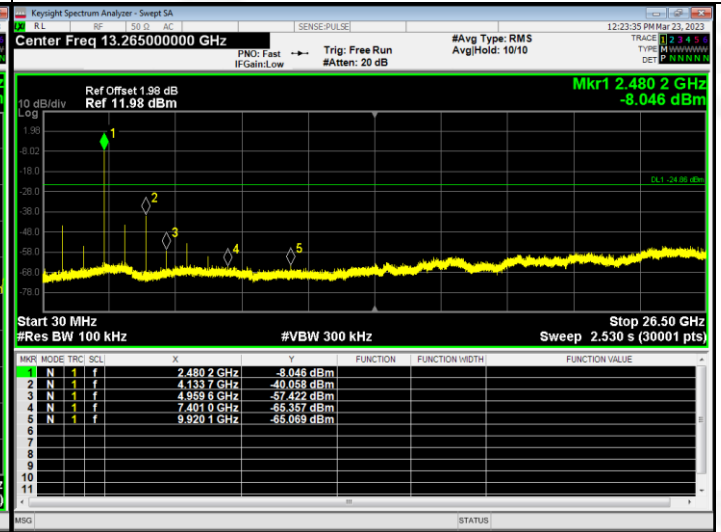

30MHz~26.5GHz



### GFSK No-hopping Band edge-left side

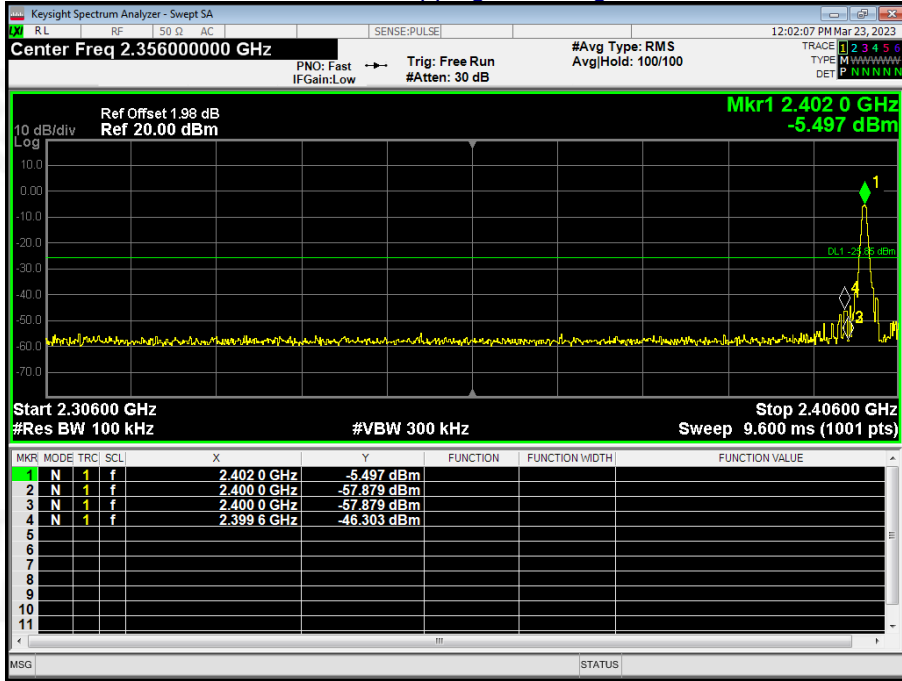

### GFSK Hopping Band edge-left side

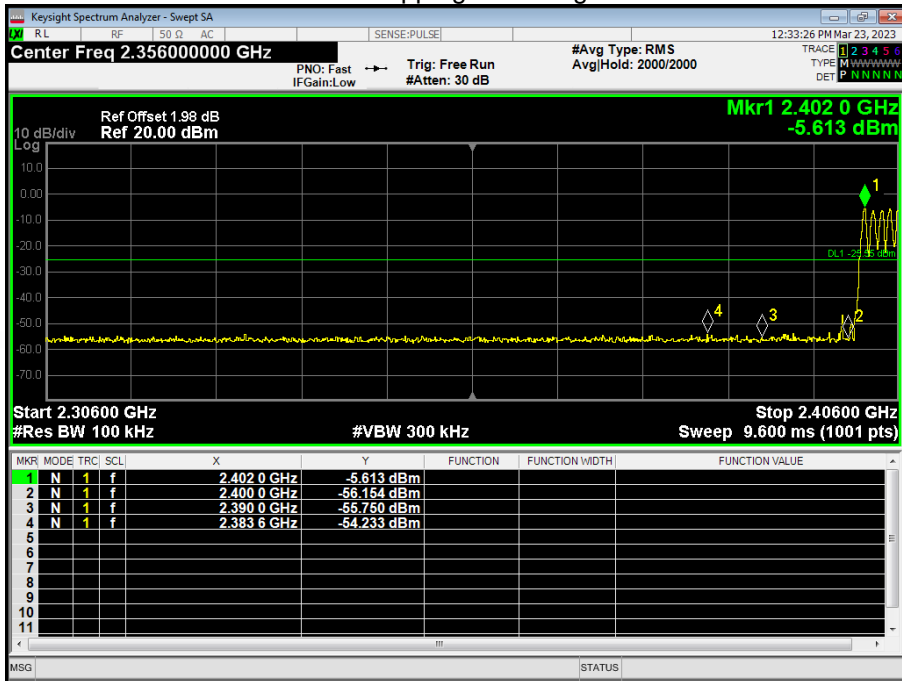



### GFSK No-hopping Band edge-right side

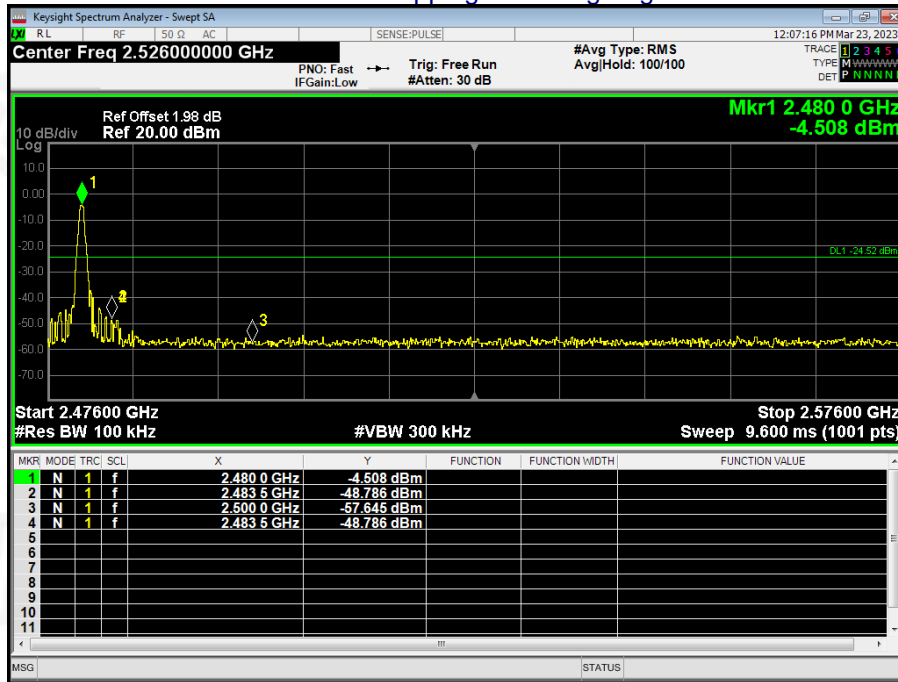

### GFSK Hopping Band edge-right side

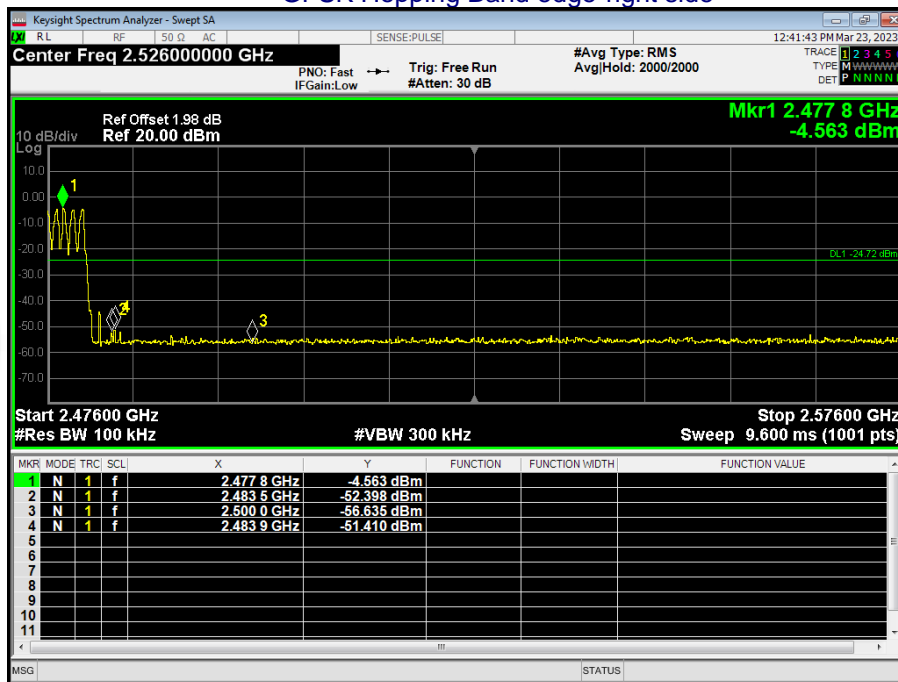



$\pi/4$ -DQPSK No-hopping Band edge-left side

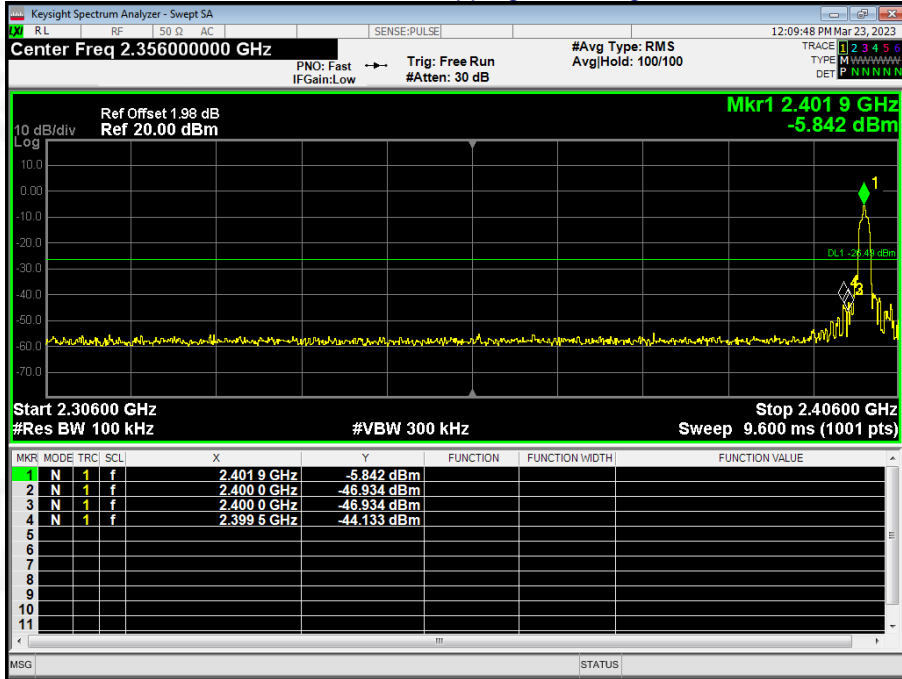

$\pi/4$ -DQPSK Hopping Band edge-left side

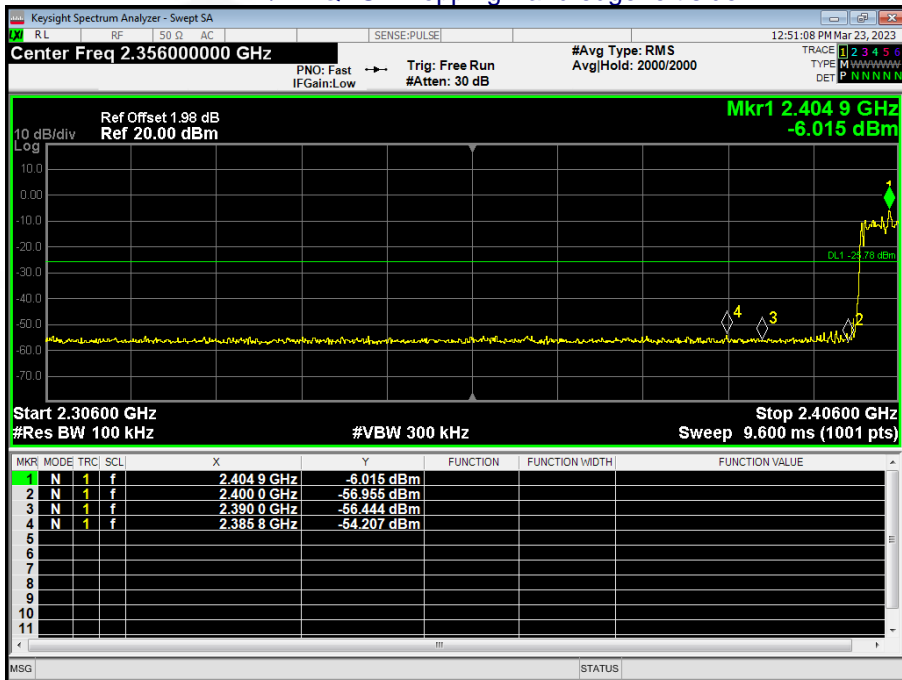



$\pi/4$ -DQPSK No-hopping Band edge-right side

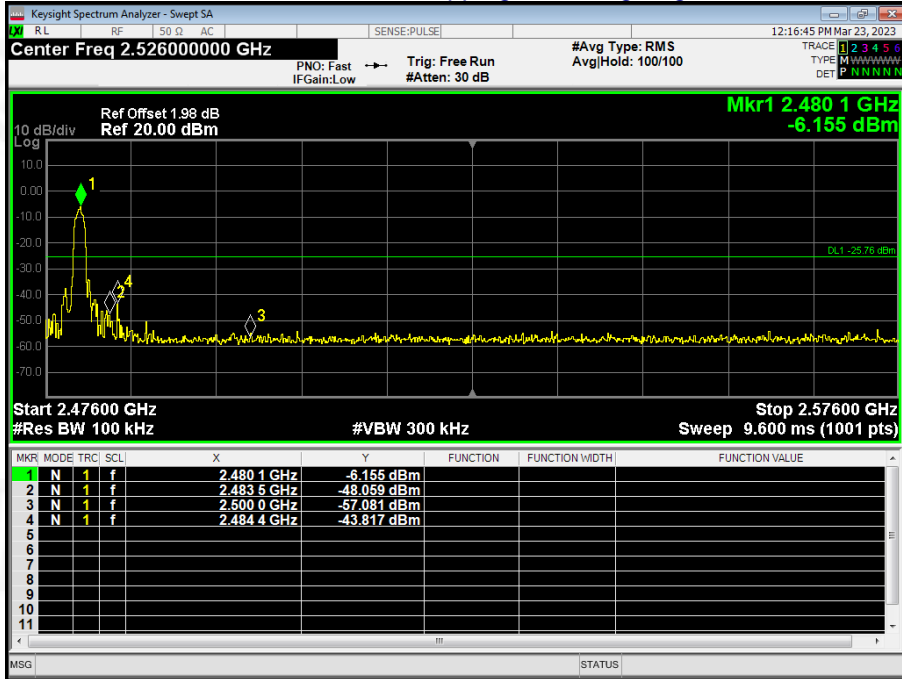

$\pi/4$ -DQPSK Hopping Band edge-right side

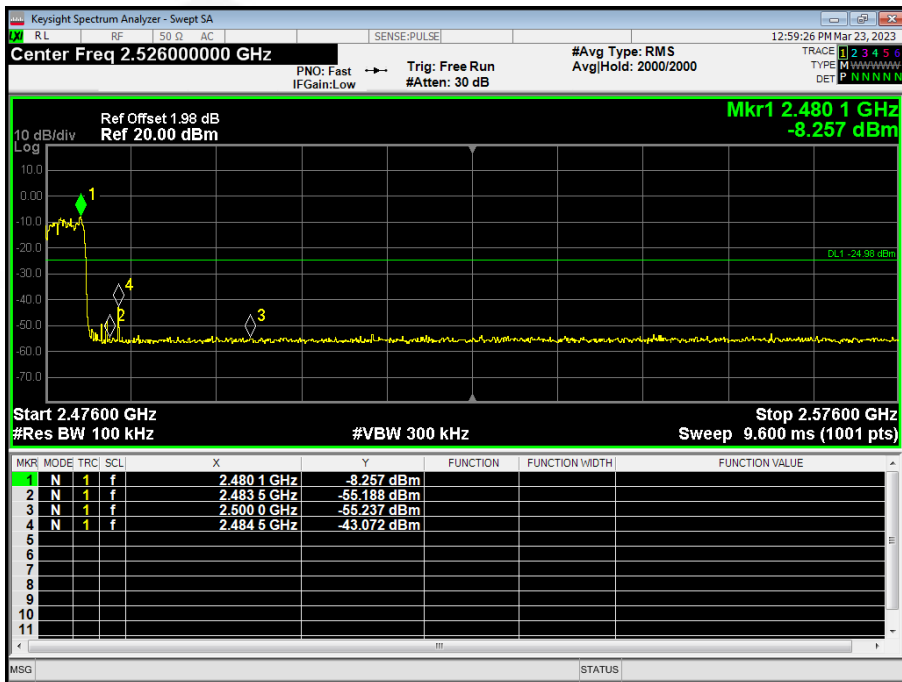



### 8-DPSK No-hopping Band edge-left side

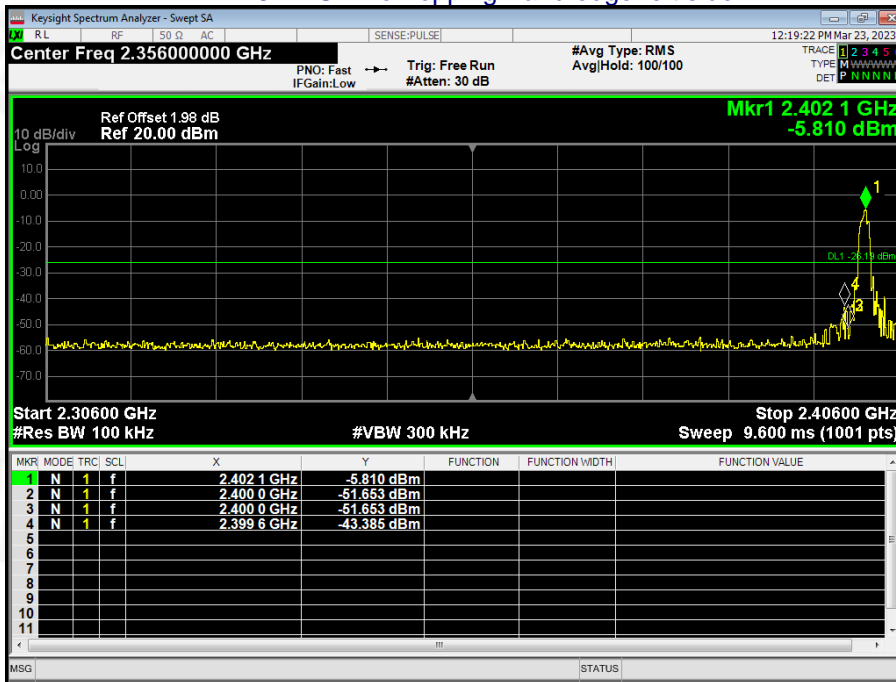

### 8-DPSK Hopping Band edge-left side

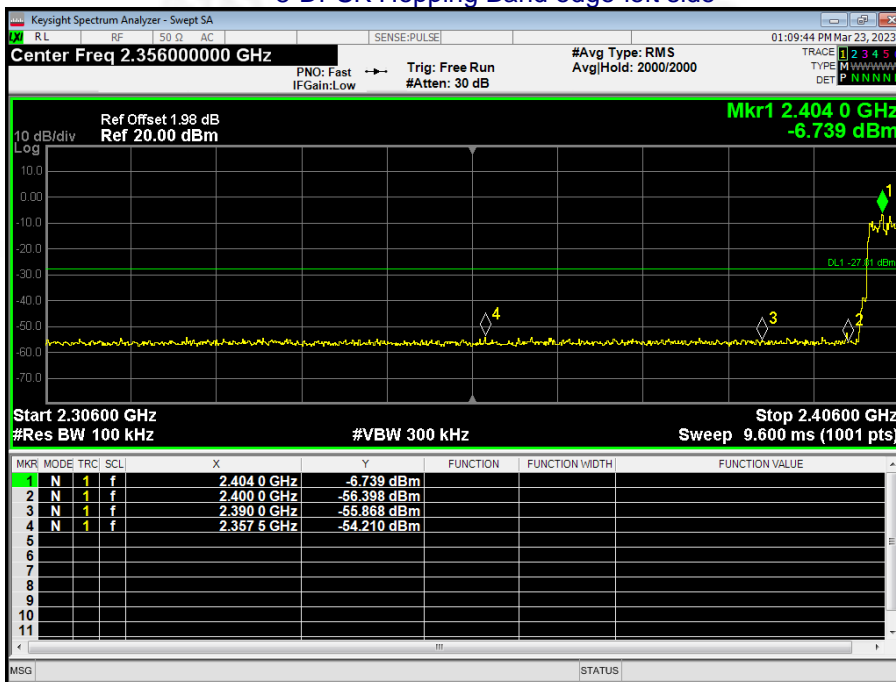





### 8-DPSK No-hopping Band edge-right side

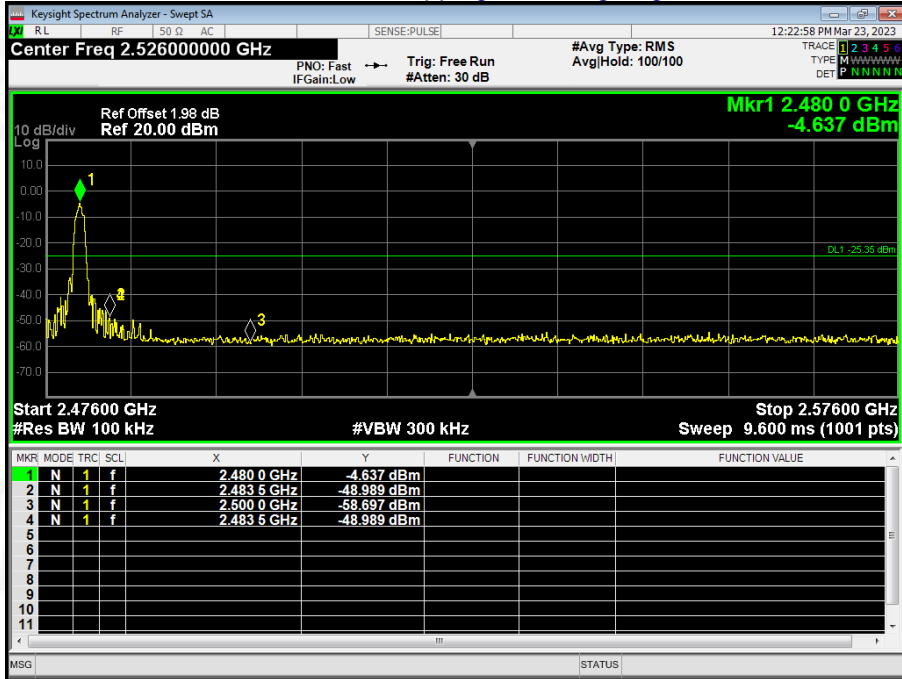

### 8-DPSK Hopping Band edge-right side

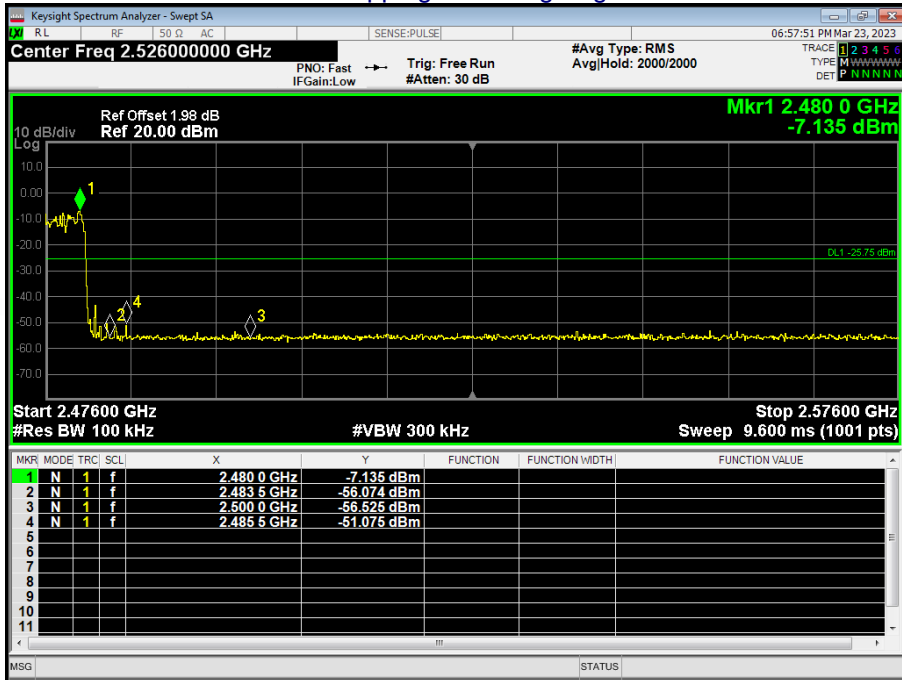



### 7. 20DB&99% BANDWIDTH

Test Requirement:	FCC Part15 C Section 15.247 (a)(1)
Test Method:	ANSI C63.10:2013

#### 7.1 Test Setup



#### 7.2 Limit

N/A

#### 7.3 Test procedure

1. Set RBW = 30 kHz.
2. Set the video bandwidth (VBW)  $\geq 3 \times$  RBW.
3. Detector = Peak.
4. Trace mode = max hold.
5. Sweep = auto couple.
6. Allow the trace to stabilize.
7. Measure the maximum width of the emission that is constrained by the frequencies associated with the two outermost amplitude points (upper and lower frequencies) that are attenuated by 6 dB relative to the maximum level measured in the fundamental emission.

#### 7.4 DEVIATION FROM STANDARD

No deviation.

#### 7.5 BW Test Result

Mode	Test channel	-20dB Emission Bandwidth (MHz)	99%Bandwidth (MHz)	Result
GFSK	Lowest	0.9530	0.89083	Pass
	Middle	0.9572	0.89318	
	Highest	0.9546	0.89262	
$\pi/4$ -DQPSK	Lowest	1.311	1.1738	Pass
	Middle	1.319	1.1764	
	Highest	1.305	1.1736	
8-DPSK	Lowest	1.296	1.1852	Pass
	Middle	1.298	1.1941	
	Highest	1.302	1.1916	



### Test plots

#### GFSK Low Channel

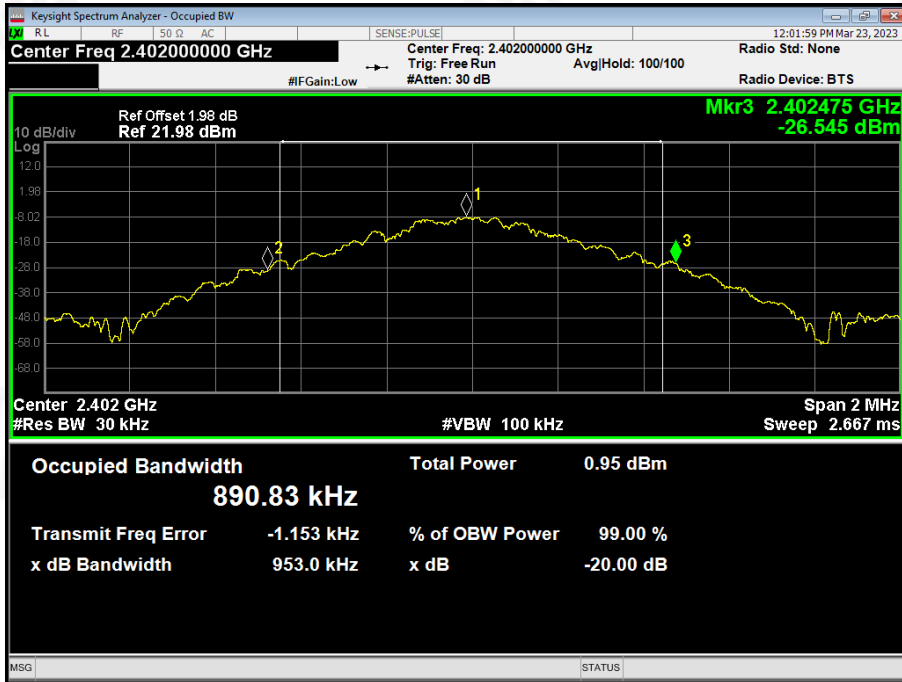



### GFSK Middle Channel



### GFSK High Channel

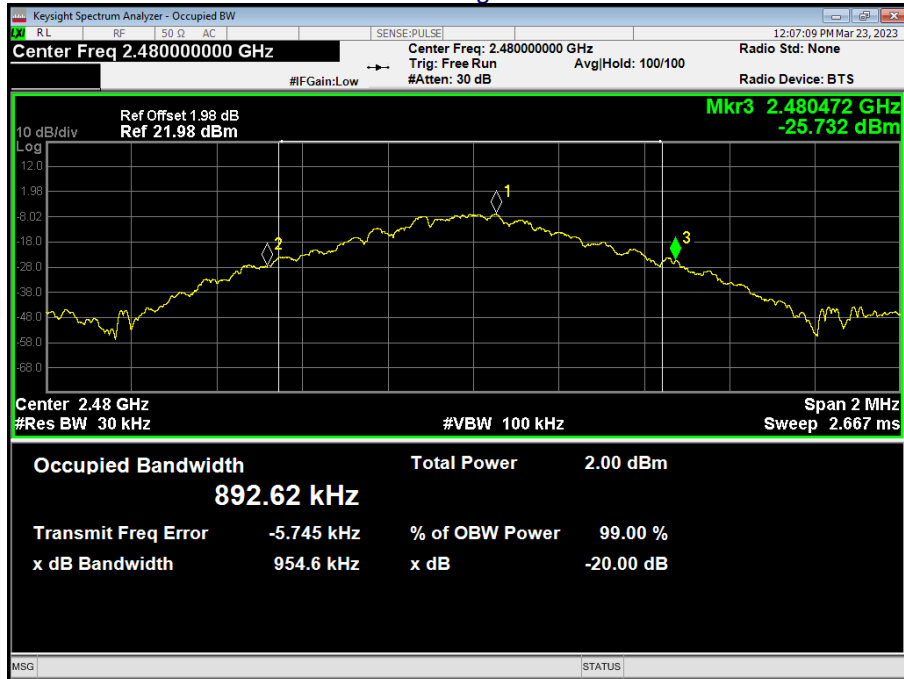



### $\pi/4$ -DQPSK Low Channel

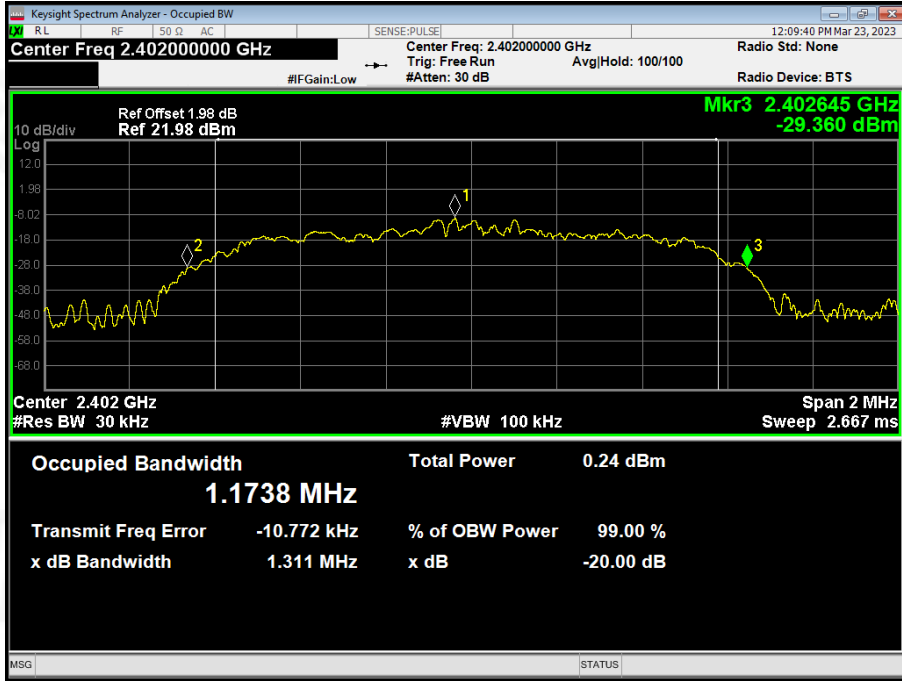

### $\pi/4$ -DQPSK Middle Channel

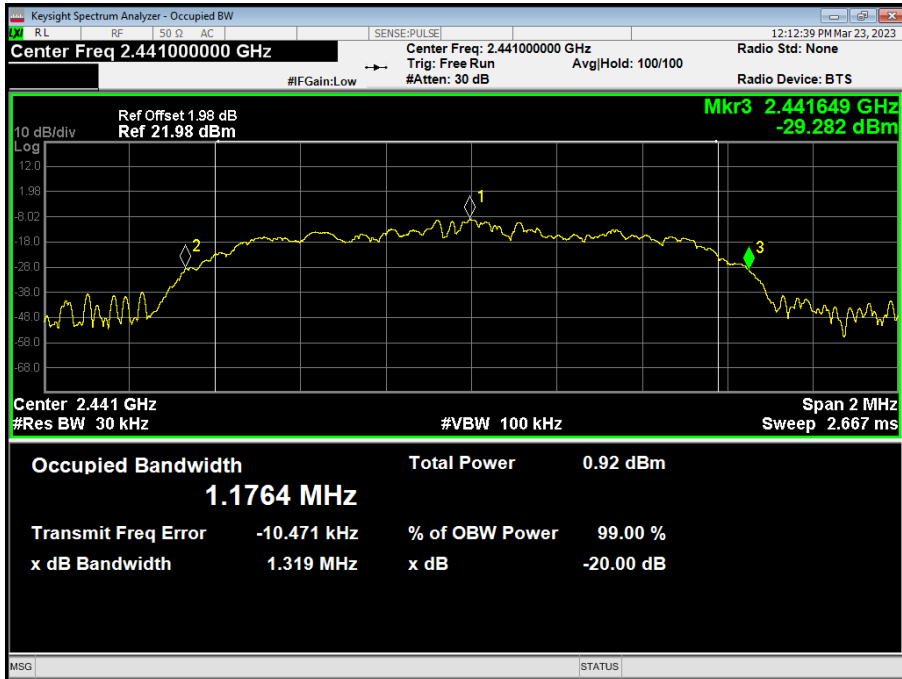



### $\pi/4$ -DQPSK High Channel

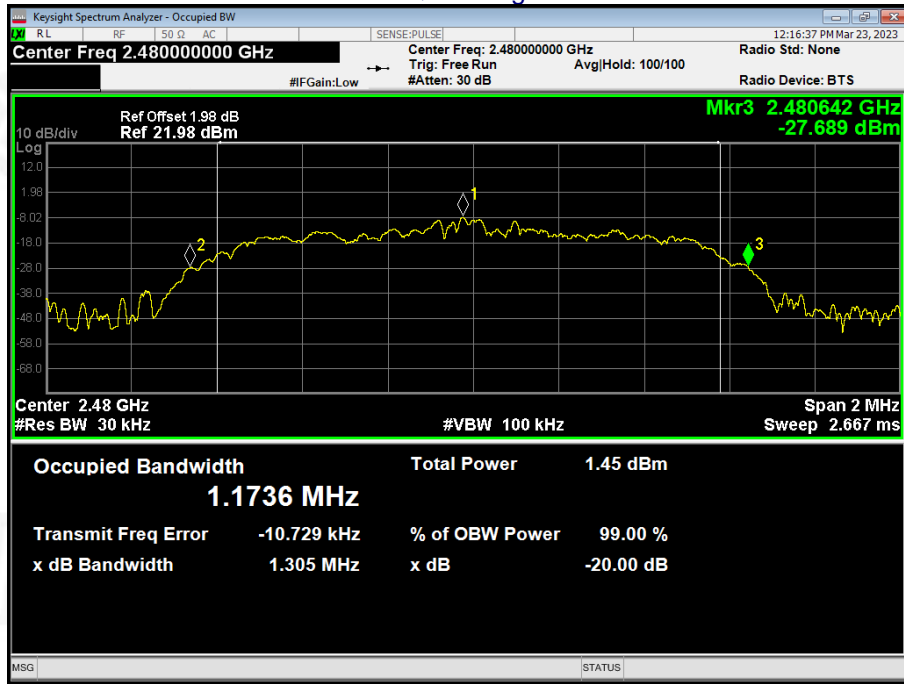



### 8-DPSK Low Channel

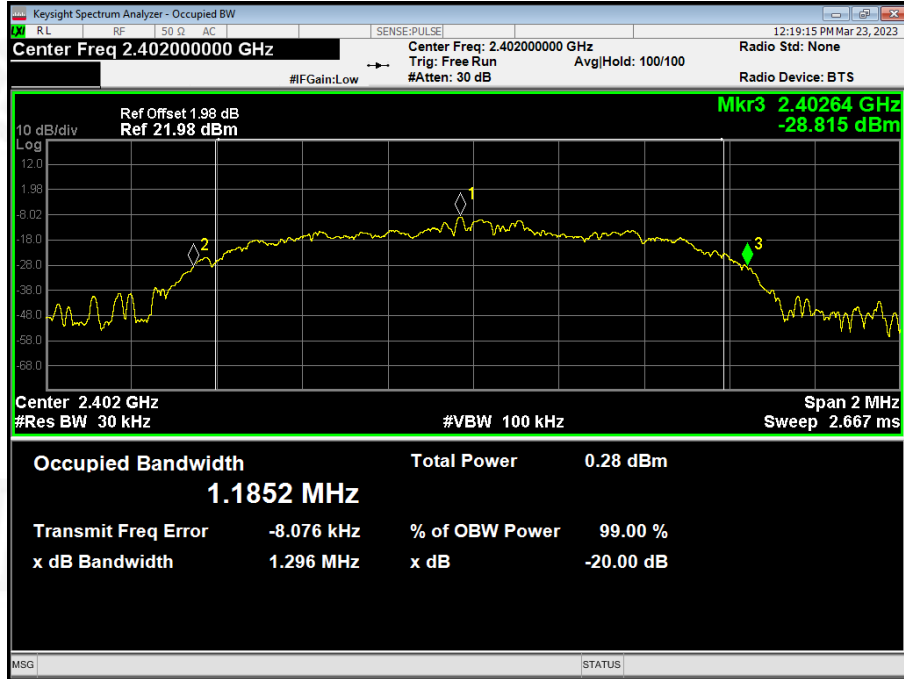



### 8-DPSK Middle Channel

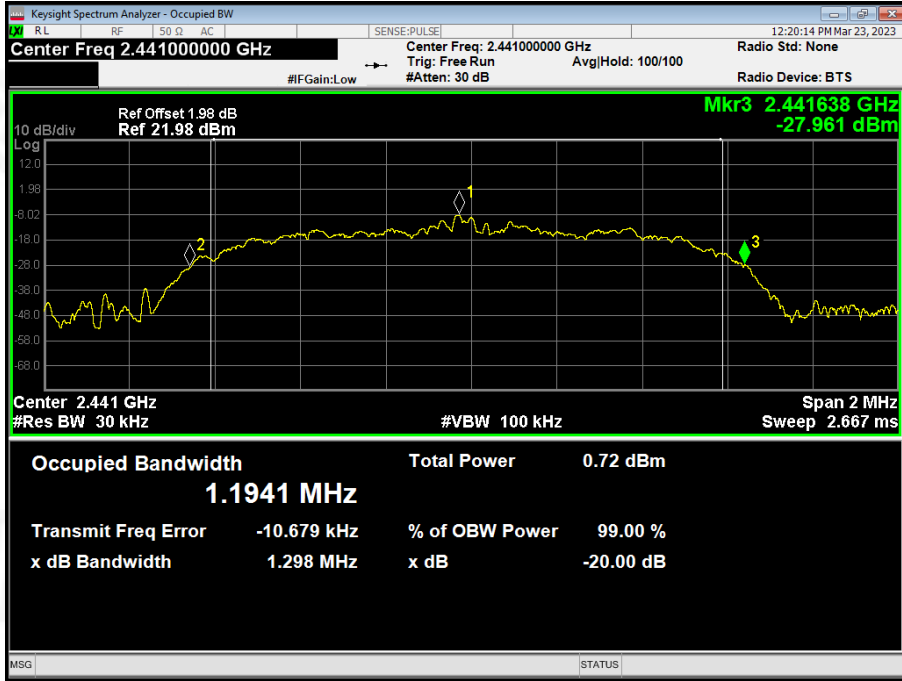

### 8-DPSK High Channel

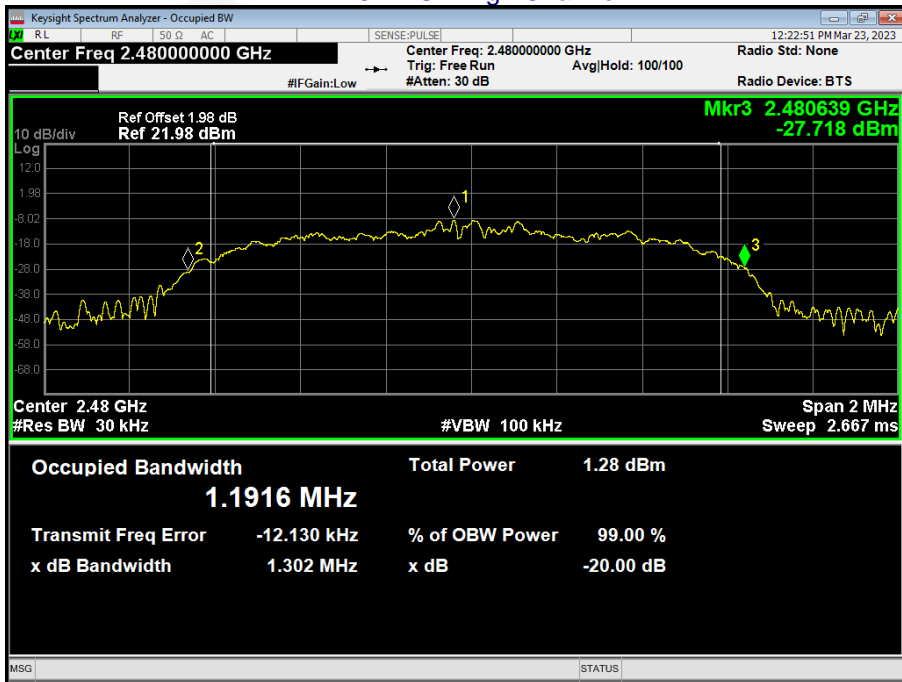





### 8. Maximum Peak Output Power

Test Requirement:	FCC Part15 C Section 15.247 (b)(1)
Test Method:	ANSI C63.10:2013
Limit:	GFSK, $\pi/4$ -DQPSK & 8-DPSK:20.97 dBm

#### 8.1 Block Diagram Of Test Setup

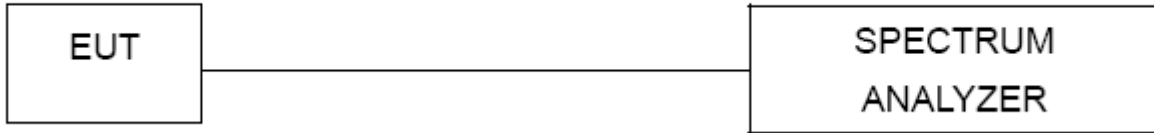

#### 8.2 Limit

For frequency hopping systems operating in the 2400-2483.5 MHz band employing at least 75 non-overlapping hopping channels, and all frequency hopping systems in the 5725-5850 MHz band: 1 watt. For all other frequency hopping systems in the 2400-2483.5 MHz band: 0.125 watts.

For FHSs operating in the band 2400-2483.5 MHz, the maximum peak conducted output power shall not exceed 1.0 W if the hopset uses 75 or more hopping channels; the maximum peak conducted output power shall not exceed 0.125 W if the hopset uses less than 75 hopping channels. The e.i.r.p. shall not exceed 4 W.

#### 8.3 Test procedure

1. Remove the antenna from the EUT and then connect a low RF cable from the antenna port to the spectrum.
2. Set the spectrum analyzer: RBW = 2MHz. VBW =6MHz. Sweep = auto; Detector Function = Peak.
3. Keep the EUT in transmitting at lowest, medium and highest channel individually. Record the max value.

#### 8.4 DEVIATION FROM STANDARD

No deviation.

#### 8.5 Max Power Test Result

Mode	Test channel	Peak Output Power (dBm)	FCC Limit (dBm)	Result
GFSK	Lowest	-4.98	21.00	Pass
	Middle	-4.29		
	Highest	-3.7		
$\pi/4$ -DQPSK	Lowest	-4.63	21.00	Pass
	Middle	-3.97		
	Highest	-3.53		
8-DPSK	Lowest	-4.18	21.00	Pass
	Middle	-3.46		
	Highest	-3.01		



### Test plots

#### GFSK Low Channel

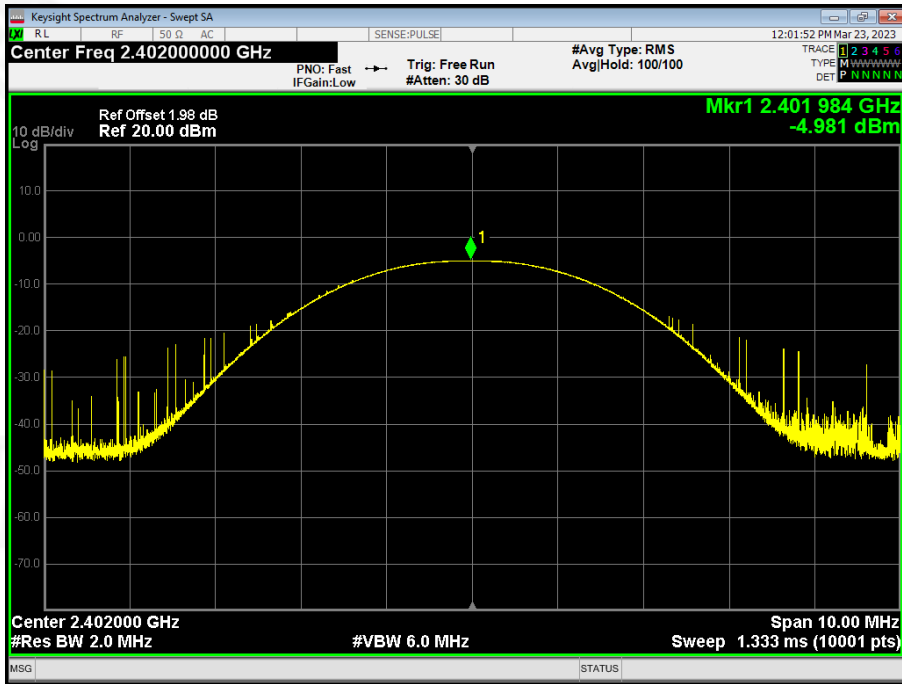

#### GFSK Middle Channel

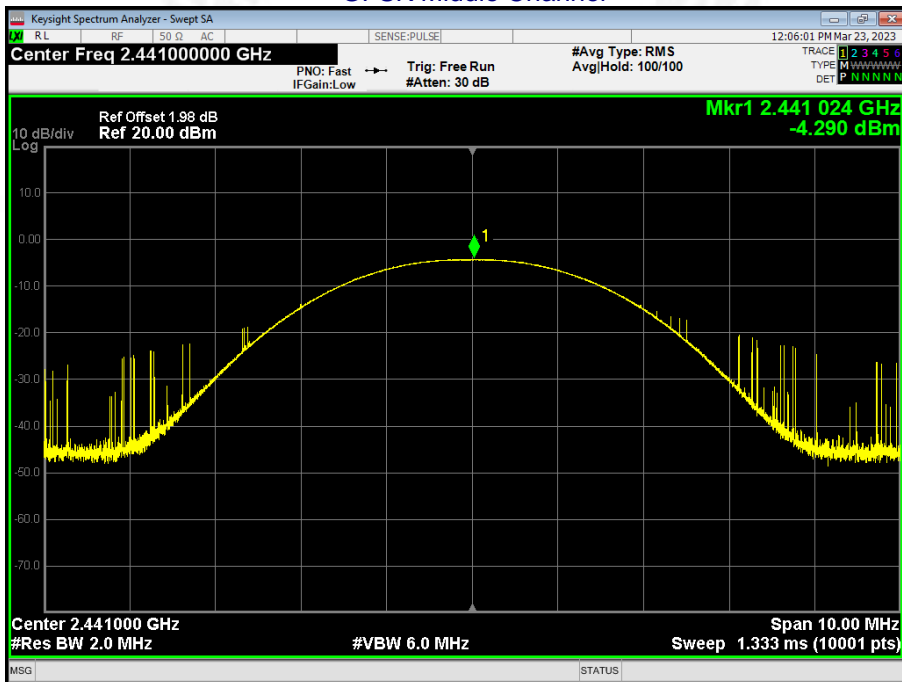



### GFSK High Channel

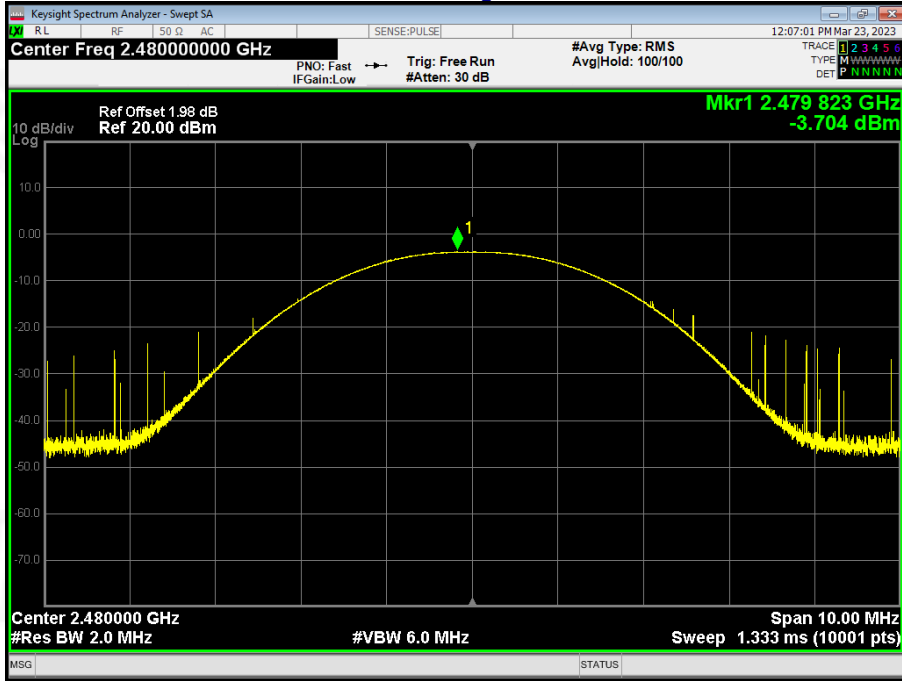

### $\pi/4$ -DQPSK Low Channel

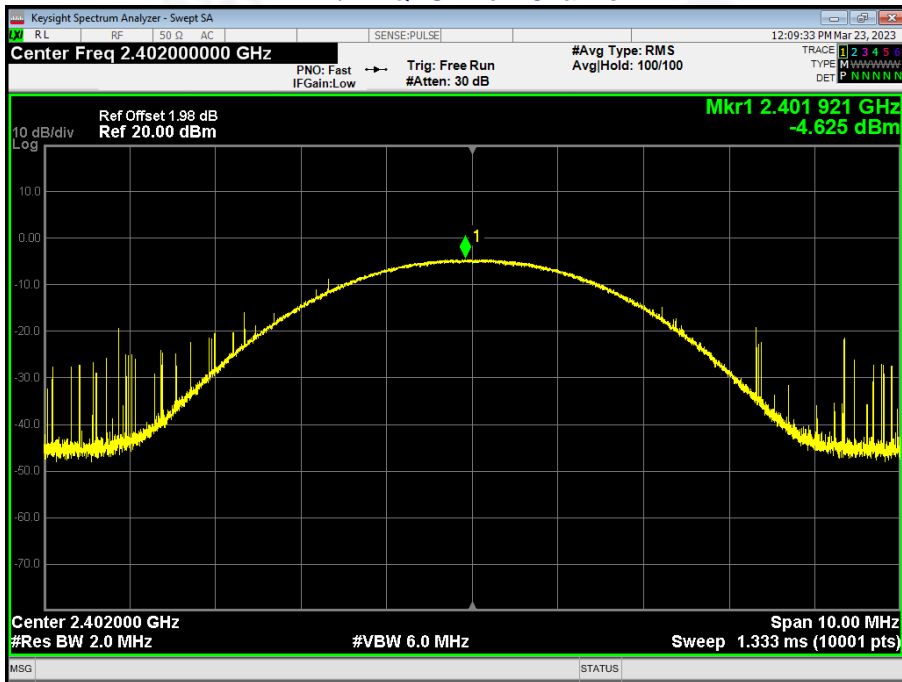



### $\pi/4$ -DQPSK Middle Channel

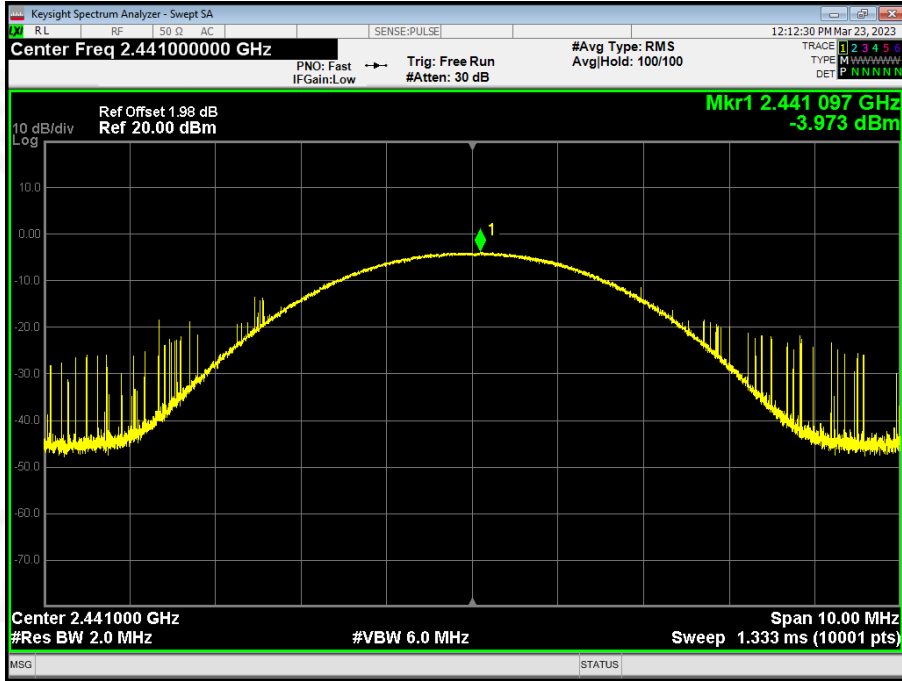

### $\pi/4$ -DQPSK High Channel

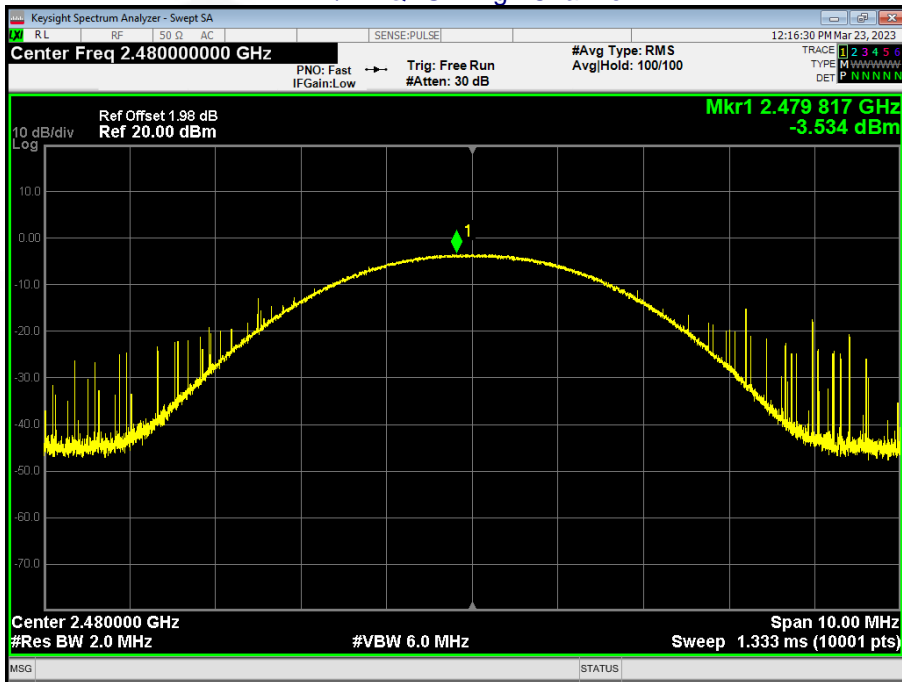



### 8-DPSK Low Channel

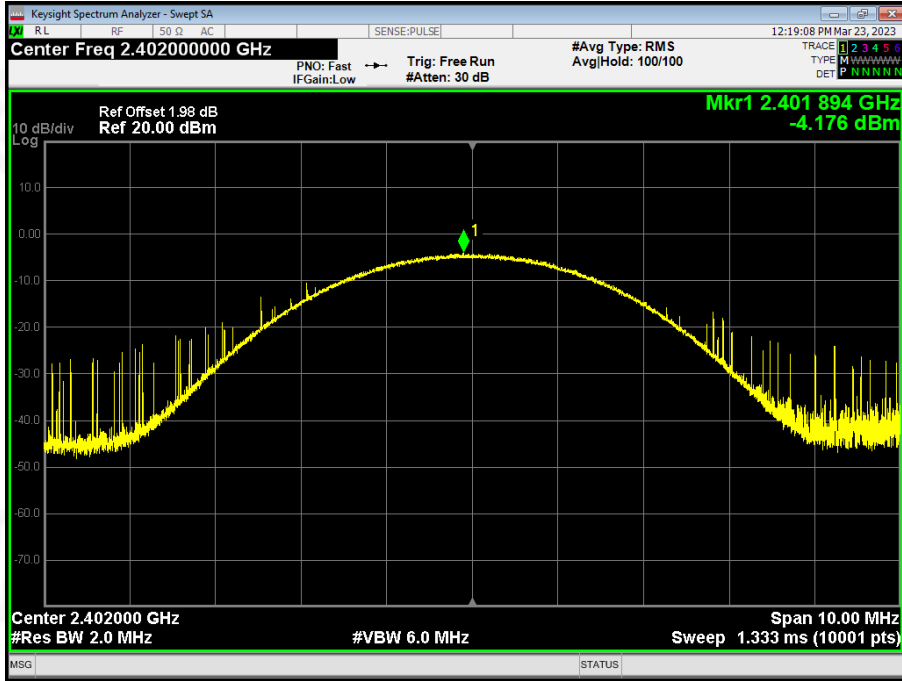

### 8-DPSK Middle Channel

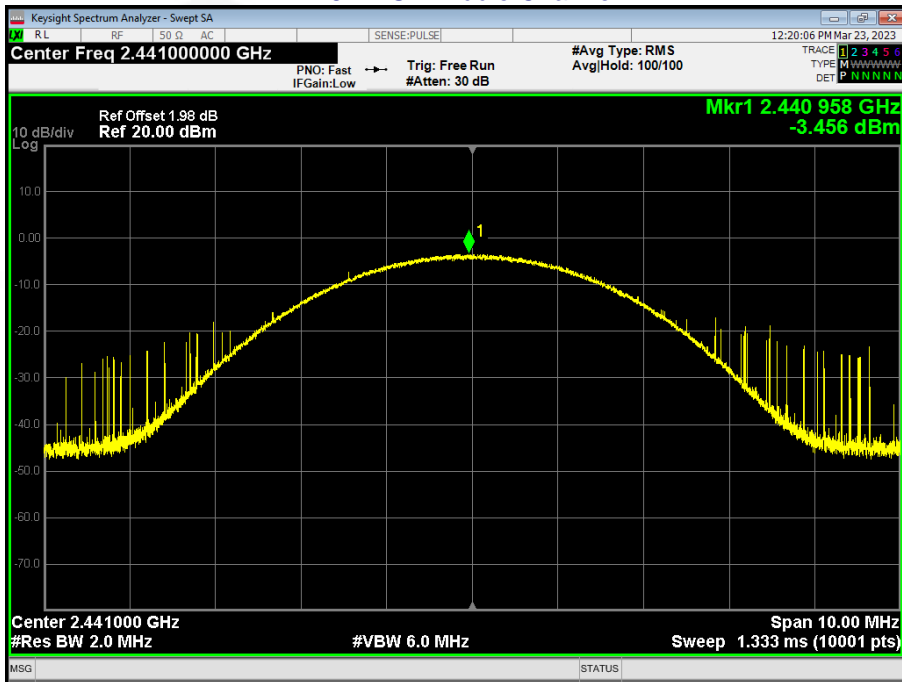



### 8-DPSK High Channel

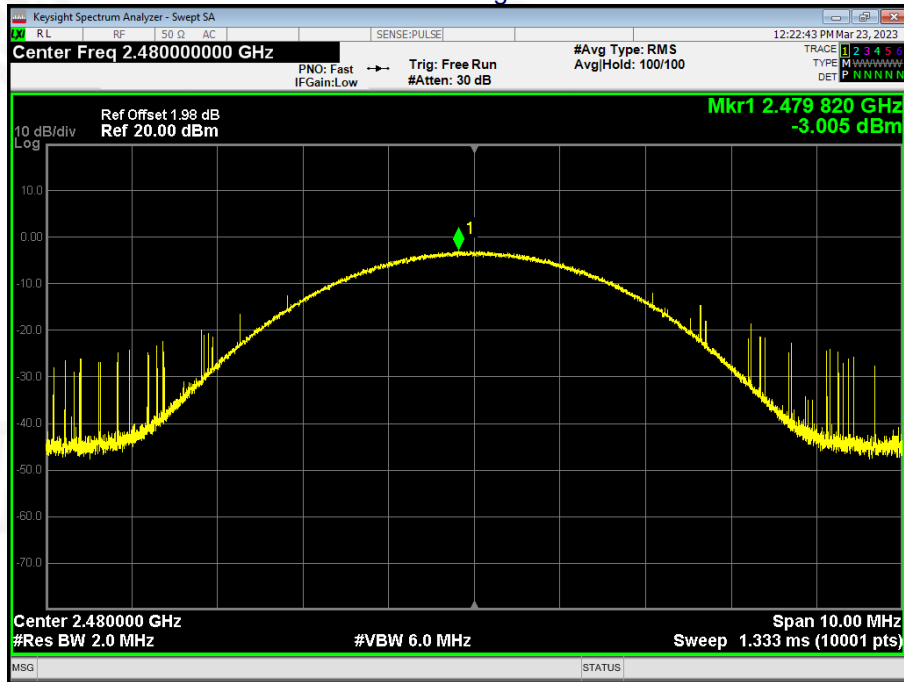



### 9. HOPPING CHANNEL SEPARATION

Test Requirement:	FCC Part15 C Section 15.247 (a)(1)
Test Method:	ANSI C63.10:2013
Receiver setup:	RBW=30KHz, VBW=100KHz, detector=Peak
Limit:	20dB bandwidth: GFSK & $\pi/4$ -DQPSK & 8-DPSK: 0.025MHz or 2/3 of the 20dB bandwidth (whichever is greater)

#### 9.1 Test Setup



#### 9.2 Test procedure

1. Remove the antenna from the EUT and then connect a low RF cable from the antenna port to the spectrum.
2. Set the spectrum analyzer: RBW = 30kHz. VBW = 100kHz , Span = 2.0MHz. Sweep = auto; Detector Function = Peak. Trace = Max hold.
3. Allow the trace to stabilize. Use the marker-delta function to determine the separation between the peaks of the adjacent channels. The limit is specified in one of the subparagraphs of this Section Submit this plot.

#### 9.3 DEVIATION FROM STANDARD

No deviation.



9.4 HCS Test Result

Modulation	Test Channel	Separation (MHz)	Limit(MHz)	Result
GFSK	Low	1.02	0.635	PASS
GFSK	Middle	1.02	0.638	PASS
GFSK	High	1.002	0.637	PASS
$\pi/4$ -DQPSK	Low	0.988	0.874	PASS
$\pi/4$ -DQPSK	Middle	1.048	0.879	PASS
$\pi/4$ -DQPSK	High	0.966	0.87	PASS
8-DPSK	Low	0.902	0.864	PASS
8-DPSK	Middle	1.022	0.865	PASS
8-DPSK	High	0.964	0.868	PASS

Test plots  
GFSK Low Channel

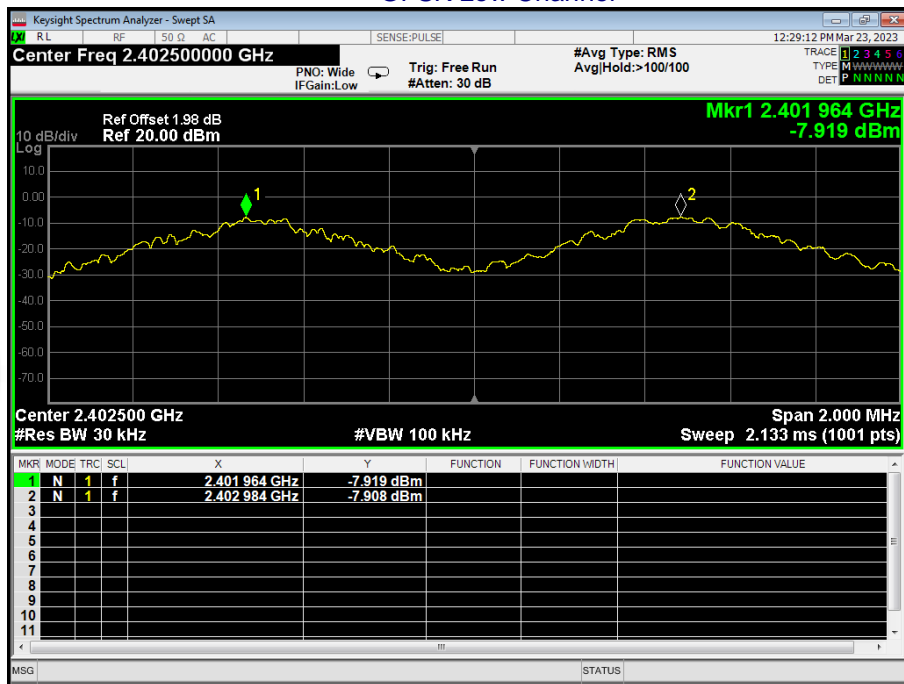





### GFSK Middle Channel

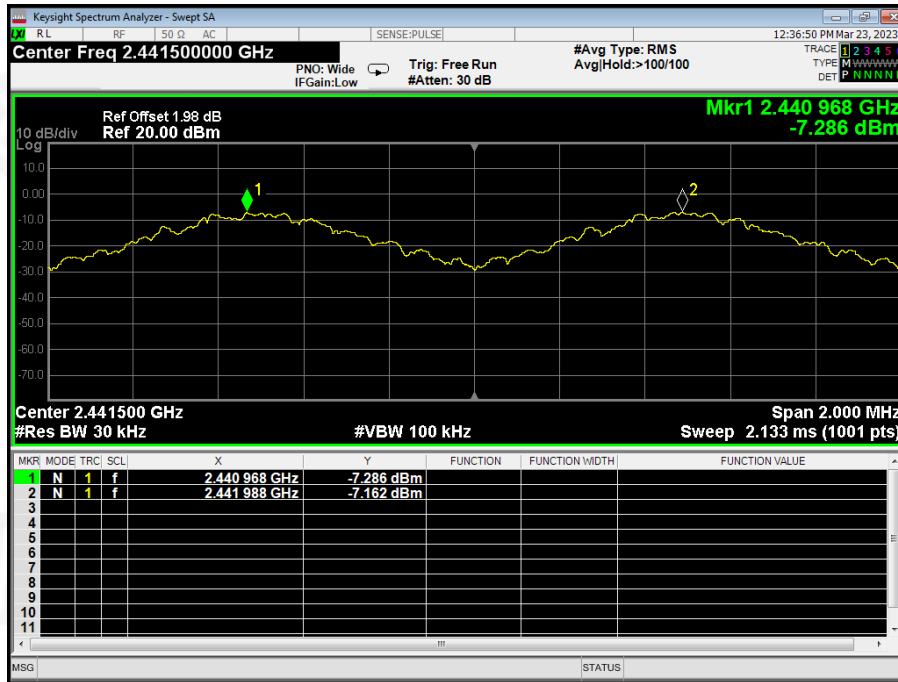

### GFSK High Channel

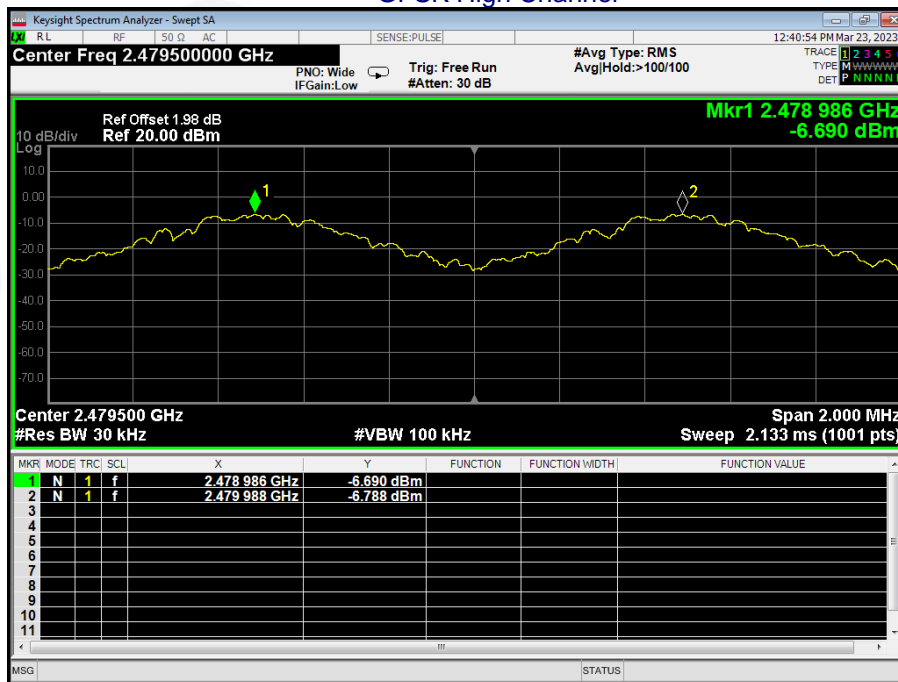



$\pi/4$ -DQPSK Low Channel

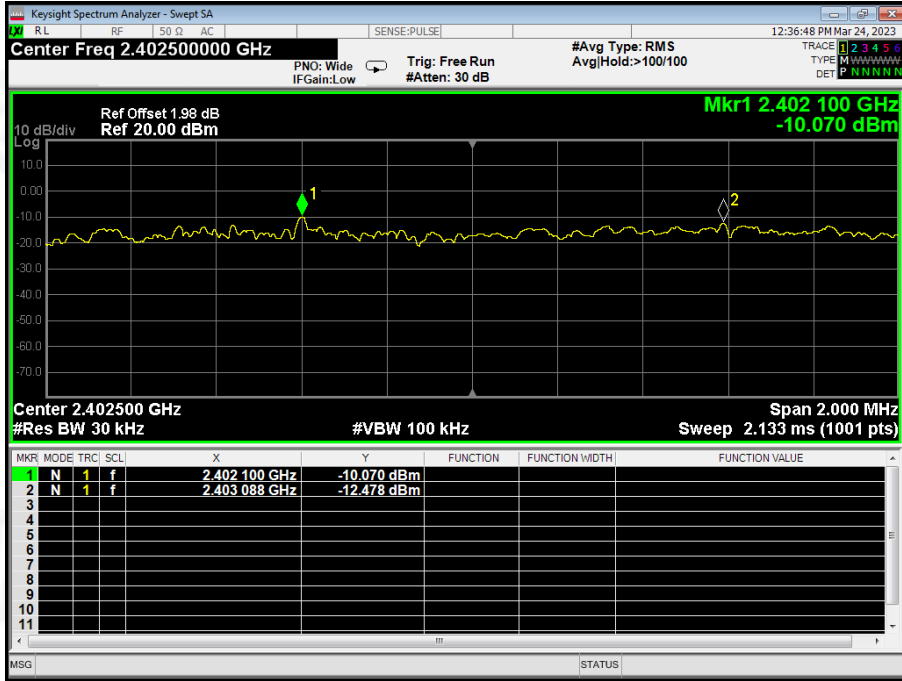

$\pi/4$ -DQPSK Middle Channel

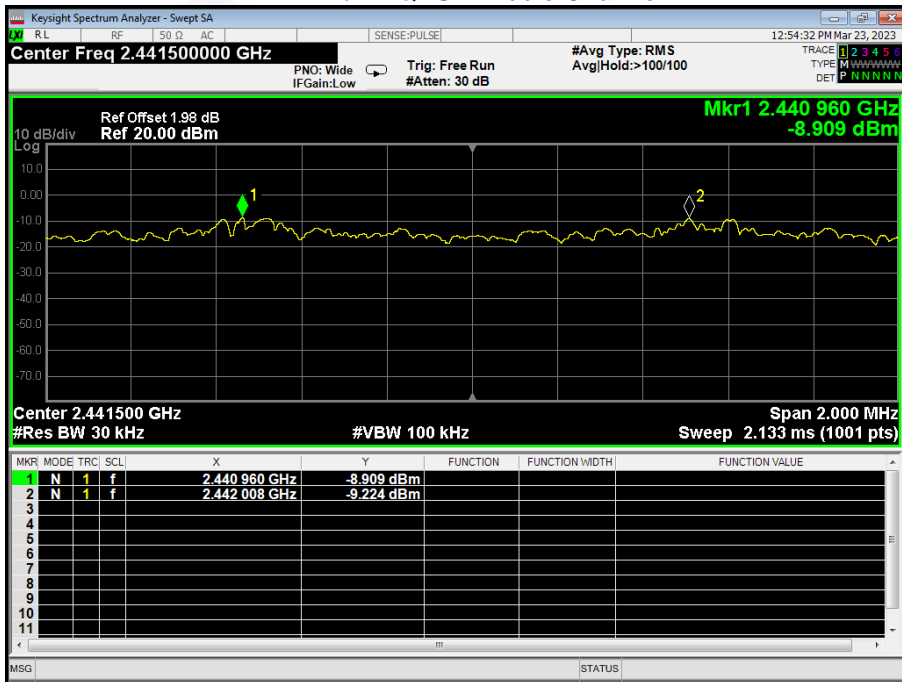



### $\pi/4$ -DQPSK High Channel

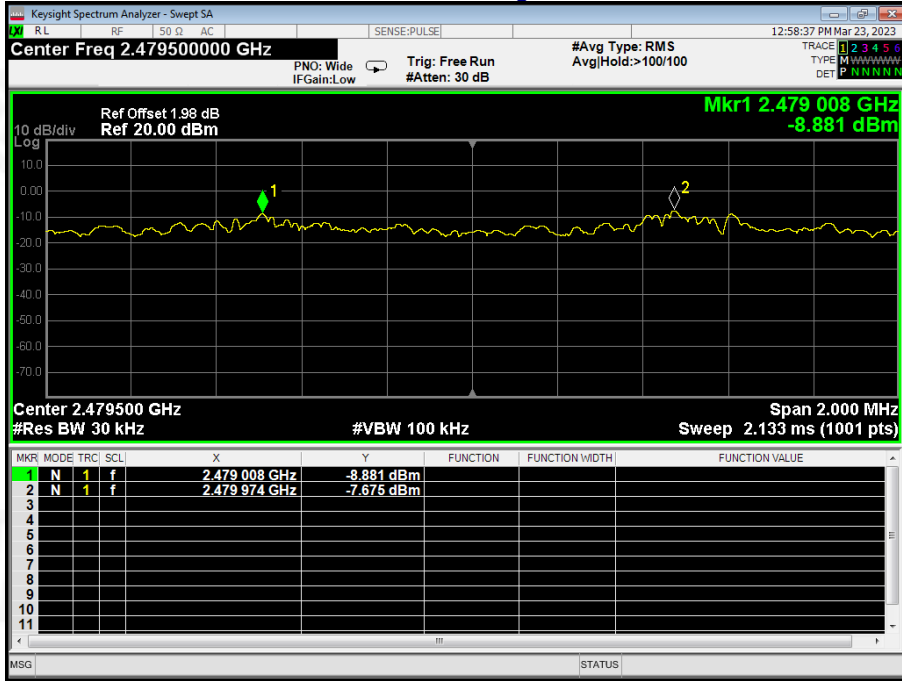

### 8-DPSK Low Channel

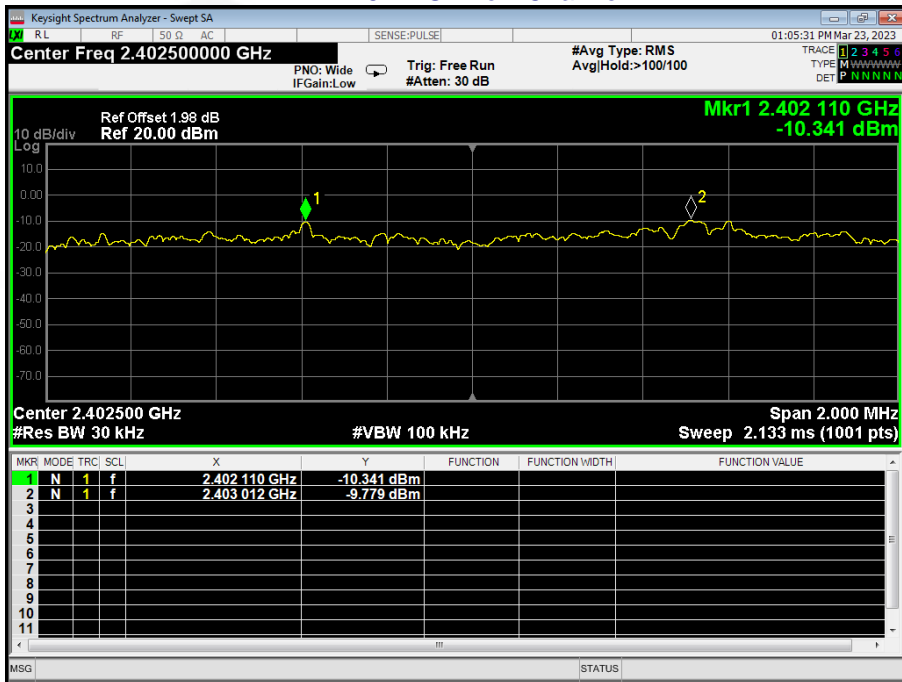



### 8-DPSK Middle Channel

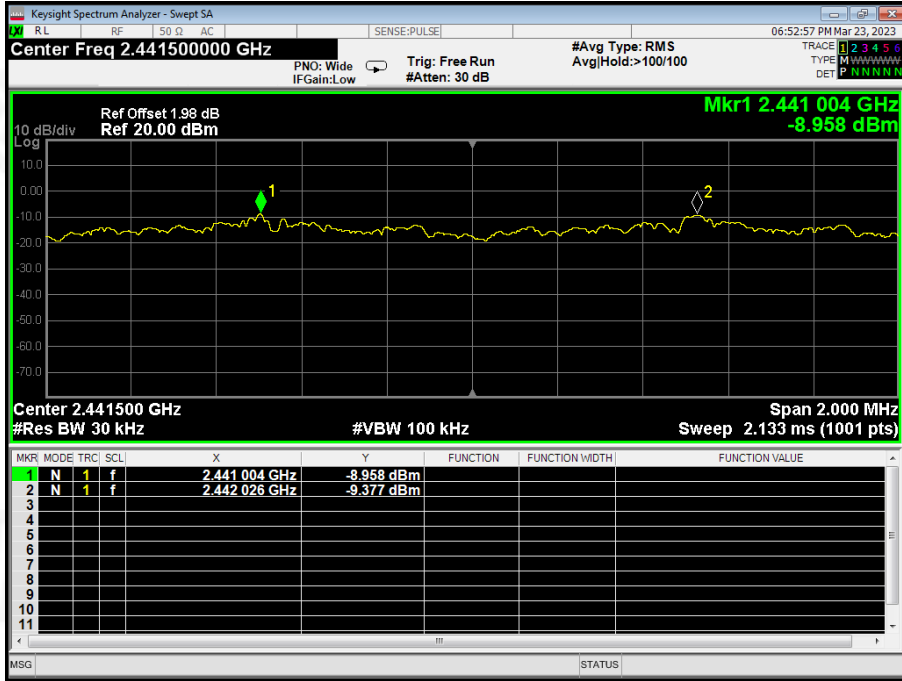

### 8-DPSK High Channel

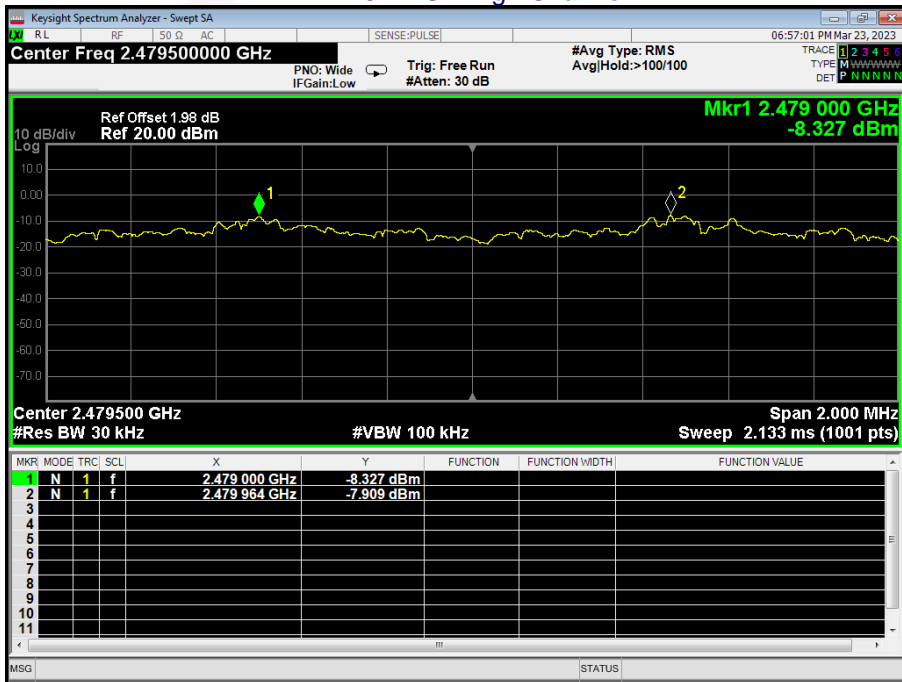



### 10.NUMBER OF HOPPING FREQUENCY

Test Requirement:	FCC Part15 C Section 15.247 (a)(1)(iii)
Test Method:	ANSI C63.10:2013
Receiver setup:	RBW=100kHz, VBW=300kHz, Frequency range=2400MHz-2483.5MHz, Detector=Peak
Limit:	15 channels

#### 10.1 Test Setup

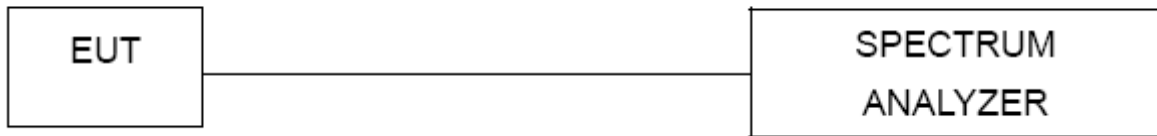

#### 10.2 Test procedure

1. Remove the antenna from the EUT and then connect a low RF cable from the antenna port to the spectrum.
2. Set the spectrum analyzer: RBW = 100kHz. VBW = 300kHz. Sweep = auto; Detector Function = Peak. Trace = Max hold.
3. Allow the trace to stabilize. It may prove necessary to break the span up to sections. in order to clearly show all of the hopping frequencies. The limit is specified in one of the subparagraphs of this Section.
4. Set the spectrum analyzer: Start Frequency = 2.4GHz, Stop Frequency = 2.4835GHz. Sweep=auto;

#### 10.3 DEVIATION FROM STANDARD

No deviation.



### 10.4 Number of Hopping Frequency Test Result

Modulation	Test Value	Limit	Result
GFSK	79	15	PASS
$\pi/4$ -DQPSK	79	15	PASS
8-DPSK	79	15	PASS

Test Plots:  
79 Channels in total  
GFSK

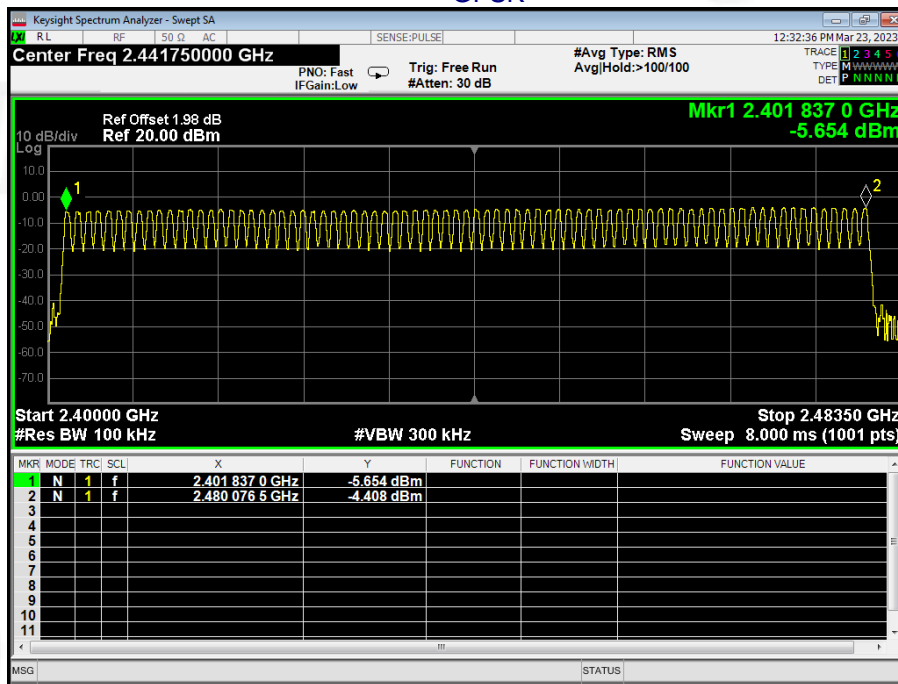



π/4-DQPSK

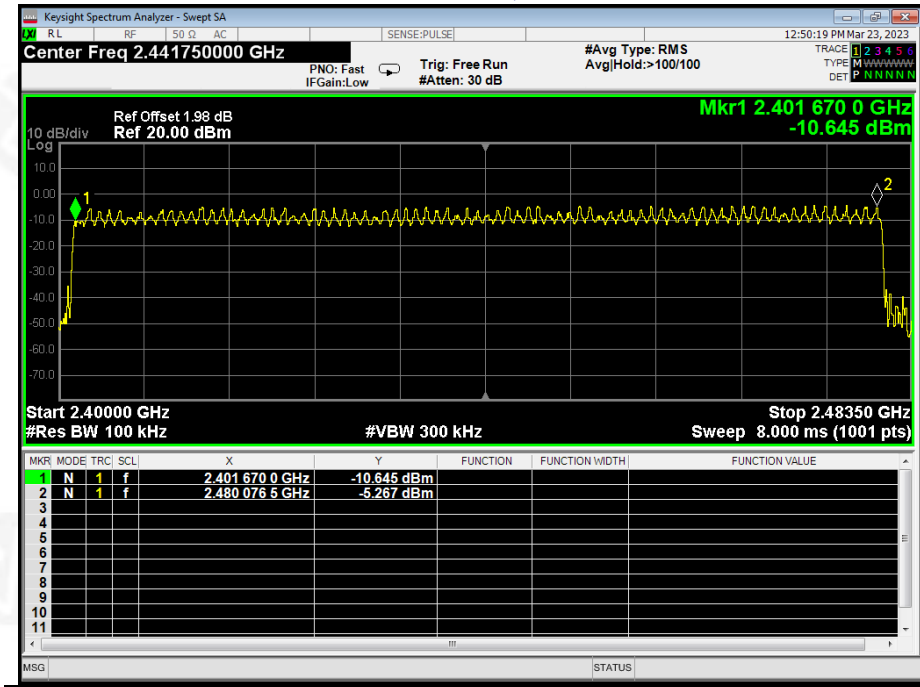

8-DPSK

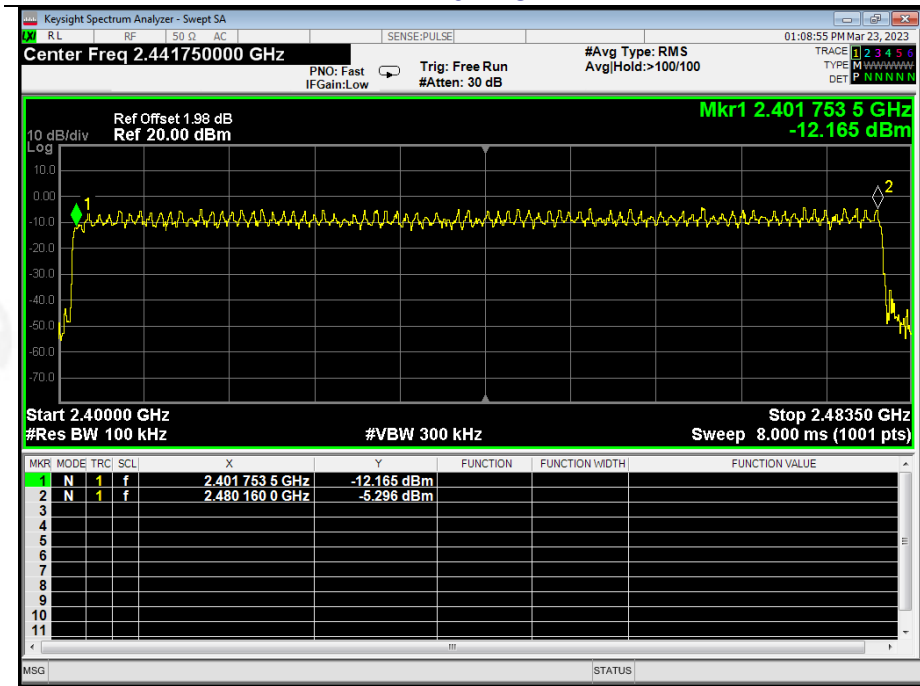



### 11. DWELL TIME

Test Requirement:	FCC Part15 C Section 15.247 (a)(1)(iii)
Test Method:	ANSI C63.10:2013
Receiver setup:	RBW=1MHz, VBW=3MHz, Span=0Hz, Detector=Peak
Limit:	0.4 Second

#### 11.1 Test Setup



#### 11.2 Test procedure

1. Remove the antenna from the EUT and then connect a low RF cable from the antenna port to the spectrum.
2. Set spectrum analyzer span = 0Hz;
3. Set RBW = 1MHz and VBW = 3MHz. Sweep = as necessary to capture the entire dwell time per hopping channel. Set the EUT for DH5, DH3 and DH1 packet transmitting.
4. Use the marker-delta function to determine the dwell time. If this value varies with different modes of operation (e.g.. data rate. modulation format. etc.). repeat this test for each variation. The limit is specified in one of the subparagraphs of this Section. Submit this plot(s).

#### 11.3 DEVIATION FROM STANDARD

No deviation.





### 11.4 Dwell Time Test Result

GFSK mode:

Frequency	Packet	Dwell time(ms)	Limit(ms)	Result
2441MHz	DH1	138.240	400	Pass
2441MHz	DH3	260.800	400	Pass
2441MHz	DH5	302.080	400	Pass

Remarks:

The test period:  $T = 0.4 \text{ Second/Channel} \times 79 \text{ Channel} = 31.6 \text{ s}$   
 Test channel: as blow  
 CH:2441MHz time slot= $0.432(\text{ms}) \times (1600 / (2 \times 79)) \times 31.6 = 138.240\text{ms}$   
 CH:2441MHz time slot= $1.630(\text{ms}) \times (1600 / (4 \times 79)) \times 31.6 = 260.800\text{ms}$   
 CH:2441MHz time slot= $2.832(\text{ms}) \times (1600 / (6 \times 79)) \times 31.6 = 302.080\text{ms}$

$\pi/4$ -DQPSK mode:

Frequency	Packet	Dwell time(ms)	Limit(ms)	Result
2441MHz	2DH1	157.440	400	Pass
2441MHz	2DH3	270.720	400	Pass
2441MHz	2DH5	308.373	400	Pass

Remarks:

The test period:  $T = 0.4 \text{ Second/Channel} \times 79 \text{ Channel} = 31.6 \text{ s}$   
 Test channel: as blow  
 CH:2441MHz time slot= $0.492(\text{ms}) \times (1600 / (2 \times 79)) \times 31.6 = 157.440\text{ms}$   
 CH:2441MHz time slot= $1.692(\text{ms}) \times (1600 / (4 \times 79)) \times 31.6 = 270.720\text{ms}$   
 CH:2441MHz time slot= $2.891(\text{ms}) \times (1600 / (6 \times 79)) \times 31.6 = 308.373\text{ms}$

8-DPSK mode:

Frequency	Packet	Dwell time(ms)	Limit(ms)	Result
2441MHz	3DH1	133.440	400	Pass
2441MHz	3DH3	266.400	400	Pass
2441MHz	3DH5	294.400	400	Pass

Remarks:

The test period:  $T = 0.4 \text{ Second/Channel} \times 79 \text{ Channel} = 31.6 \text{ s}$   
 Test channel: as blow  
 CH:2441MHz time slot= $0.417(\text{ms}) \times (1600 / (2 \times 79)) \times 31.6 = 133.440\text{ms}$   
 CH:2441MHz time slot= $1.665(\text{ms}) \times (1600 / (4 \times 79)) \times 31.6 = 266.400\text{ms}$   
 CH:2441MHz time slot= $2.760(\text{ms}) \times (1600 / (6 \times 79)) \times 31.6 = 294.400\text{ms}$



Test Plots

GFSK DH1 2441MHz

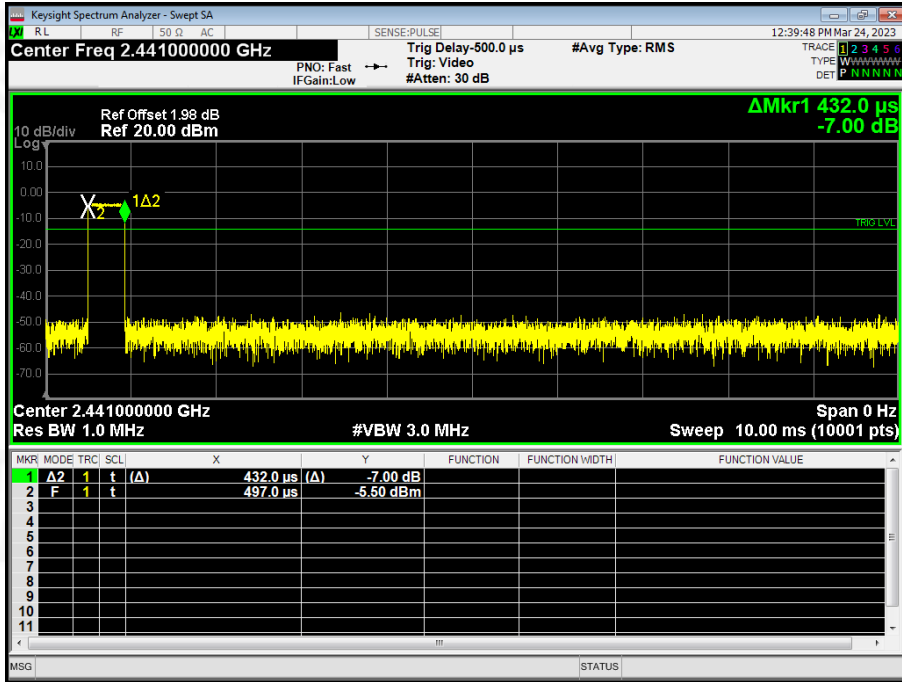

GFSK DH3 2441MHz

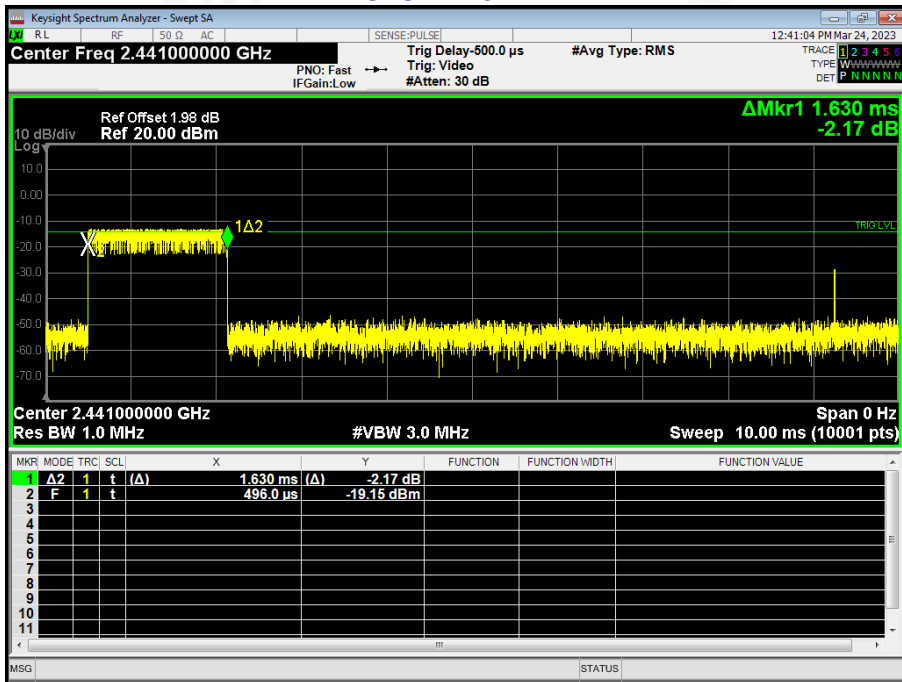



### GFSK DH5 2441MHz

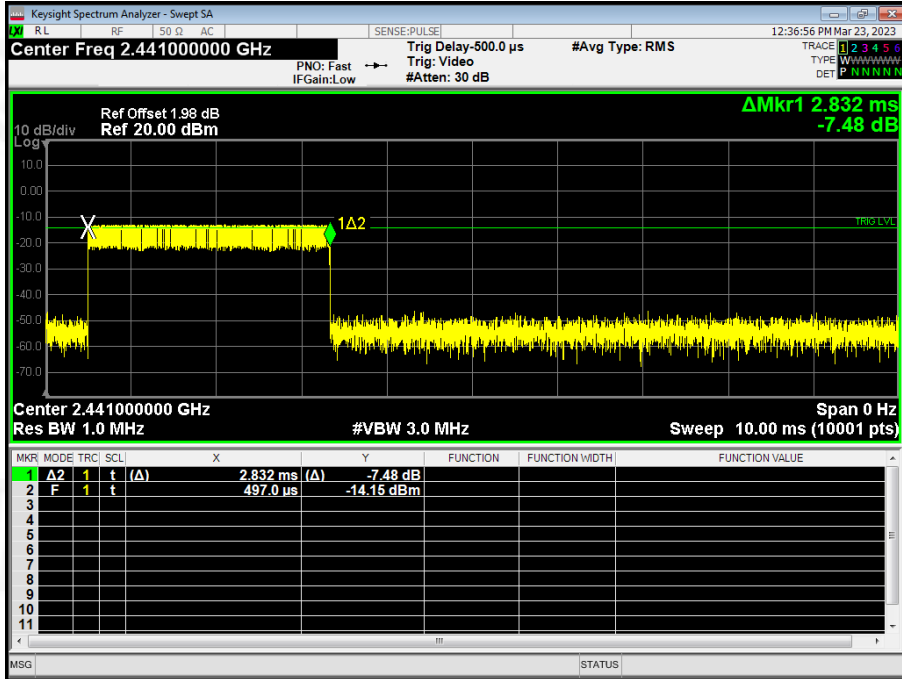

### $\pi/4$ -DQPSK 2DH1 2441MHz

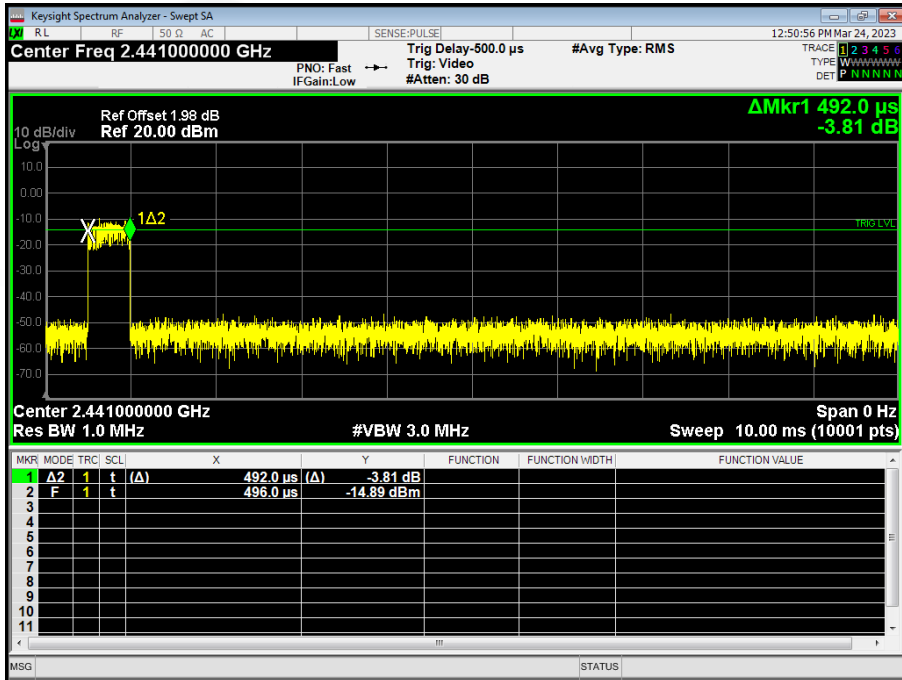



$\pi/4$ -DQPSK 2DH3 2441MHz

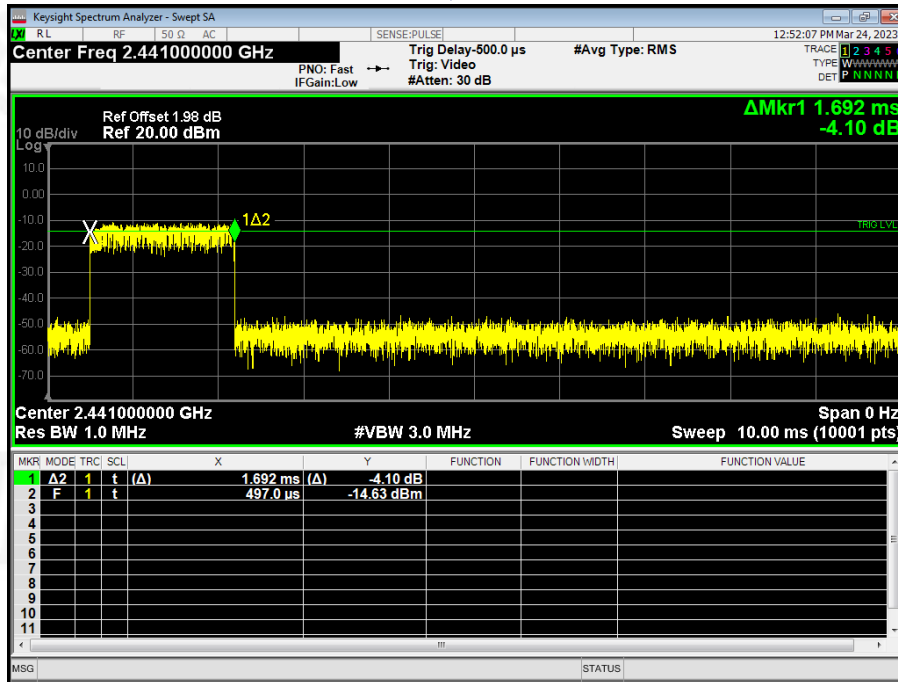

$\pi/4$ -DQPSK 2DH5 2441MHz

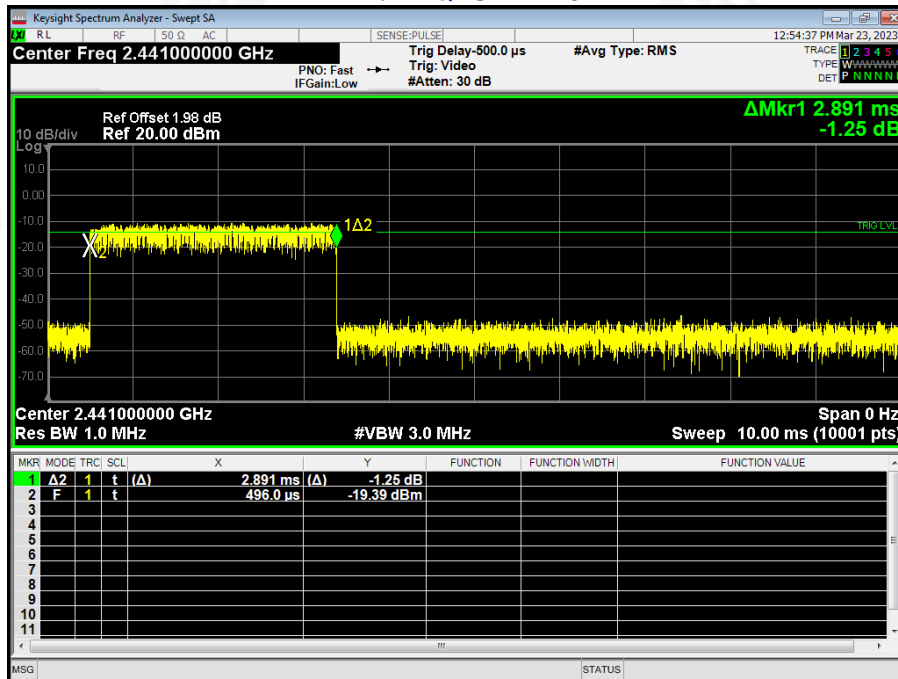



### 8-DPSK 3DH1 2441MHz

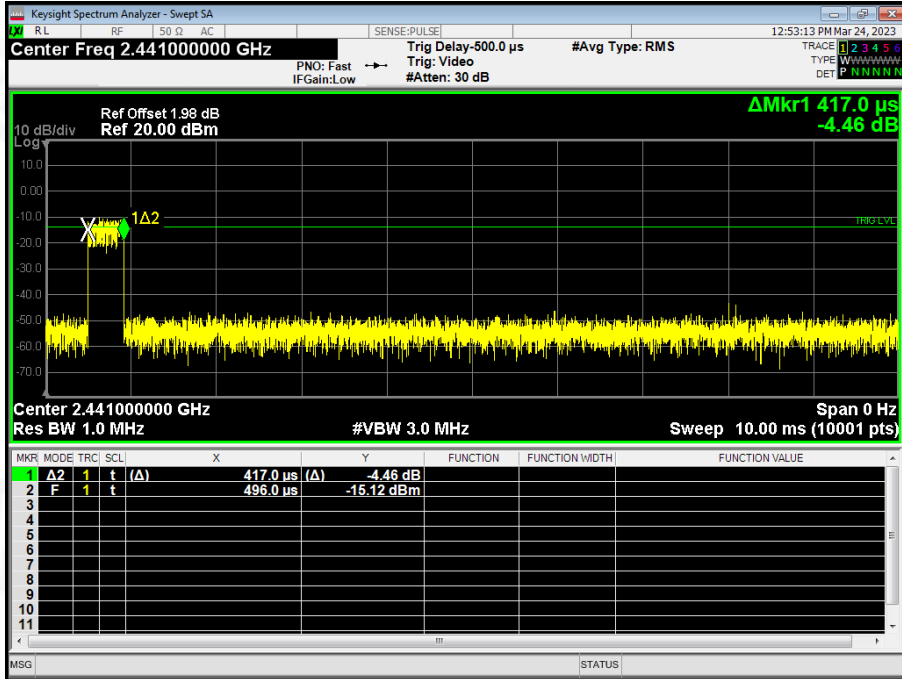

### 8-DPSK 3DH3 2441MHz

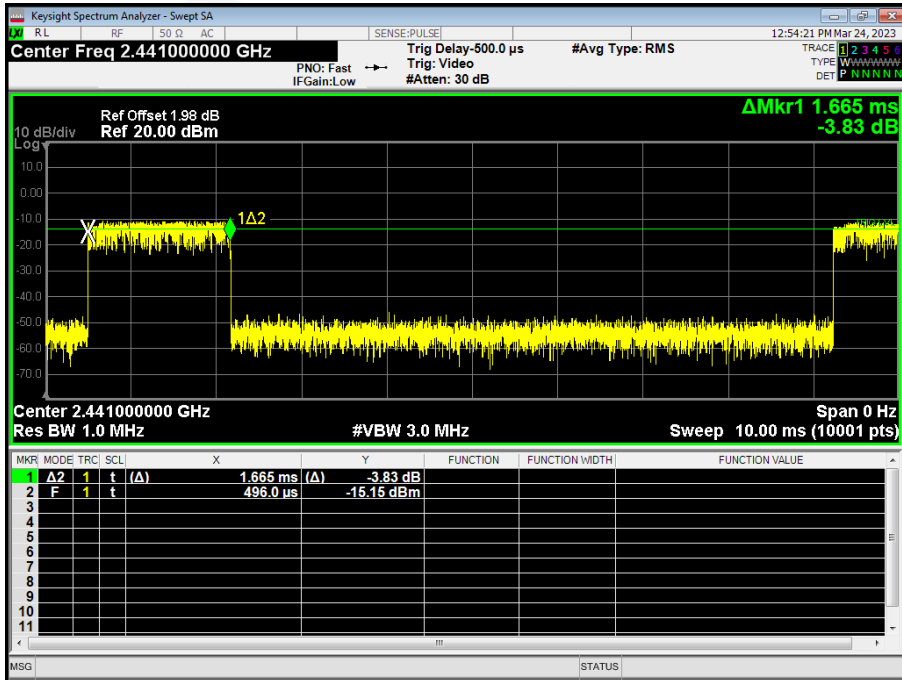



### 8-DPSK 3DH5 2441MHz

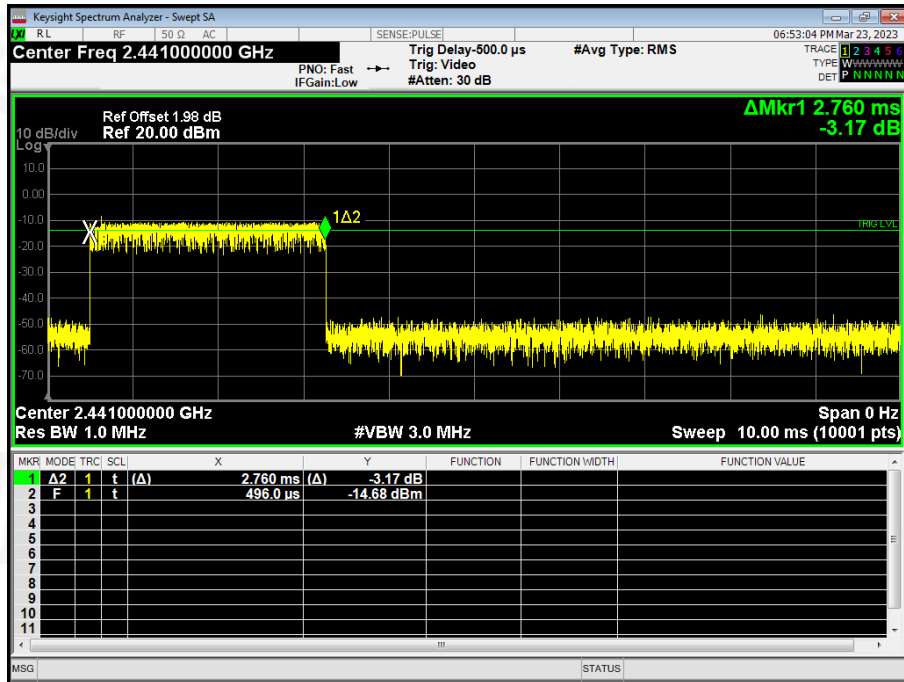



## 12. Antenna Requirement

Standard requirement:	FCC Part15 C Section 15.203 /247(c)
15.203 requirement: An intentional radiator shall be designed to ensure that no antenna other than that furnished by the responsible party shall be used with the device. The use of a permanently attached antenna or of an antenna that uses a unique coupling to the intentional radiator, the manufacturer may design the unit so that a broken antenna can be replaced by the user, but the use of a standard antenna jack or electrical connector is prohibited.	
15.247(c) (1)(i) requirement: (i) Systems operating in the 2400-2483.5 MHz band that is used exclusively for fixed. Point-to-point operations may employ transmitting antennas with directional gain greater than 6dBi provided the maximum conducted output power of the intentional radiator is reduced by 1 dB for every 3 dB that the directional gain of the antenna exceeds 6dBi.	
EUT Antenna:	
The antenna is FPCB antenna, the best case gain of the antennas is 0dBi, reference to the Internal Photos for details	



### 13. Test Setup Photo

Reference to the appendix Test Setup Photos for details.

### 14. EUT Constructional Details

Reference to the appendix External Photos and Internal Photos for details.

\*\*\*\*\* END OF REPORT \*\*\*\*\*