



TEST REPORT
FCC Part 27/RSS-139 Issue 3/ RSS-GEN

Report Reference No......: HK1907301843-2E
FCC ID.....: 2AUAE-M3300001
 Compiled by
 (position+printed name+signature)..: File administrators Gary Qian

Gary Qian

Supervised by
 (position+printed name+signature)..: Technique principal Eden Hu

Eden Hu

Approved by
 (position+printed name+signature)..: Manager Jason Zhou

Jason Zhou

Date of issue.....: Aug. 13, 2019

Testing Laboratory Name: **Shenzhen HUAKE Testing Technology Co., Ltd.**
 Address: 1F, B2 Building, Junfeng Zhongcheng Zhizao Innovation
 Park,Heping Community, Fuhai Street, Bao 'an District, Shenzhen,
 China

Applicant's name.....: **Proscend Communications Inc.**
 Address: 2F, No. 36, Industry E. Rd. IV, Hsinchu Science Park, Hsinchu,
 Taiwan, R.O.C.

Test specification:
 Standard: **FCC CFR Title 47 Part 2, Part 27**
 TRF Originator.....: Shenzhen HUAKE Testing Technology Co., Ltd.

Shenzhen HUAKE Testing Technology Co., Ltd. All rights reserved.
 This publication may be reproduced in whole or in part for non-commercial purposes as long as the Shenzhen HUAKE Testing Technology Co., Ltd. as copyright owner and source of the material. Shenzhen HUAKE Testing Technology Co., Ltd. takes no responsibility for and will not assume liability for damages resulting from the reader's interpretation of the reproduced material due to its placement and context.

Test item description: Industrial 4G LTE Cellular Router
 Trade Mark: Proscend
Manufacturer.....: **Proscend Communications Inc.**
 Model/Type reference.....: M330-W
 Listed Models: MXXX-XXXXX-XX (Where "X" can be used as "A-Z", or "0-9", or "-",
 or blank for hardware/software changes/applications or marketing
 purpose only)
 Modulation Type: QPSK, 16QAM
 Rating: DC 8-48V
 Hardware version: V2.0
 Software version: V2.0
 Result.....: **PASS**

**TEST REPORT**

Test Report No. :	HK1907301843-2E	Aug. 13, 2019
		Date of issue

Equipment under Test : Industrial 4G LTE Cellular Router

Model /Type : M330-W

Listed Models : MXXX-XXXXX-XX(Where "X" can be used as "A-Z", or "0-9", or "-", or blank for hardware/software changes/ applications or marketing purpose only)

Applicant : **Proscend Communications Inc.**

Address : 2F, No. 36, Industry E. Rd. IV, Hsinchu Science Park, Hsinchu, Taiwan, R.O.C.

Manufacturer : **Proscend Communications Inc.**

Address : 2F, No. 36, Industry E. Rd. IV, Hsinchu Science Park, Hsinchu, Taiwan, R.O.C.

Test result	Pass
--------------------	-------------

The test report merely corresponds to the test sample.
It is not permitted to copy extracts of these test result without the written permission of the test laboratory.



Contents

<u>1</u>	<u>SUMMARY</u>	<u>4</u>
1.1	TEST STANDARDS	4
1.2	Test Description	4
1.3	Test Facility	5
1.4	Statement of the measurement uncertainty	5
<u>2</u>	<u>GENERAL INFORMATION</u>	<u>6</u>
2.1	Environmental conditions	6
2.2	Description of Test Modes	6
2.3	Equipments Used during the Test	7
2.4	Related Submittal(s) / Grant (s)	7
2.5	Modifications	7
<u>3</u>	<u>TEST CONDITIONS AND RESULTS</u>	<u>8</u>
3.1	Output Power	8
3.3	Peak-to-Average Ratio (PAR)	13
3.4	Occupied Bandwidth and Emission Bandwidth	20
3.5	Band Edge compliance	27
3.6	Spurious Emission	34
3.7	Frequency Stability under Temperature & Voltage Variations	66



1 SUMMARY

1.1 TEST STANDARDS

The tests were performed according to following standards:

[FCC Part 27](#) : MISCELLANEOUS WIRELESS COMMUNICATIONS SERVICES

[TIA/EIA 603 D June 2010](#):Land Mobile FM or PM Communications Equipment Measurement and Performance Standards.

47 CFR FCC Part 15 Subpart B: - Unintentional Radiators

[FCC Part 2](#): FREQUENCY ALLOCATIONS AND RADIO TREATY MATTERS; GENERAL RULES AND REGULATIONS

[KDB971168 D01: v02r02](#) MEASUREMENT GUIDANCE FOR CERTIFICATION OF LICENSED DIGITAL TRANSMITTERS

1.2 Test Description

Test Item	Section in CFR 47	Result
RF Output Power	Part 2.1046 Part 27.50(d)(4)	Pass
Peak-to-Average Ratio	Part 27.50(d)(4)	Pass
99% & -26 dB Occupied Bandwidth	Part 2.1049 Part 27.53(h)	Pass
Spurious Emissions at Antenna Terminal	Part 2.1051 Part 27.53(h)	Pass
Field Strength of Spurious Radiation	Part 2.1053 Part 27.53(h)	Pass
Out of band emission, Band Edge	Part 2.1051 Part 27.53(h)	Pass
Frequency stability	Part 2.1055 Part 27.54	Pass



1.3 Test Facility

1.3.1 Address of the test laboratory

Shenzhen HUAKE Testing Technology Co., Ltd.

1F, B2 Building, Junfeng Zhongcheng Zhizao Innovation Park, Heping Community, Fuhai Street, Bao'an District, Shenzhen, China

1.4 Statement of the measurement uncertainty

The data and results referenced in this document are true and accurate. The reader is cautioned that there may be errors within the calibration limits of the equipment and facilities. The measurement uncertainty was calculated for all measurements listed in this test report acc. to CISPR 16 - 4 „Specification for radio disturbance and immunity measuring apparatus and methods – Part 4: Uncertainty in EMC Measurements“ and is documented in the Shenzhen HUAKE Testing Technology Co., Ltd. quality system acc. to DIN EN ISO/IEC 17025. Furthermore, component and process variability of devices similar to that tested may result in additional deviation. The manufacturer has the sole responsibility of continued compliance of the device.

Hereafter the best measurement capability for Shenzhen HUAKE Testing Technology Co., Ltd. is reported:

Test	Range	Measurement Uncertainty	Notes
Radiated Emission	30~1000MHz	4.10dB	(1)
Radiated Emission	Above 1GHz	4.32dB	(1)
Conducted Disturbance	0.15~30MHz	3.20dB	(1)

(1) This uncertainty represents an expanded uncertainty expressed at approximately the 95% confidence level using a coverage factor of $k=2$.



2 GENERAL INFORMATION

2.1 Environmental conditions

During the measurement the environmental conditions were within the listed ranges:

Normal Temperature:	25°C
Relative Humidity:	55 %
Air Pressure:	101 kPa

2.2 Description of Test Modes

The EUT has been tested under typical operating condition. The CMW500 used to control the EUT staying in continuous transmitting and receiving mode for testing. Regards to the frequency band operation: the lowest, middle and highest frequency of channel were selected to perform the test, then shown on this report.

Note:

1. For the ERP/EIRP and radiated emission test, every axis (X, Y, Z) was verified, and show the worst result on this report.
2. Test method and refer to 3GPP TS136521.



2.3 Equipments Used during the Test

Test Equipment	Manufacturer	Model No.	Serial No.	Calibration Date	Calibration Due Date
LISN	ENV216	R&S	HKE-059	2018/12/27	2019/12/26
LISN	R&S	ENV216	HKE-002	2018/12/27	2019/12/26
Broadband antenna	Schwarzbeck	VULB 9163	HKE-012	2018/12/27	2019/12/26
Receiver	R&S	ESCI 7	HKE-010	2018/12/27	2019/12/26
Spectrum analyzer	Agilent	N9020A	HKE-048	2018/12/27	2019/12/26
RF automatic control unit	Tonscend	JS0806-2	HKE-060	2018/12/27	2019/12/26
Horn antenna	Schwarzbeck	9120D	HKE-013	2018/12/27	2019/12/26
Loop antenna	Schwarzbeck	FMZB 1519 B	HKE-014	2018/12/27	2019/12/26
Preamplifier	EMCI	EMC051845SE	HKE-015	2018/12/27	2019/12/26
Preamplifier	Agilent	83051A	HKE-016	2018/12/27	2019/12/26
Temperature and humidity meter	Boyang	HTC-1	HKE-075	2018/12/27	2019/12/26
High pass filter unit	Tonscend	JS0806-F	HKE-055	2018/12/27	2019/12/26
RF cable	Times	1-40G	HKE-034	2018/12/27	2019/12/26
Power meter	Agilent	E4419B	HKE-085	2018/12/27	2019/12/26
Power Sensor	Agilent	E9300A	HKE-086	2018/12/27	2019/12/26
Wireless Communication Test Set	R&S	CMW500	HKE-026	2018/12/27	2019/12/26

2.4 Related Submittal(s) / Grant (s)

This submittal(s) (test report) is intended for FCC ID: 2AUAE-M3300001 filing to comply with of the FCC Part 24 Rules.

2.5 Modifications

No modifications were implemented to meet testing criteria.

3 TEST CONDITIONS AND RESULTS

3.1 Output Power

LIMIT

According to §27.50 (d) (4): Fixed, mobile, and portable (hand-held) stations operating in the 1710–1755 MHz band are limited to 1 watt EIRP.

TEST CONFIGURATION

Conducted Power Measurement

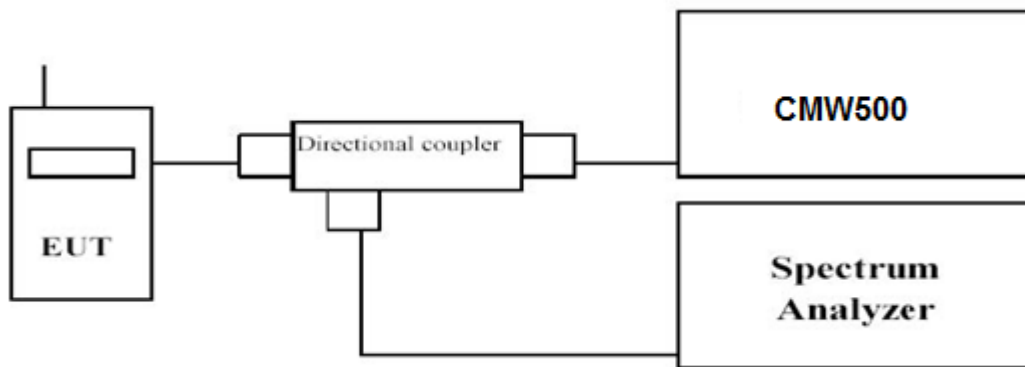

Radiated Power Measurement:

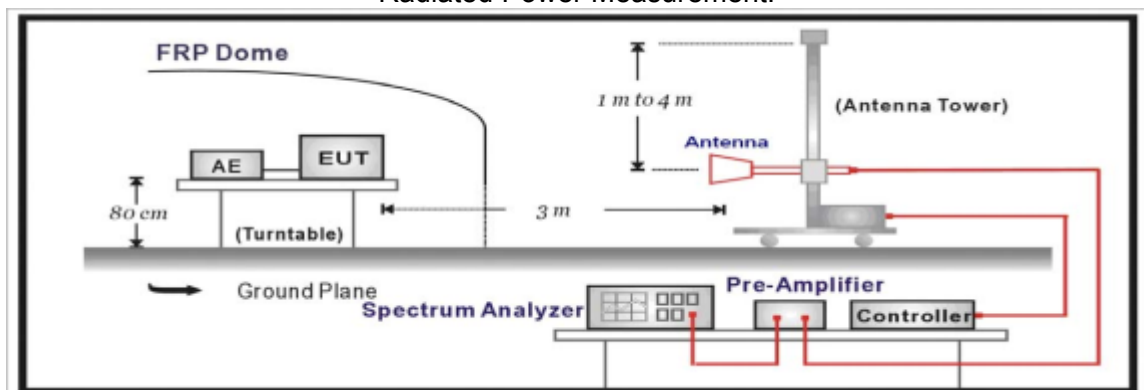

TEST PROCEDURE

The EUT was setup according to EIA/TIA 603D

Conducted Power Measurement:

- Place the EUT on a bench and set it in transmitting mode.
- Connect a low loss RF cable from the antenna port to a spectrum analyzer and CMW500 by a Directional Couple.
- EUT Communicate with CMW500, then select a channel for testing.
- Add a correction factor to the display of spectrum, and then test.

Radiated Power Measurement:

- The EUT shall be placed at the specified height on a support, and in the position closest to normal use as declared by provider.
- The test antenna shall be oriented initially for vertical polarization and shall be chosen to correspond to the frequency of the transmitter
- The output of the test antenna shall be connected to the measuring receiver.
- The transmitter shall be switched on and the measuring receiver shall be tuned to the frequency of the transmitter under test.
- The test antenna shall be raised and lowered through the specified range of height until a maximum signal level is detected by the measuring receiver.
- The transmitter shall then be rotated through 360° in the horizontal plane, until the maximum signal level is detected by the measuring receiver.



- g. The test antenna shall be raised and lowered again through the specified range of height until a maximum signal level is detected by the measuring receiver.
- h. The maximum signal level detected by the measuring receiver shall be noted.
- i. The transmitter shall be replaced by a substitution antenna.
- j. The substitution antenna shall be orientated for vertical polarization and the length of the substitution antenna shall be adjusted to correspond to the frequency of the transmitter.
- k. The substitution antenna shall be connected to a calibrated signal generator.
- l. If necessary, the input attenuator setting of the measuring receiver shall be adjusted in order to increase the sensitivity of the measuring receiver.
- m. The test antenna shall be raised and lowered through the specified range of height to ensure that the maximum signal is received.
- n. The input signal to the substitution antenna shall be adjusted to the level that produces a level detected by the measuring receiver, that is equal to the level noted while the transmitter radiated power was measured, corrected for the change of input attenuator setting of the measuring receiver.
- o. The measurement shall be repeated with the test antenna and the substitution antenna orientated for horizontal polarization.
- p. The measure of the effective radiated power is the larger of the two levels recorded at the input to the substitution antenna, corrected for gain of the substitution antenna if necessary.
- q. Test site anechoic chamber refer to ANSI C63.4.

TEST RESULTS

Conducted Measurement:

<i>LTE FDD Band 4</i>				
TX Channel Bandwidth	Frequency (MHz)	RB Size/Offset	Average Power [dBm]	
			QPSK	16QAM
1.4 MHz	1710.7	1 RB low	22.96	22.95
		1 RB high	22.95	22.94
		50% RB mid	23.01	22.98
		100% RB	21.96	21.01
	1732.5	1 RB low	22.86	21.90
		1 RB high	22.96	22.07
		50% RB mid	22.86	21.89
		100% RB	22.92	22.88
	1754.3	1 RB low	22.58	21.65
		1 RB high	22.68	21.83
		50% RB mid	22.60	21.65
		100% RB	22.64	22.62
3 MHz	1711.5	1 RB low	22.07	22.04
		1 RB high	21.99	22.01
		50% RB mid	22.04	22.04
		100% RB	21.90	20.95
	1732.5	1 RB low	22.81	22.02
		1 RB high	22.82	21.93
		50% RB mid	22.84	21.93
		100% RB	22.01	22.00
	1753.5	1 RB low	22.63	21.72
		1 RB high	22.63	21.66
		50% RB mid	22.62	21.68
		100% RB	21.72	21.71
5 MHz	1712.	1 RB low	21.88	21.90
		1 RB high	21.91	21.86
		50% RB mid	21.97	21.94
		100% RB	21.98	21.06
	1732.5	1 RB low	22.89	21.84
		1 RB high	22.98	21.88
		50% RB mid	22.82	21.79
		100% RB	21.91	21.91
	1752.5	1 RB low	22.61	21.74
		1 RB high	22.68	21.80
		50% RB mid	22.63	21.75
		100% RB	21.59	21.56



10 MHz	1715.0	1 RB low	21.95	21.96
		1 RB high	21.95	21.98
		50% RB mid	22.15	22.15
		100% RB	22.01	21.10
	1732.5	1 RB low	22.96	22.05
		1 RB high	22.97	22.10
		50% RB mid	22.80	21.95
		100% RB	21.99	22.01
	1750.0	1 RB low	22.65	21.79
		1 RB high	22.73	21.85
		50% RB mid	22.61	21.71
		100% RB	21.69	21.71
15 MHz	1717.5	1 RB low	22.03	22.01
		1 RB high	22.19	22.19
		50% RB mid	22.13	22.11
		100% RB	22.17	21.15
	1732.5	1 RB low	22.90	22.02
		1 RB high	22.89	22.01
		50% RB mid	22.68	21.82
		100% RB	22.00	22.00
	1747.5	1 RB low	22.68	21.92
		1 RB high	22.68	21.90
		50% RB mid	22.58	21.73
		100% RB	21.93	21.93
20 MHz	1720.0	1 RB low	23.24	21.92
		1 RB high	22.87	21.94
		50% RB mid	21.92	22.14
		100% RB	21.95	21.86
	1732.5	1 RB low	22.00	21.79
		1 RB high	21.99	22.08
		50% RB mid	21.79	21.57
		100% RB	21.87	21.98
	1745.0	1 RB low	22.66	21.75
		1 RB high	22.90	22.02
		50% RB mid	22.47	21.47
		100% RB	21.86	21.86

**Radiated Measurement:**

Remark:

1. We were tested all RB Configuration refer 3GPP TS136 521 for each Channel Bandwidth of LTE FDD Band 4; recorded worst case for each Channel Bandwidth of LTE FDD Band 4.
2. $EIRP = P_{Mea}(dBm) - P_{cl}(dB) + P_{Ag}(dB) + G_a(dBi)$

LTE FDD Band 4_Channel Bandwidth 1.4MHz_QPSK

Frequency (MHz)	P _{Mea} (dBm)	P _{cl} (dB)	G _a Antenna Gain(dB)	P _{Ag} (dB)	EIRP (dBm)	Limit (dBm)	Margin (dB)	Polarization
1710.7	-21.51	3.06	9.68	34.80	19.91	30.00	10.09	V
1732.5	-22.04	3.17	9.68	34.80	19.27	30.00	10.73	V
1754.3	-21.11	3.22	9.75	34.80	20.22	30.00	9.78	V

LTE FDD Band 4_Channel Bandwidth 3MHz_QPSK

Frequency (MHz)	P _{Mea} (dBm)	P _{cl} (dB)	G _a Antenna Gain(dB)	P _{Ag} (dB)	EIRP (dBm)	Limit (dBm)	Margin (dB)	Polarization
1711.5	-20.57	3.06	9.68	34.80	20.85	30.00	9.15	V
1732.5	-21.99	3.17	9.68	34.80	19.32	30.00	10.68	V
1753.5	-20.05	3.22	9.75	34.80	21.28	30.00	8.72	V

LTE FDD Band 4_Channel Bandwidth 5MHz_QPSK

Frequency (MHz)	P _{Mea} (dBm)	P _{cl} (dB)	G _a Antenna Gain(dB)	P _{Ag} (dB)	EIRP (dBm)	Limit (dBm)	Margin (dB)	Polarization
1712.5	-19.99	3.06	9.68	34.80	21.43	30.00	8.57	V
1732.5	-21.37	3.17	9.68	34.80	19.94	30.00	10.06	V
1752.5	-19.58	3.22	9.75	34.80	21.75	30.00	8.25	V

LTE FDD Band 4_Channel Bandwidth 10MHz_QPSK

Frequency (MHz)	P _{Mea} (dBm)	P _{cl} (dB)	G _a Antenna Gain(dB)	P _{Ag} (dB)	EIRP (dBm)	Limit (dBm)	Margin (dB)	Polarization
1715.0	-19.88	3.06	9.68	34.80	21.54	30.00	8.46	V
1732.5	-21.76	3.17	9.68	34.80	19.55	30.00	10.45	V
1750.0	-20.35	3.22	9.75	34.80	20.98	30.00	9.02	V

LTE FDD Band 4_Channel Bandwidth 15MHz_QPSK

Frequency (MHz)	P _{Mea} (dBm)	P _{cl} (dB)	G _a Antenna Gain(dB)	P _{Ag} (dB)	EIRP (dBm)	Limit (dBm)	Margin (dB)	Polarization
1717.5	-19.92	3.06	9.68	34.80	21.50	30.00	8.50	V
1732.5	-21.40	3.17	9.68	34.80	19.91	30.00	10.09	V
1747.5	-19.76	3.22	9.75	34.80	21.57	30.00	8.43	V

LTE FDD Band 4_Channel Bandwidth 20MHz_QPSK

Frequency (MHz)	P _{Mea} (dBm)	P _{cl} (dB)	G _a Antenna Gain(dB)	P _{Ag} (dB)	EIRP (dBm)	Limit (dBm)	Margin (dB)	Polarization
1720.0	-22.21	3.06	9.68	34.80	19.21	30.00	10.79	V
1732.5	-20.61	3.17	9.68	34.80	20.70	30.00	9.30	V
1745.0	-19.56	3.22	9.75	34.80	21.77	30.00	8.23	V

LTE FDD Band 4_Channel Bandwidth 1.4MHz_16QAM

Frequency (MHz)	P _{Mea} (dBm)	P _{cl} (dB)	G _a Antenna Gain(dB)	P _{Ag} (dB)	EIRP (dBm)	Limit (dBm)	Margin (dB)	Polarization
1710.7	-23.64	3.06	9.68	34.80	17.78	30.00	12.22	V
1732.5	-23.35	3.17	9.68	34.80	17.96	30.00	12.04	V
1754.3	-25.41	3.22	9.75	34.80	15.92	30.00	14.08	V

*LTE FDD Band 4_Channel Bandwidth 3MHz_16QAM*

Frequency (MHz)	P _{Mea} (dBm)	P _{cl} (dB)	G _a Antenna Gain(dB)	P _{Ag} (dB)	EIRP (dBm)	Limit (dBm)	Margin (dB)	Polarization
1711.5	-23.74	3.06	9.68	34.80	17.68	30.00	12.32	V
1732.5	-22.59	3.17	9.68	34.80	18.72	30.00	11.28	V
1753.5	-23.44	3.22	9.75	34.80	17.89	30.00	12.11	V

LTE FDD Band 4_Channel Bandwidth 5MHz_16QAM

Frequency (MHz)	P _{Mea} (dBm)	P _{cl} (dB)	G _a Antenna Gain(dB)	P _{Ag} (dB)	EIRP (dBm)	Limit (dBm)	Margin (dB)	Polarization
1712.5	-22.23	3.06	9.68	34.80	19.19	30.00	10.81	V
1732.5	-21.31	3.17	9.68	34.80	20.00	30.00	10.00	V
1752.5	-23.33	3.22	9.75	34.80	18.00	30.00	12.00	V

LTE FDD Band 4_Channel Bandwidth 10MHz_16QAM

Frequency (MHz)	P _{Mea} (dBm)	P _{cl} (dB)	G _a Antenna Gain(dB)	P _{Ag} (dB)	EIRP (dBm)	Limit (dBm)	Margin (dB)	Polarization
1715.0	-22.77	3.06	9.68	34.80	18.65	30.00	11.35	V
1732.5	-21.98	3.17	9.68	34.80	19.33	30.00	10.67	V
1750.0	-22.92	3.22	9.75	34.80	18.41	30.00	11.59	V

LTE FDD Band 4_Channel Bandwidth 15MHz_16QAM

Frequency (MHz)	P _{Mea} (dBm)	P _{cl} (dB)	G _a Antenna Gain(dB)	P _{Ag} (dB)	EIRP (dBm)	Limit (dBm)	Margin (dB)	Polarization
1717.5	-23.07	3.06	9.68	34.80	18.35	30.00	11.65	V
1732.5	-22.05	3.17	9.68	34.80	19.26	30.00	10.74	V
1747.5	-23.14	3.22	9.75	34.80	18.19	30.00	11.81	V

LTE FDD Band 4_Channel Bandwidth 20MHz_16QAM

Frequency (MHz)	P _{Mea} (dBm)	P _{cl} (dB)	G _a Antenna Gain(dB)	P _{Ag} (dB)	EIRP (dBm)	Limit (dBm)	Margin (dB)	Polarization
1720.0	-23.87	3.06	9.68	34.80	17.55	30.00	12.45	V
1732.5	-21.93	3.17	9.68	34.80	19.38	30.00	10.62	V
1745.0	-22.85	3.22	9.75	34.80	18.48	30.00	11.52	V



3.3 Peak-to-Average Ratio (PAR)

LIMIT

The Peak-to-Average Ratio (PAR) of the transmission may not exceed 13 dB.

TEST CONFIGURATION

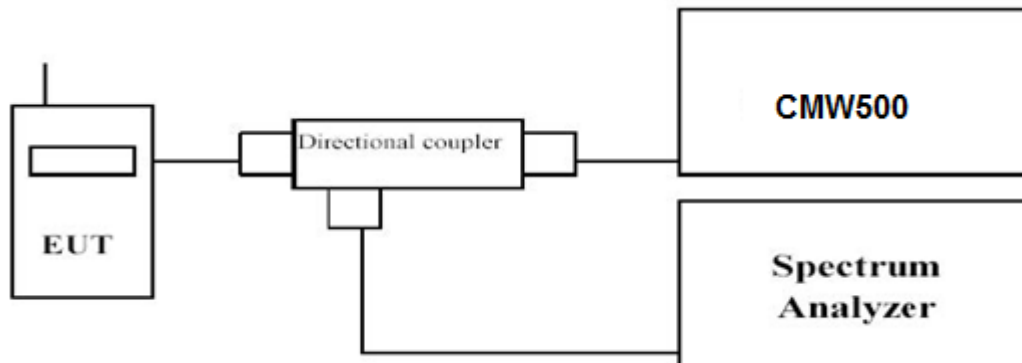

TEST PROCEDURE

1. Refer to instrument's analyzer instruction manual for details on how to use the power statistics/CCDF function;
2. Set resolution/measurement bandwidth \geq signal's occupied bandwidth;
3. Set the number of counts to a value that stabilizes the measured CCDF curve;
4. Set the measurement interval as follows:
 - 1). for continuous transmissions, set to 1 ms,
 - 2). for burst transmissions, employ an external trigger that is synchronized with the EUT burst timing sequence, or use the internal burst trigger with a trigger level that allows the burst to stabilize and set the measurement interval to a time that is less than or equal to the burst duration.
5. Record the maximum PAPR level associated with a probability of 0.1%.

TEST RESULTS

Remark:

1. We were tested all RB Configuration refer 3GPP TS136 521 for each Channel Bandwidth of LTE FDD Band 4; recorded worst case for each Channel Bandwidth of LTE FDD Band 4.

LTE FDD Band 4				
TX Channel Bandwidth	Frequency (MHz)	RB Size/Offset	PAPR (dB)	
			QPSK	16QAM
1.4 MHz	1710.7	1RB#0	4.89	5.81
	1732.5		4.49	5.21
	1754.3		3.64	4.54
3 MHz	1711.5	1RB#0	4.74	5.60
	1732.5		4.25	5.07
	1753.5		3.66	4.44
5 MHz	1712.5	1RB#0	5.00	5.49
	1732.5		4.43	5.08
	1752.5		4.02	4.74
10 MHz	1715.0	1RB#0	4.82	5.69
	1732.5		4.16	5.02
	1750.0		4.28	5.16
15 MHz	1717.5	1RB#0	4.79	5.61
	1732.5		4.05	4.93
	1747.5		4.58	5.39
20 MHz	1720.0	1RB#0	4.65	5.19
	1732.5		4.28	5.36
	1745.0		4.53	5.39



LTE FDD Band 4-1.4MHz Channel Bandwidth PAPR

QPSK

16QAM

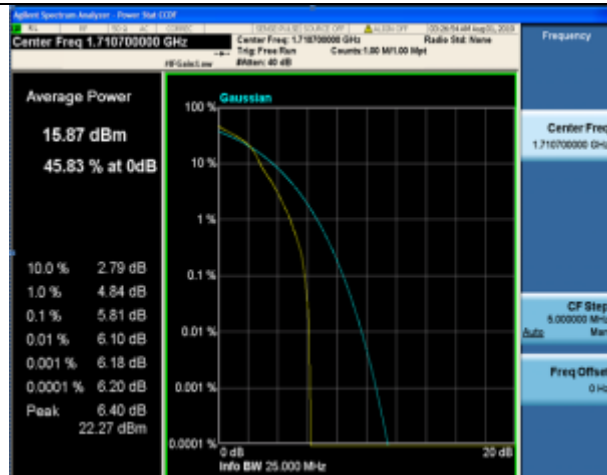
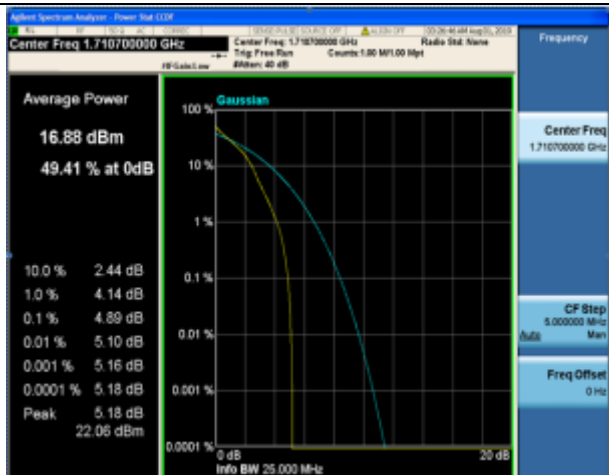

1RB#0

1RB#0

Low Channel



1RB#0

1RB#0

Middle Channel



1RB#0

1RB#0

High Channel



LTE FDD Band 4-3MHz Channel Bandwidth PAPR

QPSK

16QAM



1RB#0

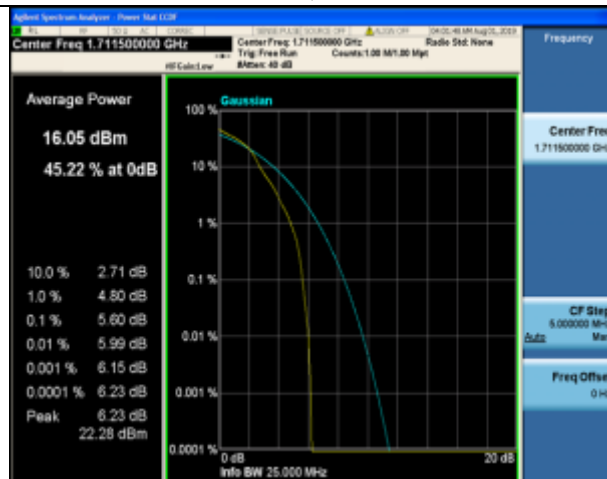

1RB#0

Low Channel

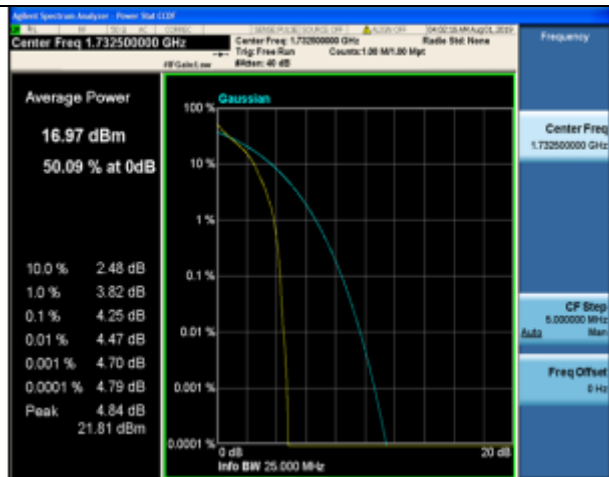

1RB#0



1RB#0

Middle Channel



1RB#0

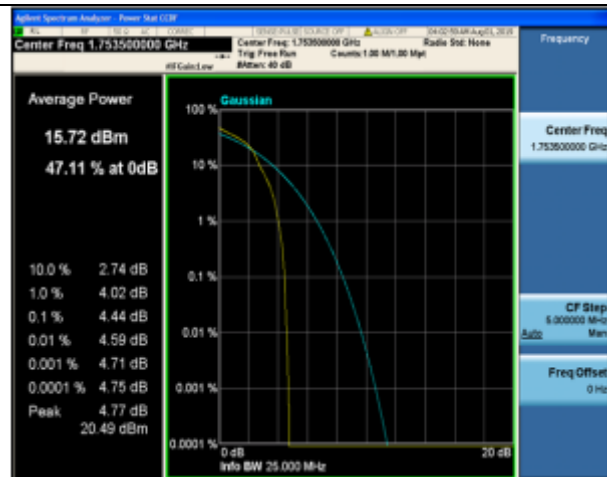

1RB#0

High Channel



LTE FDD Band 4-5MHz Channel Bandwidth PAPR

QPSK

16QAM

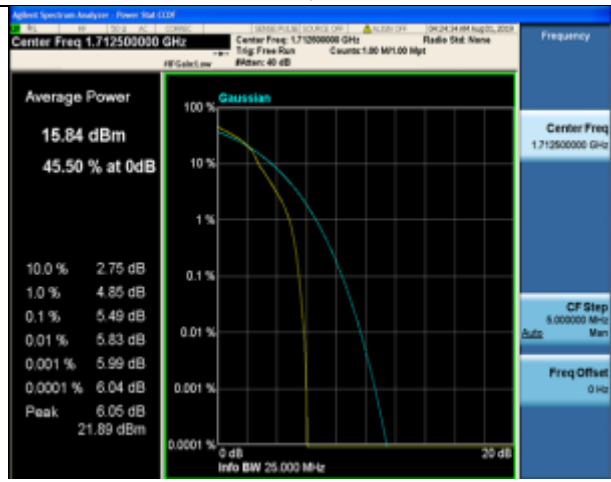
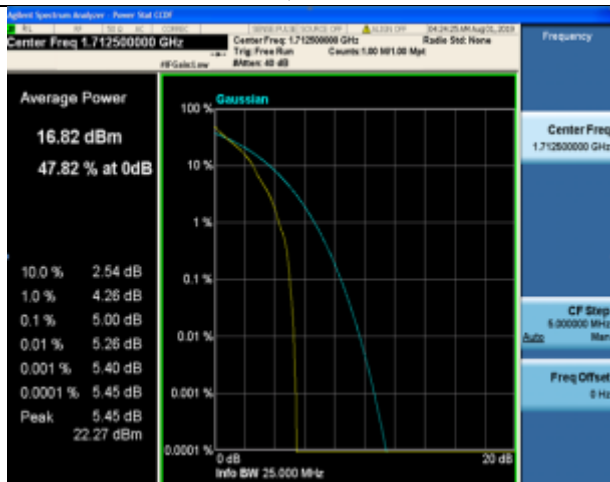

1RB#0

1RB#0

Low Channel

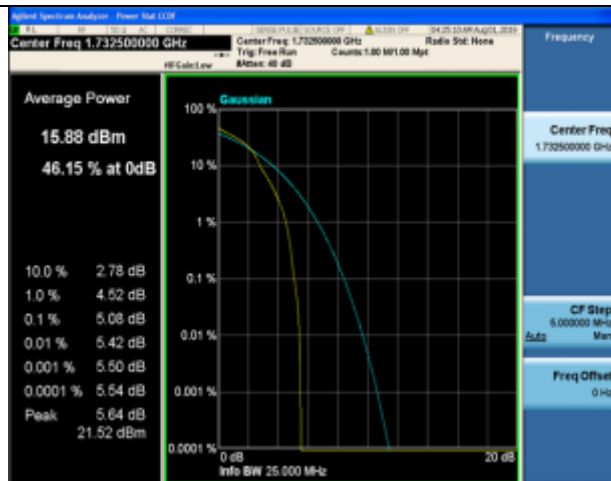

1RB#0

1RB#0

Middle Channel

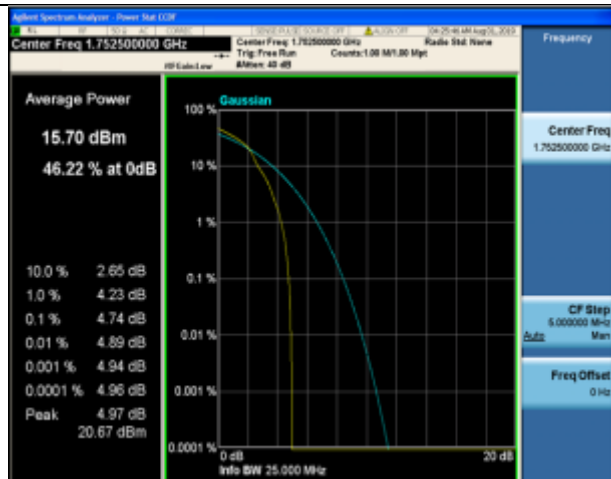
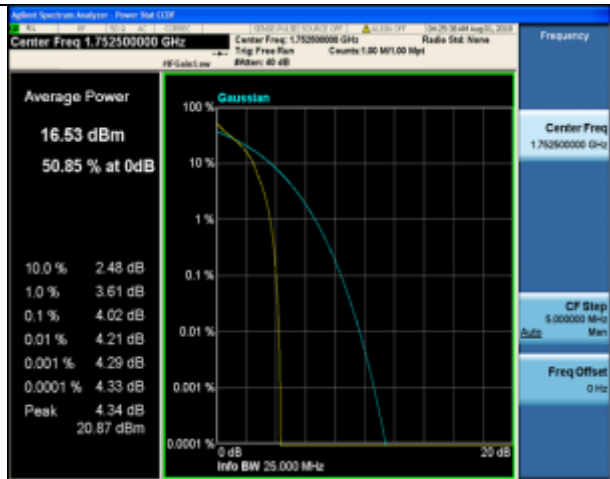

1RB#0

1RB#0

High Channel



LTE FDD Band 4-10MHz Channel Bandwidth PAPR

QPSK

16QAM

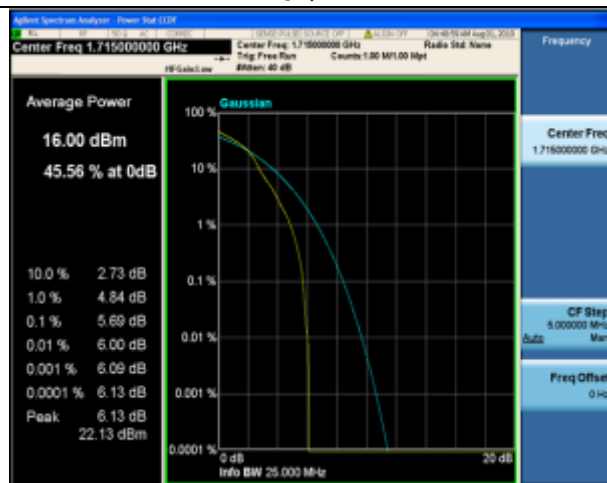

1RB#0

1RB#0

Low Channel



1RB#0

1RB#0

Middle Channel

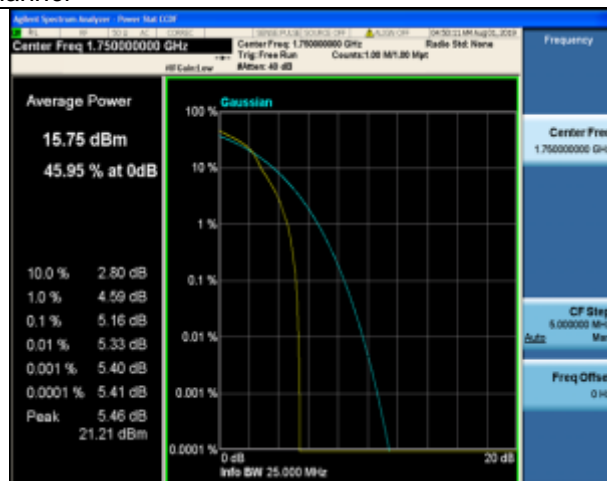

1RB#0

1RB#0

High Channel



LTE FDD Band 4-15MHz Channel Bandwidth PAPR

QPSK

16QAM



1RB#0

1RB#0

Low Channel

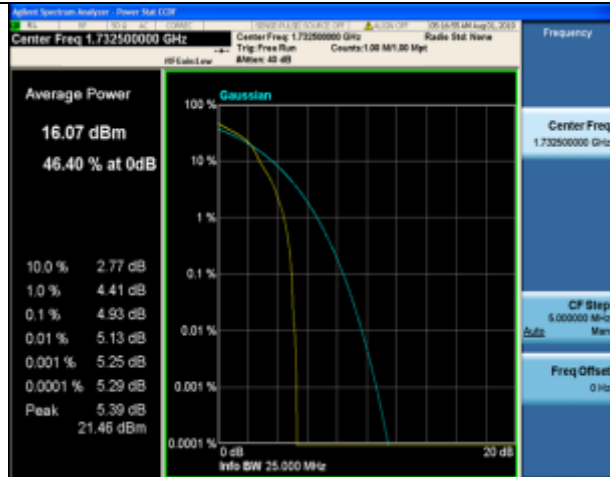
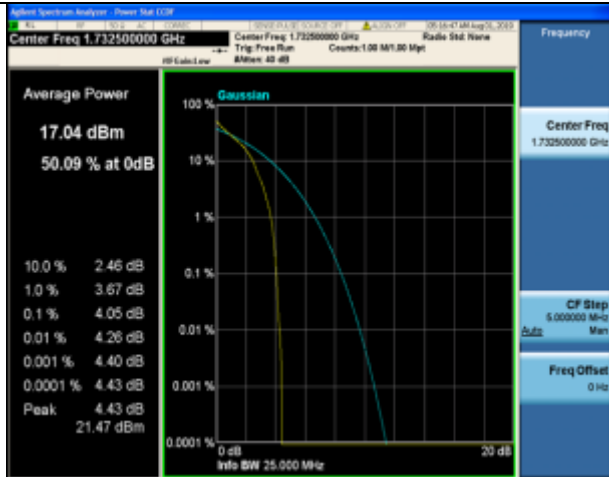

1RB#0

1RB#0

Middle Channel

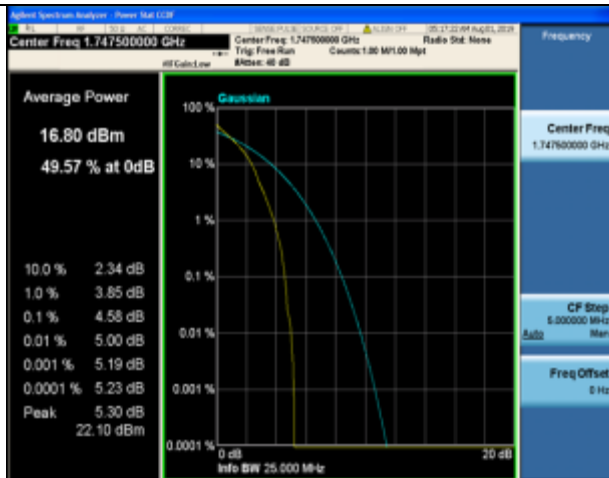

1RB#0

1RB#0

High Channel



LTE FDD Band 4-20MHz Channel Bandwidth PAPR

QPSK

16QAM

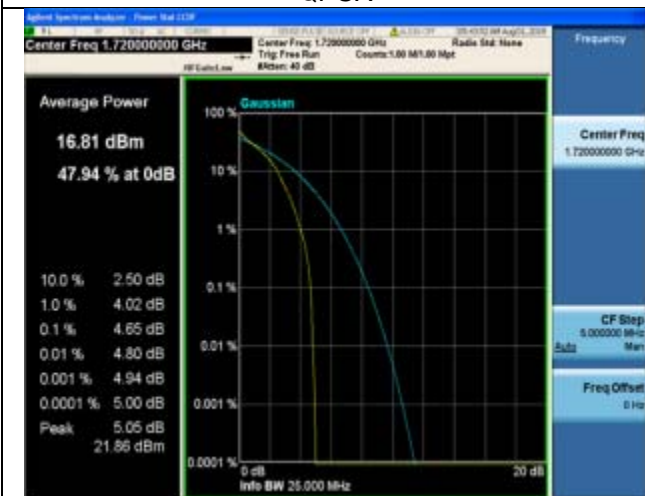

1RB#0

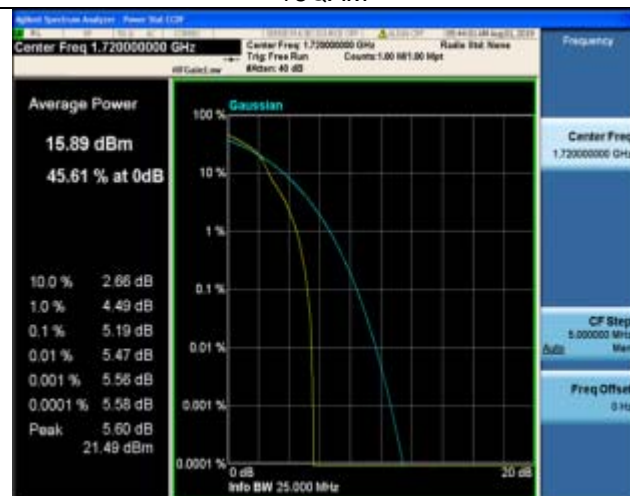

1RB#0

Low Channel

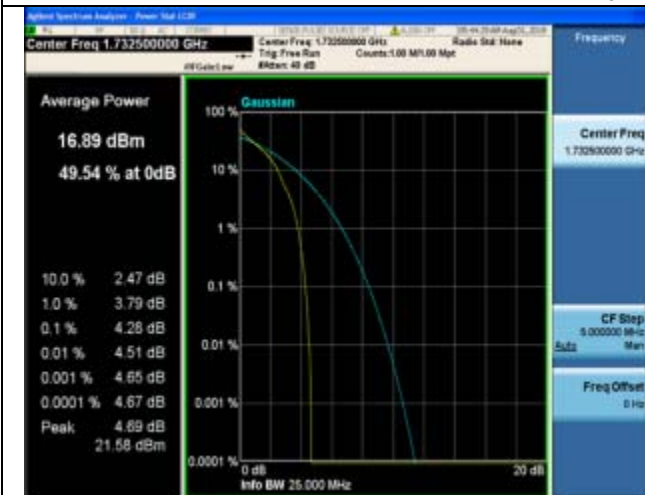

1RB#0



1RB#0

Middle Channel

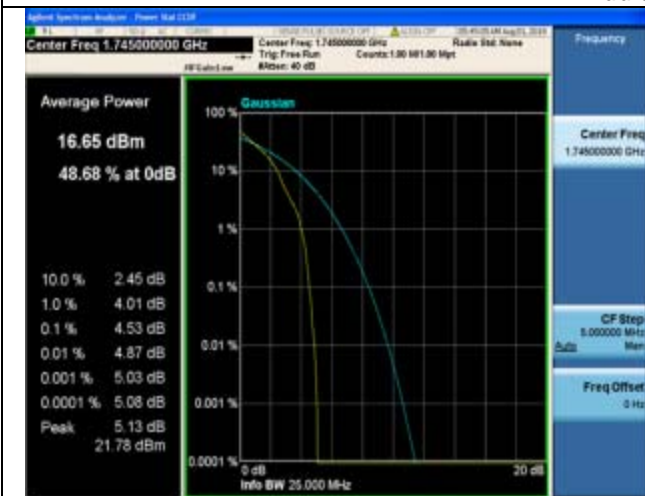

1RB#0



1RB#0

High Channel



3.4 Occupied Bandwidth and Emission Bandwidth

LIMIT

N/A

TEST CONFIGURATION

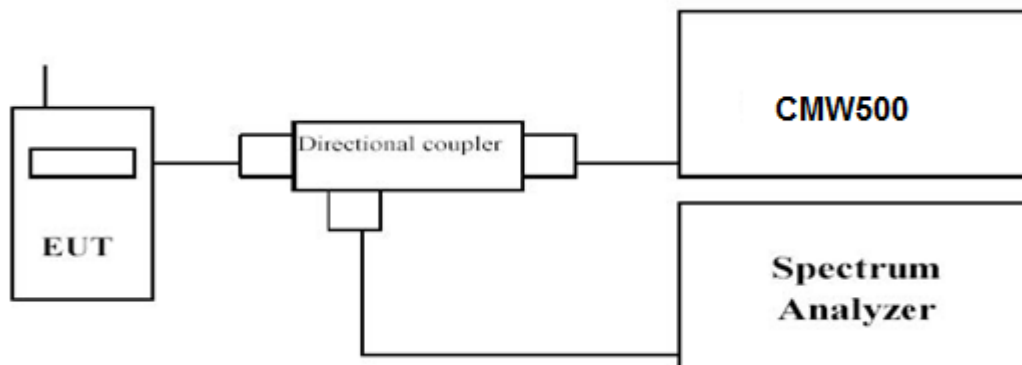

TEST PROCEDURE

The transmitter output was connected to a calibrated coaxial cable and coupler, the other end of which was connected to a spectrum analyzer. The occupied bandwidth was measured with the spectrum analyzer at low, middle and high channel in each band. The -26dBc Emission bandwidth was also measured and recorded. Set RBW was set to about 1% of emission BW, VBW≥3 times RBW. -26dBc display line was placed on the screen (or 99% bandwidth), the occupied bandwidth is the delta frequency between the two points where the display line intersects the signal trace.

TEST RESULTS

Remark:

1. We were tested all RB Configuration refer 3GPP TS136 521 for each Channel Bandwidth of LTE FDD Band 4; recorded worst case for each Channel Bandwidth of LTE FDD Band 4.

LTE FDD Band 4						
TX Channel Bandwidth	RB Size/Offset	Frequency (MHz)	-26dBc Emission bandwidth (MHz)		99% Occupied bandwidth (MHz)	
			QPSK	16QAM	QPSK	16QAM
1.4 MHz	6RB#0	1710.7	1.253	1.270	1.0881	1.0895
		1732.5	1.253	1.260	1.0946	1.0872
		1754.3	1.262	1.229	1.0887	1.0864
3 MHz	15RB#0	1711.5	2.860	2.857	2.6881	2.6905
		1732.5	2.850	2.861	2.6890	2.6882
		1753.5	2.861	2.855	2.6925	2.6908
5 MHz	25RB#0	1712.5	4.991	4.982	4.5047	4.5062
		1732.5	4.987	4.953	4.5023	4.5037
		1752.5	5.011	5.031	4.5032	4.5111
10 MHz	50RB#0	1715.0	9.619	9.590	8.9905	8.9744
		1732.5	9.565	9.621	8.9877	8.9885
		1750.0	9.582	9.565	8.9934	8.9913
15 MHz	75RB#0	1717.5	14.35	14.31	13.488	13.470
		1732.5	14.34	14.31	13.465	13.469
		1747.5	14.32	14.31	13.492	13.484
20 MHz	100RB#0	1720.0	18.97	18.99	17.939	17.945
		1732.5	18.95	18.98	17.948	17.944
		1745.0	19.05	19.03	17.972	18.002



LTE FDD Band 4-1.4MHz Channel Bandwidth

QPSK

16QAM

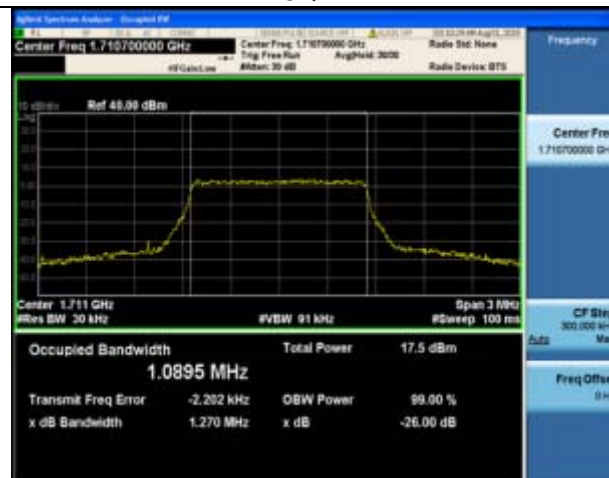
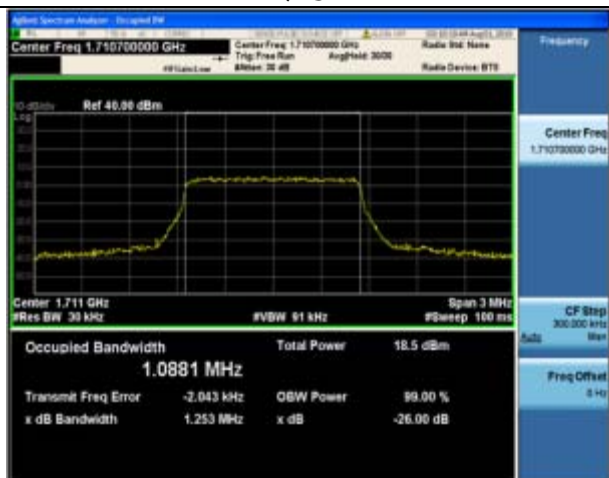

6RB#0

6RB#0

Low Channel



6RB#0

6RB#0

Middle Channel

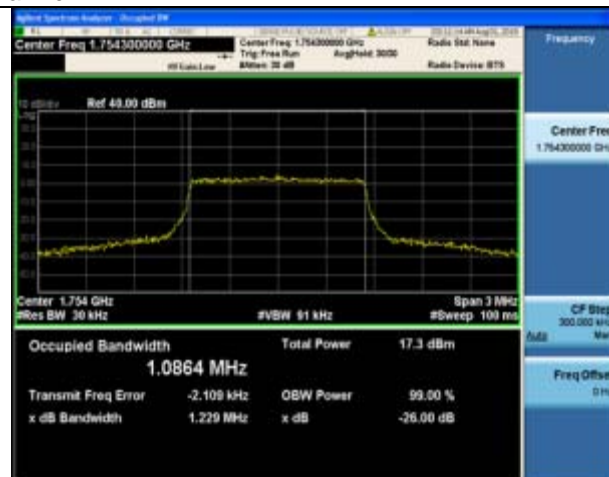
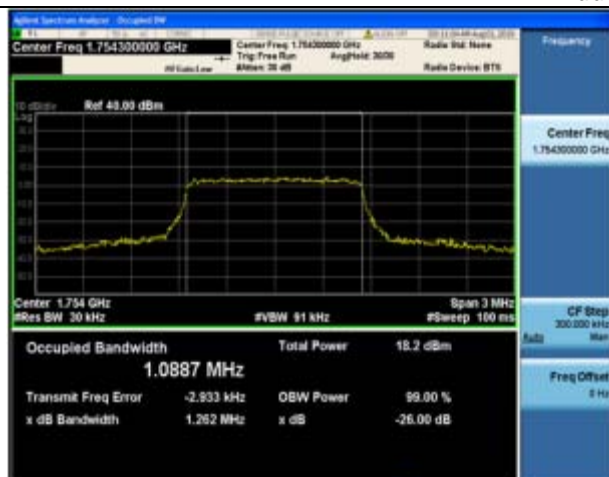

6RB#0

6RB#0

High Channel



LTE FDD Band 4-3MHz Channel Bandwidth

QPSK

16QAM

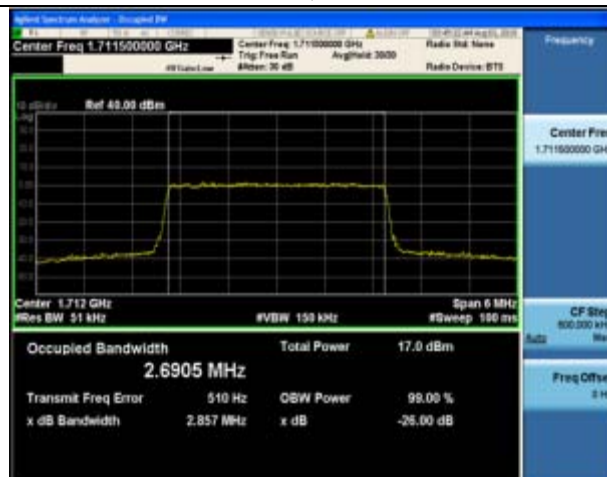
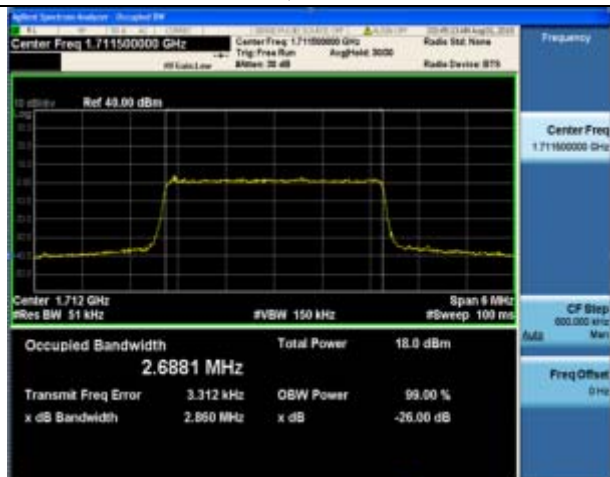

15RB#0

15RB#0

Low Channel



15RB#0

15RB#0

Middle Channel



15RB#0

15RB#0

High Channel



LTE FDD Band 4-5MHz Channel Bandwidth

QPSK

16QAM



25RB#0

25RB#0

Low Channel

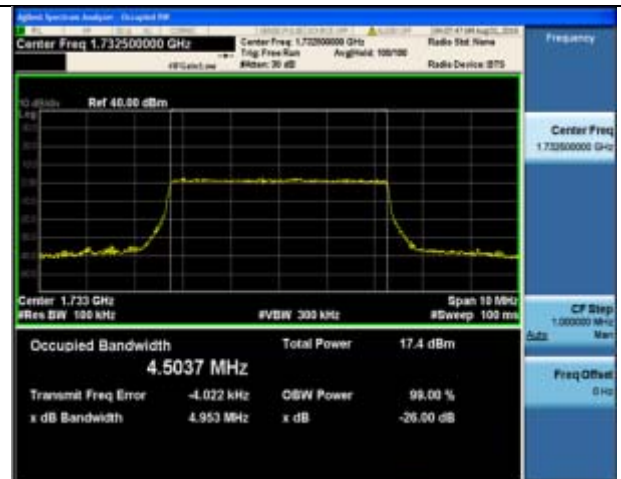

25RB#0

25RB#0

Middle Channel

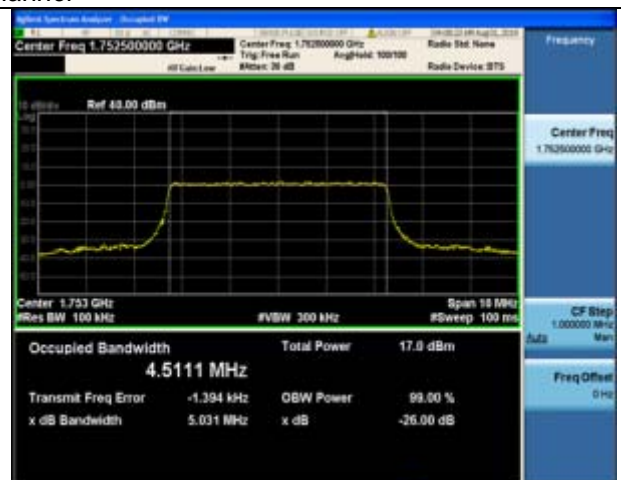

25RB#0

25RB#0

High Channel



LTE FDD Band 4-10MHz Channel Bandwidth

QPSK

16QAM



50RB#0

50RB#0

Low Channel

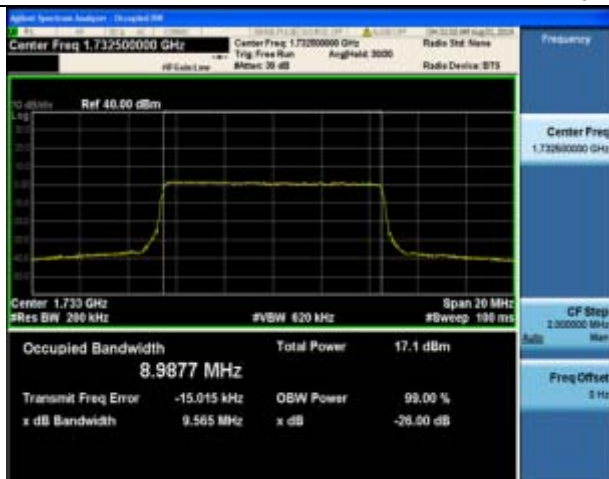

50RB#0

50RB#0

Middle Channel

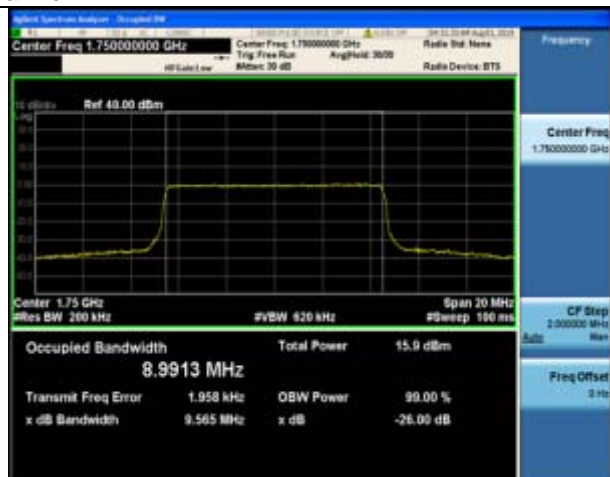

50RB#0

50RB#0

High Channel



LTE FDD Band 4-15MHz Channel Bandwidth

QPSK

16QAM

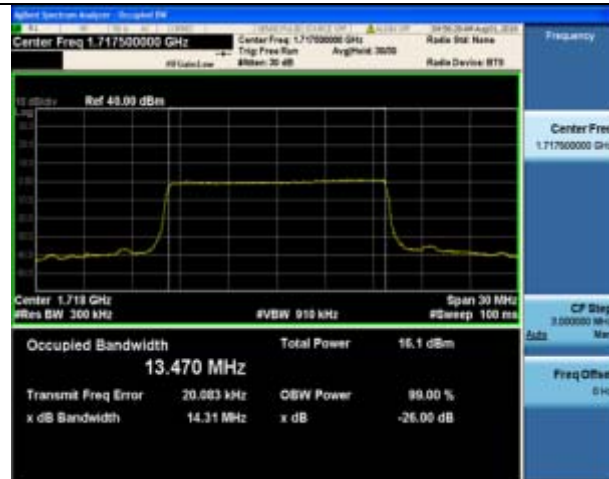

75RB#0

75RB#0

Low Channel

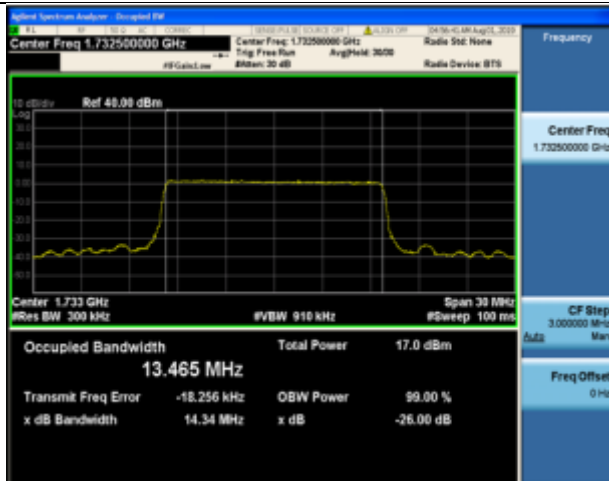

75RB#0

75RB#0

Middle Channel

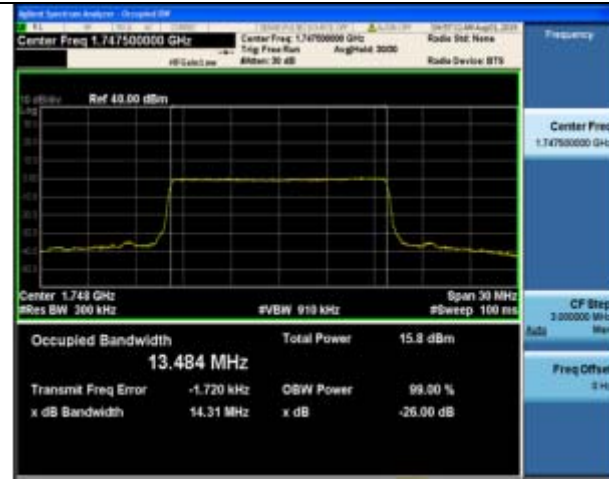
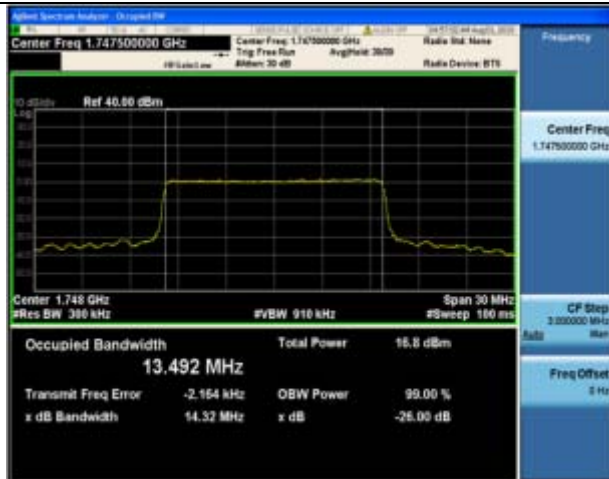

75RB#0

75RB#0

High Channel



LTE FDD Band 4-20MHz Channel Bandwidth

QPSK

16QAM

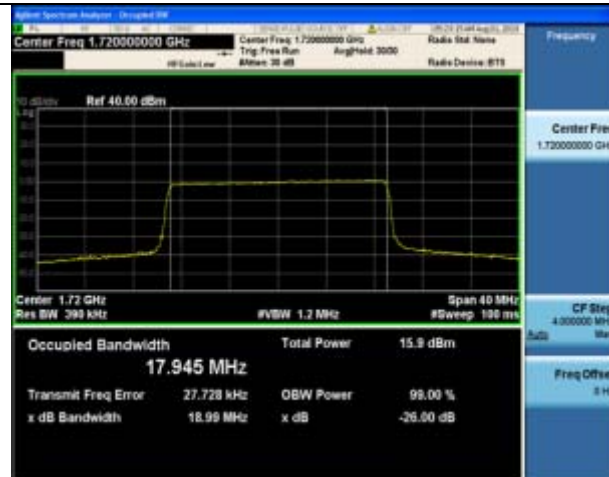

100RB#0

100RB#0

Low Channel

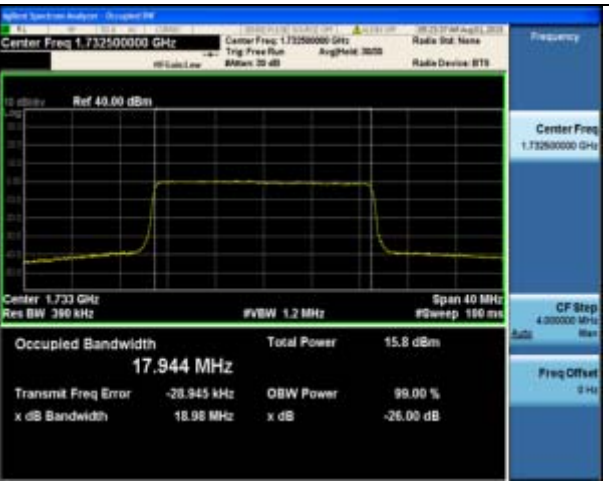

100RB#0

100RB#0

Middle Channel



100RB#0

100RB#0

High Channel



3.5 Band Edge compliance

LIMIT

According to §27.53 (h): For operations in the 1710–1755 MHz and 2110–2155 MHz bands, the power of any emission outside a licensee's frequency block shall be attenuated below the transmitter power (P) by at least $43 + 10 \log_{10}(P)$ dB.

TEST CONFIGURATION

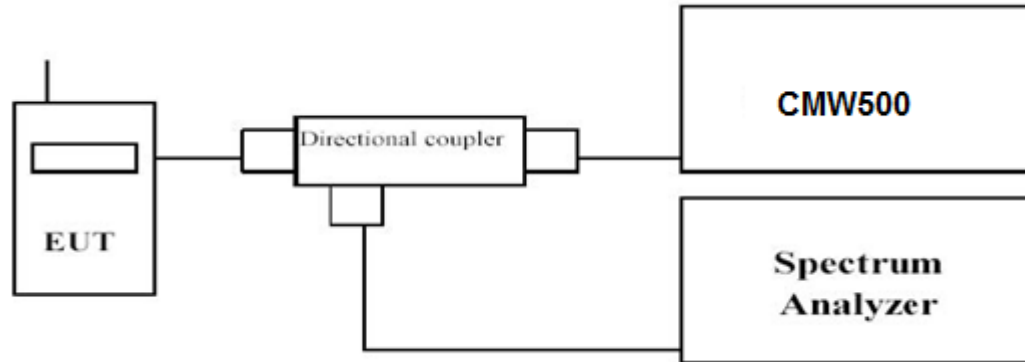

TEST PROCEDURE

1. The transmitter output port was connected to base station.
2. The RF output of EUT was connected to the power meter by RF cable and attenuator, the path loss was compensated to the results for each measurement.
3. Set EUT at maximum power through base station.
4. Select lowest and highest channels for each band and different modulation.
5. Measure Band edge using RMS (Average) detector by spectrum

TEST RESULTS

Remark:

1. We were tested all RB Configuration refer 3GPP TS136 521 for each Channel Bandwidth of LTE FDD Band 4; recorded worst case for each Channel Bandwidth of LTE FDD Band 4.



LTE FDD Band 4-1.4MHz Channel Bandwidth Band Edge Compliance

QPSK

16QAM

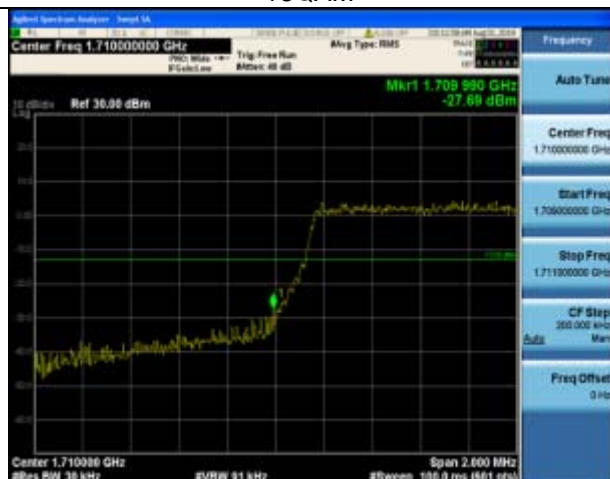
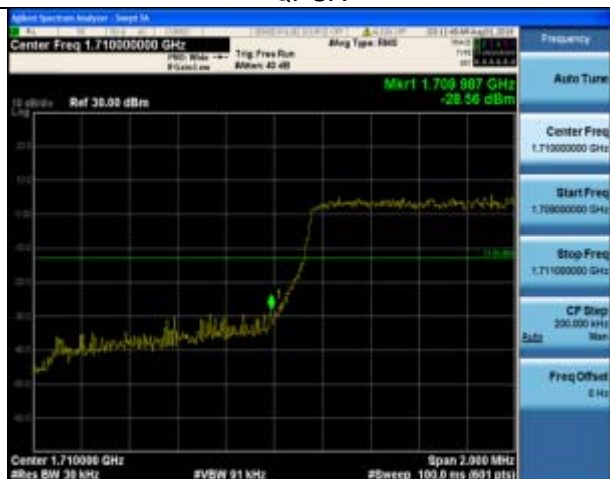

6RB#0

6RB#0

Low Channel

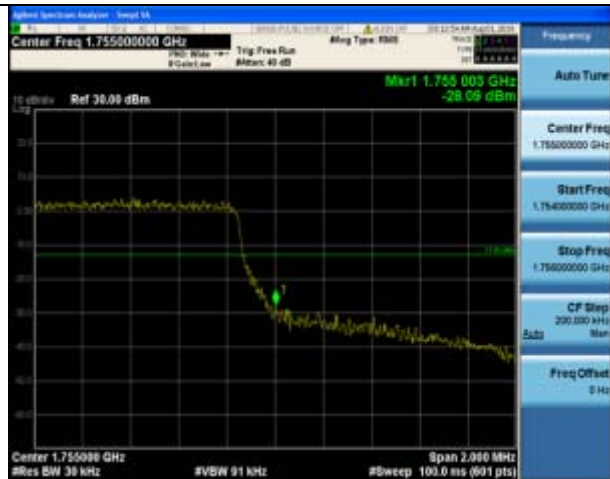
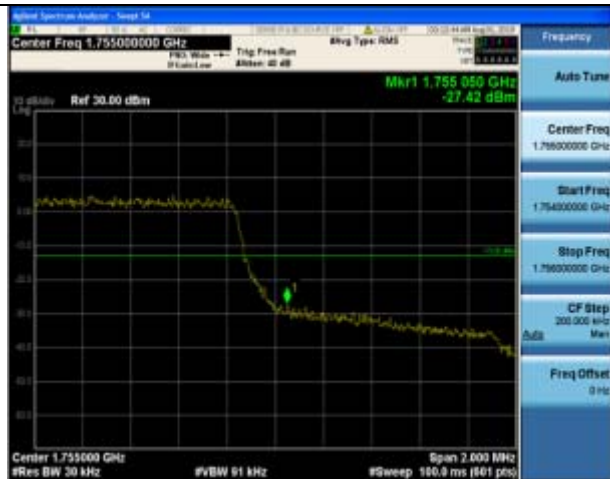

6RB#0

6RB#0

High Channel



LTE FDD Band 4-3MHz Channel Bandwidth Band Edge Compliance

QPSK

16QAM



15RB#0

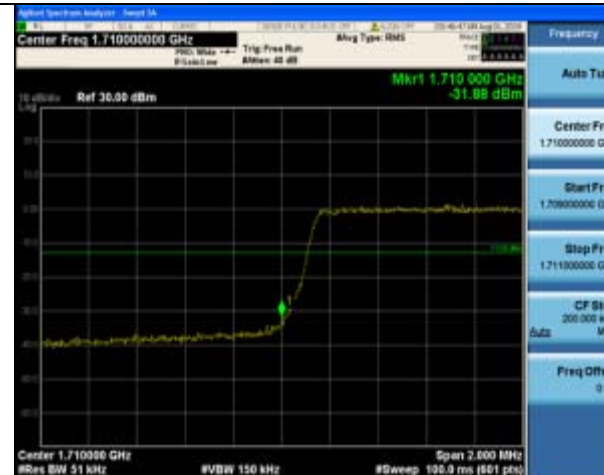

15RB#0

Low Channel

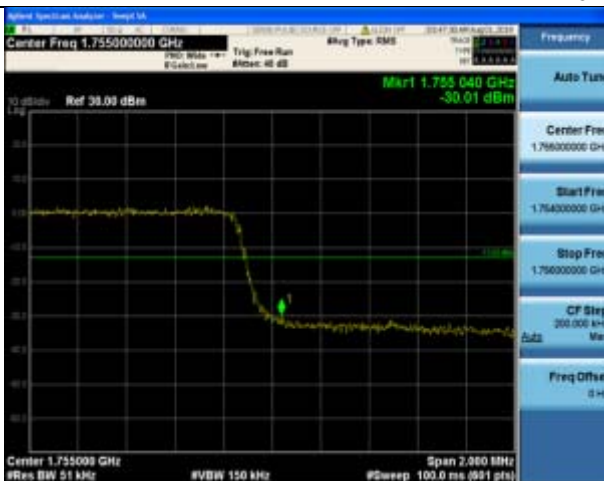

15RB#0

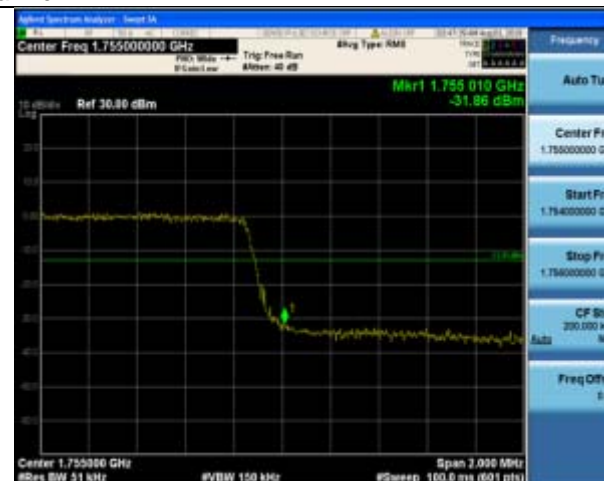

15RB#0

High Channel



LTE FDD Band 4-5MHz Channel Bandwidth Band Edge Compliance

QPSK

16QAM

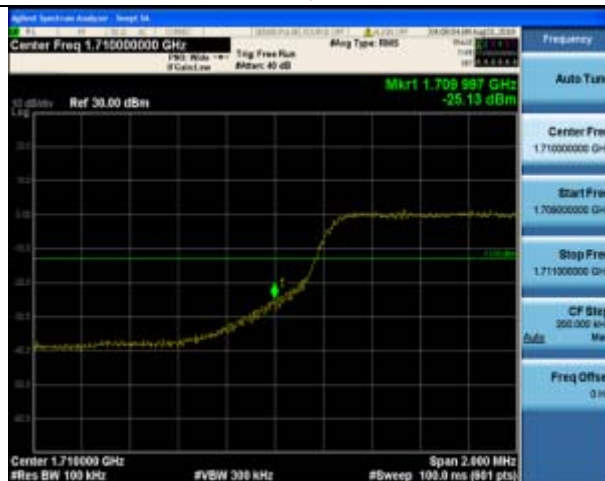
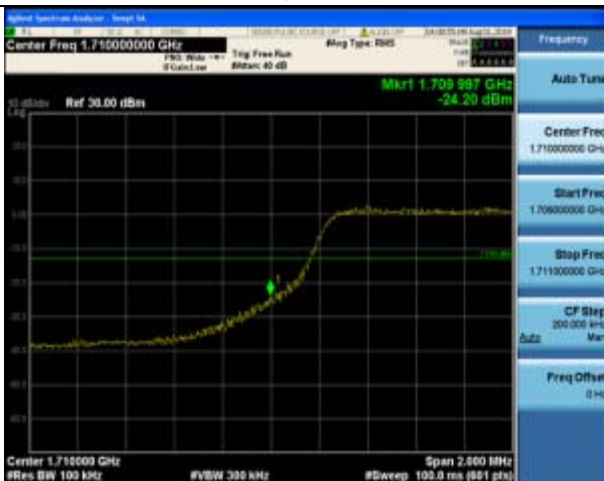

25RB#0

25RB#0

Low Channel

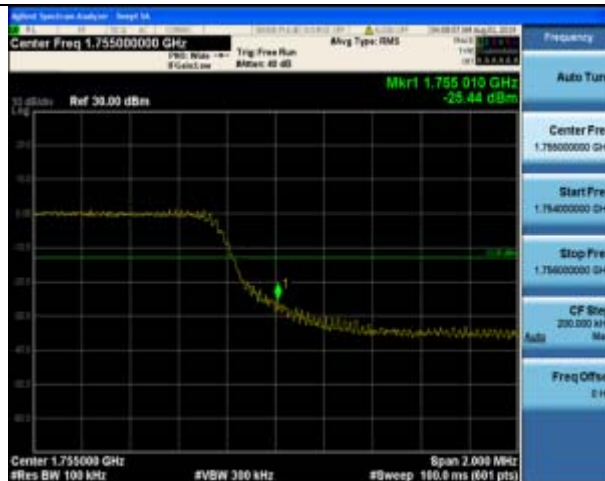

25RB#0

25RB#0

High Channel



LTE FDD Band 4-10MHz Channel Bandwidth Band Edge Compliance

QPSK

16QAM

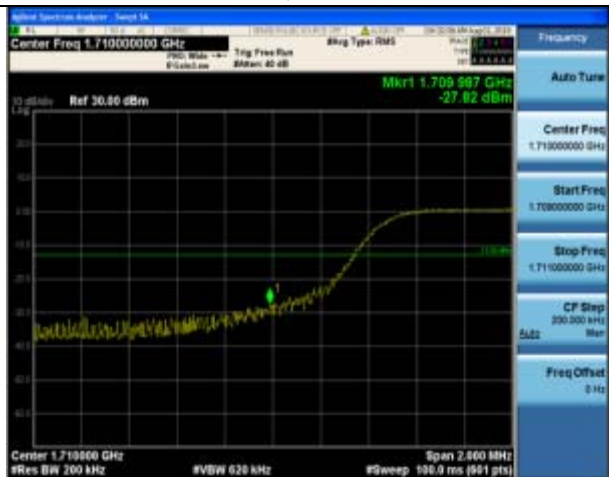

50RB#0

50RB#0

Low Channel



50RB#0

50RB#0

High Channel



LTE FDD Band 4-15MHz Channel Bandwidth Band Edge Compliance

QPSK

16QAM

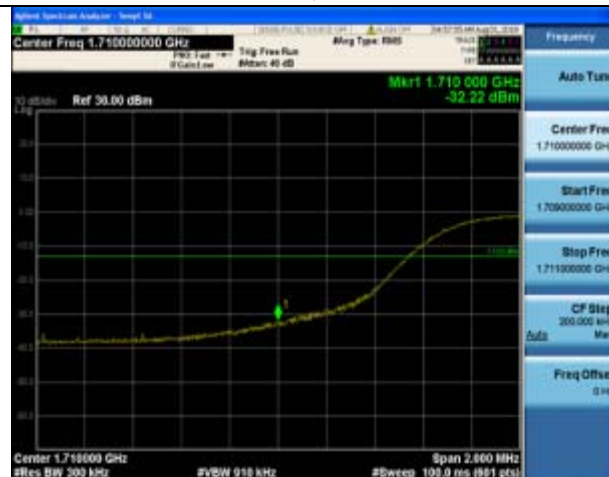

75RB#0

75RB#0

Low Channel



75RB#0

75RB#0

High Channel



LTE FDD Band 4-20MHz Channel Bandwidth Band Edge Compliance

QPSK

16QAM



100RB#0

100RB#0

Low Channel

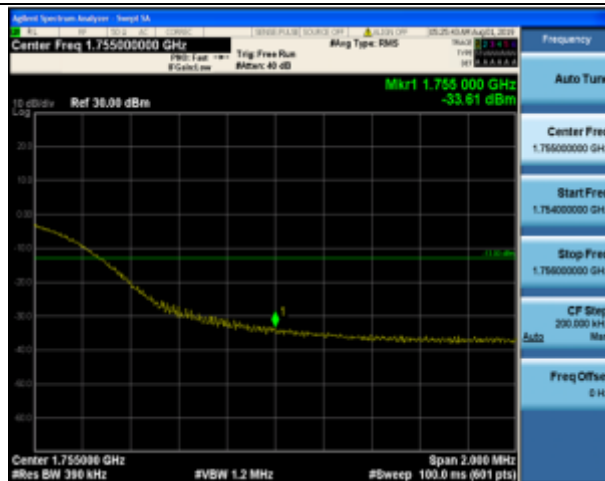
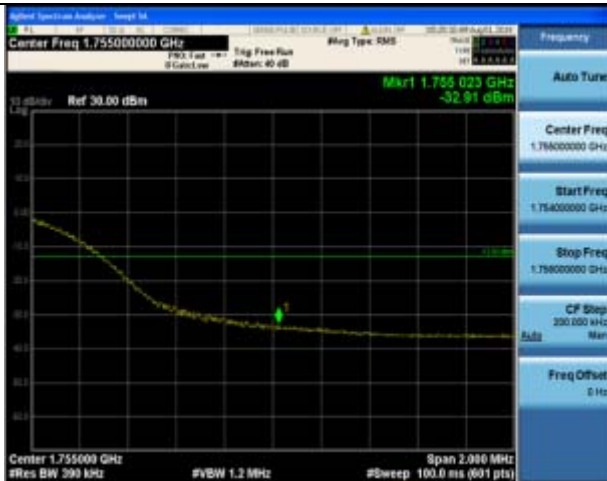

100RB#0

100RB#0

High Channel

3.6 Spurious Emission

LIMIT

According to §27.53 (h): For operations in the 1710–1755 MHz and 2110–2155 MHz bands, the power of any emission outside a licensee’s frequency block shall be attenuated below the transmitter power (P) by at least $43 + 10 \log_{10}(P)$ dB.

TEST CONFIGURATION

Conducted Spurious Measurement:

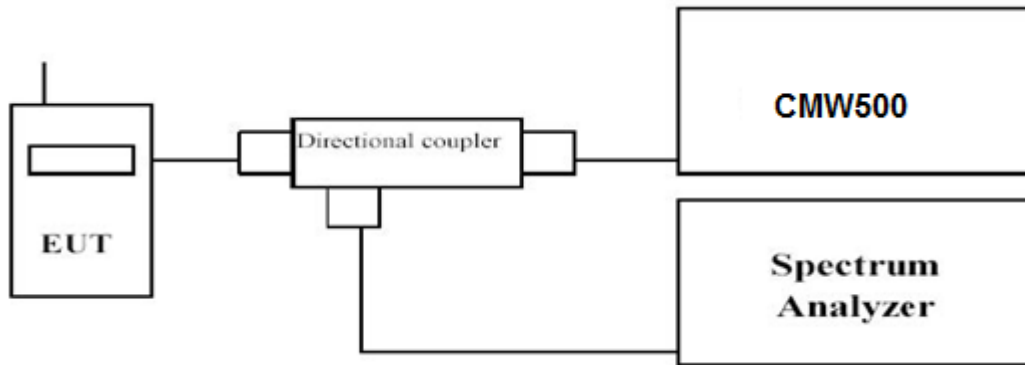

Radiated Spurious Measurement:

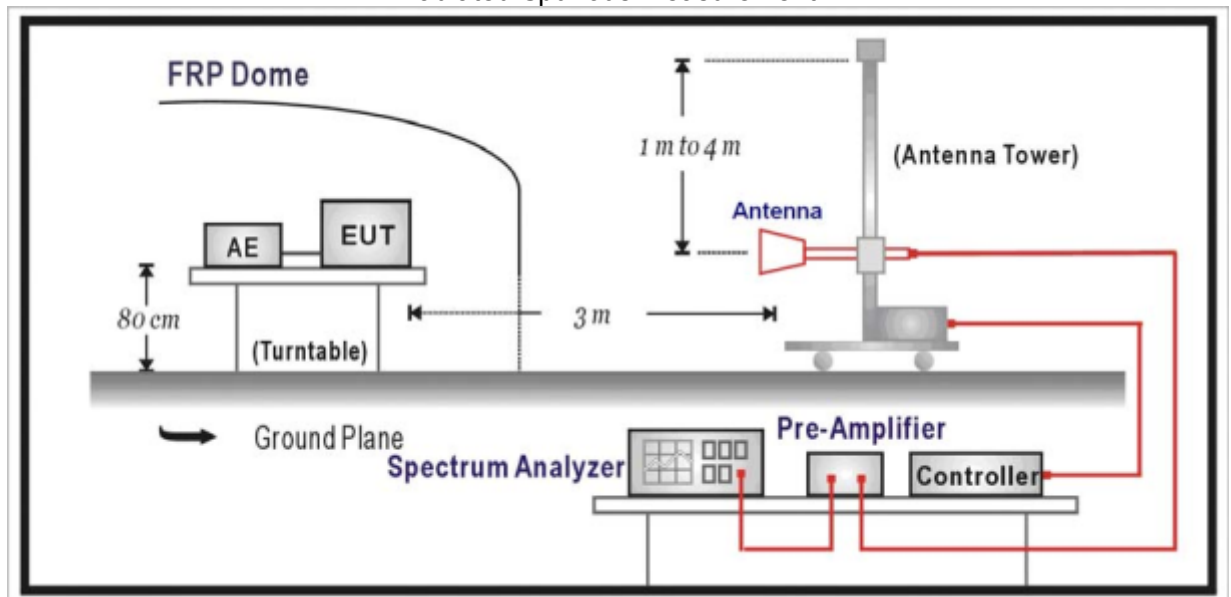

TEST PROCEDURE

The EUT was setup according to EIA/TIA 603D

Conducted Spurious Measurement:

- Place the EUT on a bench and set it in transmitting mode.
- Connect a low loss RF cable from the antenna port to a spectrum analyzer and CMW500 by a Directional Couple.
- EUT Communicate with CMW500, then select a channel for testing.
- Add a correction factor to the display of spectrum, and then test.
- The resolution bandwidth of the spectrum analyzer was set sufficient scans were taken to show the out of band Emission if any up to 10th harmonic.
- Please refer to following tables for test antenna conducted emissions.

Working Frequency	Sub range (GHz)	RBW	VBW	Sweep time (s)
LTE FDD Band 4	0.000009~0.000015	1KHz	3KHz	Auto
	0.000015~0.03	10KHz	30KHz	Auto
	0.03~26.5	1 MHz	3 MHz	Auto

**Radiated Spurious Measurement:**

- a. The EUT shall be placed at the specified height on a support, and in the position closest to normal use as declared by provider.
- b. The test antenna shall be oriented initially for vertical polarization and shall be chosen to correspond to the frequency of the transmitter
- c. The output of the test antenna shall be connected to the measuring receiver.
- d. The transmitter shall be switched on and the measuring receiver shall be tuned to the frequency of the transmitter under test.
- e. The test antenna shall be raised and lowered through the specified range of height until a maximum signal level is detected by the measuring receiver.
- f. The transmitter shall then be rotated through 360° in the horizontal plane, until the maximum signal level is detected by the measuring receiver.
- g. The test antenna shall be raised and lowered again through the specified range of height until a maximum signal level is detected by the measuring receiver.
- h. The maximum signal level detected by the measuring receiver shall be noted.
- i. The transmitter shall be replaced by a substitution antenna.
- j. The substitution antenna shall be orientated for vertical polarization and the length of the substitution antenna shall be adjusted to correspond to the frequency of the transmitter.
- k. The substitution antenna shall be connected to a calibrated signal generator.
- l. If necessary, the input attenuator setting of the measuring receiver shall be adjusted in order to increase the sensitivity of the measuring receiver.
- m. The test antenna shall be raised and lowered through the specified range of height to ensure that the maximum signal is received.
- n. The input signal to the substitution antenna shall be adjusted to the level that produces a level detected by the measuring receiver, that is equal to the level noted while the transmitter radiated power was measured, corrected for the change of input attenuator setting of the measuring receiver.
- o. The measurement shall be repeated with the test antenna and the substitution antenna orientated for horizontal polarization.
- p. The measure of the effective radiated power is the larger of the two levels recorded at the input to the substitution antenna, corrected for gain of the substitution antenna if necessary.
- q. The resolution bandwidth of the spectrum analyzer was set at 100 kHz for Part 22 and 1MHz for Part 24. The frequency range was checked up to 10th harmonic.
- r. Test site anechoic chamber refer to ANSI C63.

TEST RESULTS*Remark:*

1. *We were tested all RB Configuration refer 3GPP TS136 521 for each Channel Bandwidth of LTE FDD Band 4; recorded worst case for each Channel Bandwidth of LTE FDD Band 4.*

Conducted Measurement:



LTE FDD Band 4-1.4MHz Channel Bandwidth

Low Channel

QPSK

16QAM

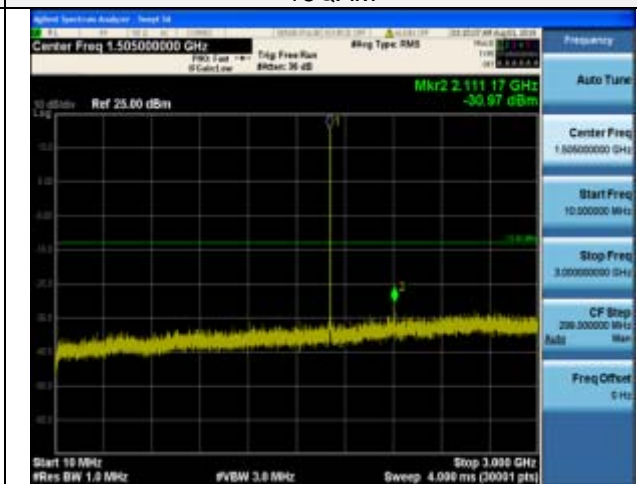
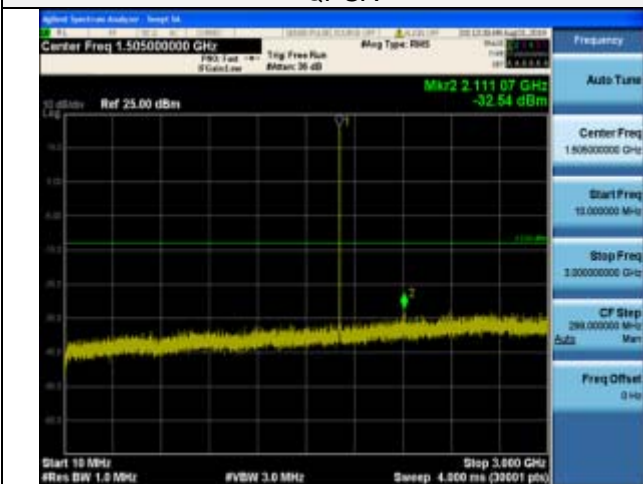

10MHz~3GHz

10MHz~3GHz

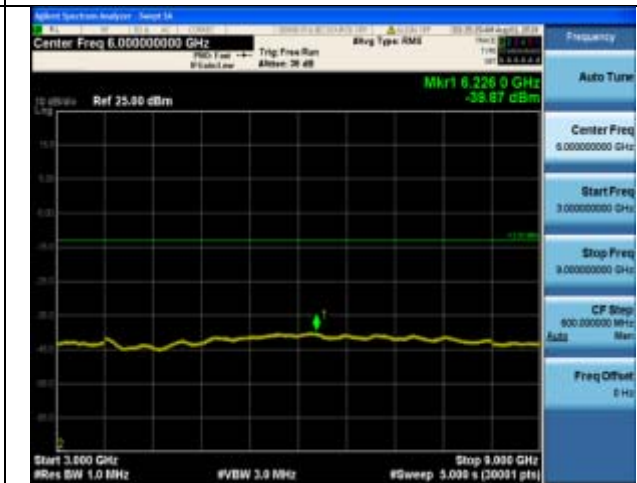
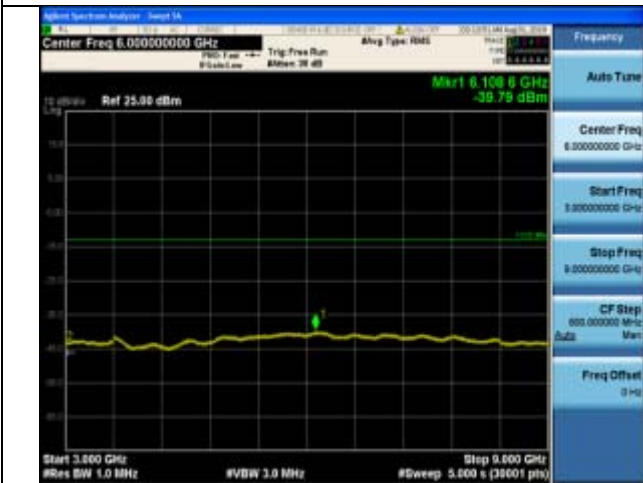

3GHz ~9GHz

3GHz ~9GHz



9GHz ~15GHz

9GHz ~15GHz

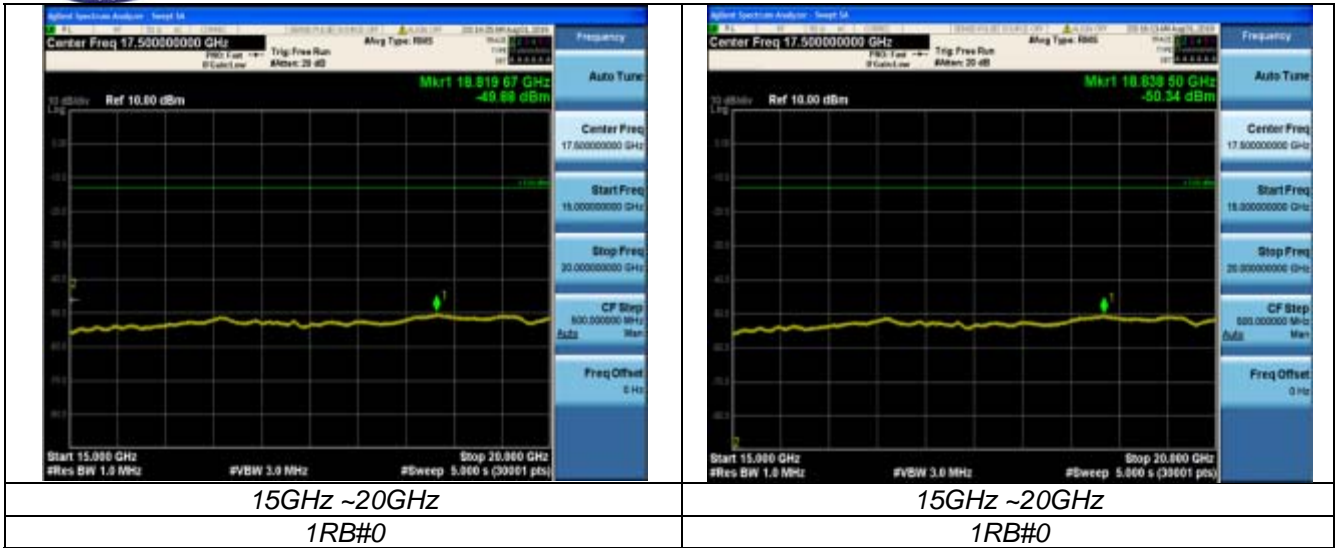

*LTE FDD Band 4-1.4MHz Channel Bandwidth
Middle Channel*

QPSK

16QAM

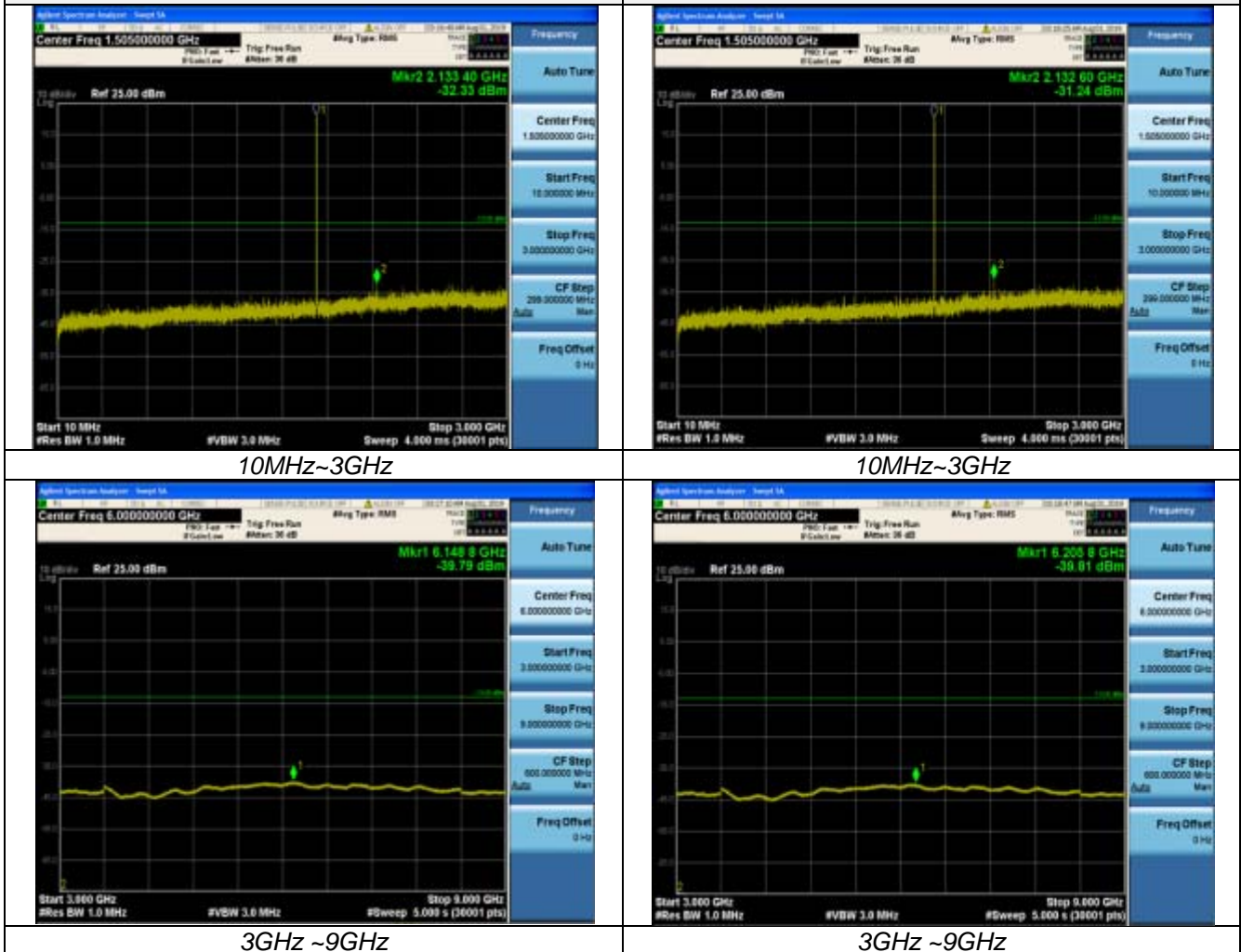



9GHz ~15GHz

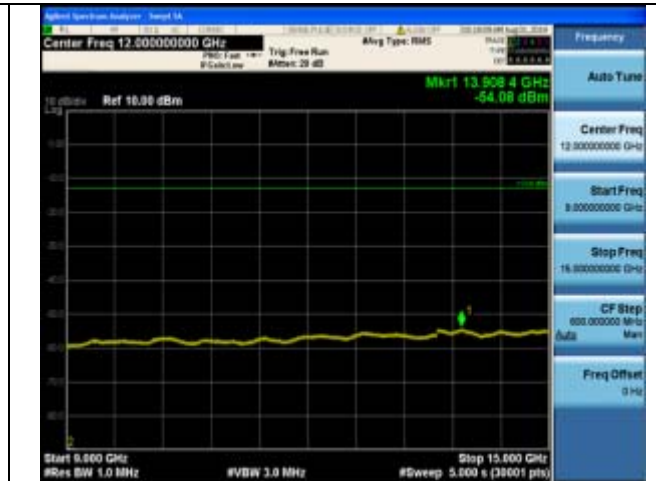

9GHz ~15GHz



15GHz ~20GHz
1RB#0



15GHz ~20GHz
1RB#0

LTE FDD Band 4-1.4MHz Channel Bandwidth

High Channel

QPSK

16QAM

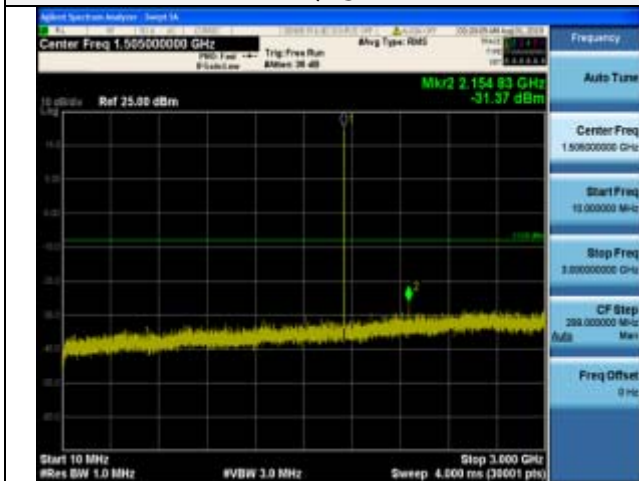

10MHz~3GHz

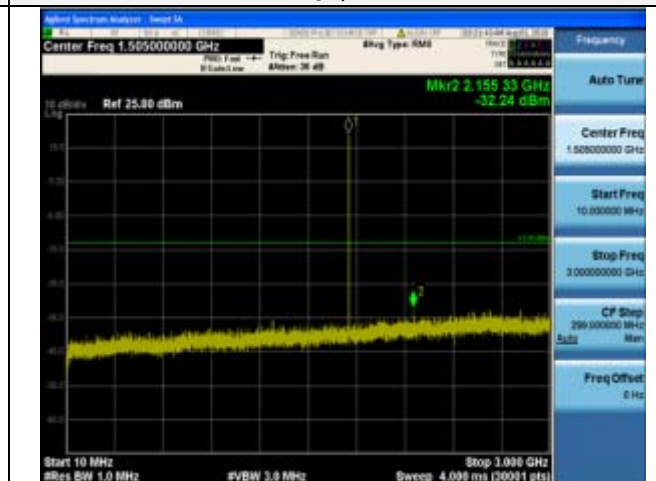

10MHz~3GHz

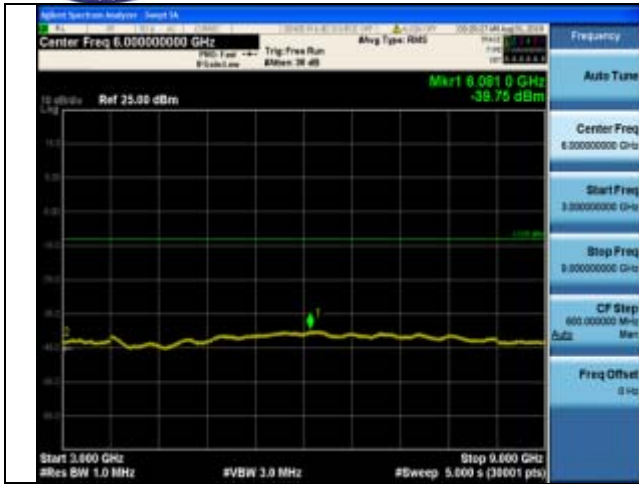

3GHz ~9GHz

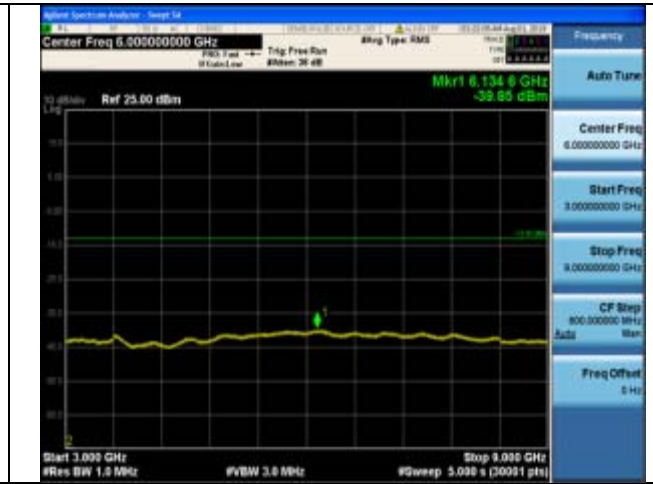

3GHz ~9GHz



9GHz ~15GHz

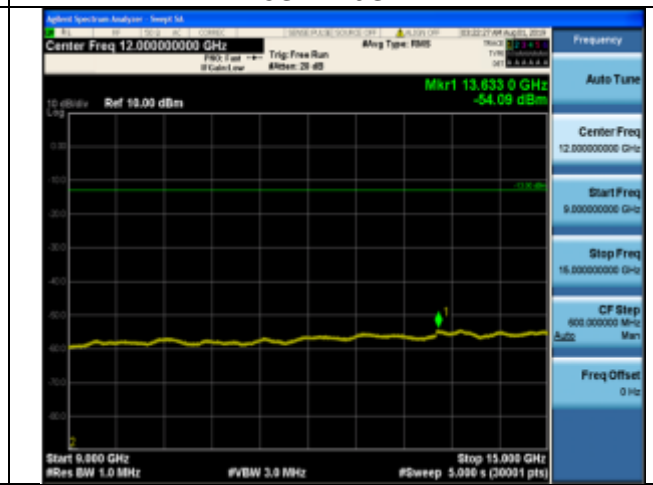

9GHz ~15GHz

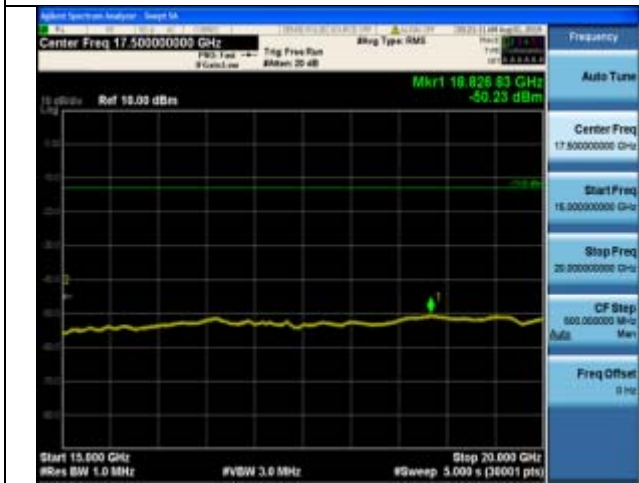

15GHz ~20GHz

1RB#0



15GHz ~20GHz

1RB#0



LTE FDD Band 4-3MHz Channel Bandwidth
Low Channel

QPSK

16QAM

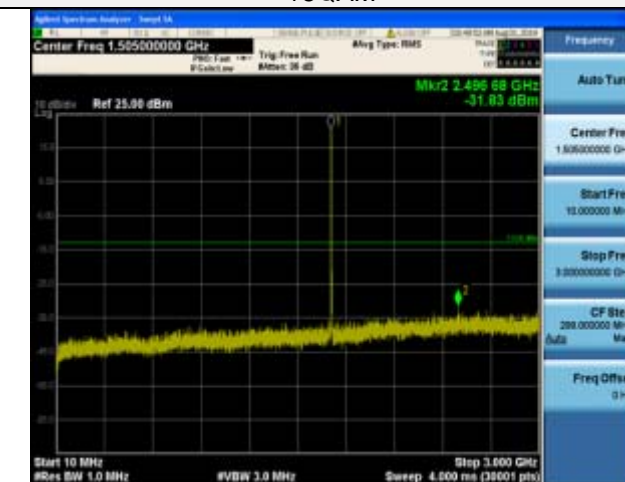
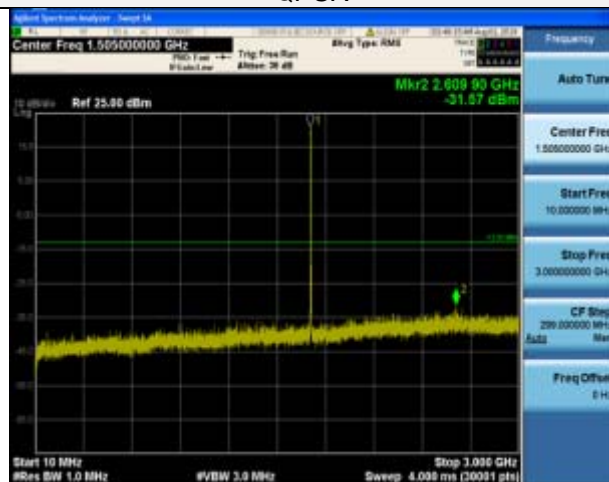

10MHz~3GHz

10MHz~3GHz

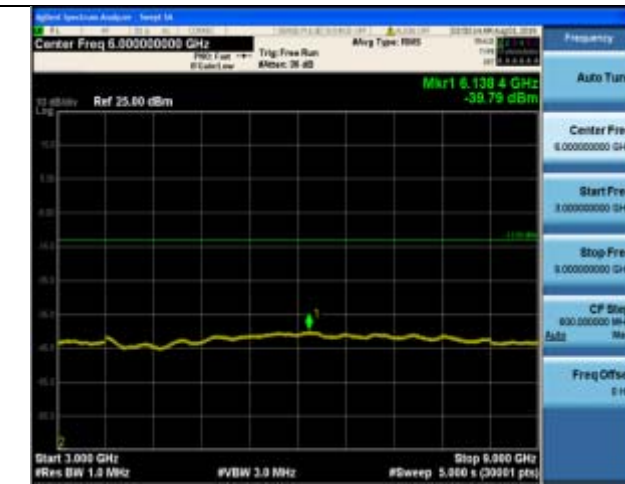

3GHz~9GHz

3GHz~9GHz



9GHz~15GHz

9GHz~15GHz



15GHz ~20GHz

1RB#0



15GHz ~20GHz

1RB#0

LTE FDD Band 4-3MHz Channel Bandwidth

Middle Channel

QPSK

16QAM

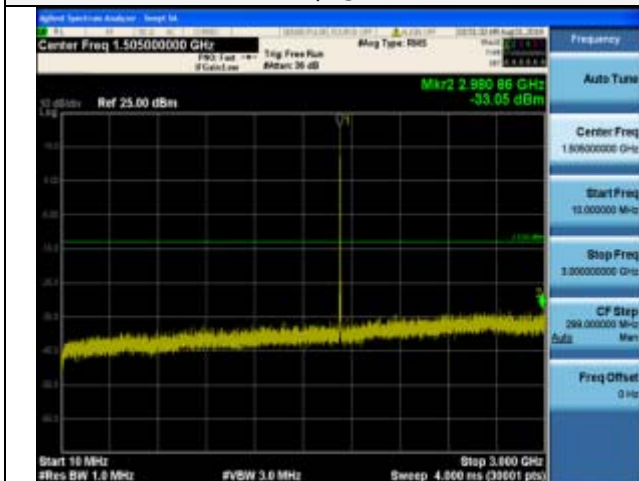

10MHz~3GHz

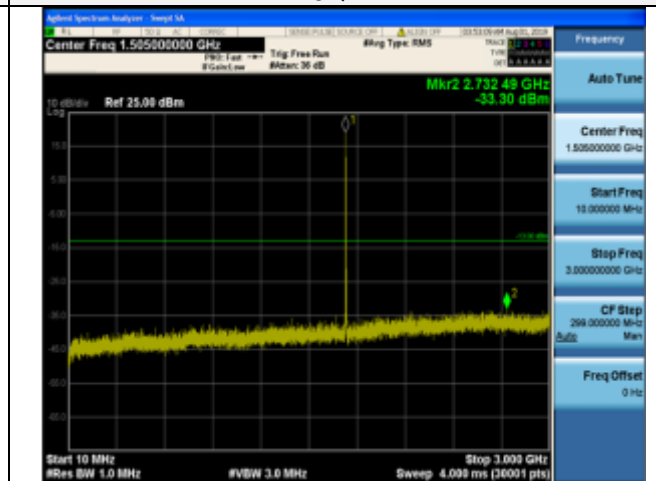

10MHz~3GHz

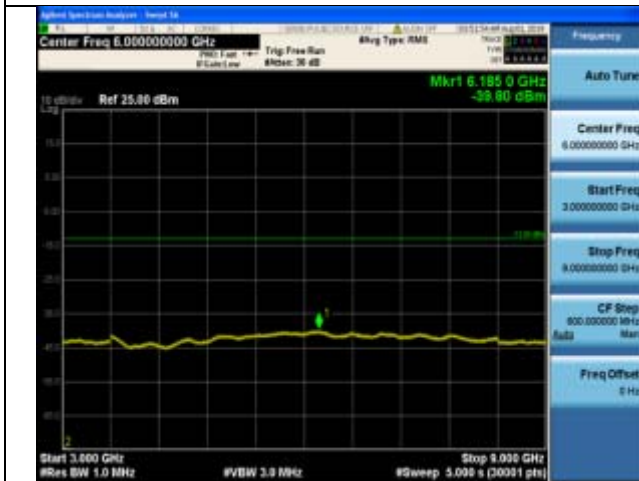

3GHz ~9GHz

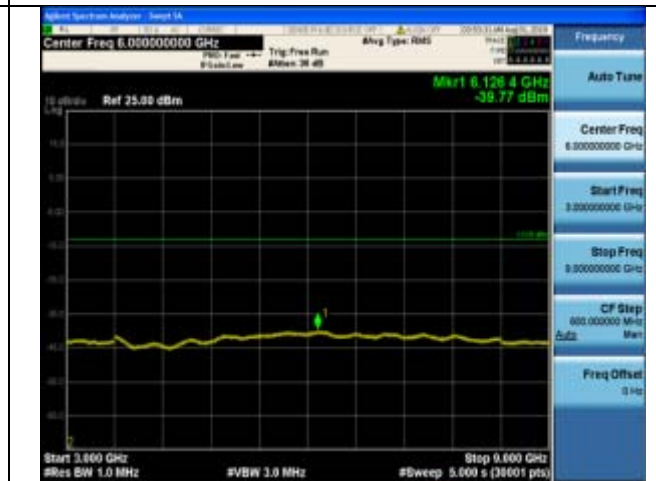

3GHz ~9GHz



9GHz ~15GHz



9GHz ~15GHz



15GHz ~20GHz

1RB#0



15GHz ~20GHz

1RB#0

LTE FDD Band 4-3MHz Channel Bandwidth
High Channel

QPSK

16QAM

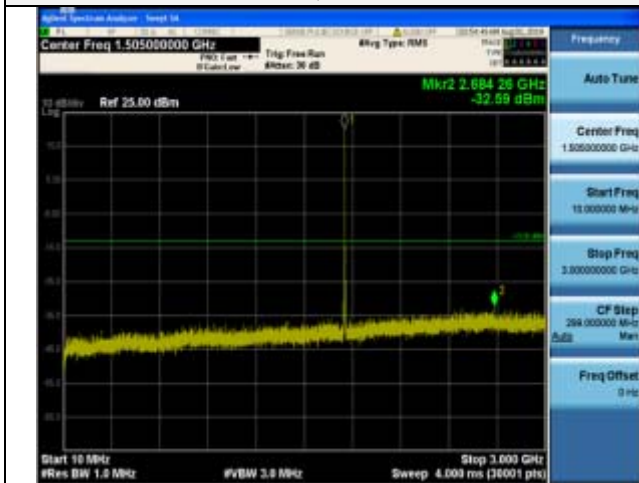

10MHz~3GHz

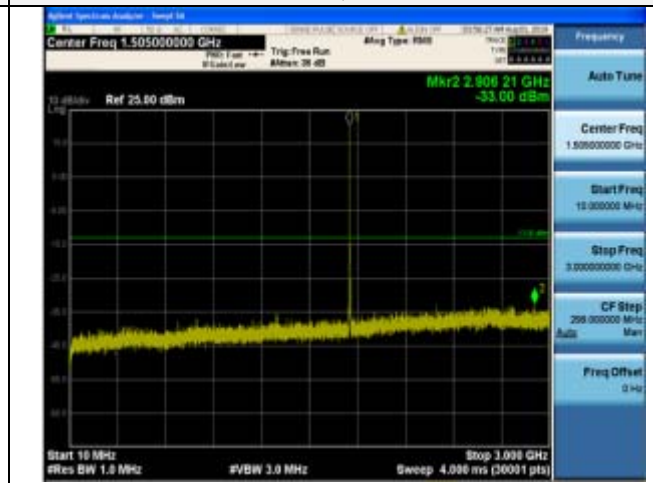

10MHz~3GHz

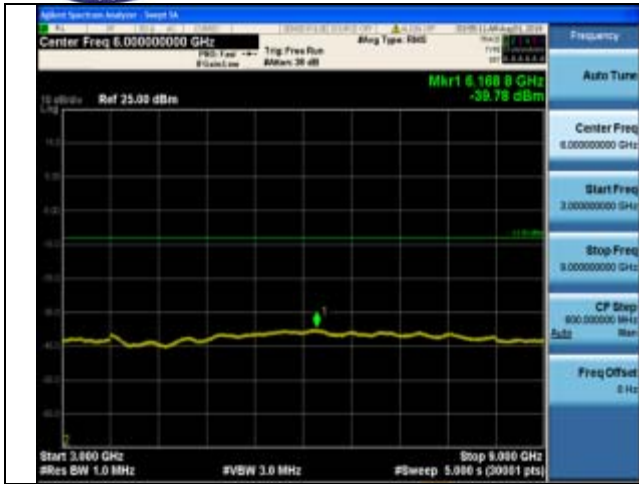

3GHz ~9GHz



3GHz ~9GHz



9GHz ~15GHz



9GHz ~15GHz

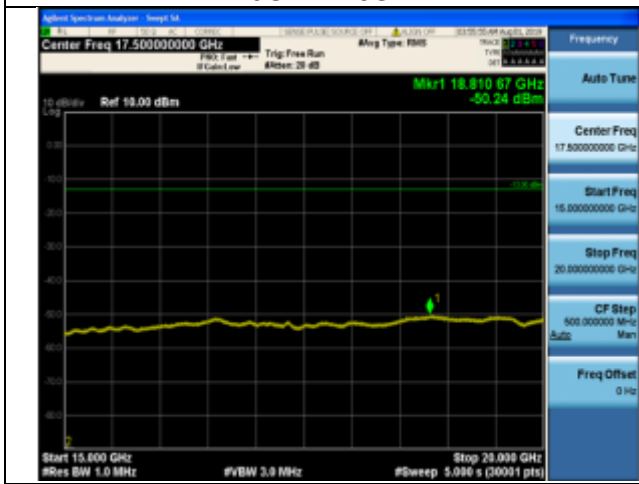

15GHz ~20GHz

1RB#0



15GHz ~20GHz

1RB#0



LTE FDD Band 4-5MHz Channel Bandwidth
Low Channel

QPSK

16QAM

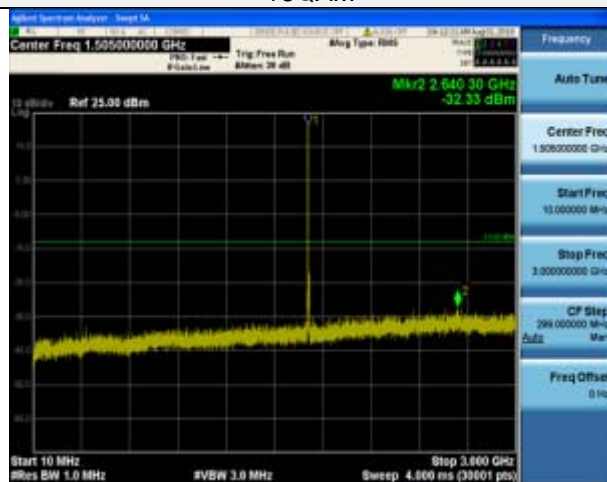
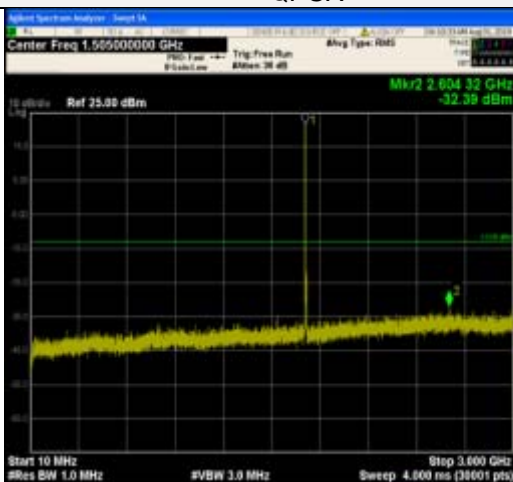

10MHz~3GHz

10MHz~3GHz



3GHz ~9GHz

3GHz ~9GHz



9GHz ~15GHz

9GHz ~15GHz

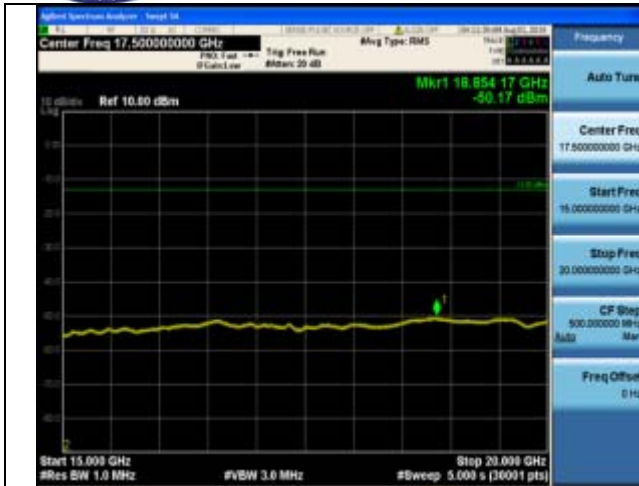

15GHz ~20GHz
1RB#0



15GHz ~20GHz
1RB#0

LTE FDD Band 4-5MHz Channel Bandwidth
Middle Channel

QPSK

16QAM

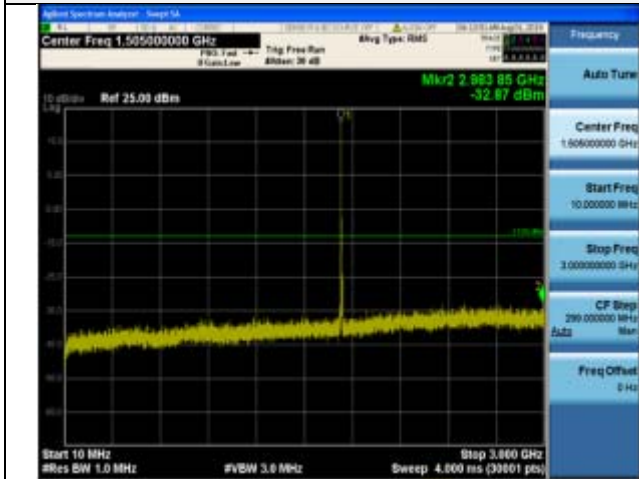

10MHz~3GHz

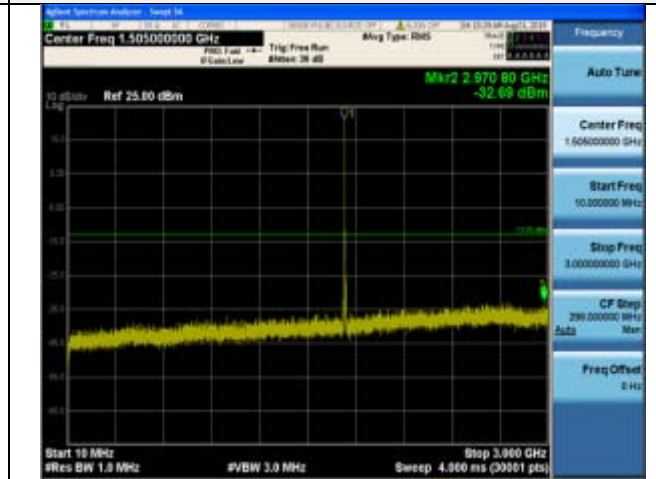

10MHz~3GHz

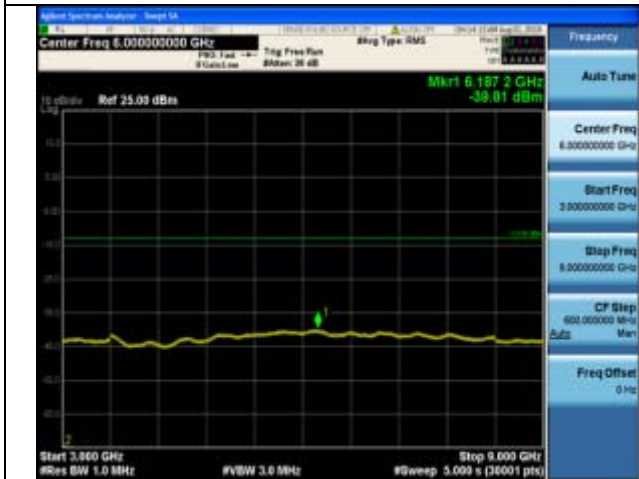

3GHz ~9GHz

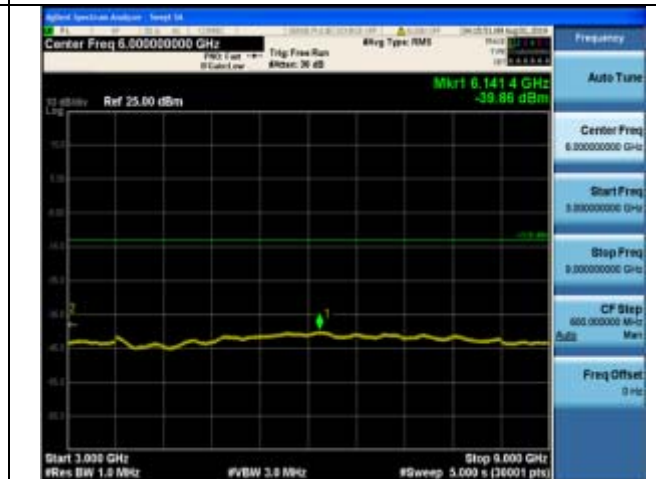

3GHz ~9GHz

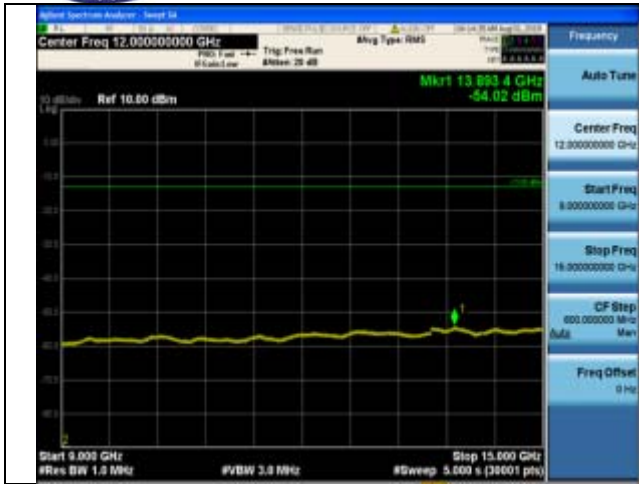

9GHz ~15GHz



9GHz ~15GHz



15GHz ~20GHz

1RB#0



15GHz ~20GHz

1RB#0

LTE FDD Band 4-5MHz Channel Bandwidth
High Channel

QPSK

16QAM

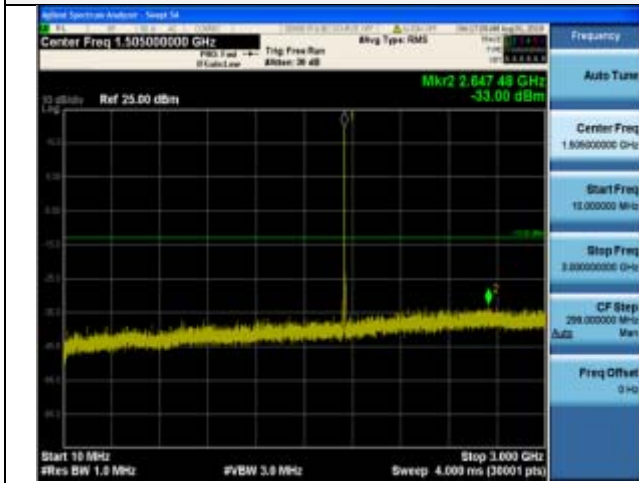

10MHz~3GHz

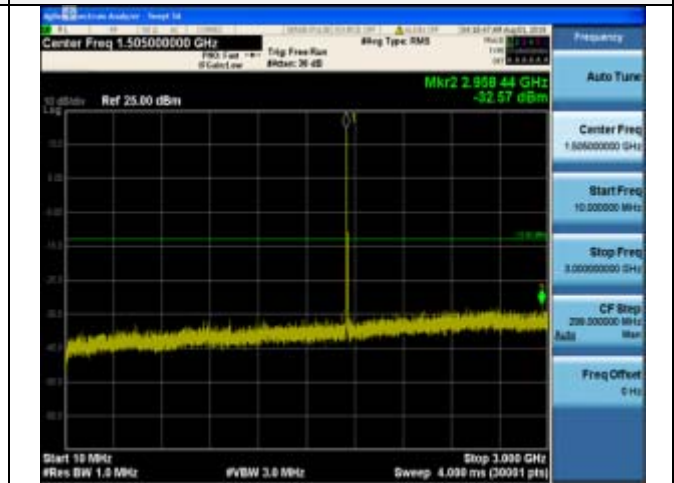

10MHz~3GHz

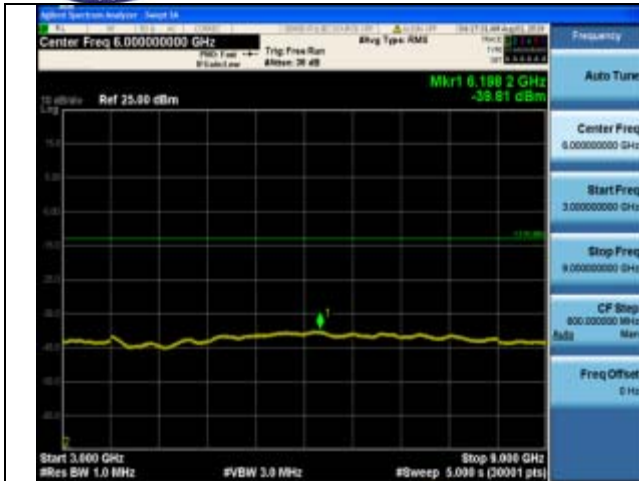

3GHz ~9GHz

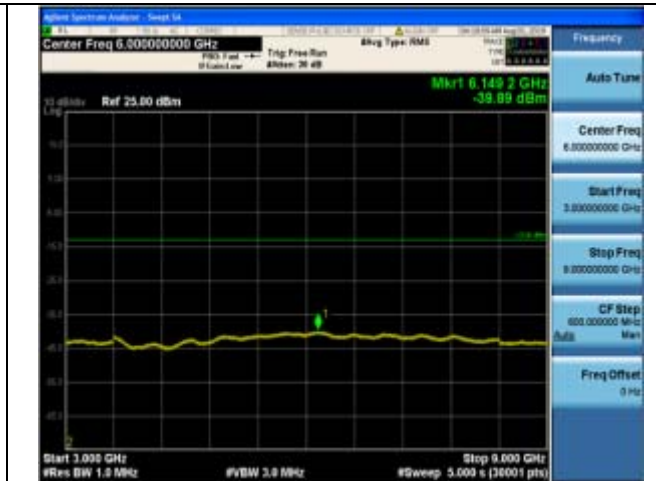

3GHz ~9GHz



9GHz ~15GHz



9GHz ~15GHz



15GHz ~20GHz

1RB#0



15GHz ~20GHz

1RB#0



LTE FDD Band 4-10MHz Channel Bandwidth
Low Channel

QPSK

16QAM

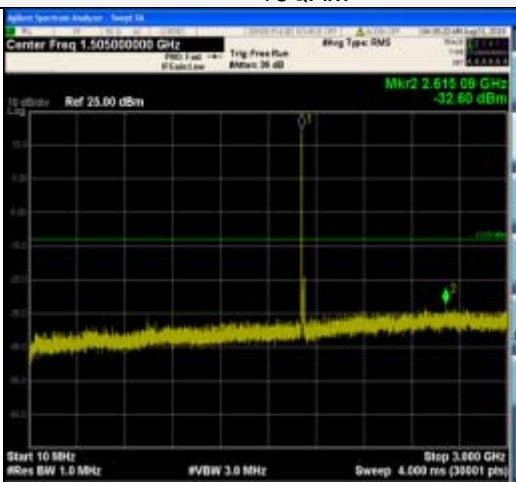

10MHz~3GHz

10MHz~3GHz

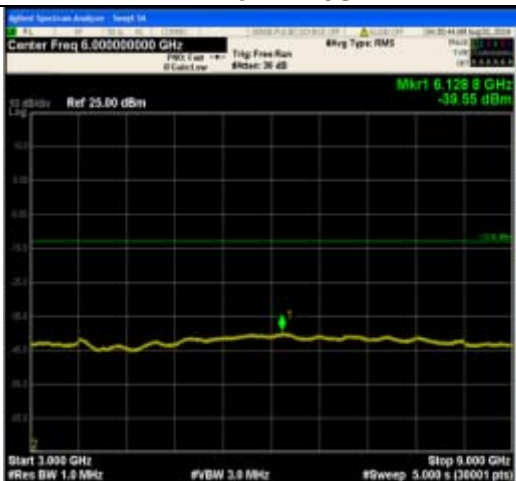

3GHz~9GHz

3GHz~9GHz



9GHz~15GHz

9GHz~15GHz



15GHz ~20GHz
1RB#0



15GHz ~20GHz
1RB#0

LTE FDD Band 4-10MHz Channel Bandwidth
Middle Channel

QPSK

16QAM

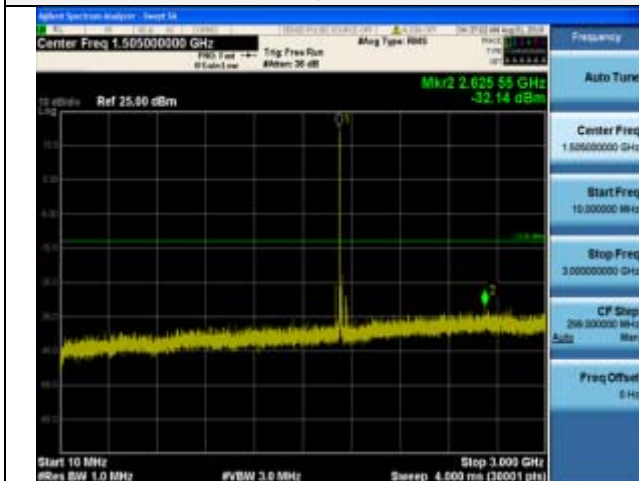

10MHz~3GHz

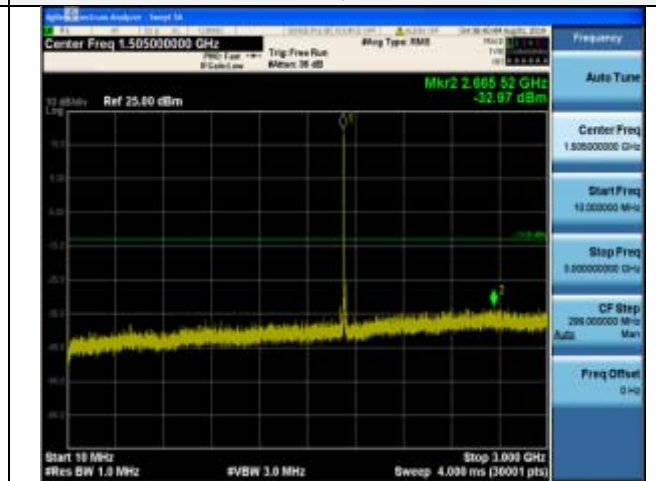

10MHz~3GHz

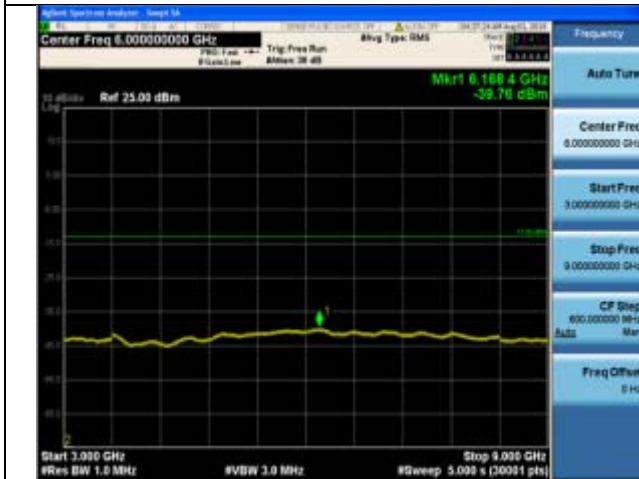

3GHz ~9GHz

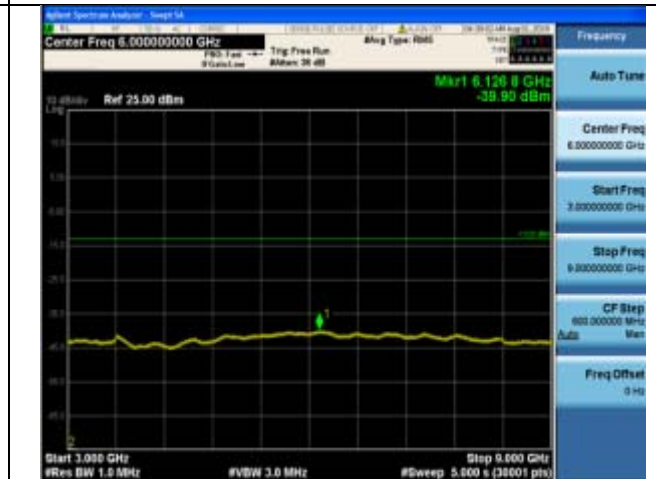

3GHz ~9GHz

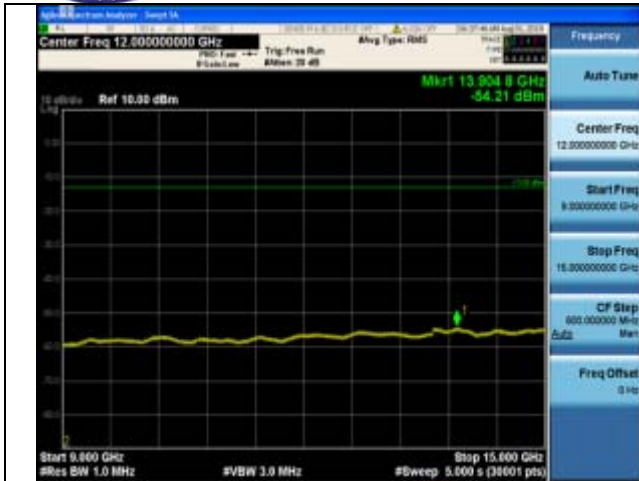

9GHz ~15GHz



9GHz ~15GHz



15GHz ~20GHz

1RB#0



15GHz ~20GHz

1RB#0

LTE FDD Band 4-10MHz Channel Bandwidth

High Channel

QPSK

16QAM

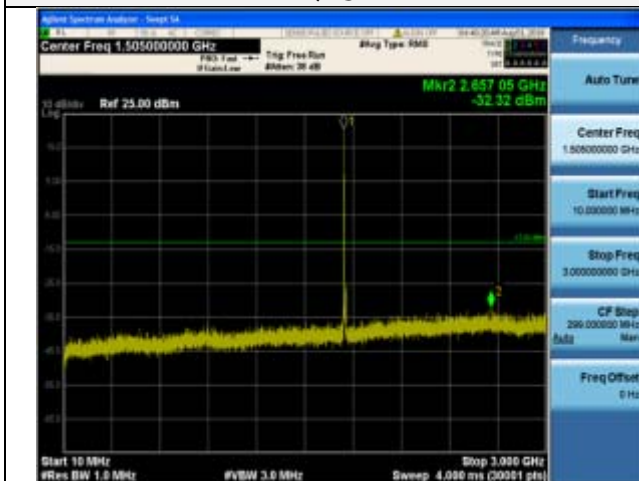

10MHz~3GHz

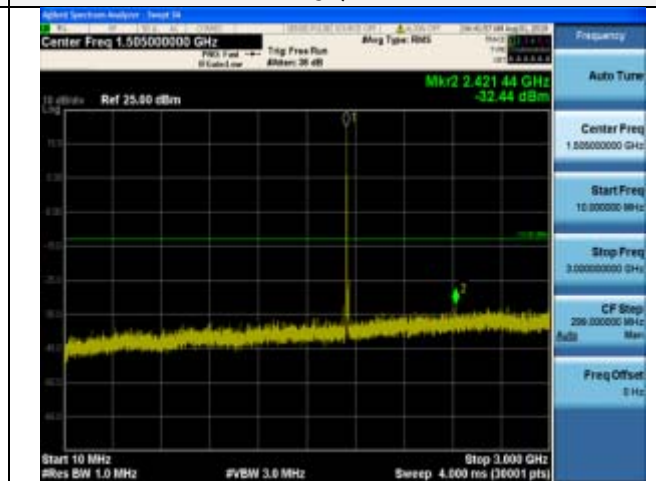

10MHz~3GHz

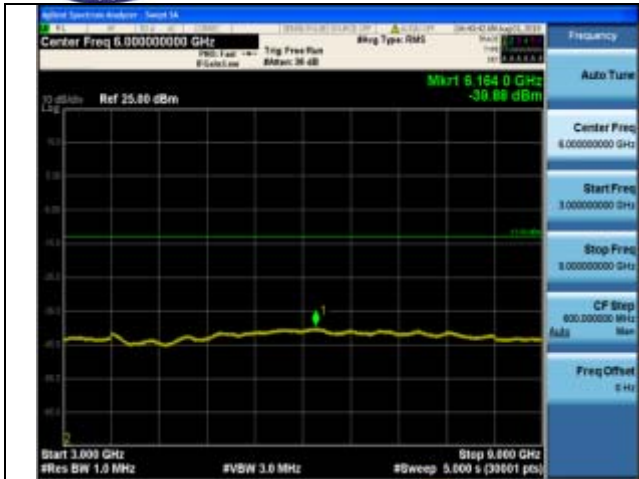

3GHz ~9GHz



3GHz ~9GHz



9GHz ~15GHz

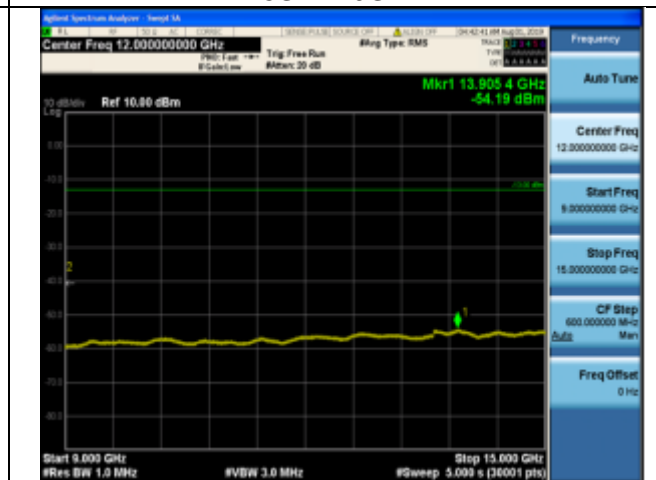

9GHz ~15GHz



15GHz ~20GHz

1RB#0



15GHz ~20GHz

1RB#0



LTE FDD Band 4-15MHz Channel Bandwidth
Low Channel

QPSK

16QAM

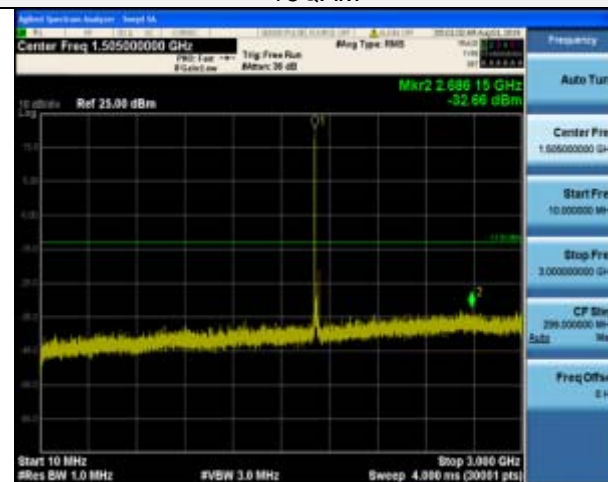
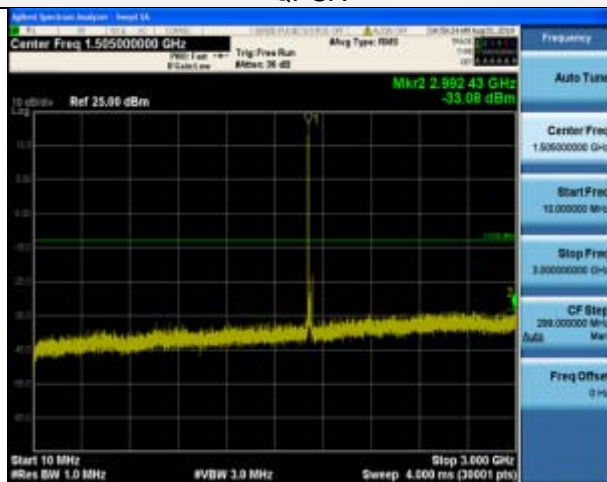

10MHz~3GHz

10MHz~3GHz



3GHz~9GHz

3GHz~9GHz

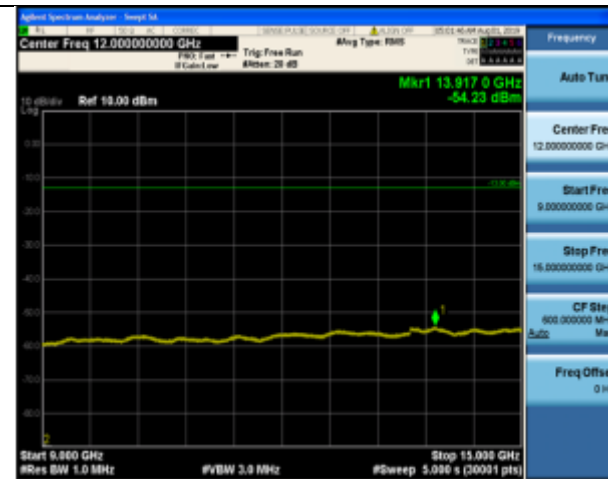

9GHz~15GHz

9GHz~15GHz

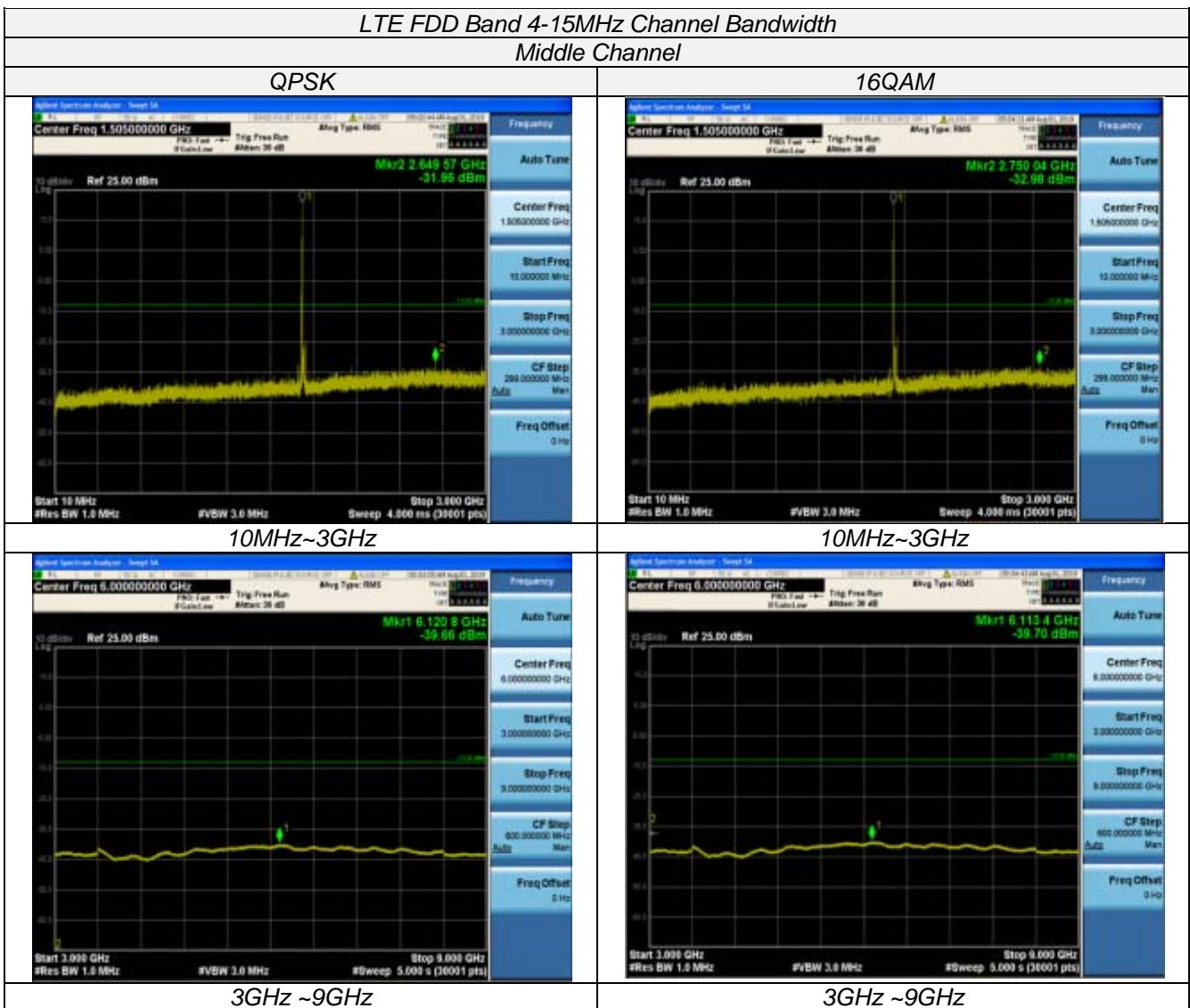
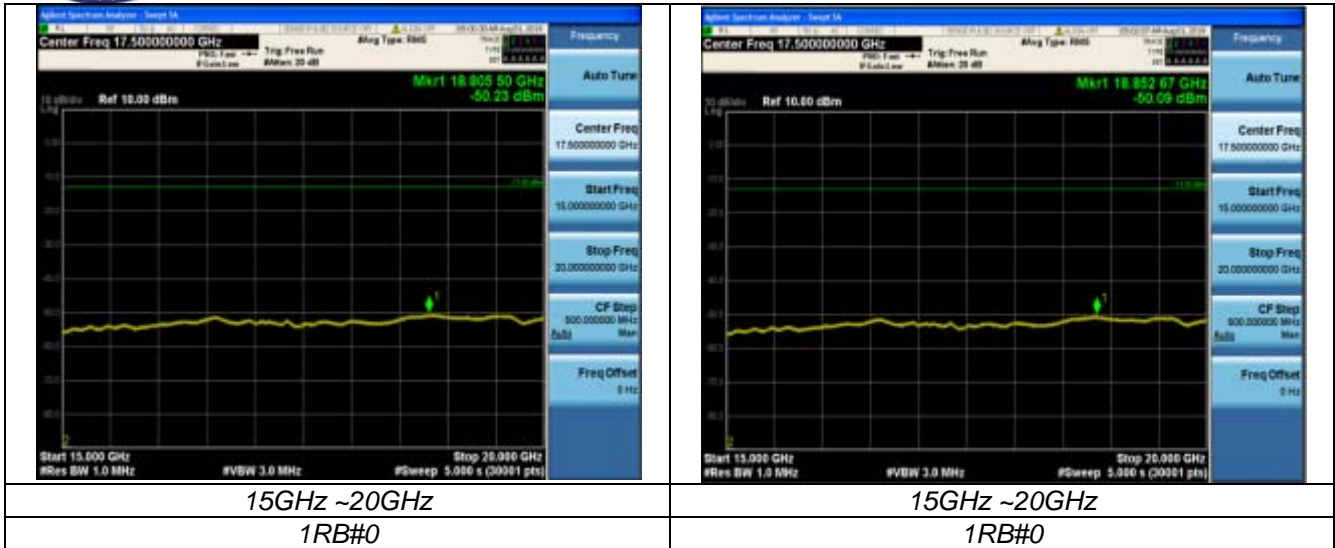

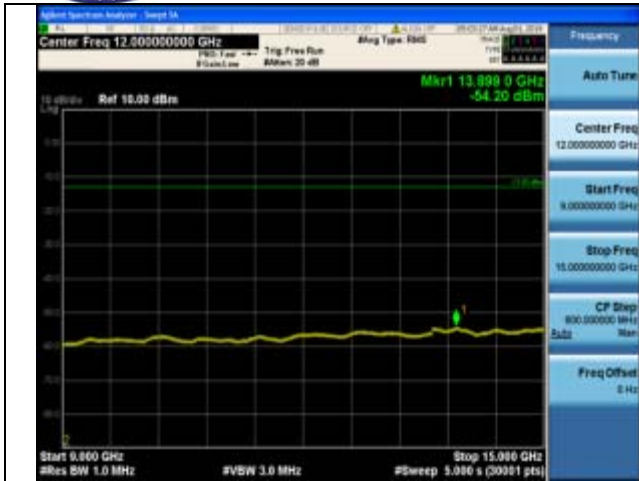

9GHz ~15GHz



9GHz ~15GHz



15GHz ~20GHz

1RB#0



15GHz ~20GHz

1RB#0

LTE FDD Band 4-15MHz Channel Bandwidth

High Channel

QPSK

16QAM

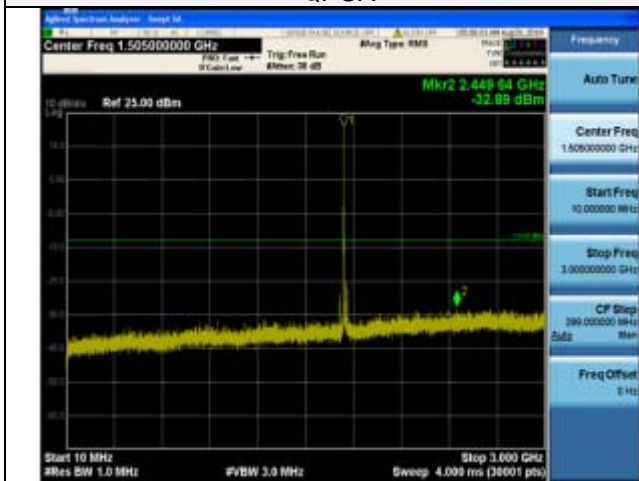

10MHz~3GHz

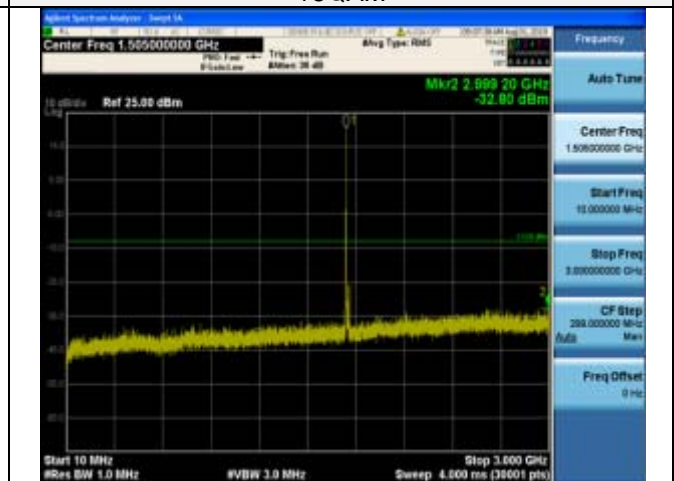

10MHz~3GHz

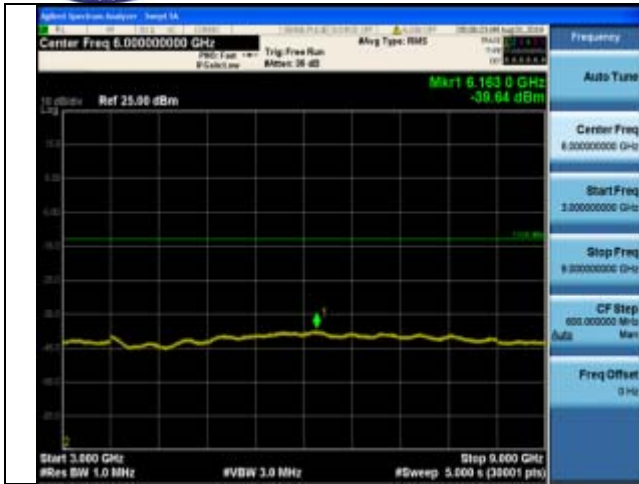

3GHz ~9GHz



3GHz ~9GHz



9GHz ~15GHz



9GHz ~15GHz



15GHz ~20GHz

1RB#0



15GHz ~20GHz

1RB#0



LTE FDD Band 4-20MHz Channel Bandwidth
Low Channel

QPSK

16QAM

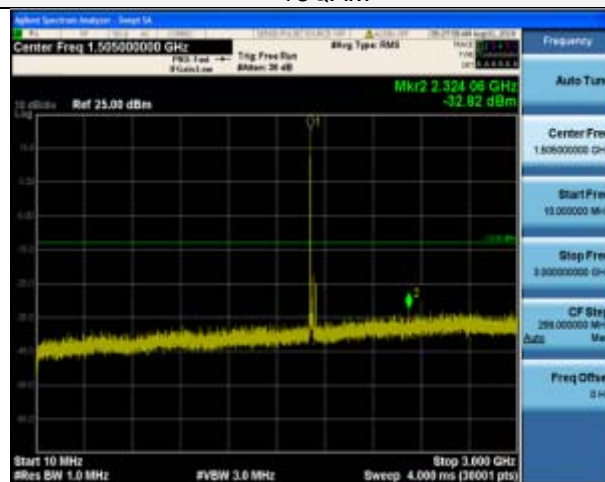
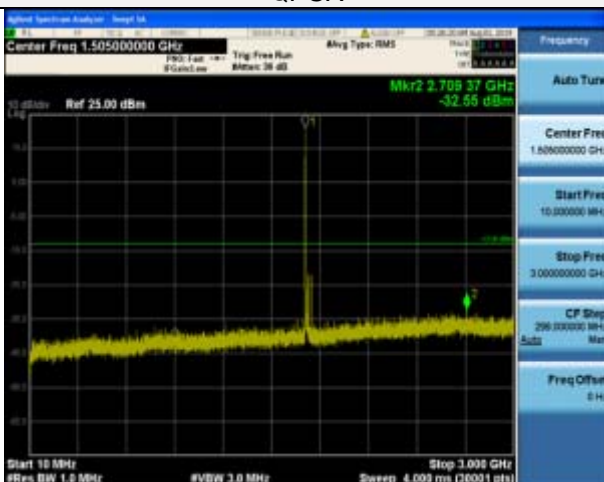

10MHz~3GHz

10MHz~3GHz



3GHz ~9GHz

3GHz ~9GHz



9GHz ~15GHz

9GHz ~15GHz

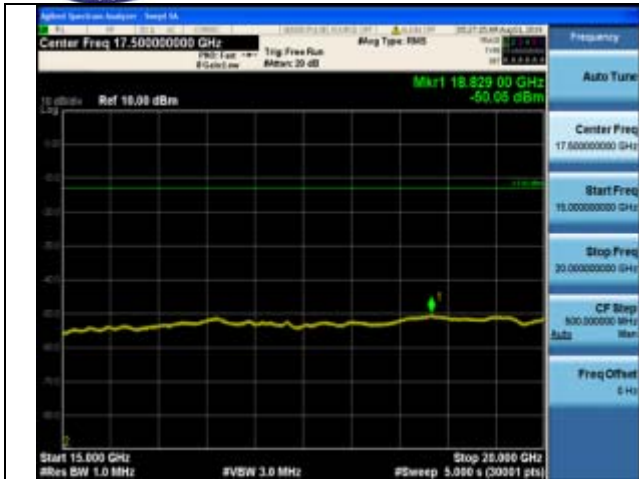

15GHz ~20GHz
1RB#0



15GHz ~20GHz
1RB#0

LTE FDD Band 4-20MHz Channel Bandwidth
Middle Channel

QPSK

16QAM

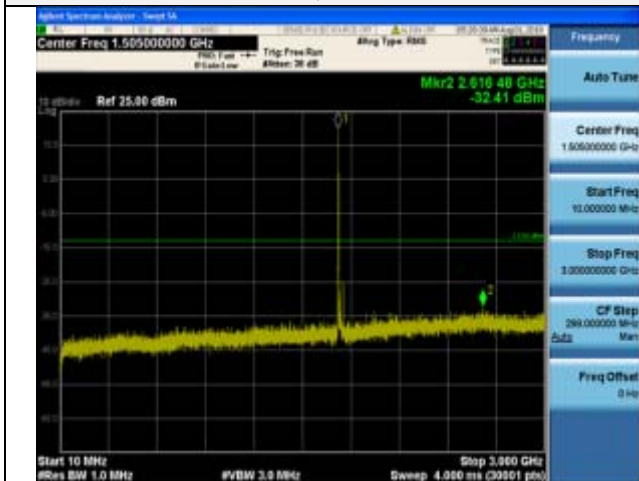

10MHz~3GHz

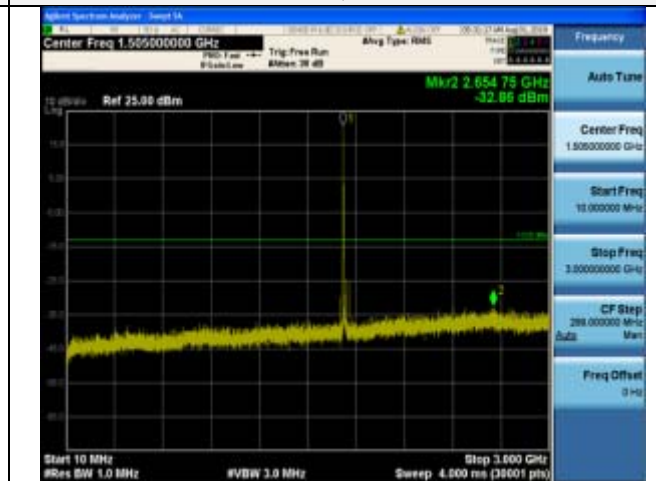

10MHz~3GHz

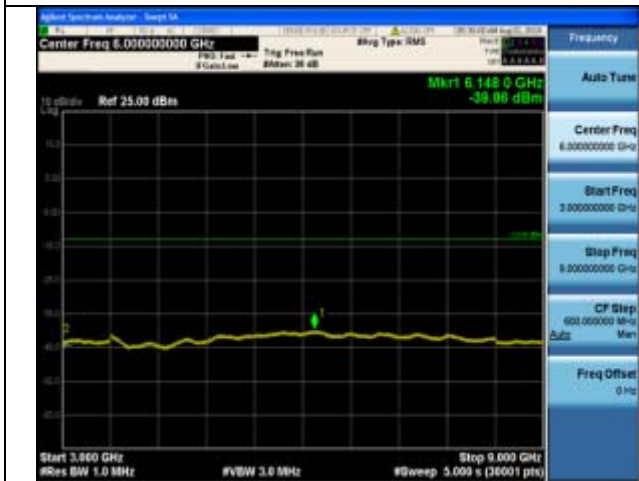

3GHz ~9GHz

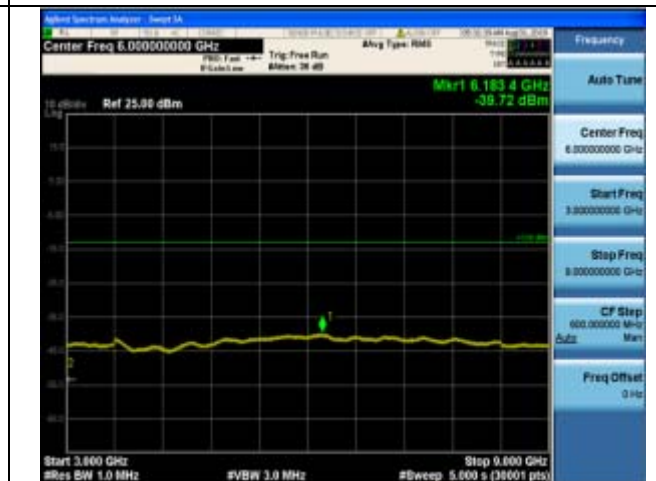

3GHz ~9GHz



9GHz ~15GHz



9GHz ~15GHz



15GHz ~20GHz

1RB#0



15GHz ~20GHz

1RB#0

LTE FDD Band 4-20MHz Channel Bandwidth

High Channel

QPSK

16QAM

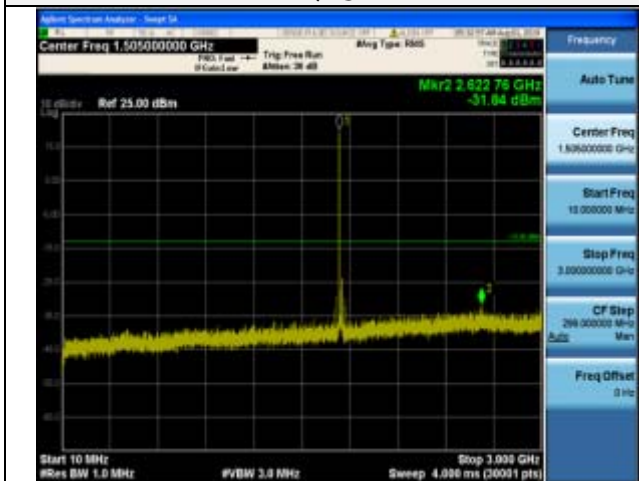

10MHz~3GHz

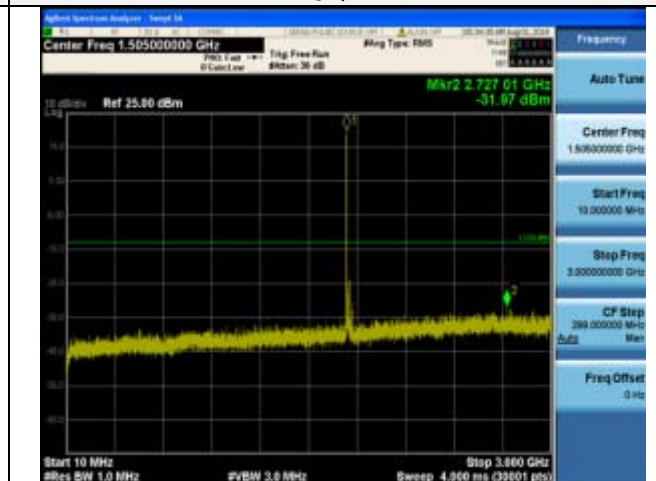

10MHz~3GHz

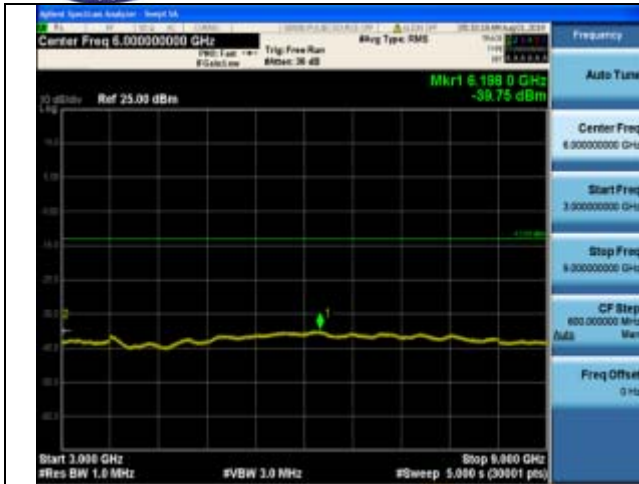

3GHz ~9GHz

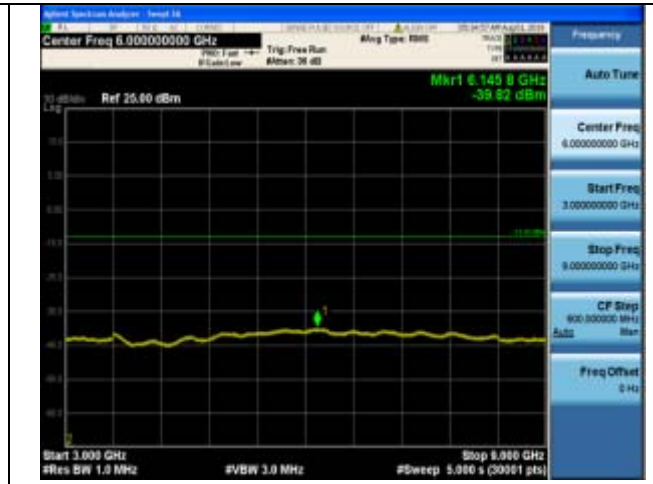

3GHz ~9GHz



9GHz ~15GHz



9GHz ~15GHz



15GHz ~20GHz

1RB#0



15GHz ~20GHz

1RB#0

**Radiated Measurement:***Remark:*

1. We were tested all RB Configuration refer 3GPP TS136 521 for each Channel Bandwidth of LTE FDD Band 4; recorded worst case for each Channel Bandwidth of LTE FDD Band 4.
2. $EIRP = P_{Mea}(dBm) - P_{cl}(dB) + G_a(dBi)$
3. We were not recorded other points as values lower than limits.
4. $Margin = Limit - EIRP$

LTE FDD Band 4 Channel Bandwidth 1.4MHz_QPSK_Low Channel

Frequency (MHz)	PMea (dBm)	Pcl (dB)	Diatance	Ga Antenna Gain(dB)	Peak EIRP (dBm)	Limit (dBm)	Margin (dB)	Polarization
3421.4	-45.33	4.02	3.00	12.5	-36.85	-13.00	23.85	H
5132.1	-48.11	5.11	3.00	13.38	-39.84	-13.00	26.84	H
3421.4	-51.17	4.02	3.00	12.5	-42.69	-13.00	29.69	V
5132.1	-52.3	5.11	3.00	13.38	-44.03	-13.00	31.03	V

LTE FDD Band 4 Channel Bandwidth 1.4MHz_QPSK_Middle Channel

Frequency (MHz)	PMea (dBm)	Pcl (dB)	Diatance	Ga Antenna Gain(dB)	EIRP (dBm)	Limit (dBm)	Margin (dB)	Polarization
3465.0	-43.71	4.02	3.00	12.45	-35.28	-13.00	22.28	H
5197.5	-48.01	5.11	3.00	13.38	-39.74	-13.00	26.74	H
3465.0	-51.18	4.02	3.00	12.45	-42.75	-13.00	29.75	V
5197.5	-54.72	5.11	3.00	13.38	-46.45	-13.00	33.45	V

LTE FDD Band 4 Channel Bandwidth 1.4MHz_QPSK_High Channel

Frequency (MHz)	PMea (dBm)	Pcl (dB)	Diatance	Ga Antenna Gain(dB)	EIRP (dBm)	Limit (dBm)	Margin (dB)	Polarization
3508.6	-45.98	4.02	3.00	12.21	-37.79	-13.00	24.79	H
5262.9	-47.57	5.11	3.00	13.26	-39.42	-13.00	26.42	H
3508.6	-50.84	4.02	3.00	12.21	-42.65	-13.00	29.65	V
5262.9	-53.08	5.11	3.00	13.26	-44.93	-13.00	31.93	V

LTE FDD Band 4 Channel Bandwidth 3MHz_QPSK_Low Channel

Frequency (MHz)	PMea (dBm)	Pcl (dB)	Diatance	Ga Antenna Gain(dB)	Peak EIRP (dBm)	Limit (dBm)	Margin (dB)	Polarization
3423.0	-44.86	4.02	3.00	12.5	-36.38	-13.00	23.38	H
5134.5	-47.65	5.11	3.00	13.38	-39.38	-13.00	26.38	H
3423.0	-51.67	4.02	3.00	12.5	-43.19	-13.00	30.19	V
5134.5	-51.94	5.11	3.00	13.38	-43.67	-13.00	30.67	V

LTE FDD Band 4 Channel Bandwidth 3MHz_QPSK_Middle Channel

Frequency (MHz)	PMea (dBm)	Pcl (dB)	Diatance	Ga Antenna Gain(dB)	EIRP (dBm)	Limit (dBm)	Margin (dB)	Polarization
3465.0	-43.96	4.02	3.00	12.45	-35.53	-13.00	22.53	H
5197.5	-47.95	5.11	3.00	13.38	-39.68	-13.00	26.68	H
3465.0	-50.78	4.02	3.00	12.45	-42.35	-13.00	29.35	V
5197.5	-53.89	5.11	3.00	13.38	-45.62	-13.00	32.62	V

LTE FDD Band 4 Channel Bandwidth 3MHz_QPSK_High Channel

Frequency (MHz)	PMea (dBm)	Pcl (dB)	Diatance	Ga Antenna Gain(dB)	EIRP (dBm)	Limit (dBm)	Margin (dB)	Polarization
3507.0	-46.21	4.02	3.00	12.21	-38.02	-13.00	25.02	H
5260.5	-47.57	5.11	3.00	13.26	-39.42	-13.00	26.42	H
3507.0	-51.7	4.02	3.00	12.21	-43.51	-13.00	30.51	V
5260.5	-52.94	5.11	3.00	13.26	-44.79	-13.00	31.79	V



LTE FDD Band 4 Channel Bandwidth 5MHz_QPSK_Low Channel

Frequency (MHz)	PMea (dBm)	Pcl (dB)	Diatance	Ga Antenna Gain(dB)	Peak EIRP (dBm)	Limit (dBm)	Margin (dB)	Polarization
3425.0	-45.32	4.02	3.00	12.5	-36.84	-13.00	23.84	H
5137.5	-48.18	5.11	3.00	13.38	-39.91	-13.00	26.91	H
3425.0	-51.25	4.02	3.00	12.5	-42.77	-13.00	29.77	V
5137.5	-52.39	5.11	3.00	13.38	-44.12	-13.00	31.12	V

LTE FDD Band 4 Channel Bandwidth 5MHz_QPSK_Middle Channel

Frequency (MHz)	PMea (dBm)	Pcl (dB)	Diatance	Ga Antenna Gain(dB)	EIRP (dBm)	Limit (dBm)	Margin (dB)	Polarization
3465.0	-43.86	4.02	3.00	12.45	-35.43	-13.00	22.43	H
5197.5	-47.73	5.11	3.00	13.38	-39.46	-13.00	26.46	H
3465.0	-50.87	4.02	3.00	12.45	-42.44	-13.00	29.44	V
5197.5	-53.97	5.11	3.00	13.38	-45.7	-13.00	32.7	V

LTE FDD Band 4 Channel Bandwidth 5MHz_QPSK_High Channel

Frequency (MHz)	PMea (dBm)	Pcl (dB)	Diatance	Ga Antenna Gain(dB)	EIRP (dBm)	Limit (dBm)	Margin (dB)	Polarization
3505.0	-46.78	4.02	3.00	12.21	-38.59	-13.00	25.59	H
5257.5	-47.26	5.11	3.00	13.26	-39.11	-13.00	26.11	H
3505.0	-50.98	4.02	3.00	12.21	-42.79	-13.00	29.79	V
5257.5	-53.45	5.11	3.00	13.26	-45.3	-13.00	32.3	V

LTE FDD Band 4 Channel Bandwidth 10MHz_QPSK_Low Channel

Frequency (MHz)	PMea (dBm)	Pcl (dB)	Diatance	Ga Antenna Gain(dB)	Peak EIRP (dBm)	Limit (dBm)	Margin (dB)	Polarization
3430.0	-45.49	4.02	3.00	12.5	-37.01	-13.00	24.01	H
5145.0	-47.91	5.11	3.00	13.38	-39.64	-13.00	26.64	H
3430.0	-51.13	4.02	3.00	12.5	-42.65	-13.00	29.65	V
5145.0	-52.66	5.11	3.00	13.38	-44.39	-13.00	31.39	V

LTE FDD Band 4 Channel Bandwidth 10MHz_QPSK_Middle Channel

Frequency (MHz)	PMea (dBm)	Pcl (dB)	Diatance	Ga Antenna Gain(dB)	EIRP (dBm)	Limit (dBm)	Margin (dB)	Polarization
3465.0	-43.9	4.02	3.00	12.45	-35.47	-13.00	22.47	H
5197.5	-47.78	5.11	3.00	13.38	-39.51	-13.00	26.51	H
3465.0	-50.4	4.02	3.00	12.45	-41.97	-13.00	28.97	V
5197.5	-54.1	5.11	3.00	13.38	-45.83	-13.00	32.83	V

LTE FDD Band 4 Channel Bandwidth 10MHz_QPSK_High Channel

Frequency (MHz)	PMea (dBm)	Pcl (dB)	Diatance	Ga Antenna Gain(dB)	EIRP (dBm)	Limit (dBm)	Margin (dB)	Polarization
3500.0	-45.95	4.02	3.00	12.5	-37.47	-13.00	24.47	H
5250.0	-47.52	5.11	3.00	13.38	-39.25	-13.00	26.25	H
3500.0	-51.71	4.02	3.00	12.5	-43.23	-13.00	30.23	V
5250.0	-53.33	5.11	3.00	13.38	-45.06	-13.00	32.06	V

LTE FDD Band 4 Channel Bandwidth 15MHz_QPSK_Low Channel

Frequency (MHz)	PMea (dBm)	Pcl (dB)	Diatance	Ga Antenna Gain(dB)	Peak EIRP (dBm)	Limit (dBm)	Margin (dB)	Polarization
3435.0	-45.09	4.02	3.00	12.5	-36.61	-13.00	23.61	H
5152.5	-47.67	5.11	3.00	13.38	-39.4	-13.00	26.4	H
3435.0	-50.98	4.02	3.00	12.5	-42.5	-13.00	29.5	V
5152.5	-52.18	5.11	3.00	13.38	-43.91	-13.00	30.91	V



LTE FDD Band 4 Channel Bandwidth 15MHz_QPSK Middle Channel

Frequency (MHz)	PMea (dBm)	Pcl (dB)	Diatance	Ga Antenna Gain(dB)	EIRP (dBm)	Limit (dBm)	Margin (dB)	Polarization
3465.0	-43.97	4.02	3.00	12.45	-35.54	-13.00	22.54	H
5197.5	-47.2	5.11	3.00	13.38	-38.93	-13.00	25.93	H
3465.0	-51.01	4.02	3.00	12.45	-42.58	-13.00	29.58	V
5197.5	-54.11	5.11	3.00	13.38	-45.84	-13.00	32.84	V

LTE FDD Band 4 Channel Bandwidth 15MHz_QPSK High Channel

Frequency (MHz)	PMea (dBm)	Pcl (dB)	Diatance	Ga Antenna Gain(dB)	EIRP (dBm)	Limit (dBm)	Margin (dB)	Polarization
3495.0	-46.23	4.02	3.00	12.5	-37.75	-13.00	24.75	H
5242.5	-47.53	5.11	3.00	13.38	-39.26	-13.00	26.26	H
3495.0	-51.3	4.02	3.00	12.5	-42.82	-13.00	29.82	V
5242.5	-53.63	5.11	3.00	13.38	-45.36	-13.00	32.36	V

LTE FDD Band 4 Channel Bandwidth 20MHz_QPSK Low Channel

Frequency (MHz)	PMea (dBm)	Pcl (dB)	Diatance	Ga Antenna Gain(dB)	Peak EIRP (dBm)	Limit (dBm)	Margin (dB)	Polarization
3440.0	-44.88	4.02	3.00	12.5	-36.4	-13.00	23.4	H
5160.0	-48.39	5.11	3.00	13.38	-40.12	-13.00	27.12	H
3440.0	-51.6	4.02	3.00	12.5	-43.12	-13.00	30.12	V
5160.0	-52.31	5.11	3.00	13.38	-44.04	-13.00	31.04	V

LTE FDD Band 4 Channel Bandwidth 20MHz_QPSK Middle Channel

Frequency (MHz)	PMea (dBm)	Pcl (dB)	Diatance	Ga Antenna Gain(dB)	EIRP (dBm)	Limit (dBm)	Margin (dB)	Polarization
3465.0	-43.35	4.02	3.00	12.45	-34.92	-13.00	21.92	H
5197.5	-47.48	5.11	3.00	13.38	-39.21	-13.00	26.21	H
3465.0	-50.2	4.02	3.00	12.45	-41.77	-13.00	28.77	V
5197.5	-53.84	5.11	3.00	13.38	-45.57	-13.00	32.57	V

LTE FDD Band 4 Channel Bandwidth 20MHz_QPSK High Channel

Frequency (MHz)	PMea (dBm)	Pcl (dB)	Diatance	Ga Antenna Gain(dB)	EIRP (dBm)	Limit (dBm)	Margin (dB)	Polarization
3490.0	-46.78	4.02	3.00	12.5	-38.3	-13.00	25.3	H
5235.0	-47.62	5.11	3.00	13.38	-39.35	-13.00	26.35	H
3490.0	-50.91	4.02	3.00	12.5	-42.43	-13.00	29.43	V
5235.0	-53.62	5.11	3.00	13.38	-45.35	-13.00	32.35	V

LTE FDD Band 4 Channel Bandwidth 1.4MHz_16QAM Low Channel

Frequency (MHz)	PMea (dBm)	Pcl (dB)	Diatance	Ga Antenna Gain(dB)	Peak EIRP (dBm)	Limit (dBm)	Margin (dB)	Polarization
3421.4	-44.85	4.02	3.00	12.5	-36.37	-13.00	23.37	H
5132.1	-47.8	5.11	3.00	13.38	-39.53	-13.00	26.53	H
3421.4	-51.72	4.02	3.00	12.5	-43.24	-13.00	30.24	V
5132.1	-51.96	5.11	3.00	13.38	-43.69	-13.00	30.69	V

LTE FDD Band 4 Channel Bandwidth 1.4MHz_16QAM Middle Channel

Frequency (MHz)	PMea (dBm)	Pcl (dB)	Diatance	Ga Antenna Gain(dB)	EIRP (dBm)	Limit (dBm)	Margin (dB)	Polarization
3465.0	-43.82	4.02	3.00	12.45	-35.39	-13.00	22.39	H
5197.5	-47.61	5.11	3.00	13.38	-39.34	-13.00	26.34	H
3465.0	-50.46	4.02	3.00	12.45	-42.03	-13.00	29.03	V
5197.5	-54.44	5.11	3.00	13.38	-46.17	-13.00	33.17	V



LTE FDD Band 4 Channel Bandwidth 1.4MHz_16QAM_High Channel

Frequency (MHz)	PMea (dBm)	Pcl (dB)	Diatance	Ga Antenna Gain(dB)	EIRP (dBm)	Limit (dBm)	Margin (dB)	Polarization
3508.6	-46.53	4.02	3.00	12.21	-38.34	-13.00	25.34	H
5262.9	-47.91	5.11	3.00	13.26	-39.76	-13.00	26.76	H
3508.6	-51.41	4.02	3.00	12.21	-43.22	-13.00	30.22	V
5262.9	-53.63	5.11	3.00	13.26	-45.48	-13.00	32.48	V

LTE FDD Band 4 Channel Bandwidth 3MHz_16QAM_Low Channel

Frequency (MHz)	PMea (dBm)	Pcl (dB)	Diatance	Ga Antenna Gain(dB)	Peak EIRP (dBm)	Limit (dBm)	Margin (dB)	Polarization
3423.0	-45.49	4.02	3.00	12.5	-37.01	-13.00	24.01	H
5134.5	-47.83	5.11	3.00	13.38	-39.56	-13.00	26.56	H
3423.0	-51.08	4.02	3.00	12.5	-42.6	-13.00	29.6	V
5134.5	-52.1	5.11	3.00	13.38	-43.83	-13.00	30.83	V

LTE FDD Band 4 Channel Bandwidth 3MHz_16QAM_Middle Channel

Frequency (MHz)	PMea (dBm)	Pcl (dB)	Diatance	Ga Antenna Gain(dB)	EIRP (dBm)	Limit (dBm)	Margin (dB)	Polarization
3465.0	-43.26	4.02	3.00	12.45	-34.83	-13.00	21.83	H
5197.5	-47.93	5.11	3.00	13.38	-39.66	-13.00	26.66	H
3465.0	-50.19	4.02	3.00	12.45	-41.76	-13.00	28.76	V
5197.5	-54.83	5.11	3.00	13.38	-46.56	-13.00	33.56	V

LTE FDD Band 4 Channel Bandwidth 3MHz_16QAM_High Channel

Frequency (MHz)	PMea (dBm)	Pcl (dB)	Diatance	Ga Antenna Gain(dB)	EIRP (dBm)	Limit (dBm)	Margin (dB)	Polarization
3507.0	-46.14	4.02	3.00	12.21	-37.95	-13.00	24.95	H
5260.5	-47.32	5.11	3.00	13.26	-39.17	-13.00	26.17	H
3507.0	-51.73	4.02	3.00	12.21	-43.54	-13.00	30.54	V
5260.5	-53.38	5.11	3.00	13.26	-45.23	-13.00	32.23	V

LTE FDD Band 4 Channel Bandwidth 5MHz_16QAM_Low Channel

Frequency (MHz)	PMea (dBm)	Pcl (dB)	Diatance	Ga Antenna Gain(dB)	Peak EIRP (dBm)	Limit (dBm)	Margin (dB)	Polarization
3425.0	-45.75	4.02	3.00	12.5	-37.27	-13.00	24.27	H
5137.5	-48.57	5.11	3.00	13.38	-40.3	-13.00	27.3	H
3425.0	-50.99	4.02	3.00	12.5	-42.51	-13.00	29.51	V
5137.5	-52.29	5.11	3.00	13.38	-44.02	-13.00	31.02	V

LTE FDD Band 4 Channel Bandwidth 5MHz_16QAM_Middle Channel

Frequency (MHz)	PMea (dBm)	Pcl (dB)	Diatance	Ga Antenna Gain(dB)	EIRP (dBm)	Limit (dBm)	Margin (dB)	Polarization
3465.0	-43.97	4.02	3.00	12.45	-35.54	-13.00	22.54	H
5197.5	-47.21	5.11	3.00	13.38	-38.94	-13.00	25.94	H
3465.0	-50.2	4.02	3.00	12.45	-41.77	-13.00	28.77	V
5197.5	-54.74	5.11	3.00	13.38	-46.47	-13.00	33.47	V

LTE FDD Band 4 Channel Bandwidth 5MHz_16QAM_High Channel

Frequency (MHz)	PMea (dBm)	Pcl (dB)	Diatance	Ga Antenna Gain(dB)	EIRP (dBm)	Limit (dBm)	Margin (dB)	Polarization
3505.0	-46.1	4.02	3.00	12.21	-37.91	-13.00	24.91	H
5257.5	-47.28	5.11	3.00	13.26	-39.13	-13.00	26.13	H
3505.0	-51.57	4.02	3.00	12.21	-43.38	-13.00	30.38	V
5257.5	-53.09	5.11	3.00	13.26	-44.94	-13.00	31.94	V



LTE FDD Band 4 Channel Bandwidth 10MHz_16QAM_Low Channel

Frequency (MHz)	PMea (dBm)	Pcl (dB)	Diatance	Ga Antenna Gain(dB)	Peak EIRP (dBm)	Limit (dBm)	Margin (dB)	Polarization
3430.0	-44.86	4.02	3.00	12.5	-36.38	-13.00	23.38	H
5145.0	-47.93	5.11	3.00	13.38	-39.66	-13.00	26.66	H
3430.0	-51.05	4.02	3.00	12.5	-42.57	-13.00	29.57	V
5145.0	-52.84	5.11	3.00	13.38	-44.57	-13.00	31.57	V

LTE FDD Band 4 Channel Bandwidth 10MHz_16QAM_Middle Channel

Frequency (MHz)	PMea (dBm)	Pcl (dB)	Diatance	Ga Antenna Gain(dB)	EIRP (dBm)	Limit (dBm)	Margin (dB)	Polarization
3465.0	-43.75	4.02	3.00	12.45	-35.32	-13.00	22.32	H
5197.5	-47.22	5.11	3.00	13.38	-38.95	-13.00	25.95	H
3465.0	-50.4	4.02	3.00	12.45	-41.97	-13.00	28.97	V
5197.5	-54.65	5.11	3.00	13.38	-46.38	-13.00	33.38	V

LTE FDD Band 4 Channel Bandwidth 10MHz_16QAM_High Channel

Frequency (MHz)	PMea (dBm)	Pcl (dB)	Diatance	Ga Antenna Gain(dB)	EIRP (dBm)	Limit (dBm)	Margin (dB)	Polarization
3500.0	-46.13	4.02	3.00	12.5	-37.65	-13.00	24.65	H
5250.0	-47.64	5.11	3.00	13.38	-39.37	-13.00	26.37	H
3500.0	-51.25	4.02	3.00	12.5	-42.77	-13.00	29.77	V
5250.0	-53.26	5.11	3.00	13.38	-44.99	-13.00	31.99	V

LTE FDD Band 4 Channel Bandwidth 15MHz_16QAM_Low Channel

Frequency (MHz)	PMea (dBm)	Pcl (dB)	Diatance	Ga Antenna Gain(dB)	Peak EIRP (dBm)	Limit (dBm)	Margin (dB)	Polarization
3435.0	-44.98	4.02	3.00	12.5	-36.5	-13.00	23.5	H
5152.5	-48.41	5.11	3.00	13.38	-40.14	-13.00	27.14	H
3435.0	-51.67	4.02	3.00	12.5	-43.19	-13.00	30.19	V
5152.5	-52.76	5.11	3.00	13.38	-44.49	-13.00	31.49	V

LTE FDD Band 4 Channel Bandwidth 15MHz_16QAM_Middle Channel

Frequency (MHz)	PMea (dBm)	Pcl (dB)	Diatance	Ga Antenna Gain(dB)	EIRP (dBm)	Limit (dBm)	Margin (dB)	Polarization
3465.0	-43.96	4.02	3.00	12.45	-35.53	-13.00	22.53	H
5197.5	-47.62	5.11	3.00	13.38	-39.35	-13.00	26.35	H
3465.0	-50.78	4.02	3.00	12.45	-42.35	-13.00	29.35	V
5197.5	-54.28	5.11	3.00	13.38	-46.01	-13.00	33.01	V

LTE FDD Band 4 Channel Bandwidth 15MHz_16QAM_High Channel

Frequency (MHz)	PMea (dBm)	Pcl (dB)	Diatance	Ga Antenna Gain(dB)	EIRP (dBm)	Limit (dBm)	Margin (dB)	Polarization
3495.0	-46.57	4.02	3.00	12.5	-38.09	-13.00	25.09	H
5242.5	-47.18	5.11	3.00	13.38	-38.91	-13.00	25.91	H
3495.0	-51.62	4.02	3.00	12.5	-43.14	-13.00	30.14	V
5242.5	-53.65	5.11	3.00	13.38	-45.38	-13.00	32.38	V

LTE FDD Band 4 Channel Bandwidth 20MHz_16QAM_Low Channel

Frequency (MHz)	PMea (dBm)	Pcl (dB)	Diatance	Ga Antenna Gain(dB)	Peak EIRP (dBm)	Limit (dBm)	Margin (dB)	Polarization
3440.0	-45.25	4.02	3.00	12.5	-36.77	-13.00	23.77	H
5160.0	-48.19	5.11	3.00	13.38	-39.92	-13.00	26.92	H
3440.0	-50.75	4.02	3.00	12.5	-42.27	-13.00	29.27	V
5160.0	-52.47	5.11	3.00	13.38	-44.2	-13.00	31.2	V



LTE FDD Band 4 Channel Bandwidth 20MHz_16QAM_Middle Channel

Frequency (MHz)	PMea (dBm)	Pcl (dB)	Diatance	Ga Antenna Gain(dB)	EIRP (dBm)	Limit (dBm)	Margin (dB)	Polarization
3465.0	-43.98	4.02	3.00	12.45	-35.55	-13.00	22.55	H
5197.5	-47.71	5.11	3.00	13.38	-39.44	-13.00	26.44	H
3465.0	-50.31	4.02	3.00	12.45	-41.88	-13.00	28.88	V
5197.5	-53.86	5.11	3.00	13.38	-45.59	-13.00	32.59	V

LTE FDD Band 4 Channel Bandwidth 20MHz_16QAM_High Channel

Frequency (MHz)	PMea (dBm)	Pcl (dB)	Diatance	Ga Antenna Gain(dB)	EIRP (dBm)	Limit (dBm)	Margin (dB)	Polarization
3490.0	-46.27	4.02	3.00	12.5	-37.79	-13.00	24.79	H
5235.0	-47.19	5.11	3.00	13.38	-38.92	-13.00	25.92	H
3490.0	-51.13	4.02	3.00	12.5	-42.65	-13.00	29.65	V
5235.0	-53.36	5.11	3.00	13.38	-45.09	-13.00	32.09	V



3.7 Frequency Stability under Temperature & Voltage Variations

LIMIT

According to §27.54, §2.1055 requirement, the frequency stability shall be sufficient to ensure that the fundamental emissions stay within the authorized bands of operation and should not exceed 2.5ppm.

TEST CONFIGURATION

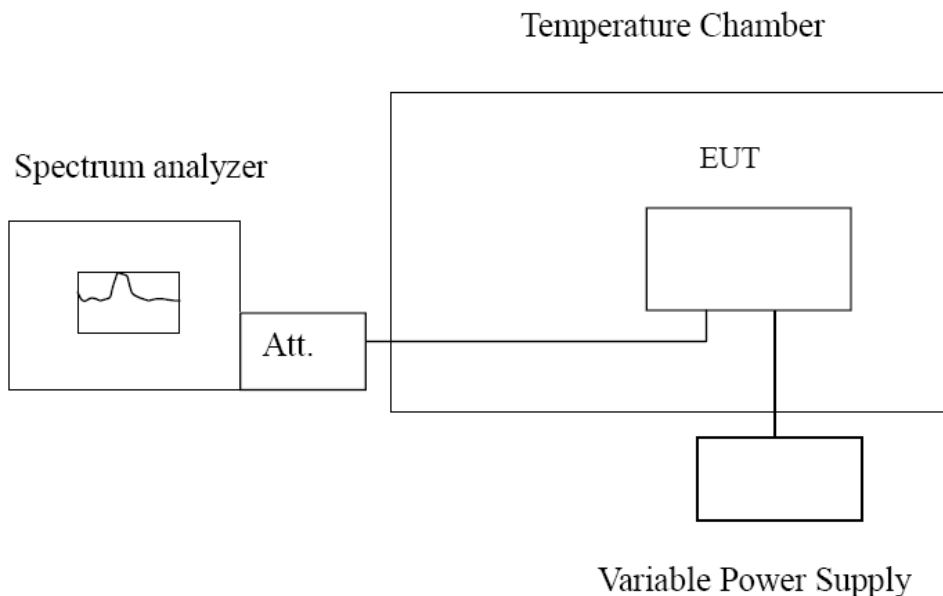

TEST PROCEDURE

The EUT was setup according to EIA/TIA 603D

Frequency Stability Under Temperature Variations:

In order to measure the carrier frequency under the condition of AFC lock, it is necessary to make measurements with the EUT in a "call mode". This is accomplished with the use of R&S CMW500 DIGITAL RADIO COMMUNICATION TESTER.

1. Measure the carrier frequency at room temperature.
2. Subject the EUT to overnight soak at -30°C.
3. With the EUT, powered via nominal voltage, connected to the CMW500 and in a simulated call on middle channel for LTE band 4, measure the carrier frequency. These measurements should be made within 2 minutes of Powering up the EUT, to prevent significant self-warming.
4. Repeat the above measurements at 10°C increments from -30°C to +50°C. Allow at least 1.5 hours at each temperature, unpowered, before making measurements.
5. Re-measure carrier frequency at room temperature with nominal voltage. Vary supply voltage from minimum voltage to maximum voltage, in 0.1Volt increments re-measuring carrier frequency at each voltage. Pause at nominal voltage for 1.5 hours unpowered, to allow any self-heating to stabilize, before continuing.
6. Subject the EUT to overnight soak at +50°C.
7. With the EUT, powered via nominal voltage, connected to the CMW500 and in a simulated call on the centre channel, measure the carrier frequency. These measurements should be made within 2 minutes of Powering up the EUT, to prevent significant self-warming.
8. Repeat the above measurements at 10 °C increments from +50°C to -30°C. Allow at least 1.5 hours at each temperature, unpowered, before making measurements
9. At all temperature levels hold the temperature to +/- 0.5°C during the measurement procedure.

Frequency Stability Under Voltage Variations:

Set chamber temperature to 20°C. Use a variable AC power supply / DC power source to power the EUT and set the voltage to rated voltage. Set the spectrum analyzer RBW low enough to obtain the desired frequency resolution and recorded the frequency.

Reduce the input voltage to specify extreme voltage variation ($\pm 15\%$) and endpoint, record the maximum frequency change.

**TEST RESULTS**

Remark:

1. We tested all RB Configuration refer 3GPP TS136 521 for each Channel Bandwidth of LTE FDD Band 4; recorded worst case.

LTE Band 4, 1.4MHz bandwidth , QPSK (worst case of all bandwidths)

LTE FDD Band 4					
DC Power	Temperature (°C)	Frequency error(Hz)	Frequency error(ppm)	Limit (ppm)	Verdict
3.40	20	-11.66	-0.006816	2.50	PASS
3.60	20	-9.13	-0.005337	2.50	PASS
4.20	20	8.20	0.004793	2.50	PASS
3.60	-30	-12.02	-0.006938	2.50	PASS
3.60	-20	-12.90	-0.007446	2.50	PASS
3.60	-10	-8.21	-0.004739	2.50	PASS
3.60	0	-9.98	-0.005689	2.50	PASS
3.60	10	-12.53	-0.007142	2.50	PASS
3.60	20	-11.54	-0.006578	2.50	PASS
3.60	30	-9.86	-0.005764	2.50	PASS
3.60	40	-12.55	-0.007336	2.50	PASS
3.60	50	-12.06	-0.007050	2.50	PASS

LTE Band 4, 1.4MHz bandwidth , 16QAM (worst case of all bandwidths)

LTE FDD Band 4					
DC Power	Temperature (°C)	Frequency error(Hz)	Frequency error(ppm)	Limit (ppm)	Verdict
3.40	20	-9.93	-0.005732	2.50	PASS
3.60	20	-11.17	-0.006447	2.50	PASS
4.20	20	-8.48	-0.004895	2.50	PASS
3.60	-30	-11.70	-0.006669	2.50	PASS
3.60	-20	-12.32	-0.007023	2.50	PASS
3.60	-10	-12.72	-0.007251	2.50	PASS
3.60	0	-7.12	-0.004160	2.50	PASS
3.60	10	-10.59	-0.006188	2.50	PASS
3.60	20	-13.25	-0.007742	2.50	PASS
3.60	30	-11.30	-0.006522	2.50	PASS
3.60	40	-10.51	-0.006066	2.50	PASS
3.60	50	-9.93	-0.005732	2.50	PASS

***** End of Report *****