

# Quick Installation Guide

AX1800 Dual-Band Wi-Fi 6 Router

RSD0619

Quick Installation Guide

Contact rock space

Shenzhen Renqing Excellent Technology Co., Ltd.

Shenzhen Renqing Excellent Technology Co. Ltd.  
Address: 104, No.15, Longhua Industrial Zone, Huangang Road, Tongsheng Community, Daling Street, Longhua District, Shenzhen, China

## I. Basic Installation

If you want to copy the PPPoE user name and password from your original router, start from **Step 1**. Otherwise, start from **Step 2**.

### Step 1: Input your PPPoE user name and password from your original router.

1. Power on your original and new routers.
2. Connect the WAN port of the original router to a LAN port of the new router using an Ethernet cable.
3. When the WAN and LAN LED indicators of the new router turn solid on for 3 seconds after blinking fast, the PPPoE user name and password are inputted to your new router successfully.
4. Remove the original router.

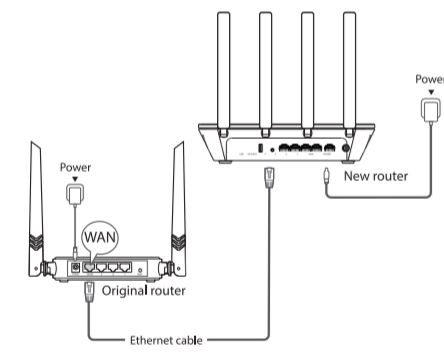

### Step 2: Connect your new router to the internet.

1. Power on the new router.
2. Connect the WAN port of the new router to the LAN port of your modem or the Ethernet jack using an Ethernet cable. The WAN LED indicator lights on.

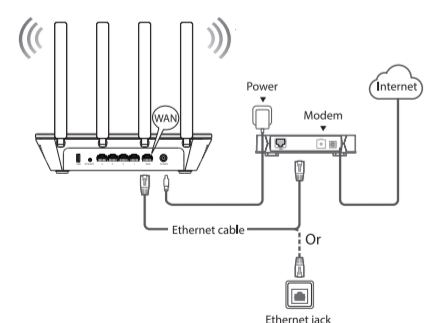

## II. Wireless Network Settings

### Method 1: Setup via RS WIFI APP

Before you start, download the RS WIFI App on your mobile device (smart phone or tablet). A smart phone is used for illustration here.

1. Connect your smart phone to the WiFi network of the router (the default WiFi network information is labeled on the bottom of the router).

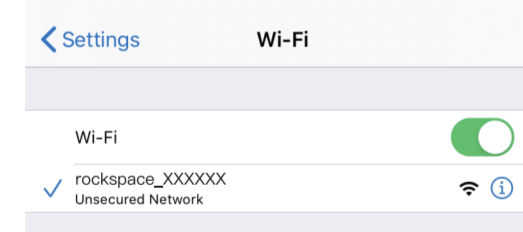

### 2. Open the RS WIFI App.



3. The App will detect your Connection Type automatically. If your Internet connection type is PPPoE, enter your PPPoE user name and password and tap "Next". If your internet connection type is dynamic IP, tap "Next". If your internet connection type is static IP, enter your IP address and other information your ISP provides, and tap "Next".

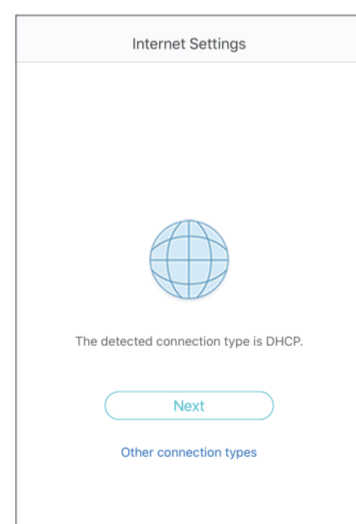

### 4. Customize the WiFi Name and WiFi Password.



### 5. Tap OK.

After the configuration is completed, Android phones will connect to the WiFi network you just set automatically. iPhone users need to connect to the new WiFi network manually. Then, you can access the internet and manage your WiFi network on the RS WIFI App.

6. After setting up the router, you could go back to the setting page of the App and **reconnect** the wifi with your personal account and password

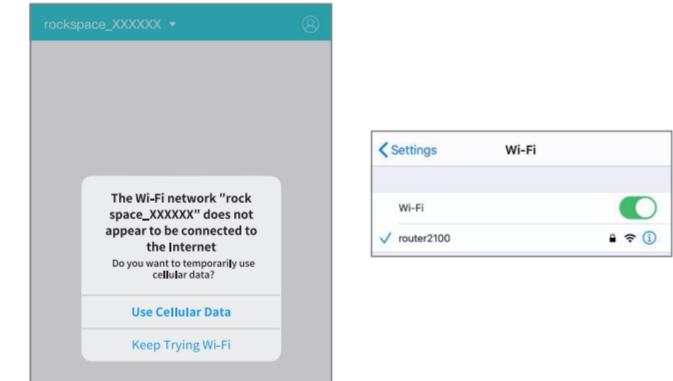

### 7. Finish wifi connection and return to the App, click **Control Now** to manage the router



### WiFi Name & Password

In this section, you can view and change the WiFi name and password of the WiFi network of the router.

#### Procedures:

- Step 1. Open the RS WIFI App, and choose Tools > WiFi Name & Password.
- Step 2. Customize the WiFi Name and WiFi Password.
- Step 3. Select a Security Mode (WPA/WPA2 mixed is recommended).
- Step 4. (Optional) Enable Hide WiFi Network.
- Step 5. Tap Save.

Notes: Please wait with patience if the router takes a bit longer to reboot at the last step of the settings.

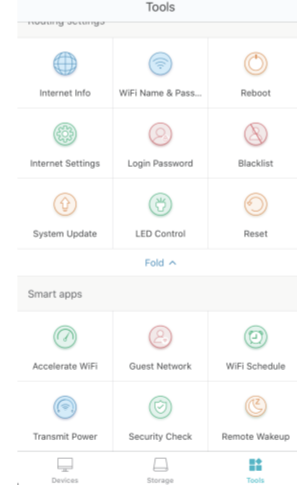

## Method 2: Web UI Setting

### Internet Setting Login in via IP Address:

- Step 1. Connect to the wireless network (the SSID name of the router has been provided on the back of the router, which could be customized in the following settings)

- Step 2. Open your browser on your device and enter **192.168.0.1** in the address bar and press Start on the start page.

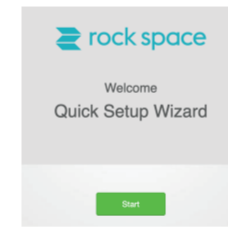

- Step 3. Select your **Connection Type**. The router supports three connection types: PPPoE, Dynamic IP Address, and Static IP Address.

Auto configuration will show up here. You could select the specific kind of connection type that fits in your network by providing information as required. Click "Next".

#### NOTES:

- If your Internet connection type is PPPoE, enter your PPPoE user name and password and tap "Next".
- If your internet connection type is dynamic IP, tap "Next".
- If your internet connection type is static IP, enter your IP address and other information your ISP provides, and tap "Next".

#### Please select your connection type:

As selected, your connection type may be Dynamic IP Address

Connection Type: Dynamic IP Address

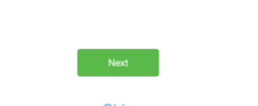

- Step 4. Here comes the SETUP page. Personalize your network by inputting a name and password for it. You can also share the wifi password with login password, otherwise input another one down below for the login password. Click "Next".

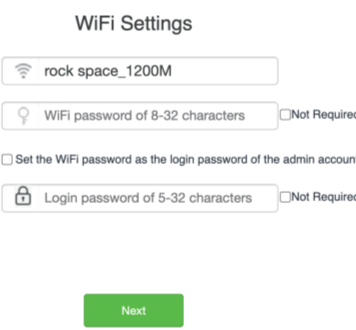

### Now you successfully complete the setup on the website.

You're all set! You can now connect to rock space\_1200M

- After this setting, the router will reboot again. Go to your wifi network list and find the SSID named by yourself. Connect to the AC2100 router by entering the new password.

- Step 5. Open your browser on your device and enter 192.168.0.1 in the address bar and input your login password (which has been set before). Click "Login"

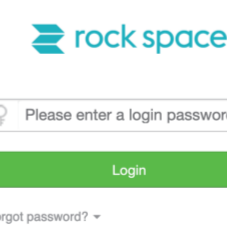

- Step 6. Here you are successfully connect to the new wifi network and you can customize the functions you need on this page. There are different settings on the left side.

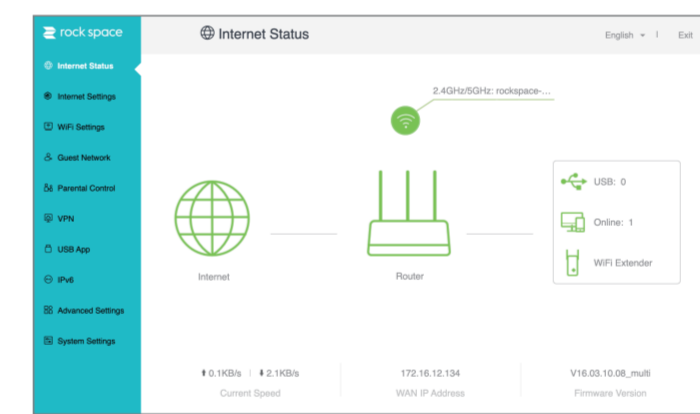

### Dual Band Setting

- 1) Go to WiFi Setting right on the left column and select WiFi Name & Password, you could customize your private network name and password here.

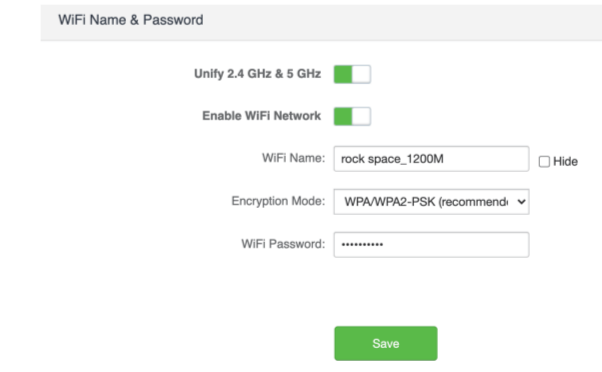

- 2) Close the button of the Selection Unify 2.4GHz & 5 GHz, you could modify WiFi SSID Name and Password separately for two bands and then click "Save".



- 3) The router will reboot and you can reconnect by applying the new customized network SSID and password in a few seconds.

### Firmware Upgrade

Go to System Setting and choose firmware upgrade. The latest version would be available if there's one. You could select the online upgrade or local upgrade here.

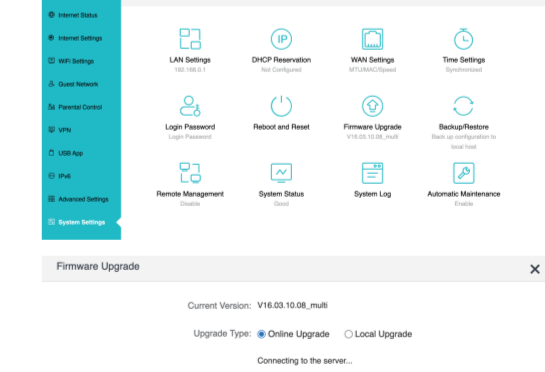

**FAQ**  
**Q: How can I reset the router?**  
**A:** Press physical 'Reset' button for about 3 secs and guarantee that your device is on power. Release it and it will reboot within 15 seconds.  
**Q: What if I forget my password of the router?**  
**A:** You can reset the router and login to the router to set it up again. Go to Tools-WiFi Name & Password to customize it for your own.  
**Q: How can I update the firmware?**  
**A:** Go to the WiFi app and choose 'Tools-System Update-Upgrade Now'. Do not power off the router during the process. The router will reboot when the update is finished.  
**Q: How can I update the firmware manually?**  
**A:** You can follow the router 'Tools-Internet Setting' and choose the type you want or consult your ISP for reference.  
**Q: How can I select my connection type?**  
**A:** Please make sure that your ISP's band can and not be blocked. In this case, you can check the status of 5GHz through Tools-WiFi Name & Password. Turn on the 5GHz band if it's OK.  
**Q: What if the app could not recognize the device or connect to the device?**  
**A:** First please make sure that your Ethernet cable with Internet connection is securely plugged into the WAN port rather than LAN port.  
**Q: What if the app could not recognize the device or connect to the device?**  
**A:** Please make sure that your routers are securely connected to the SSID that belongs to the mesh network.  
**Q: How can I connect to the router?**  
**A:** Step 1. Click the WiFi Name of router right on the upper left side.  
**Q: How can I connect to the router?**  
**A:** Step 2. Click the "+" and choose Router to add your device.  
**Q: How can I connect to the router?**  
**A:** Step 3. The app will detect the device in this case and click Control Now to get it work. Connection is now successful. This approach could be applied in any situation when you reconnect the router and it fails to reset immediately.

**FCC Statement**  
 This equipment has been tested and found to comply with the limits for a Class B digital device, pursuant to part 15 of the FCC rules. These limits are designed to provide reasonable protection against harmful interference in a residential installation. This equipment generates, uses and can radiate radio frequency energy and, if not installed and used in accordance with the instructions, may cause harmful interference to radio communications. However, there is no guarantee that interference will not occur in a particular installation. If this equipment does cause harmful interference to radio or television reception, which can be determined by turning the equipment off and on, the user is encouraged to try to correct the interference by one or more of the following measures:  
 —Reorient or relocate the receiving antenna.  
 —Increase the separation between the equipment and receiver.  
 —Connect the equipment into an outlet on a circuit different from that to which the receiver is connected.  
 —Consult the dealer or an experienced radio/TV technician for help.

**FCC Radiation Exposure Statement**  
 This device complies with FCC radiation exposure limits set forth for an uncontrolled environment and it also complies with Part 15 of the FCC RF Rules. This equipment must be installed and operated in accordance with provided instructions and the user must use the PPE equipment must be installed by providing a separation distance of at least 20 cm. This device must accept any interference received, including interference that may cause undesired operation.  
**Caution:**  
 Any changes or modifications not expressly approved by the party responsible for compliance could void the user's authority to operate the equipment.

Contact rock space  
 Shenzhen Renqing Excellent Technology Co., Ltd.  
 Address: 104, No. 15, Longhua Industrial Zone, Huangang Road, Tongsheng Community, Daling Street, Longhua District, Shenzhen, China  
 Email: rs@rock-space.com  
 Website: www.rock-space.com  
 Technical Phone Support: +8613318166558  
 Service Time: 9:00-17:00 (PST), 9:00-18:00 from Monday to Friday