

# Smart Plotter ZC2

Product Manual

## Product List

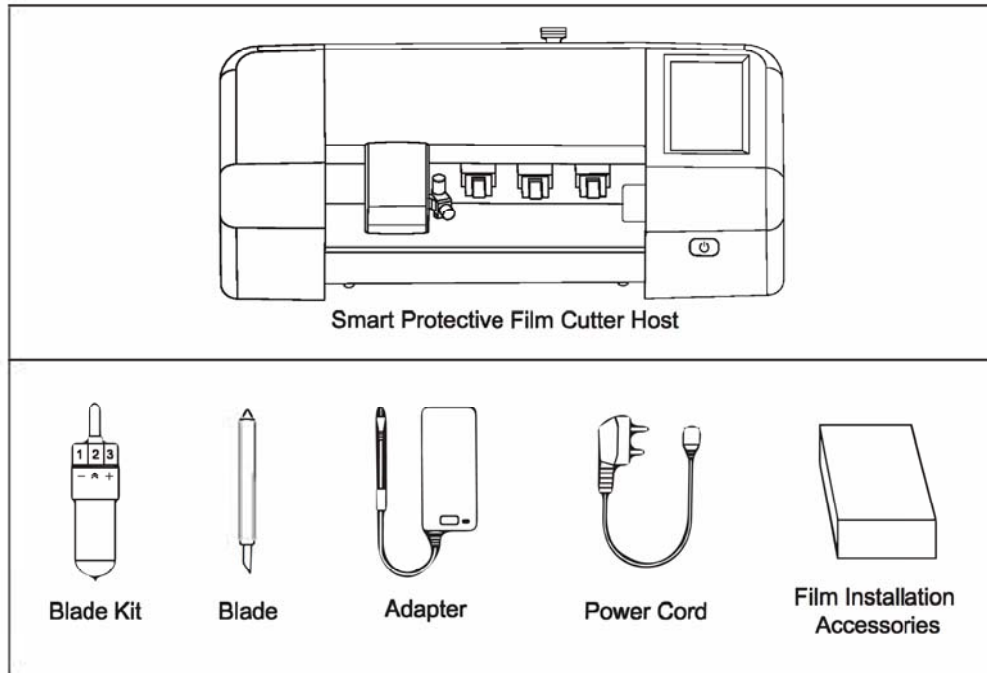

## Appearance And Function

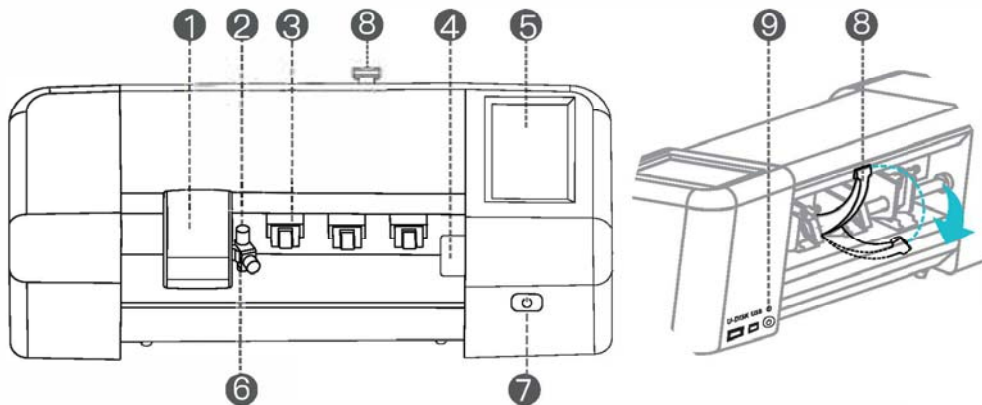

- |  |  |
|--|--|
| <p><b>1 Driver</b><br/>Control the lateral movement of the Blade Kit</p> <p><b>2 Blade Kit</b><br/>Cutting protective film See details 10, 11, 12, 13</p> <p><b>3 Platen Roller</b><br/>Fixes protective film</p> <p><b>4 Lateral Panel</b><br/>Set limit of position and movement for protective film</p> | <p><b>5 QR code sticker</b><br/>Scan code to download APP.</p> <p><b>6 Power Switch,</b><br/>Starting device</p> <p><b>7 Power Interface</b><br/>Link power</p> <p><b>8 Pressing Bar</b><br/>Press to control the platen roller to lift or fall</p> <p><b>9 Blade Kit Clamp</b><br/>Lock the knife handle to secure the blade kit<br/>*The U-DISK and USB not used</p> |
|--|--|

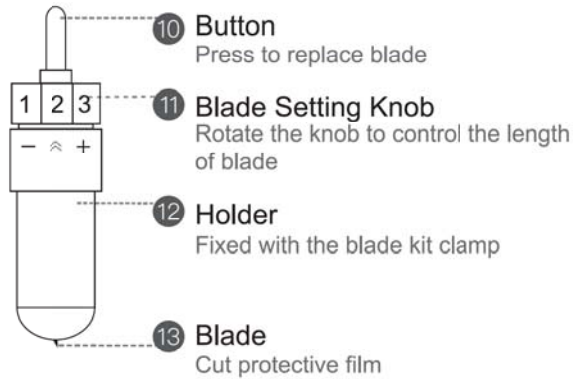

**Notice:**

**Adjust blade:**

Rotate the knob 11 to control the length of the blade. Lengthen the blade in the direction of symbol "+" and shorten the blade in the direction of symbol "-".

**Replace blade:**

Press the button 10 to remove the old blade and then put in the new blade 13. (The built-in magnet can absorb the blade)

# Instructions

## 1. Installing Install blade kit

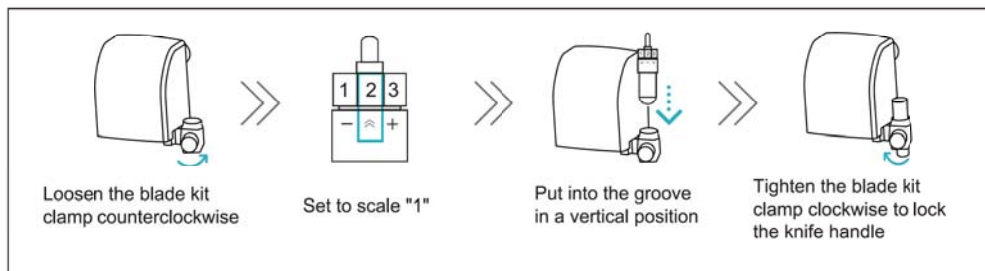

## 2. Power on

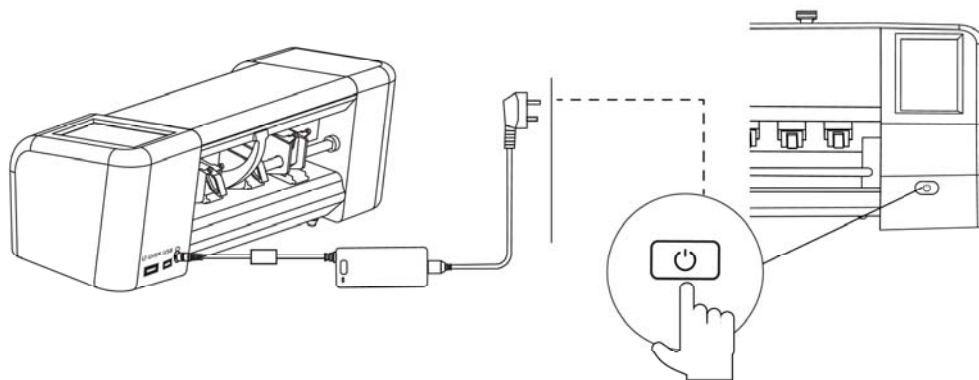

Connect the power cord to the adapter and then connect the power cord to the power socket. To ensure the normal operation of the device, please use 100-240 volts AC power; Connect the adapter to the power interface of the device; Install the blade kit on the knife holder to ensure it is fixed correctly. After connecting, press [Power Switch] to start the device.

### 3. Cut Film

When using it for the first time, you need to click [select language] to complete the language setting, then you need to click [set Bluetooth] to complete Bluetooth connection

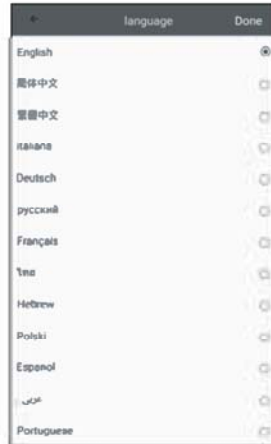

- (1). Please prepare a protective film to be cut as shown in the figure. Confirm that the protective film is flat and complete, without bending, folding or missing layer.



- (2). Press down the pressing bar to lift the platen roller, and place the protective film in the dotted area as shown.

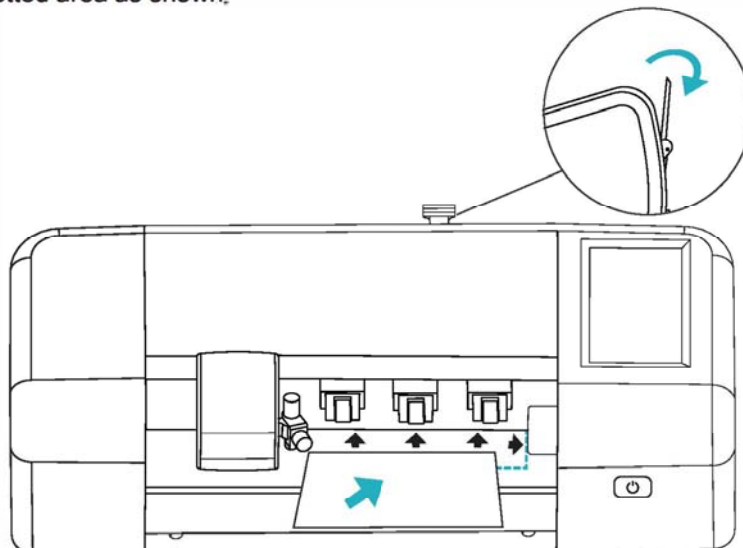

(3)、Slowly lift the pressing bar so that the platen roller presses the protective film.

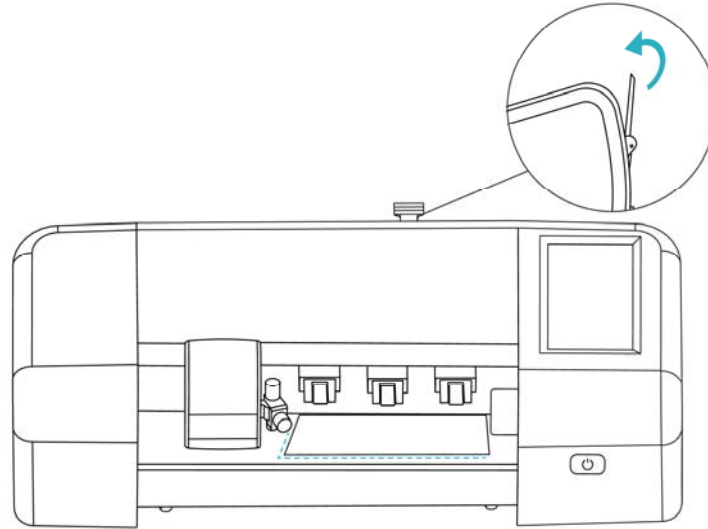

(4)、After the system starts normally, enters the home page.

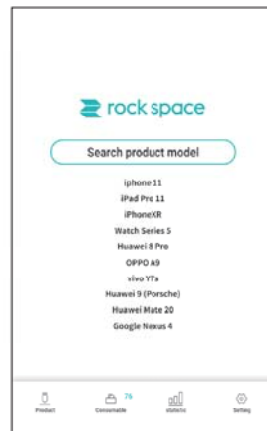

(5)、Enter keywords in the search box to search for the product model you need to cut; select the appropriate protective film.

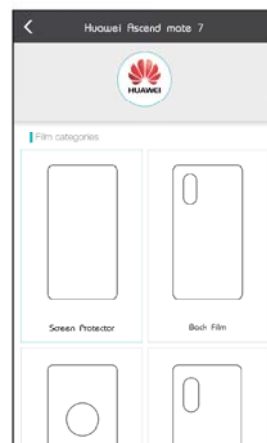

- (6). After checking that the protective film has been placed correctly, click **[OK]** to start cutting.

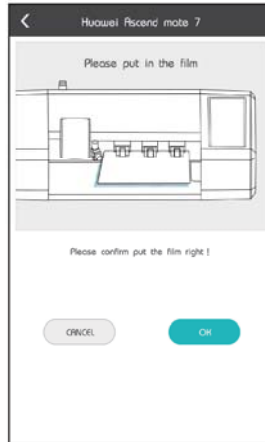

- (7). After cutting, the protective film will be pushed out automatically. Take out the protective film and finish cutting.

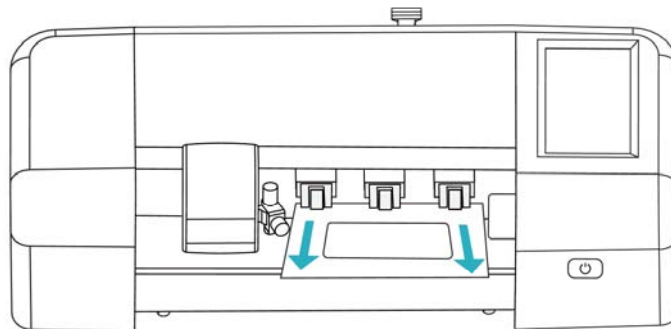



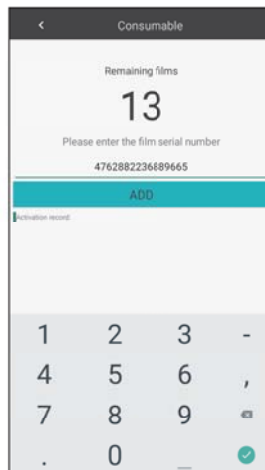

## 4. Activate Film Code

Enter [Consumable identification code] found on the protective film package box, and then click [ADD].

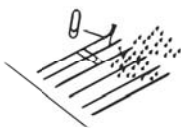

<b>Product Specification</b>	
Bluetooth version	Bluetooth4.2
Input	24V 2.75A
Size	508x183x178mm
Net Weight	6.0 kg

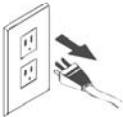
## Cautions

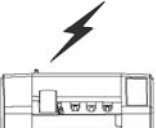
	<p>Don't touch the tip of the blade with your finger. It will hurt your finger.</p>
	<p>Liquid or metal objects are not allowed to enter into the machine These objects can cause fires.</p>
	<p>Do not destroy or arbitrarily replace the original power cord, Do not bend, pull or bind the power cord excessively or place the power cord under heavy object. This can cause damage to the power supply, resulting in an electric shock or fire.</p>
	<p>If you do not use the device for a long time, remove the power cord from the socket Otherwise, it will cause a fire.</p>
	<p>The device should be placed on a firm surface Otherwise, the device will fall down and get damaged.</p>
	<p>When the power cord is unplugged from the socket, the plug should be unplugged instead of the cable Pulling a cable strongly can cause an electric shock or fire</p>
	<p>It is forbidden to use in thunderstorm and lightning weather. Lest the machine be damaged by electric shocks</p>

**This device complies with part 15 of the FCC Rules. Operation is subject to the following two conditions:**

(1) This device may not cause harmful interference, and (2) this device must accept any interference received, including interference that may cause undesired operation.

Any changes or modifications not expressly approved by the party responsible for compliance could void the user's authority to operate the equipment.

This equipment has been tested and found to comply with the limits for a Class B digital device, pursuant to part 15 of the FCC Rules. These limits are designed to provide reasonable protection against harmful interference in a residential installation. This equipment generates, uses and can radiate radio frequency energy and, if not installed and used in accordance with the instructions, may cause harmful interference to radio communications. However, there is no guarantee that interference will not occur in a particular installation. If this equipment does cause harmful interference to radio or television reception, which can be determined by turning the equipment off and on, the user is encouraged to try to correct the interference by one or more of the following measures:

- Reorient or relocate the receiving antenna.
- Increase the separation between the equipment and receiver.
- Connect the equipment into an outlet on a circuit different from that to which the receiver is connected.
- Consult the dealer or an experienced radio/TV technician for help.





**FCC Radiation Exposure Statement**

This equipment complies with FCC radiation exposure limits set forth for an uncontrolled environment.

This transmitter must not be co - located or operating in conjunction with any other antenna or transmitter.

This equipment should be installed and operated with minimum distance 20cm between the radiator&your body.

## Precautions

-  Press the power button to stop urgently during
-  Please don't move the driver manually when powered on to avoid damage to the machine.
-  Please don't touch or bump the blade against anything hard for it is sharp and fragile.
-  In order to ensure perfect cutting effect, it is suggested to replace the blade and the rubber strip every 500 times of cutting or 3 months of use.
-  Please shut down the machine normally through the App, and please don't unplug the power cable directly, for it may cause irreversible damage to the machine.



If you are a user beyond China, please scan the QR code to follow us in Facebook for more information.