



Test Report No.:
FCCSZ2024-0065-RF3

RF Test Report

FCC ID : 2AUA5-P2

NAME OF SAMPLE : Smart Desktop Terminal

APPLICANT : IMachine(Xiamen)Intelligent Devices Co.,Ltd.

CLASSIFICATION OF TEST : N/A

CVC Testing Technology (Shenzhen) Co., Ltd.



Applicant		Name:IMachine(Xiamen)Intelligent Devices Co.,Ltd. Address:7F-2,No.88-1,Tonghui South Road,Tongan,Xiamen,China.	
Manufacturer		Name:IMachine(Xiamen)Intelligent Devices Co.,Ltd. Address:7F-2,No.88-1,Tonghui South Road,Tongan,Xiamen,China.	
Equipment Under Test		Product Name:Smart Desktop Terminal Model/Type: P2 Additional Model/Type: See Chapter 2.1 Brand Name: N/A Serial NO.: N/A Sample NO.:2-1	
Date of Receipt.	2024.08.27	Date of Testing	2024.08.27~2024.11.06
Test Specification		Test Result	
FCC Part 15, Subpart E (15.407)		PASS	
Evaluation of Test Result	The equipment under test was found to comply with the requirements of the standards applied. Seal of CVC Issue Date:2024.11.06		
Compiled by: <u>Liang Jiatong</u> Name Signature	Reviewed by: <u>Mo Xianbiao</u> Name Signature	Approved by: <u>Dong Sanbi</u> Name Signature	
Other Aspects: NONE.			
Abbreviations:OK, Pass= passed Fail = failed N/A= not applicable EUT= equipment, sample(s) under tested			

This test report relates only to the EUT, and shall not be reproduced except in full, without written approval of CVC.



TABLE OF CONTENTS

RELEASE CONTROL RECORD	4
1 SUMMARY OF TEST RESULTS	5
1.1 LIST OF TEST AND MEASUREMENT INSTRUMENTS	6
1.2 MEASUREMENT UNCERTAINTY	8
1.3 TEST LOCATION	9
2 GENERAL INFORMATION	10
2.1 GENERAL PRODUCT INFORMATION	10
2.2 CARRIER FREQUENCY AND CHANNEL	12
2.3 TEST MODE APPLICABILITY AND TESTED CHANNEL DETAIL	15
2.4 DESCRIPTION OF SUPPORT UNITS	16
2.5 GENERAL DESCRIPTION OF APPLIED STANDARDS	16
3 TEST TYPES AND RESULTS	17
3.1 CONDUCTED EMISSION MEASUREMENT	17
3.2 RADIATED EMISSION AND BANDEDGE MEASUREMENT	22
3.3 OCCUPIED BANDWIDTH MEASUREMENT	50
3.4 26DB EMISSION BANDWIDTH	51
3.5 6DB EMISSION BANDWIDTH	52
3.6 TRANSMIT POWER MEASUREMENT	53
3.7 POWER SPECTRAL DENSITY MEASUREMENT	54
3.8 FREQUENCY STABILITY	55
3.9 ANTENNA REQUIREMENT	56
4 PHOTOGRAPHS OF TEST SETUP	57
5 PHOTOGRAPHS OF THE EUT	58



RELEASE CONTROL RECORD

ISSUE NO.	REASON FOR CHANGE	DATE ISSUED
FCCSZ2024-0065-RF3	Original release	2024.11.06

1 SUMMARY OF TEST RESULTS

The EUT has been tested according to the following specifications:

APPLIED STANDARD: FCC PART 15, SUBPARTE (SECTION 15.407)			
STANDARD SECTION	TEST TYPE	RESULT	REMARK
FCC 15.207	AC Power Conducted Emission	PASS	See section 3.1
FCC 15.403(a)(e)	6dB&26dB Emission Bandwidth	PASS	Appendix A1&A3 of FCCSZ2024-0065-RF3-A1
---	Occupied Bandwidth Measurement	PASS	Appendix A2 of FCCSZ2024-0065-RF3-A1
FCC 15.407(b)	Radiated Emission and Bandedge	PASS	See section 3.2
FCC 15.407(a)	Transmit Power	PASS	Appendix C of FCCSZ2024-0065-RF3-A1
FCC 15.407(a)	Power Spectral Density	PASS	Appendix D of FCCSZ2024-0065-RF3-A1
FCC 15.407(g)	Frequency Stability	PASS	Appendix E of FCCSZ2024-0065-RF3-A1
FCC 15.203 FCC 15.407(a)	Antenna Requirement	PASS	See section 3.9



1.1 LIST OF TEST AND MEASUREMENT INSTRUMENTS

Equipment	Manufacturer	Model No.	Serial Number	Cal. interval	Cal. Due
Antenna Port Conducted Test					
Signal&Spectrum Analyzer	Rohde&Schwarz	FSV 30	104408	1 year	2025.5.22
#4Shielding room	MORI	443	N/A	3 year	2026.5.16
Wideband radio communication tester	Rohde&Schwarz	CMW 500	168588	1 year	2025.5.24
Analog signal Generator(100kHz~12.75GHz)	Rohde&Schwarz	SMB 100A	181882	1 year	2025.4.27
Vector signal Generator(8kHz~6GHz)	Rohde&Schwarz	SMBV 100B	101846	1 year	2025.4.28
DC power supply	Rohde&Schwarz	HMC8041-G	101203	1 year	2025.4.29
RF control unit(2/3/4/5G)	Tonscend	JS0806-1	CS0300027	1 year	2025.4.28
Automatic filter bank(2/3/4G)	Tonscend	JS0806-F	CS0300028	1 year	2025.4.28
Automatic filter bank(5G)	Tonscend	JS0806-F-5G NR	N/A	1 year	2025.4.28
Temperature and humidity meter	UNI-T	A10T	C193561464	1 year	2025.4.27
Radio Communication Analyzer	Anritsu	MT8821C	6272374548	1 year	2025.1.09
Constant temperature humidity chamber	TEELONG	TL-HW-225B	20220518-01	1 year	2025.5.24
Radio Communication Test Station	Anritsu	MT8000A	6272354169	1 year	2025.1.09
Radiation Spurious					
Signal&Spectrum Analyzer	Rohde&Schwarz	FSV 40	101898	1 year	2025.4.28
EMI Test Receiver	Rohde&Schwarz	ESR3	102693	1 year	2025.5.24
Antenna(30MHz~1001MHz)	SCHWARZBECK	VULB 9168	1133	1 year	2025.2.21
Horn antenna(1GHz-18GHz)	ETS	3117	227611	1 year	2025.3.24
Horn antenna(18GHz-40GHz)	QMS	QMS-00880	22051	1 year	2025.3.24
3m anechoic chamber	MORI	966	CS0300011	3 year	2026.5.18
Filter group(RSE-BT/WiFi)	Rohde&Schwarz	WiFi /BT Variant 1	100820	1 year	2025.4.28
Filter group(RSE-Cellular)	Rohde&Schwarz	Cellular Variant 1	100768	1 year	2025.4.28
Preamplifier(1GHz-18GHz)	Rohde&Schwarz	SCU-18F	100799	1 year	2025.4.28
Preamplifier(1GHz-18GHz)	Rohde&Schwarz	SCU-18F	100801	1 year	2025.4.28
Preamplifier(18Gz-40GHz)	Rohde&Schwarz	SCU-40A	101209	1 year	2025.4.28
#2 control room	MORI	433	CS0200059	3 year	2026.5.16
Temperature and humidity meter	/	C193561517	C193561517	1 year	2025.4.27



RE Test - 3M Chamber					
Equipment	Manufacturer	Model No.	Serial Number	Cal. interval	Cal. Due
EMI Test Receiver	Rohde&Schwarz	ESR 26	101718	1 year	2025.5.24
Antenna(30MHz~1000MHz)	SCHWARZBECK	VULB 9168	01132	1 year	2025.4.25
Horn antenna(1GHz-18GHz)	ETS	3117	227634	1 year	2025.3.24
Horn antenna(18GHz-40GHz)	SCHWARZBECK	BBHA 9170	01003	1 year	2025.3.25
3m anechoic chamber	MORI	966	CS0200019	3 year	2026.5.18
Preamplifier(1GHz-18GHz)	Tonscend	TAP-051845	AP22G806257	1 year	2025.4.28
Attenuator	/	SJ-5dB	607684	1 year	2025.2.21
#1 control room	MORI	433	CS0300028	3 year	2026.5.16
Temperature and humidity meter	UNI-T	A10T	C193561473	1 year	2025.4.27
Conducted emission					
Equipment	Manufacturer	Model No.	Serial Number	Cal. interval	Cal. Due
EMI Test Receiver	Rohde&Schwarz	ESR3	102694	1 year	2025.5.24
Voltage probe	Rohde&Schwarz	CVP9222C	28	1 year	2025.4.27
Current probe	Rohde&Schwarz	EZ-17	101442	1 year	2025.4.28
ISN network	Rohde&Schwarz	ENV 81	100401	1 year	2025.4.28
ISN network	Rohde&Schwarz	ENV 81 Cat6	101896	1 year	2025.4.28
ISN network	Rohde&Schwarz	NNLK&8129RC	05021	1 year	2025.4.27
#1Shielding room	MORI	854	N/A	3 year	2026.5.16

1.2 MEASUREMENT UNCERTAINTY

Where relevant, the following measurement uncertainty levels have been estimated for tests performed on the EUT as specified in CISPR 16-4-2:

No.	Item	Measurement Uncertainty
1	Occupied Channel Bandwidth	±1.86 %
2	RF output power, conducted	±0.9 dB
3	Power Spectral Density, conducted	±0.8 dB
4	Conducted emission test	+/-2.7 dB
5	Radiated emission 9kHz-30MHz	+/-5.6 dB
	Radiated emission 30MHz-1GHz	+/-4.6 dB
	Radiated emission 1GHz-18GHz	+/-4.4 dB
	Radiated emission 18GHz-40GHz	+/-5.1 dB
6	Temperature	±0.73 °C
7	Humidity	±3.90 %
8	Supply voltages	±0.37 %
9	Time	±0.27 %

Remark: 95% Confidence Levels, k=2.

Only the measured values related to their corresponding limits will be used to decide whether the equipment under test meets the requirements of the test standards listed.

The measurement uncertainty is mentioned in this test report, but is not taken into account - neither to the limits nor to the measurement results. Measurement results with a smaller margin to the corresponding limits than the measurement uncertainty have a potential risk of more than 5% that the decision might be wrong.

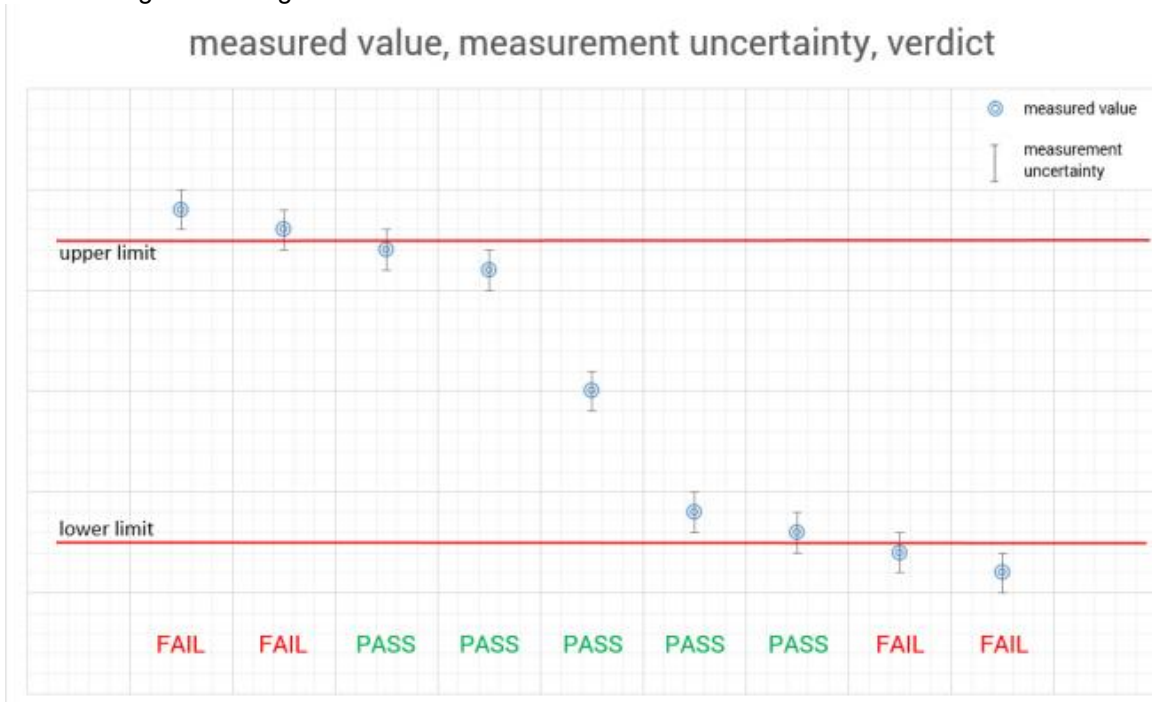

1.3 TEST LOCATION

The tests and measurements refer to this report were performed by EMC testing Lab. of CVC Testing Technology (Shenzhen) Co., Ltd.

Lab Address: No. 1301-14&16, Guanguang Road, Xinlan Community, Guanlan Subdistrict, Longhua District, Shenzhen, Guangdong, China

Post Code: 518110 Tel: 0755-23763060-8805

Fax: 0755-23763060 E-mail: sz-kf@cvc.org.cn

FCC(Test firm designation number: CN1363)

IC(Test firm CAB identifier number: CN0137)

CNAS(Test firm designation number: L16091)



2 GENERAL INFORMATION

2.1 GENERAL PRODUCT INFORMATION

PRODUCT	Smart Desktop Terminal		
BRAND	N/A		
TEST MODEL	P2		
ADDITIONAL MODEL	<p>P1、P2、P3、P5、P6、P7、P8、P9、P1S、P2S、P3S、P5S、P6S、P7S、P8S、P9S、P1 MINI、P2 MINI、P3 MINI、P5 MINI、P6 MINI、P7 MINI、P8 MINI、P9 MINI、P1 PLUS、P2 PLUS、P3 PLUS、P5 PLUS、P1Pro、P2Pro、P3Pro、P5Pro;</p> <p>A1、A2、A3、A5、A6、A7、A8、A9、A1S、A2S、A3S、A5S、A6S、A7S、A8S、A9S、A1 MINI、A2 MINI、A3 MINI、A5 MINI、A6 MINI、A7 MINI、A8 MINI、A9 MINI、A1 Plus、A2 PLUS、A3 PLUS、A5 PLUS、A1Pro、A2Pro、A3Pro、A5Pro、A1 PlusPro、A2PlusPro、A3 PlusPro、K1、K2、K3、K5、K6、K7、K8、K9、K1S、K2S、K3S、K5S、K6S、K7S、K8S、K9S、K1 PLUS、K1Pro、L1、L1 PLUS、L1Pro、L1S、M1、M1 PLUS、M1Pro、M1S、N1、N1 PLUS、N1Pro、N1S、Q1、Q1 PLUS、Q1Pro、Q1S、R1、R1 PLUS、R1Pro、R1S、S1、S1 PLUS、S1Pro、S1S、T1、T1 PLUS、T1Pro、T1S、U1、U1 PLUS、U1Pro、U1S</p> <p>P***(*=0-9 or A-Z or MINI or PLUS or Pro or PLUS Pro or blank) A***(*=0-9 or A-Z or MINI or PLUS or Pro or PLUS Pro or blank) K***(*=0-9 or A-Z or MINI or PLUS or Pro or PLUS Pro or blank) L***(*=0-9 or A-Z or MINI or PLUS or Pro or PLUS Pro or blank) M***(*=0-9 or A-Z or MINI or PLUS or Pro or PLUS Pro or blank) N***(*=0-9 or A-Z or MINI or PLUS or Pro or PLUS Pro or blank) Q***(*=0-9 or A-Z or MINI or PLUS or Pro or PLUS Pro or blank) R***(*=0-9 or A-Z or MINI or PLUS or Pro or PLUS Pro or blank) S***(*=0-9 or A-Z or MINI or PLUS or Pro or PLUS Pro or blank) T***(*=0-9 or A-Z or MINI or PLUS or Pro or PLUS Pro or blank) U***(*=0-9 or A-Z or MINI or PLUS or Pro or PLUS Pro or blank)</p>		
POWER SUPPLY	DC 12V From Adapter		
MODULATION TECHNOLOGY	OFDM		
MODULATION TYPE	256QAM, 64QAM, 16QAM, QPSK, BPSK for OFDM		
TRANSFER RATE	802.11a: up to (54Mbps) 802.11n: up to (HT20/40 MCS7) 802.11ac: up to (HT80 MCS9),		
OPERATING FREQUENCY AND MAXIMUM POWER	Frequency	MAX output power(dBm)	MAX.EIPR(dBm)
	5180 ~ 5240MHz	14.28	18.32
	5260 ~ 5320MHz	14.21	18.25
	5500 ~ 5700MHz	15.80	19.84



	5745 ~ 5825MHz	14.35	18.39
NUMBER OF CHANNEL	See item 2.3		
ANTENNA TYPE(NOTE 4)	WiFi Antenna(Aux):FPC Antenna with 4.04dBi gain for 5G WiFi		
FIX FREQUENCY SOFTWARE	adb		
I/O PORTS	Refer to user's manual		

NOTE:

1. For a more detailed features description, please refer to the manufacturer's specifications or the user's manual.
2. For the test results, the EUT had been tested with all conditions. But only the worst case was shown in test report.
3. EUT photo refer to report (Report NO.: FCCSZ2024-0065-EUT).
4. Since the above data and/or information is provided by the client, CVC is not responsible for the authenticity, integrity and results of the data and information and/or the validity of the conclusion
5. Test Model(P2) and other model the only difference is the model name
6. The device shall automatically discontinue transmission in case of either absence of information to transmit or operational failure.

MODULATION MODE	TX FUNCTION
802.11a	SISO
802.11n	SISO
802.11ac	SISO

	Adapter1	Adapter2
Brand	MASS POWER	DA-JING
Model No.:	S050-1A120400B3	ADP60A-12500A1
Input:	100V-240V,50/60Hz, 1.5A	100V-240V,50/60Hz, 1.5A
Output:	12V/4A	12V/5A



2.2 CARRIER FREQUENCY AND CHANNEL

FOR 5180 ~ 5320MHz

8 channels are provided for 802.11a, 802.11n (HT20):

CHANNEL	FREQUENCY	CHANNEL	FREQUENCY
36	5180MHz	40	5200MHz
44	5220 MHz	48	5240MHz
52	5260MHz	56	5280MHz
60	5300MHz	64	5320MHz

4 channels are provided for 802.11n (HT40):

CHANNEL	FREQUENCY	CHANNEL	FREQUENCY
38	5190MHz	46	5230 MHz
54	5270MHz	62	5310MHz

2 channels are provided for 802.11ac (VHT80):

CHANNEL	FREQUENCY	CHANNEL	FREQUENCY
42	5210MHz	58	5290 MHz

WLAN 5.50 ~ 5.70GHz

9 channels are provided for 802.11a, 802.11n (HT20):

CHANNEL	FREQUENCY	CHANNEL	FREQUENCY
100	5500MHz	124	5620MHz
104	5520MHz	128	5640MHz
108	5540MHz	132	5660MHz
112	5560MHz	136	5680MHz
116	5580MHz	140	5700MHz
120	5600MHz		

4 channels are provided for 802.11n (HT40):

CHANNEL	FREQUENCY	CHANNEL	FREQUENCY
102	5510MHz	126	5630MHz
110	5550MHz	134	5670MHz
118	5590MHz		

2 channels are provided for 802.11ac (VHT80):

CHANNEL	FREQUENCY	CHANNEL	FREQUENCY
106	5530MHz	122	5610 MHz

FOR 5745 ~ 5825MHz

5 channels are provided for 802.11a, 802.11n (20MHz):

CHANNEL	FREQUENCY	CHANNEL	FREQUENCY
149	5745MHz	153	5765MHz
157	5785MHz	161	5805MHz
165	5825MHz	--	--

2 channels are provided for 802.11n (HT40):

CHANNEL	FREQUENCY	CHANNEL	FREQUENCY
151	5755MHz	159	5795MHz

1 channels are provided for 802.11ac (VHT80):

CHANNEL	FREQUENCY
155	5775MHz

The channels which were indicated in bold type of the above channel list were selected as representative test channel. Therefore only the data of the test channels were recorded in this report



By means of test software which provided by manufacture, the power levels during the tests were set according to the following codes:

Operated in 5180 ~ 5240MHz band							
802.11a		802.11n(HT20)		802.11n(HT40)		802.11ac (VHT80)	
FREQUENCY (MHZ)	POWER SETTING	FREQUENCY (MHZ)	POWER SETTING	FREQUENCY (MHZ)	POWER SETTING	FREQUENCY (MHZ)	POWER SETTING
5180	55	5180	55	5190	55	5210	55
5200	55	5200	55	5230	55		
5240	55	5240	55				
Operated in 5260 ~ 5320MHz band							
802.11a		802.11n(HT20)		802.11n(HT40)		802.11ac (VHT80)	
FREQUENCY (MHZ)	POWER SETTING	FREQUENCY (MHZ)	POWER SETTING	FREQUENCY (MHZ)	POWER SETTING	FREQUENCY (MHZ)	POWER SETTING
5260	55	5260	55	5270	55	5290	55
5300	55	5300	55	5310	55		
5320	55	5320	55				
Operated in 5500 ~ 5700MHz band							
802.11a		802.11n(HT20)		802.11n(HT40)		802.11ac (VHT80)	
FREQUENCY (MHZ)	POWER SETTING	FREQUENCY (MHZ)	POWER SETTING	FREQUENCY (MHZ)	POWER SETTING	FREQUENCY (MHZ)	POWER SETTING
5500	55	5500	55	5510	55	5530	55
5580	55	5550	55	5550	55	5610	55
5700	55	5700	55	5670	55		
Operated in 5745 ~ 5825MHz band							
802.11a		802.11n(HT20)		802.11n(HT40)		802.11ac (VHT80)	
FREQUENCY (MHZ)	POWER SETTING	FREQUENCY (MHZ)	POWER SETTING	FREQUENCY (MHZ)	POWER SETTING	FREQUENCY (MHZ)	POWER SETTING
5745	55	5745	55	5755	55	5755	55
5785	55	5785	55	5795	55		
5825	55	5825	55				



2.3 TEST MODE APPLICABILITY AND TESTED CHANNEL DETAIL

EUT CONFIGURE MODE	APPLICABLE TO				DESCRIPTION
	RE≥1G	RE<1G	PLC	APCM	
-	√	√	√	√	5G WIFI Function

Where **RE≥1G**: Radiated Emission above 1GHz **RE<1G**: Radiated Emission below 1GHz
PLC: Power Line Conducted Emission **APCM**: Antenna Port Conducted Measurement

NOTE:
1. The EUT had been pre-tested on the positioned of each 3 axis. The worst case was found when positioned on **X-plane**.
NOTE: “-” means no effect.

TEST CASES	ANTENNA 1-WIFI	ANTENNA 2-BT	MIMO/CDD	PARTIAL RU
AC Power Conducted Emission	○	N/A	N/A	N/A
6dB&26dB Emission Bandwidth	○	N/A	N/A	N/A
Occupied Bandwidth Measurement	○	N/A	N/A	N/A
Radiated Emission and Band edge	○	N/A	N/A	N/A
Transmit Power	○	N/A	N/A	N/A
Power Spectral Density	○	N/A	N/A	N/A
Frequency Stability	○	N/A	N/A	N/A

MODULATION	DATA RATE
802.11a	6Mbps
802.11n HT20	MCS0
802.11n HT40	MCS0
802.11ac VHT20	MCS0
802.11ac VHT40	MCS0
802.11ac VHT80	MCS0

TEST CONDITION:

APPLICABLE TO	ENVIRONMENTAL CONDITIONS	INPUT POWER	TESTED BY
RE<1G	25deg. C, 54%RH	DC 12V from Adapter	Liu Yuan
RE≥1G	25deg. C, 54%RH	DC 12V from Adapter	Liu Yuan
PLC	20deg. C, 56%RH	DC 12V from Adapter	Wang Zhiming
APCM	20deg. C, 55%RH	DC 12V from Adapter	Cai Jianyu

2.4 DESCRIPTION OF SUPPORT UNITS

The EUT has been tested as an independent unit together with other necessary accessories or support units. The following support units or accessories were used to form a representative test configuration during the tests.

Support Equipment							
NO	Description	Brand	Model No.	Serial Number	Supplied by		
1	Laptop	Lenovo	K4e-ARE120	MP20kshe	Lab		
2	Adapter-1	DAJING	ADP60A-120500A1	TW34210050	Client		
3	Adapter-2	MASS	S050-1A120400B3	N/A	Client		
Support Cable							
NO	Description	Quantity (Number)	Length (cm)	Detachable (Yes/ No)	Shielded (Yes/ No)	Cores (Number)	Supplied by

2.5 GENERAL DESCRIPTION OF APPLIED STANDARDS

The EUT is a RF product, according to the specifications of the manufacturers. It must comply with the requirements of the following standards:

FCC Part 15, Subpart E (15.407)

KDB 789033 D02 General UNII Test Procedures New Rules v02r01

ANSI C63.10-2013

All test items have been performed and recorded as per the above standards

3 TEST TYPES AND RESULTS

3.1 CONDUCTED EMISSION MEASUREMENT

3.1.1 LIMITS OF CONDUCTED EMISSION MEASUREMENT

Frequency (MHz)	Conducted Limits(dBμV)	
	Quasi-peak	Average
0.15 - 0.5	66 to 56 *	56 to 46*
0.5 - 5	56	46
5 - 30	60	50

NOTE: 1. The lower limit shall apply at the transition frequencies.
 NOTE: 2. The limit decreases in line with the logarithm of the frequency in the range of 0.15 to 0.50MHz.

3.1.2 TEST PROCEDURES

- a. The EUT was placed 0.4 meters from the conducting wall of the shielded room with EUT being connected to the power mains through a line impedance stabilization network (LISN). Other support units were connected to the power mains through another LISN. The two LISNs provide 50 ohm/ 50uH of coupling impedance for the measuring instrument.
- b. Both lines of the power mains connected to the EUT were checked for maximum conducted interference.
- c. The frequency range from 150kHz to 30MHz was searched. Emission levels under (Limit - 20dB) were not recorded.

NOTE: All modes of operation were investigated and the worst-case emissions are reported.

3.1.3 TEST SETUP

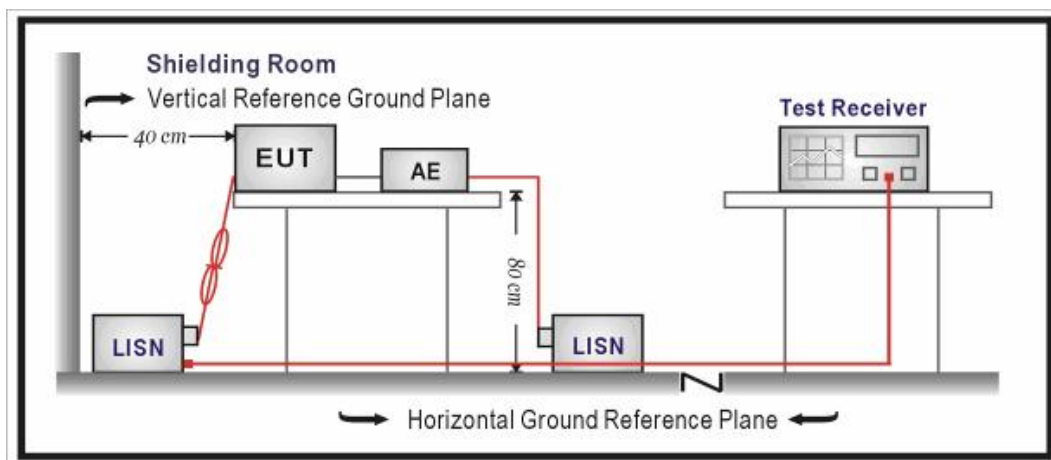

NOTE: For the actual test configuration, please refer to the attached file (Test Setup Photo).

3.1.4 Adapter-1 TEST RESULTS

Test Mode	5G WIFI Link	Frequency Range	150KHz ~ 30MHz
PHASE	Line (L)		

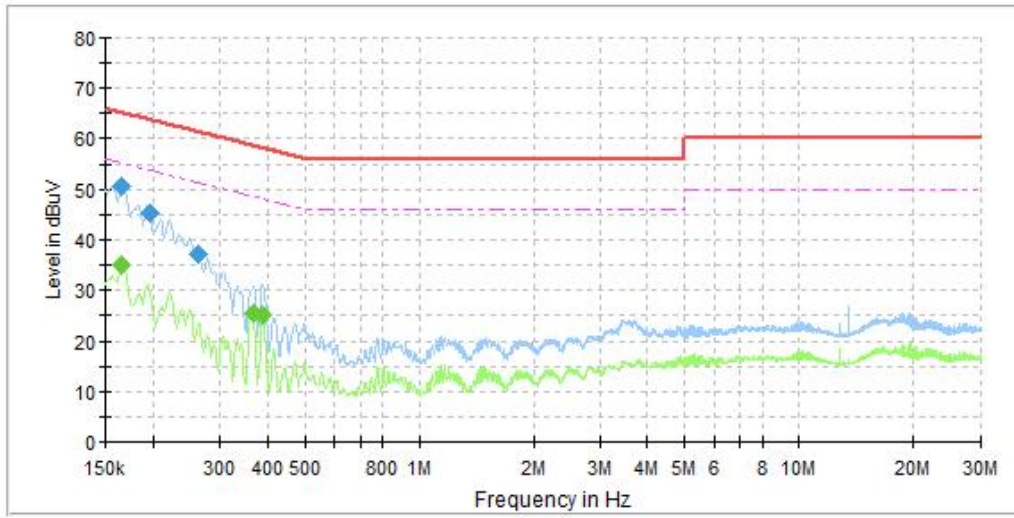

NO	Frequency (MHz)	QuasiPeak (dBuV)	Average (dBuV)	Limit (dBuV)	Margin (dB)	Line	Corr. (dB)
1	0.166	50.6	---	65.2	14.6	L1	20.2
2	0.166	---	35.0	55.2	20.2	L1	20.2
3	0.197	45.2	---	63.7	18.6	L1	20.2
4	0.263	37.3	---	61.4	24.0	L1	20.2
5	0.366	---	25.5	48.6	23.1	L1	20.2
6	0.389	---	25.2	48.1	22.9	L1	20.2

Remark: The emission levels of other frequencies were very low against the limit.

Test Mode	5G WIFI Link	Frequency Range	150KHz ~ 30MHz
PHASE	Line (N)		

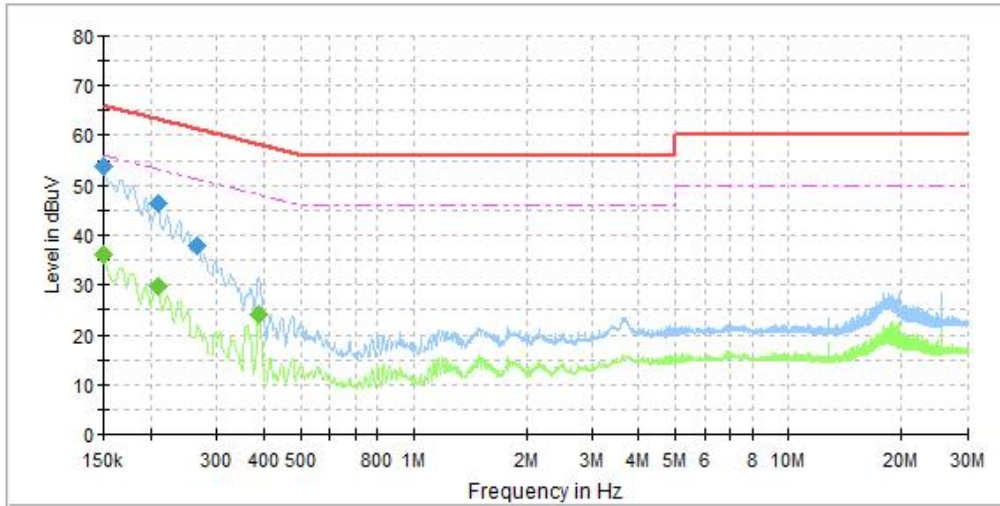

NO	Frequency (MHz)	QuasiPeak (dBuV)	Average (dBuV)	Limit (dBuV)	Margin (dB)	Line	Corr.Factor (dB)
1	0.150	53.9	---	66.0	12.1	N	20.1
2	0.150	---	36.1	56.0	19.9	N	20.1
3	0.209	46.4	---	63.3	16.8	N	20.2
4	0.209	---	29.6	53.3	23.6	N	20.2
5	0.267	38.0	---	61.2	23.2	N	20.2
6	0.386	---	24.1	48.1	24.0	N	20.2

Remark: The emission levels of other frequencies were very low against the limit.

3.1.5 Adapter-2 TEST RESULTS

Test Mode	5G WIFI Link	Frequency Range	150KHz ~ 30MHz
PHASE	Line (L)		

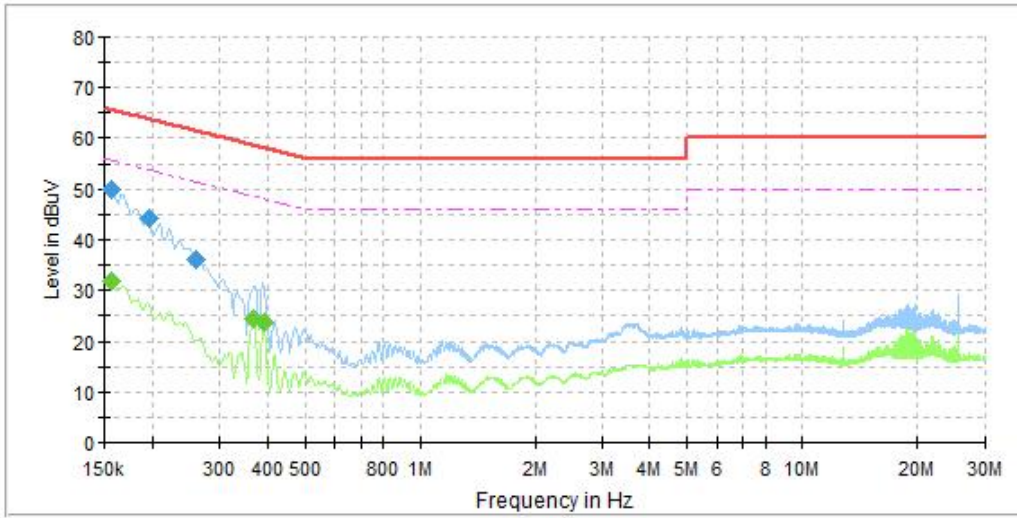

NO	Frequency (MHz)	QuasiPeak (dBuV)	Average (dBuV)	Limit (dBuV)	Margin (dB)	Line	Corr. (dB)
1	0.157	49.9	---	65.6	15.8	L1	20.2
2	0.157	---	32.0	55.6	23.7	L1	20.2
3	0.197	44.2	---	63.7	19.5	L1	20.2
4	0.260	36.3	---	61.4	25.2	L1	20.2
5	0.366	---	24.6	48.6	24.0	L1	20.2
6	0.391	---	23.7	48.0	24.3	L1	20.2

Remark: The emission levels of other frequencies were very low against the limit.

Test Mode	5G WIFI Link	Frequency Range	150KHz ~ 30MHz
PHASE	Line (N)		

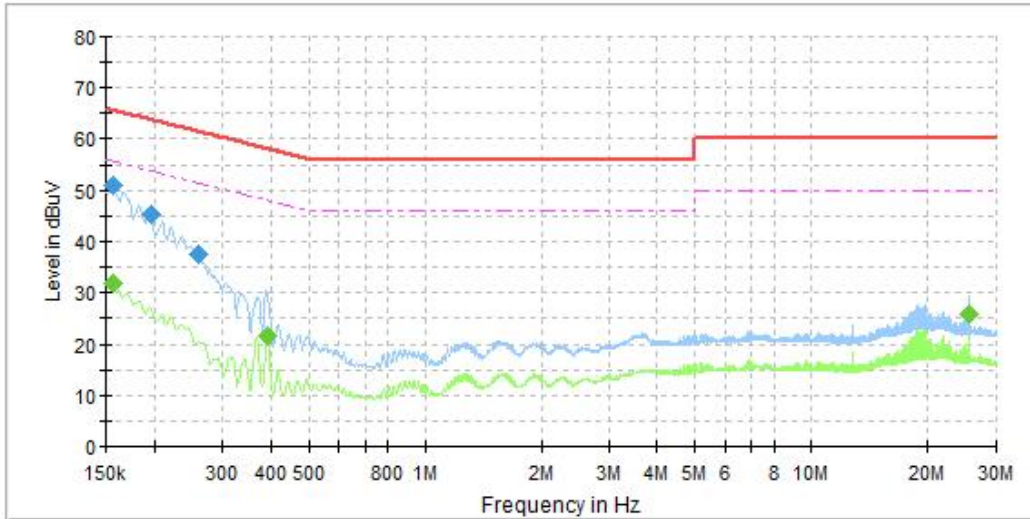

NO	Frequency (MHz)	QuasiPeak (dBuV)	Average (dBuV)	Limit (dBuV)	Margin (dB)	Line	Corr.Factor (dB)
1	0.157	50.9	---	65.6	14.7	N	20.1
2	0.157	---	32.0	55.6	23.7	N	20.1
3	0.197	45.1	---	63.7	18.6	N	20.2
4	0.260	37.4	---	61.4	24.0	N	20.2
5	0.391	---	21.7	48.0	26.4	N	20.2
6	25.602	---	25.9	50.0	24.1	N	23.7

Remark: The emission levels of other frequencies were very low against the limit.

3.2 RADIATED EMISSION AND BANDEDGE MEASUREMENT

3.1.1 LIMITS OF RADIATED EMISSION AND BANDEDGE MEASUREMENT

Radiated emissions which fall in the restricted bands must comply with the radiated emission limits specified as below table:

FREQUENCIES (MHz)	FIELD STRENGTH (microvolts/meter)	MEASUREMENT DISTANCE (meters)
0.009 ~ 0.490	2400/F(kHz)	300
0.490 ~ 1.705	24000/F(kHz)	30
1.705 ~ 30.0	30	30
30 ~ 88	100	3
88 ~ 216	150	3
216 ~ 960	200	3
Above 960	500	3

NOTE:

1. The lower limit shall apply at the transition frequencies.
2. Emission level (dBuV/m) = 20 log Emission level (uV/m).
3. For frequencies above 1000MHz, the field strength limits are based on average detector, however, the peak field strength of any emission shall not exceed the maximum permitted average limits, specified above by more than 30dB under any condition of modulation.

3.1.2 LIMITS OF UNWANTED EMISSION OUT OF THE RESTRICTED BANDS

APPLICABLE TO	LIMIT	
KDB 789033 D02 General UNII Test Procedures New Rules v02r01	FIELD STRENGTH AT 3m	
	PK:74 (dBµV/m)	AV:54 (dBµV/m)
APPLICABLE TO	EIRP LIMIT	EQUIVALENT FIELD STRENGTH AT 3m
15.407(b)(1)	PK:-27 (dBm/MHz)	PK:68.2(dBµV/m)
15.407(b)(2)		
15.407(b)(3)		
15.407(b)(4)	Note	Note

NOTE:

For transmitters operating in the 5.725-5.85 GHz band:Section 15.407(b)(4) specifies the unwanted emissions limit for the U-NII-3 band. A band emissions mask is specified in Section 15.407(b)(4)(i). An alternative to the band emissions mask is specified in Section 15.407(b)(4)(ii). The alternative limits are based on the highest antenna gain specified in the filing. There are also marketing and importation restrictions for the alternative limit.

15.407(b)(4)(i) All emissions shall be limited to a level of -27 dBm/MHz at 75 MHz or more above or below theband edge increasing linearly to 10 dBm/MHz at 25 MHz above or below the band edge, and from 25MHz above or below the band edge increasing linearly to a level of 15.6 dBm/MHz at 5 MHz above orbelow the band edge, and from 5 MHz above or below the band edge increasing linearly to a level of 27dBm/MHz at the band edge.

The following formula is used to convert the equipment isotropic radiated power (eirp) to field strength:

$$E = \frac{1000000\sqrt{30P}}{3} \mu\text{V/m, where P is the eirp (Watts).$$

3.1.3 TEST PROCEDURES

- a. The EUT was placed on the top of a rotating table 1.5 meters(above 1GHz)and 0.8 meters(below 1GHz) above the ground at a 3 meters semi-anechoic chamber. The table was rotated 360 degrees to determine the position of the highest radiation.
- b. The EUT was set 3 meters away from the interference-receiving antenna, which was mounted on the top of a variable-height antenna tower.
- c. The antenna is a broadband antenna, and its height is varied from one meter to four meters above the ground to determine the maximum value of the field strength. Both horizontal and vertical polarizations of the antenna are set to make the measurement.
- d. For each suspected emission, the EUT was arranged to its worst case and then the antenna was tuned to heights from 1 meter to 4 meters and the rotatable table was turned from 0 degrees to 360 degrees to find the maximum reading.
- e. The test-receiver system was set to Peak Detect Function and Specified Bandwidth with Maximum Hold Mode.
- f. If the emission level of the EUT in peak mode was 10dB lower than the limit specified, then testing could be stopped and the peak values of the EUT would be reported. Otherwise the emissions that did not have 10dB margin would be re-tested one by one using peak, quasi-peak or average method as specified and then reported in a data sheet.

NOTE:

1. The resolution bandwidth and video bandwidth of test receiver/spectrum analyzer is 120kHz for Quasi-peak detection at frequency below 1GHz.
2. The resolution bandwidth of test receiver/spectrum analyzer is 1MHz and video bandwidth is 3MHz for Peak detection at frequency above 1GHz.
3. The resolution bandwidth of test receiver/spectrum analyzer is 1MHz and the video bandwidth is $\geq 1/T$ (Duty cycle < 98%) or 10Hz(Duty cycle > 98%) for Average detection (AV) at frequency above 1GHz.
4. All modes of operation were investigated and the worst-case emissions are reported.

3.1.4 TEST SETUP

Below 30MHz Test Setup:

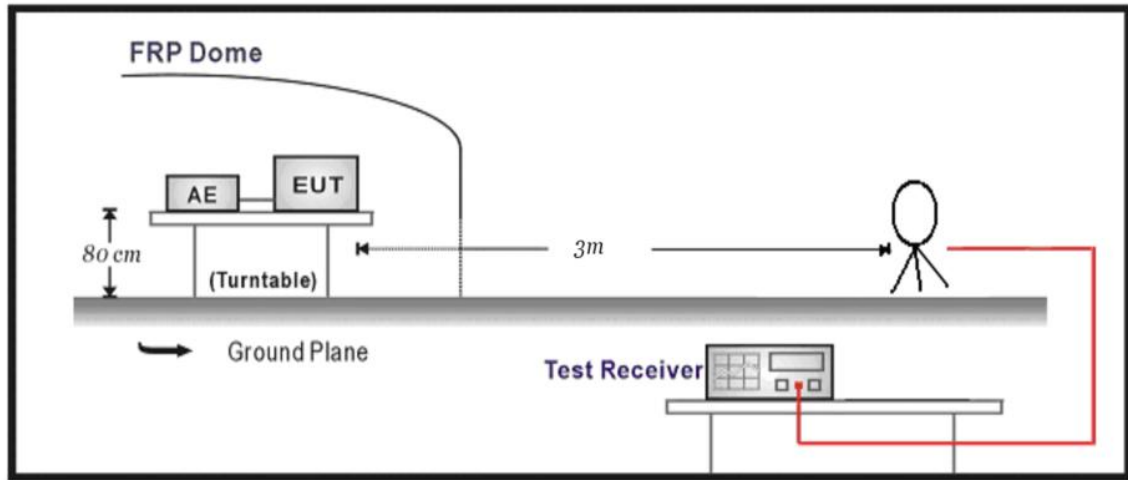

Below 1GHz Test Setup:

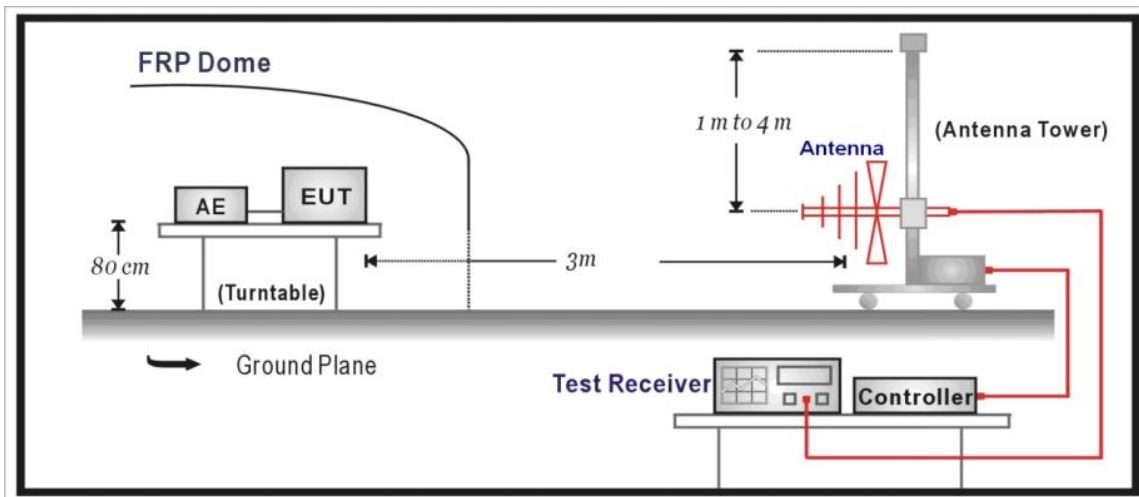

Above 1GHz Test Setup:

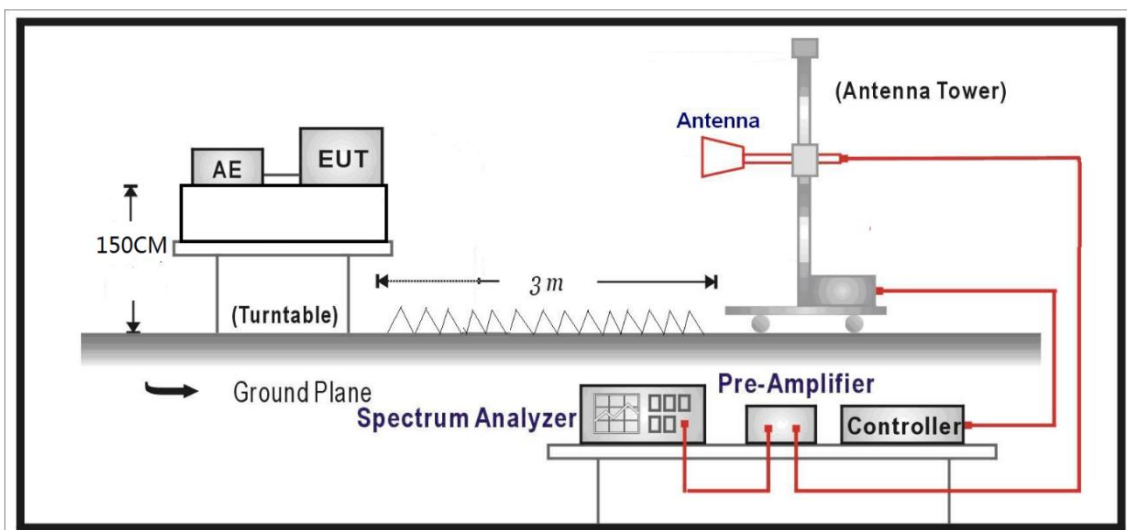

Note: For the actual test configuration, please refer to the related Item in this test report (Photographs of the Test Setup)



3.1.5 Adapter-1 TEST RESULTS - BELOW 1GHz

Test Mode:	11a 5180	Frequency Range	30-1000MHz
Detector Function	Quasi-Peak(QP)		

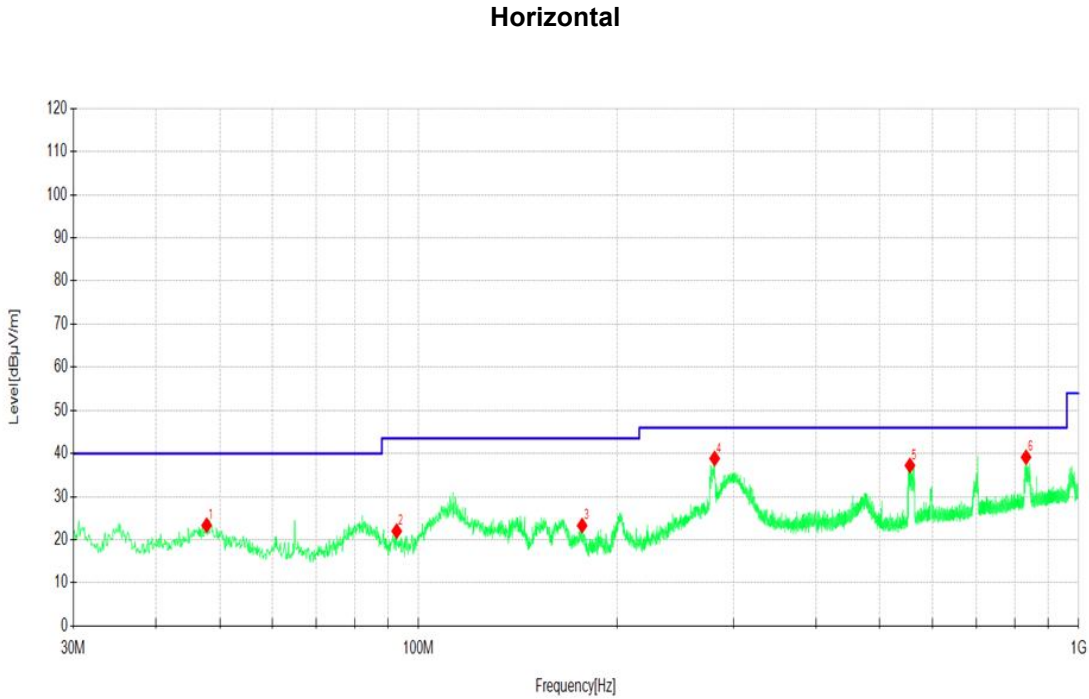

NO.	Freq. [MHz]	Reading [dBµV]	Factor [dB/m]	Level [dBµV/m]	Limit [dBµV/m]	Margin [dB]	Polarity
1	47.75	3.82	19.54	23.36	40.00	16.64	Horizontal
2	92.67	6.10	15.91	22.01	43.50	21.49	Horizontal
3	176.97	4.48	18.81	23.29	43.50	20.21	Horizontal
4	280.96	19.26	19.60	38.86	46.00	7.14	Horizontal
5	555.21	11.45	25.78	37.23	46.00	8.77	Horizontal
6	832.56	9.24	29.91	39.15	46.00	6.85	Horizontal

Remark: 1. The emission levels of 9k - 30MHz were greater than 20dB margin.
 2. Level (dBµV/m) = Reading (dBµV) + Factor (dB/m).
 3. Factor (dB/m) = Antenna Factor (dB/m) + Cable Factor (dB).
 4. Margin(dB) = Limit[dBµV/m] - Level [dBµV/m]



Test Mode:	11a 5180	Frequency Range	30-1000MHz
Detector Function	Quasi-Peak(QP)		

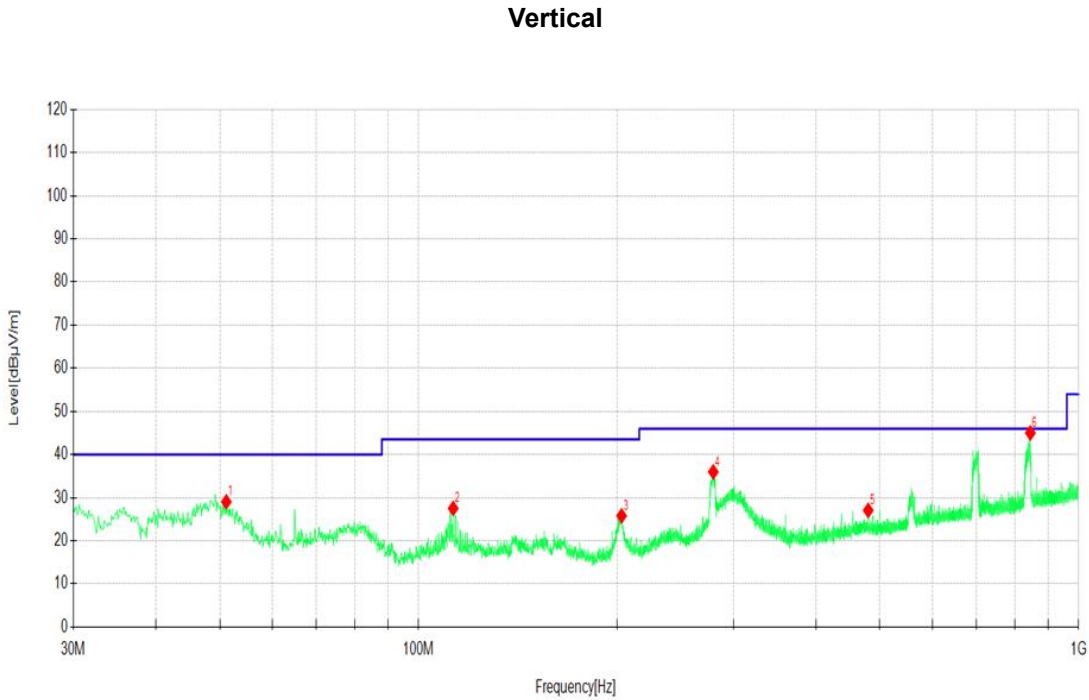

NO.	Freq. [MHz]	Reading [dBµV]	Factor [dB/m]	Level [dBµV/m]	Limit [dBµV/m]	Margin [dB]	Polarity
1	51.15	9.57	19.46	29.03	40.00	10.97	Vertical
2	112.85	9.55	17.97	27.52	43.50	15.98	Vertical
3	203.07	8.88	16.91	25.79	43.50	17.71	Vertical
4	279.61	16.42	19.55	35.97	46.00	10.03	Vertical
5	480.03	2.65	24.41	27.06	46.00	18.94	Vertical
6	845.17	14.88	30.12	45.00	46.00	1.00	Vertical

Remark: 1. The emission levels of 9k - 30MHz were greater than 20dB margin.
 2. Level (dBµV/m) = Reading (dBµV) + Factor (dB/m).
 3. Factor (dB/m) = Antenna Factor (dB/m) + Cable Factor (dB).
 4. Margin(dB) = Limit[dBµV/m] - Level [dBµV/m]

3.1.6 Adapter-2 TEST RESULTS - BELOW 1GHz

Test Mode:	11a 5180	Frequency Range	30-1000MHz
Detector Function	Quasi-Peak(QP)		

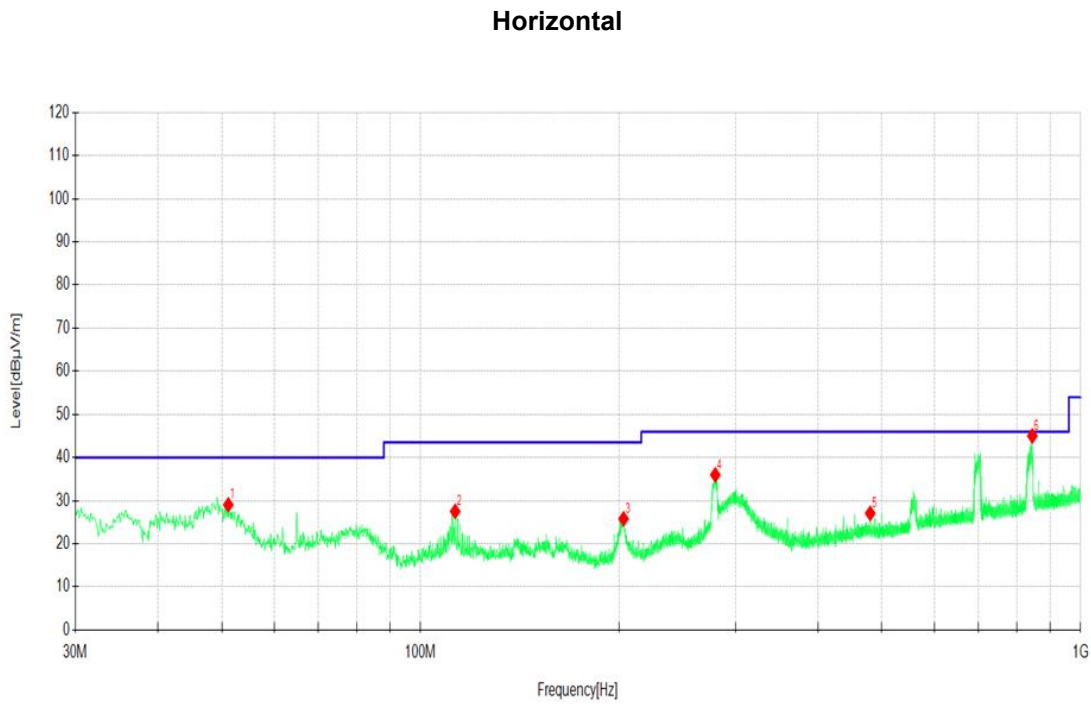

NO.	Freq. [MHz]	Reading [dBµV]	Factor [dB/m]	Level [dBµV/m]	Limit [dBµV/m]	Margin [dB]	Polarity
1	34.95	4.42	19.40	23.82	40.00	16.18	Horizontal
2	65.02	7.82	17.82	25.64	40.00	14.36	Horizontal
3	113.72	12.22	18.07	30.29	43.50	13.21	Horizontal
4	280.58	20.51	19.59	40.10	46.00	5.90	Horizontal
5	552.88	10.87	25.74	36.61	46.00	9.39	Horizontal
6	846.24	7.79	30.11	37.90	46.00	8.10	Horizontal

Remark: 1. The emission levels of 9k - 30MHz were greater than 20dB margin.
 2. Level (dBuV/m) = Reading (dBuV) + Factor (dB/m).
 3. Factor (dB/m) = Antenna Factor (dB/m) + Cable Factor (dB).
 4. Margin(dB) = Limit[dBµV/m] - Level [dBµV/m]

Test Mode:	11a 5180	Frequency Range	30-1000MHz
Detector Function	Quasi-Peak(QP)		

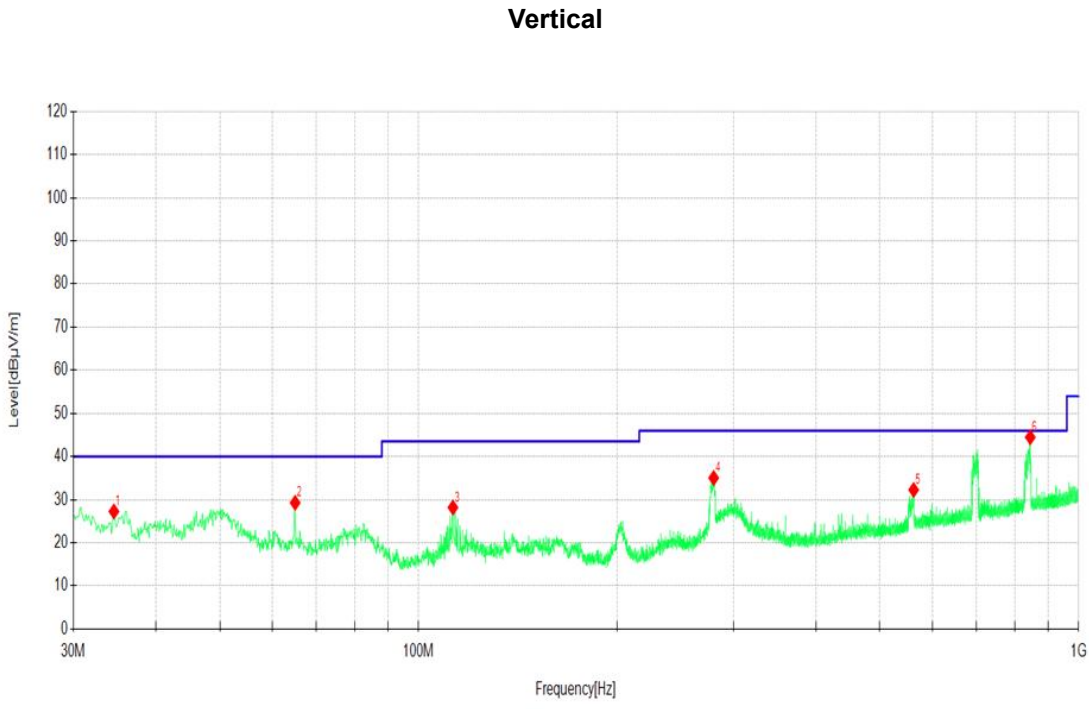

NO.	Freq. [MHz]	Reading [dBµV]	Factor [dB/m]	Level [dBµV/m]	Limit [dBµV/m]	Margin [dB]	Polarity
1	34.56	7.89	19.37	27.26	40.00	12.74	Vertical
2	65.02	11.46	17.82	29.28	40.00	10.72	Vertical
3	112.75	10.23	17.96	28.19	43.50	15.31	Vertical
4	279.99	15.47	19.57	35.04	46.00	10.96	Vertical
5	562.49	6.33	25.93	32.26	46.00	13.74	Vertical
6	844.78	14.35	30.12	44.47	46.00	1.53	Vertical

Remark: 1. The emission levels of 9k - 30MHz were greater than 20dB margin.
 2. Level (dBµV/m) = Reading (dBµV) + Factor (dB/m).
 3. Factor (dB/m) = Antenna Factor (dB/m) + Cable Factor (dB).
 4. Margin(dB) = Limit[dBµV/m] - Level [dBµV/m]

3.1.7 TEST RESULTS - Band 1 (5180-5240MHz):

ABOVE 1GHz DATA

All test modes have been tested, and the report only presents the worst case(802.11a).

Channel	802.11a CH36	Frequency	5180 MHz
Frequency Range	Above 1G	Detector Function	PK/AV

Horizontal

NO.	Freq. [MHz]	Reading [dBμV]	Factor [dB/m]	Level [dBμV/m]	Limit [dBμV/m]	Margin [dB]	Detector
1	5112.31	34.32	8.00	42.32	54.00	11.68	AV
2	5122.39	46.12	7.87	53.99	74.00	20.01	PK
3	5150.00	35.03	8.03	43.06	54.00	10.94	AV
4	5150.00	46.60	8.03	54.63	74.00	19.37	PK
5	5185.30	93.89	7.63	101.52	74.00	-27.52	PK
6	5186.74	85.73	7.58	93.31	54.00	-39.31	AV
7	10360.00	27.16	15.59	42.75	68.20	25.45	PK
8	10360.00	18.07	15.59	33.66	54.00	20.34	AV
9	15540.00	23.18	21.44	44.62	74.00	29.38	PK
10	15540.00	14.57	21.44	36.01	54.00	17.99	AV

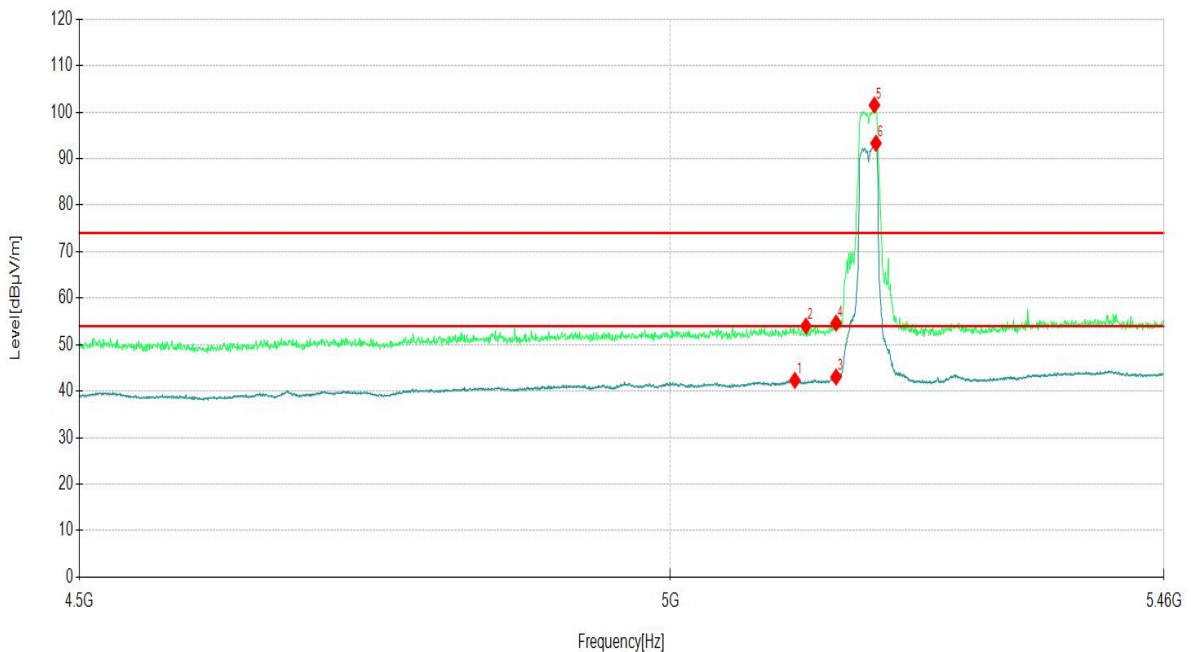

- Remark: 1. The emission levels of other frequencies were greater than 20dB margin.
 2. Level (dBμV/m) = Reading (dBμV) + Factor (dB/m).
 3. Factor (dB/m) = Antenna Factor (dB/m) + Cable Factor (dB).
 4. Margin(dB) = Limit[dBμV/m] - Level [dBμV/m]

Channel	802.11a CH36	Frequency	5180 MHz
Frequency Range	Above 1G	Detector Function	PK/AV

Vertical

NO.	Freq. [MHz]	Reading [dBμV]	Factor [dB/m]	Level [dBμV/m]	Limit [dBμV/m]	Margin [dB]	Detector
1	5109.42	46.19	8.05	54.24	74.00	19.76	PK
2	5111.35	34.24	8.04	42.28	54.00	11.72	AV
3	5150.00	33.92	8.03	41.95	54.00	12.05	AV
4	5150.00	45.71	8.03	53.74	74.00	20.26	PK
5	5184.82	87.88	7.65	95.53			PK
6	5186.74	79.90	7.58	87.48			AV
7	10360.00	27.99	15.59	43.58	68.20	24.62	PK
8	10360.00	18.84	15.59	34.43	54.00	19.57	AV
9	15540.00	22.59	21.44	44.03	74.00	29.97	PK
10	15540.00	14.52	21.44	35.96	54.00	18.04	AV

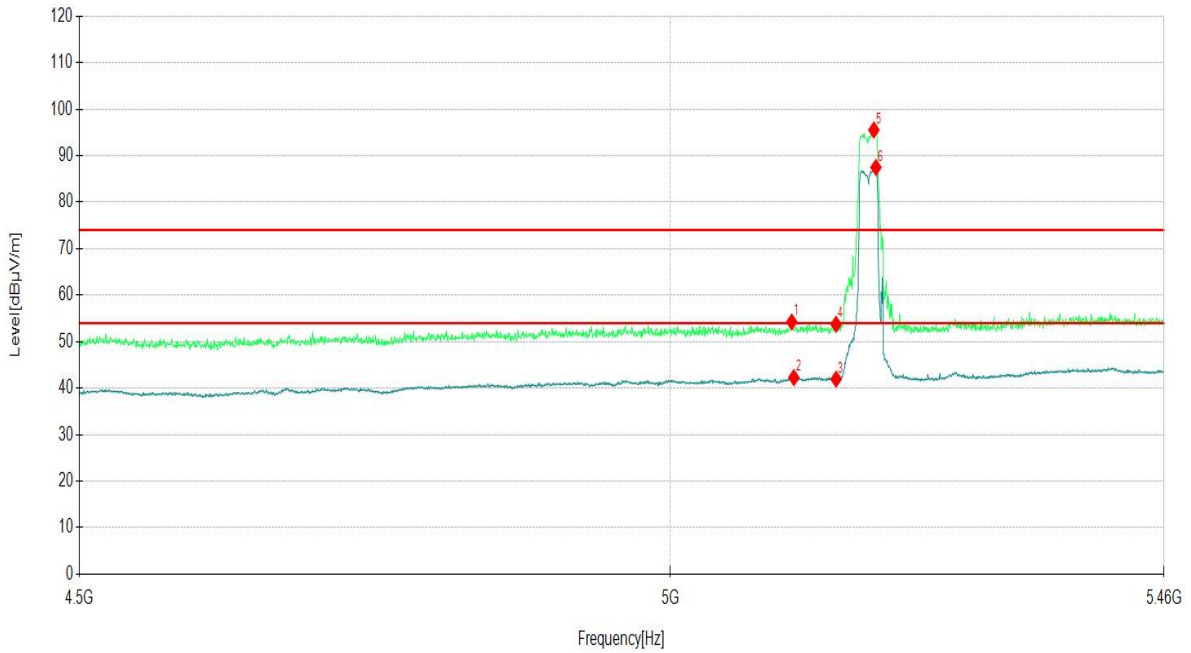

Remark: 1. The emission levels of other frequencies were greater than 20dB margin.
 2. Level (dBuV/m) = Reading (dBuV) + Factor (dB/m).
 3. Factor (dB/m) = Antenna Factor (dB/m) + Cable Factor (dB).
 4. Margin(dB) = Limit[dBμV/m] - Level [dBμV/m]

Channel		802.11a CH 40		Frequency		5200MHz	
Frequency Range		Above 1G		Detector Function		PK/AV	
Horizontal							
NO.	Freq. [MHz]	Reading [dBμV]	Factor [dB/m]	Level [dBμV/m]	Limit [dBμV/m]	Margin [dB]	Detector
1	10400.00	28.30	15.80	44.10	68.20	24.10	PK
2	10400.00	19.21	15.80	35.01	54.00	18.99	AV
3	15600.00	23.28	21.58	44.86	74.00	29.14	PK
4	15600.00	13.01	21.58	34.59	54.00	19.41	AV
Vertical							
NO.	Freq. [MHz]	Reading [dBμV]	Factor [dB/m]	Level [dBμV/m]	Limit [dBμV/m]	Margin [dB]	Detector
1	10400.00	26.45	15.80	42.25	68.20	25.95	PK
2	10400.00	18.94	15.80	34.74	54.00	19.26	AV
3	15600.00	23.69	21.58	45.27	74.00	28.73	PK
4	15600.00	13.54	21.58	35.12	54.00	18.88	AV
Remark: 1. The emission levels of other frequencies were greater than 20dB margin. 2. Level (dBuV/m) = Reading (dBuV) + Factor (dB/m). 3. Factor (dB/m) = Antenna Factor (dB/m) + Cable Factor (dB). 4. Margin(dB) = Limit[dBμV/m] - Level [dBμV/m]							

Channel	802.11a CH48	Frequency	5240 MHz
Frequency Range	Above 1G	Detector Function	PK/AV

Horizontal

NO.	Freq. [MHz]	Reading [dBμV]	Factor [dB/m]	Level [dBμV/m]	Limit [dBμV/m]	Margin [dB]	Detector
1	5244.37	95.21	8.04	103.25			PK
2	5246.77	87.01	8.04	95.05			AV
3	5350.00	44.21	9.66	53.87	74.00	20.13	PK
4	5350.00	33.72	9.66	43.38	54.00	10.62	AV
5	5407.17	45.85	9.92	55.77	74.00	18.23	PK
6	5411.50	34.36	9.93	44.29	54.00	9.71	AV
7	10480.00	28.30	15.87	44.17	68.20	24.03	PK
8	10480.00	19.79	15.87	35.66	54.00	18.34	AV
9	15720.00	22.22	22.33	44.55	74.00	29.45	PK
10	15720.00	13.37	22.33	35.70	54.00	18.30	AV

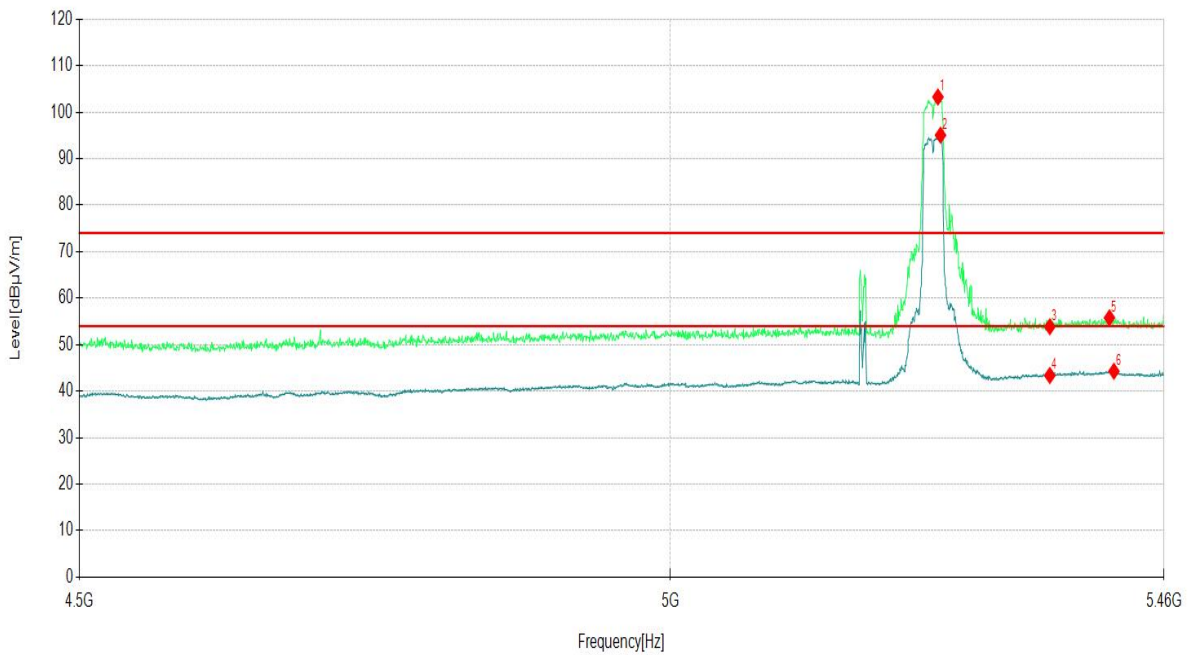

Remark: 1. The emission levels of other frequencies were greater than 20dB margin.
 2. Level (dBuV/m) = Reading (dBuV) + Factor (dB/m).
 3. Factor (dB/m) = Antenna Factor (dB/m) + Cable Factor (dB).
 4. Margin(dB) = Limit[dBμV/m] - Level [dBμV/m]

Channel	802.11a CH48	Frequency	5240 MHz
Frequency Range	Above 1G	Detector Function	PK/AV

Vertical

NO.	Freq. [MHz]	Reading [dBμV]	Factor [dB/m]	Level [dBμV/m]	Limit [dBμV/m]	Margin [dB]	Detector
1	5244.37	90.88	8.04	98.92			PK
2	5245.81	82.78	8.03	90.81			AV
3	5350.00	33.70	9.66	43.36	54.00	10.64	AV
4	5350.00	45.49	9.66	55.15	74.00	18.85	PK
5	5409.57	34.76	10.01	44.77	54.00	9.23	AV
6	5422.54	46.45	9.53	55.98	74.00	18.02	PK
7	10480.00	29.20	15.87	45.07	68.20	23.13	PK
8	10480.00	19.47	15.87	35.34	54.00	18.66	AV
9	15720.00	22.43	22.33	44.76	74.00	29.24	PK
10	15720.00	13.71	22.33	36.04	54.00	17.96	AV

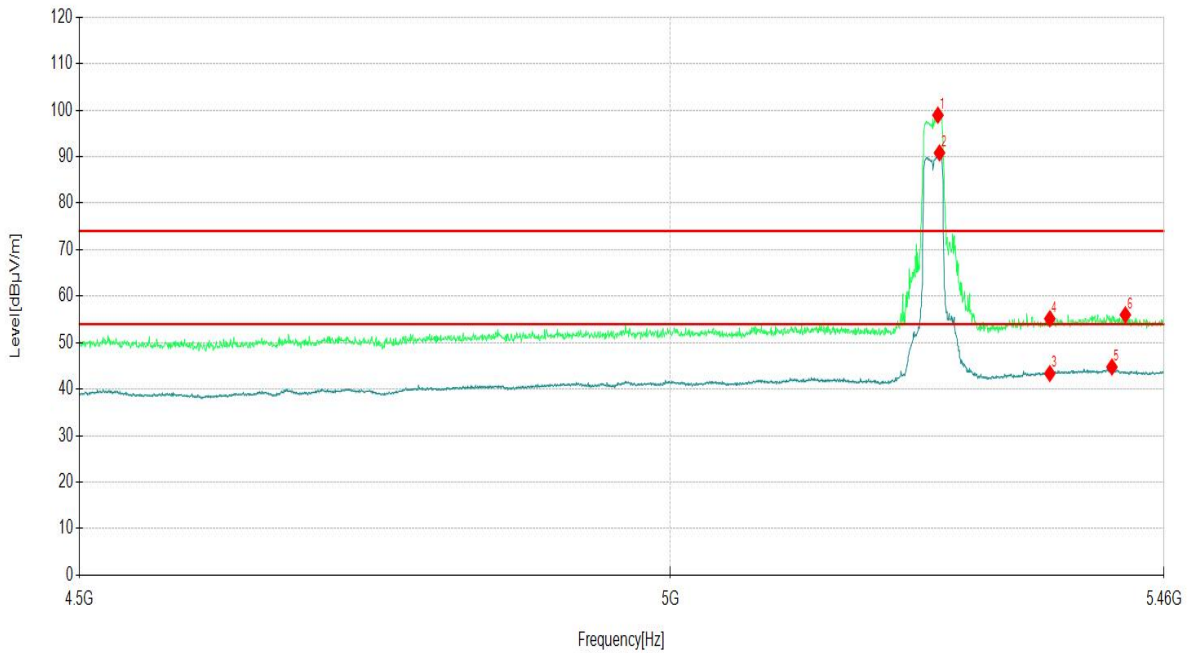

Remark: 1. The emission levels of other frequencies were greater than 20dB margin.
 2. Level (dBμV/m) = Reading (dBμV) + Factor (dB/m).
 3. Factor (dB/m) = Antenna Factor (dB/m) + Cable Factor (dB).
 4. Margin(dB) = Limit[dBμV/m] - Level [dBμV/m]

3.1.8 TEST RESULTS - Band 2 (5260-5320MHz):

ABOVE 1GHz DATA

All test modes have been conducted, and the report only presents the worst case.

Channel	802.11a CH52	Frequency	5260 MHz
Frequency Range	Above 1G	Detector Function	PK/AV

Horizontal

NO.	Freq. [MHz]	Reading [dBμV]	Factor [dB/m]	Level [dBμV/m]	Limit [dBμV/m]	Margin [dB]	Detector
1	5111.35	34.19	8.04	42.23	54.00	11.77	PK
2	5119.51	45.82	7.78	53.60	74.00	20.40	AV
3	5150.00	33.96	8.03	41.99	54.00	12.01	AV
4	5150.00	44.58	8.03	52.61	74.00	21.39	PK
5	5265.50	84.04	8.74	92.78			PK
6	5265.50	91.73	8.74	100.47			AV
7	10520.00	27.29	15.70	42.99	68.20	25.21	PK
8	10520.00	18.53	15.70	34.23	54.00	19.77	AV
9	15780.00	21.41	22.35	43.76	74.00	30.24	PK
10	15780.00	12.65	22.35	35.00	54.00	19.00	AV

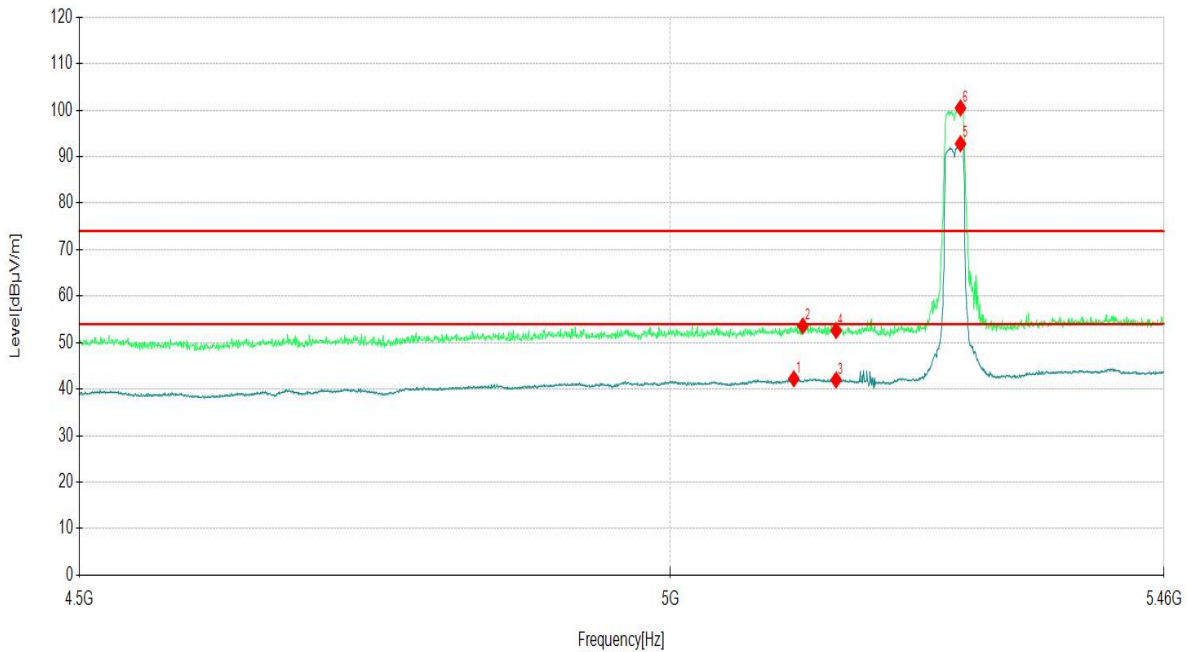

- Remark: 1. The emission levels of other frequencies were greater than 20dB margin.
 2. Level (dBμV/m) = Reading (dBμV) + Factor (dB/m).
 3. Factor (dB/m) = Antenna Factor (dB/m) + Cable Factor (dB).
 4. Margin(dB) = Limit[dBμV/m] - Level [dBμV/m]

Channel	802.11a CH52	Frequency	5260 MHz
Frequency Range	Above 1G	Detector Function	PK/AV

Vertical

NO.	Freq. [MHz]	Reading [dBμV]	Factor [dB/m]	Level [dBμV/m]	Limit [dBμV/m]	Margin [dB]	Detector
1	5110.87	46.24	8.05	54.29	74.00	19.71	PK
2	5113.27	34.29	7.97	42.26	54.00	11.74	AV
3	5150.00	33.85	8.03	41.88	54.00	12.12	AV
4	5150.00	44.59	8.03	52.62	74.00	21.38	PK
5	5266.46	80.34	8.67	89.01			AV
6	5266.46	88.96	8.67	97.63			PK
7	10520.00	26.16	15.70	41.86	68.20	26.34	PK
8	10520.00	18.26	15.70	33.96	54.00	20.04	AV
9	15780.00	21.09	22.35	43.44	74.00	30.56	PK
10	15780.00	13.29	22.35	35.64	54.00	18.36	AV

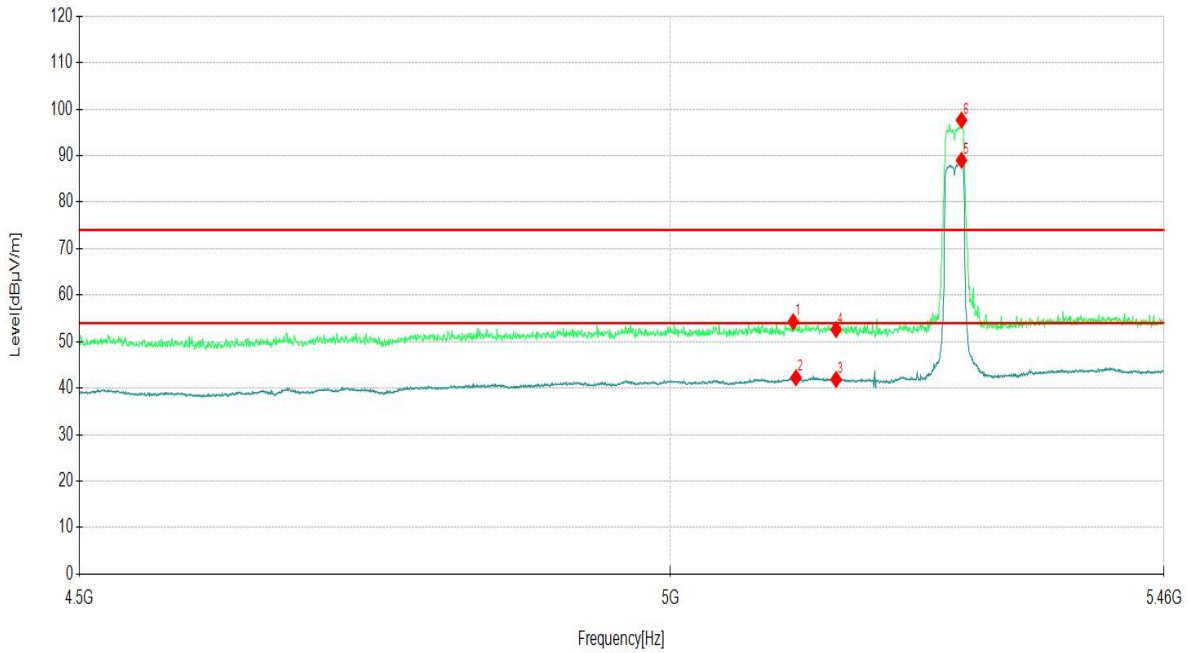

Remark: 1. The emission levels of other frequencies were greater than 20dB margin.
 2. Level (dBuV/m) = Reading (dBuV) + Factor (dB/m).
 3. Factor (dB/m) = Antenna Factor (dB/m) + Cable Factor (dB).
 4. Margin(dB) = Limit[dBμV/m] - Level [dBμV/m]



Channel		802.11a CH56		Frequency		5280MHz	
Frequency Range		Above 1G		Detector Function		PK/AV	
Horizontal							
NO.	Freq. [MHz]	Reading [dBμV]	Factor [dB/m]	Level [dBμV/m]	Limit [dBμV/m]	Margin [dB]	Detector
1	10560.00	27.34	15.66	43.00	68.20	25.20	PK
2	10560.00	19.42	15.66	35.08	54.00	18.92	AV
3	15840.00	22.36	22.21	44.57	74.00	29.43	PK
4	15840.00	13.32	22.21	35.53	54.00	18.47	AV
Vertical							
NO.	Freq. [MHz]	Reading [dBμV]	Factor [dB/m]	Level [dBμV/m]	Limit [dBμV/m]	Margin [dB]	Detector
1	10560.00	27.65	15.66	43.31	68.20	24.89	PK
2	10560.00	18.60	15.66	34.26	54.00	19.74	AV
3	15840.00	21.84	22.21	44.05	74.00	29.95	PK
4	15840.00	13.02	22.21	35.23	54.00	18.77	AV
<p>Remark: 1. The emission levels of other frequencies were greater than 20dB margin. 2. Level (dBuV/m) = Reading (dBuV) + Factor (dB/m). 3. Factor (dB/m) = Antenna Factor (dB/m) + Cable Factor (dB). 4. Margin(dB) = Limit[dBμV/m] - Level [dBμV/m]</p>							

Channel	802.11a CH64	Frequency	5320 MHz
Frequency Range	Above 1G	Detector Function	PK/AV

Horizontal

NO.	Freq. [MHz]	Reading [dBμV]	Factor [dB/m]	Level [dBμV/m]	Limit [dBμV/m]	Margin [dB]	Detector
1	5312.09	92.87	8.86	101.73			PK
2	5325.53	84.83	8.96	93.79			AV
3	5350.00	45.56	9.66	55.22	74.00	18.78	PK
4	5350.00	35.18	9.66	44.84	54.00	9.16	AV
5	5399.97	34.74	9.72	44.46	54.00	9.54	AV
6	5408.13	35.17	10.25	45.42	54.00	8.58	AV
7	10640.00	26.56	15.47	42.03	74.00	31.97	PK
8	10640.00	17.55	15.47	33.02	54.00	20.98	AV
9	15960.00	21.62	22.57	44.19	74.00	29.81	PK
10	15960.00	13.47	22.57	36.04	54.00	17.96	AV

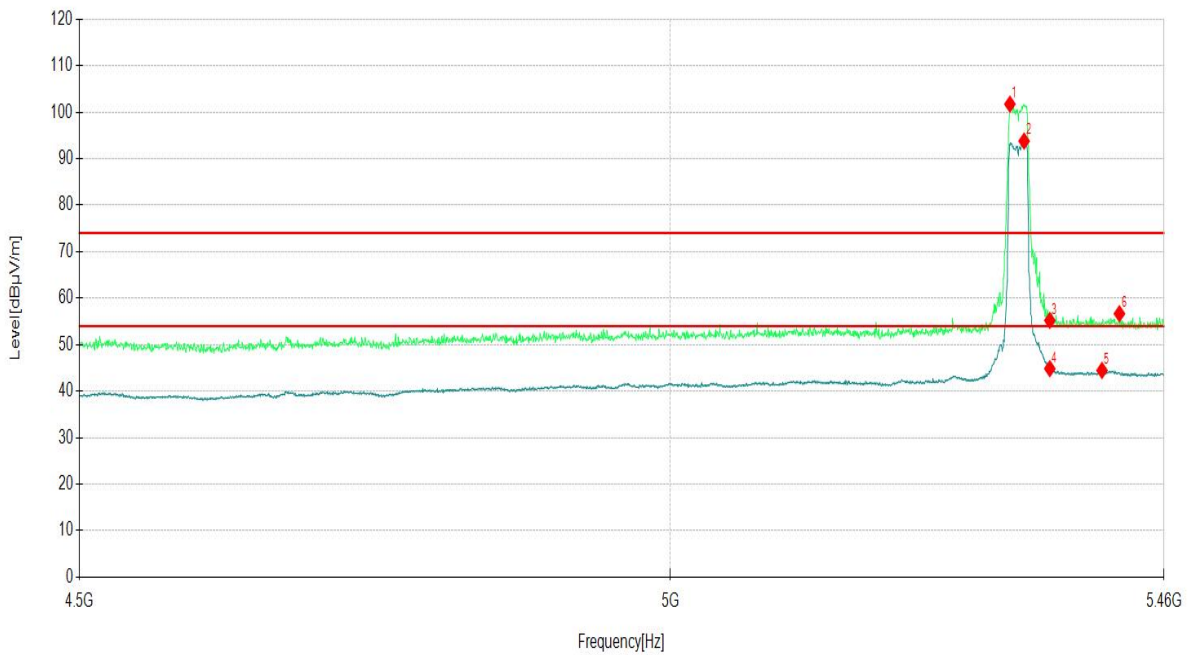

Remark: 1. The emission levels of other frequencies were greater than 20dB margin.
 2. Level (dBuV/m) = Reading (dBuV) + Factor (dB/m).
 3. Factor (dB/m) = Antenna Factor (dB/m) + Cable Factor (dB).
 4. Margin(dB) = Limit[dBμV/m] - Level [dBμV/m]

Channel	802.11a CH64	Frequency	5320 MHz
Frequency Range	Above 1G	Detector Function	PK/AV

Vertical

NO.	Freq. [MHz]	Reading [dBμV]	Factor [dB/m]	Level [dBμV/m]	Limit [dBμV/m]	Margin [dB]	Detector
1	5324.57	91.11	8.92	100.03			PK
2	5326.97	81.70	9.04	90.74			AV
3	5350.00	45.57	9.66	55.23	74.00	18.77	PK
4	5350.00	34.69	9.66	44.35	54.00	9.65	AV
5	5405.25	34.42	9.88	44.30	54.00	9.70	AV
6	5416.30	46.73	9.68	56.41	74.00	17.59	PK
7	10640.00	26.83	15.47	42.30	74.00	31.70	PK
8	10640.00	17.63	15.47	33.10	54.00	20.90	AV
9	15960.00	22.95	22.57	45.52	74.00	28.48	PK
10	15960.00	12.88	22.57	35.45	54.00	18.55	AV

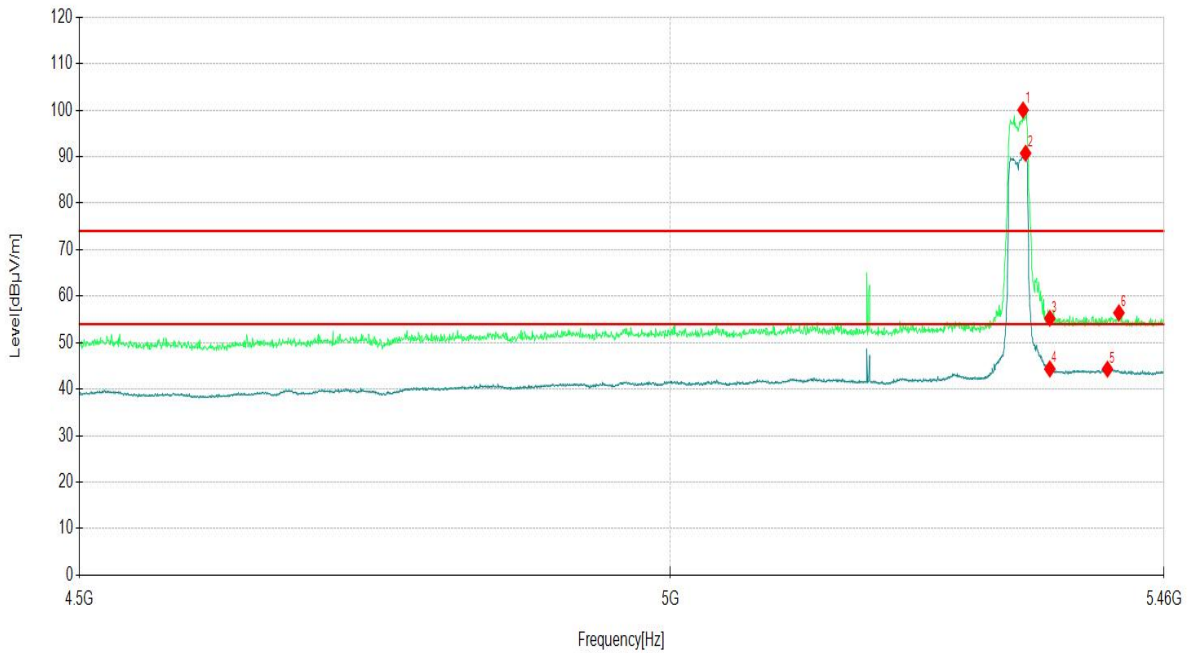

Remark: 1. The emission levels of other frequencies were greater than 20dB margin.
 2. Level (dBμV/m) = Reading (dBμV) + Factor (dB/m).
 3. Factor (dB/m) = Antenna Factor (dB/m) + Cable Factor (dB).
 4. Margin(dB) = Limit[dBμV/m] - Level [dBμV/m]

3.1.9 TEST RESULTS - Band 3 (5500-5700MHz):

ABOVE 1GHz DATA

All test modes have been conducted, and the report only presents the worst case.

Channel	802.11a CH100	Frequency	5500 MHz				
Frequency Range	Above 1G	Detector Function	PK/AV				
Horizontal							
NO.	Freq. [MHz]	Reading [dBμV]	Factor [dB/m]	Level [dBμV/m]	Limit [dBμV/m]	Margin [dB]	Detector
1	5424.91	46.73	9.56	56.29	74.00	17.71	PK
2	5455.05	46.19	9.66	55.85	74.00	18.15	PK
3	5458.30	34.44	9.74	44.18	54.00	9.82	AV
4	5470.00	45.31	9.75	55.06	68.20	13.14	PK
5	5504.83	91.71	9.28	100.99			PK
6	5506.58	82.90	9.37	92.27			AV
7	11000.00	26.60	16.33	42.93	74.00	31.07	PK
8	11000.00	17.39	16.33	33.72	54.00	20.28	AV
9	16500.00	20.49	24.06	44.55	68.20	23.65	PK
10	16500.00	11.85	24.06	35.91	54.00	18.09	AV

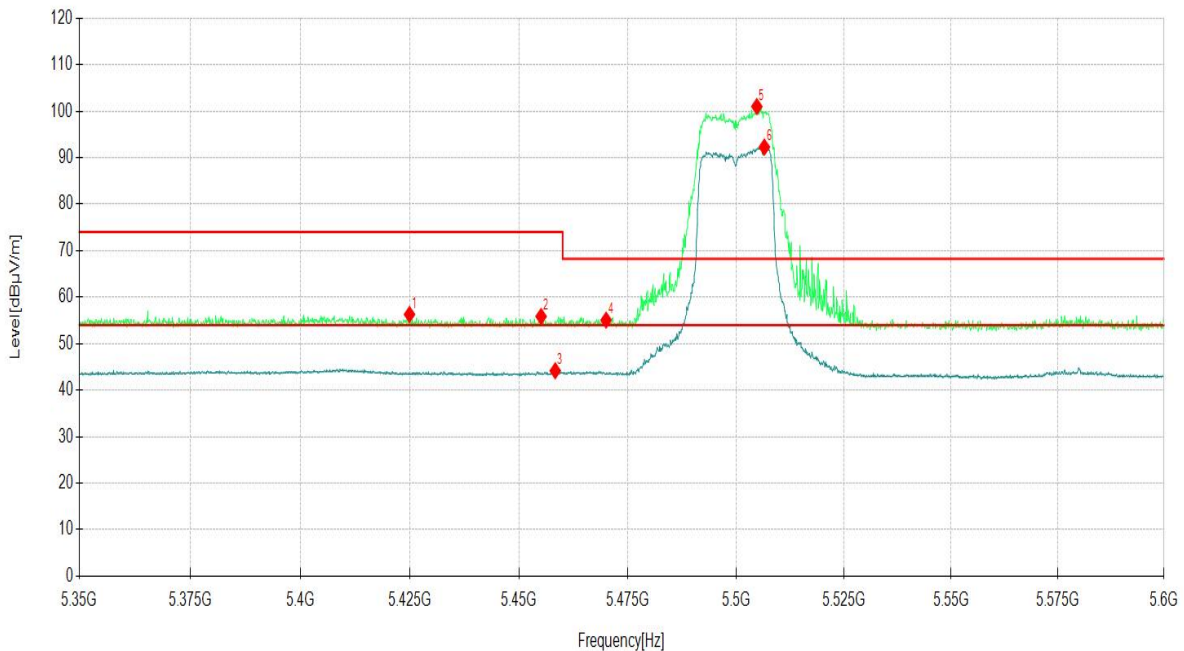

Remark: 1. The emission levels of other frequencies were greater than 20dB margin.
 2. Level (dBμV/m) = Reading (dBμV) + Factor (dB/m).
 3. Factor (dB/m) = Antenna Factor (dB/m) + Cable Factor (dB).
 4. Margin(dB) = Limit[dBμV/m] - Level [dBμV/m]

Channel	802.11a CH100	Frequency	5500 MHz
Frequency Range	Above 1G	Detector Function	PK/AV

Vertical

NO.	Freq. [MHz]	Reading [dBμV]	Factor [dB/m]	Level [dBμV/m]	Limit [dBμV/m]	Margin [dB]	Detector
1	5442.05	46.04	9.50	55.54	74.00	18.46	PK
2	5454.80	45.92	9.65	55.57	74.00	18.43	PK
3	5460.81	34.42	9.79	44.21	54.00	9.79	AV
4	5470.00	44.19	9.75	53.94	68.20	14.26	PK
5	5506.08	87.96	9.35	97.31			PK
6	5507.45	78.50	9.43	87.93			AV
7	11000.00	26.88	16.33	43.21	74.00	30.79	PK
8	11000.00	17.58	16.33	33.91	54.00	20.09	AV
9	16500.00	20.30	24.06	44.36	68.20	23.84	PK
10	16500.00	11.82	24.06	35.88	54.00	18.12	AV

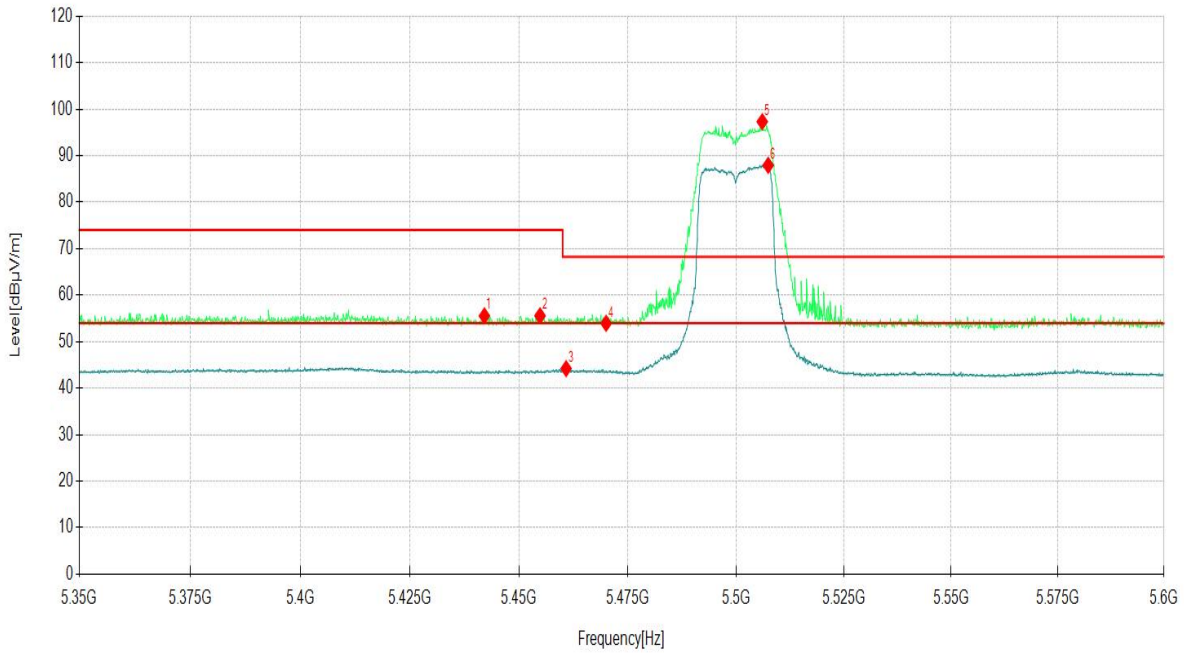

Remark: 1. The emission levels of other frequencies were greater than 20dB margin.
 2. Level (dBuV/m) = Reading (dBuV) + Factor (dB/m).
 3. Factor (dB/m) = Antenna Factor (dB/m) + Cable Factor (dB).
 4. Margin(dB) = Limit[dBμV/m] - Level [dBμV/m]



Channel		802.11a CH 116		Frequency		5580MHz	
Frequency Range		Above 1G		Detector Function		PK/AV	
Horizontal							
NO.	Freq. [MHz]	Reading [dBμV]	Factor [dB/m]	Level [dBμV/m]	Limit [dBμV/m]	Margin [dB]	Detector
1	11160.00	25.14	16.69	41.83	74.00	32.17	PK
2	11160.00	16.56	16.69	33.25	54.00	20.75	AV
3	16740.00	21.99	25.38	47.37	68.20	20.83	PK
4	16740.00	11.97	25.38	37.35	54.00	16.65	AV
Vertical							
NO.	Freq. [MHz]	Reading [dBμV]	Factor [dB/m]	Level [dBμV/m]	Limit [dBμV/m]	Margin [dB]	Detector
1	11160.00	25.32	16.69	42.01	74.00	31.99	PK
2	11160.00	16.80	16.69	33.49	54.00	20.51	AV
3	16740.00	20.13	25.38	45.51	68.20	22.69	PK
4	16740.00	11.86	25.38	37.24	54.00	16.76	AV
<p>Remark: 1. The emission levels of other frequencies were greater than 20dB margin. 2. Level (dBuV/m) = Reading (dBuV) + Factor (dB/m). 3. Factor (dB/m) = Antenna Factor (dB/m) + Cable Factor (dB). 4. Margin(dB) = Limit[dBμV/m] - Level [dBμV/m]</p>							

Channel	802.11a CH140	Frequency	5700 MHz
Frequency Range	Above 1G	Detector Function	PK/AV

Horizontal

NO.	Freq. [MHz]	Reading [dBμV]	Factor [dB/m]	Level [dBμV/m]	Limit [dBμV/m]	Margin [dB]	Detector
1	5704.98	93.28	8.78	102.06			PK
2	5725.00	45.28	8.89	54.17	68.20	14.03	PK
3	5740.90	47.38	8.94	56.32	68.20	11.88	PK
4	11400.00	26.24	16.60	42.84	74.00	31.16	PK
5	11400.00	16.78	16.60	33.38	54.00	20.62	AV
6	17100.00	19.64	27.23	46.87	68.20	21.33	PK
7	17100.00	10.30	27.23	37.53	54.00	16.47	AV

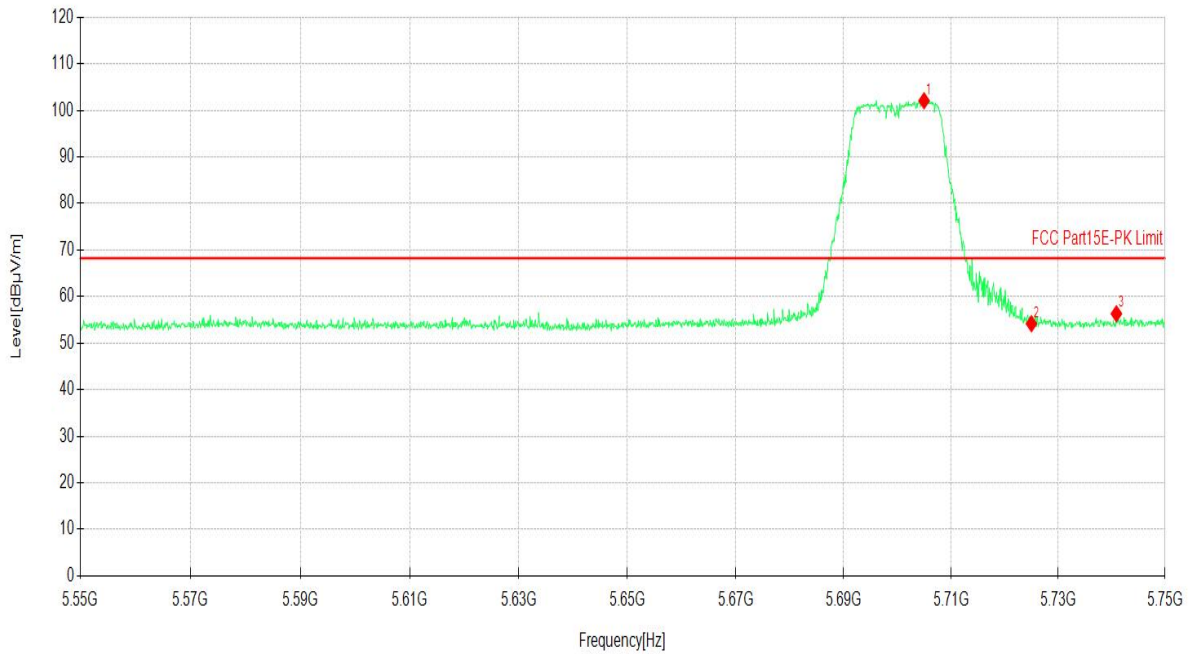

Remark: 1. The emission levels of other frequencies were greater than 20dB margin.
 2. Level (dBuV/m) = Reading (dBuV) + Factor (dB/m).
 3. Factor (dB/m) = Antenna Factor (dB/m) + Cable Factor (dB).
 4. Margin(dB) = Limit[dBμV/m] - Level [dBμV/m]

Channel	802.11a CH140	Frequency	5700 MHz
Frequency Range	Above 1G	Detector Function	PK/AV

Vertical

NO.	Freq. [MHz]	Reading [dBμV]	Factor [dB/m]	Level [dBμV/m]	Limit [dBμV/m]	Margin [dB]	Detector
1	5706.58	88.38	8.72	97.10			PK
2	5725.00	45.60	8.89	54.49	68.20	13.71	PK
3	5737.29	46.61	8.87	55.48	68.20	12.72	PK
4	11400.00	25.94	16.60	42.54	74.00	31.46	PK
5	11400.00	16.72	16.60	33.32	54.00	20.68	AV
6	17100.00	19.63	27.23	46.86	68.20	21.34	PK
7	17100.00	10.36	27.23	37.59	54.00	16.41	AV

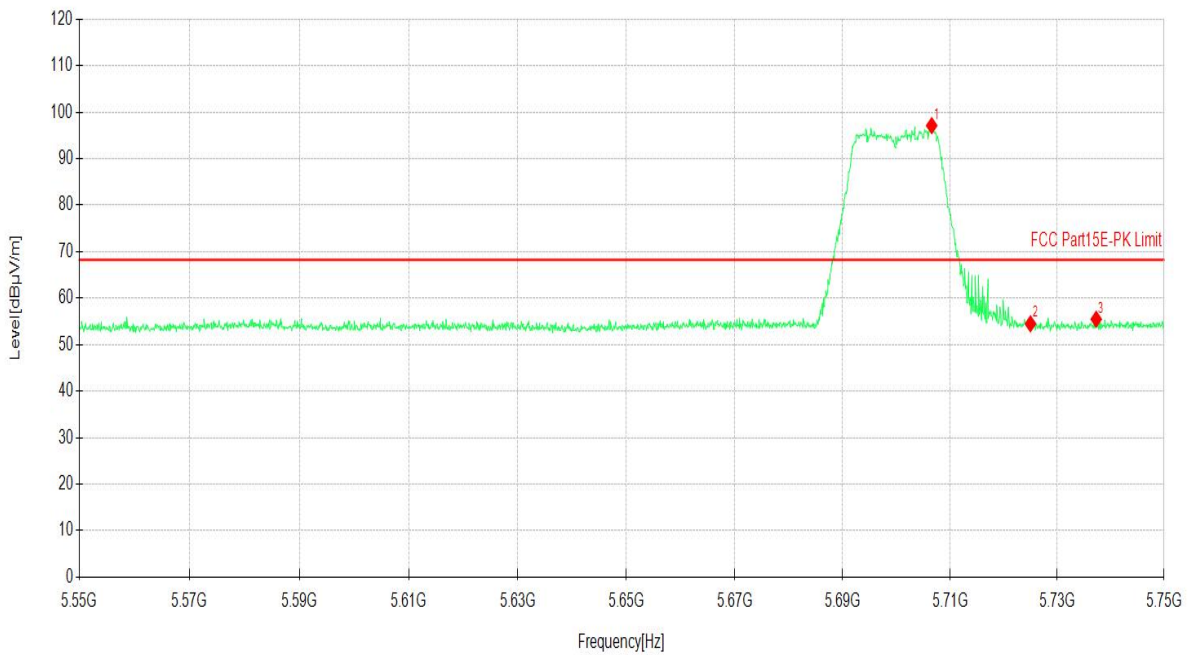

Remark: 1. The emission levels of other frequencies were greater than 20dB margin.
 2. Level (dBuV/m) = Reading (dBuV) + Factor (dB/m).
 3. Factor (dB/m) = Antenna Factor (dB/m) + Cable Factor (dB).
 4. Margin(dB) = Limit[dBμV/m] - Level [dBμV/m]

3.1.10 TEST RESULTS - Band 4 (5745-5825MHz):

ABOVE 1GHz DATA

All test modes have been conducted, and the report only presents the worst case.

Channel	802.11a CH149	Frequency	5745 MHz
Frequency Range	Above 1G	Detector Function	PK/AV

Horizontal

NO.	Freq. [MHz]	Reading [dBμV]	Factor [dB/m]	Level [dBμV/m]	Limit [dBμV/m]	Margin [dB]	Detector
1	5624.57	47.06	9.02	56.08	68.20	12.12	PK
2	5741.45	87.75	8.94	96.69			PK
3	5936.36	47.10	10.69	57.79	68.20	10.41	PK
4	11490.00	24.49	16.45	40.94	74.00	33.06	PK
5	11490.00	17.12	16.45	33.57	54.00	20.43	AV
6	17235.00	19.26	27.05	46.31	68.20	21.89	PK
7	17235.00	12.01	27.05	39.06	54.00	14.94	AV

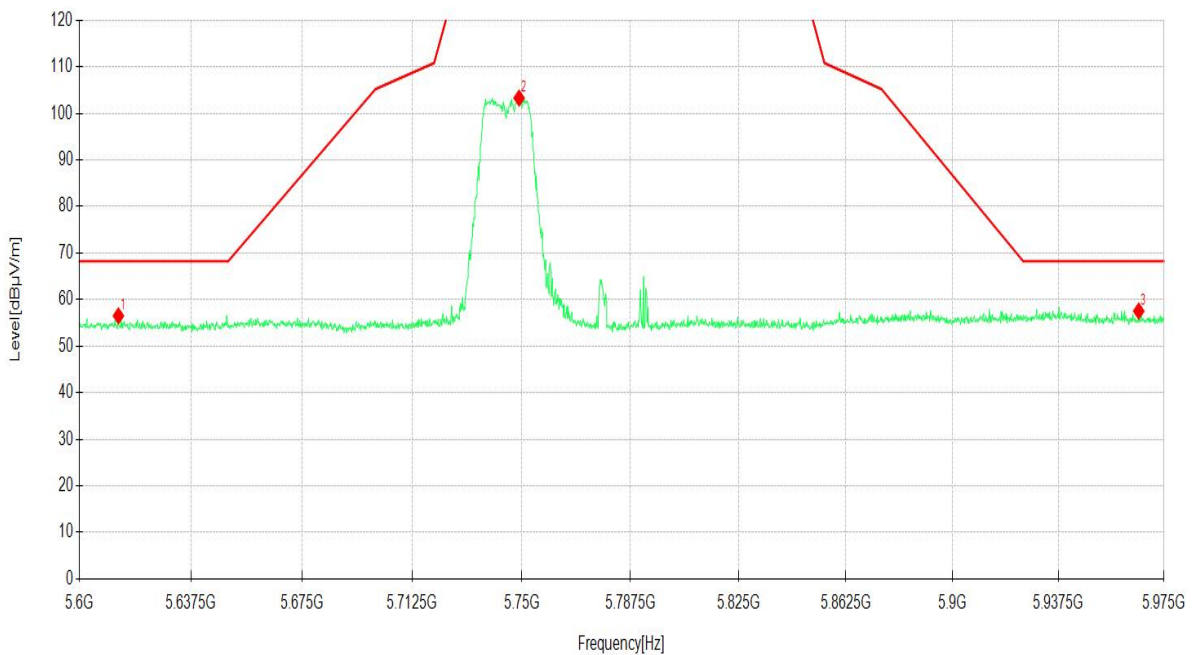

- Remark: 1. The emission levels of other frequencies were greater than 20dB margin.
 2. Level (dBuV/m) = Reading (dBuV) + Factor (dB/m).
 3. Factor (dB/m) = Antenna Factor (dB/m) + Cable Factor (dB).
 4. Margin(dB) = Limit[dBμV/m] - Level [dBμV/m]

Channel	802.11a CH149	Frequency	5745 MHz
Frequency Range	Above 1G	Detector Function	PK/AV

Vertical

NO.	Freq. [MHz]	Reading [dBμV]	Factor [dB/m]	Level [dBμV/m]	Limit [dBμV/m]	Margin [dB]	Detector
1	5633.20	47.80	8.85	56.65	68.20	11.55	PK
2	5752.89	94.46	9.06	103.52			PK
3	5937.86	47.49	10.75	58.24	68.20	9.96	PK
4	11510.00	26.69	15.12	41.81	54.00	12.19	AV
5	11510.00	34.66	15.12	49.78	74.00	24.22	PK
6	17265.00	20.70	25.62	46.32	68.20	21.88	PK
7	17265.00	13.40	25.62	39.02	54.00	14.98	AV

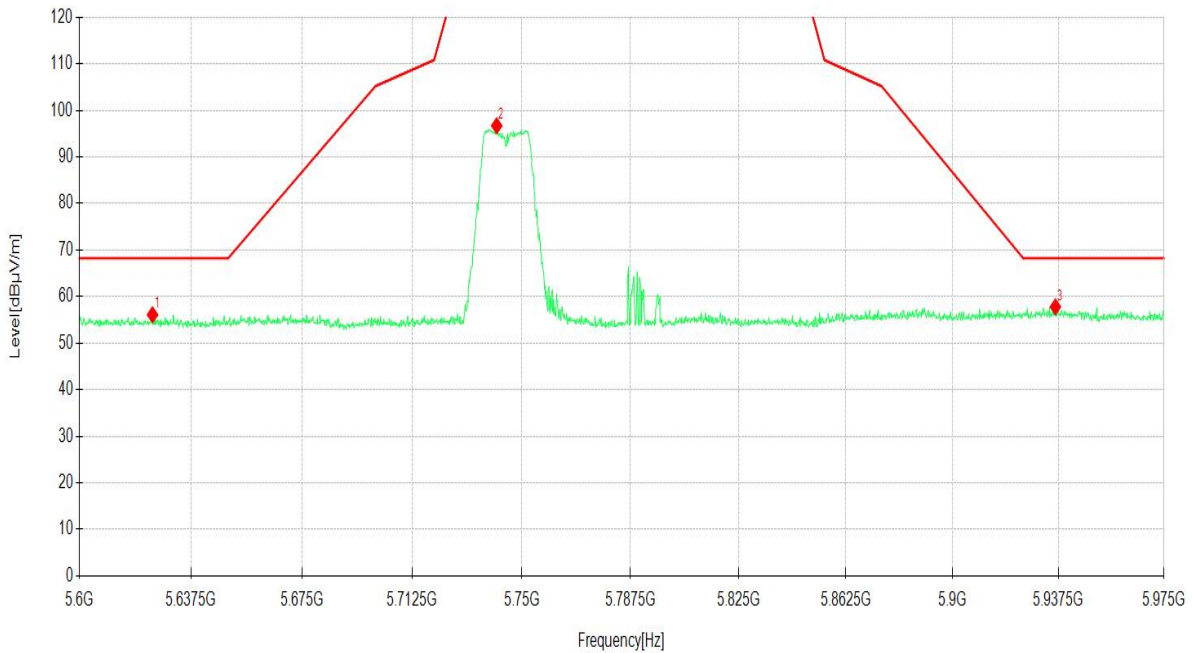

Remark: 1. The emission levels of other frequencies were greater than 20dB margin.
 2. Level (dBuV/m) = Reading (dBuV) + Factor (dB/m).
 3. Factor (dB/m) = Antenna Factor (dB/m) + Cable Factor (dB).
 4. Margin(dB) = Limit[dBμV/m] - Level [dBμV/m]

Channel		802.11a CH 157		Frequency		5785MHz	
Frequency Range		Above 1G		Detector Function		PK/AV	
Horizontal							
NO.	Freq. [MHz]	Reading [dBμV]	Factor [dB/m]	Level [dBμV/m]	Limit [dBμV/m]	Margin [dB]	Detector
1	11650.00	24.79	16.70	41.49	74.00	32.51	PK
2	11650.00	17.56	16.70	34.26	54.00	19.74	AV
3	17475.00	18.18	28.12	46.30	68.20	21.90	PK
4	17475.00	10.64	28.12	38.76	54.00	15.24	AV
Vertical							
NO.	Freq. [MHz]	Reading [dBμV]	Factor [dB/m]	Level [dBμV/m]	Limit [dBμV/m]	Margin [dB]	Detector
1	11650.00	25.67	16.70	42.37	74.00	31.63	PK
2	11650.00	18.28	16.70	34.98	54.00	19.02	AV
3	17475.00	18.59	28.12	46.71	68.20	21.49	PK
4	17475.00	10.81	28.12	38.93	54.00	15.07	AV
Remark: 1. The emission levels of other frequencies were greater than 20dB margin. 2. Level (dBuV/m) = Reading (dBuV) + Factor (dB/m). 3. Factor (dB/m) = Antenna Factor (dB/m) + Cable Factor (dB). 4. Margin(dB) = Limit[dBμV/m] - Level [dBμV/m]							

Channel	802.11a CH165	Frequency	5825 MHz
Frequency Range	Above 1G	Detector Function	PK/AV

Horizontal

NO.	Freq. [MHz]	Reading [dBμV]	Factor [dB/m]	Level [dBμV/m]	Limit [dBμV/m]	Margin [dB]	Detector
1	5612.01	46.97	9.03	56.00	68.20	12.20	PK
2	5817.98	92.47	8.96	101.43			PK
3	5938.23	47.08	10.76	57.84	68.20	10.36	PK
4	11650.00	25.04	16.70	41.74	74.00	32.26	PK
5	11650.00	18.83	16.70	35.53	54.00	18.47	AV
6	17475.00	18.73	28.12	46.85	68.20	21.35	PK
7	17475.00	11.01	28.12	39.13	54.00	14.87	AV

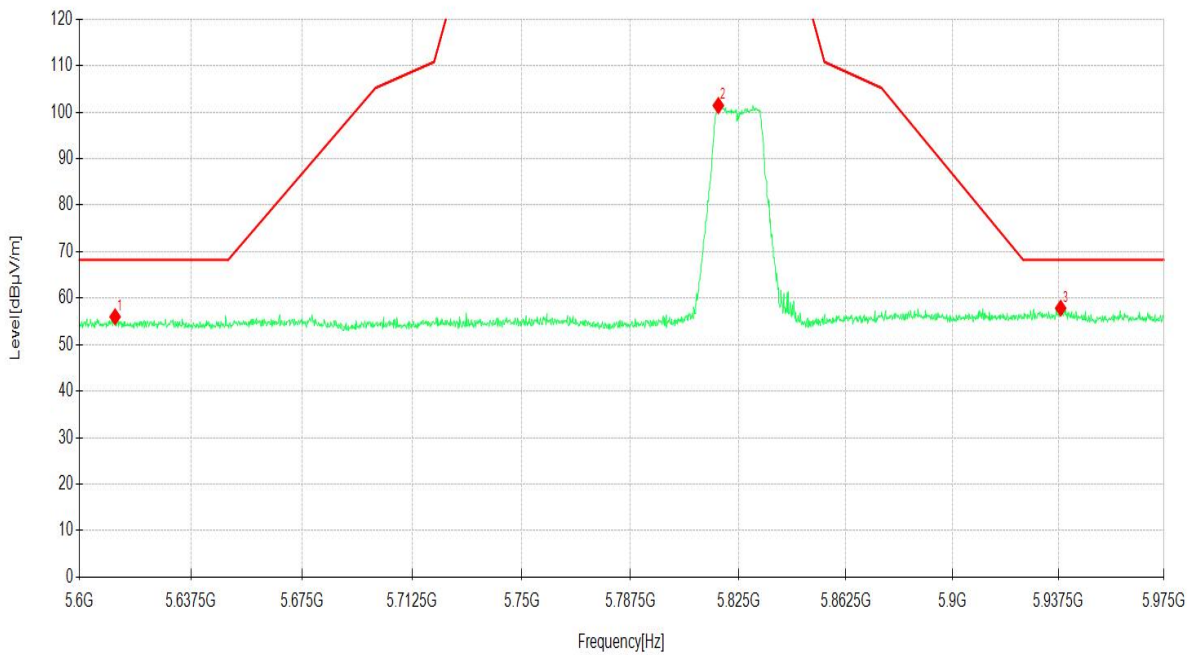

Remark: 1. The emission levels of other frequencies were greater than 20dB margin.
 2. Level (dBμV/m) = Reading (dBμV) + Factor (dB/m).
 3. Factor (dB/m) = Antenna Factor (dB/m) + Cable Factor (dB).
 4. Margin(dB) = Limit[dBμV/m] - Level [dBμV/m]

Channel	802.11a CH165	Frequency	5825 MHz
Frequency Range	Above 1G	Detector Function	PK/AV

Vertical

NO.	Freq. [MHz]	Reading [dBμV]	Factor [dB/m]	Level [dBμV/m]	Limit [dBμV/m]	Margin [dB]	Detector
1	5612.01	46.97	9.03	56.00	68.20	12.20	PK
2	5817.98	92.47	8.96	101.43			PK
3	5938.23	47.08	10.76	57.84	68.20	10.36	PK
4	11650.00	25.04	16.70	41.74	74.00	32.26	PK
5	11650.00	18.83	16.70	35.53	54.00	18.47	AV
6	17475.00	18.73	28.12	46.85	68.20	21.35	PK
7	17475.00	11.01	28.12	39.13	54.00	14.87	AV

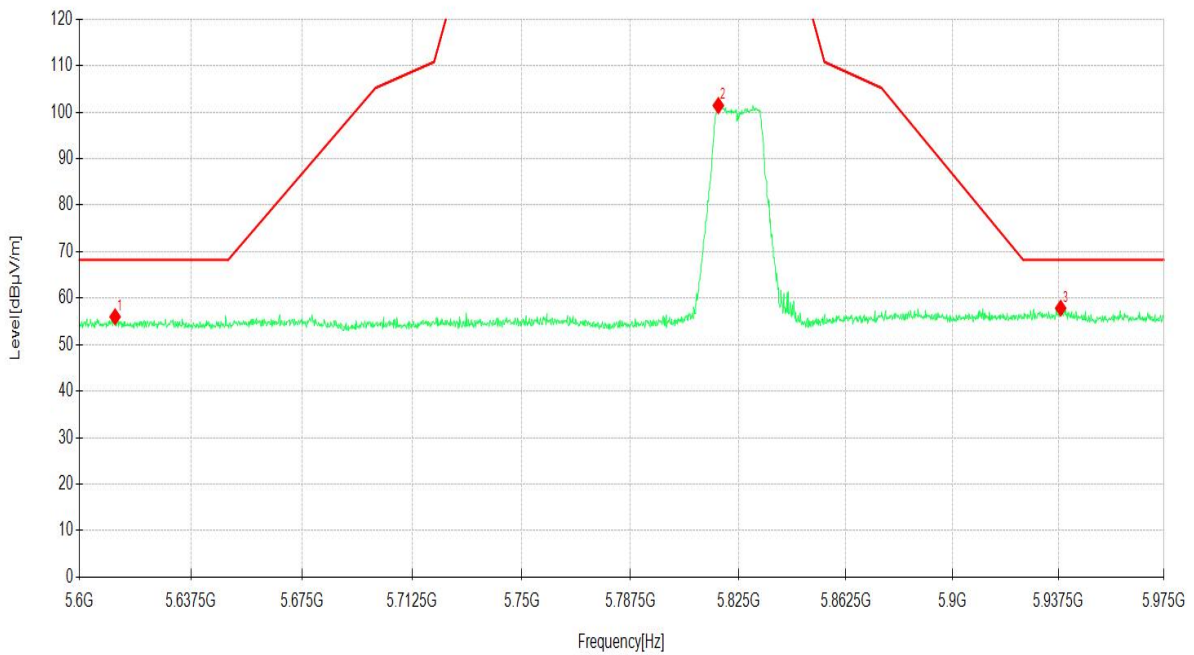

Remark: 1. The emission levels of other frequencies were greater than 20dB margin.
 2. Level (dBμV/m) = Reading (dBμV) + Factor (dB/m).
 3. Factor (dB/m) = Antenna Factor (dB/m) + Cable Factor (dB).
 4. Margin(dB) = Limit[dBμV/m] - Level [dBμV/m]

3.3 OCCUPIED BANDWIDTH MEASUREMENT

3.3.1 Measurement procedure

The transmitter antenna output was connected to the spectrum analyzer through an attenuator. The resolution bandwidth shall be set to the range of 1% to 5% of the anticipated emission bandwidth, and a video bandwidth at least 3x the resolution bandwidth. below the lower and above the upper frequency limits, the mean powers emitted are each equal to a specified percentage 0.5 %of the total mean power of a given emission.

3.3.2 TEST SETUP



3.4 26DB EMISSION BANDWIDTH

3.4.1 LIMITS OF 26DB EMISSION BANDWIDTH

This section is for reporting purpose only, there is on restriction limit of bandwidth

3.4.2 TEST PROCEDURES

FOR 26dB BANDWIDTH

- 1) Set RBW = approximately 1% of the emission bandwidth.
- 2) Set the VBW > RBW.
- 3) Detector = Peak
- 4) Trace mode = max hold.
- 5) Measure the maximum width of the emission that is 26 dB down from the peak of the emission. Compare this with the RBW setting of the analyzer. Readjust RBW and repeat measurement as needed until the RBW/EBW ratio is approximately 1%.

3.4.3 TEST SETUP

FOR 26dB BANDWIDTH

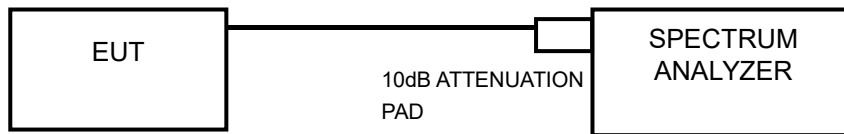

3.5 6DB EMISSION BANDWIDTH

3.5.1 LIMITS OF 6DB EMISSION BANDWIDTH

The minimum of 6dB Bandwidth Measurement is 0.5MHz.

3.5.2 TEST PROCEDURES

FOR 6dB BANDWIDTH

- 1)Set RBW = 100 kHz.
- 2)Set the video bandwidth (VBW) \geq 3 RBW.
- 3)Detector = Peak.
- 4)Trace mode = max hold.
- 5) Sweep = auto couple.
- 6) Allow the trace to stabilize.
- 7)Measure the maximum width of the emission that is constrained by the frequencies associated with the two outermost amplitude points (upper and lower frequencies) that are attenuated by 6 dB relative to the maximum level measured in the fundamental emission.

3.5.3 TEST SETUP

FOR 6dB BANDWIDTH

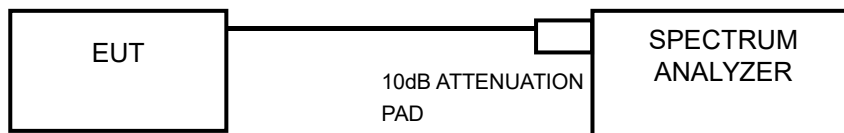

3.6 TRANSMIT POWER MEASUREMENT

3.6.1 LIMITS OF TRANSMIT POWER MEASUREMENT(FCC)

Operation Band	EUT Category		LIMIT
U-NII-1		Outdoor Access Point	1 Watt (30 dBm) (Max. e.i.r.p \cong 125mW(21 dBm) at any elevation angle above 30 degrees as measured from the horizon)
		Fixed point-to-point Access Point	1 Watt (30 dBm)
		Indoor Access Point	1 Watt (30 dBm)
	√	Mobile and Portable client device	250mW (24 dBm)
U-NII-2A	√		250mW(24dBm) or 11 dBm+10LogB*
U-NII-2C	√		250mW(24dBm) or 11 dBm+10LogB*
U-NII-3	√		1 Watt (30 dBm)

NOTE: 1. Where B is the 26dB emission bandwidth in MHz.

3.6.2 TEST PROCEDURES

FOR AVERAGE POWER MEASUREMENT

Method PM is used to perform output power measurement, trigger and gating function of wide band power meter is enabled to measure max output power of TX on burst. Duty factor is not added to measured value.

3.6.3 TEST SETUP

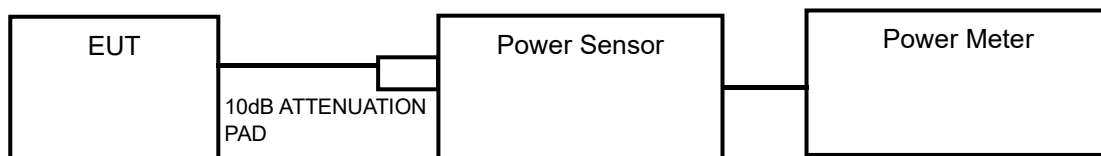

3.7 POWER SPECTRAL DENSITY MEASUREMENT

3.7.1 LIMITS OF PEAK POWER SPECTRAL DENSITY MEASUREMENT(FCC)

Operation Band	EUT Category		LIMIT
U-NII-1		Outdoor Access Point	17dBm/ MHz
		Fixed point-to-point Access Point	
		Indoor Access Point	
	√	Mobile and Portable client device	11dBm/ MHz
U-NII-2A	√		11dBm/ MHz
U-NII-2C	√		11dBm/ MHz
U-NII-3	√		30dBm/ 500kHz

3.7.2 TEST PROCEDURE

For U-NII-1, U-NII-2A, U-NII-2Cband:

Using method SA-2

- 1) Set span to encompass the entire emission bandwidth (EBW) of the signal.
- 2) Set RBW = 1MHz, Set VBW =3 MHz, Detector = AV
- 3) Set Channel power measure = 1MHz
- 4) Sweep time = auto, trigger set to“free run”.
- 5) Trace average at least 100 traces in power averaging mode.
- 6) Record the max value and add 10 log (1/duty cycle)

For U-NII-3 band:

Using method SA-2

- 1) Set span to encompass the entire emission bandwidth (EBW) of the signal.
- 2) Set RBW = 300 kHz, Set VBW =1 MHz, Detector = AV
- 3) Set Channel power measure = 1MHz
- 4) Sweep time = auto, trigger set to“free run”.
- 5) Trace average at least 100 traces in power averaging mode.
- 6) Record the max value and add 10 log (1/duty cycle)

3.7.3 TEST SETUP

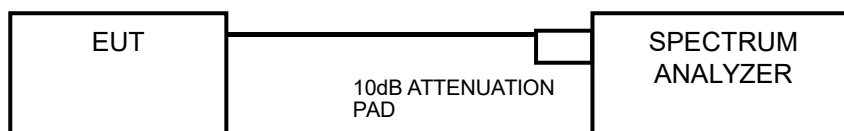

3.8 FREQUENCY STABILITY

3.8.1 LIMITS OFFREQUENCY STABILITY

The frequency of the carrier signal shall be maintained within band of operation.

3.8.2 TEST PROCEDURES

- a. The EUT was placed inside the environmental test chamber and powered by nominal AC voltage.
- b. Turn the EUT on and couple its output to a spectrum analyzer.
- c. Turn the EUT off and set the chamber to the highest temperature specified.
- d. Allow sufficient time (approximately 30 min) for the temperature of the chamber to stabilize, turn the EUT on and measure the operating frequency after 2, 5, and 10 minutes.
- e. Repeat step 2 and 3 with the temperature chamber set to the lowest temperature.
- f. The test chamber was allowed to stabilize at +20 degree C for a minimum of 30minutes. The supply voltage was then adjusted on the EUT from 85% to 115%and the frequency record.

3.8.3 TEST SETUP

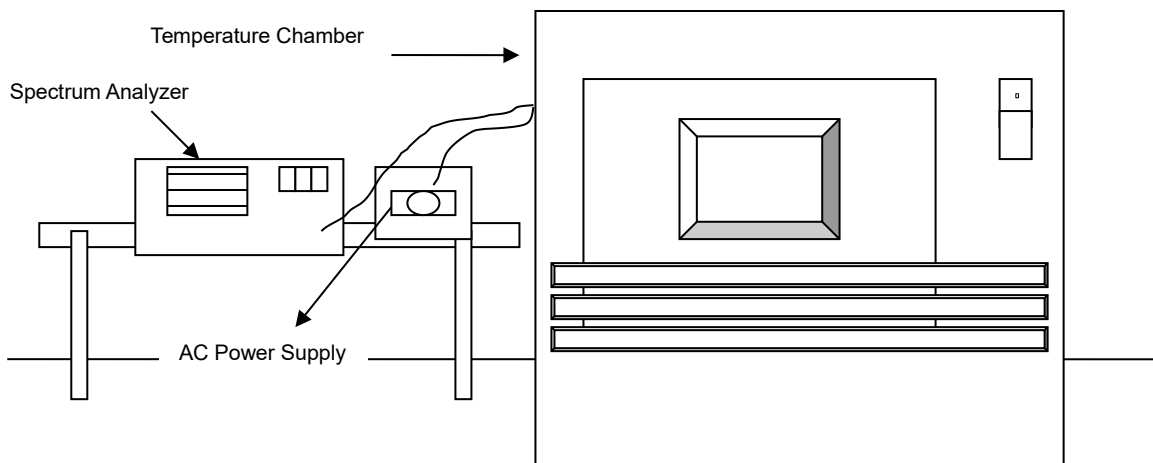

3.9 ANTENNA REQUIREMENT

3.9.1 LIMITS OFFREQUENCY STABILITY

For intentional device, according to FCC 47 CFR Section 15.203, an intentional radiator shall be designed to ensure that no antenna other than that furnished by the responsible party shall be used with the device. According to FCC 47 CFR Section 15.407(a)(1)(2) , if transmitting antennas of directional gain greater than 6 dBi are used, the power shall be reduced by the amount in dB that the directional gain of the antenna exceeds 6 dBi.

3.9.2 ANTENNA ANTI-REPLACEMENT CONSTRUCTION

The antenna used for this product is FPC antenna and that no antenna other than that furnished by the responsible party shall be used with the device

3.9.3 ANTENNA GAIN

The maximum peak gain of the transmit antenna is 4.04 dBi.

4 PHOTOGRAPHS OF TEST SETUP

Please refer to the attached file (Test Setup Photo).

5 PHOTOGRAPHS OF THE EUT

Please refer to the attached file (External Photos report and Internal Photos).

----- End of the Report -----

Important

- (1) The test report is valid without the official stamp of CVC;
- (2) Any part photocopies of the test report are forbidden without the written permission from CVC;
- (3) The test report is invalid without the signatures of Approval and Reviewer;
- (4) The test report is invalid if altered;
- (5) Objections to the test report must be submitted to CVC within 15 days.
- (6) Generally, commission test is responsible for the tested samples only.
- (7) As for the test result “-” or “N” means “not applicable”, “/” means “not test”, “P” means “pass” and “F” means “fail”

Address: No. 1301-14&16, Guanguang Road, Xinlan Community, Guanlan Subdistrict, Longhua District, Shenzhen, Guangdong, China

Post Code: 518110 Tel: 0755-23763060-8805

Fax: 0755-23763060 E-mail: sz-kf@cvc.org.cn

<http://www.cvc.org.cn>