



RF TEST REPORT

Applicant Shanghai Smawave Technology Co. ,Ltd
FCC ID 2AU8HSRW310
Product Outdoor CPE
Model SRW310
Report No. R2002A0093-R1VG
Issue Date May 21 , 2020

TA Technology (Shanghai) Co., Ltd. tested the above equipment in accordance with the requirements in **FCC CFR47 Part 2 (2019)/ FCC CFR 47 Part 96E (2019)**. The test results show that the equipment tested is capable of demonstrating compliance with the requirements as documented in this report.

Performed by: Peng Tao

Approved by: Kai Xu

TA Technology (Shanghai) Co., Ltd.

No.145, Jintang Rd, Tangzhen Industry Park, Pudong Shanghai, China

TEL: +86-021-50791141/2/3

FAX: +86-021-50791141/2/3-8000



TABLE OF CONTENT

- 1. Test Laboratory4
 - 1.1. Notes of the Test Report 4
 - 1.2. Test facility.....4
 - 1.3. Testing Location 4
- 2. General Description of Equipment under Test.....5
 - 2.3. Applicant and Manufacturer Information5
 - 2.4. General Information..... 5
- 3. Applied Standards6
- 4. Test Configuration.....7
- 5. Test Case Results.....8
 - 5.1. RF Power Output..... 8
 - 5.2. Maximum Effective Isotropic Radiated Power and Maximum Power Spectral Density 15
 - 5.3. Occupied Bandwidth 31
 - 5.4. Band Edge Compliance..... 40
 - 5.5. Peak-to-Average Power Ratio (PAPR) 50
 - 5.6. Frequency Stability..... 53
 - 5.7. Spurious Emissions at Antenna Terminals 57
 - 5.8. Radiates Spurious Emission 67
- 6. Main Test Instruments70



Summary of measurement results

No.	Test Type	Clause in FCC rules	Verdict
1	RF power output	2.1046/ 96.41(b)	PASS
2	Maximum Effective Isotropic Radiated Power and Maximum Power Spectral Density	96.41(b)	PASS
3	Occupied Bandwidth	2.1049/ 96.41	PASS
4	Band Edge Compliance	2.1051/ 96.41(e)	PASS
5	Peak-to-Average Power Ratio	96.41(g)	PASS
6	Frequency Stability	2.1055	PASS
7	Spurious Emissions at Antenna Terminals	2.1051 / 96.41(e)	PASS
8	Radiates Spurious Emission	2.1051 / 96.41(e)	PASS

Date of Testing: March 4, 2020 ~ April 16, 2020

Note: PASS: The EUT complies with the essential requirements in the standard.
FAIL: The EUT does not comply with the essential requirements in the standard.
All indications of Pass/Fail in this report are opinions expressed by TA Technology (Shanghai) Co., Ltd. based on interpretations and/or observations of test results. Measurement Uncertainties were not taken into account and are published for informational purposes only.

Note This revised report (Report No. R2002A0093-R1V2) supersedes and replaces the previously issued report (Report No. R2002A0093-R1V1). Please discard or destroy the previously issued report and dispose of it accordingly.



1. Test Laboratory

1.1. Notes of the Test Report

This report shall not be reproduced in full or partial, without the written approval of **TA technology (shanghai) co., Ltd.** The results documented in this report apply only to the tested sample, under the conditions and modes of operation as described herein .Measurement Uncertainties were not taken into account and are published for informational purposes only. This report is written to support regulatory compliance of the applicable standards stated above.

1.2. Test facility

FCC (Designation number: CN1179, Test Firm Registration Number: 446626)

TA Technology (Shanghai) Co., Ltd. has been listed on the US Federal Communications Commission list of test facilities recognized to perform electromagnetic emissions measurements.

A2LA (Certificate Number: 3857.01)

TA Technology (Shanghai) Co., Ltd. has been listed by American Association for Laboratory Accreditation to perform electromagnetic emission measurement.

1.3. Testing Location

Company: TA Technology (Shanghai) Co., Ltd.
Address: No.145, Jintang Rd, Tangzhen Industry Park, Pudong
City: Shanghai
Post code: 201201
Country: P. R. China
Contact: Xu Kai
Telephone: +86-021-50791141/2/3
Fax: +86-021-50791141/2/3-8000
Website: <http://www.ta-shanghai.com>
E-mail: xukai@ta-shanghai.com

2. General Description of Equipment under Test

2.3. Applicant and Manufacturer Information

Applicant	Shanghai Smawave Technology Co. ,Ltd
Applicant address	3/F, Building 8, 1001 North Qinzhou Road, Xuhui District, Shanghai, China
Manufacturer	Shanghai Smawave Technology Co. ,Ltd
Manufacturer address	3/F, Building 8, 1001 North Qinzhou Road, Xuhui District, Shanghai, China

2.4. General Information

EUT Description			
Model	SRW310		
IMEI	862165040656140		
Hardware Version	V1.0		
Software Version	MG6_0.3.2.20		
Power Supply	AC adapter		
Antenna Type	Internal Antenna		
Antenna Gain	16.00dBi		
Test Mode(s)	LTE Band 48;		
Test Modulation	QPSK,16QAM, 64QAM		
LTE Category	6		
Maximum Conducted Power(dBm)	LTE Band 48:	23.02	
Maximum EIRP (dBm/10MHz)	LTE Band 48:	39.02	
Maximum PSD (dBm/MHz)	LTE Band 48:	31.65	
Rated Power Supply Voltage	24V		
Extreme Voltage	Minimum: 19V Maximum: 26V		
Extreme Temperature	Lowest: -40°C Highest: +60°C		
Operating Frequency Range(s)	Band	Tx (MHz)	Rx (MHz)
	LTE Band 48	3550-3700	3550-3700
Note: 1. The EUT is sent from the applicant to TA and the information of the EUT is declared by the applicant.			



3. Applied Standards

According to the specifications of the manufacturer, it must comply with the requirements of the following standards:

Test standards:

FCC 47 CFR Part 96E (2019)

ANSI / TIA-603-E

Reference standard:

FCC 47 CFR Part 2 (2019)

FCC KDB 940660 D01 Part 96 CBRS Eqpt v02



4. Test Configuration

There is more than one SIM card slot, each one should be applied throughout the compliance test respectively, and however, only the worst case (SIM 1) will be recorded in this report.

Radiated measurements are performed by rotating the EUT in three different orthogonal test planes. EUT stand-up position (Z axis), lie-down position (X, Y axis). Receiver antenna polarization (horizontal and vertical), the worst emission was found in position (X axis, horizontal polarization) and the worst case was recorded.

All mode and data rates and positions were investigated. Subsequently, only the worst case emissions are reported.

Test modes are chosen to be reported as the worst case configuration below:

Test modes are chosen as the worst case configuration below for LTE Band 48.

Test items	Bandwidth (MHz)				Modulation			RB			Test Channel		
	5	10	15	20	QPSK	16QAM	64QAM	1	50%	100%	L	M	H
RF power output	O	O	O	O	O	O	O	O	O	O	O	O	O
Maximum Effective Isotropic Radiated Power and Maximum Power Spectral Density	O	O	O	O	O	O	O	O	O	O	O	O	O
Occupied Bandwidth	O	O	O	O	O	O	O	-	-	O	-	O	-
Band Edge Compliance	O	O	O	O	O	O	O	O	-	O	O	-	O
Peak-to-Average Power Ratio	O	O	O	O	O	O	O	-	-	O	O	O	O
Frequency Stability	O	O	O	O	O	O	O	O	O	O	O	O	O
Spurious Emissions at Antenna Terminals	O	O	O	O	O	-	-	O	-	-	O	O	O
Radiates Spurious Emission	O	-	O	O	O	-	-	O	-	-	-	O	-
Note	1. The mark "O" means that this configuration is chosen for testing. 2. The mark "-" means that this configuration is not testing.												

5. Test Case Results

5.1. RF Power Output

Ambient condition

Temperature	Relative humidity	Pressure
23°C ~25°C	45%~50%	101.5kPa

Methods of Measurement

A system simulator was used to establish communication with the EUT. Its parameters were set to force the EUT transmitting at maximum output power. The measured power in the radio frequency on the transmitter output terminals shall be reported.

1. The transmitter output port was connected to the system simulator.
2. Set EUT at maximum power through the system simulator.
3. Select lowest, middle, and highest channels for each band and different modulation.
4. Measure and record the power level from the system simulator.

Test Setup

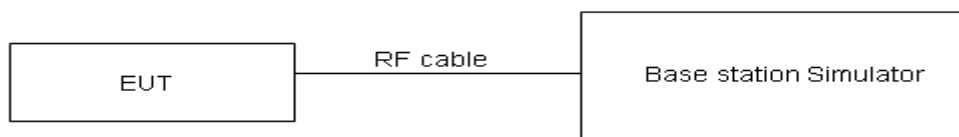

The loss between RF output port of the EUT and the input port of the tester has been taken into consideration.

Limits

Rule Part 96.41(b) specifies that

Device	Maximum EIRP (dBm/10MHz)	Maximum PSD (dBm/MHz)
End User Device	23	N/A
Category B CBSD ¹	47	37

NOTE: Category B CBSDs will only be authorized for use after an ESC is approved and commercially deployed consistent with §§96.15 and 96.67.

Measurement Uncertainty

The assessed measurement uncertainty to ensure 95% confidence level for the normal distribution is with the coverage factor $k = 2$, $U = 0.4$ dB.

**Test Results**

Band	Bandwidth	Modulation	Channel	RB Configuration	Conducted Power(dBm)	EIRP (dBm)
LTE Band48	5M	QPSK	56265	1RB#0	23.02	39.02
LTE Band48	5M	QPSK	56265	1RB#13	22.63	38.63
LTE Band48	5M	QPSK	56265	1RB#24	22.88	38.88
LTE Band48	5M	QPSK	56265	12RB#0	21.58	37.58
LTE Band48	5M	QPSK	56265	12RB#6	21.49	37.49
LTE Band48	5M	QPSK	56265	12RB#13	21.51	37.51
LTE Band48	5M	QPSK	56265	25RB#0	21.48	37.48
LTE Band48	5M	QPSK	56490	1RB#0	22.98	38.98
LTE Band48	5M	QPSK	56490	1RB#13	22.50	38.50
LTE Band48	5M	QPSK	56490	1RB#24	22.59	38.59
LTE Band48	5M	QPSK	56490	12RB#0	21.52	37.52
LTE Band48	5M	QPSK	56490	12RB#6	21.35	37.35
LTE Band48	5M	QPSK	56490	12RB#13	21.33	37.33
LTE Band48	5M	QPSK	56490	25RB#0	21.35	37.35
LTE Band48	5M	QPSK	56715	1RB#0	22.75	38.75
LTE Band48	5M	QPSK	56715	1RB#13	22.38	38.38
LTE Band48	5M	QPSK	56715	1RB#24	22.91	38.91
LTE Band48	5M	QPSK	56715	12RB#0	21.25	37.25
LTE Band48	5M	QPSK	56715	12RB#6	21.26	37.26
LTE Band48	5M	QPSK	56715	12RB#13	21.22	37.22
LTE Band48	5M	QPSK	56715	25RB#0	21.16	37.16
LTE Band48	5M	16QAM	56265	1RB#0	22.06	38.06
LTE Band48	5M	16QAM	56265	1RB#13	21.83	37.83
LTE Band48	5M	16QAM	56265	1RB#24	22.06	38.06
LTE Band48	5M	16QAM	56265	12RB#0	20.55	36.55
LTE Band48	5M	16QAM	56265	12RB#6	20.50	36.50
LTE Band48	5M	16QAM	56265	12RB#13	20.49	36.49
LTE Band48	5M	16QAM	56265	25RB#0	20.48	36.48
LTE Band48	5M	16QAM	56490	1RB#0	22.99	38.99
LTE Band48	5M	16QAM	56490	1RB#13	22.50	38.50
LTE Band48	5M	16QAM	56490	1RB#24	22.57	38.57
LTE Band48	5M	16QAM	56490	12RB#0	21.45	37.45
LTE Band48	5M	16QAM	56490	12RB#6	21.43	37.43
LTE Band48	5M	16QAM	56490	12RB#13	21.37	37.37
LTE Band48	5M	16QAM	56490	25RB#0	21.40	37.40
LTE Band48	5M	16QAM	56715	1RB#0	21.96	37.96
LTE Band48	5M	16QAM	56715	1RB#13	21.58	37.58
LTE Band48	5M	16QAM	56715	1RB#24	22.05	38.05
LTE Band48	5M	16QAM	56715	12RB#0	20.23	36.23



LTE Band48	5M	16QAM	56715	12RB#6	20.28	36.28
LTE Band48	5M	16QAM	56715	12RB#13	20.26	36.26
LTE Band48	5M	16QAM	56715	25RB#0	20.15	36.15
LTE Band48	5M	64QAM	56340	1RB#0	22.04	38.04
LTE Band48	5M	64QAM	56340	1RB#50	21.79	37.79
LTE Band48	5M	64QAM	56340	1RB#99	22.05	38.05
LTE Band48	5M	64QAM	56340	50RB#0	20.52	36.52
LTE Band48	5M	64QAM	56340	50RB#25	20.55	36.55
LTE Band48	5M	64QAM	56340	50RB#50	20.63	36.63
LTE Band48	5M	64QAM	56340	100RB#0	20.49	36.49
LTE Band48	5M	64QAM	56490	1RB#0	22.95	38.95
LTE Band48	5M	64QAM	56490	1RB#50	22.44	38.44
LTE Band48	5M	64QAM	56490	1RB#99	22.67	38.67
LTE Band48	5M	64QAM	56490	50RB#0	21.39	37.39
LTE Band48	5M	64QAM	56490	50RB#25	21.38	37.38
LTE Band48	5M	64QAM	56490	50RB#50	21.33	37.33
LTE Band48	5M	64QAM	56490	100RB#0	21.36	37.36
LTE Band48	5M	64QAM	56640	1RB#0	22.08	38.08
LTE Band48	5M	64QAM	56640	1RB#50	21.66	37.66
LTE Band48	5M	64QAM	56640	1RB#99	22.01	38.01
LTE Band48	5M	64QAM	56640	50RB#0	20.32	36.32
LTE Band48	5M	64QAM	56640	50RB#25	20.27	36.27
LTE Band48	5M	64QAM	56640	50RB#50	20.21	36.21
LTE Band48	5M	64QAM	56640	100RB#0	20.24	36.24
LTE Band48	10M	QPSK	56290	1RB#0	22.97	38.97
LTE Band48	10M	QPSK	56290	1RB#25	22.57	38.57
LTE Band48	10M	QPSK	56290	1RB#49	22.81	38.81
LTE Band48	10M	QPSK	56290	25RB#0	21.51	37.51
LTE Band48	10M	QPSK	56290	25RB#13	21.45	37.45
LTE Band48	10M	QPSK	56290	25RB#25	21.44	37.44
LTE Band48	10M	QPSK	56290	50RB#0	21.46	37.46
LTE Band48	10M	QPSK	56490	1RB#0	22.85	38.85
LTE Band48	10M	QPSK	56490	1RB#25	22.46	38.46
LTE Band48	10M	QPSK	56490	1RB#49	22.51	38.51
LTE Band48	10M	QPSK	56490	25RB#0	21.48	37.48
LTE Band48	10M	QPSK	56490	25RB#13	21.31	37.31
LTE Band48	10M	QPSK	56490	25RB#25	21.25	37.25
LTE Band48	10M	QPSK	56490	50RB#0	21.27	37.27
LTE Band48	10M	QPSK	56690	1RB#0	22.69	38.69
LTE Band48	10M	QPSK	56690	1RB#25	22.32	38.32
LTE Band48	10M	QPSK	56690	1RB#49	22.81	38.81
LTE Band48	10M	QPSK	56690	25RB#0	21.19	37.19
LTE Band48	10M	QPSK	56690	25RB#13	21.21	37.21



LTE Band48	10M	QPSK	56690	25RB#25	21.23	37.23
LTE Band48	10M	QPSK	56690	50RB#0	21.17	37.17
LTE Band48	10M	16QAM	56290	1RB#0	22.03	38.03
LTE Band48	10M	16QAM	56290	1RB#25	21.81	37.81
LTE Band48	10M	16QAM	56290	1RB#49	22.04	38.04
LTE Band48	10M	16QAM	56290	25RB#0	20.52	36.52
LTE Band48	10M	16QAM	56290	25RB#13	20.47	36.47
LTE Band48	10M	16QAM	56290	25RB#25	20.44	36.44
LTE Band48	10M	16QAM	56290	50RB#0	20.46	36.46
LTE Band48	10M	16QAM	56490	1RB#0	22.96	38.96
LTE Band48	10M	16QAM	56490	1RB#25	22.45	38.45
LTE Band48	10M	16QAM	56490	1RB#49	22.50	38.50
LTE Band48	10M	16QAM	56490	25RB#0	21.42	37.42
LTE Band48	10M	16QAM	56490	25RB#13	21.38	37.38
LTE Band48	10M	16QAM	56490	25RB#25	21.37	37.37
LTE Band48	10M	16QAM	56490	50RB#0	21.40	37.40
LTE Band48	10M	16QAM	56690	1RB#0	21.91	37.91
LTE Band48	10M	16QAM	56690	1RB#25	21.54	37.54
LTE Band48	10M	16QAM	56690	1RB#49	22.01	38.01
LTE Band48	10M	16QAM	56690	25RB#0	20.19	36.19
LTE Band48	10M	16QAM	56690	25RB#13	20.22	36.22
LTE Band48	10M	16QAM	56690	25RB#25	20.23	36.23
LTE Band48	10M	16QAM	56690	50RB#0	20.13	36.13
LTE Band48	10M	64QAM	56340	1RB#0	22.01	38.01
LTE Band48	10M	64QAM	56340	1RB#50	21.77	37.77
LTE Band48	10M	64QAM	56340	1RB#99	22.03	38.03
LTE Band48	10M	64QAM	56340	50RB#0	20.49	36.49
LTE Band48	10M	64QAM	56340	50RB#25	20.52	36.52
LTE Band48	10M	64QAM	56340	50RB#50	20.58	36.58
LTE Band48	10M	64QAM	56340	100RB#0	20.47	36.47
LTE Band48	10M	64QAM	56490	1RB#0	22.92	38.92
LTE Band48	10M	64QAM	56490	1RB#50	22.39	38.39
LTE Band48	10M	64QAM	56490	1RB#99	22.60	38.60
LTE Band48	10M	64QAM	56490	50RB#0	21.36	37.36
LTE Band48	10M	64QAM	56490	50RB#25	21.33	37.33
LTE Band48	10M	64QAM	56490	50RB#50	21.33	37.33
LTE Band48	10M	64QAM	56490	100RB#0	21.36	37.36
LTE Band48	10M	64QAM	56640	1RB#0	22.03	38.03
LTE Band48	10M	64QAM	56640	1RB#50	21.62	37.62
LTE Band48	10M	64QAM	56640	1RB#99	21.97	37.97
LTE Band48	10M	64QAM	56640	50RB#0	20.28	36.28
LTE Band48	10M	64QAM	56640	50RB#25	20.21	36.21
LTE Band48	10M	64QAM	56640	50RB#50	20.18	36.18



LTE Band48	10M	64QAM	56640	100RB#0	20.22	36.22
LTE Band48	15M	QPSK	56315	1RB#0	22.96	38.96
LTE Band48	15M	QPSK	56315	1RB#38	22.55	38.55
LTE Band48	15M	QPSK	56315	1RB#74	22.78	38.78
LTE Band48	15M	QPSK	56315	36RB#0	21.49	37.49
LTE Band48	15M	QPSK	56315	36RB#18	21.42	37.42
LTE Band48	15M	QPSK	56315	36RB#39	21.41	37.41
LTE Band48	15M	QPSK	56315	75RB#0	21.44	37.44
LTE Band48	15M	QPSK	56490	1RB#0	22.81	38.81
LTE Band48	15M	QPSK	56490	1RB#38	22.45	38.45
LTE Band48	15M	QPSK	56490	1RB#74	22.46	38.46
LTE Band48	15M	QPSK	56490	36RB#0	21.44	37.44
LTE Band48	15M	QPSK	56490	36RB#18	21.26	37.26
LTE Band48	15M	QPSK	56490	36RB#39	21.22	37.22
LTE Band48	15M	QPSK	56490	75RB#0	21.23	37.23
LTE Band48	15M	QPSK	56665	1RB#0	22.67	38.67
LTE Band48	15M	QPSK	56665	1RB#38	22.29	38.29
LTE Band48	15M	QPSK	56665	1RB#74	22.77	38.77
LTE Band48	15M	QPSK	56665	36RB#0	21.16	37.16
LTE Band48	15M	QPSK	56665	36RB#18	21.17	37.17
LTE Band48	15M	QPSK	56665	36RB#39	21.19	37.19
LTE Band48	15M	QPSK	56665	75RB#0	21.12	37.12
LTE Band48	15M	16QAM	56315	1RB#0	21.98	37.98
LTE Band48	15M	16QAM	56315	1RB#38	21.79	37.79
LTE Band48	15M	16QAM	56315	1RB#74	22.01	38.01
LTE Band48	15M	16QAM	56315	36RB#0	20.49	36.49
LTE Band48	15M	16QAM	56315	36RB#18	20.44	36.44
LTE Band48	15M	16QAM	56315	36RB#39	20.42	36.42
LTE Band48	15M	16QAM	56315	75RB#0	20.43	36.43
LTE Band48	15M	16QAM	56490	1RB#0	22.94	38.94
LTE Band48	15M	16QAM	56490	1RB#38	22.42	38.42
LTE Band48	15M	16QAM	56490	1RB#74	22.46	38.46
LTE Band48	15M	16QAM	56490	36RB#0	21.40	37.40
LTE Band48	15M	16QAM	56490	36RB#18	21.33	37.33
LTE Band48	15M	16QAM	56490	36RB#39	21.33	37.33
LTE Band48	15M	16QAM	56490	75RB#0	21.35	37.35
LTE Band48	15M	16QAM	56665	1RB#0	21.89	37.89
LTE Band48	15M	16QAM	56665	1RB#38	21.52	37.52
LTE Band48	15M	16QAM	56665	1RB#74	21.98	37.98
LTE Band48	15M	16QAM	56665	36RB#0	20.16	36.16
LTE Band48	15M	16QAM	56665	36RB#18	20.18	36.18
LTE Band48	15M	16QAM	56665	36RB#39	20.20	36.20
LTE Band48	15M	16QAM	56665	75RB#0	20.09	36.09



LTE Band48	15M	64QAM	56340	1RB#0	21.96	37.96
LTE Band48	15M	64QAM	56340	1RB#50	21.75	37.75
LTE Band48	15M	64QAM	56340	1RB#99	22.00	38.00
LTE Band48	15M	64QAM	56340	50RB#0	20.46	36.46
LTE Band48	15M	64QAM	56340	50RB#25	20.49	36.49
LTE Band48	15M	64QAM	56340	50RB#50	20.56	36.56
LTE Band48	15M	64QAM	56340	100RB#0	20.44	36.44
LTE Band48	15M	64QAM	56490	1RB#0	22.90	38.90
LTE Band48	15M	64QAM	56490	1RB#50	22.36	38.36
LTE Band48	15M	64QAM	56490	1RB#99	22.56	38.56
LTE Band48	15M	64QAM	56490	50RB#0	21.34	37.34
LTE Band48	15M	64QAM	56490	50RB#25	21.28	37.28
LTE Band48	15M	64QAM	56490	50RB#50	21.29	37.29
LTE Band48	15M	64QAM	56490	100RB#0	21.31	37.31
LTE Band48	15M	64QAM	56640	1RB#0	22.01	38.01
LTE Band48	15M	64QAM	56640	1RB#50	21.60	37.60
LTE Band48	15M	64QAM	56640	1RB#99	21.94	37.94
LTE Band48	15M	64QAM	56640	50RB#0	20.25	36.25
LTE Band48	15M	64QAM	56640	50RB#25	20.17	36.17
LTE Band48	15M	64QAM	56640	50RB#50	20.15	36.15
LTE Band48	15M	64QAM	56640	100RB#0	20.18	36.18
LTE Band48	20M	QPSK	56340	1RB#0	22.93	38.93
LTE Band48	20M	QPSK	56340	1RB#50	22.54	38.54
LTE Band48	20M	QPSK	56340	1RB#99	22.76	38.76
LTE Band48	20M	QPSK	56340	50RB#0	21.46	37.46
LTE Band48	20M	QPSK	56340	50RB#25	21.40	37.40
LTE Band48	20M	QPSK	56340	50RB#50	21.38	37.38
LTE Band48	20M	QPSK	56340	100RB#0	21.41	37.41
LTE Band48	20M	QPSK	56490	1RB#0	22.77	38.77
LTE Band48	20M	QPSK	56490	1RB#50	22.41	38.41
LTE Band48	20M	QPSK	56490	1RB#99	22.45	38.45
LTE Band48	20M	QPSK	56490	50RB#0	21.39	37.39
LTE Band48	20M	QPSK	56490	50RB#25	21.22	37.22
LTE Band48	20M	QPSK	56490	50RB#50	21.17	37.17
LTE Band48	20M	QPSK	56490	100RB#0	21.18	37.18
LTE Band48	20M	QPSK	56640	1RB#0	22.64	38.64
LTE Band48	20M	QPSK	56640	1RB#50	22.27	38.27
LTE Band48	20M	QPSK	56640	1RB#99	22.74	38.74
LTE Band48	20M	QPSK	56640	50RB#0	21.12	37.12
LTE Band48	20M	QPSK	56640	50RB#25	21.14	37.14
LTE Band48	20M	QPSK	56640	50RB#50	21.15	37.15
LTE Band48	20M	QPSK	56640	100RB#0	21.08	37.08
LTE Band48	20M	16QAM	56340	1RB#0	21.96	37.96



LTE Band48	20M	16QAM	56340	1RB#50	21.75	37.75
LTE Band48	20M	16QAM	56340	1RB#99	21.99	37.99
LTE Band48	20M	16QAM	56340	50RB#0	20.46	36.46
LTE Band48	20M	16QAM	56340	50RB#25	20.41	36.41
LTE Band48	20M	16QAM	56340	50RB#50	20.39	36.39
LTE Band48	20M	16QAM	56340	100RB#0	20.41	36.41
LTE Band48	20M	16QAM	56490	1RB#0	22.90	38.90
LTE Band48	20M	16QAM	56490	1RB#50	22.40	38.40
LTE Band48	20M	16QAM	56490	1RB#99	22.43	38.43
LTE Band48	20M	16QAM	56490	50RB#0	21.36	37.36
LTE Band48	20M	16QAM	56490	50RB#25	21.31	37.31
LTE Band48	20M	16QAM	56490	50RB#50	21.28	37.28
LTE Band48	20M	16QAM	56490	100RB#0	21.31	37.31
LTE Band48	20M	16QAM	56640	1RB#0	21.84	37.84
LTE Band48	20M	16QAM	56640	1RB#50	21.48	37.48
LTE Band48	20M	16QAM	56640	1RB#99	21.96	37.96
LTE Band48	20M	16QAM	56640	50RB#0	20.13	36.13
LTE Band48	20M	16QAM	56640	50RB#25	20.15	36.15
LTE Band48	20M	16QAM	56640	50RB#50	20.16	36.16
LTE Band48	20M	16QAM	56640	100RB#0	20.06	36.06
LTE Band48	20M	64QAM	56340	1RB#0	21.94	37.94
LTE Band48	20M	64QAM	56340	1RB#50	21.71	37.71
LTE Band48	20M	64QAM	56340	1RB#99	21.98	37.98
LTE Band48	20M	64QAM	56340	50RB#0	20.43	36.43
LTE Band48	20M	64QAM	56340	50RB#25	20.46	36.46
LTE Band48	20M	64QAM	56340	50RB#50	20.53	36.53
LTE Band48	20M	64QAM	56340	100RB#0	20.42	36.42
LTE Band48	20M	64QAM	56490	1RB#0	22.86	38.86
LTE Band48	20M	64QAM	56490	1RB#50	22.34	38.34
LTE Band48	20M	64QAM	56490	1RB#99	22.53	38.53
LTE Band48	20M	64QAM	56490	50RB#0	21.30	37.30
LTE Band48	20M	64QAM	56490	50RB#25	21.26	37.26
LTE Band48	20M	64QAM	56490	50RB#50	21.24	37.24
LTE Band48	20M	64QAM	56490	100RB#0	21.27	37.27
LTE Band48	20M	64QAM	56640	1RB#0	21.96	37.96
LTE Band48	20M	64QAM	56640	1RB#50	21.56	37.56
LTE Band48	20M	64QAM	56640	1RB#99	21.92	37.92
LTE Band48	20M	64QAM	56640	50RB#0	20.22	36.22
LTE Band48	20M	64QAM	56640	50RB#25	20.14	36.14
LTE Band48	20M	64QAM	56640	50RB#50	20.11	36.11
LTE Band48	20M	64QAM	56640	100RB#0	20.15	36.15

Note: EIRP = A (Average output power) + G(Antenna Gain=16dBi)

5.2. Maximum Effective Isotropic Radiated Power and Maximum Power Spectral Density

Ambient condition

Temperature	Relative humidity	Pressure
23°C ~25°C	45%~50%	101.5kPa

Methods of Measurement

The EUT was connected to Spectrum Analyzer and Base Station Simulator via power Splitter. The EIRP and Power Spectral Density of the low, middle and high channels were measured.

Test setup

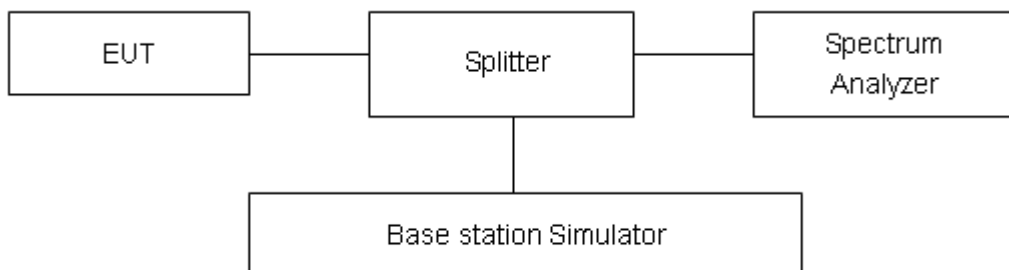

Limits

Unless otherwise specified in this section, the maximum effective isotropic radiated power (EIRP) and maximum Power Spectral Density (PSD) of and End User Device must comply with the limits shown in following table:

Rule Part 96.41(b) specifies that

Unless otherwise specified in this section, the maximum effective isotropic radiated power (EIRP) and maximum Power Spectral Density (PSD) of any CBSD and End User Device must comply with the limits shown in following table:

Rule Part 96.41(b) specifies that

Device	Maximum EIRP (dBm/10MHz)	Maximum PSD (dBm/MHz)
End User Device	23	N/A
Category B CBSD ¹	47	37

NOTE: Category B CBSDs will only be authorized for use after an ESC is approved and commercially deployed consistent with §§96.15 and 96.67.

Measurement Uncertainty

The assessed measurement uncertainty to ensure 95% confidence level for the normal distribution is with the coverage factor $k = 2$, $U = 1.19$ dB

**Test Results:**

The measurement is performed for both of horizontal and vertical antenna Polarization, and only the data of worst mode is recorded in this report.

Maximum Effective Isotropic Radiated Power

BAND	Bandwidth	Modulation	Channel	RB Configuration	Conducted Power (dBm/10MHz)	EIRP (dBm/10MHz)	Limit (dBm/10MHz)
Band48	5M	QPSK	56265	1RB#0	23.02	39.02	47
Band48	5M	QPSK	56490	1RB#0	22.98	38.98	47
Band48	5M	QPSK	56715	1RB#0	22.75	38.75	47
Band48	5M	16QAM	56265	1RB#0	22.06	38.06	47
Band48	5M	16QAM	56490	1RB#0	22.99	38.99	47
Band48	5M	16QAM	56715	1RB#0	21.96	37.96	47
Band48	5M	64QAM	56340	1RB#0	22.04	38.04	47
Band48	5M	64QAM	56490	1RB#0	22.95	38.95	47
Band48	5M	64QAM	56640	1RB#0	22.08	38.08	47
Band48	10M	QPSK	56290	1RB#0	22.97	38.97	47
Band48	10M	QPSK	56490	1RB#0	22.85	38.85	47
Band48	10M	QPSK	56690	1RB#0	22.69	38.69	47
Band48	10M	16QAM	56290	1RB#0	22.03	38.03	47
Band48	10M	16QAM	56490	1RB#0	22.96	38.96	47
Band48	10M	16QAM	56690	1RB#0	21.91	37.91	47
Band48	10M	64QAM	56340	1RB#0	22.01	38.01	47
Band48	10M	64QAM	56490	1RB#0	22.92	38.92	47
Band48	10M	64QAM	56640	1RB#0	22.03	38.03	47
Band48	15M	QPSK	56315	1RB#0	22.96	38.96	47
Band48	15M	QPSK	56490	1RB#0	22.81	38.81	47
Band48	15M	QPSK	56665	1RB#0	22.67	38.67	47
Band48	15M	16QAM	56315	1RB#0	21.98	37.98	47
Band48	15M	16QAM	56490	1RB#0	22.94	38.94	47
Band48	15M	16QAM	56665	1RB#0	21.89	37.89	47
Band48	15M	64QAM	56340	1RB#0	21.96	37.96	47
Band48	15M	64QAM	56490	1RB#0	22.90	38.9	47
Band48	15M	64QAM	56640	1RB#0	22.01	38.01	47
Band48	20M	QPSK	56340	1RB#0	22.93	38.93	47
Band48	20M	QPSK	56490	1RB#0	22.77	38.77	47
Band48	20M	QPSK	56640	1RB#0	22.64	38.64	47
Band48	20M	16QAM	56340	1RB#0	21.96	37.96	47
Band48	20M	16QAM	56490	1RB#0	22.90	38.9	47
Band48	20M	16QAM	56640	1RB#0	21.84	37.84	47
Band48	20M	64QAM	56340	1RB#0	21.94	37.94	47
Band48	20M	64QAM	56490	1RB#0	22.86	38.86	47



Band48	20M	64QAM	56640	1RB#0	21.96	37.96	47
--------	-----	-------	-------	-------	-------	-------	----

Maximum Power Spectral Density

BAND	Bandwidth	Modulation	Channel	RB Configuration	Maximum Conducted PSD (dBm/MHz)	Maximum PSD (dBm/MHz)	Limit (dBm/MHz)
Band48	5M	QPSK	56265	1RB#0	14.72	30.72	37
Band48	5M	QPSK	56490	1RB#0	15.65	31.65	37
Band48	5M	QPSK	56715	1RB#0	14.94	30.94	37
Band48	5M	16QAM	56265	1RB#0	14.82	30.82	37
Band48	5M	16QAM	56490	1RB#0	14.47	30.47	37
Band48	5M	16QAM	56715	1RB#0	12.91	28.91	37
Band48	5M	64QAM	56340	1RB#0	15.21	31.21	37
Band48	5M	64QAM	56490	1RB#0	14.40	30.40	37
Band48	5M	64QAM	56640	1RB#0	13.23	29.23	37
Band48	10M	QPSK	56290	1RB#0	12.87	28.87	37
Band48	10M	QPSK	56490	1RB#0	13.36	29.36	37
Band48	10M	QPSK	56690	1RB#0	11.34	27.34	37
Band48	10M	16QAM	56290	1RB#0	11.65	27.65	37
Band48	10M	16QAM	56490	1RB#0	12.23	28.23	37
Band48	10M	16QAM	56690	1RB#0	10.14	26.14	37
Band48	10M	64QAM	56340	1RB#0	11.79	27.79	37
Band48	10M	64QAM	56490	1RB#0	12.42	28.42	37
Band48	10M	64QAM	56640	1RB#0	10.31	26.31	37
Band48	15M	QPSK	56315	1RB#0	11.04	27.04	37
Band48	15M	QPSK	56490	1RB#0	11.76	27.76	37
Band48	15M	QPSK	56665	1RB#0	9.28	25.28	37
Band48	15M	16QAM	56315	1RB#0	9.72	25.72	37
Band48	15M	16QAM	56490	1RB#0	10.56	26.56	37
Band48	15M	16QAM	56665	1RB#0	8.42	24.42	37
Band48	15M	64QAM	56340	1RB#0	9.17	25.17	37
Band48	15M	64QAM	56490	1RB#0	10.59	26.59	37
Band48	15M	64QAM	56640	1RB#0	8.30	24.30	37
Band48	20M	QPSK	56340	1RB#0	10.08	26.08	37
Band48	20M	QPSK	56490	1RB#0	10.09	26.09	37
Band48	20M	QPSK	56640	1RB#0	8.19	24.19	37
Band48	20M	16QAM	56340	1RB#0	9.28	25.28	37
Band48	20M	16QAM	56490	1RB#0	9.30	25.30	37
Band48	20M	16QAM	56640	1RB#0	7.50	23.50	37
Band48	20M	64QAM	56340	1RB#0	8.33	24.33	37
Band48	20M	64QAM	56490	1RB#0	9.80	25.80	37
Band48	20M	64QAM	56640	1RB#0	7.69	23.69	37



Note: Maximum PSD (dBm/MHz) = Maximum Conducted PSD(dBm/MHz) + (Antenna Gain=16dBi)



Maximum PSD (dBm/10MHz)

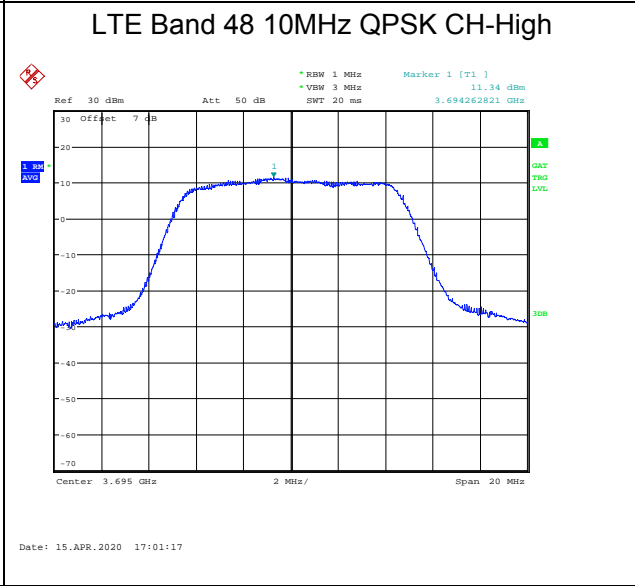
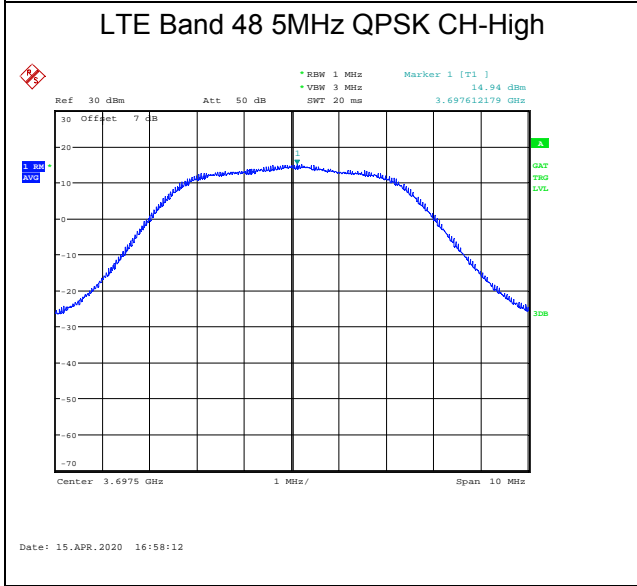
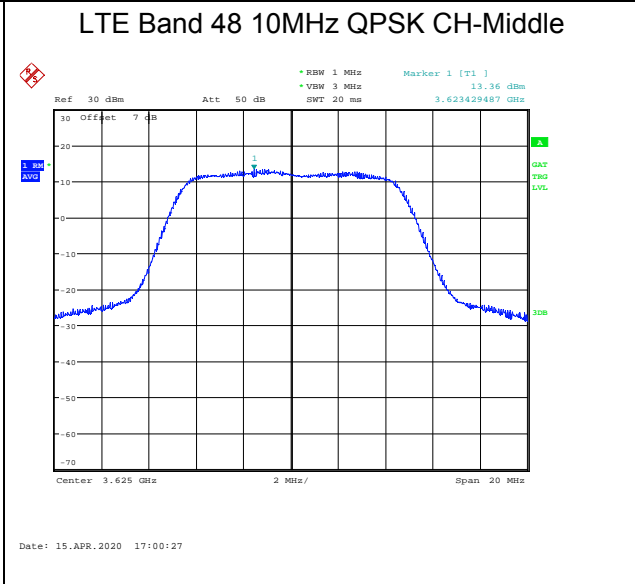
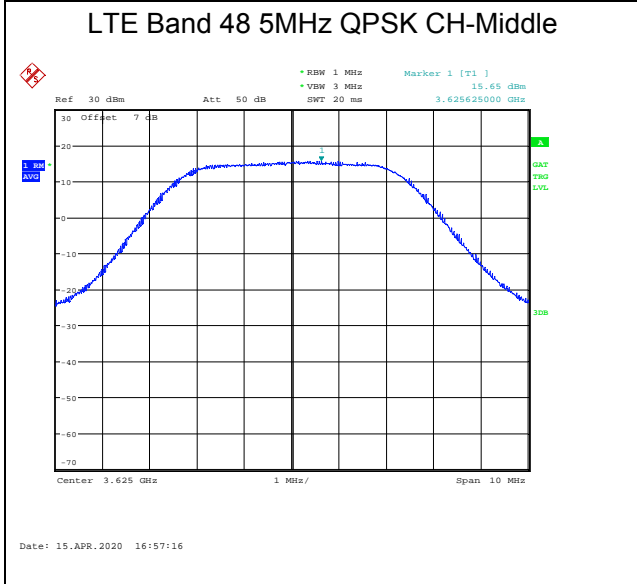
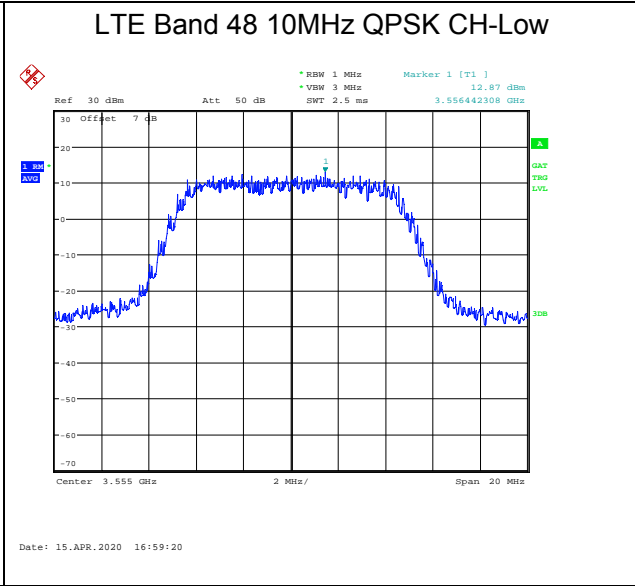
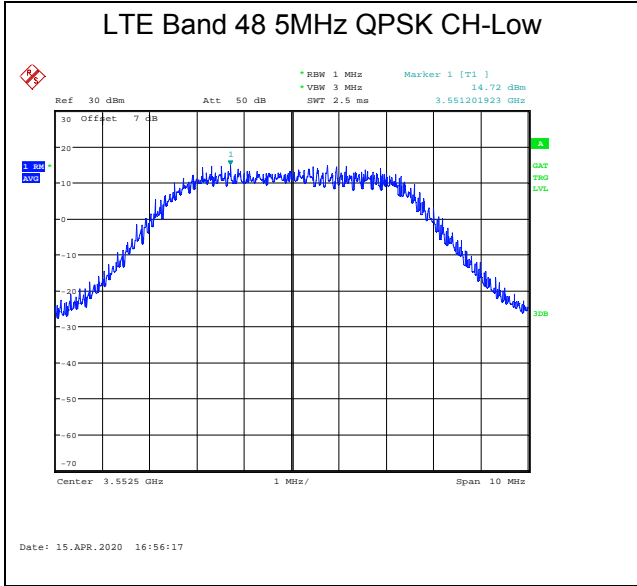



LTE Band 48 15MHz QPSK CH-Low

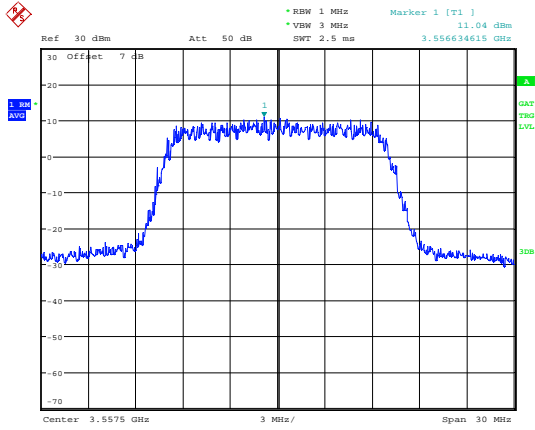

Date: 15.APR.2020 17:02:16

LTE Band 48 20MHz QPSK CH-Low

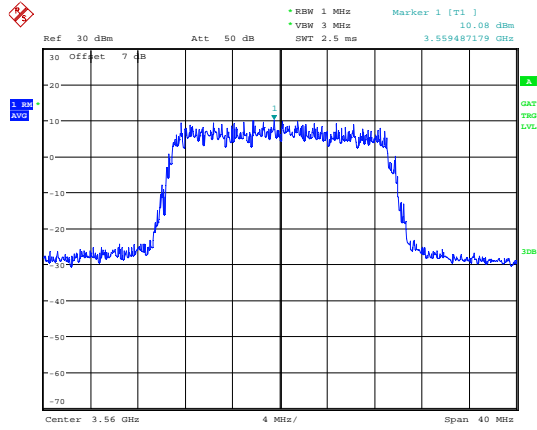

Date: 15.APR.2020 17:04:54

LTE Band 48 15MHz QPSK CH-Middle

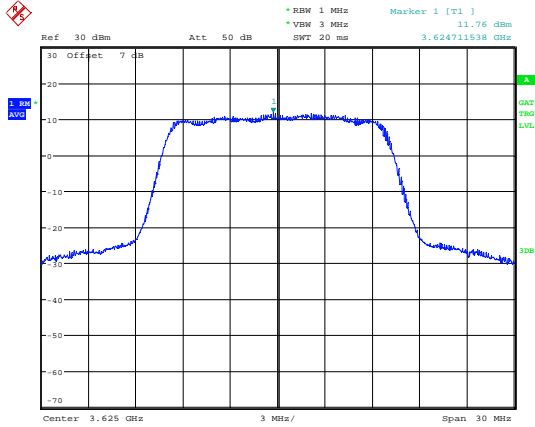

Date: 15.APR.2020 17:02:59

LTE Band 48 20MHz QPSK CH-Middle

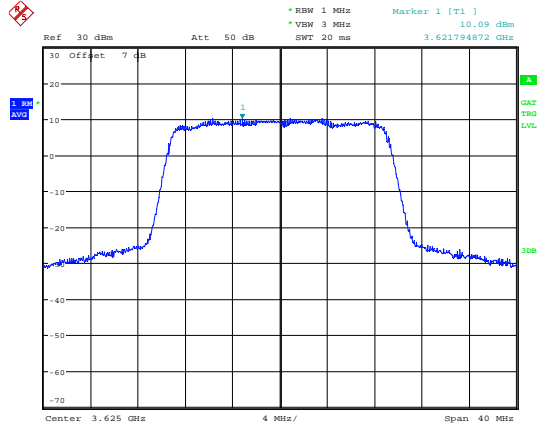

Date: 15.APR.2020 17:05:44

LTE Band 48 15MHz QPSK CH-High

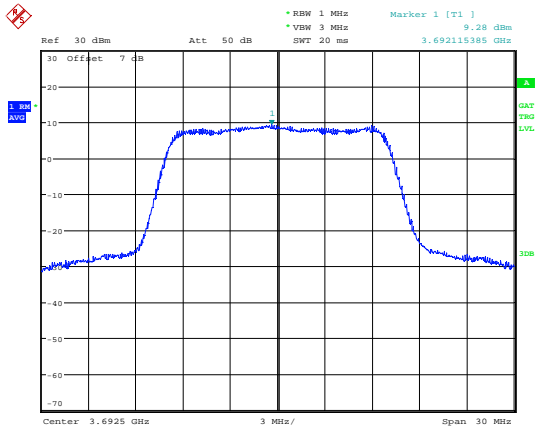

Date: 15.APR.2020 17:03:51

LTE Band 48 20MHz QPSK CH-High

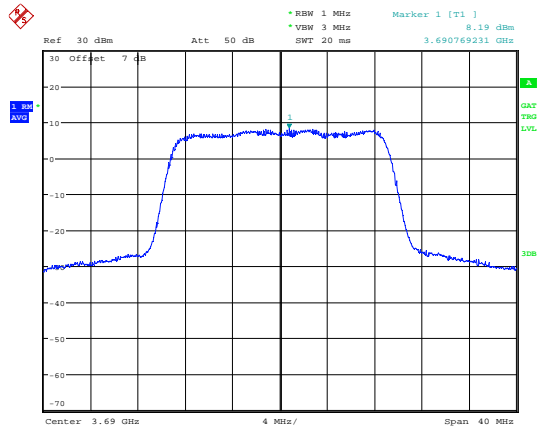

Date: 15.APR.2020 17:06:51

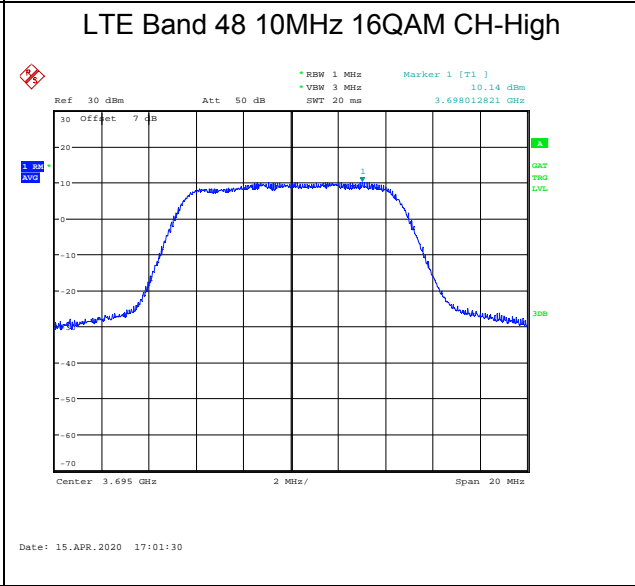
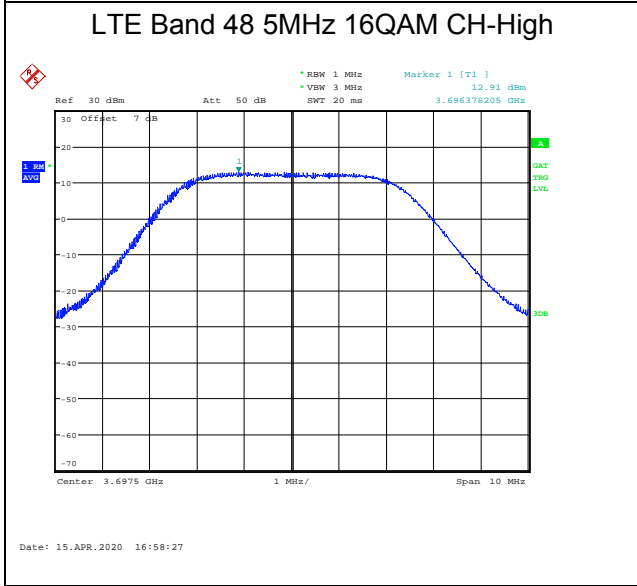
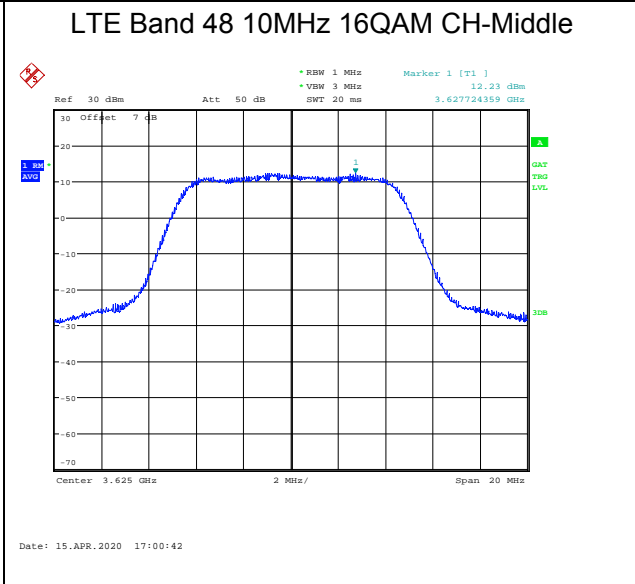
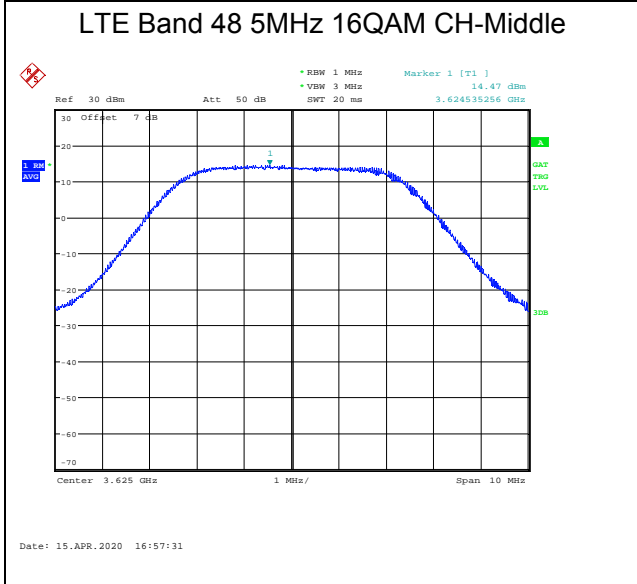
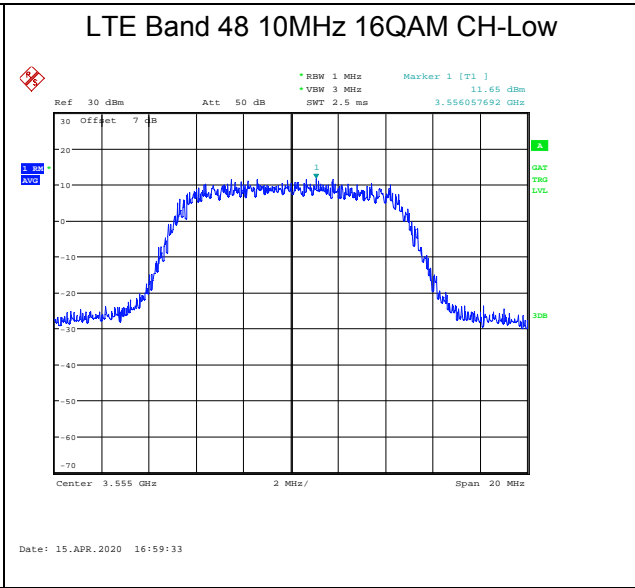
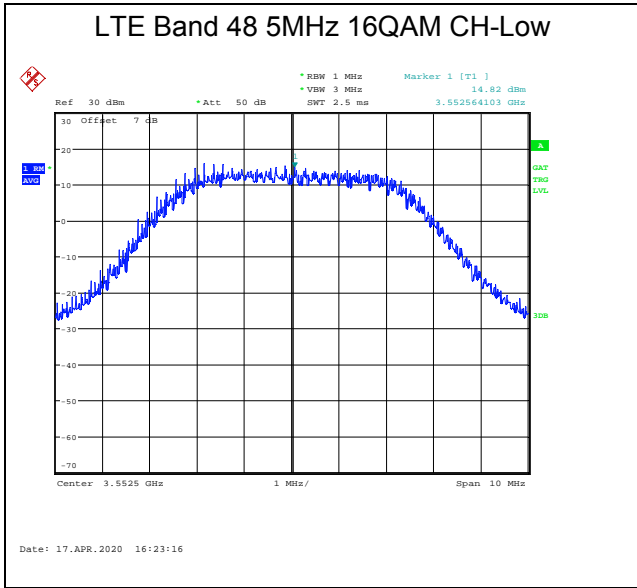



LTE Band 48 15MHz 16QAM CH-Low

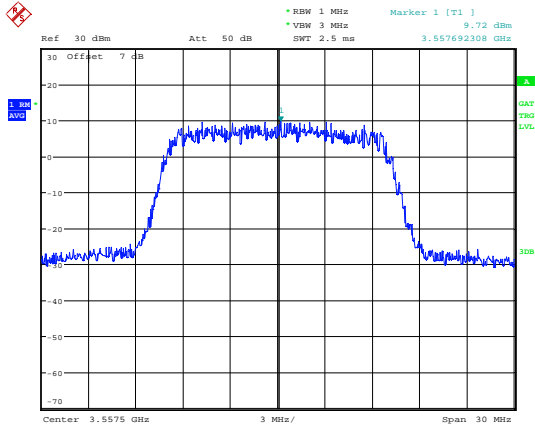

Date: 15.APR.2020 17:02:29

LTE Band 48 20MHz 16QAM CH-Low

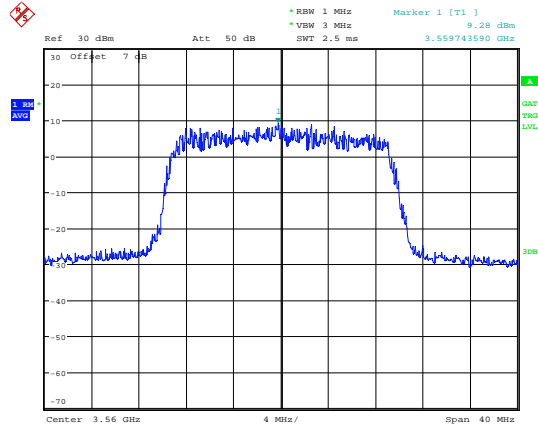

Date: 15.APR.2020 17:05:12

LTE Band 48 15MHz 16QAM CH-Middle

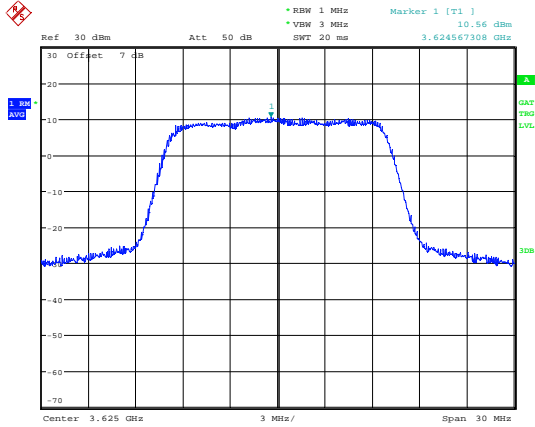

Date: 15.APR.2020 17:03:13

LTE Band 48 20MHz 16QAM CH-Middle

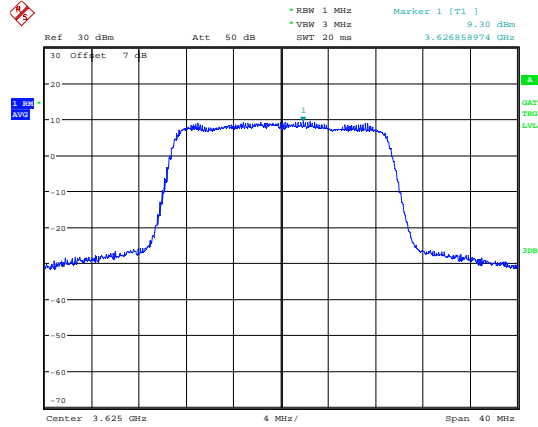

Date: 15.APR.2020 17:06:02

LTE Band 48 15MHz 16QAM CH-High

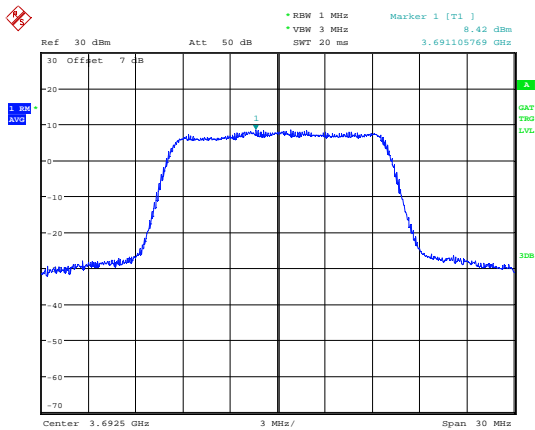

Date: 15.APR.2020 17:04:07

LTE Band 48 20MHz 16QAM CH-High

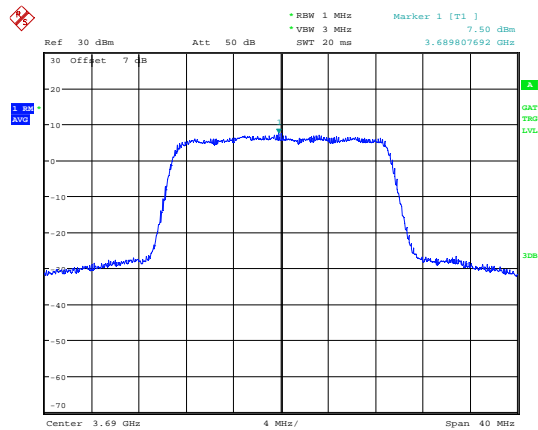

Date: 15.APR.2020 17:07:22



LTE Band 48 5MHz 64QAM CH-Low

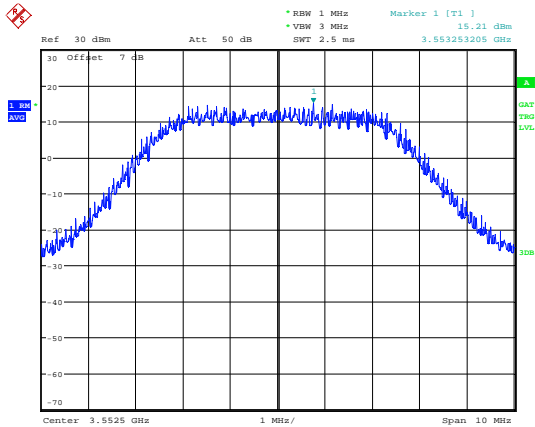

Date: 15.APR.2020 16:56:49

LTE Band 48 10MHz 64QAM CH-Low

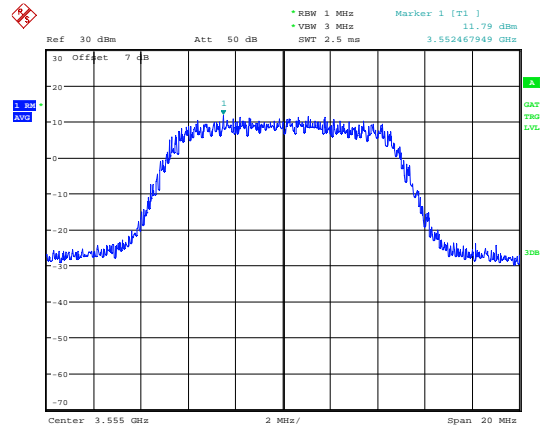

Date: 15.APR.2020 16:59:46

LTE Band 48 5MHz 64QAM CH-Middle

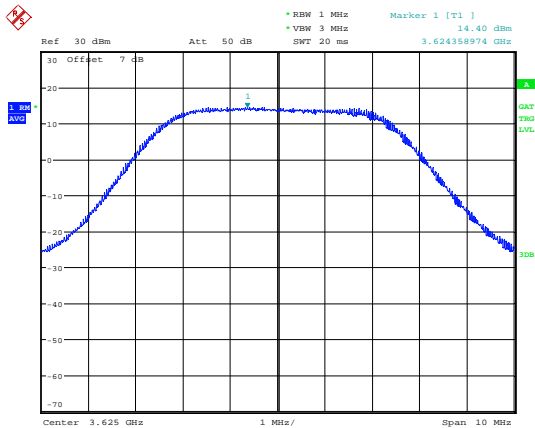

Date: 15.APR.2020 16:57:46

LTE Band 48 10MHz 64QAM CH-Middle

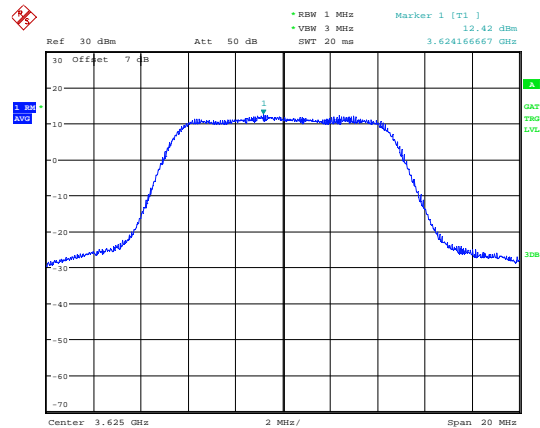

Date: 15.APR.2020 17:00:54

LTE Band 48 5MHz 64QAM CH-High

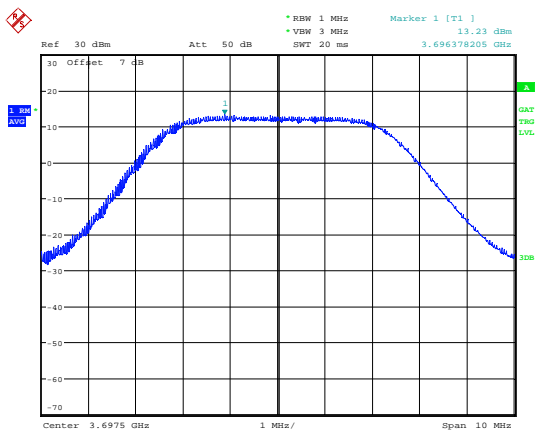

Date: 15.APR.2020 16:58:39

LTE Band 48 10MHz 64QAM CH-High

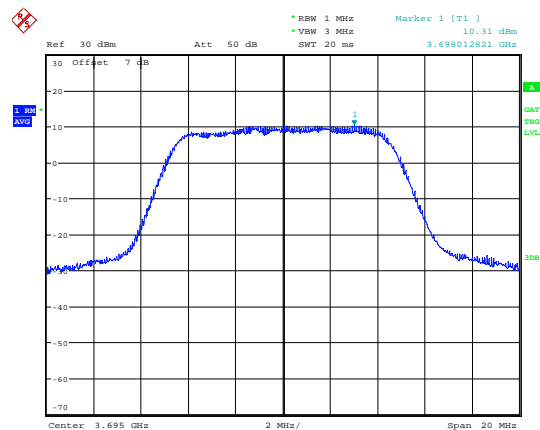

Date: 15.APR.2020 17:01:40

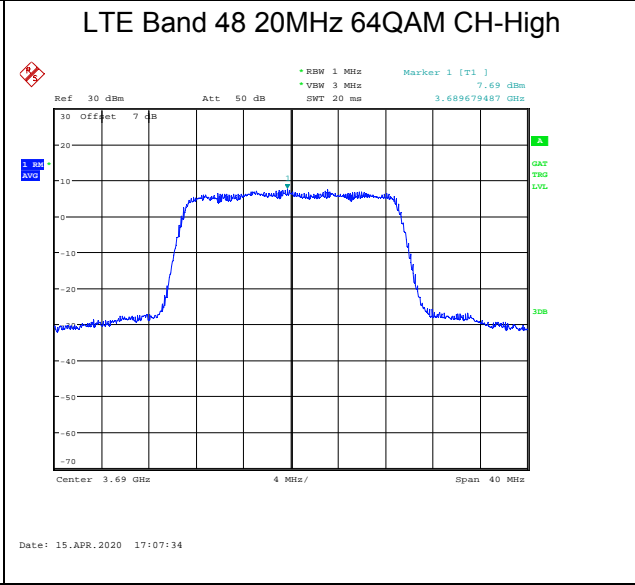
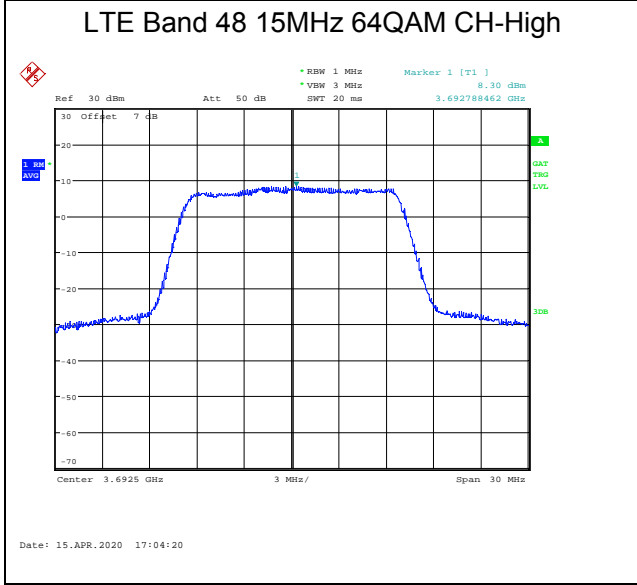
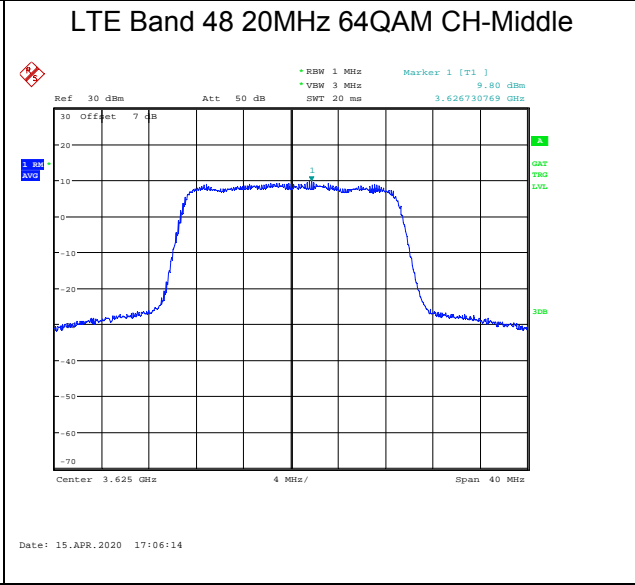
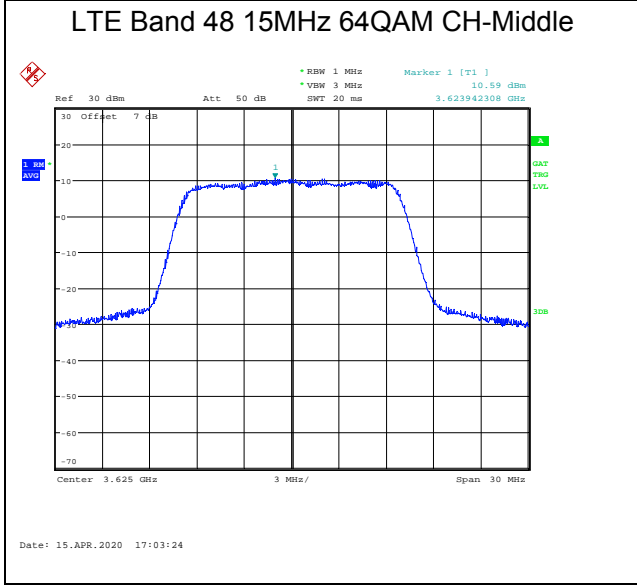
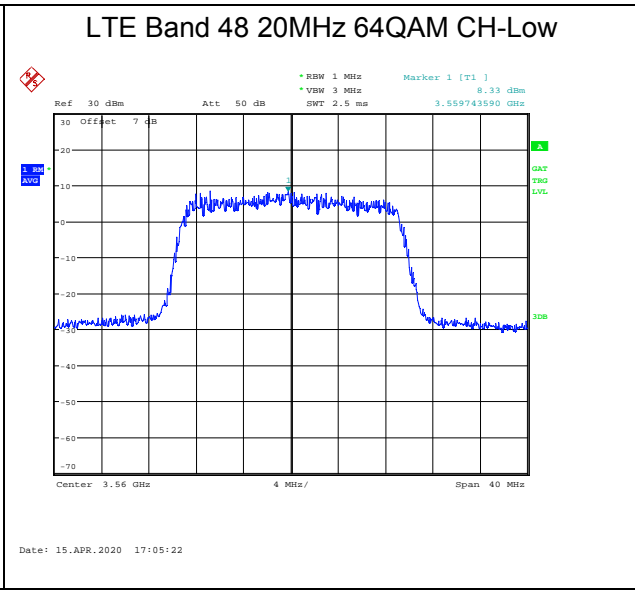
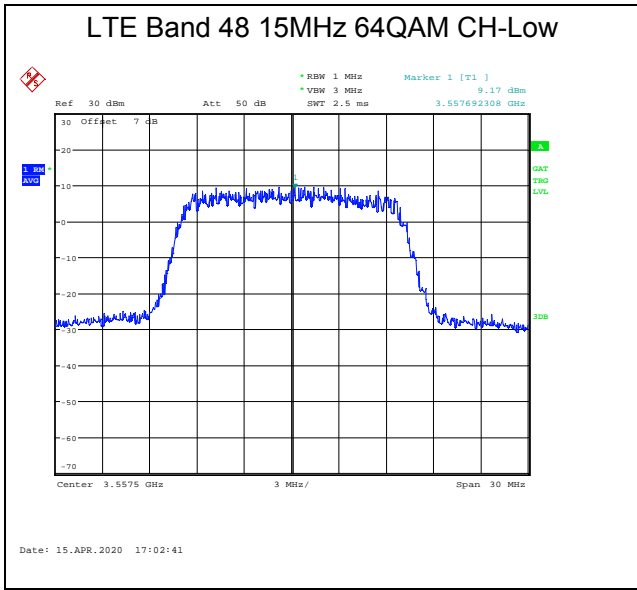



Maximum PSD (dBm/MHz)

LTE Band 48 5MHz QPSK CH-Low

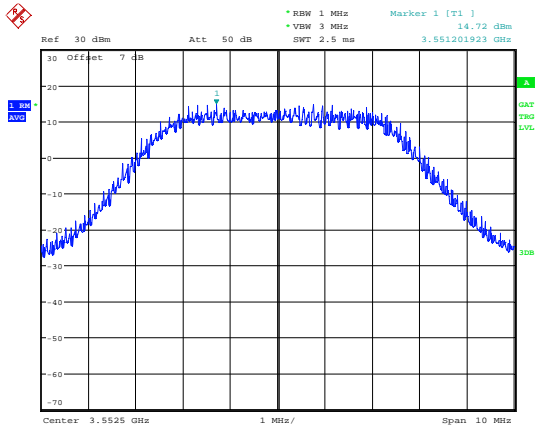

Date: 15.APR.2020 16:56:17

LTE Band 48 10MHz QPSK CH-Low

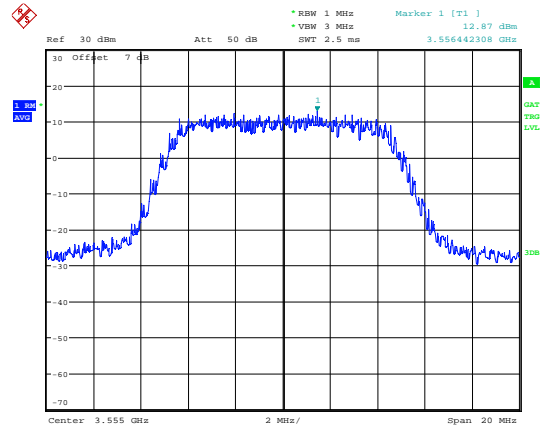

Date: 15.APR.2020 16:59:20

LTE Band 48 5MHz QPSK CH-Middle

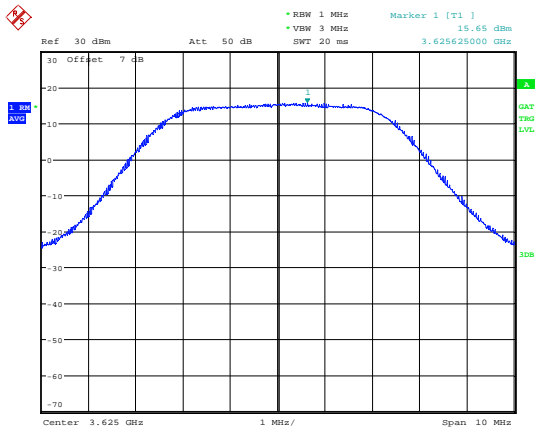

Date: 15.APR.2020 16:57:16

LTE Band 48 10MHz QPSK CH-Middle

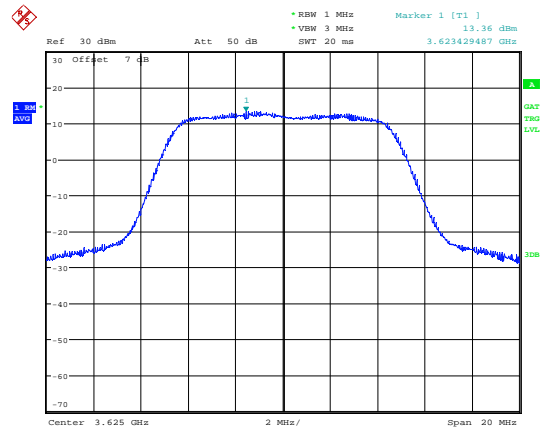

Date: 15.APR.2020 17:00:27

LTE Band 48 5MHz QPSK CH-High

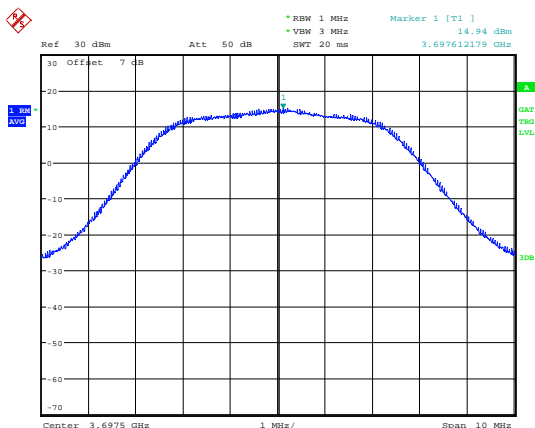

Date: 15.APR.2020 16:58:12

LTE Band 48 10MHz QPSK CH-High

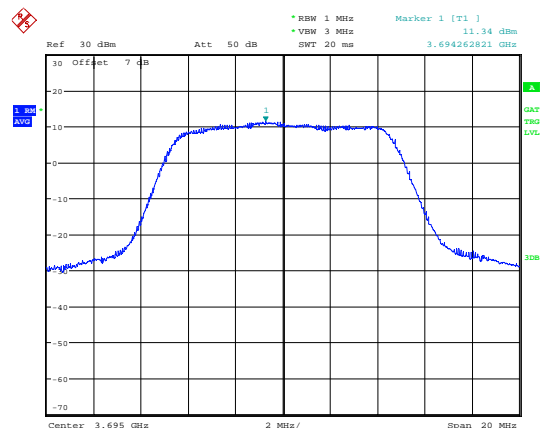

Date: 15.APR.2020 17:01:17



LTE Band 48 15MHz QPSK CH-Low

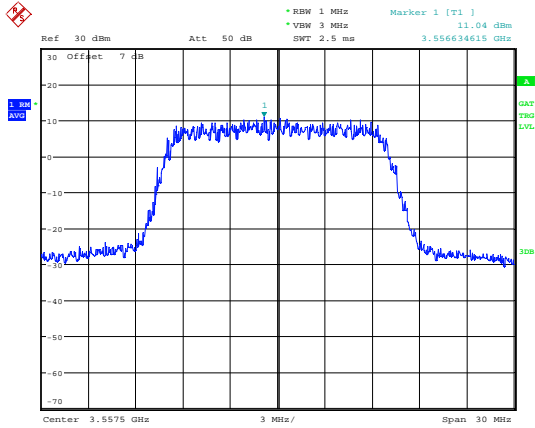

Date: 15.APR.2020 17:02:16

LTE Band 48 20MHz QPSK CH-Low

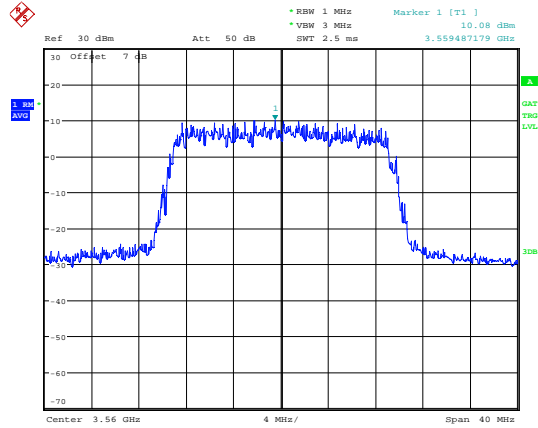

Date: 15.APR.2020 17:04:54

LTE Band 48 15MHz QPSK CH-Middle

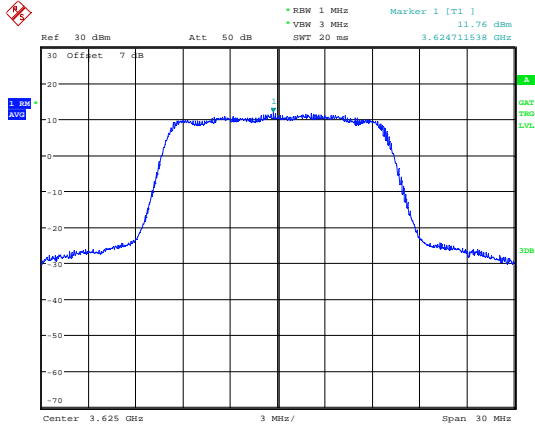

Date: 15.APR.2020 17:02:59

LTE Band 48 20MHz QPSK CH-Middle

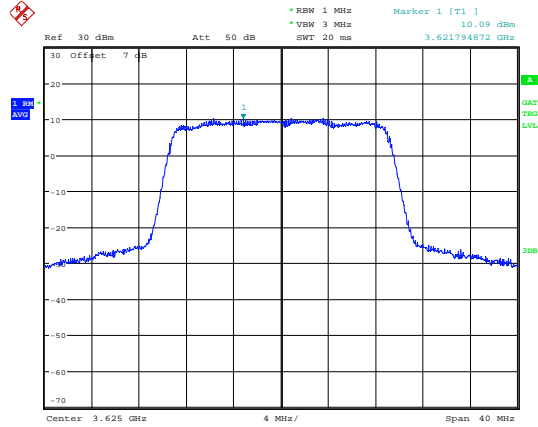

Date: 15.APR.2020 17:05:44

LTE Band 48 15MHz QPSK CH-High

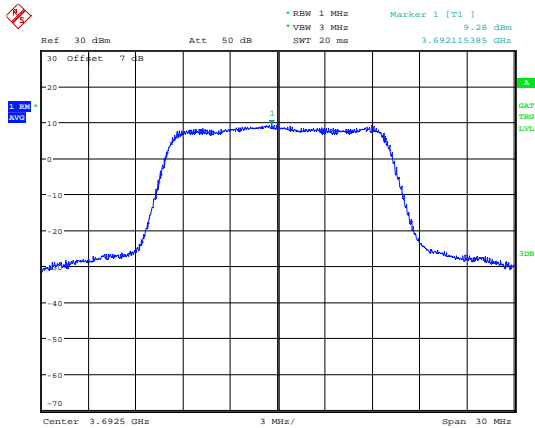

Date: 15.APR.2020 17:03:51

LTE Band 48 20MHz QPSK CH-High

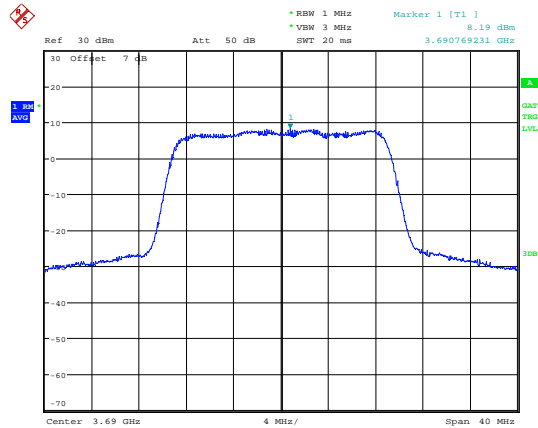

Date: 15.APR.2020 17:06:51

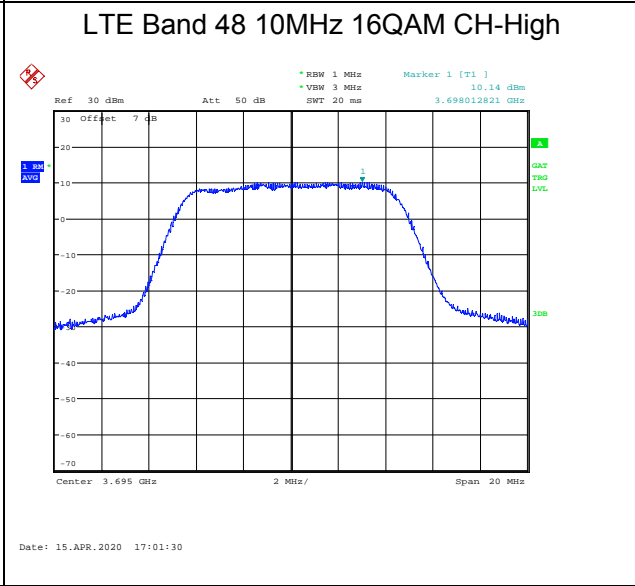
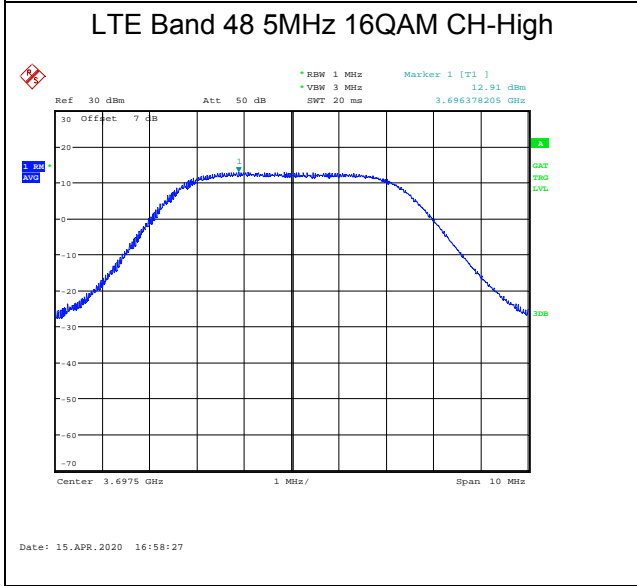
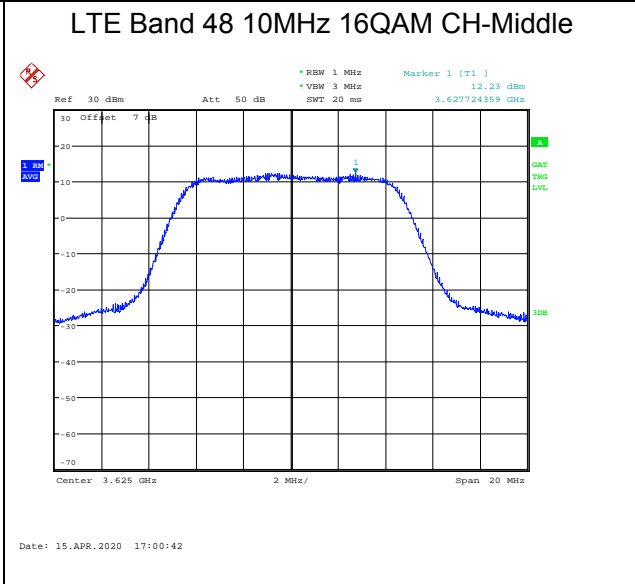
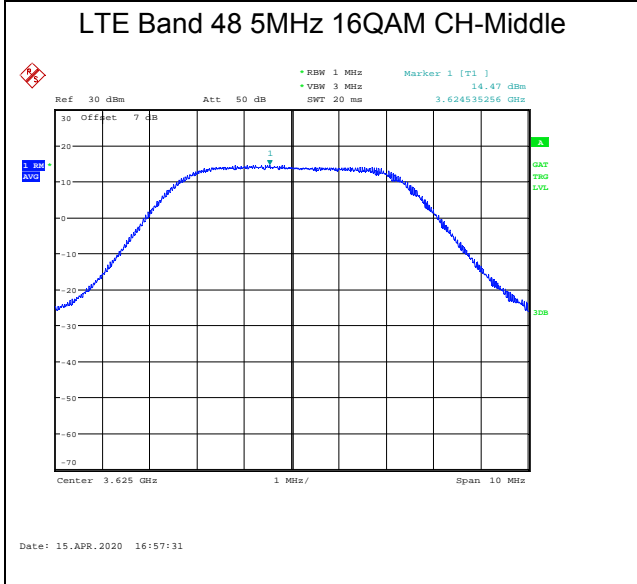
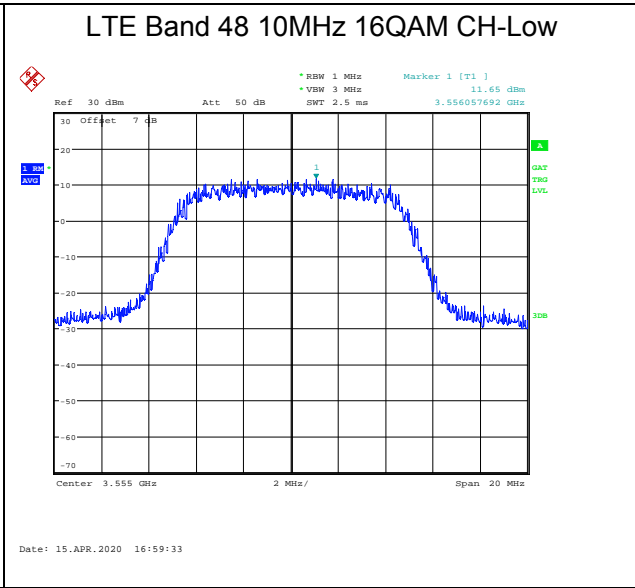
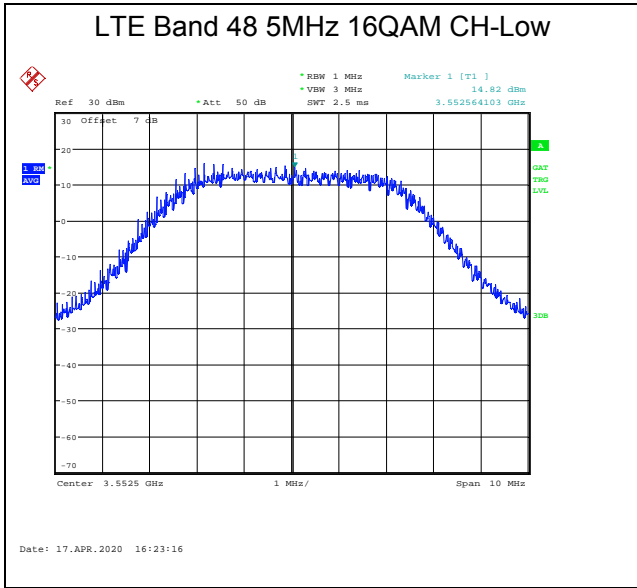



LTE Band 48 15MHz 16QAM CH-Low

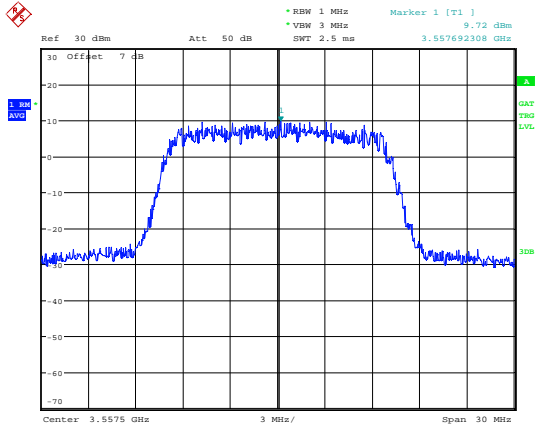

Date: 15.APR.2020 17:02:29

LTE Band 48 20MHz 16QAM CH-Low

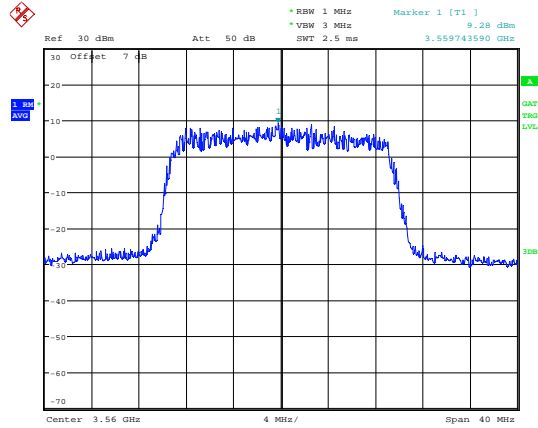

Date: 15.APR.2020 17:05:12

LTE Band 48 15MHz 16QAM CH-Middle

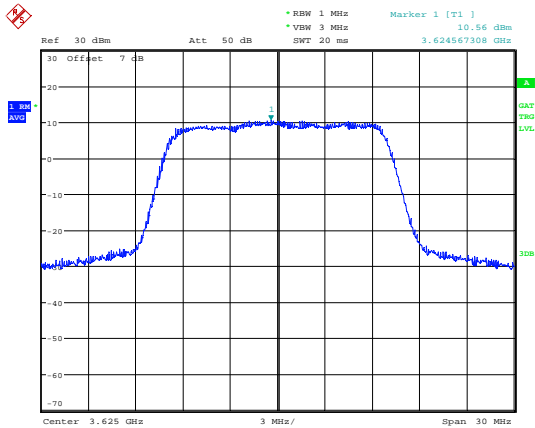

Date: 15.APR.2020 17:03:13

LTE Band 48 20MHz 16QAM CH-Middle

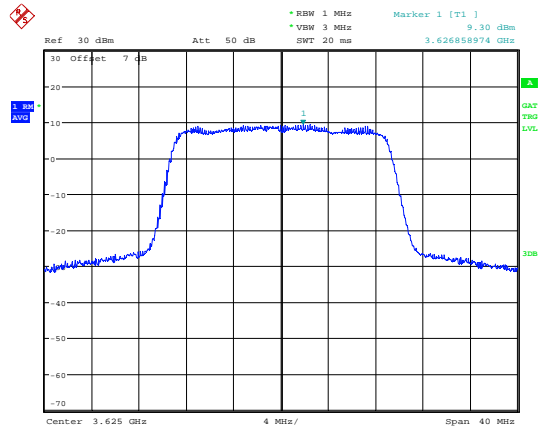

Date: 15.APR.2020 17:06:02

LTE Band 48 15MHz 16QAM CH-High

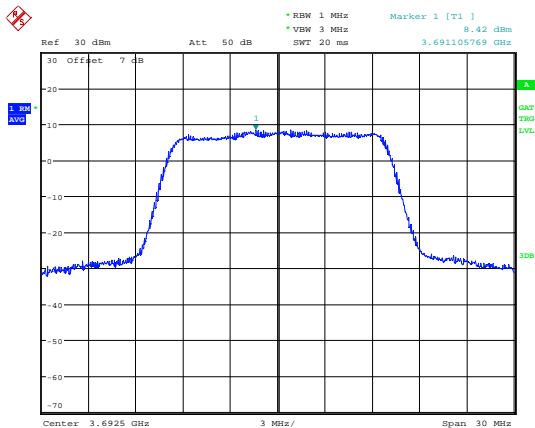

Date: 15.APR.2020 17:04:07

LTE Band 48 20MHz 16QAM CH-High

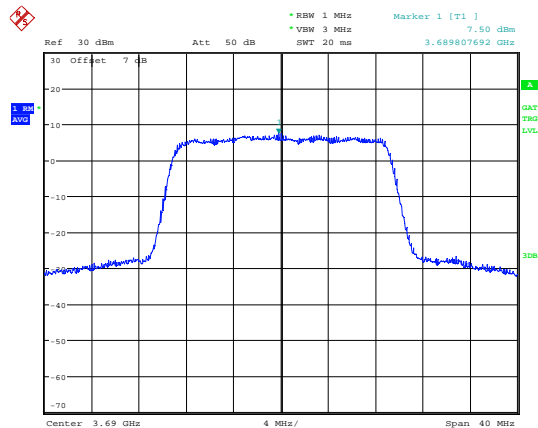

Date: 15.APR.2020 17:07:22



LTE Band 48 5MHz 64QAM CH-Low

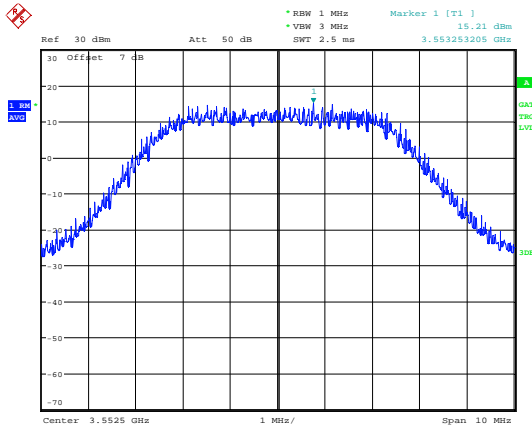

Date: 15.APR.2020 16:56:49

LTE Band 48 10MHz 64QAM CH-Low

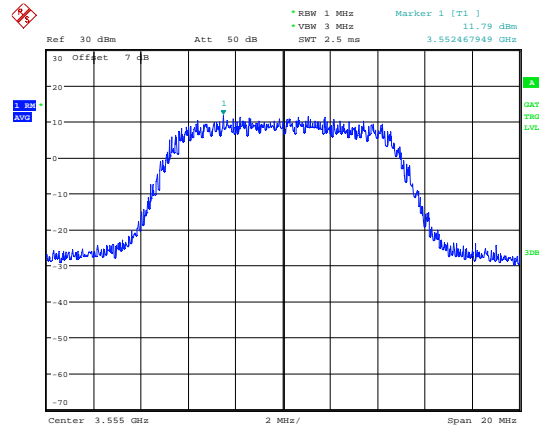

Date: 15.APR.2020 16:59:46

LTE Band 48 5MHz 64QAM CH-Middle

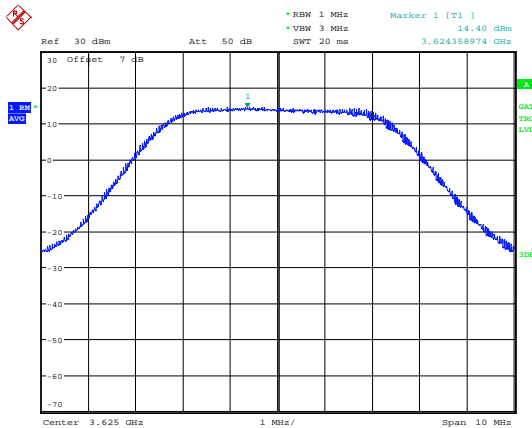

Date: 15.APR.2020 16:57:46

LTE Band 48 10MHz 64QAM CH-Middle

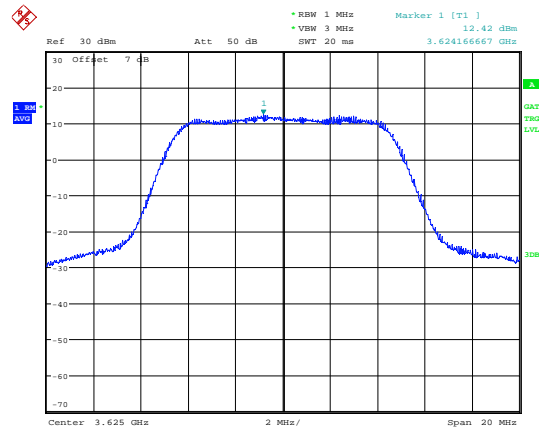

Date: 15.APR.2020 17:00:54

LTE Band 48 5MHz 64QAM CH-High

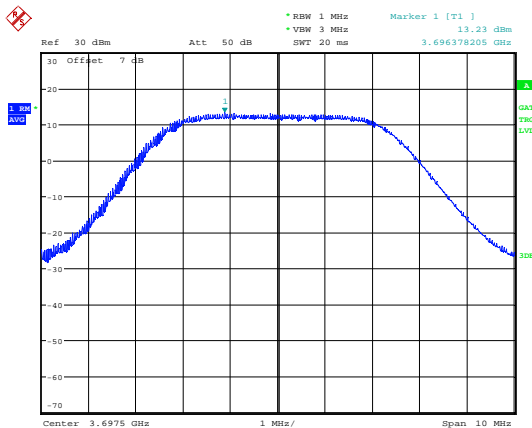

Date: 15.APR.2020 16:58:39

LTE Band 48 10MHz 64QAM CH-High

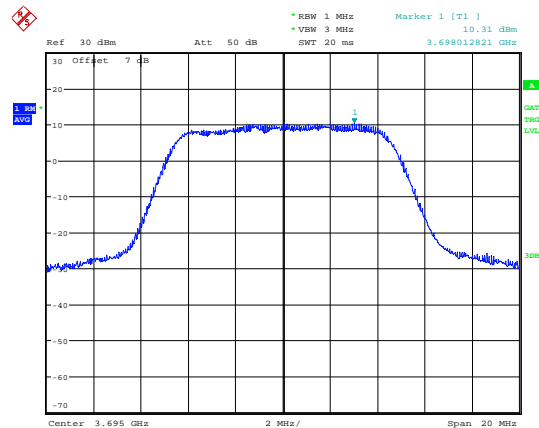

Date: 15.APR.2020 17:01:40



LTE Band 48 15MHz 64QAM CH-Low

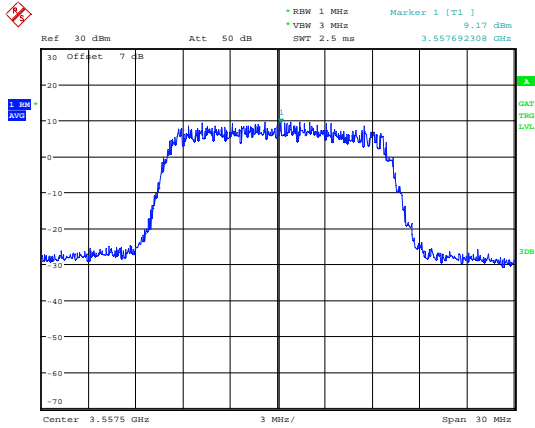

Date: 15.APR.2020 17:02:41

LTE Band 48 20MHz 64QAM CH-Low

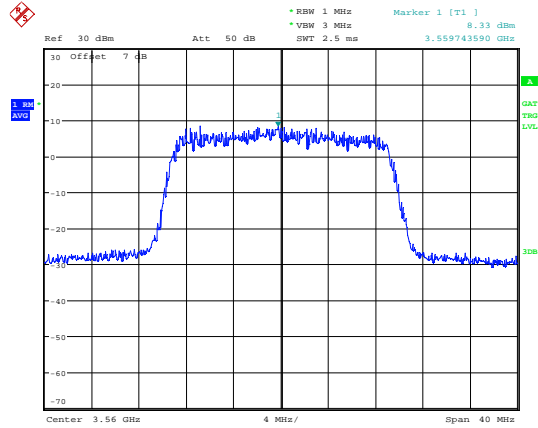

Date: 15.APR.2020 17:05:22

LTE Band 48 15MHz 64QAM CH-Middle

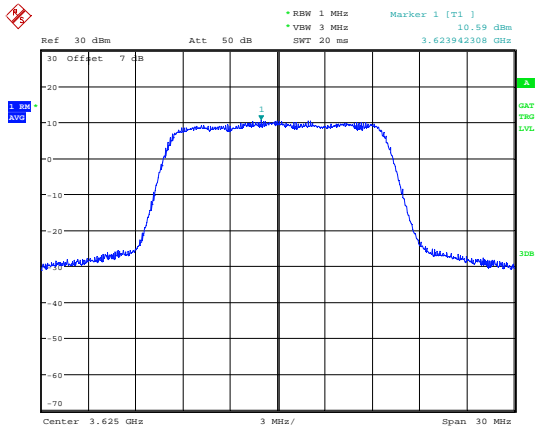

Date: 15.APR.2020 17:03:24

LTE Band 48 20MHz 64QAM CH-Middle

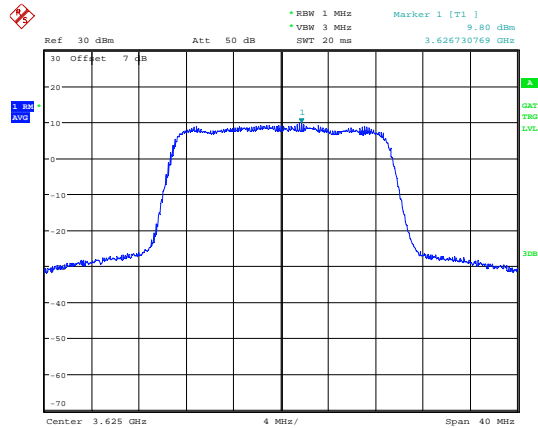

Date: 15.APR.2020 17:06:14

LTE Band 48 15MHz 64QAM CH-High

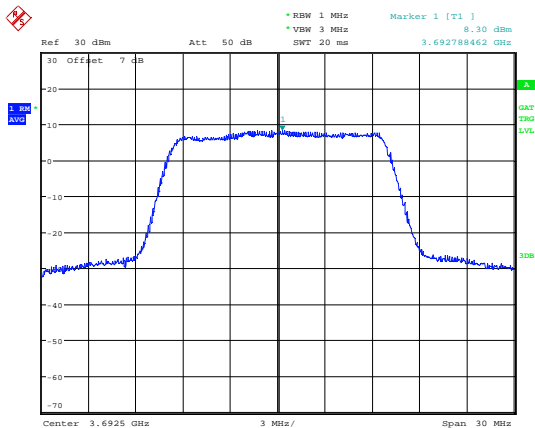

Date: 15.APR.2020 17:04:20

LTE Band 48 20MHz 64QAM CH-High

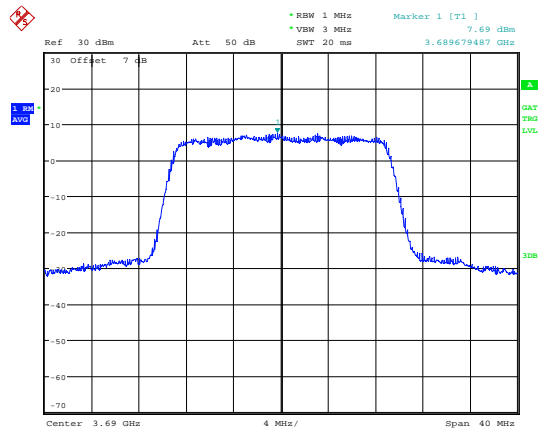

Date: 15.APR.2020 17:07:34

5.3. Occupied Bandwidth

Ambient condition

Temperature	Relative humidity	Pressure
23°C ~25°C	45%~50%	101.5kPa

Method of Measurement

The occupied bandwidth is the width of a frequency band such that, below the lower and above the upper frequency limits, the mean powers emitted are each equal to a specified percentage 0.5% of the total mean transmitted power.

The testing follows FCC KDB 971168 D01 v03r01 Section 4.2

1. The EUT was connected to spectrum analyzer and system simulator via a power divider.
2. The spectrum analyzer center frequency is set to the nominal EUT channel center frequency. The span range for the spectrum analyzer shall be between two and five times the anticipated OBW.
3. The nominal resolution bandwidth (RBW) shall be in the range of 1 to 5 % of the anticipated OBW, and the VBW shall be at least 3 times the RBW.
4. Set the detection mode to peak, and the trace mode to max hold.
5. Determine the reference value: Set the EUT to transmit a modulated signal. Allow the trace to stabilize. Set the spectrum analyzer marker to the highest level of the displayed trace. (this is the reference value)
6. Determine the “-26 dB down amplitude” as equal to (Reference Value – X).
7. Place two markers, one at the lowest and the other at the highest frequency of the envelope of the spectral display such that each marker is at or slightly below the “-X dB down amplitude” determined in step 6. If a marker is below this “-X dB down amplitude” value it shall be placed as close as possible to this value. The OBW is the positive frequency difference between the two markers.
8. Use the 99 % power bandwidth function of the spectrum analyzer and report the measured bandwidth.

Test Setup

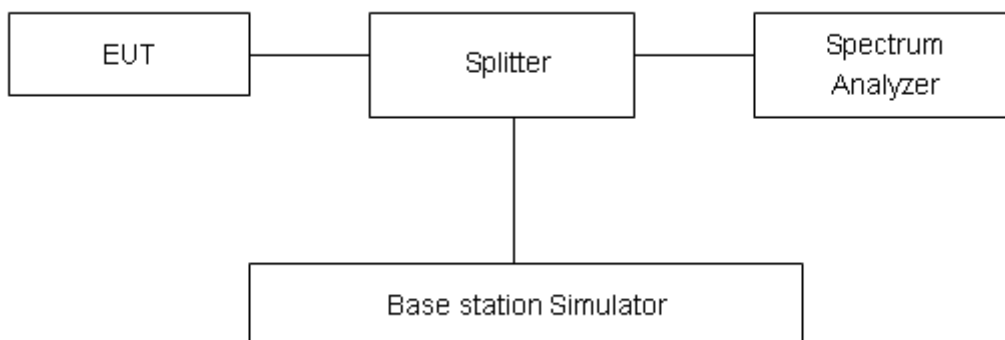

Limits



The 26 dB emission bandwidth is defined as the frequency range between two points, one above and one below the carrier frequency, at which the spectral density of the emission is attenuated 26 dB below the maximum in-band spectral density of the modulated signal. Spectral density (power per unit bandwidth) is to be measured with a detector of resolution bandwidth equal to approximately 1.0% of the emission bandwidth.

Measurement Uncertainty

The assessed measurement uncertainty to ensure 95% confidence level for the normal distribution is with the coverage factor $k = 2$, $U = 624\text{Hz}$.

Test Result

LTE Band 48						
RB	Modulation	Bandwidth (MHz)	Channel	Frequency (MHz)	99% Power Bandwidth(MHz)	-26dBc Bandwidth(MHz)
100%	QPSK	5	55265	3552.5	4.5276	5.219
			55990	3625	4.5099	5.232
			56715	3697.5	4.5113	5.290
		10	55290	3555	9.0940	10.080
			55990	3625	9.0627	10.410
			56690	3695	9.0172	10.030
		15	55315	3557.5	13.4500	14.550
			55990	3625	13.5160	14.580
			56665	3692.5	13.4610	14.520
		20	55340	3560	17.8660	19.210
			55990	3625	17.8330	18.890
			56660	3690	17.9020	18.980
	16QAM	5	55265	3552.5	4.5328	5.300
			55990	3625	4.5193	5.229
			56715	3697.5	4.5113	5.245
		10	55290	3555	9.0370	10.060
			55990	3625	9.0244	9.996
			56690	3695	9.0112	10.010
		15	55315	3557.5	13.4910	14.770
			55990	3625	13.4790	14.440
			56665	3692.5	13.4530	14.560
		20	55340	3560	17.8870	19.100
			55990	3625	17.8380	19.140
			56660	3690	17.8560	19.060
	64QAM	5	55265	3552.5	4.5415	5.323
			55990	3625	4.4974	5.148



			56715	3697.5	4.5229	5.138
		10	55290	3555	9.0497	10.030
			55990	3625	9.0334	9.929
			56690	3695	9.0502	9.981
		15	55315	3557.5	13.4950	14.570
			55990	3625	13.4940	14.610
			56665	3692.5	13.4520	14.410
		20	55340	3560	17.8800	19.000
			55990	3625	17.8480	18.890
			56660	3690	17.8720	18.930



LTE Band 48 5MHz QPSK CH-Low

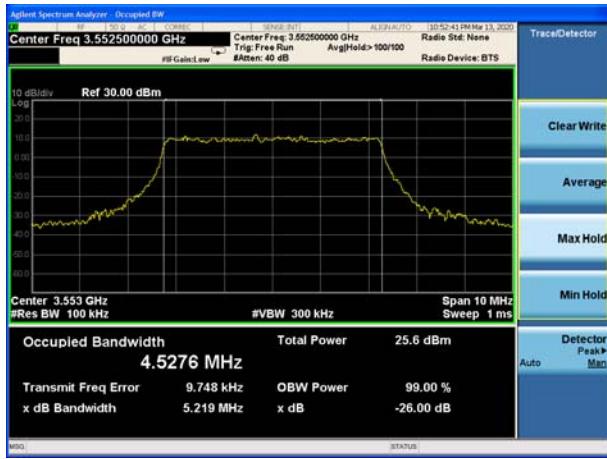

LTE Band 48 10MHz QPSK CH-Low

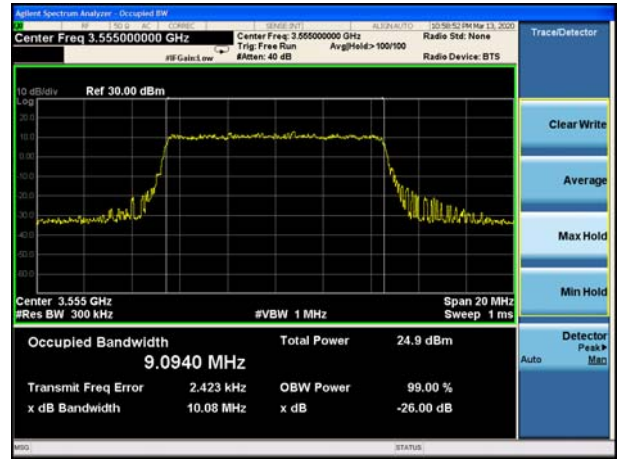

LTE Band 48 5MHz QPSK CH-Middle



LTE Band 48 10MHz QPSK CH-Middle

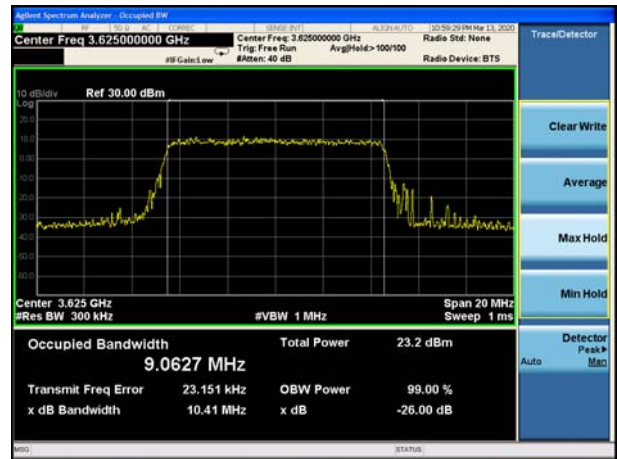

LTE Band 48 5MHz QPSK CH-High



LTE Band 48 10MHz QPSK CH-High

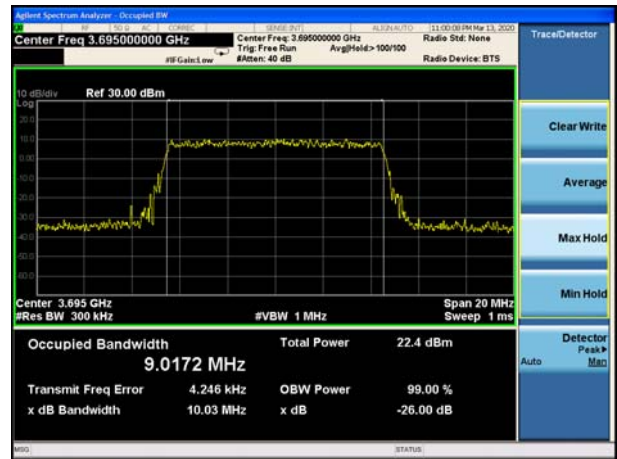

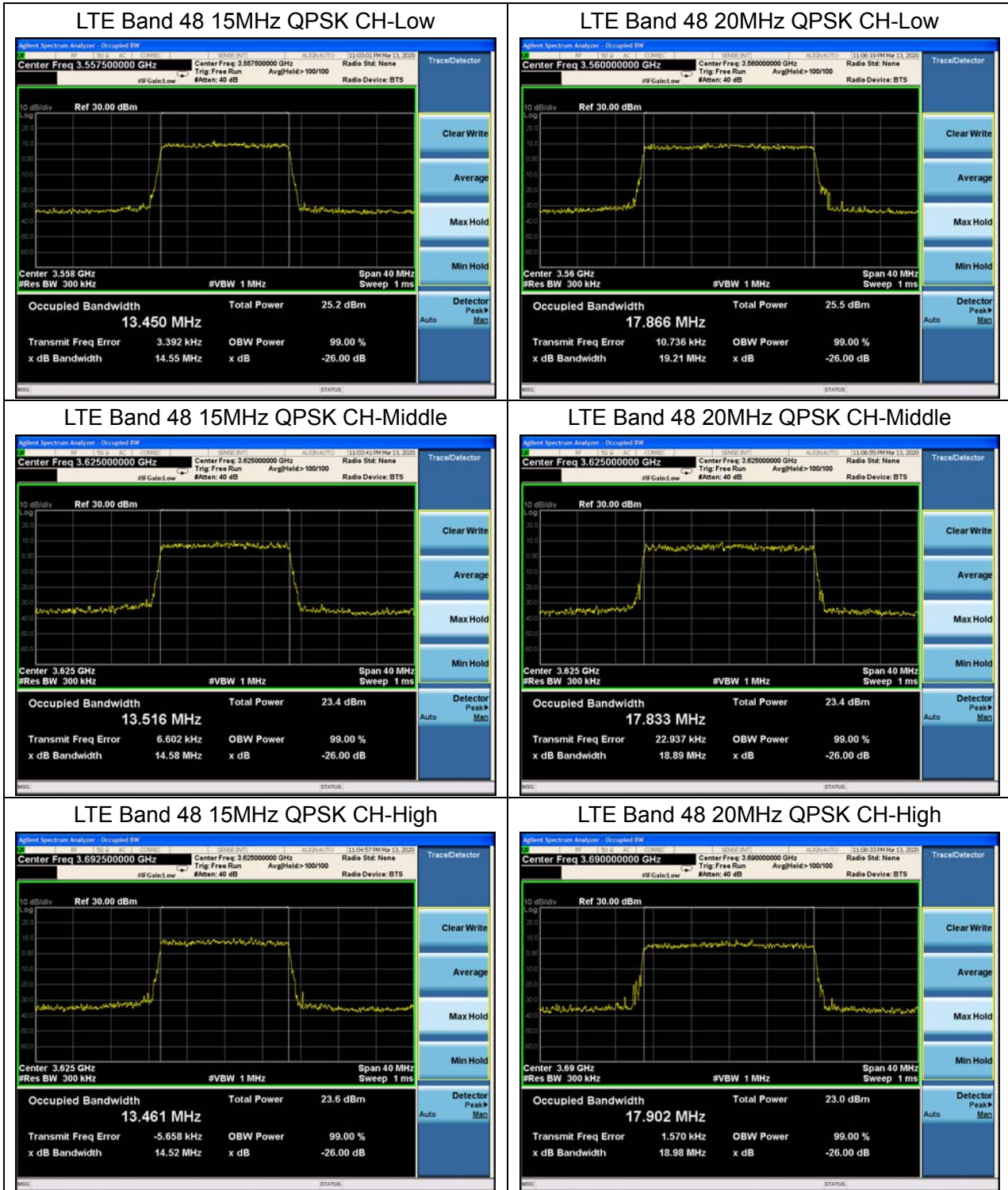



LTE Band 48 5MHz 16QAM CH-Low

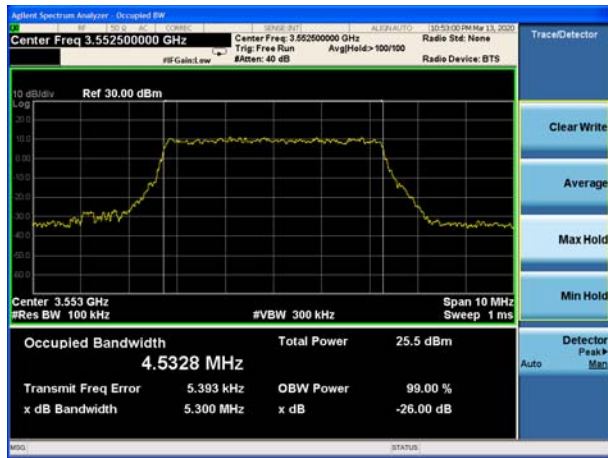

LTE Band 48 10MHz 16QAM CH-Low

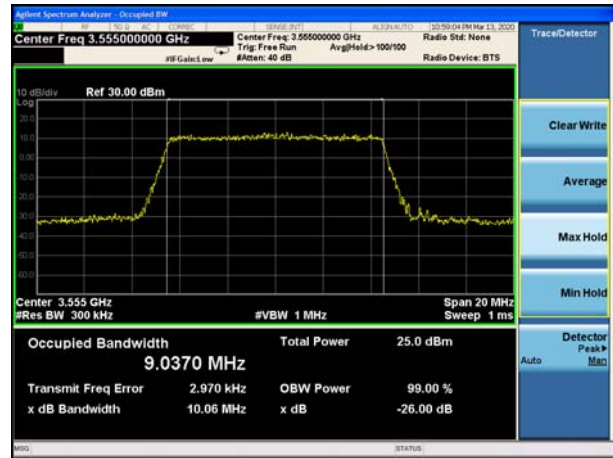

LTE Band 48 5MHz 16QAM CH-Middle

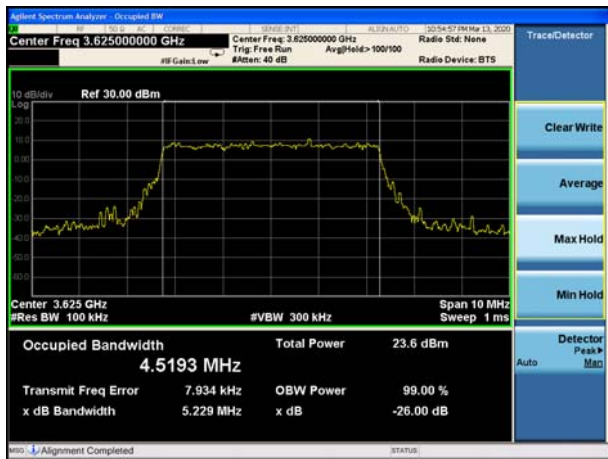

LTE Band 48 10MHz 16QAM CH-Middle

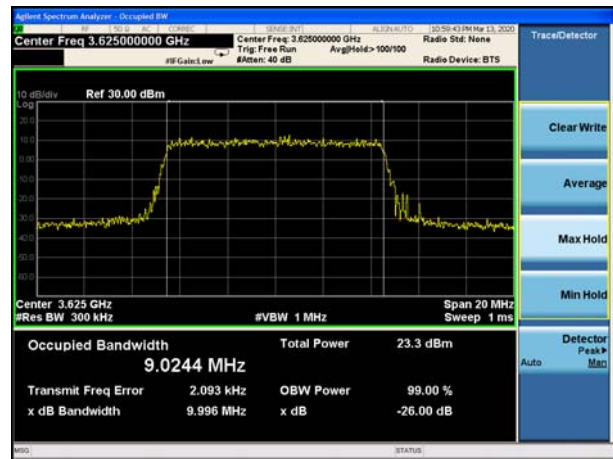

LTE Band 48 5MHz 16QAM CH-High

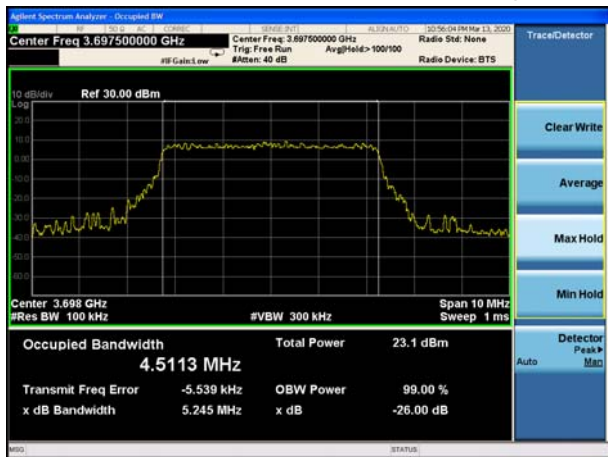

LTE Band 48 10MHz 16QAM CH-High

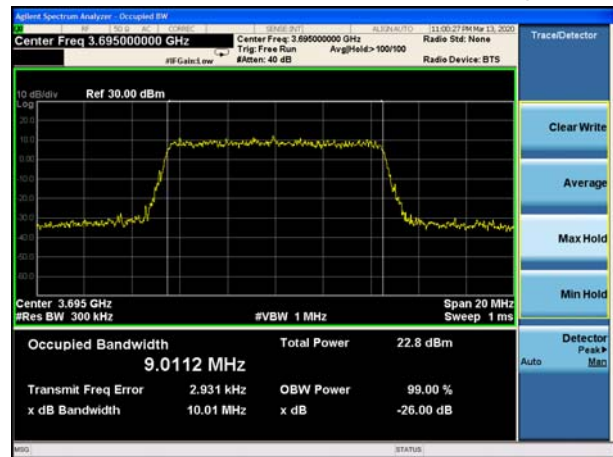



LTE Band 48 15MHz 16QAM CH-Low

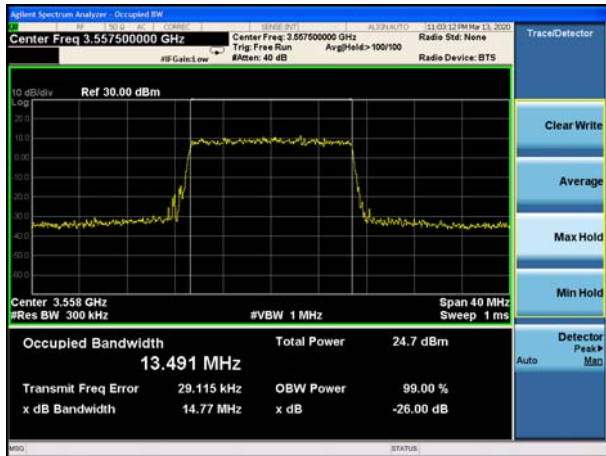

LTE Band 48 20MHz 16QAM CH-Low

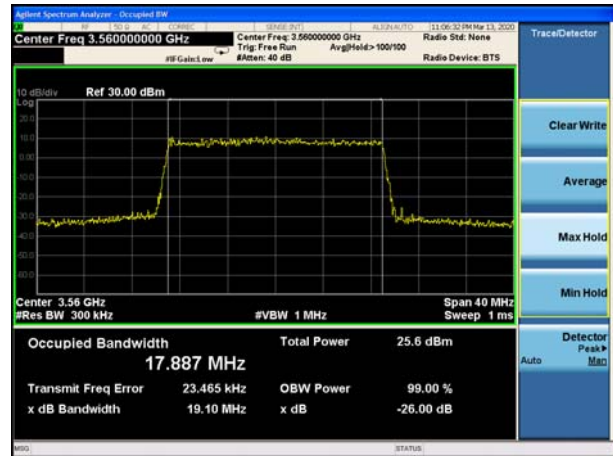

LTE Band 48 15MHz 16QAM CH-Middle

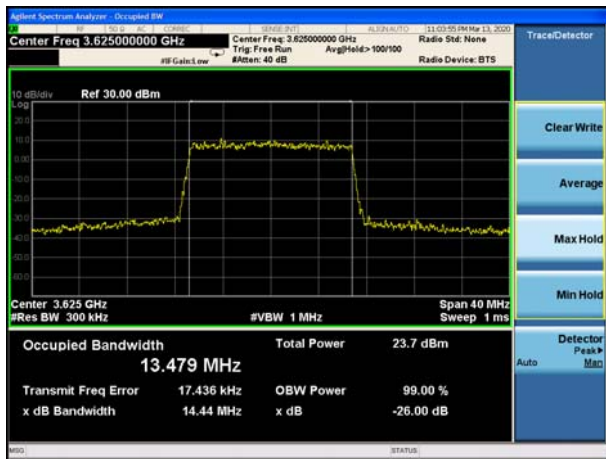

LTE Band 48 20MHz 16QAM CH-Middle

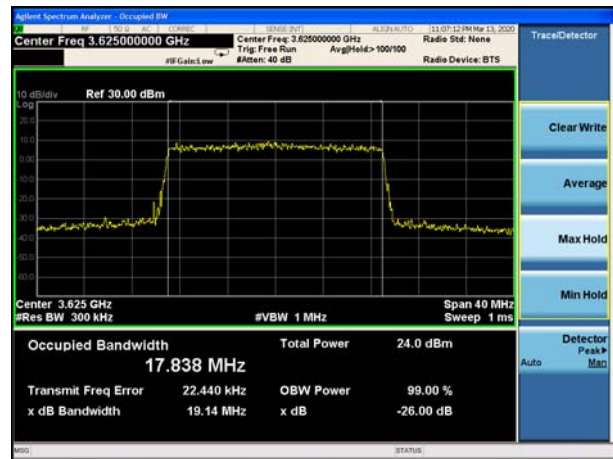

LTE Band 48 15MHz 16QAM CH-High

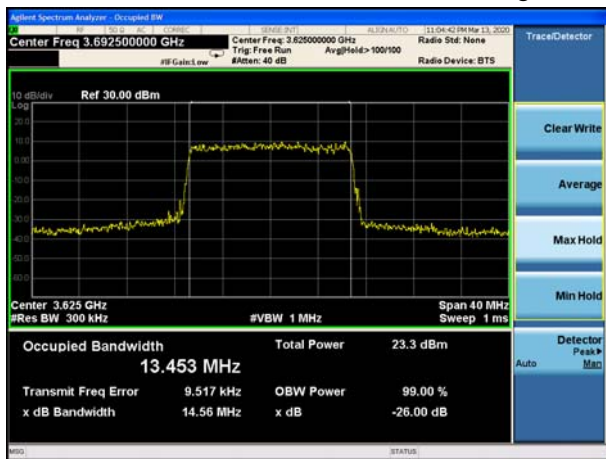

LTE Band 48 20MHz 16QAM CH-High

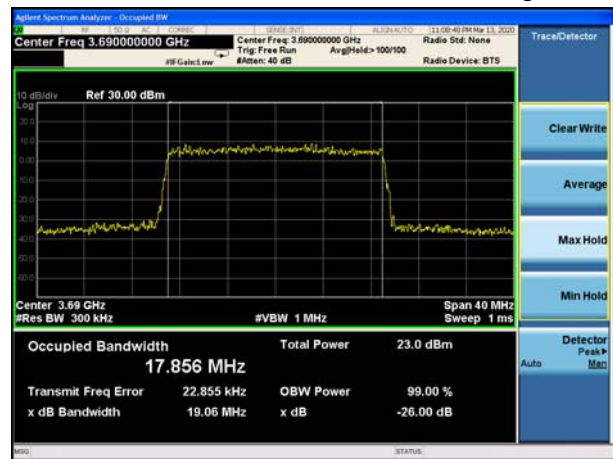

LTE Band 48 5MHz 64QAM CH-Low



LTE Band 48 10MHz 64QAM CH-Low



LTE Band 48 5MHz 64QAM CH-Middle



LTE Band 48 10MHz 64QAM CH-Middle



LTE Band 48 5MHz 64QAM CH-High



LTE Band 48 10MHz 64QAM CH-High



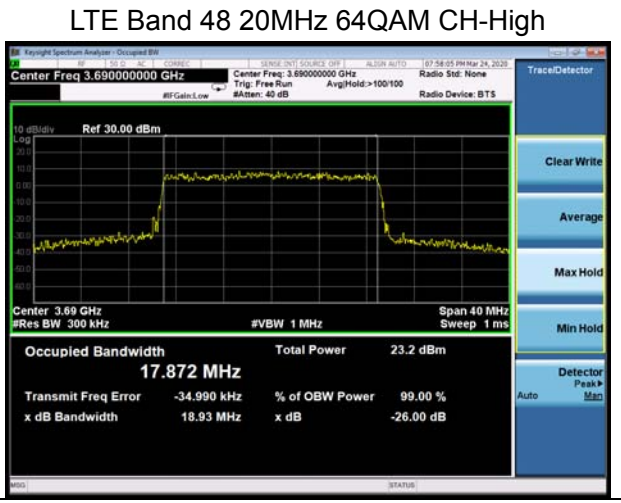
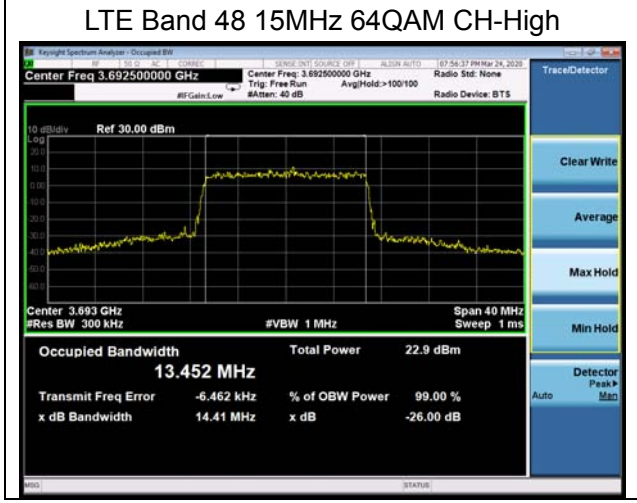
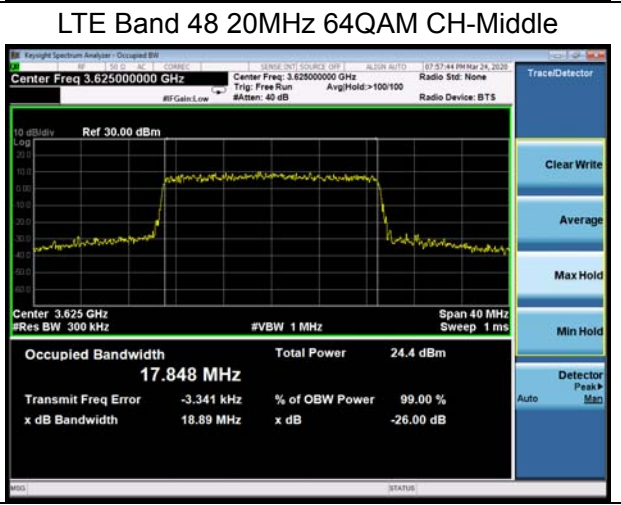
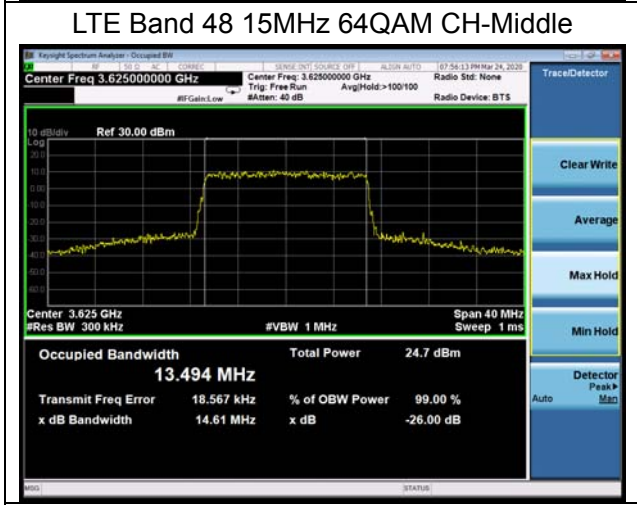
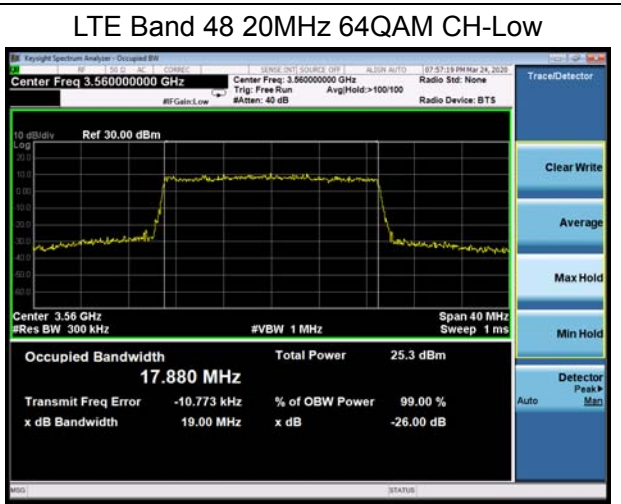
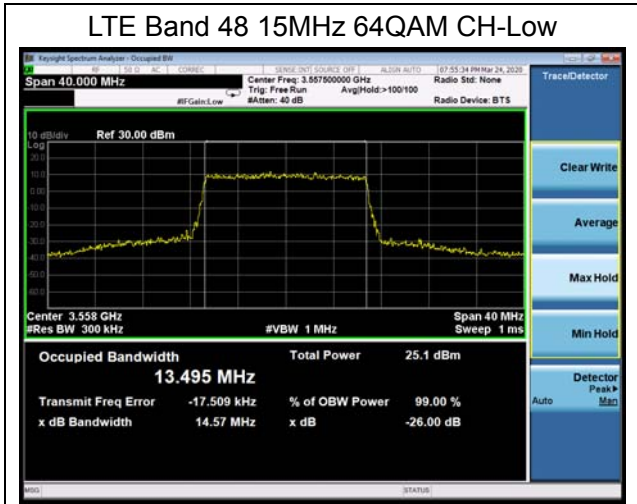

5.4. Band Edge Compliance

Ambient condition

Temperature	Relative humidity	Pressure
23°C ~25°C	45%~50%	101.5kPa

Method of Measurement

The testing follows FCC KDB 971168 D01 v03r01 Section 6.0.

1. The EUT was connected to spectrum analyzer and system simulator via a power divider.
2. The band edges of low and high channels for the highest RF powers were measured.
3. Set RBW \geq 1% EBW in the 1MHz band immediately outside and adjacent to the band edge.
4. Beyond the 1 MHz band from the band edge, RBW=1MHz was used
5. Set spectrum analyzer with RMS detector.
6. The RF fundamental frequency should be excluded against the limit line in the operating frequency band.

Test Setup

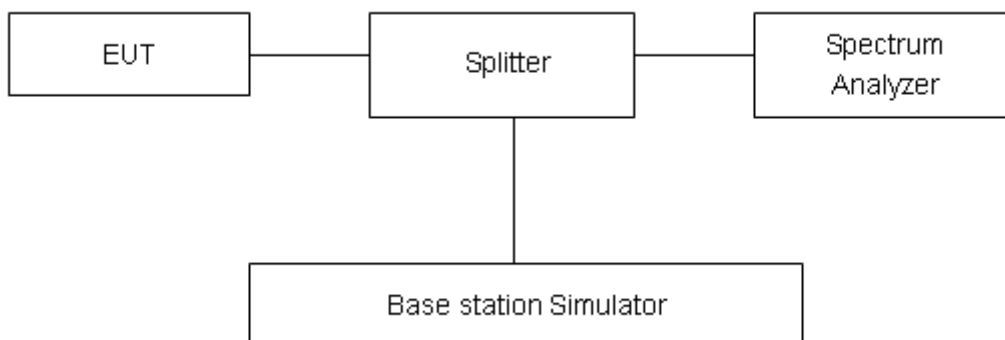

Limits

Rule Part 96.41(e) (1) (i) specifies that “Except as otherwise specified in paragraph (e)(2) of this section, for channel and frequency assignments made by the SAS to CBSDs, the conducted power of any CBSD emission outside the fundamental emission bandwidth as specified in paragraph (e)(3) of this section (whether the emission is inside or outside of the authorized band) shall not exceed -13 dBm/MHz within 0-10 megahertz above the upper SAS-assigned channel edge and within 0-10 megahertz below the lower SAS-assigned channel edge. At all frequencies greater than 10 megahertz above the upper SAS assigned channel edge and less than 10 MHz below the lower SAS assigned channel edge, the conducted power of any CBSD emission shall not exceed -25 dBm/MHz. The upper and lower SAS assigned channel edges are the upper and lower limits of any channel assigned to a CBSD by an SAS, or in the case of multiple contiguous channels, the upper and lower limits of the combined contiguous channels.”

Measurement Uncertainty

The assessed measurement uncertainty to ensure 95% confidence level for the normal distribution is with the coverage factor $k = 1.96$, $U=0.684\text{dB}$.

Test Result:

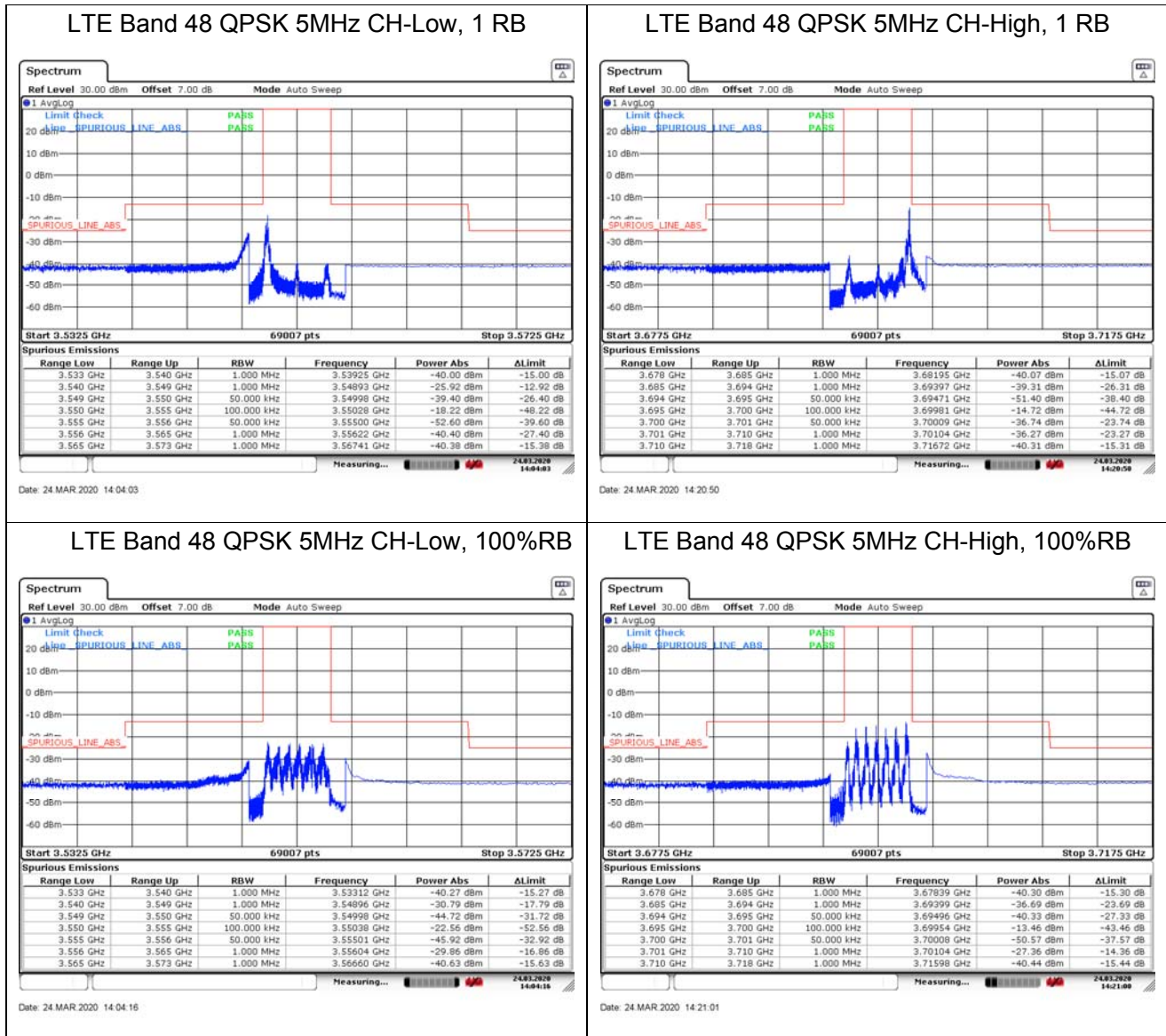



LTE Band 48 QPSK 10MHz CH-Low, 1 RB

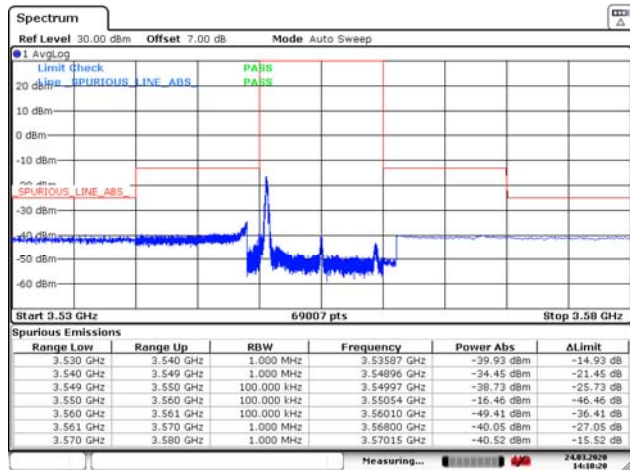

Date: 24 MAR 2020 14 10 20

LTE Band 48 QPSK 10MHz CH-High, 1 RB

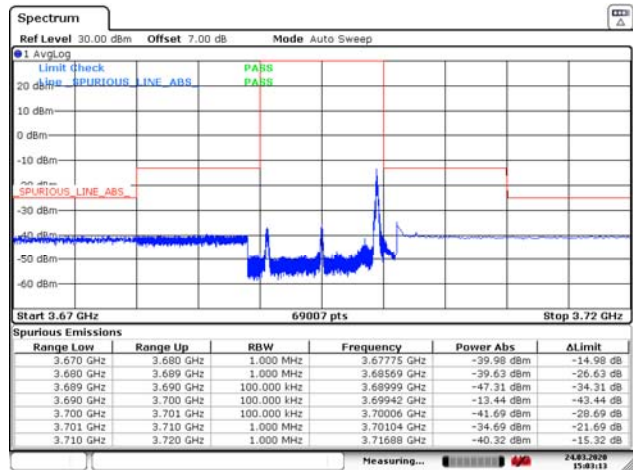

Date: 24 MAR 2020 15 03 13

LTE Band 48 QPSK 10MHz CH-Low, 100%RB

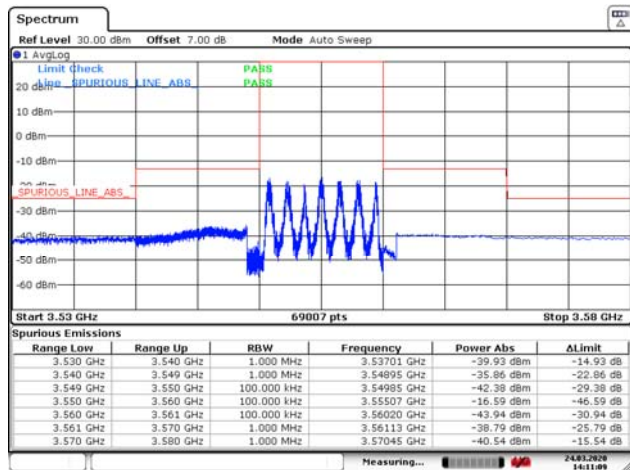

Date: 24 MAR 2020 14 11 10

LTE Band 48 QPSK 10MHz CH-High, 100%RB

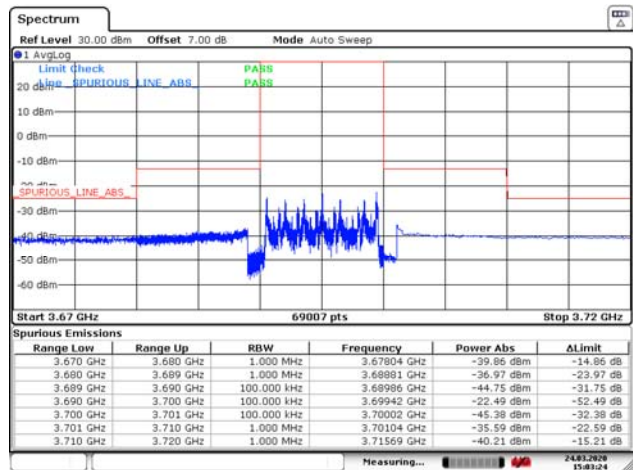

Date: 24 MAR 2020 15 03 23

LTE Band 48 QPSK 15MHz CH-Low, 1 RB

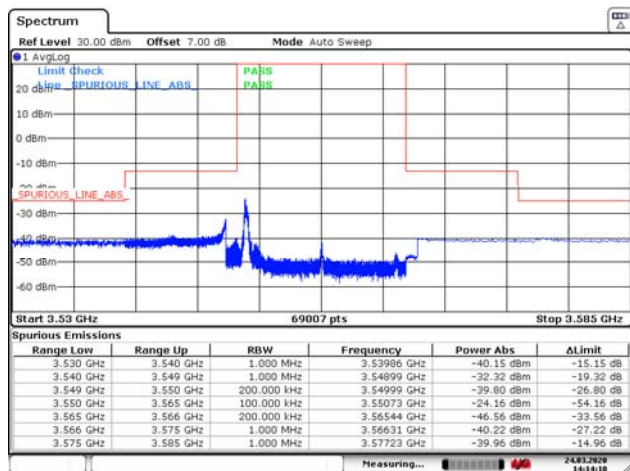

Date: 24 MAR 2020 14 14 10

LTE Band 48 QPSK 15MHz CH-High, 1 RB

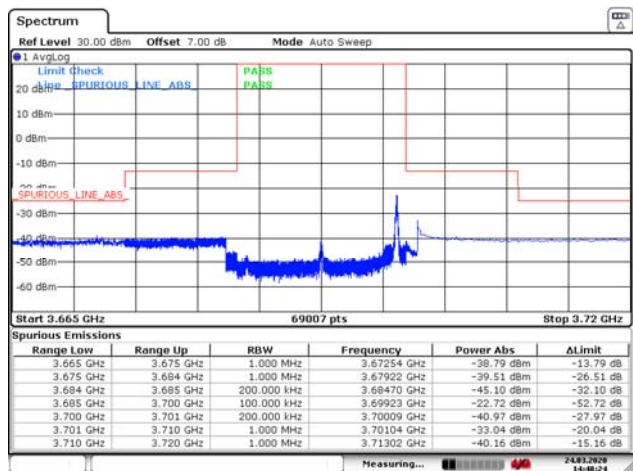

Date: 24 MAR 2020 14 48 24



LTE Band 48 QPSK 15MHz CH-Low, 100%RB

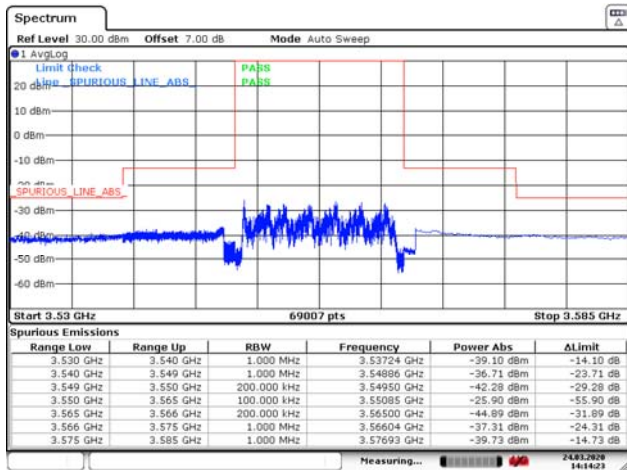

Date: 24 MAR 2020 14:14:23

LTE Band 48 QPSK 15MHz CH-High, 100%RB

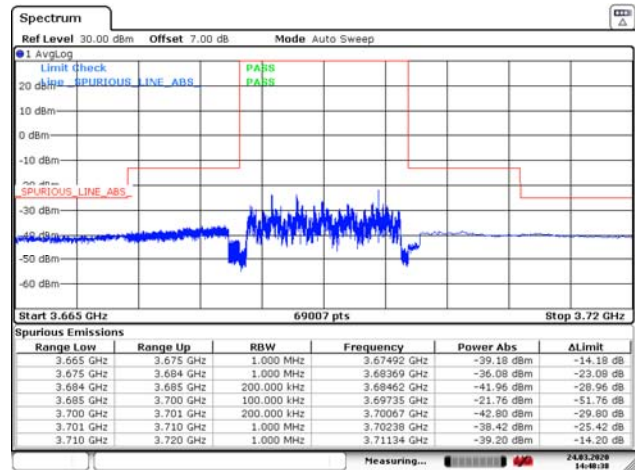

Date: 24 MAR 2020 14:48:38

LTE Band 48 QPSK 20MHz CH-Low, 1 RB

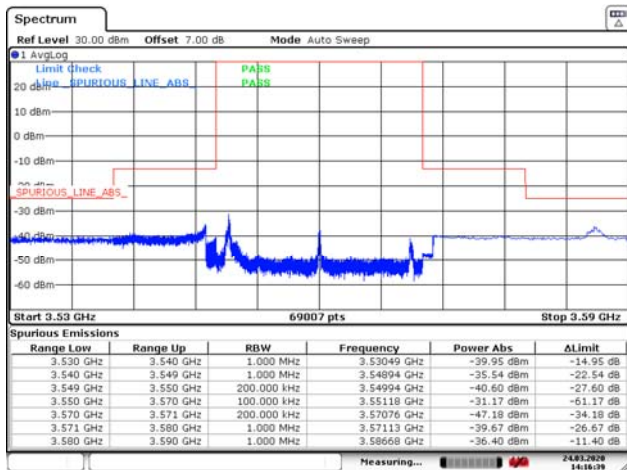

Date: 24 MAR 2020 14:16:39

LTE Band 48 QPSK 20MHz CH-High, 1 RB

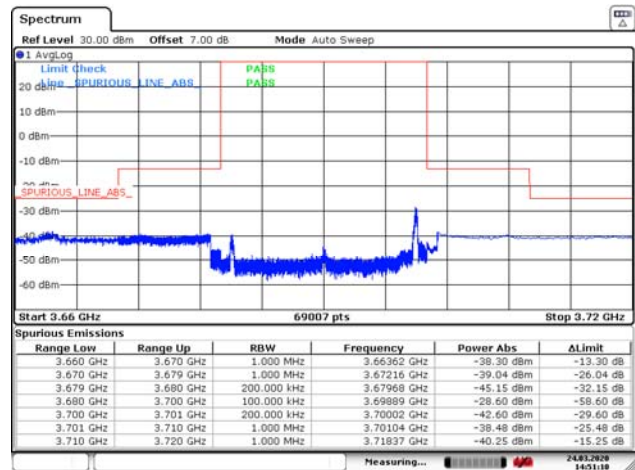

Date: 24 MAR 2020 14:51:10

LTE Band 48 QPSK 20MHz CH-Low, 100%RB

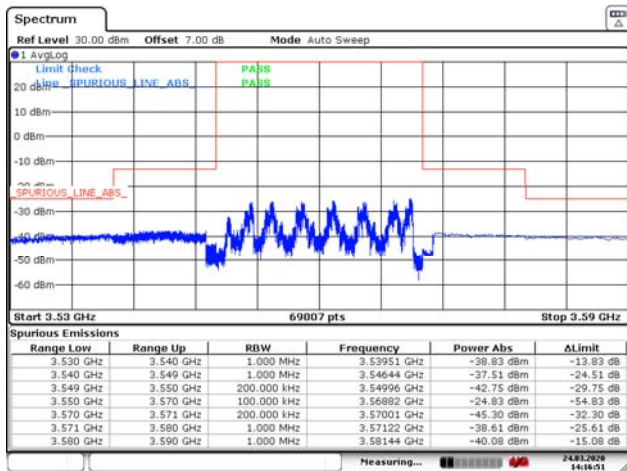

Date: 24 MAR 2020 14:16:51

LTE Band 48 QPSK 20MHz CH-High, 100%RB

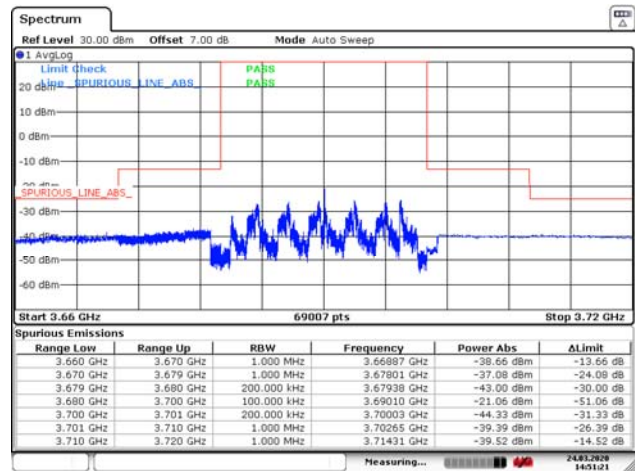

Date: 24 MAR 2020 14:51:20



LTE Band 48 16QAM 5MHz CH-Low, 1 RB

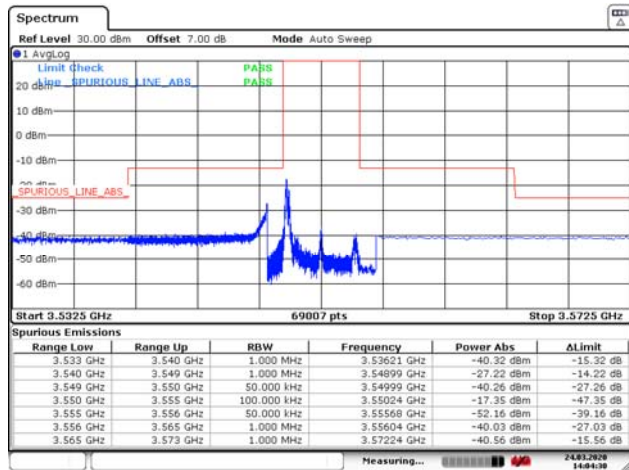

Date: 24 MAR 2020 14:04:30

LTE Band 48 16QAM 5MHz CH-High, 1 RB

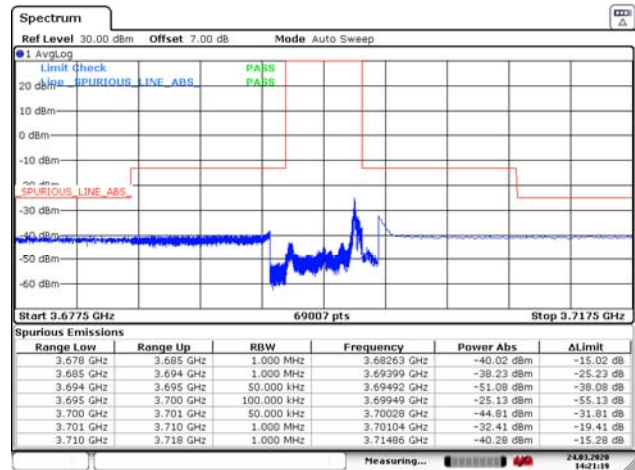

Date: 24 MAR 2020 14:21:19

LTE Band 48 16QAM 5MHz CH-Low, 100%RB

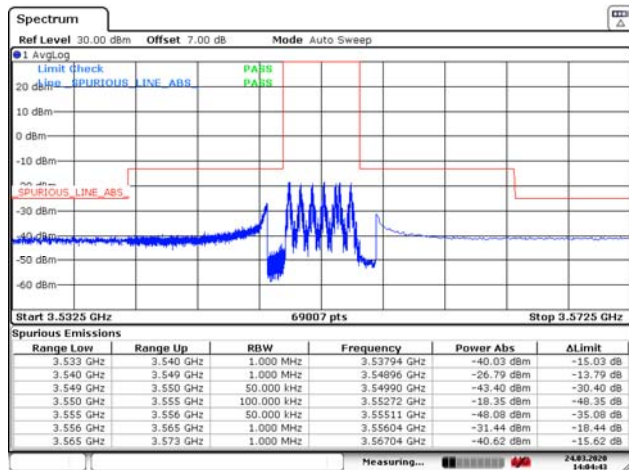

Date: 24 MAR 2020 14:04:43

LTE Band 48 16QAM 5MHz CH-High, 100%RB

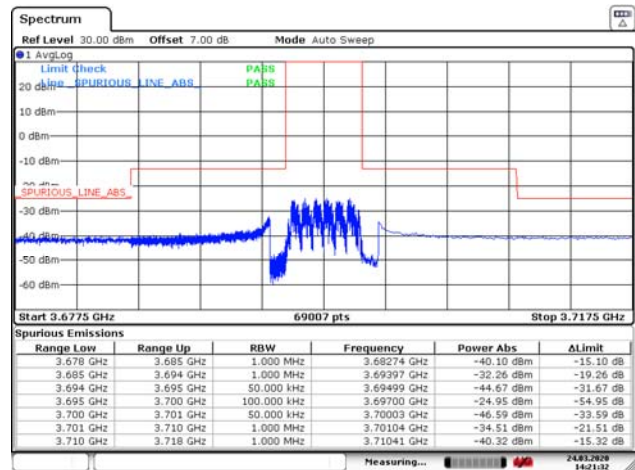

Date: 24 MAR 2020 14:21:32

LTE Band 48 16QAM 10MHz CH-Low, 1 RB

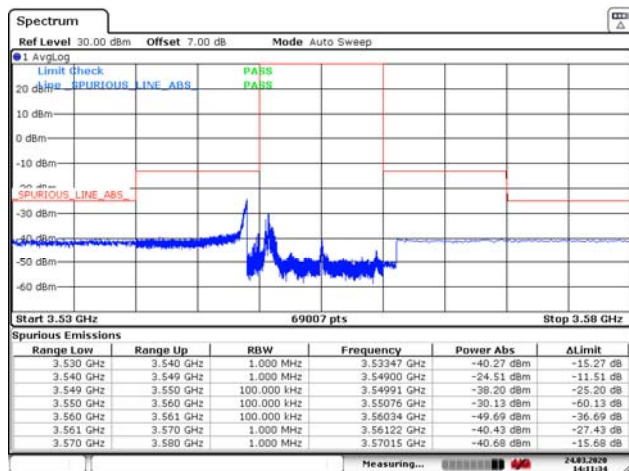

Date: 24 MAR 2020 14:11:33

LTE Band 48 16QAM 10MHz CH-High, 1 RB

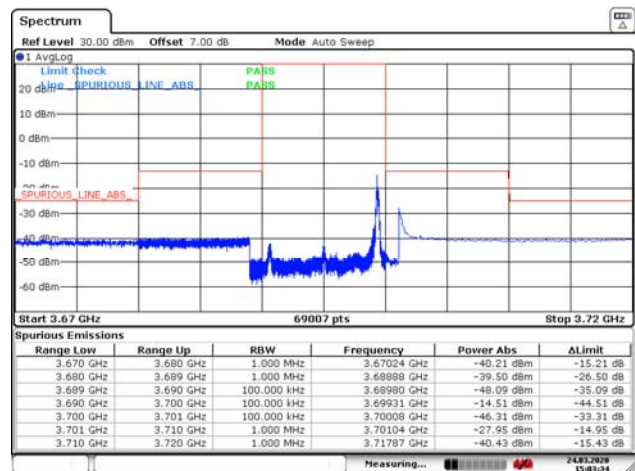

Date: 24 MAR 2020 15:03:33



LTE Band 48 16QAM 10MHz CH-Low, 100%RB

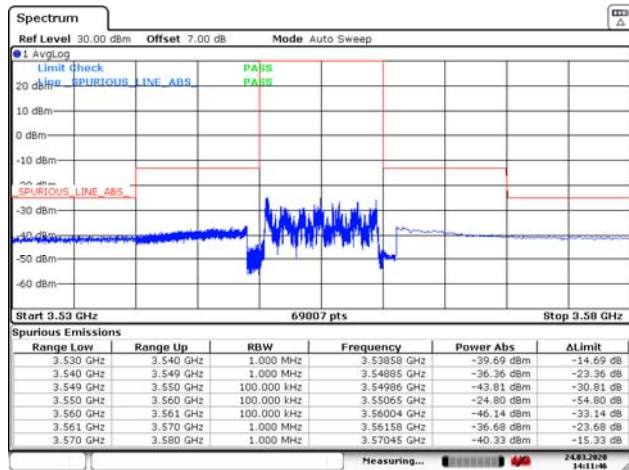

Date: 24 MAR 2020 14:11:46

LTE Band 48 16QAM 10MHz CH-High, 100%RB

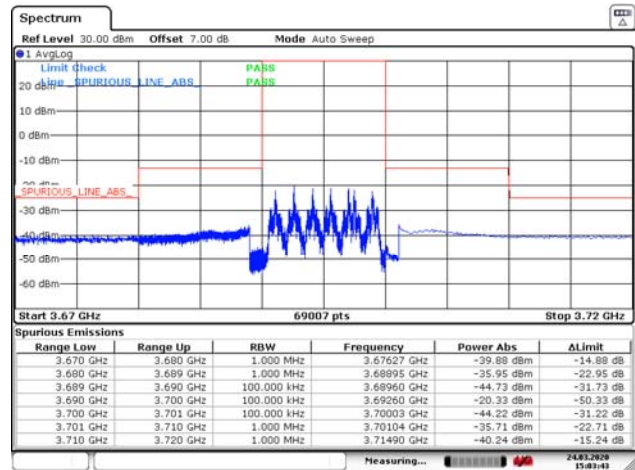

Date: 24 MAR 2020 15:03:43

LTE Band 48 16QAM 15MHz CH-Low, 1 RB

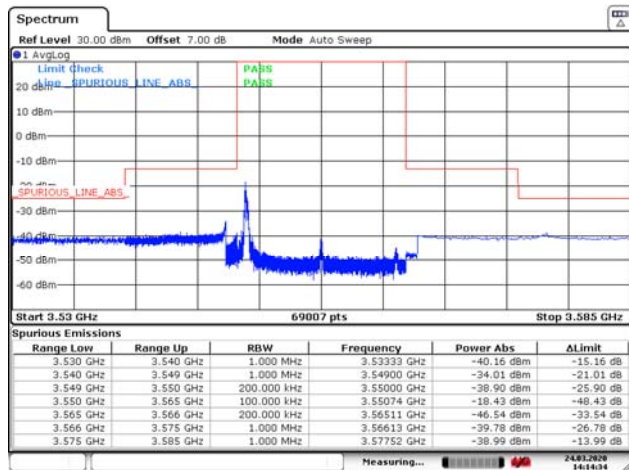

Date: 24 MAR 2020 14:14:34

LTE Band 48 16QAM 15MHz CH-High, 1 RB

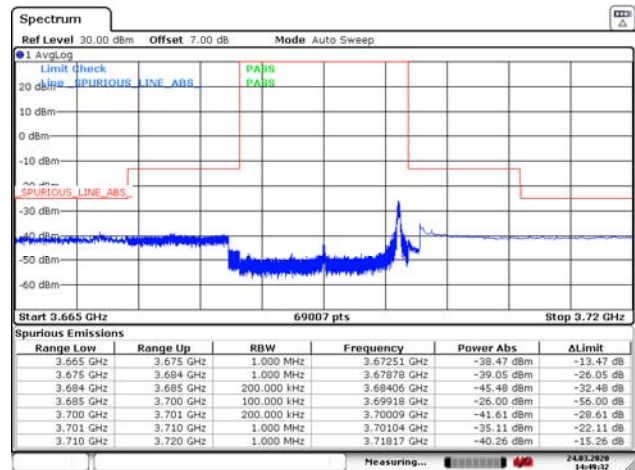

Date: 24 MAR 2020 14:49:32

LTE Band 48 16QAM 15MHz CH-Low, 100%RB

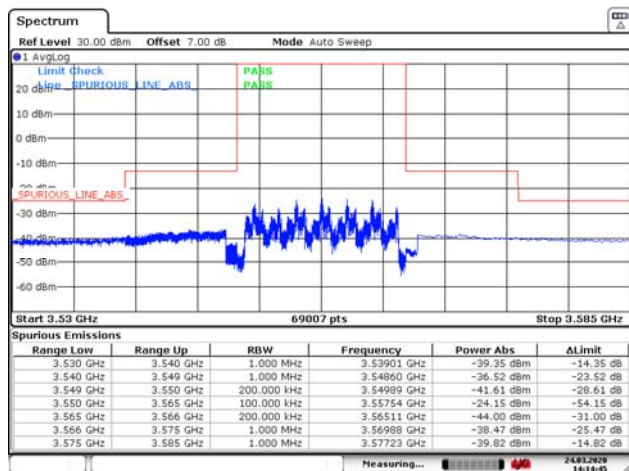

Date: 24 MAR 2020 14:14:45

LTE Band 48 16QAM 15MHz CH-High, 100%RB

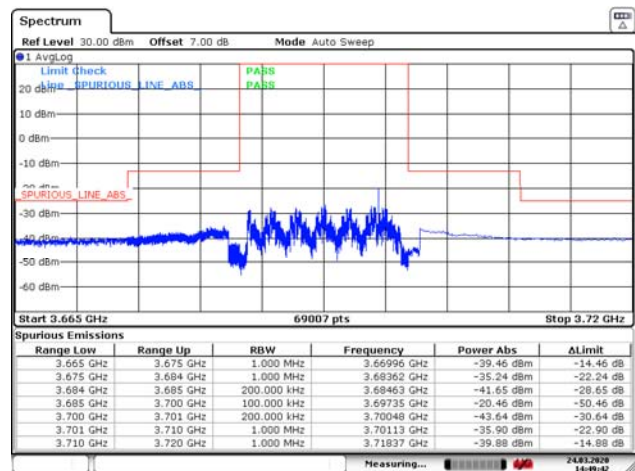

Date: 24 MAR 2020 14:49:42



LTE Band 48 16QAM 20MHz CH-Low, 1 RB

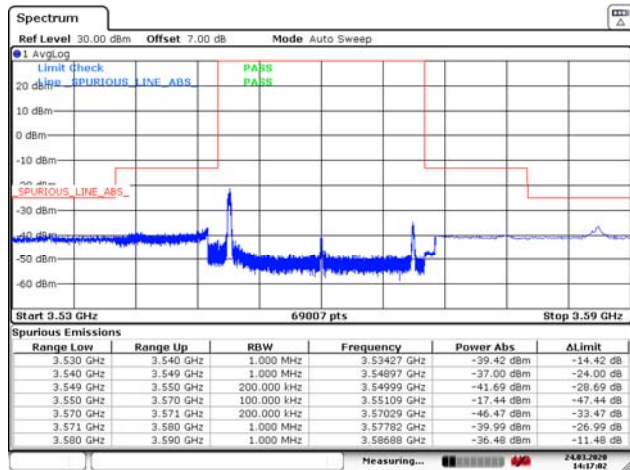

Date: 24 MAR 2020 14:17:02

LTE Band 48 16QAM 20MHz CH-High, 1 RB

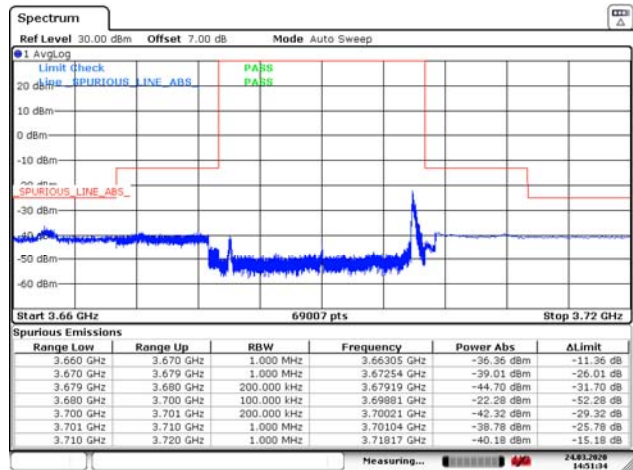

Date: 24 MAR 2020 14:51:34

LTE Band 48 16QAM 20MHz CH-Low, 100%RB

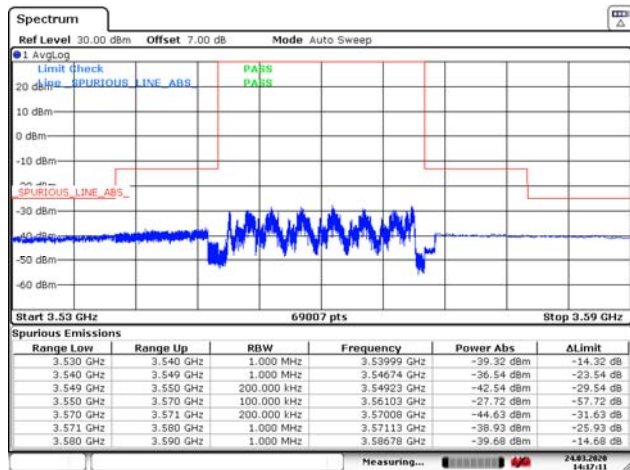

Date: 24 MAR 2020 14:17:11

LTE Band 48 16QAM 20MHz CH-High, 100%RB

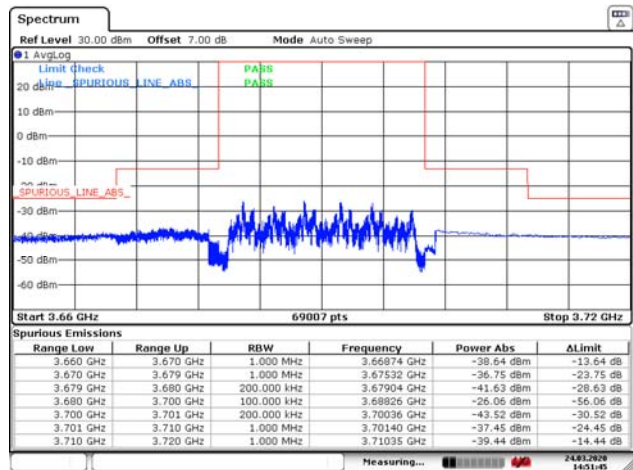

Date: 24 MAR 2020 14:51:45

LTE Band 48 64QAM 5MHz CH-Low, 1 RB

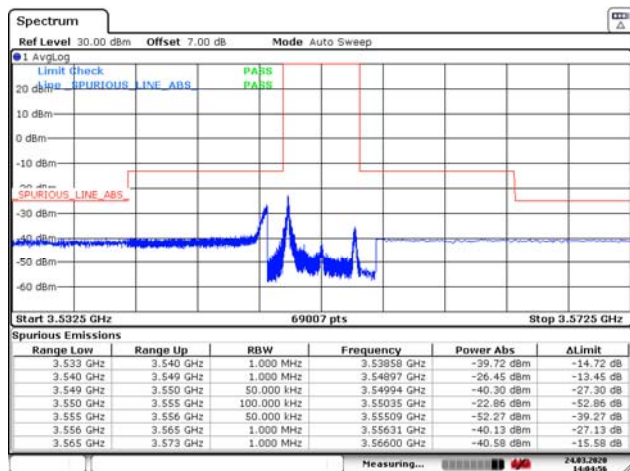

Date: 24 MAR 2020 14:04:56

LTE Band 48 64QAM 5MHz CH-High, 1 RB

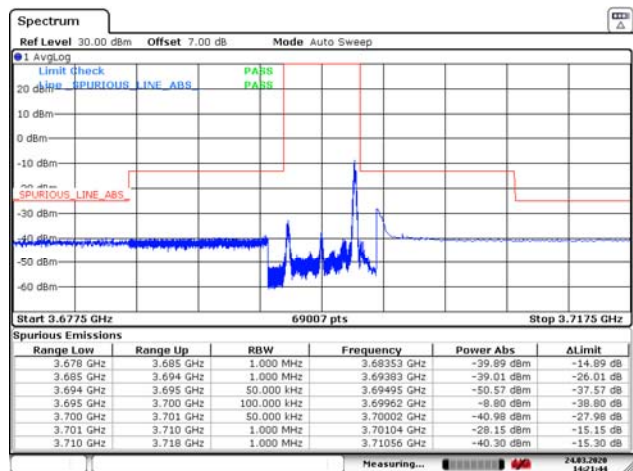

Date: 24 MAR 2020 14:21:44



LTE Band 48 64QAM 5MHz CH-Low, 100%RB

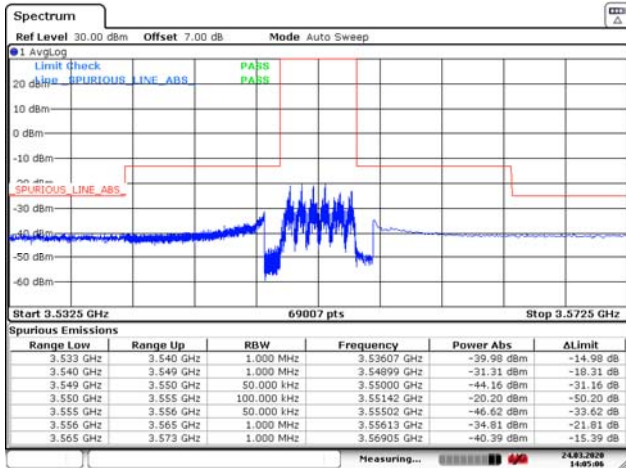

Date: 24 MAR 2020 14 05 06

LTE Band 48 64QAM 5MHz CH-High, 100%RB

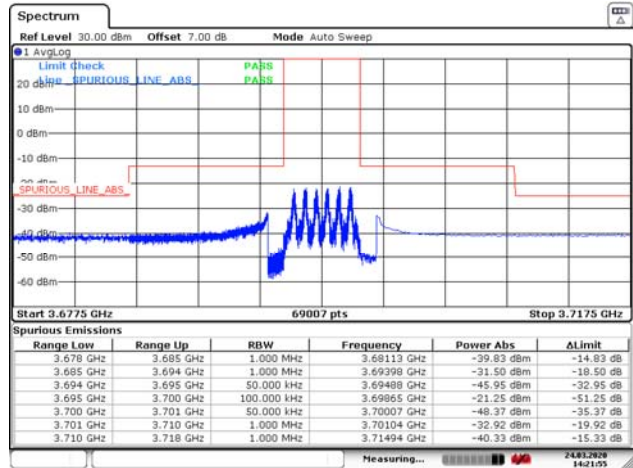

Date: 24 MAR 2020 14 21 55

LTE Band 48 64QAM 10MHz CH-Low, 1 RB

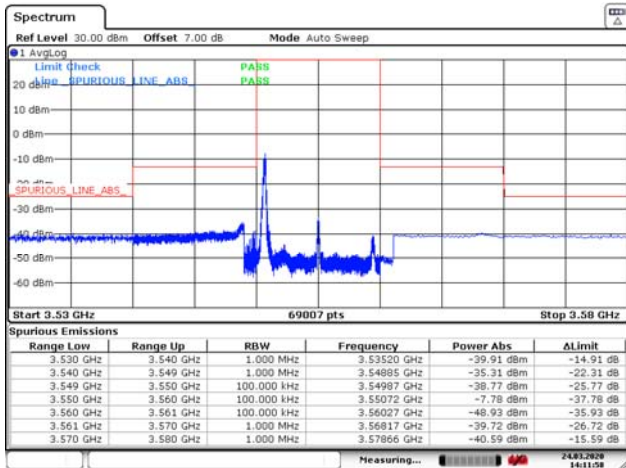

Date: 24 MAR 2020 14 11 57

LTE Band 48 64QAM 10MHz CH-High, 1 RB

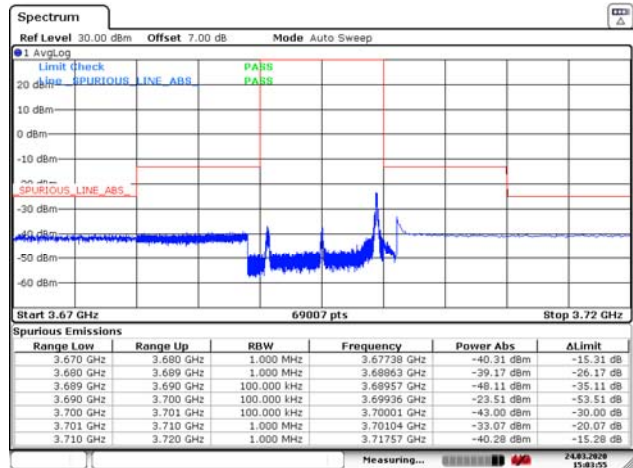

Date: 24 MAR 2020 15 03 55

LTE Band 48 64QAM 10MHz CH-Low, 100%RB

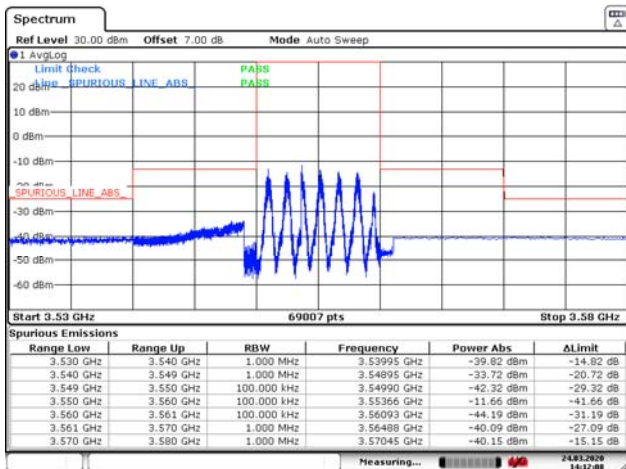

Date: 24 MAR 2020 14 12 08

LTE Band 48 64QAM 10MHz CH-High, 100%RB

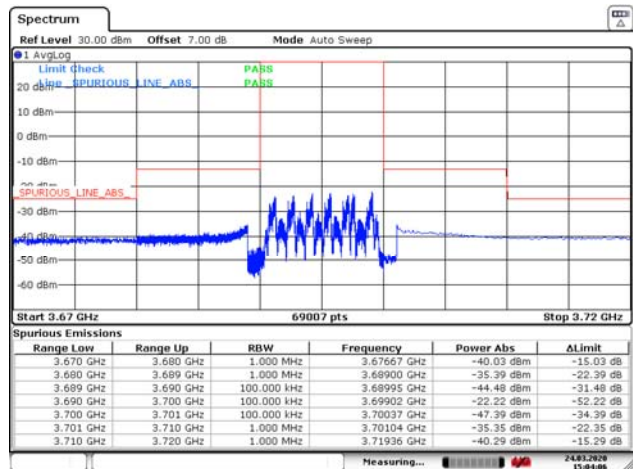

Date: 24 MAR 2020 15 04 06



LTE Band 48 64QAM 15MHz CH-Low, 1 RB

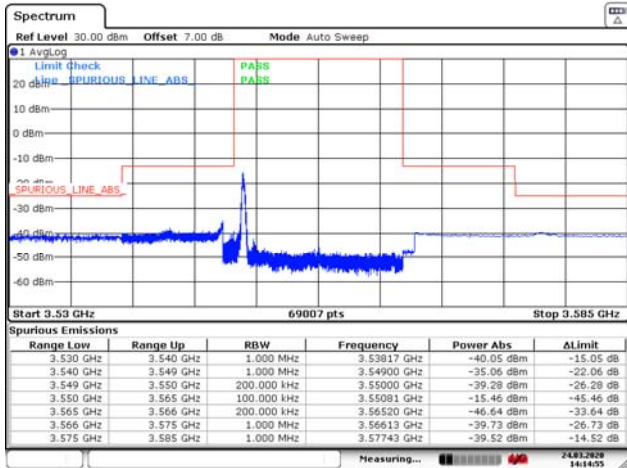

Date: 24 MAR 2020 14:14:55

LTE Band 48 64QAM 15MHz CH-High, 1 RB

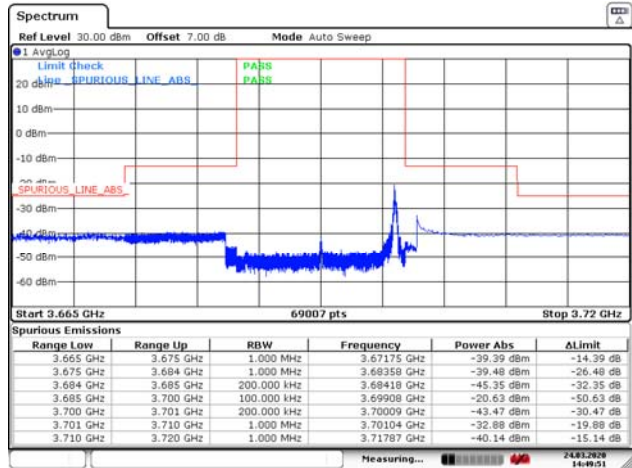

Date: 24 MAR 2020 14:49:52

LTE Band 48 64QAM 15MHz CH-Low, 100%RB

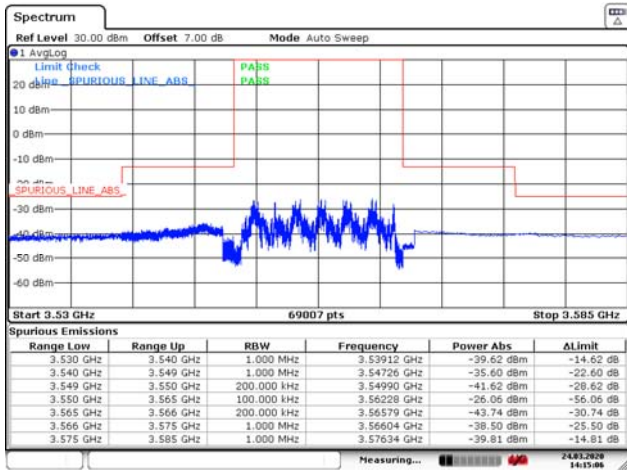

Date: 24 MAR 2020 14:15:06

LTE Band 48 64QAM 15MHz CH-High, 100%RB

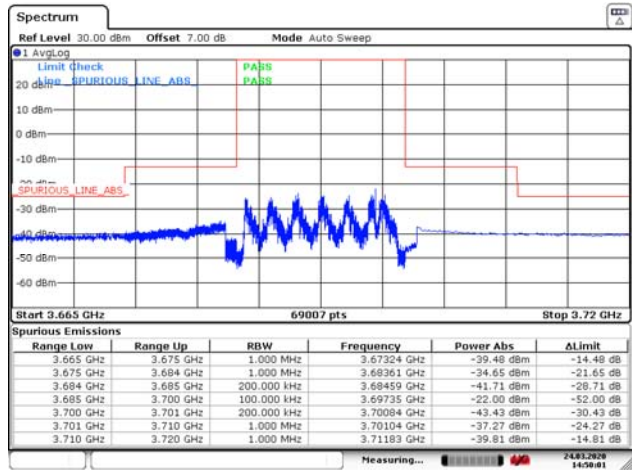

Date: 24 MAR 2020 14:50:01

LTE Band 48 64QAM 20MHz CH-Low, 1 RB

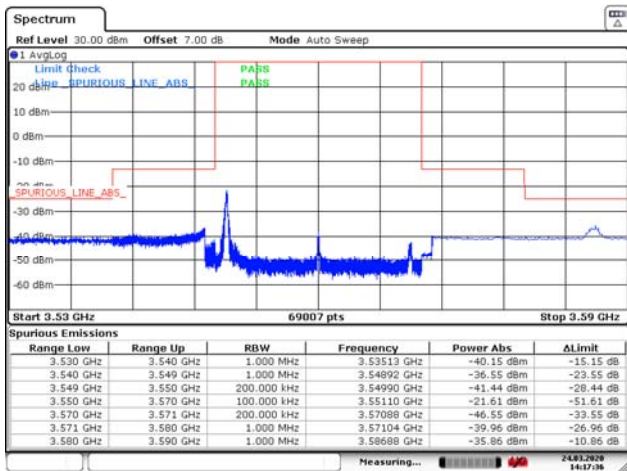

Date: 24 MAR 2020 14:17:35

LTE Band 48 64QAM 20MHz CH-High, 1 RB

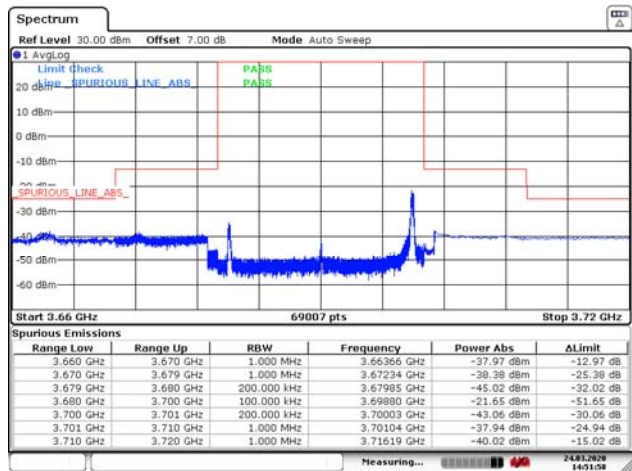

Date: 24 MAR 2020 14:51:58



LTE Band 48 64QAM 20MHz CH-Low, 100%RB

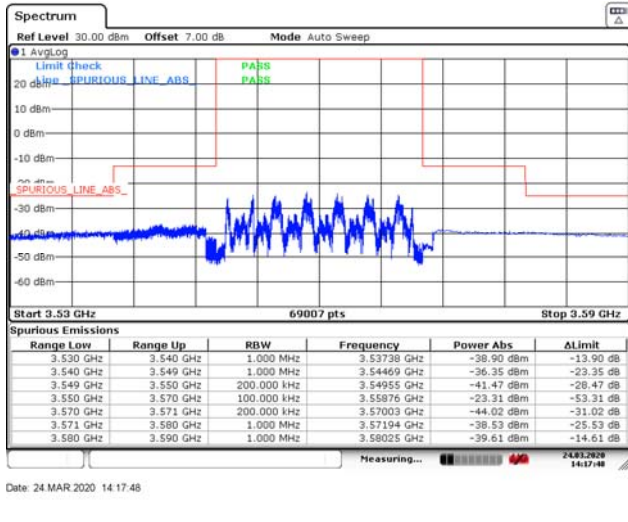

LTE Band 48 64QAM 20MHz CH-High, 100%RB

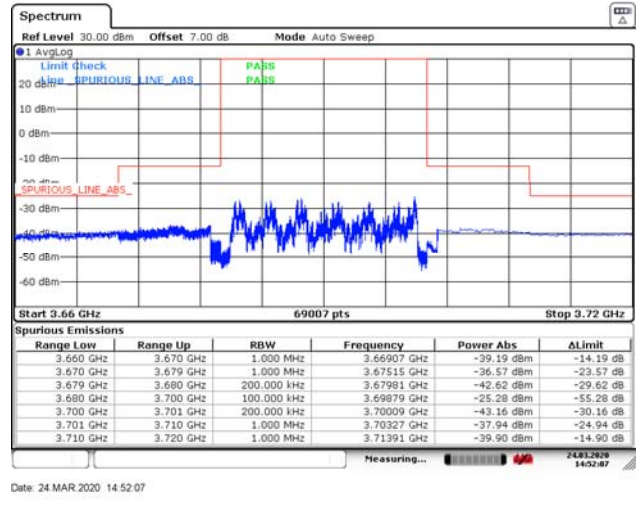

5.5. Peak-to-Average Power Ratio (PAPR)

Ambient condition

Temperature	Relative humidity	Pressure
23°C ~25°C	45%~50%	101.5kPa

Methods of Measurement

Power Complementary Cumulative Distribution Function (CCDF) curves provide a means for characterizing the power peaks of a digitally modulated signal on a statistical basis. A CCDF curve depicts the probability of the peak signal amplitude exceeding the average power level. Most contemporary measurement instrumentation include the capability to produce CCDF curves for an input signal provided that the instrument’s resolution bandwidth can be set wide enough to accommodate the entire input signal bandwidth.

The testing follows FCC KDB 971168 D01 v03r01 Section 5.7.1

1. The EUT was connected to spectrum and system simulator via a power divider.
2. Set the CCDF (Complementary Cumulative Distribution Function) option in spectrum analyzer.
3. The highest RF powers were measured and recorded the maximum PAPR level associated with a probability of 0.1 %.
4. Record the deviation as Peak to Average Ratio

Test Setup

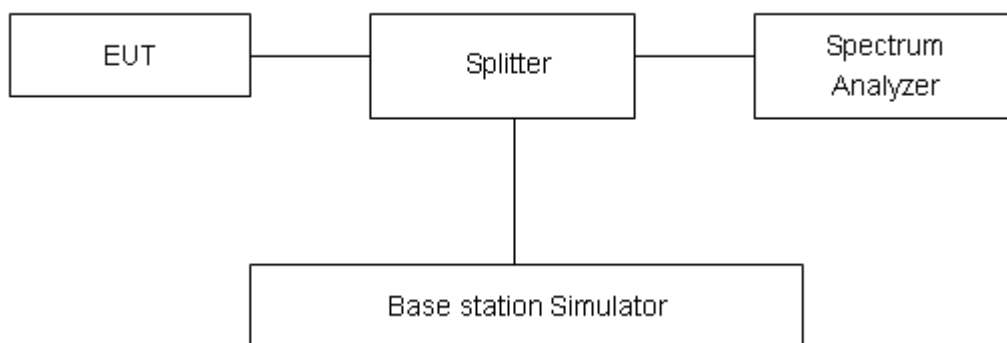

Limits

Rule Part 96.41(g), The peak-to-average power ratio (PAPR) of any CBSD transmitter output power must not exceed 13 dB.

Measurement Uncertainty

The assessed measurement uncertainty to ensure 95% confidence level for the normal distribution is with the coverage factor $k = 2$, $U = 0.4$ dB.



Test Results

LTE Band 48								
Modulation	Bandwidth (MHz)	Channel	Frequency (MHz)	Peak (dBm)	Avg (dBm)	PAPR (dB)	Limit (dB)	Conclusion
QPSK	5	55265	3552.5	22.28	13.01	9.27	≤13	PASS
		55990	3625	21.54	11.85	9.69	≤13	PASS
		56715	3697.5	20.68	11.53	9.15	≤13	PASS
	10	55290	3555	22.18	13.00	9.18	≤13	PASS
		55990	3625	21.38	12.06	9.32	≤13	PASS
		56690	3695	20.69	11.24	9.45	≤13	PASS
	15	55315	3557.5	22.89	13.37	9.52	≤13	PASS
		55990	3625	21.80	12.06	9.74	≤13	PASS
		56665	3692.5	21.18	11.44	9.74	≤13	PASS
	20	55340	3560	22.66	12.98	9.68	≤13	PASS
		55990	3625	21.95	12.54	9.41	≤13	PASS
		5660	3690	21.20	12.00	9.20	≤13	PASS
16QAM	5	55265	3552.5	22.92	12.76	10.16	≤13	PASS
		55990	3625	22.26	12.24	10.02	≤13	PASS
		56715	3697.5	21.33	11.30	10.03	≤13	PASS
	10	55290	3555	22.97	13.16	9.81	≤13	PASS
		55990	3625	22.14	11.91	10.23	≤13	PASS
		56690	3695	21.43	11.23	10.20	≤13	PASS
	15	55315	3557.5	23.36	12.63	10.73	≤13	PASS
		55990	3625	22.30	11.63	10.67	≤13	PASS
		56665	3692.5	21.69	11.26	10.43	≤13	PASS
	20	55340	3560	23.44	13.57	9.87	≤13	PASS
		55990	3625	22.73	12.80	9.93	≤13	PASS
		5660	3690	21.83	11.20	10.63	≤13	PASS
64QAM	5	55265	3552.5	22.90	12.71	10.19	≤13	PASS
		55990	3625	23.33	13.01	10.32	≤13	PASS
		56715	3697.5	21.87	11.78	10.09	≤13	PASS
	10	55290	3555	22.40	12.36	10.04	≤13	PASS
		55990	3625	22.99	12.98	10.01	≤13	PASS
		56690	3695	21.67	11.54	10.13	≤13	PASS



	15	55315	3557.5	22.87	12.45	10.42	≤13	PASS
		55990	3625	23.36	13.05	10.31	≤13	PASS
		56665	3692.5	22.28	12.22	10.06	≤13	PASS
	20	55340	3560	23.01	12.78	10.23	≤13	PASS
		55990	3625	23.33	13.07	10.26	≤13	PASS
		5660	3690	22.18	11.28	10.90	≤13	PASS

5.6. Frequency Stability

Ambient condition

Temperature	Relative humidity	Pressure
23°C ~25°C	45%~50%	101.5kPa

Method of Measurement

Test Procedures for Temperature Variation

The testing follows FCC KDB 971168 D01 v03r01 Section 9.0.

1. The EUT was set up in the thermal chamber and connected with the system simulator.
2. With power OFF, the temperature was decreased to -30°C and the EUT was stabilized before testing. Power was applied and the maximum change in frequency was recorded within one minute.
3. With power OFF, the temperature was raised in 10°C step up to 50°C. The EUT was stabilized at each step for at least half an hour. Power was applied and the maximum frequency change was recorded within one minute.

Test Procedures for Voltage Variation

The testing follows FCC KDB 971168 D01 v03r01 Section 9.0.

1. The EUT was placed in a temperature chamber at 25±5° C and connected with the system simulator.
2. The power supply voltage to the EUT was varied from 85% to 115% of the nominal value measured at the input to the EUT.
3. The variation in frequency was measured for the worst case.

Test setup

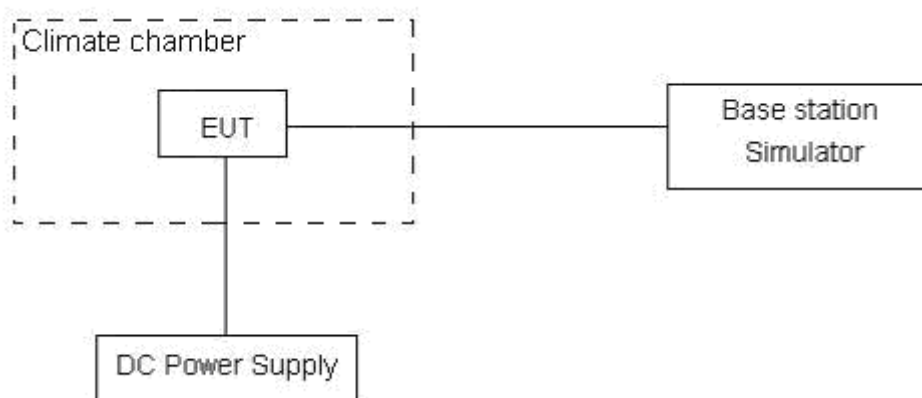

Limits

The frequency stability shall be measured by variation of ambient temperature and variation of primary supply voltage to ensure that the fundamental emission stays within the authorized frequency block. The frequency stability of the transmitter shall be maintained within ±0.00025% (±2.5ppm) of the center frequency



Measurement Uncertainty

The assessed measurement uncertainty to ensure 99.75% confidence level for the normal distribution is with the coverage factor $k = 3$, $U = 0.01\text{ppm}$.



Test Result

Condition		Freq. Error (Hz)	Freq. Error (Hz)	Freq. Error (Hz)	Frequency Stability (ppm)	Frequency Stability (ppm)	Frequency Stability (ppm)	Verdict
BANDWIDTH	5MHz	(Hz)	(Hz)	(Hz)	(ppm)	(ppm)	(ppm)	
Temperature	Voltage	64QAM	16QAM	QPSK	64QAM	16QAM	QPSK	
Normal(25°C)	Normal	6.87	3.10	17.75	0.00366	0.00165	0.00944	PASS
Extreme(70°C)		7.48	3.23	1.57	0.00398	0.00172	0.00083	PASS
Extreme(60°C)		17.40	10.05	2.25	0.00926	0.00534	0.00120	PASS
Extreme(50°C)		3.41	15.60	8.30	0.00181	0.00830	0.00441	PASS
Extreme(40°C)		10.38	10.56	1.22	0.00552	0.00562	0.00065	PASS
Extreme(30°C)		11.25	10.55	14.59	0.00598	0.00561	0.00776	PASS
Extreme(20°C)		5.15	5.25	1.23	0.00274	0.00279	0.00066	PASS
Extreme(10°C)		15.07	11.51	9.16	0.00802	0.00612	0.00487	PASS
Extreme(0°C)		2.35	7.41	12.37	0.00125	0.00394	0.00658	PASS
Extreme(-10°C)		3.90	3.83	16.62	0.00207	0.00204	0.00884	PASS
Extreme(-20°C)		16.70	15.23	6.70	0.00889	0.00810	0.00356	PASS
Extreme(-30°C)		6.87	3.10	17.75	0.00366	0.00165	0.00944	PASS
Extreme(-40°C)		7.48	3.23	1.57	0.00398	0.00172	0.00083	PASS
25°C		LV	16.64	4.72	14.94	0.00885	0.00251	0.00795
	HV	6.07	1.62	4.19	0.00323	0.00086	0.00223	PASS
Condition		Freq. Error (Hz)	Freq. Error (Hz)	Freq. Error (Hz)	Frequency Stability (ppm)	Frequency Stability (ppm)	Frequency Stability (ppm)	Verdict
BANDWIDTH	10MHz	(Hz)	(Hz)	(Hz)	(ppm)	(ppm)	(ppm)	
Temperature	Voltage	64QAM	16QAM	QPSK	64QAM	16QAM	QPSK	
Normal(25°C)	Normal	1.92	3.46	4.21	0.00102	0.00184	0.00224	PASS
Extreme(70°C)		14.62	7.71	4.29	0.00777	0.00410	0.00228	PASS
Extreme(60°C)		16.08	9.44	8.93	0.00855	0.00502	0.00475	PASS
Extreme(50°C)		2.08	15.20	9.69	0.00111	0.00808	0.00516	PASS
Extreme(40°C)		15.06	16.67	4.34	0.00801	0.00887	0.00231	PASS
Extreme(30°C)		12.76	13.07	8.33	0.00679	0.00695	0.00443	PASS
Extreme(20°C)		13.41	14.72	6.52	0.00713	0.00783	0.00347	PASS
Extreme(10°C)		12.55	5.14	17.73	0.00667	0.00273	0.00943	PASS
Extreme(0°C)		4.30	10.35	4.43	0.00229	0.00551	0.00236	PASS
Extreme(-10°C)		5.53	9.25	5.52	0.00294	0.00492	0.00294	PASS
Extreme(-20°C)		13.46	6.11	8.54	0.00716	0.00325	0.00454	PASS
Extreme(-30°C)		1.92	3.46	4.21	0.00102	0.00184	0.00224	PASS
Extreme(-40°C)		14.62	7.71	4.29	0.00777	0.00410	0.00228	PASS
25°C		LV	7.05	14.58	4.75	0.00375	0.00776	0.00253
	HV	13.98	8.92	14.67	0.00744	0.00474	0.00780	PASS



Condition		Freq. Error (Hz)	Freq. Error (Hz)	Freq. Error (Hz)	Frequency Stability (ppm)	Frequency Stability (ppm)	Frequency Stability (ppm)	Verdict
BANDWIDTH	15MHz	(Hz)	(Hz)	(Hz)	(ppm)	(ppm)	(ppm)	
Temperature	Voltage	64QAM	16QAM	QPSK	64QAM	16QAM	QPSK	
Normal(25°C)	Normal	8.15	14.55	9.21	0.00433	0.00774	0.00490	PASS
Extreme(70°C)		9.22	14.72	13.78	0.00490	0.00783	0.00733	PASS
Extreme(60°C)		2.05	2.83	14.08	0.00109	0.00150	0.00749	PASS
Extreme(50°C)		6.54	15.40	17.82	0.00348	0.00819	0.00948	PASS
Extreme(40°C)		5.53	15.71	11.92	0.00294	0.00836	0.00634	PASS
Extreme(30°C)		12.69	16.71	9.76	0.00675	0.00889	0.00519	PASS
Extreme(20°C)		12.04	10.07	6.02	0.00641	0.00535	0.00320	PASS
Extreme(10°C)		10.11	15.99	15.41	0.00538	0.00850	0.00820	PASS
Extreme(0°C)		4.96	5.85	3.39	0.00264	0.00311	0.00180	PASS
Extreme(-10°C)		4.11	7.23	5.49	0.00219	0.00385	0.00292	PASS
Extreme(-20°C)		16.19	17.03	12.56	0.00861	0.00906	0.00668	PASS
Extreme(-30°C)		8.15	14.55	9.21	0.00433	0.00774	0.00490	PASS
Extreme(-40°C)		9.22	14.72	13.78	0.00490	0.00783	0.00733	PASS
25°C		LV	15.75	2.24	3.18	0.00838	0.00119	0.00169
	HV	5.65	12.84	15.91	0.00300	0.00683	0.00846	PASS
Condition		Freq. Error (Hz)	Freq. Error (Hz)	Freq. Error (Hz)	Frequency Stability (ppm)	Frequency Stability (ppm)	Frequency Stability (ppm)	Verdict
BANDWIDTH	20MHz	(Hz)	(Hz)	(Hz)	(ppm)	(ppm)	(ppm)	
Temperature	Voltage	64QAM	16QAM	QPSK	64QAM	16QAM	QPSK	
Normal(25°C)	Normal	16.78	15.07	12.95	0.00893	0.00802	0.00689	PASS
Extreme(70°C)		10.56	15.57	3.76	0.00562	0.00828	0.00200	PASS
Extreme(60°C)		5.23	2.34	1.86	0.00278	0.00124	0.00099	PASS
Extreme(50°C)		9.16	16.10	10.57	0.00487	0.00857	0.00562	PASS
Extreme(40°C)		12.84	10.00	15.83	0.00683	0.00532	0.00842	PASS
Extreme(30°C)		12.99	1.47	8.01	0.00691	0.00078	0.00426	PASS
Extreme(20°C)		5.40	16.59	12.16	0.00287	0.00882	0.00647	PASS
Extreme(10°C)		9.85	2.27	16.26	0.00524	0.00121	0.00865	PASS
Extreme(0°C)		15.91	3.36	3.54	0.00846	0.00179	0.00188	PASS
Extreme(-10°C)		7.00	1.24	5.50	0.00373	0.00066	0.00293	PASS
Extreme(-20°C)		5.46	10.05	6.85	0.00290	0.00534	0.00364	PASS
Extreme(-30°C)		16.78	15.07	12.95	0.00893	0.00802	0.00689	PASS
Extreme(-40°C)		10.56	15.57	3.76	0.00562	0.00828	0.00200	PASS
25°C		LV	3.13	15.48	15.50	0.00167	0.00824	0.00824
	HV	14.19	17.73	10.35	0.00755	0.00943	0.00551	PASS

5.7. Spurious Emissions at Antenna Terminals

Ambient condition

Temperature	Relative humidity	Pressure
23°C ~25°C	45%~50%	101.5kPa

Method of Measurement

The testing follows FCC KDB 971168 D01 v03r01 Section 6.0.

1. The EUT was connected to spectrum analyzer and system simulator via a power divider.
2. The RF output of EUT was connected to the spectrum analyzer by RF cable and attenuator. The path loss was compensated to the results for each measurement.
3. The middle channel for the highest RF power within the transmitting frequency was measured.
4. The conducted spurious emission for the whole frequency range was taken.
5. Make the measurement with the spectrum analyzer's
 - RBW is set to 1 kHz (0.009MHz~ 0.15 MHz),
 - RBW is set to 10 kHz (0.15 MHz~ 30 MHz)
 - RBW is set to 100 kHz (30MHz~1000 MHz)
 - RBW is set to 1000 kHz (above 1000MHz).
6. Set spectrum analyzer with RMS detector.
7. Taking the record of maximum spurious emission.
8. The RF fundamental frequency should be excluded against the limit line in the operating frequency band.
9. The limit line is -40dBm/MHz.

Test setup

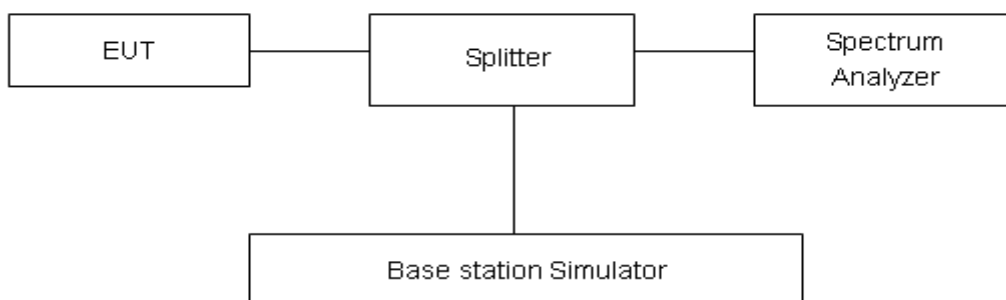

Limits

Rule Part 96.41(e) (2) *Additional protection levels*. Notwithstanding paragraph (e)(1) of this section, for CBSDs and End User Devices, the conducted power of emissions below 3540 MHz or above 3710 MHz shall not exceed -25 dBm/MHz, and the conducted power of emissions below 3530 MHz or above 3720 MHz shall not exceed -40dBm/MHz.

**Measurement Uncertainty**

The assessed measurement uncertainty to ensure 99.75% confidence level for the normal distribution is with the coverage factor $k = 1.96$.

Frequency	Uncertainty
100kHz-2GHz	0.684 dB
2GHz-18GHz	1.407 dB
18GHz-40GHz	1.515 dB



Test Result

If disturbances were found more than 20dB below limit line, the mark is not required for the EUT.
The signal beyond the limit is carrier.

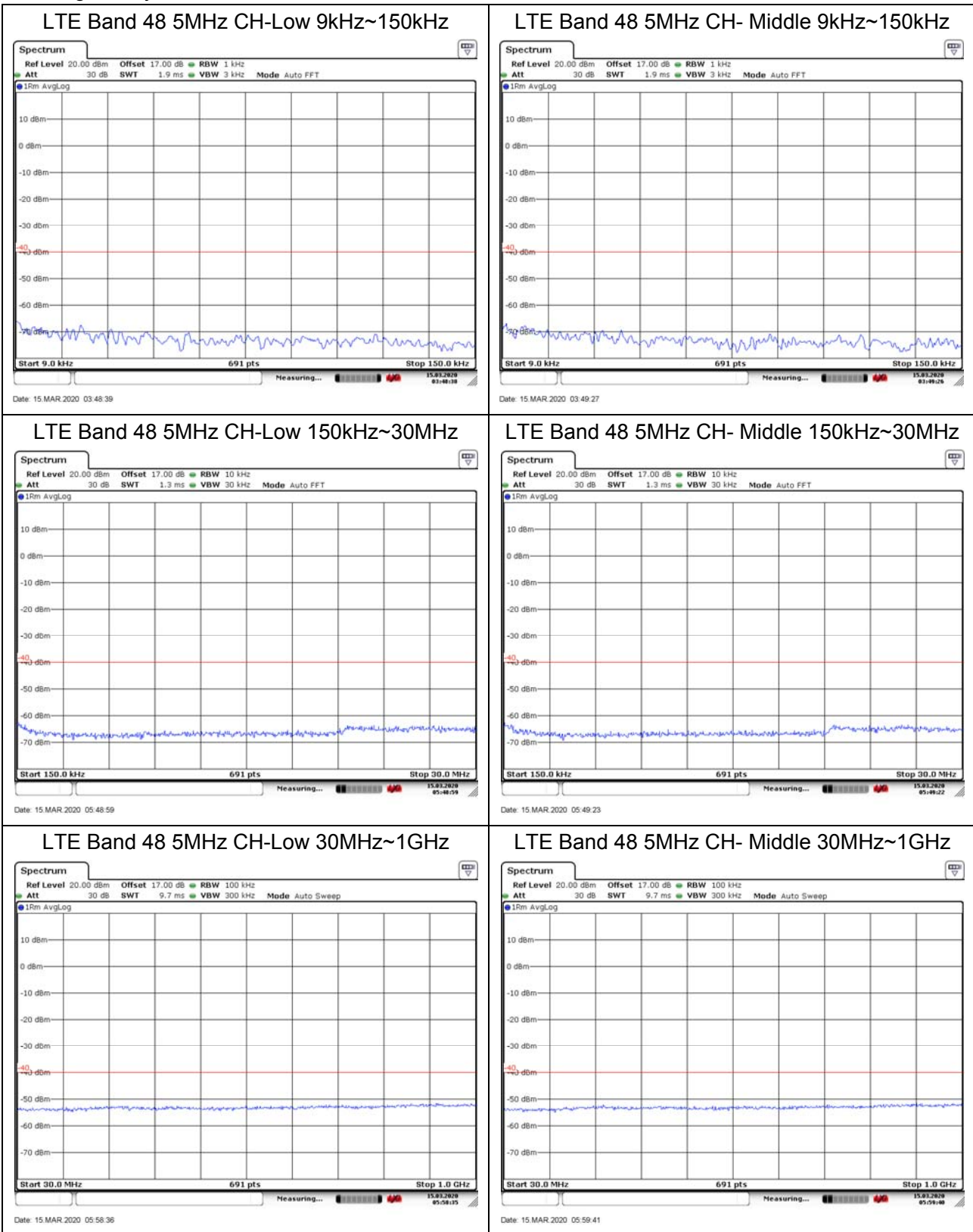

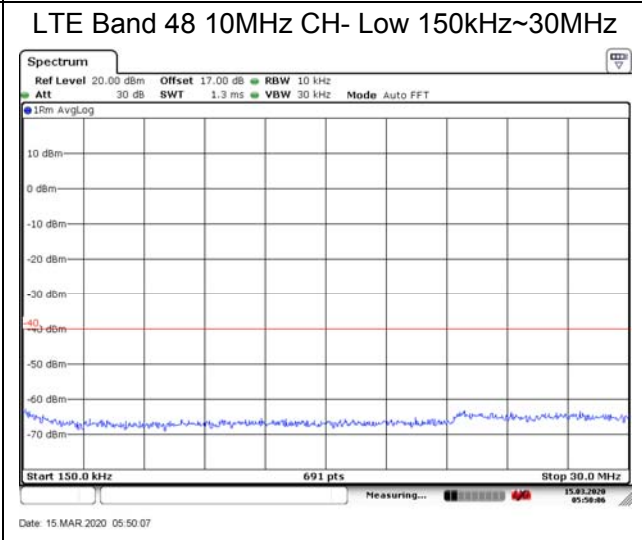
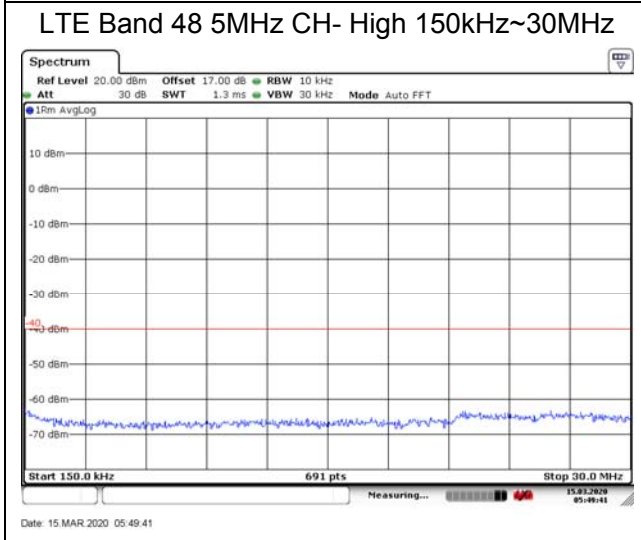
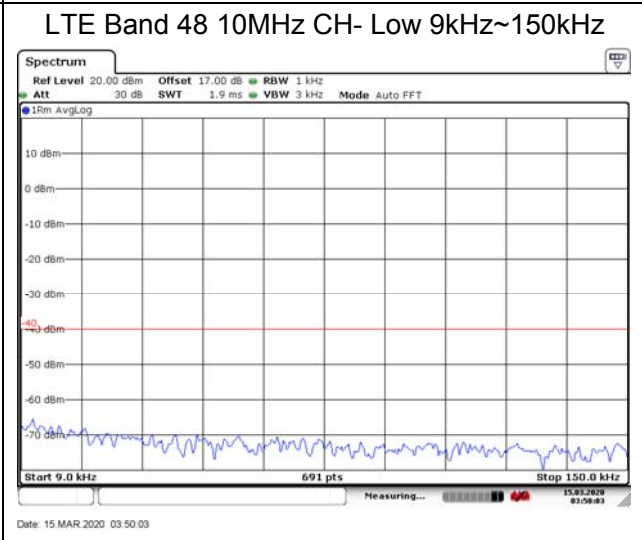
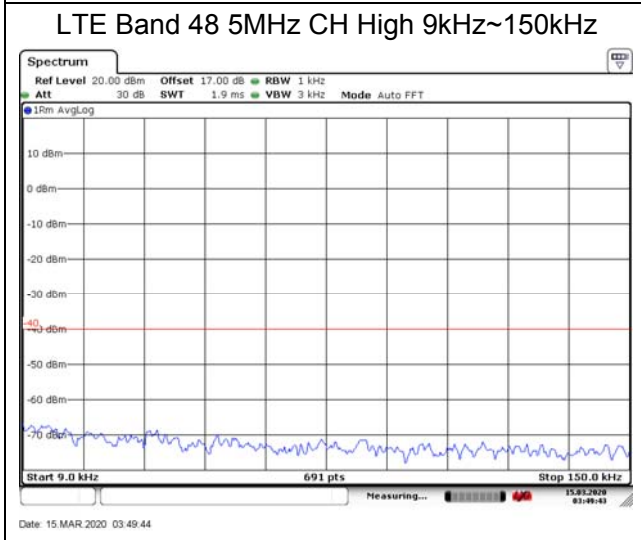
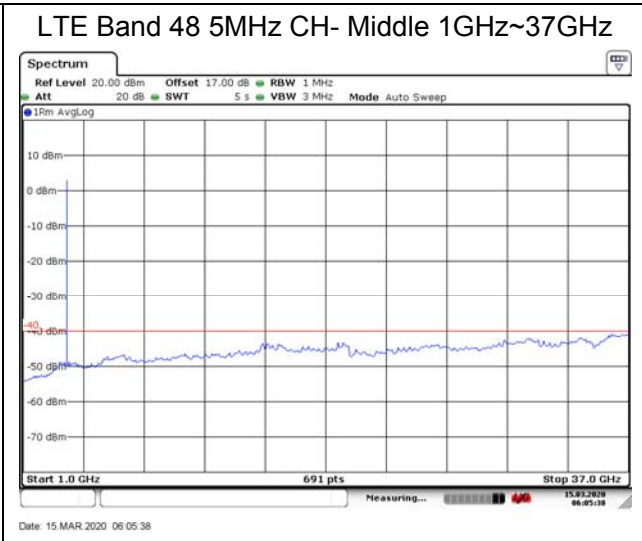
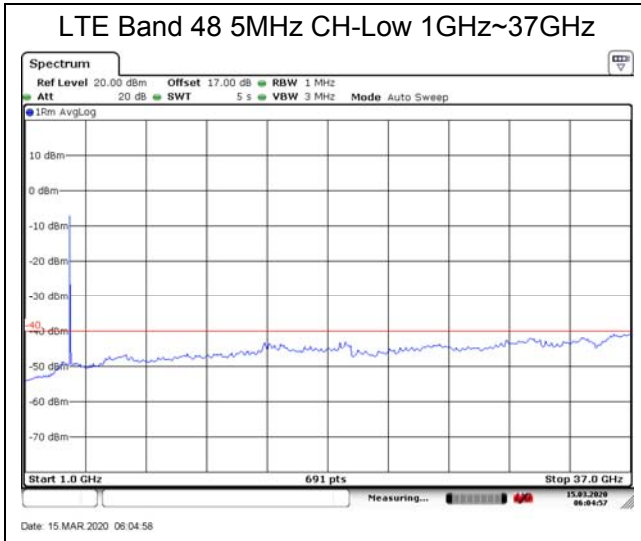

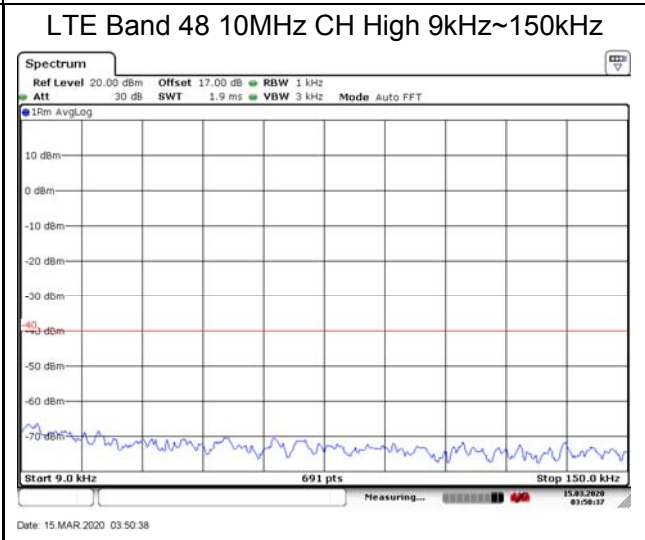
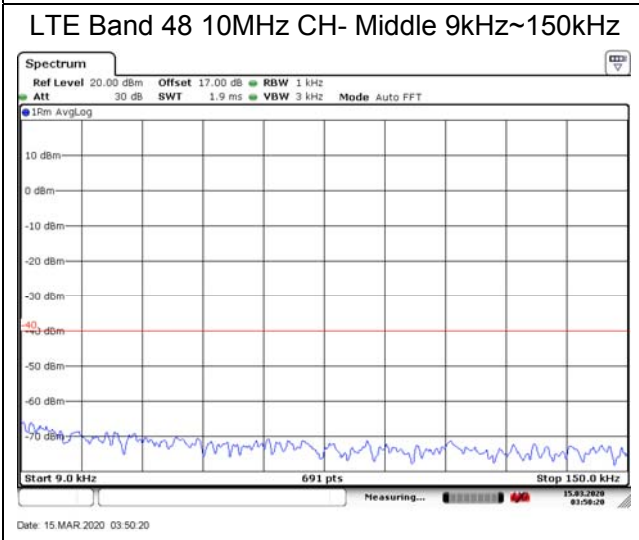
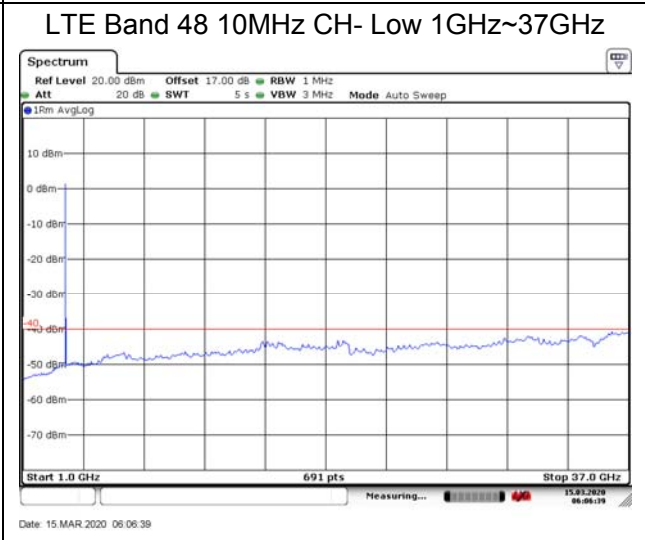
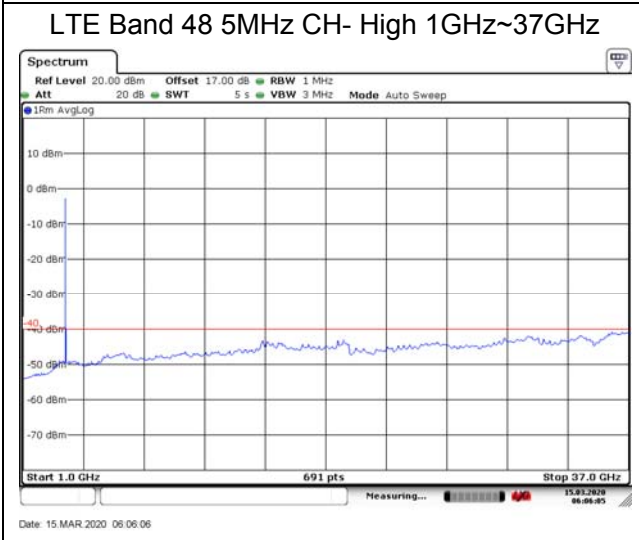
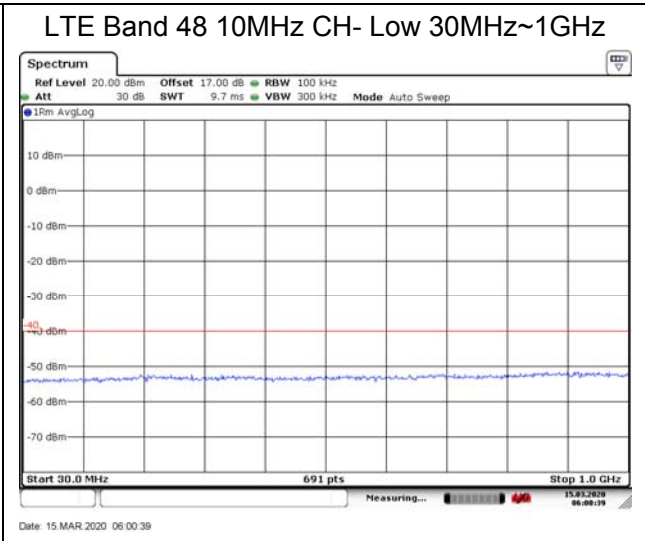
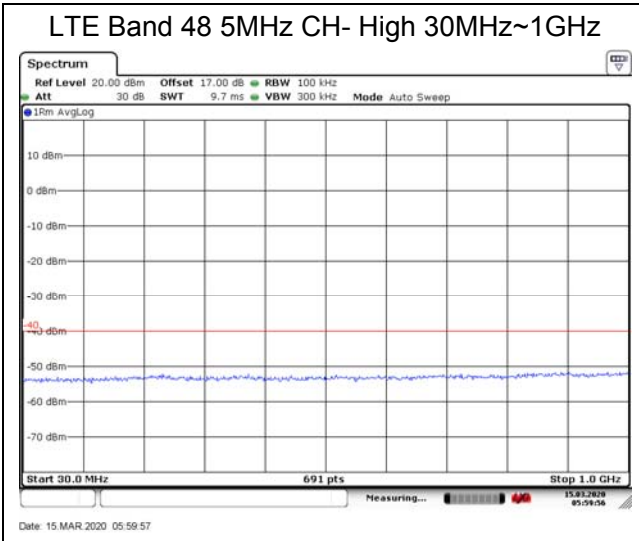

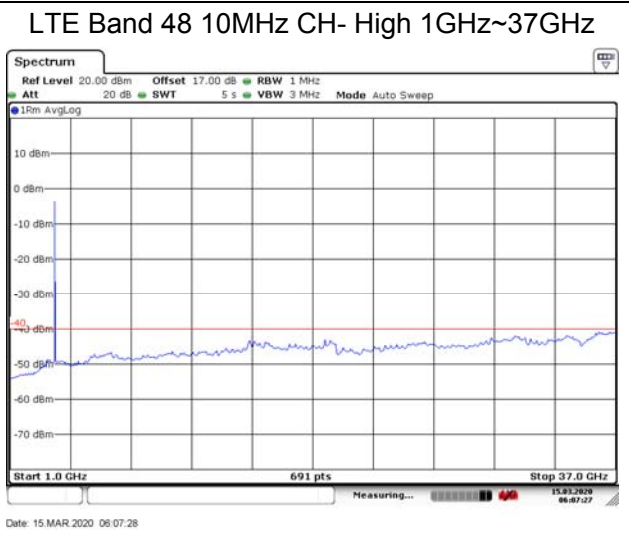
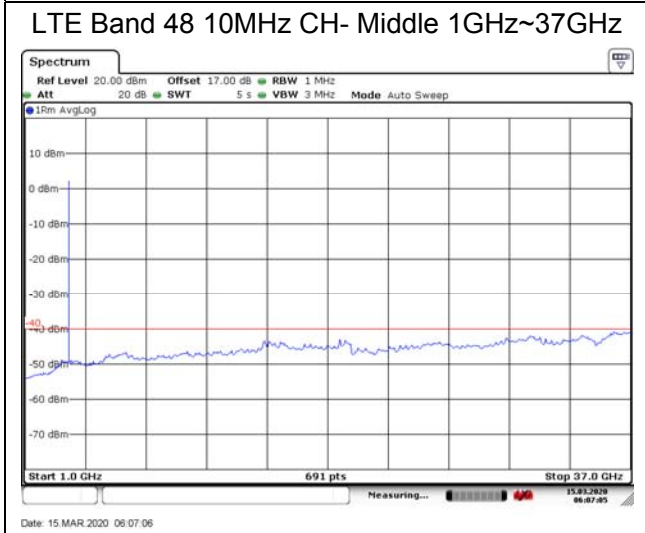
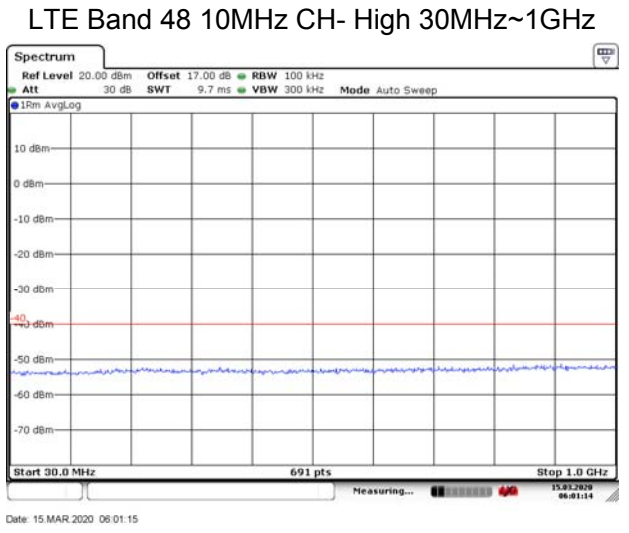
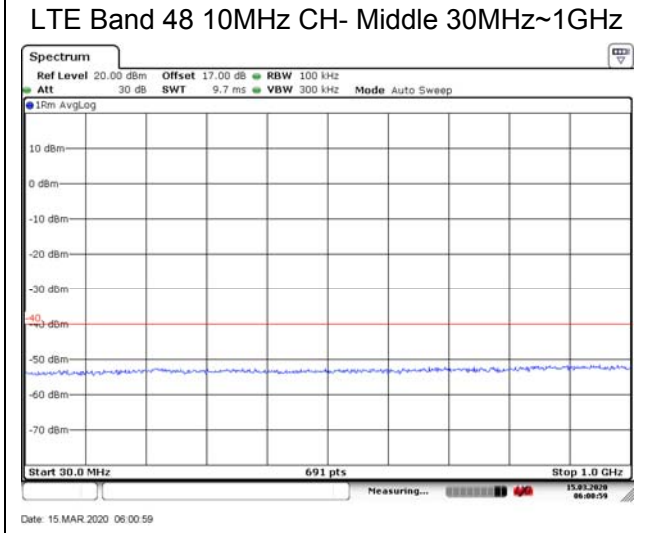
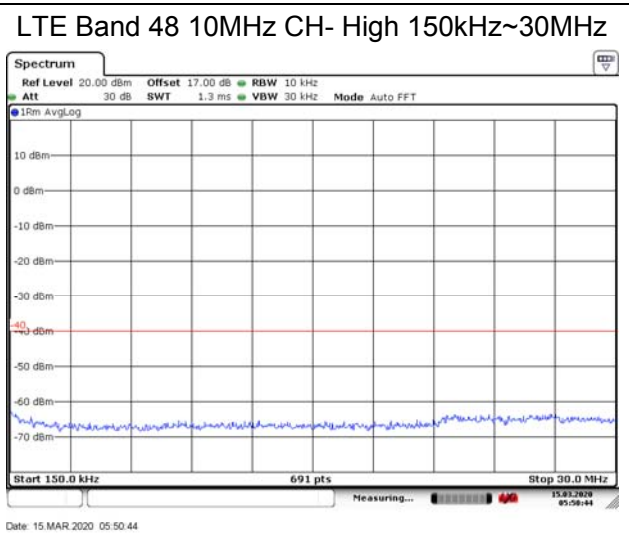
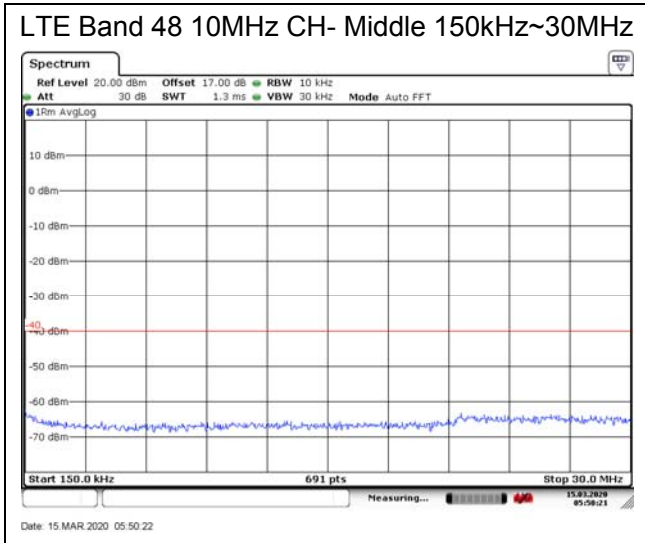

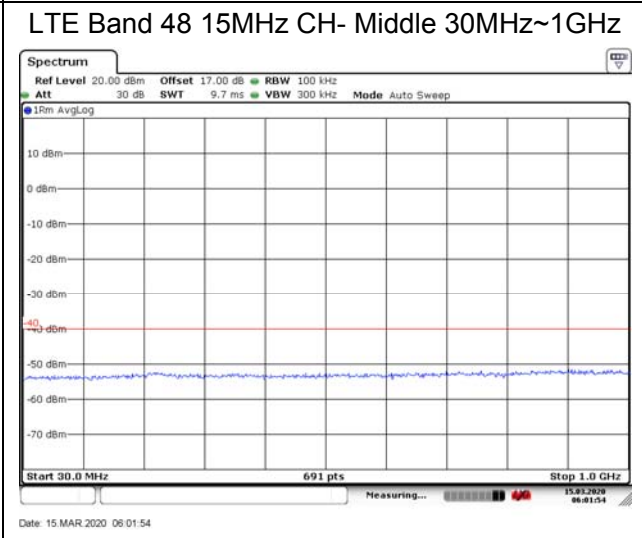
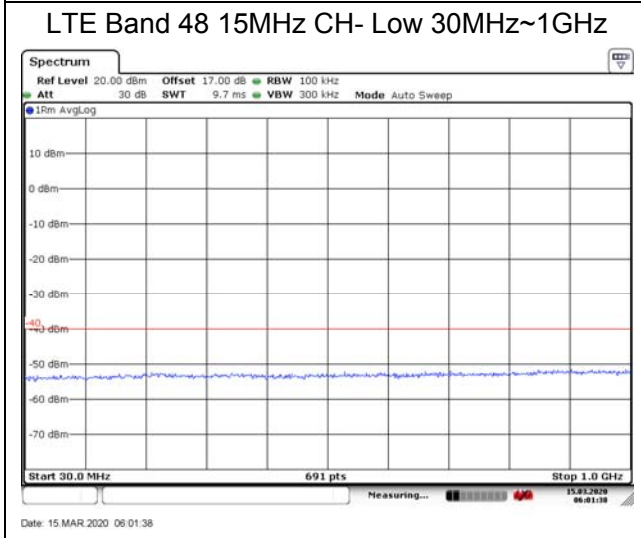
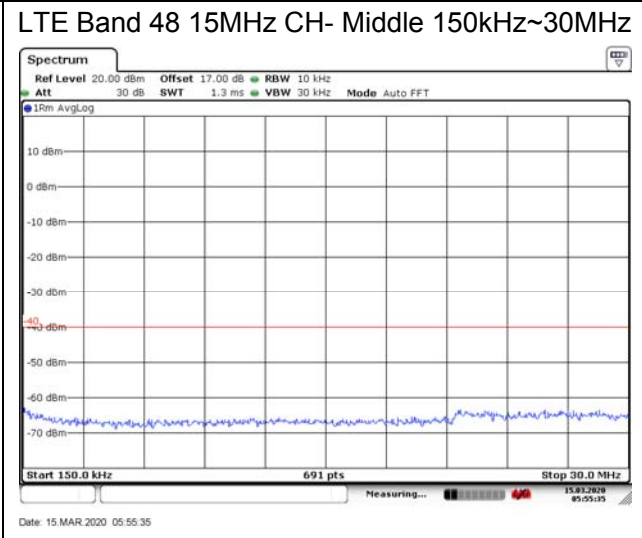
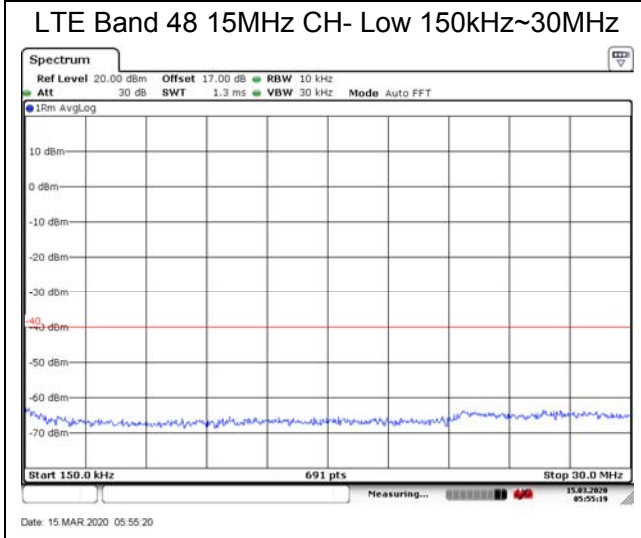
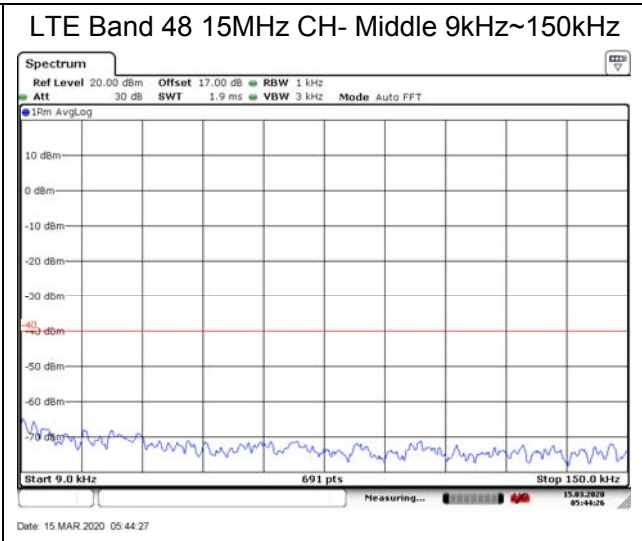
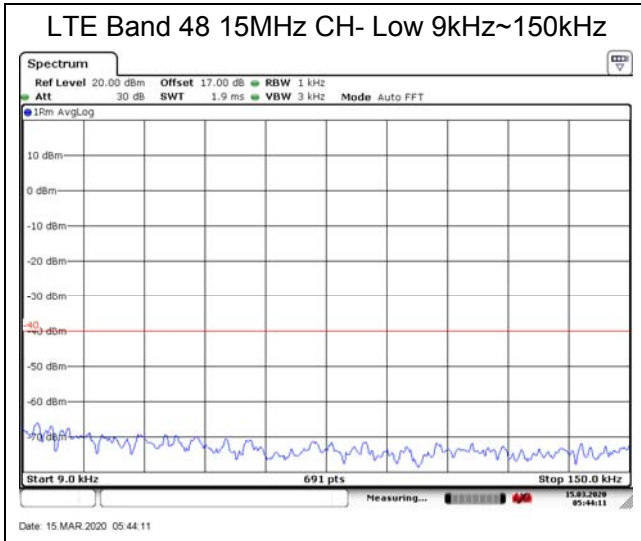



LTE Band 48 15MHz CH- Low 1GHz~37GHz

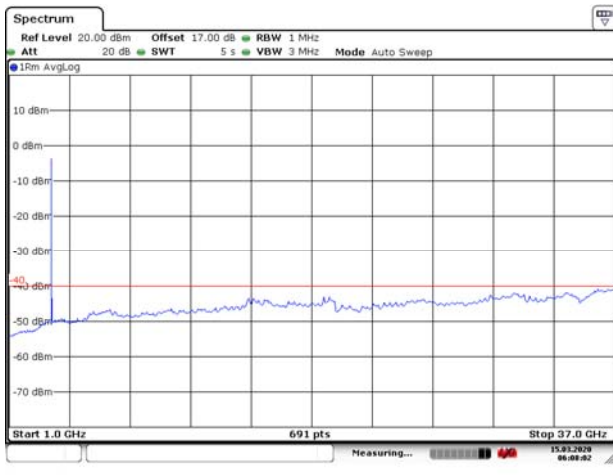

Date: 15.MAR.2020 06:08:02

LTE Band 48 15MHz CH- Middle 1GHz~37GHz

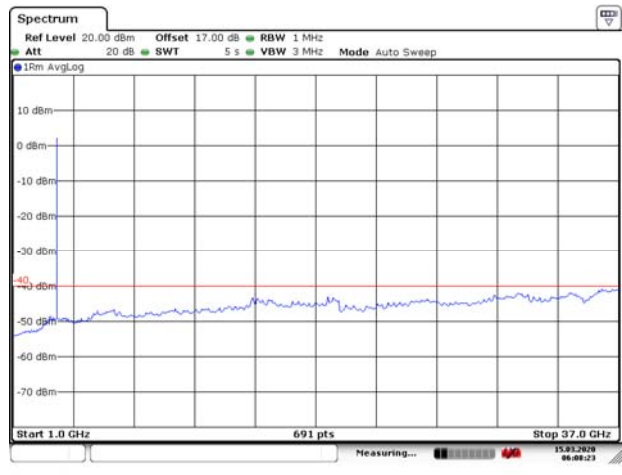

Date: 15.MAR.2020 06:08:23

LTE Band 48 15MHz CH High 9kHz~150kHz

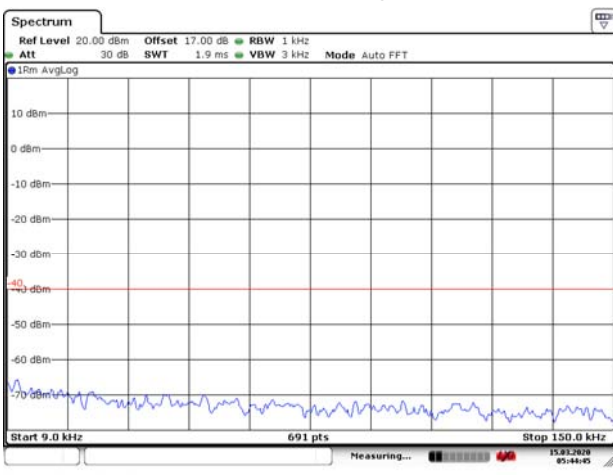

Date: 15.MAR.2020 05:44:45

LTE Band 48 20MHz CH- Low 9kHz~150kHz

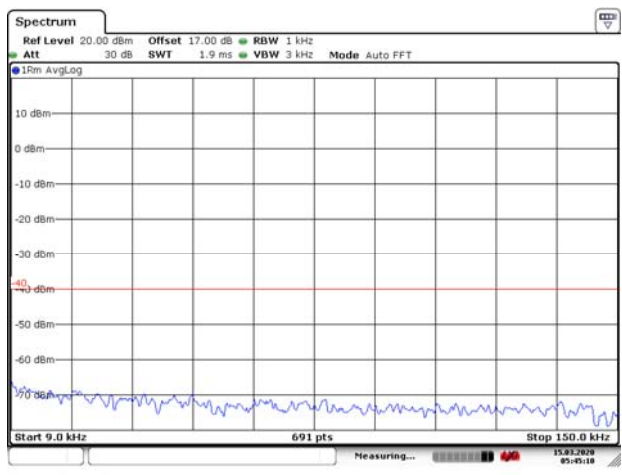

Date: 15.MAR.2020 05:45:10

LTE Band 48 15MHz CH- High 150kHz~30MHz

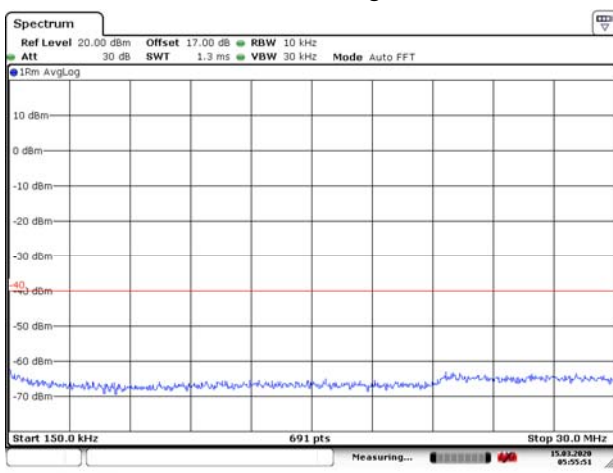

Date: 15.MAR.2020 05:55:51

LTE Band 48 20MHz CH- Low 150kHz~30MHz

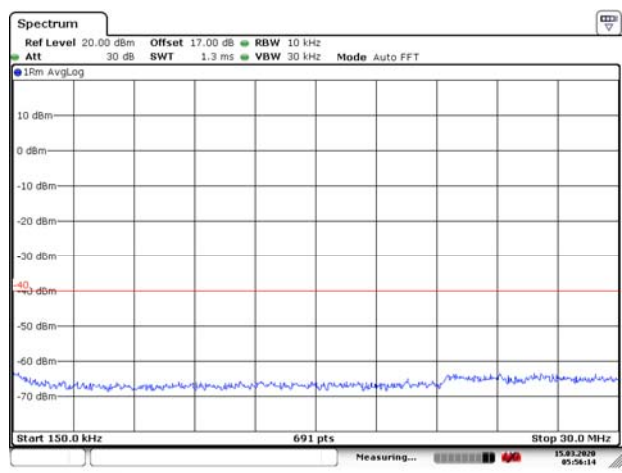

Date: 15.MAR.2020 05:56:14

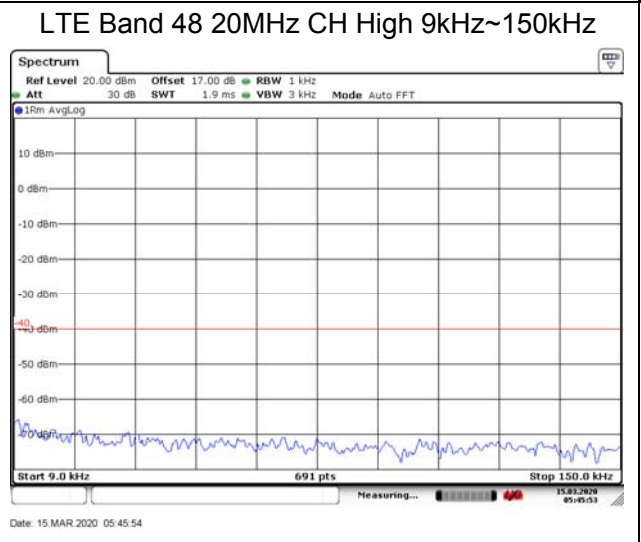
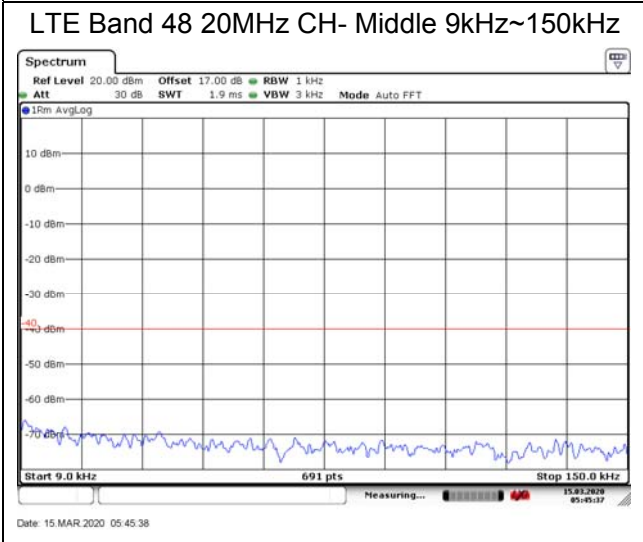
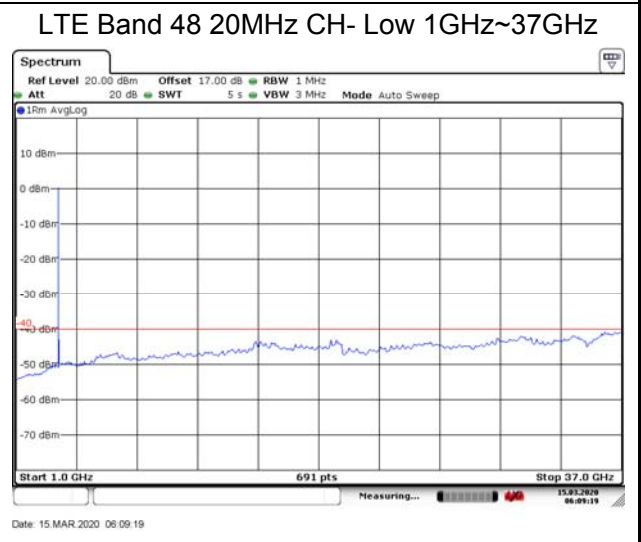
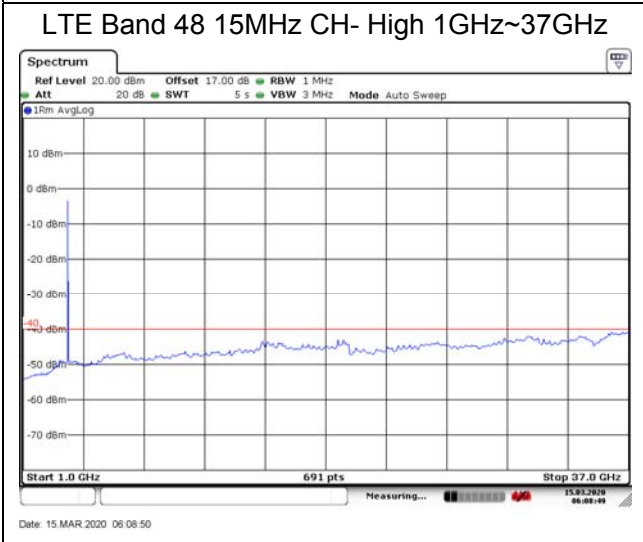
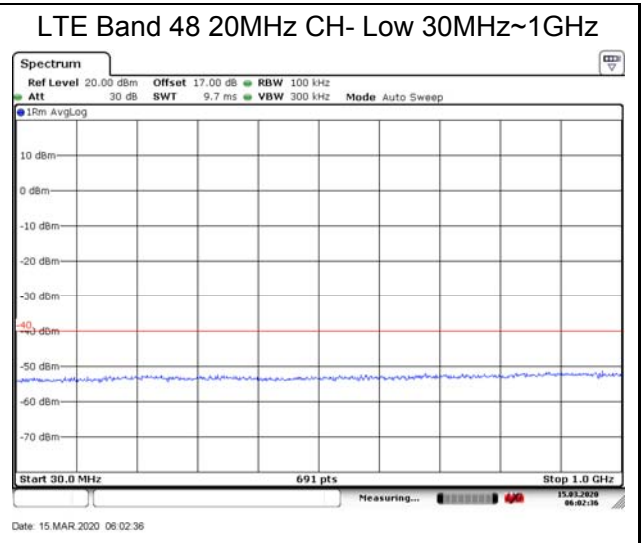
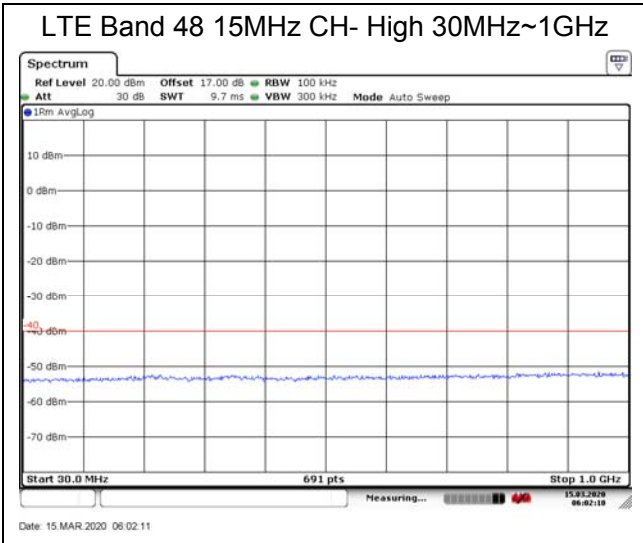

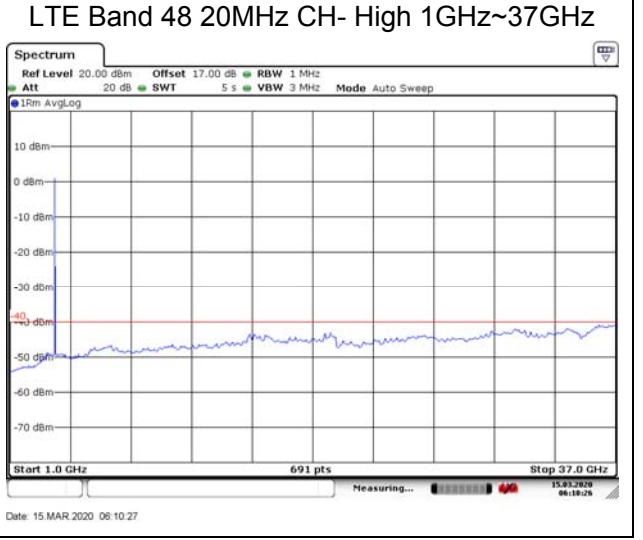
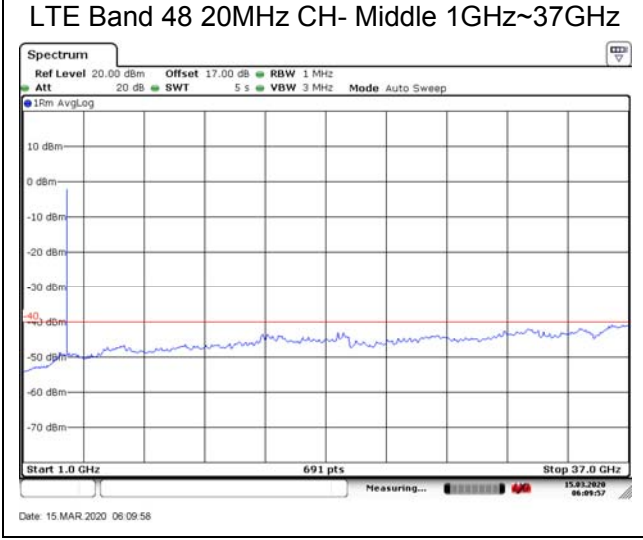
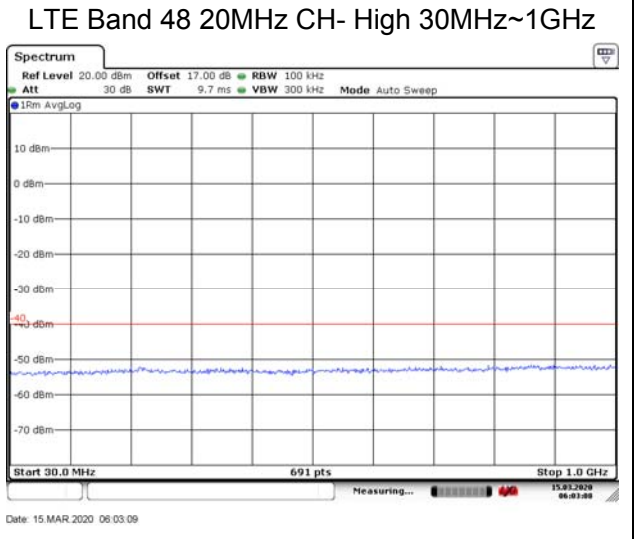
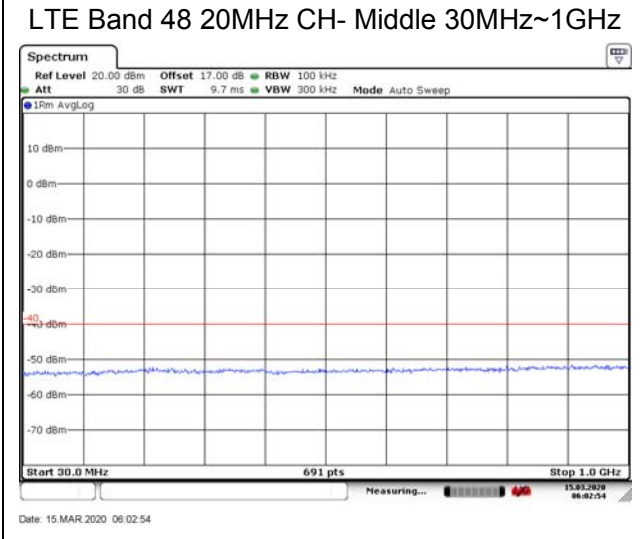
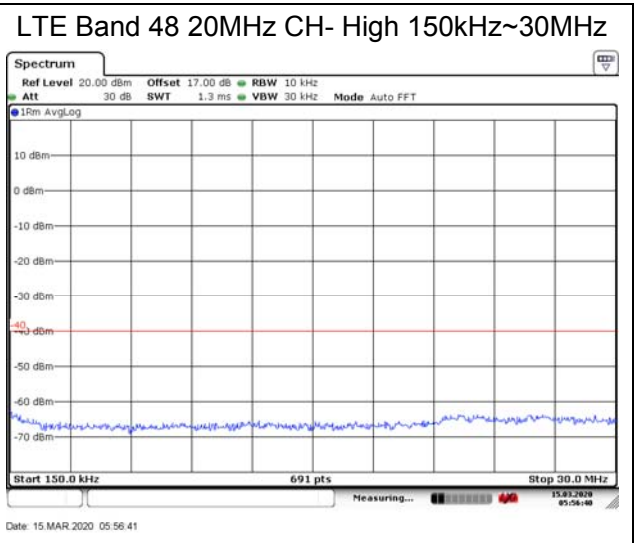
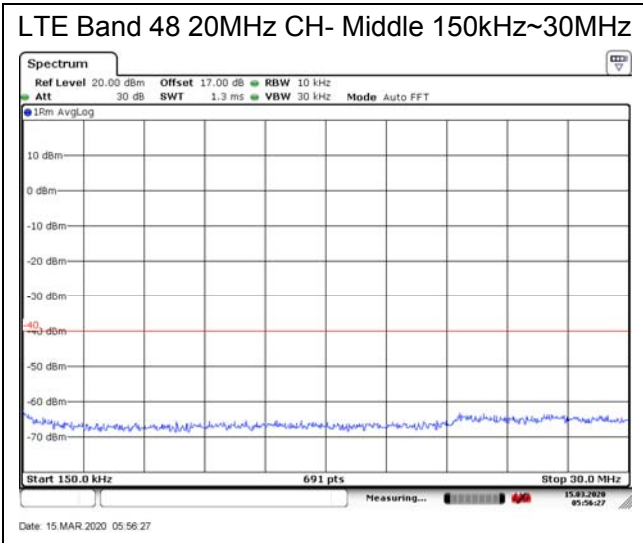

5.8. Radiates Spurious Emission

Ambient condition

Temperature	Relative humidity	Pressure
23°C ~25°C	45%~50%	101.5kPa

Method of Measurement

1. The testing follows FCC KDB 971168 D01 v03r01 Section 5.8 and ANSI C63.26 (2015).
2. Below 1GHz: The EUT is placed on a turntable 0.8 meters above the ground in the chamber, 3 meter away from the antenna. The maximal emission value is acquired by adjusting the antenna height, polarisation and turntable azimuth. Normally, the height range of antenna is 1 m to 4 m, the azimuth range of turntable is 0° to 360°, and the receive antenna has two polarizations Vertical (V) and Horizontal (H). Above 1GHz: (Note: the FCC's permission to use 1.5m as an alternative per TCBC Conf call of Dec. 2, 2014.) The EUT is placed on a turntable 1.5 meters above the ground in the chamber, 3 meter away from the antenna. The maximal emission value is acquired by adjusting the antenna height, polarisation and turntable azimuth. Normally, the height range of antenna is 1 m to 4 m, the azimuth range of turntable is 0° to 360°, and the receive antenna has two polarizations Vertical (V) and Horizontal (H).
3. A loop antenna, A log-periodic antenna or horn antenna shall be substituted in place of the EUT. The log-periodic antenna will be driven by a signal generator and the level will be adjusted till the same power value on the spectrum analyzer or receiver. The level of the spurious emissions can be calculated through the level of the signal generator, cable loss, the gain of the substitution antenna and the reading of the spectrum analyzer or receiver.
4. The EUT is then put into continuously transmitting mode at its maximum power level during the test. Set Test Receiver or Spectrum RBW=200Hz,VBW=600Hz for 9kHz150kHz , RBW=10kHz, VBW=30kHz 150kHz-30MHz ,RBW=100kHz,VBW=300kHz for 30MHz to 1GHz and RBW=1MHz, VBW=3MHz for above 1GHz And the maximum value of the receiver should be recorded as (Pr).
5. The EUT shall be replaced by a substitution antenna. In the chamber, an substitution antenna for the frequency band of interest is placed at the reference point of the chamber. An RF Signal source for the frequency band of interest is connected to the substitution antenna with a cable that has been constructed to not interfere with the radiation pattern of the antenna. A power (PMea) is applied to the input of the substitution antenna, and adjust the level of the signal generator output until the value of the receiver reach the previously recorded (Pr). The power of signal source (PMea) is recorded. The test should be performed by rotating the test item and adjusting the receiving antenna polarization.
6. A amplifier should be connected to the Signal Source output port. And the cable should be connect between the Amplifier and the Substitution Antenna. The cable loss (Pcl) ,the Substitution Antenna Gain (Ga) and the Amplifier Gain (PAg) should be recorded after test.
7. The measurement results are obtained as described below:
Power(EIRP)=PMea- PAg - Pcl + Ga
The measurement results are amend as described below:
Power(EIRP)=PMea- Pcl + Ga
8. This value is EIRP since the measurement is calibrated using an antenna of known gain (2.15 dBi)

and known input power. ERP can be calculated from EIRP by subtracting the gain of the dipole, $ERP = EIRP - 2.15\text{dBi}$.

The modulation mode and RB allocation refer to section 5.1, using the maximum output power configuration.

Test setup

30MHz~~~ 1GHz

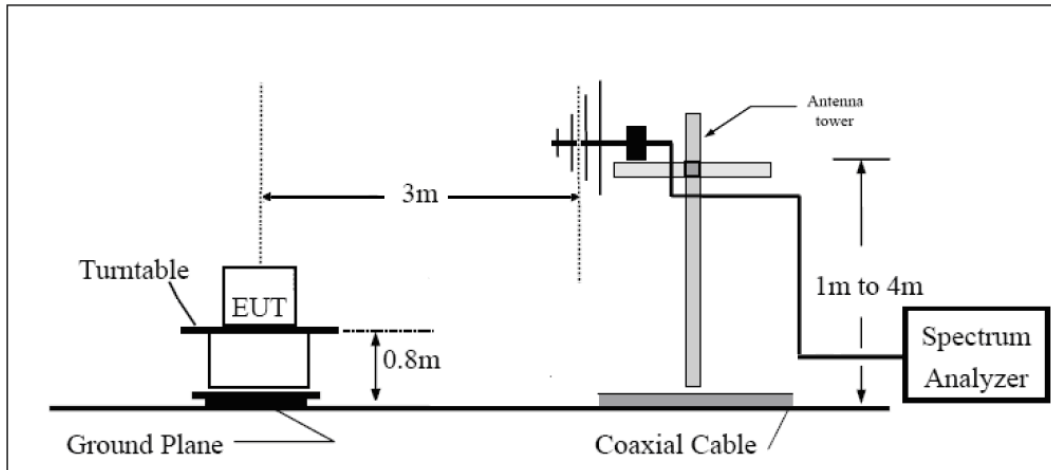

Above 1GHz

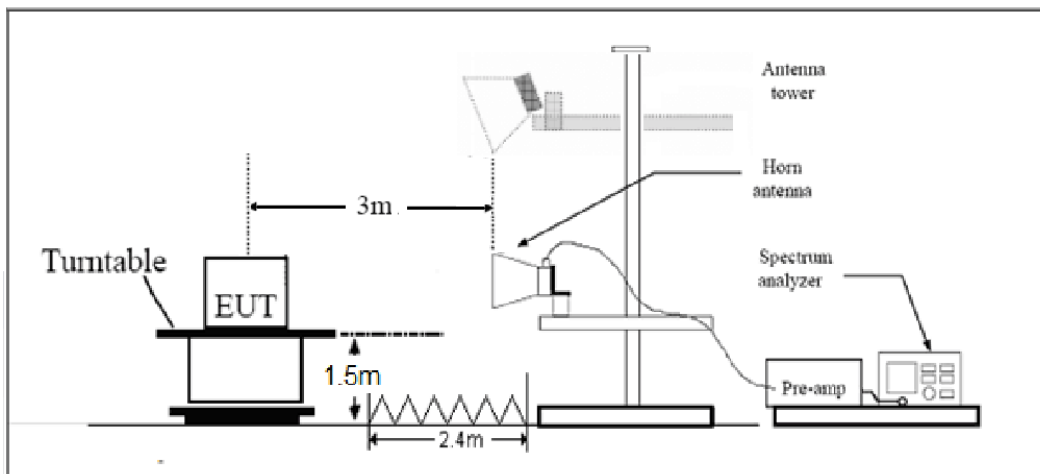

Note: Area side:2.4mX3.6m

Limits

Rule Part 96.41(e) (2) specifies that “*Additional protection levels.* Notwithstanding paragraph (e)(1) of this section, for CBSDs and End User Devices, the conducted power of emissions below 3540 MHz or above 3710 MHz shall not exceed -25 dBm/MHz , and the conducted power of emissions below 3530 MHz or above 3720 MHz shall not exceed -40dBm/MHz .”

Measurement Uncertainty

The assessed measurement uncertainty to ensure 95% confidence level for the normal distribution is with the coverage factor $k = 1.96$, $U = 3.55\text{ dB}$.

**Test Result**

LTE Band 48 QPSK 5MHz CH-Middle, RB 1

Harmonic	Frequency (MHz)	SG (dBm)	Cable Loss (dB)	Gain (dBi)	Antenna Polarization	EIRP Level (dBm)	Limit (dBm)	Margin (dB)	Azimuth (deg)
2	7345.5	-55.43	2.6	10.75	Horizontal	-47.28	-40.00	7.28	315
3	11019.0	-63.50	2.4	11.05	Horizontal	-54.85	-40.00	14.85	225
4	14691.0	-59.86	4.5	11.15	Horizontal	-53.21	-40.00	13.21	135
5	18125.0	--	--	--	--	--	--	--	--
6	21750.0	--	--	--	--	--	--	--	--
7	25375.0	--	--	--	--	--	--	--	--
8	29000.0	--	--	--	--	--	--	--	--
9	32625.0	--	--	--	--	--	--	--	--
10	36250.0	--	--	--	--	--	--	--	--

Note: 1.The other Spurious RF Radiated emissions level is no more than noise floor.
2. The worst emission was found in the antenna is Horizontal position.

LTE Band 48 QPSK 20MHz CH-Middle, RB 1

Harmonic	Frequency (MHz)	SG (dBm)	Cable Loss (dB)	Gain (dBi)	Antenna Polarization	EIRP Level (dBm)	Limit (dBm)	Margin (dB)	Azimuth (deg)
2	7332.0	-54.30	2.6	10.75	Horizontal	-46.15	-40.00	6.15	135
3	10998.8	-61.18	2.4	11.05	Horizontal	-52.53	-40.00	12.53	45
4	14664.0	-58.42	4.5	11.15	Horizontal	-51.77	-40.00	11.77	180
5	18125.0	--	--	--	--	--	--	--	--
6	21750.0	--	--	--	--	--	--	--	--
7	25375.0	--	--	--	--	--	--	--	--
8	29000.0	--	--	--	--	--	--	--	--
9	32625.0	--	--	--	--	--	--	--	--
10	36250.0	--	--	--	--	--	--	--	--

Note: 1.The other Spurious RF Radiated emissions level is no more than noise floor.
2. The worst emission was found in the antenna is Horizontal position.



6.

Main Test Instruments

Name	Manufacturer	Type	Serial Number	Calibration Date	Expiration Date
Base Station Simulator	R&S	CMW500	113824	2019-05-19	2020-05-18
Power Splitter	Hua Xiang	SHX-GF2-2-13	10120101	/	/
Spectrum Analyzer	Key sight	N9010A	MY50210259	2019-05-19	2020-05-18
Signal Analyzer	R&S	FSV30	100815	2019-12-16	2020-12-15
Loop Antenna	SCHWARZBECK	FMZB1519	1519-047	2017-09-26	2020-09-25
Trilog Antenna	SCHWARZBECK	VUBL 9163	9163-201	2017-11-18	2020-11-17
Horn Antenna	R&S	HF907	100126	2018-07-07	2020-07-06
Horn Antenna	ETS-Lindgren	3160-09	00102643	2018-06-20	2020-06-19
Horn Antenna	STEATITE	QSH-SL-26-40-K-15	16779	2017-07-20	2020-07-19
Signal generator	R&S	SMB 100A	102594	2019-05-19	2020-05-18
Climatic Chamber	ESPEC	SU-242	93000506	2017-12-17	2020-12-16
Preamplifier	R&S	SCU18	102327	2019-05-19	2020-05-18
MOB COMMS DC SUPPLY	Keysight	66319D	MY43004105	2019-05-19	2020-05-18
RF Cable	Agilent	SMA 15cm	0001	2019-12-13	2020-12-12
Software	R&S	EMC32	9.26.0	/	/

*****END OF REPORT *****