



RF TEST REPORT

Applicant Smawave Technology Co. ,Ltd
FCC ID 2AU8HSRT011
Product Router
Brand Smawave
Model SRM310; SRT011
Report No. R2109A0784-R1
Issue Date October 26, 2021

TA Technology (Shanghai) Co., Ltd. tested the above equipment in accordance with the requirements in **FCC CFR47 Part 15C (2020)**. The test results show that the equipment tested is capable of demonstrating compliance with the requirements as documented in this report.

Prepared by: Peng Tao

Approved by: Kai Xu

TA Technology (Shanghai) Co., Ltd.

No.145, Jintang Rd, Tangzhen Industry Park, Pudong Shanghai, China

TEL: +86-021-50791141/2/3

FAX: +86-021-50791141/2/3-8000



TABLE OF CONTENT

1. Test Laboratory	4
1.1. Notes of the test report.....	4
1.2. Test facility	4
1.3. Testing Location.....	4
2. General Description of Equipment under Test.....	5
2.1. Applicant and Manufacturer Information.....	5
2.2. General information.....	5
3. Applied Standards	6
4. Test Configuration	7
5. Test Case Results	8
5.1. Maximum output power	8
5.2. 99% Bandwidth and 6dB Bandwidth	12
5.3. Band Edge	18
5.4. Power Spectral Density	20
5.5. Spurious RF Conducted Emissions.....	32
5.6. Unwanted Emission	40
5.7. Conducted Emission	74
6. Main Test Instruments.....	77
ANNEX A: The EUT Appearance	78
ANNEX B: Test Setup Photos	79



Summary of measurement results

Number	Test Case	Clause in FCC rules	Verdict
1	Maximum output power	15.247(b)(3)	PASS
2	6 dB bandwidth	15.247(a)(2)	PASS
3	Power spectral density	15.247(e)	PASS
4	Band Edge	15.247(d)	PASS
5	Spurious RF Conducted Emissions	15.247(d)	PASS
6	Unwanted Emissions	15.247(d),15.205,15.209	PASS
7	Conducted Emissions	15.207	PASS

Date of Testing: September 6, 2021 ~ September 20, 2021
Date of Sample Received: September 1, 2021

Note: All indications of Pass/Fail in this report are opinions expressed by TA Technology (Shanghai) Co., Ltd. based on interpretations and/or observations of test results. Measurement Uncertainties were not taken into account and are published for informational purposes only.



1. Test Laboratory

1.1. Notes of the test report

This report shall not be reproduced in full or partial, without the written approval of **TA technology (shanghai) co., Ltd.** The results documented in this report apply only to the tested sample, under the conditions and modes of operation as described herein .Measurement Uncertainties were not taken into account and are published for informational purposes only. This report is written to support regulatory compliance of the applicable standards stated above.

1.2. Test facility

FCC (Designation number: CN1179, Test Firm Registration Number: 446626)

TA Technology (Shanghai) Co., Ltd. has been listed on the US Federal Communications Commission list of test facilities recognized to perform measurements.

A2LA (Certificate Number: 3857.01)

TA Technology (Shanghai) Co., Ltd. has been listed by American Association for Laboratory Accreditation to perform measurement.

1.3. Testing Location

Company: TA Technology (Shanghai) Co., Ltd.
Address: No.145, Jintang Rd, Tangzhen Industry Park, Pudong
City: Shanghai
Post code: 201201
Country: P. R. China
Contact: Xu Kai
Telephone: +86-021-50791141/2/3
Fax: +86-021-50791141/2/3-8000
Website: <http://www.ta-shanghai.com>
E-mail: xukai@ta-shanghai.com

2. General Description of Equipment under Test

2.1. Applicant and Manufacturer Information

Applicant	Smawave Technology Co. ,Ltd
Applicant address	3/F, Building 8, 1001 North Qinzhou Road, Xuhui District, Shanghai, China
Manufacturer	Smawave Technology Co. ,Ltd
Manufacturer address	3/F, Building 8, 1001 North Qinzhou Road, Xuhui District, Shanghai, China

2.2. General information

EUT Description	
Model	SRM310; SRT011
Lob internal SN	R2109A0784/S01
Hardware Version	V1.0
Software Version	DO_STD
Power Supply	AC adapter
Antenna Type	Internal Antenna
Antenna Connector	A permanently attached antenna (meet with the standard FCC Part 15.203 requirement)
Antenna Gain	Antenna 1: 2.4dBi Antenna 2: 3.9dBi
additional beamforming gain	NA
Operating Frequency Range(s)	802.11b/g/n(HT20): 2412 ~ 2462 MHz 802.11n(HT40): 2422 ~ 2452 MHz
Modulation Type	802.11b: DSSS 802.11g/n(HT20/HT40): OFDM
Max. Conducted Power	23.93dBm
EUT Accessory	
Adapter 1	Manufacturer: TOPOW Model: TPA289B-24240-US
Adapter 2	Manufacturer: aquilstar Model: ASSA1078023
Note: 1. The EUT is sent from the applicant to TA and the information of the EUT is declared by the applicant. 2. Customer declaration, SRM310 and SRT011 are the same, except for the model name.	

3. Applied Standards

According to the specifications of the manufacturer, it must comply with the requirements of the following standards:

Test standards:

FCC CFR47 Part 15C (2020) Radio Frequency Devices

ANSI C63.10 (2013)

Reference standard:

KDB 558074 D01 15.247 Meas Guidance v05r02

KDB 662911 D01 Multiple Transmitter Output v02r01

4. Test Configuration

Test Mode

The EUT has been associated with peripherals and configuration operated in a manner tended to maximize its emission characteristics in a typical application.

The radiated emission was measured in the following position: EUT stand-up position (Z axis), lie-down position (X, Y axis). The worst emission was found in lie-down position (X axis) and the loop antenna is vertical, the others are vertical and horizontal. and the worst case was recorded.

In order to find the worst case condition, Pre-tests are needed at the presence of different data rate. Preliminary tests have been done on all the configuration for confirming worst case. Data rate below means worst-case rate of each test item.

Worst-case data rates are shown as following table.

Test Mode	Data Rate		
	Antenna 1	Antenna 2	MIMO
802.11b	1 Mbps	1 Mbps	1 Mbps
802.11g	6 Mbps	6 Mbps	6 Mbps
802.11n HT20	MCS0	MCS0	MCS8
802.11n HT40	MCS0	MCS0	MCS8

The worst case Antenna mode for each of the following tests for Wi-Fi:

Test Cases	Antenna 1	Antenna 2	CDD/MIMO
Maximum conducted output power	O	O	O
6dB Bandwidth	--	--	O
Band Edge	--	--	O
Power Spectral Density	O	O	O
Spurious RF Conducted Emissions	--	--	O
Unwanted Emissions	--	--	O
Conducted Emission	--	--	O
Note: "O": test all bands			

According to RF Output power results in chapter 5.1, MIMO was selected as the worst antenna.

5. Test Case Results

5.1. Maximum output power

Ambient condition

Temperature	Relative humidity	Pressure
23°C ~25°C	45%~50%	101.5kPa

Methods of Measurement

During the process of the testing, The EUT was connected to Power meter with a known loss. The EUT is max power transmission with proper modulation.

The conducted Power is measured at each antenna port. The measured results at the various antenna ports are then summed mathematically.

Test Setup

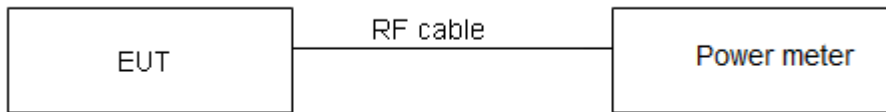

Limits

Rule Part 15.247 (b) (3) specifies that " For systems using digital modulation in the 902–928 MHz, 2400–2483.5 MHz: 1 Watt."

Average Output Power	$\leq 1W$ (30dBm)
----------------------	-------------------

Measurement Uncertainty

The assessed measurement uncertainty to ensure 95% confidence level for the normal distribution is with the coverage factor $k = 2$, $U = 0.44$ dB.



Test Results

SISO Antenna Power Index						
Antenna	Channel	802.11b	802.11g	802.11n HT20	Channel	802.11n HT40
Antenna 1	CH1	16	13.5	13.5	CH3	13
	CH6	16	13.5	13.5	CH6	13
	CH11	16	13.5	13.5	CH9	13
Antenna 2	CH1	16	13.5	13.5	CH3	13
	CH6	16	13.5	13.5	CH6	13
	CH11	16	13.5	13.5	CH9	13
MIMO Antenna Power Index						
Antenna	Channel	802.11b	802.11g	802.11n HT20	Channel	802.11n HT40
Antenna 1	CH1	16	13.5	13.5	CH3	13
	CH6	16	13.5	13.5	CH6	13
	CH11	16	13.5	13.5	CH9	13
Antenna 2	CH1	16	13.5	13.5	CH3	13
	CH6	16	13.5	13.5	CH6	13
	CH11	16	13.5	13.5	CH9	13

Test Mode	T _{on} (ms)	T _(on+off) (ms)	Duty cycle	Duty cycle correction Factor(dB)
802.11b	1.00	1.00	1.00	NA
802.11g	1.40	1.56	0.90	0.47
802.11n HT20	1.30	1.46	0.89	0.50
802.11n HT40	0.65	0.80	0.81	0.92

Note: when Duty cycle \geq 0.98, Duty cycle correction Factor not required.

**SISO Antenna 1**

Test Mode	Carrier frequency (MHz) / Channel	Average Power Measured (dBm)	Average Power with duty factor (dBm)	Limit (dBm)	Conclusion
802.11b	2412/CH1	20.57	20.57	30	PASS
	2437/CH6	20.73	20.73	30	PASS
	2462/CH11	20.02	20.02	30	PASS
802.11g	2412/CH1	16.85	17.32	30	PASS
	2437/CH6	16.94	17.41	30	PASS
	2462/CH11	16.46	16.93	30	PASS
802.11n HT20	2412/CH1	16.72	17.22	30	PASS
	2437/CH6	16.67	17.17	30	PASS
	2462/CH11	16.21	16.71	30	PASS
802.11n HT40	2422/CH3	15.92	16.84	30	PASS
	2437/CH6	16.01	16.93	30	PASS
	2452/CH9	15.83	16.75	30	PASS

Note: Average Power with duty factor = Average Power Measured +Duty cycle correction factor

SISO Antenna 2

Test Mode	Carrier frequency (MHz) / Channel	Average Power Measured (dBm)	Average Power with duty factor (dBm)	Limit (dBm)	Conclusion
802.11b	2412/CH1	20.97	20.97	30	PASS
	2437/CH6	20.76	20.76	30	PASS
	2462/CH11	20.44	20.44	30	PASS
802.11g	2412/CH1	17.42	17.89	30	PASS
	2437/CH6	17.14	17.61	30	PASS
	2462/CH11	17.06	17.53	30	PASS
802.11n HT20	2412/CH1	17.25	17.75	30	PASS
	2437/CH6	17.05	17.55	30	PASS
	2462/CH11	16.87	17.37	30	PASS
802.11n HT40	2422/CH3	16.36	17.28	30	PASS
	2437/CH6	16.02	16.94	30	PASS
	2452/CH9	16.11	17.03	30	PASS

Note: Average Power with duty factor = Average Power Measured +Duty cycle correction factor

MIMO Antenna

Test Mode	Carrier frequency (MHz) / Channel	MIMO Antenna 1		MIMO Antenna 2		Total Power (dBm)	Limit (dBm)	Conclusion
		Average Power Measured (dBm)	Average Power with duty factor (dBm)	Average Power Measured (dBm)	Average Power with duty factor (dBm)			
802.11b HT20	2412/CH1	20.68	20.68	21.15	21.15	23.93	30	PASS
	2437/CH6	20.89	20.89	20.94	20.94	23.93	30	PASS
	2462/CH11	20.21	20.21	20.74	20.74	23.49	30	PASS
802.11g HT20	2412/CH1	17.09	17.56	17.60	18.07	20.83	30	PASS
	2437/CH6	17.13	17.60	17.32	17.79	20.71	30	PASS
	2462/CH11	16.57	17.04	17.29	17.76	20.43	30	PASS
802.11n HT20	2412/CH1	16.89	17.39	17.43	17.93	20.68	30	PASS
	2437/CH6	16.86	17.36	17.41	17.91	20.66	30	PASS
	2462/CH11	16.32	16.82	17.05	17.55	20.21	30	PASS
802.11n HT40	2422/CH3	16.12	17.04	16.58	17.50	20.28	30	PASS
	2437/CH6	16.13	17.05	16.27	17.19	20.13	30	PASS
	2452/CH9	15.92	16.84	16.29	17.21	20.03	30	PASS

Note: 1. Average Power with duty factor = Average Power Measured + Duty cycle correction factor

2. For Total Power, according to KDB 662911 D01 Multiple Transmitter Output v02r01 1),

The Total Power = $10 \log(10^{(\text{Power antenna1 in dBm}/10)} + 10^{(\text{Power antenna2 in dBm}/10)})$

3. The manufacturer declared the transmitter output signals is CDD mode. And $N_{SS}=1$. According to KDB 662911 D01 Multiple Transmitter Output v02r01 2)f)(i): If all antennas have the same gain, Directional gain = $G_{ANT} + \text{Array Gain}$,

For power measurements on IEEE 802.11 devices,

Array Gain = 0 dB (i.e., no array gain) for $N_{ANT} \leq 4$;

Array Gain = 0 dB (i.e., no array gain) for channel widths ≥ 40 MHz for any N_{ANT} ;

Array Gain = $5 \log(N_{ANT}/N_{SS})$ dB or 3 dB, whichever is less, for 20-MHz channel widths with $N_{ANT} \geq 5$.

4. If antenna gains are not equal, the user may use either of the following methods to calculate directional gain, provided that each transmit antenna is driven by only one spatial stream: Directional gain may be calculated by using the formulas applicable to equal gain antennas with G_{ANT} set equal to the gain of the antenna having the highest gain.

So directional gain = $G_{ANT} + \text{Array Gain} = 3.9 \text{dBi} < 6 \text{dBi}$. So the power limit is 30dBm

5.2. 99% Bandwidth and 6dB Bandwidth

Ambient condition

Temperature	Relative humidity	Pressure
23°C ~25°C	45%~50%	101.5kPa

Method of Measurement

The EUT was connected to the spectrum analyzer through an external attenuator (20dB) and a known loss cable. RBW is set to 100 kHz; VBW is set to 300 kHz on spectrum analyzer. Dector=Peak, Trace mode=max hold.

The EUT was connected to the spectrum analyzer through a known loss cable. The resolution bandwidth (RBW) shall be in the range of 1% to 5% of the actual occupied / x dB bandwidth and the video bandwidth (VBW) shall not be smaller than three times the RBW value.

Test Setup

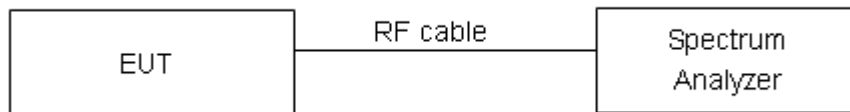

Limits

Rule Part 15.247 (a) (2) specifies that “Systems using digital modulation techniques may operate in the 902–928 MHz, 2400–2483.5 MHz bands. The minimum 6 dB bandwidth shall be at least 500 kHz.”

minimum 6 dB bandwidth	≥ 500 kHz
------------------------	-----------

Measurement Uncertainty

The assessed measurement uncertainty to ensure 95% confidence level for the normal distribution is with the coverage factor $k = 2$, $U = 936$ Hz.

**Test Results:**

Test Mode	Carrier frequency (MHz)	99% bandwidth (MHz)	Minimum 6 dB bandwidth (MHz)	Limit (kHz)	Conclusion
802.11b	2412	14.834	10.02	500	PASS
	2437	15.225	10.07	500	PASS
	2462	15.347	10.08	500	PASS
802.11g	2412	16.451	13.76	500	PASS
	2437	16.502	13.20	500	PASS
	2462	16.566	13.86	500	PASS
802.11n HT20	2412	17.564	12.63	500	PASS
	2437	17.625	15.01	500	PASS
	2462	17.611	12.51	500	PASS
802.11n HT40	2422	35.815	31.34	500	PASS
	2437	35.923	32.59	500	PASS
	2452	35.964	32.58	500	PASS



99%bandwidth

802.11b, Carrier frequency (MHz): 2412



802.11g, Carrier frequency (MHz): 2412



802.11b, Carrier frequency (MHz): 2437



802.11g, Carrier frequency (MHz): 2437



802.11b, Carrier frequency (MHz):2462



802.11g, Carrier frequency (MHz):2462





802.11n(HT20), Carrier frequency (MHz): 2412



802.11n(HT40), Carrier frequency (MHz): 2422



802.11n(HT20), Carrier frequency (MHz): 2437



802.11n(HT40), Carrier frequency (MHz): 2437



802.11n(HT20), Carrier frequency (MHz):2462



802.11n(HT40), Carrier frequency (MHz):2452





6 dB bandwidth

802.11b, Carrier frequency (MHz): 2412



802.11g, Carrier frequency (MHz): 2412



802.11b, Carrier frequency (MHz): 2437



802.11g, Carrier frequency (MHz): 2437



802.11b, Carrier frequency (MHz): 2462



802.11g, Carrier frequency (MHz): 2462





802.11n(HT20), Carrier frequency (MHz): 2412



802.11n(HT40), Carrier frequency (MHz): 2422



802.11n(HT20), Carrier frequency (MHz): 2437



802.11n(HT40), Carrier frequency (MHz): 2437



802.11n(HT20), Carrier frequency (MHz):2462



802.11n(HT40), Carrier frequency (MHz):2452



5.3. Band Edge

Ambient condition

Temperature	Relative humidity	Pressure
23°C ~25°C	45%~50%	101.5kPa

Method of Measurement

The EUT was connected to the spectrum analyzer through an external attenuator (20dB) and a known loss cable the band edge of the lowest and highest channels were measured. The peak detector is used and RBW is set to 100 kHz and VBW is set to 300 kHz on spectrum analyzer. Spectrum analyzer plots are included on the following pages.

Test Setup

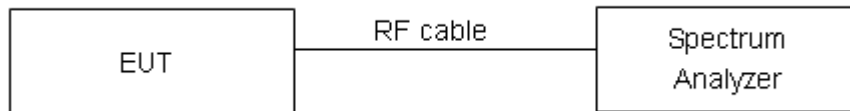

Limits

Rule Part 15.247(d) specifies that “In any 100 kHz bandwidth outside the frequency band in which the spread spectrum or digitally modulated intentional radiator is operating, the radio frequency power that is produced by the intentional radiator shall be at least 20 dB below that in the 100 kHz bandwidth within the band that contains the highest level of the desired power, based on either an RF conducted or a radiated measurement, provided the transmitter demonstrates compliance with the peak conducted power limits.” If the transmitter complies with the conducted power limits based on the use of RMS averaging over a time interval, as permitted under paragraph (b)(3) of this section, the attenuation required under this paragraph shall be 30 dB instead of 20 dB.”

Measurement Uncertainty

The assessed measurement uncertainty to ensure 95% confidence level for the normal distribution is with the coverage factor $k = 1.96$.

Frequency	Uncertainty
2GHz-3GHz	1.407 dB



Test Results: PASS

802.11b, Channel No.: 1

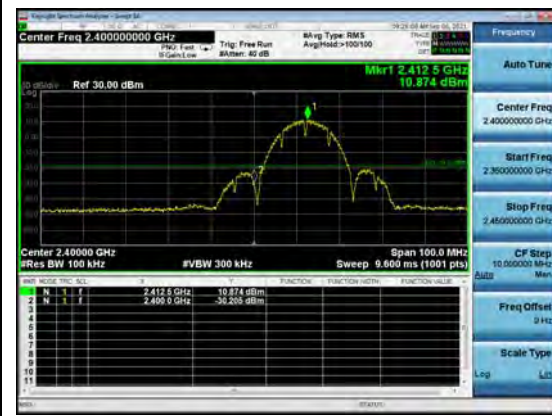

802.11b, Channel No.: 11

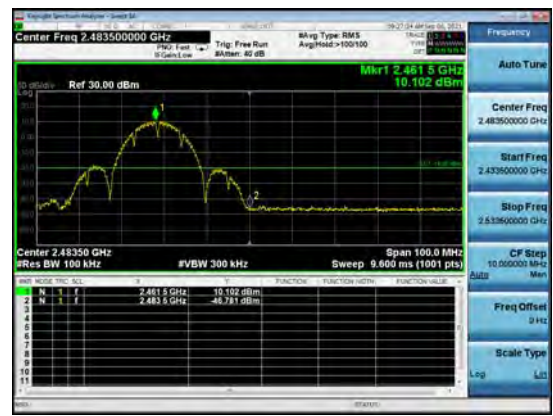

802.11g, Channel No.: 1

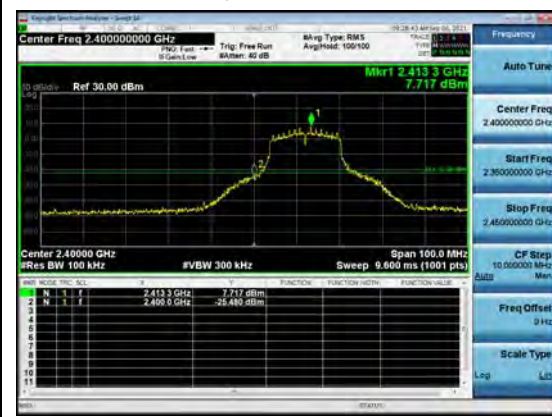

802.11g, Channel No.: 11



802.11n(HT20), Channel No.: 1

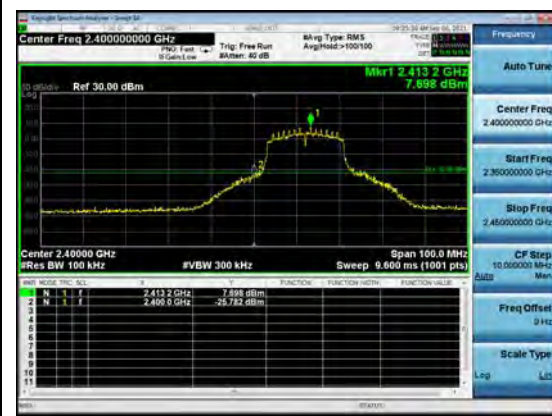

802.11n(HT20), Channel No.: 11



802.11n(HT40), Channel No.: 3

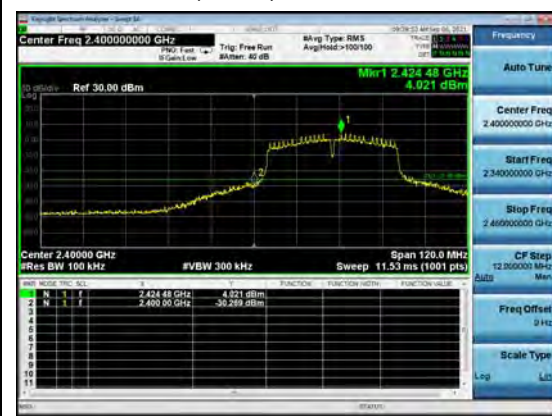

802.11n(HT40), Channel No.: 9



5.4. Power Spectral Density

Ambient condition

Temperature	Relative humidity	Pressure
23°C ~25°C	45%~50%	101.5kPa

Method of Measurement

During the process of the testing, The EUT was connected to Spectrum Analyzer with a known loss.

The EUT is max power transmission with proper modulation.

Method AVGPSD-1 was used for this test.

- a) Set instrument center frequency to DTS channel center frequency
- b) Set span to at least 1.5 times the OBW
- c) Set RBW to: $3\text{kHz} \leq \text{RBW} \leq 100\text{kHz}$
- d) Set VBW $\geq [3 \times \text{RBW}]$
- e) Detector=power averaging(rms) or sample detector(when rms not available)
- f) Ensure that the number of measurement points in the sweep $2[2 \times \text{span}/\text{RBWT}]$
- g) Sweep time auto couple
- h) Employ trace averaging(rms) mode over a minimum of 100 traces
- i) Use the peak marker function to determine the maximum amplitude level.
- j) If the measured value exceeds requirement, then reduce RBW (but no less than 3 kHz) and repeat(note that this may require zooming in on the emission of interest and reducing the span to meet the minimum measurement point requirement as the RBW is reduced)

Method AVGPSD-2 was used for this test.

- a) Measure the duty cycle(D)of the transmitter output signal as described in 11.6
- b) Set instrument center frequency to DTS channel center frequency
- c) Set span to at least 1.5 times the OBW
- d) Set RBW to: $3\text{kHz} \leq \text{RBW} \leq 100\text{Kh}$
- e) Set VBW $\geq [3 \times \text{RBW}]$
- f) Detector= power averaging(rms) or sample detector (when rms not available)
- g) Ensure that the number of measurement points in the sweep $2[2 \times \text{span}/\text{RBW}]$
- h) Sweep time =auto couple
- i) Do not use sweep triggering; allow sweep to "free run"
- j) Employ trace averaging(rms) mode over a minimum of 100 traces
- k) Use the peak marker function to determine the maximum amplitude level
- l) Add $[10 \log(1/ D)]$, where D is the duty cycle measured in step a), to the measured PSD to

compute the average PSD during the actual transmission time

m) If measured value exceeds requirement specified by regulatory agency then reduce RBW (but no less than 3 kHz) and repeat (note that this may require zooming in on the emission of interest and reducing the span to meet the minimum measurement point requirement as the RBW is reduced)

The conducted Power is measured at each antenna port. The measured results at the various antenna ports are then summed mathematically.

Test setup

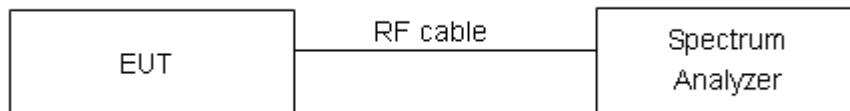

Limits

Rule Part 15.247(e) specifies that "For digitally modulated systems, the power spectral density conducted from the intentional radiator to the antenna shall not be greater than 8 dBm in any 3 kHz band during any time interval of continuous transmission. "

Limits	$\leq 8 \text{ dBm} / 3\text{kHz}$
--------	------------------------------------

Measurement Uncertainty

The assessed measurement uncertainty to ensure 95% confidence level for the normal distribution is with the coverage factor $k = 2$, $U = 0.75\text{dB}$.

**Test Results:****SISO Antenna 1**

Test Mode	Channel Number	Read Value (dBm / 3kHz)	Power Spectral Density (dBm / 3kHz)	Limit (dBm / 3kHz)	Conclusion
802.11b	1	-12.470	-12.47	8	PASS
	6	-13.956	-13.96	8	PASS
	11	-12.353	-12.35	8	PASS
802.11g	1	-18.393	-17.92	8	PASS
	6	-18.220	-17.75	8	PASS
	11	-18.829	-18.36	8	PASS
802.11n HT20	1	-18.706	-18.20	8	PASS
	6	-18.320	-17.82	8	PASS
	11	-19.071	-18.57	8	PASS
802.11n HT40	3	-22.569	-21.65	8	PASS
	6	-22.193	-21.28	8	PASS
	9	-22.211	-21.30	8	PASS

Note: Power Spectral Density =Read Value+Duty cycle correction factor

SISO Antenna 2

Test Mode	Channel Number	Read Value (dBm / 3kHz)	Power Spectral Density (dBm / 3kHz)	Limit (dBm / 3kHz)	Conclusion
802.11b	1	-11.057	-11.06	8	PASS
	6	-11.683	-11.68	8	PASS
	11	-12.296	-12.30	8	PASS
802.11g	1	-17.539	-17.07	8	PASS
	6	-18.302	-17.83	8	PASS
	11	-18.143	-17.67	8	PASS
802.11n HT20	1	-18.177	-17.67	8	PASS
	6	-18.248	-17.75	8	PASS
	11	-18.352	-17.85	8	PASS
802.11n HT40	3	-21.907	-20.99	8	PASS
	6	-22.556	-21.64	8	PASS
	9	-22.399	-21.48	8	PASS

Note: Power Spectral Density =Read Value+Duty cycle correction factor

MIMO Antenna

Test Mode	Channel Number	Power Spectral Density				Total PSD	Limit (dBm / 3kHz)	Conclusion
		Antenna 1		Antenna 2				
		Read Value (dBm / 3kHz)	Power Spectral Density (dBm / 3kHz)	Read Value (dBm / 3kHz)	Power Spectral Density (dBm / 3kHz)	(dBm / 3kHz)		
802.11b	1	-13.361	-13.36	-13.004	-13.00	-10.17	7.09	PASS
	6	-13.398	-13.40	-13.279	-13.28	-10.33	7.09	PASS
	11	-13.024	-13.02	-13.451	-13.45	-10.22	7.09	PASS
802.11g	1	-17.949	-17.48	-17.392	-16.92	-14.18	7.09	PASS
	6	-18.320	-17.85	-17.888	-17.42	-14.62	7.09	PASS
	11	-18.603	-18.13	-17.864	-17.39	-14.74	7.09	PASS
802.11n HT20	1	-18.603	-18.10	-16.949	-16.45	-14.18	7.09	PASS
	6	-18.210	-17.71	-16.715	-16.21	-13.89	7.09	PASS
	11	-18.809	-18.31	-17.377	-16.87	-14.52	7.09	PASS
802.11n HT40	3	-22.379	-21.46	-21.812	-20.90	-18.16	7.09	PASS
	6	-22.383	-21.47	-22.386	-21.47	-18.46	7.09	PASS
	9	-22.331	-21.42	-22.210	-21.29	-18.34	7.09	PASS

Note: 1. Power Spectral Density = Read Value + Duty cycle correction factor
 2. For Total PSD, according to KDB 662911 D01 Multiple Transmitter Output v02r01 2)a), the power spectral density = $10\log(10^{(\text{PSD antenna1 in dBm}/10)} + 10^{(\text{PSD antenna2 in dBm}/10)})$
 3. The manufacturer declared the transmitter output signals is CDD mode. And $N_{ss}=1$. According to KDB 662911 D01 Multiple Transmitter Output v02r01 2)f)(i): If all antennas have the same gain, Directional gain = $G_{ANT} + \text{Array Gain}$. For PSD measurements on all devices, Array Gain = $10\log(N_{ant}/N_{ss})\text{dB}$, so directional gain = $G_{ANT} + \text{Array Gain} = 3.9 + 10\log(2/1) = 6.91 > 6\text{dBi}$. So the PSD limit is $8 + 6 - \text{MAX}(6, 6.91)\text{dBm} = 7.09\text{dBm}$



SISO Antenna 1

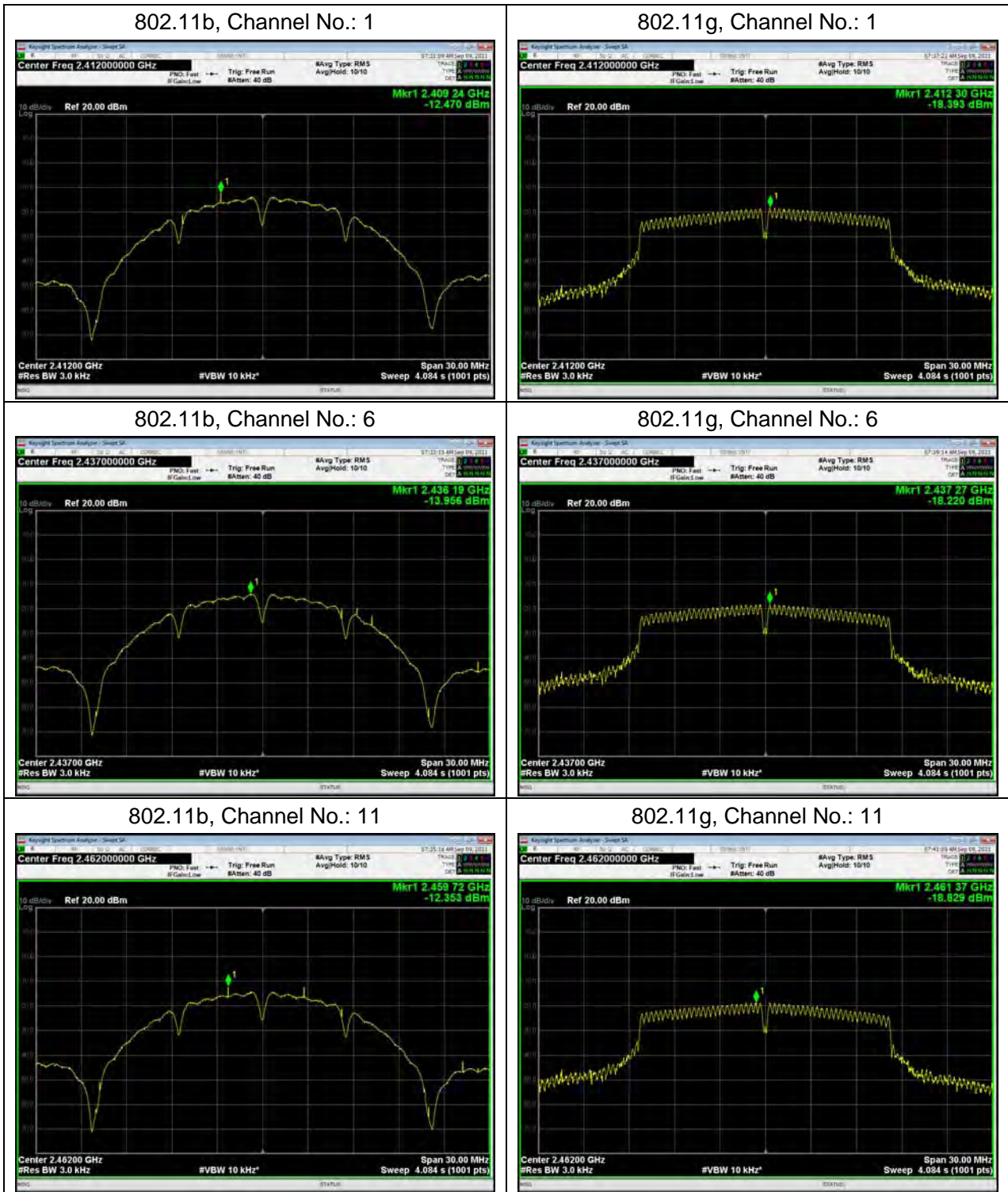



802.11n(HT20), Channel No. 1



802.11n(HT40), Channel No. 3



802.11n(HT20), Channel No. 6

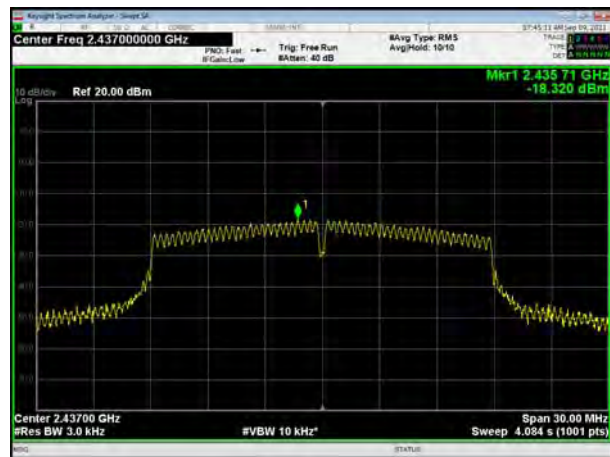

802.11n(HT40), Channel No. 6

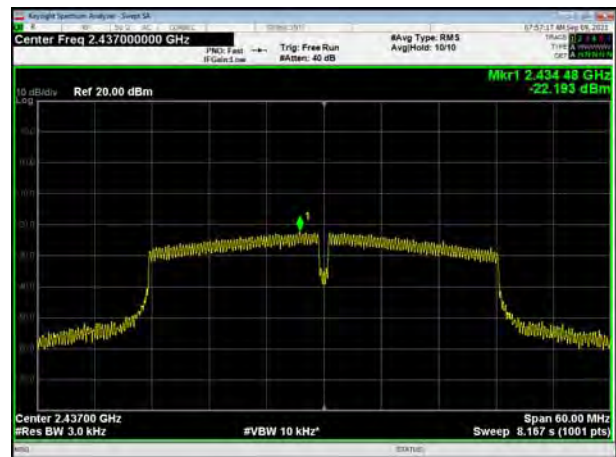

802.11n(HT20), Channel No. 11

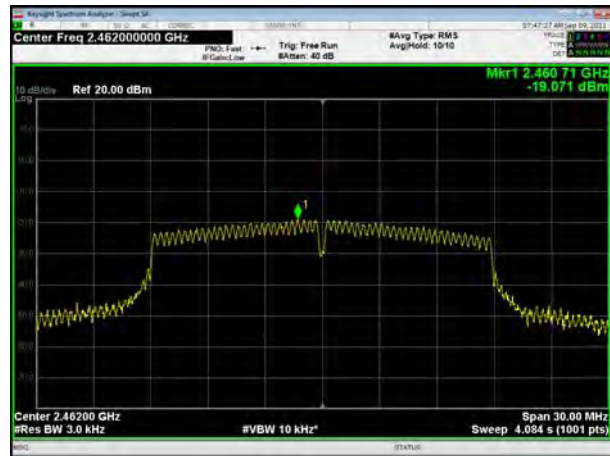

802.11n(HT40), Channel No. 9

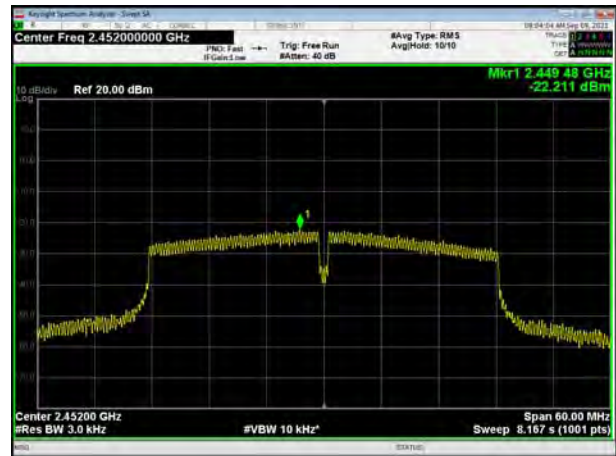



SISO Antenna 2

802.11b, Channel No.: 1



802.11g, Channel No.: 1

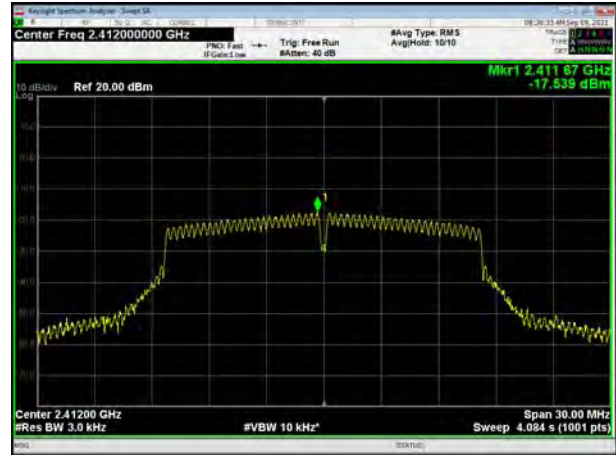

802.11b, Channel No.: 6



802.11g, Channel No.: 6

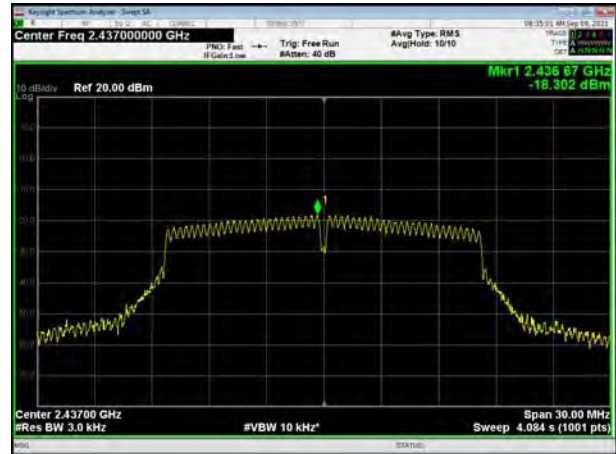

802.11b, Channel No.: 11



802.11g, Channel No.: 11

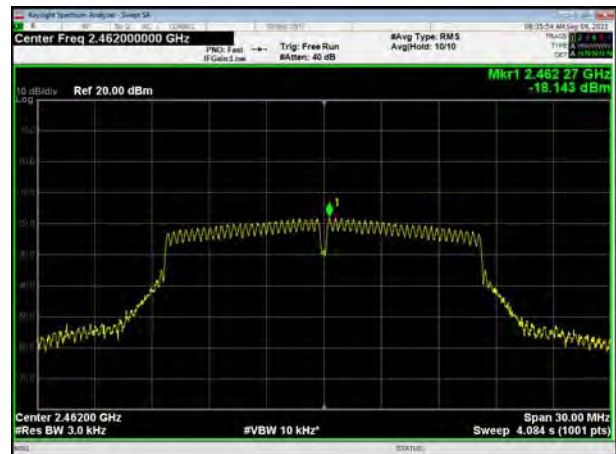



802.11n(HT20), Channel No. 1

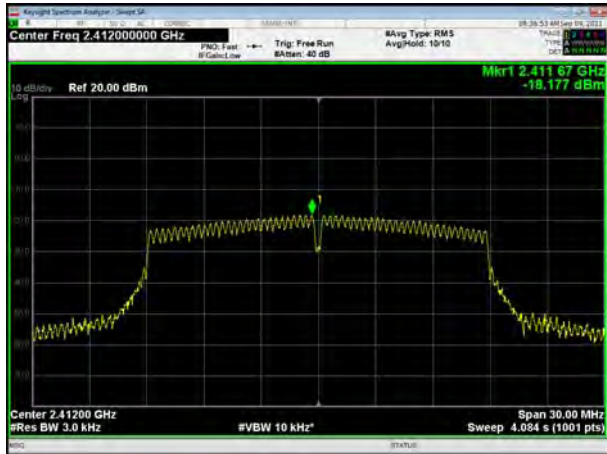

802.11n(HT40), Channel No. 3

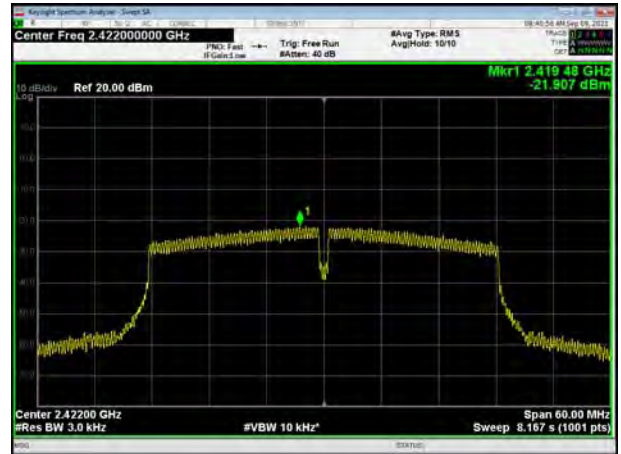

802.11n(HT20), Channel No. 6

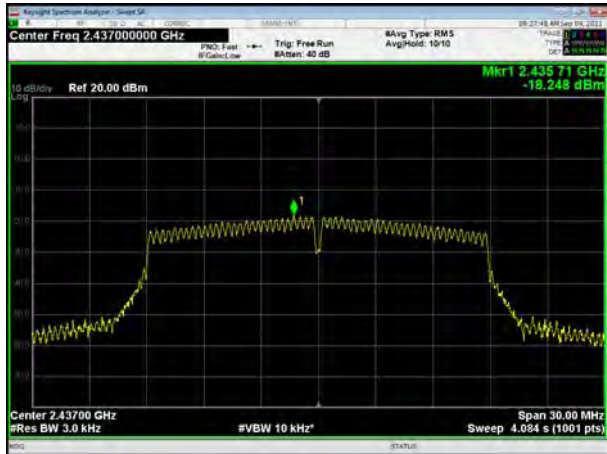

802.11n(HT40), Channel No. 6

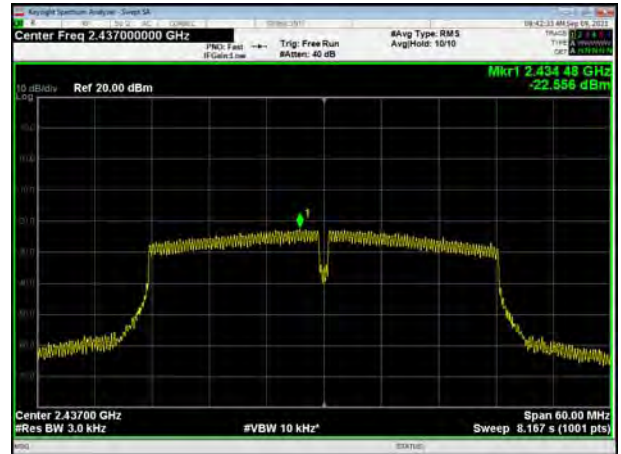

802.11n(HT20), Channel No. 11

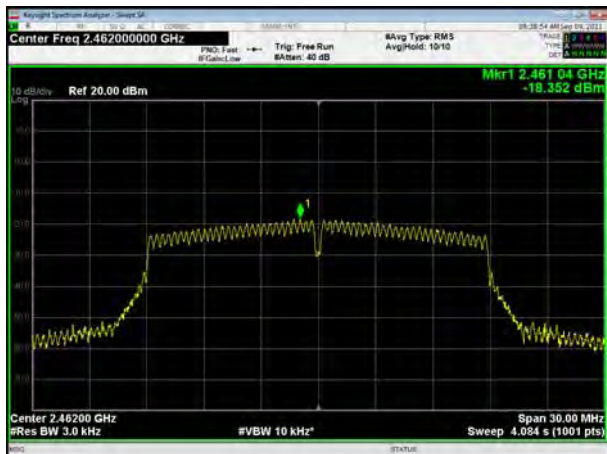

802.11n(HT40), Channel No. 9

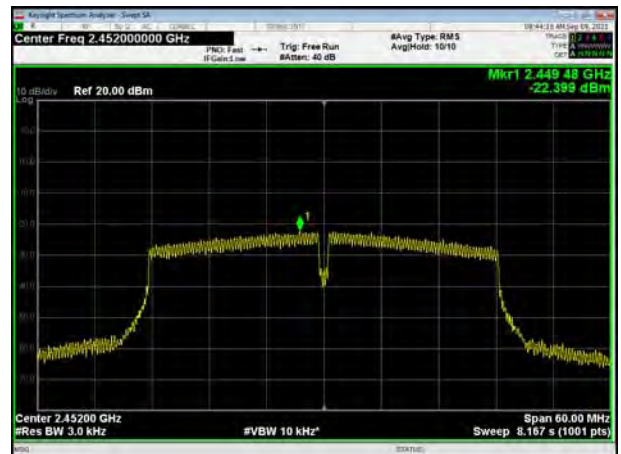



MIMO Antenna 1

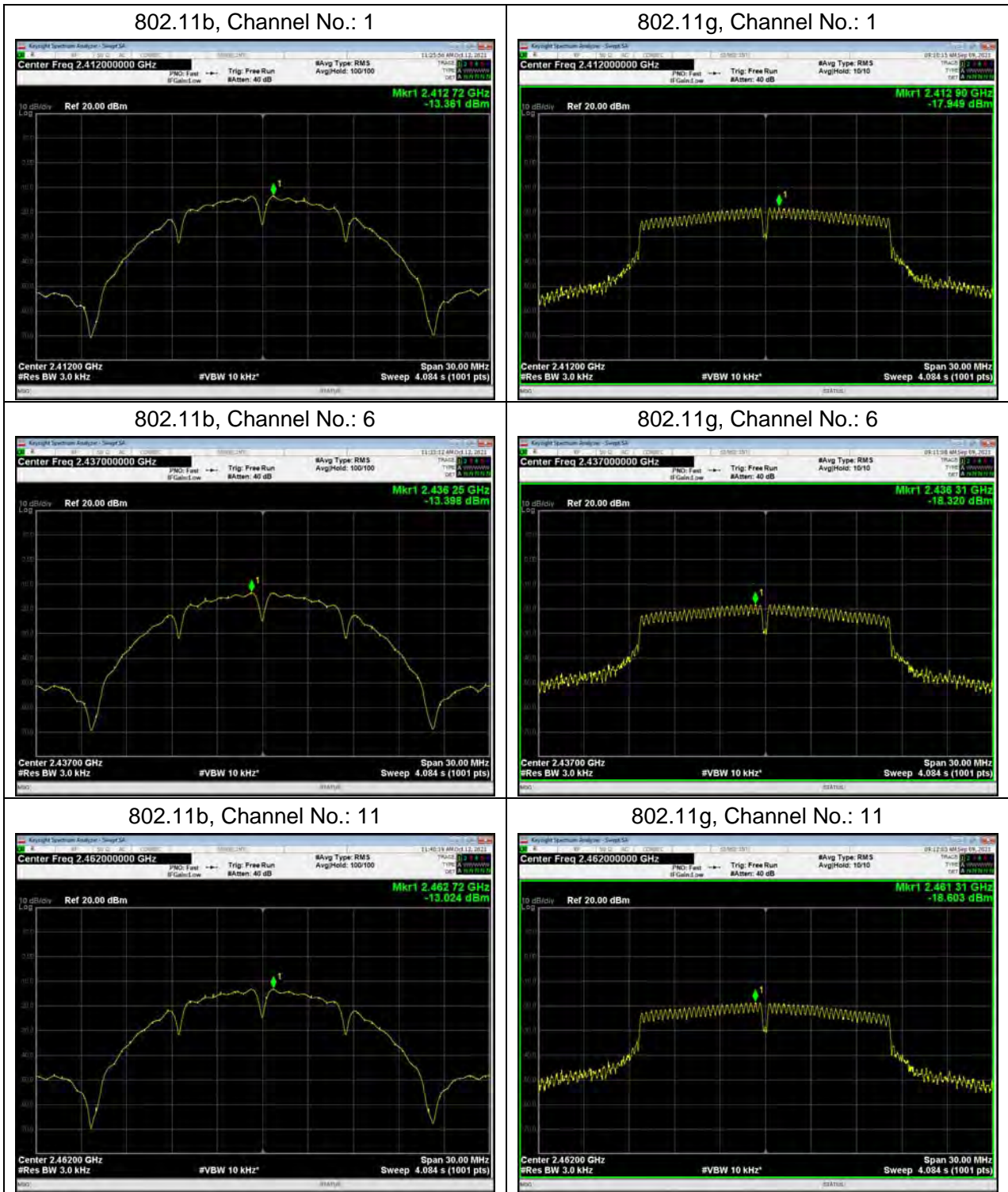



802.11n(HT20), Channel No. 1

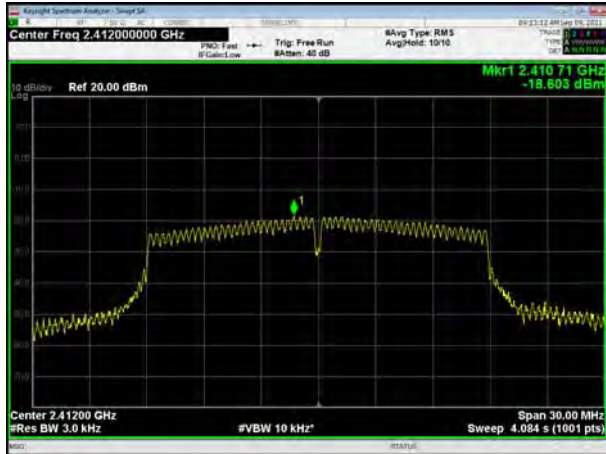

802.11n(HT40), Channel No. 3

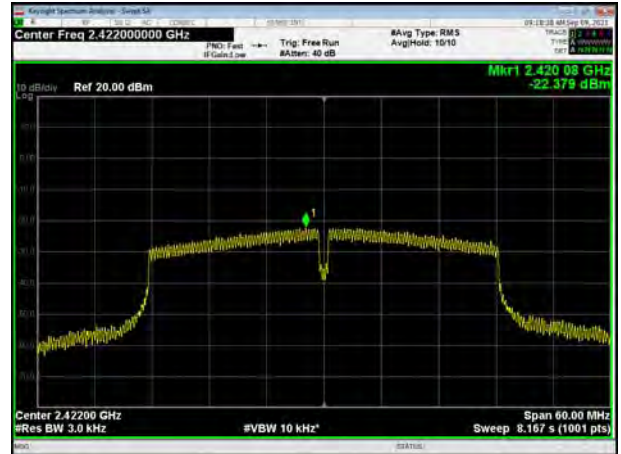

802.11n(HT20), Channel No. 6



802.11n(HT40), Channel No. 6



802.11n(HT20), Channel No. 11



802.11n(HT40), Channel No. 9





MIMO Antenna 2

802.11b, Channel No.: 1



802.11g, Channel No.: 1



802.11b, Channel No.: 6



802.11g, Channel No.: 6

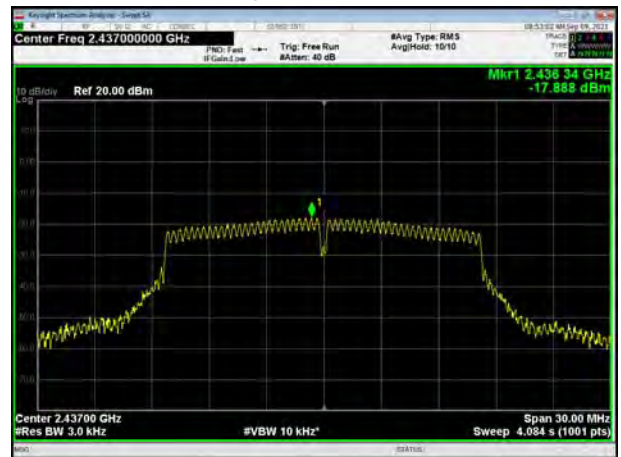

802.11b, Channel No.: 11



802.11g, Channel No.: 11





802.11n(HT20), Channel No. 1



802.11n(HT40), Channel No. 3



802.11n(HT20), Channel No. 6

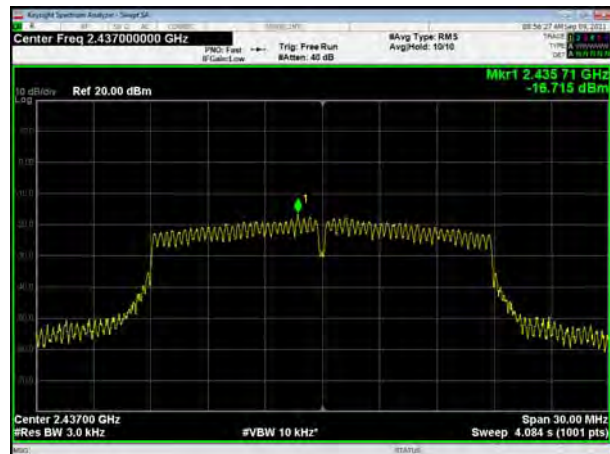

802.11n(HT40), Channel No. 6



802.11n(HT20), Channel No. 11

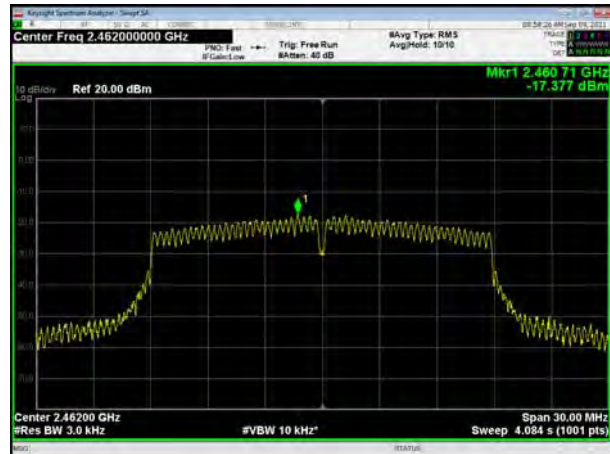

802.11n(HT40), Channel No. 9



5.5. Spurious RF Conducted Emissions

Ambient condition

Temperature	Relative humidity	Pressure
23°C ~25°C	45%~50%	101.5kPa

Method of Measurement

The EUT was connected to the spectrum analyzer with a known loss. The spectrum analyzer scans from 30MHz to the 10th harmonic of the carrier. The peak detector is used. Set RBW to 100 kHz and VBW to 300 kHz, Sweep is set to ATUO.

The test is in transmitting mode.

Test setup



Limits

Rule Part 15.247(d) pacifies that “In any 100 kHz bandwidth outside the frequency band in which the spread spectrum or digitally modulated intentional radiator is operating, the radio frequency power that is produced by the intentional radiator shall be at least 20 dB below that in the 100 kHz bandwidth within the band that contains the highest level of the desired power, based on either an RF conducted or a radiated measurement, provided the transmitter demonstrates compliance with the peak conducted power limits. If the transmitter complies with the conducted power limits based on the use of RMS averaging over a time interval, as permitted under paragraph (b)(3) of this section, the attenuation required under this paragraph shall be 30 dB instead of 20 dB. ”

Test Mode	Carrier frequency (MHz)	Reference value (dBm)	Limit
802.11b	2412	9.04	-20.96
	2437	9.01	-20.99
	2462	8.67	-21.33
802.11g	2412	5.26	-24.74
	2437	4.84	25.16
	2462	4.45	-25.55
802.11n HT20	2412	4.30	-25.70
	2437	5.41	-24.59
	2462	4.40	-25.60
802.11n HT40	2422	2.22	-27.78
	2437	2.30	-27.70
	2452	2.03	-27.97

**Measurement Uncertainty**

The assessed measurement uncertainty to ensure 95% confidence level for the normal distribution is with the coverage factor $k = 1.96$.

Frequency	Uncertainty
100kHz-2GHz	0.684 dB
2GHz-26GHz	1.407 dB



Test Results:





802.11b, Channel No.: 6



802.11g, Channel No.: 6

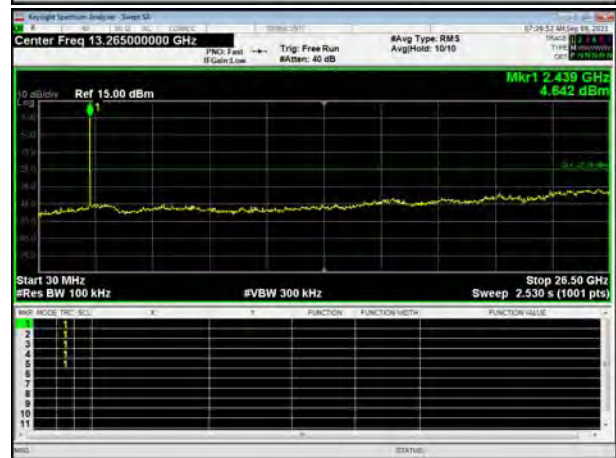
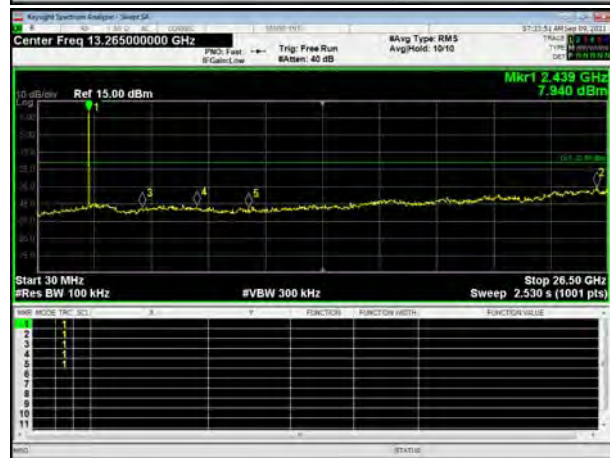



802.11b, Channel No.: 11



802.11g, Channel No.: 11

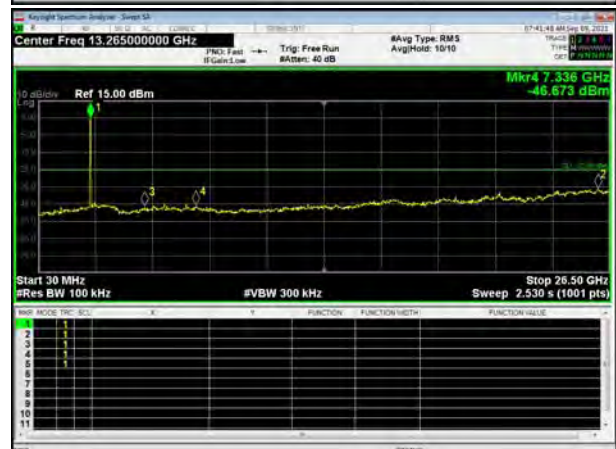
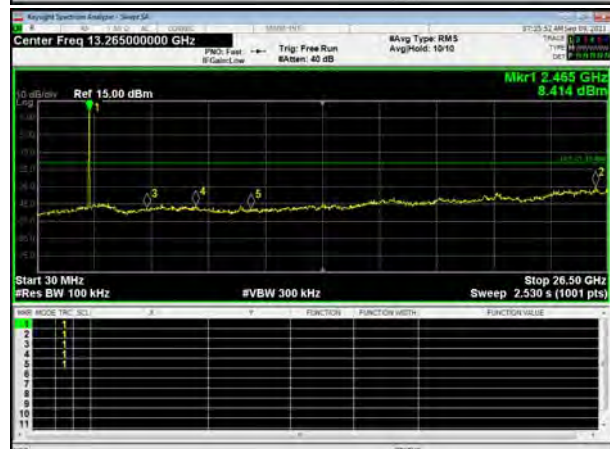



802.11n(HT20), Channel No. 1



802.11n(HT40), Channel No. 3

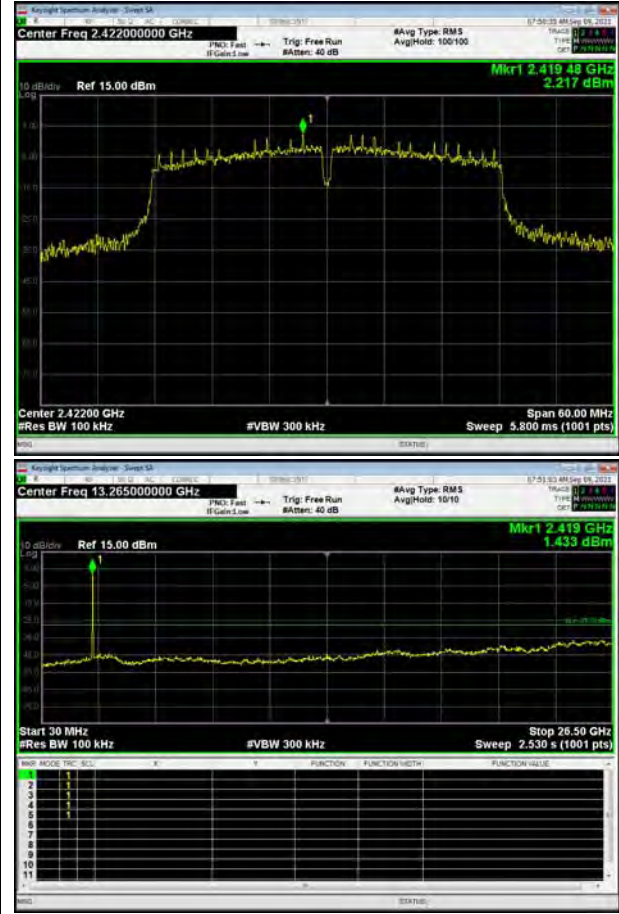



802.11n(HT20), Channel No. 6

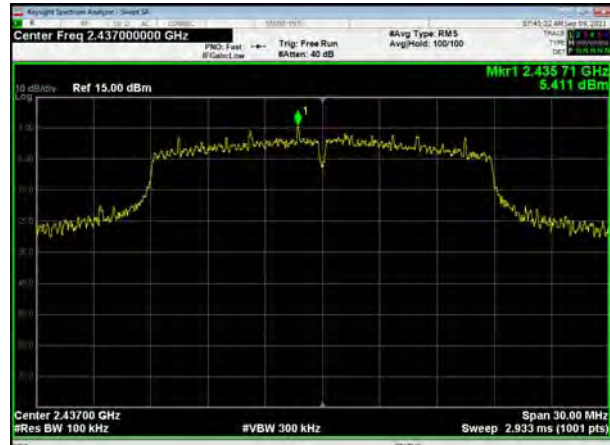

802.11n(HT40), Channel No. 6

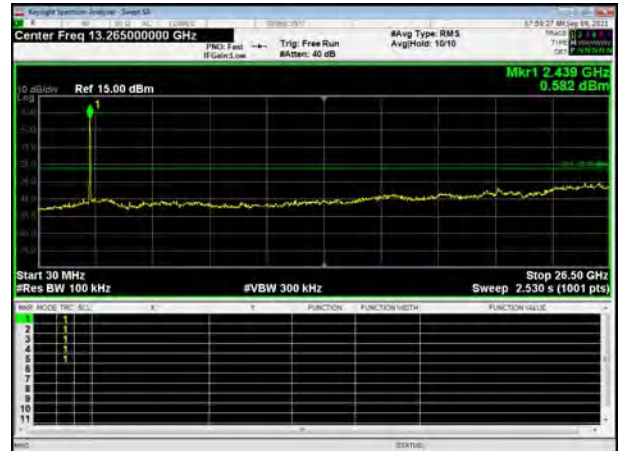
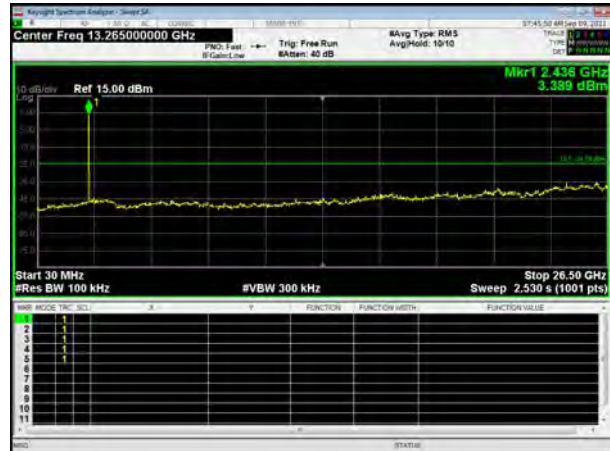



802.11n(HT20), Channel No. 11

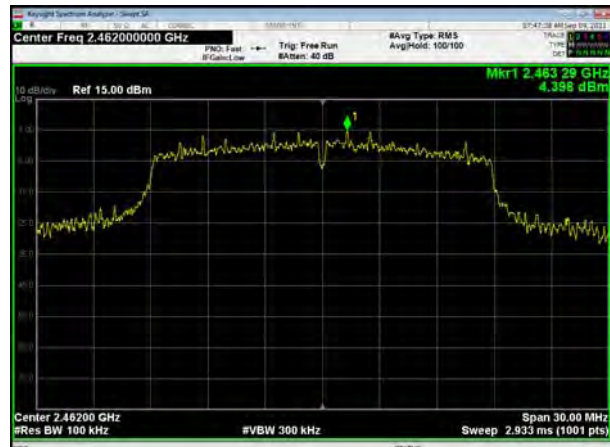

802.11n(HT40), Channel No. 9

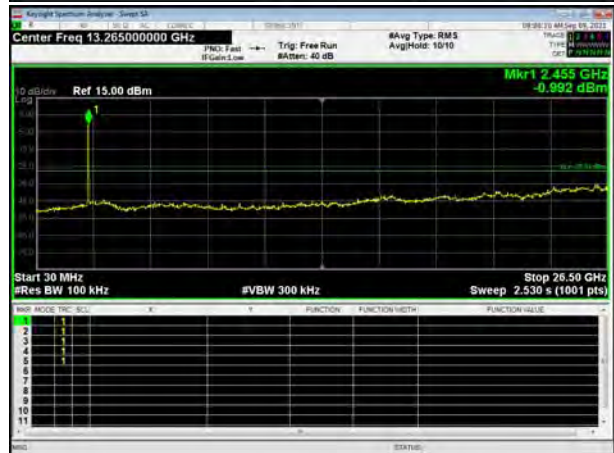
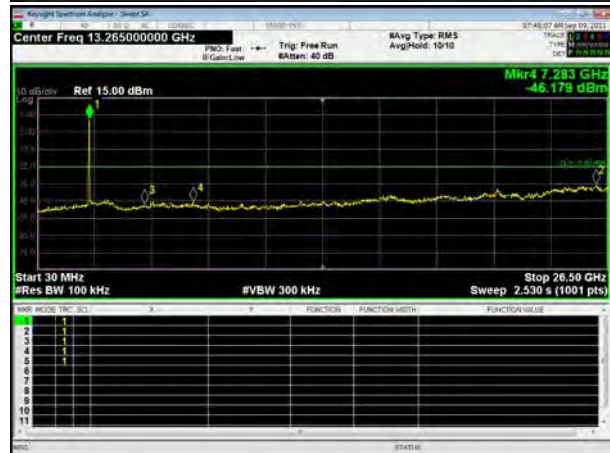
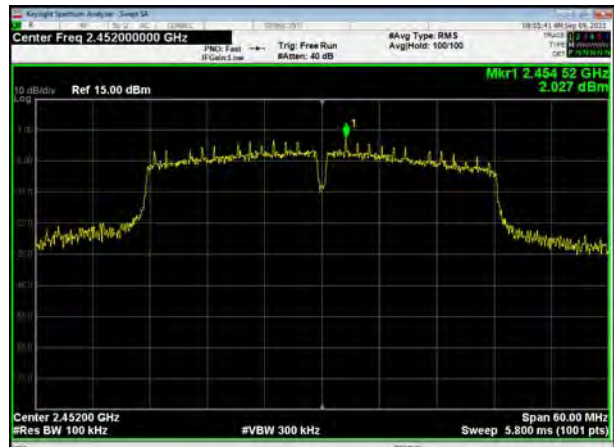

5.6. Unwanted Emission

Ambient condition

Temperature	Relative humidity	Pressure
23°C ~25°C	45%~50%	102.5kPa

Method of Measurement

The test set-up was made in accordance to the general provisions of ANSI C63.10.

The Equipment Under Test (EUT) was set up on a non-conductive table in the semi-anechoic chamber. The test was performed at the distance of 3 m between the EUT and the receiving antenna.

The turntable shall be rotated from 0 to 360 degrees for detecting the maximum of radiated spurious signal level. The measurements shall be repeated with orthogonal polarization of the test antenna. The data of cable loss and antenna factor has been calibrated in full testing frequency range before the testing. Sweep the Restricted Band and the emissions less than 20 dB below the permissible value are reported.

The radiated emissions measurements were made in a typical installation configuration.

Sweep the whole frequency band through the range from 9 kHz to the 10th harmonic of the carrier, and the emissions less than 20 dB below the permissible value are reported.

This method refer to ANSI C63.10.

The procedure for peak unwanted emissions measurements above 1000 MHz is as follows:

Set the spectrum analyzer in the following:

9kHz~150 kHz

RBW=200Hz, VBW=1kHz/ Sweep=AUTO

150 kHz~30MHz

RBW=9KHz, VBW=30KHz,/ Sweep=AUTO

Below 1GHz

RBW=100kHz / VBW=300kHz / Sweep=AUTO

a) Peak emission levels are measured by setting the instrument as follows:

Above 1GHz

PEAK: RBW=1MHz VBW=3MHz/ Sweep=AUTO

b) Average emission levels are measured by setting the instrument as follows:

Above 1GHz

AVERAGE: RBW=1MHz / VBW=3MHz / Sweep=AUTO

c) Detector: The measurements employing a CISPR quasi-peak detector except for the frequency bands 9-90 kHz, 110-490 kHz and above 1000 MHz. Radiated emission limits in these three bands are based on measurements employing an average detector.

d) Averaging type = power (i.e., rms) (As an alternative, the detector and averaging type may be set for linear voltage averaging. Some instruments require linear display mode to use linear voltage



averaging. Log or dB averaging shall not be used.)

e) Sweep time = auto.

f) Perform a trace average of at least 100 traces if the transmission is continuous. If the transmission is not continuous, then the number of traces shall be increased by a factor of $1 / D$, where D is the duty cycle. For example, with 50% duty cycle, at least 200 traces shall be averaged. (If a specific emission is demonstrated to be continuous—i.e., 100% duty cycle—then rather than turning ON and OFF with the transmit cycle, at least 100 traces shall be averaged.)

g) If tests are performed with the EUT transmitting at a duty cycle less than 98%, then a correction factor shall be added to the measurement results prior to comparing with the emission limit, to compute the emission level that would have been measured had the test been performed at 100% duty cycle. The correction factor is computed as follows:

1) If power averaging (rms) mode was used in the preceding step e), then the correction factor is $[10 \log (1 / D)]$, where D is the duty cycle. For example, if the transmit duty cycle was 50%, then 3 dB shall be added to the measured emission levels.

2) If linear voltage averaging mode was used in the preceding step e), then the correction factor is $[20 \log (1 / D)]$, where D is the duty cycle. For example, if the transmit duty cycle was 50%, then 6 dB shall be added to the measured emission levels.

3) If a specific emission is demonstrated to be continuous (100% duty cycle) rather than turning ON and OFF with the transmit cycle, then no duty cycle correction is required for that emission.

The test is in transmitting mode.

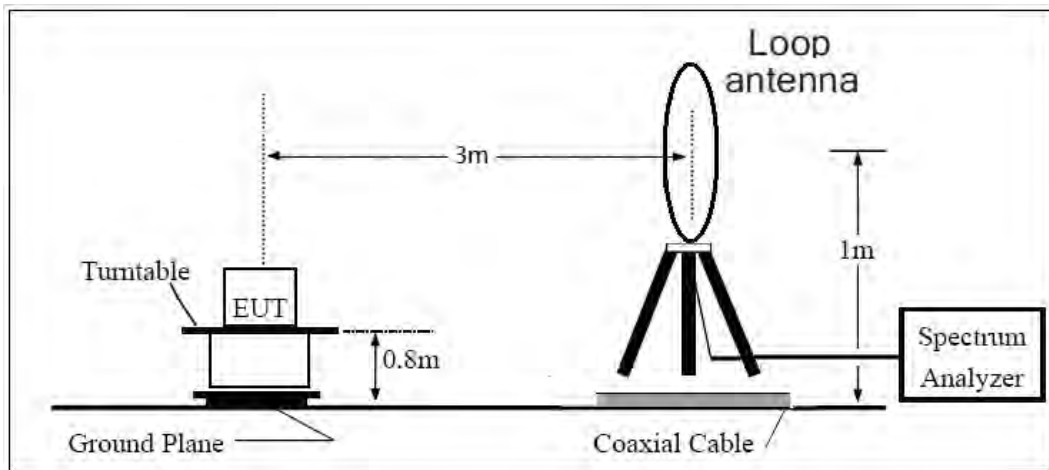
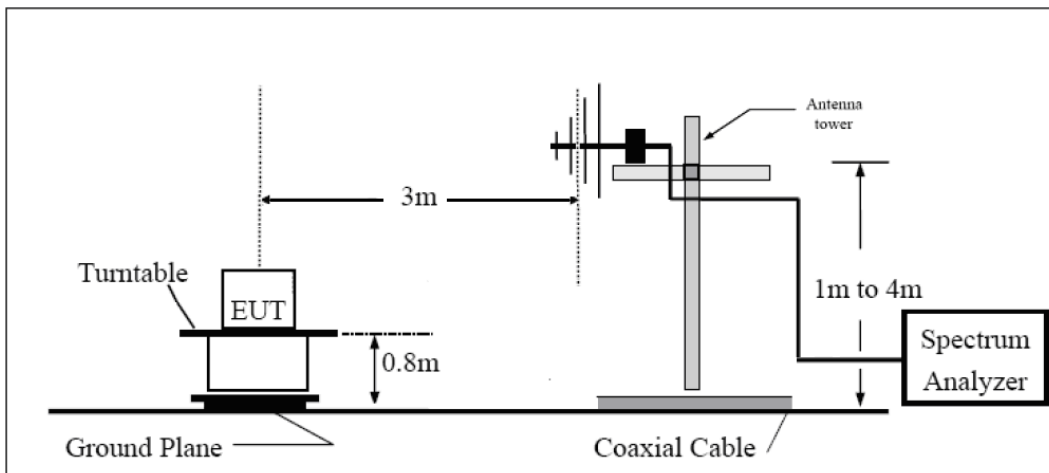
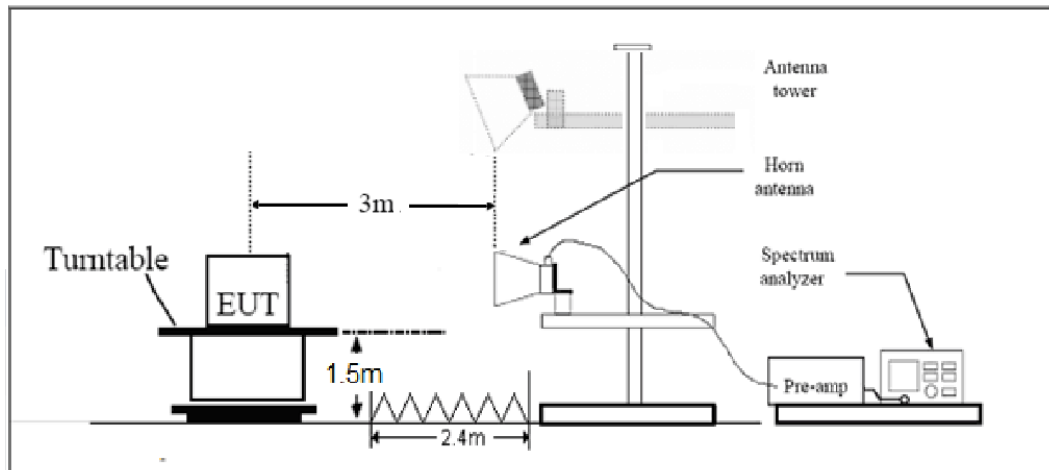
Test setup**9KHz ~ 30MHz****30MHz ~ 1GHz****Above 1GHz**

Note: Area side:2.4mX3.6m

**Limits**

Rule Part 15.247(d) specifies that "In addition, radiated emissions which fall in the restricted bands, as defined in § 15.205(a), must also comply with the radiated emission limits specified in § 15.209(a) (see § 15.205(c))."

Limit in restricted band

Frequency of emission (MHz)	Field strength(uV/m)	Field strength(dBuV/m)
0.009–0.490	2400/F(kHz)	/
0.490–1.705	24000/F(kHz)	/
1.705–30.0	30	/
30-88	100	40
88-216	150	43.5
216-960	200	46
Above960	500	54

§15.35(b)

There is also a limit on the radio frequency emissions, as measured using instrumentation with a peak detector function, corresponding to 20 dB above the maximum permitted average limit.

Peak Limit=74 dBuV/m

Average Limit=54 dBuV/m

Spurious Radiated Emissions are permitted in any of the frequency bands listed below:

MHz	MHz	MHz	GHz
0.090 - 0.110	16.42 - 16.423	399.9 - 410	4.5 - 5.15
¹ 0.495 - 0.505	16.69475 - 16.69525	608 - 614	5.35 - 5.46
2.1735 - 2.1905	16.80425 - 16.80475	960 - 1240	7.25 - 7.75
4.125 - 4.128	25.5 - 25.67	1300 - 1427	8.025 - 8.5
4.17725 - 4.17775	37.5 - 38.25	1435 - 1626.5	9.0 - 9.2
4.20725 - 4.20775	73 - 74.6	1645.5 - 1646.5	9.3 - 9.5
6.215 - 6.218	74.8 - 75.2	1660 - 1710	10.6 - 12.7
6.26775 - 6.26825	108 - 121.94	1718.8 - 1722.2	13.25 - 13.4
6.31175 - 6.31225	123 - 138	2200 - 2300	14.47 - 14.5
8.291 - 8.294	149.9 - 150.05	2310 - 2390	15.35 - 16.2
8.362 - 8.366	156.52475 - 156.52525	2483.5 - 2500	17.7 - 21.4
8.37625 - 8.38675	156.7 - 156.9	2690 - 2900	22.01 - 23.12
8.41425 - 8.41475	162.0125 - 167.17	3260 - 3267	23.6 - 24.0
12.29 - 12.293	167.72 - 173.2	3332 - 3339	31.2 - 31.8
12.51975 - 12.52025	240 - 285	3345.8 - 3358	36.43 - 36.5
12.57675 - 12.57725	322 - 335.4	3600 - 4400	(²)
13.36 - 13.41			

**Measurement Uncertainty**

The assessed measurement uncertainty to ensure 95% confidence level for the normal distribution is with the coverage factor $k = 1.96$.

Frequency	Uncertainty
9KHz-30MHz	3.55 dB
30MHz-200MHz	4.17 dB
200MHz-1GHz	4.84 dB
1-18GHz	4.35 dB
18-26.5GHz	5.90 dB
26.5GHz~40GHz	5.92 dB



Test Results:

A font (dB_{μV/m}) in the test plot =(dB μ V/m)

A font (dB_V/m) in the test plot =(dB μ V/m)

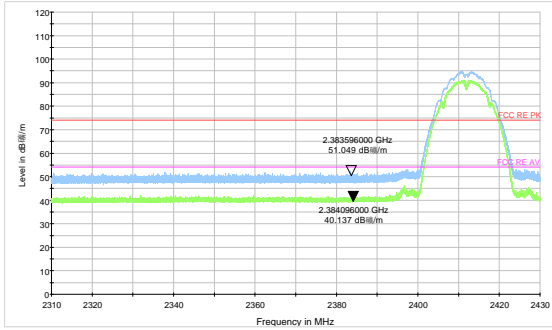

802.11b-Channel 1 Peak + Average

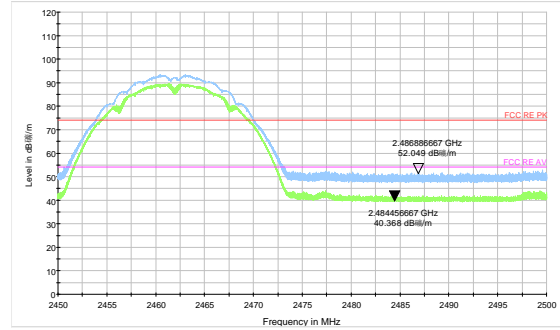

802.11b-Channel 1 Peak + Average

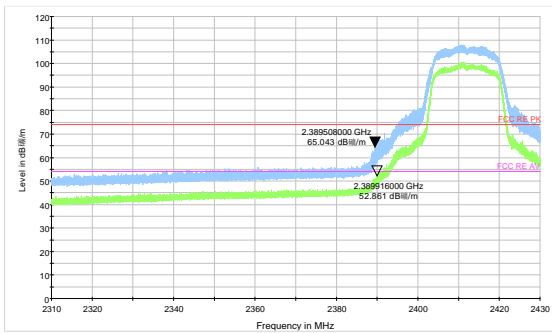

802.11g-Channel 1 Peak + Average

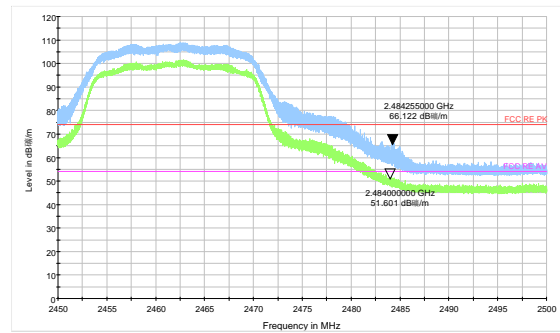

802.11g-Channel 1 Peak + Average

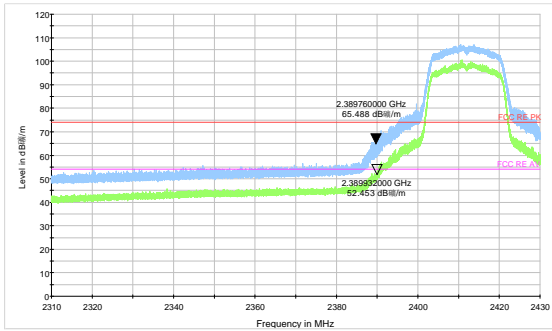

802.11n HT20 -Channel 1 Peak + Average

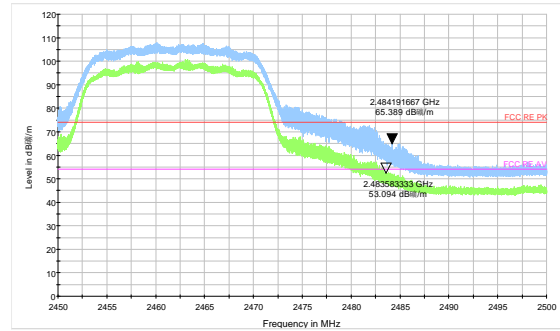

802.11n HT20 -Channel 1 Peak + Average

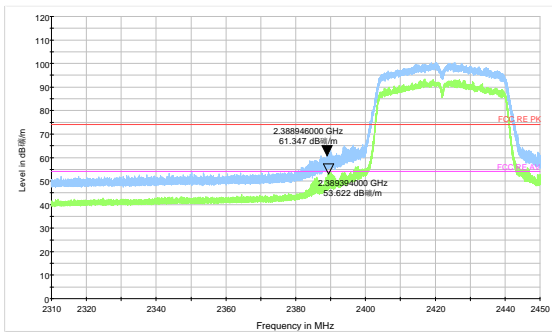

802.11n HT40 -Channel 3 Peak + Average

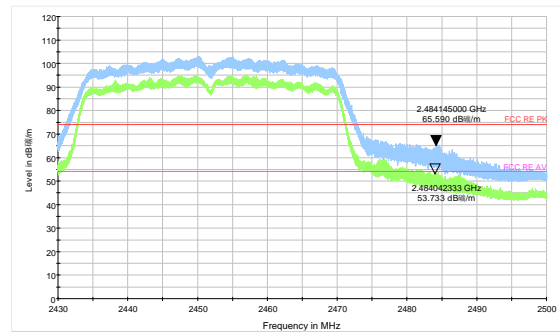

802.11n HT40 -Channel 9 Peak + Average



Result of RE

Test result

Sweep the whole frequency band through the range from 9kHz to the 10th harmonic of the carrier, the Emissions in the frequency band 9kHz-30MHz and 18GHz-26.5GHz are more than 20dB below the limit are not reported.

The following graphs display the maximum values of horizontal and vertical by software. For above 1GHz, Blue trace uses the peak detection, Green trace uses the average detection.

After the pretest, MIMO was selected as the worst antenna.

During the test, the Radiates Emission from 30MHz to 1GHz was performed in all modes with all channels, 802.11n (HT20) CH11 are selected as the worst condition. The test data of the worst-case condition was recorded in this report.

A font (Level in dB μ V/) in the test plot =(level in dB μ V/m)

Continuous TX mode:

FCC RE 9K-90KHz AV

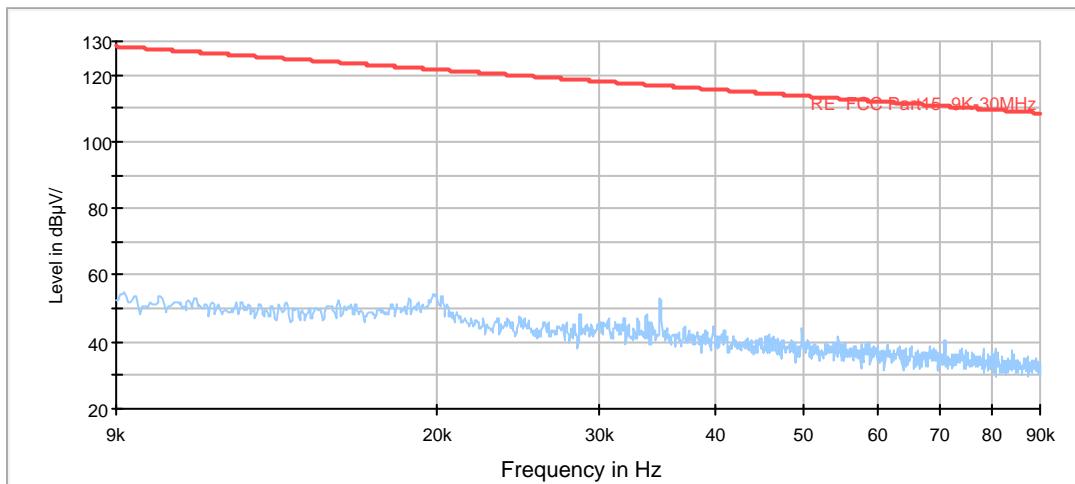

Radiates Emission from 9KHz to 90KHz

FCC RE 90K-110KHz QP

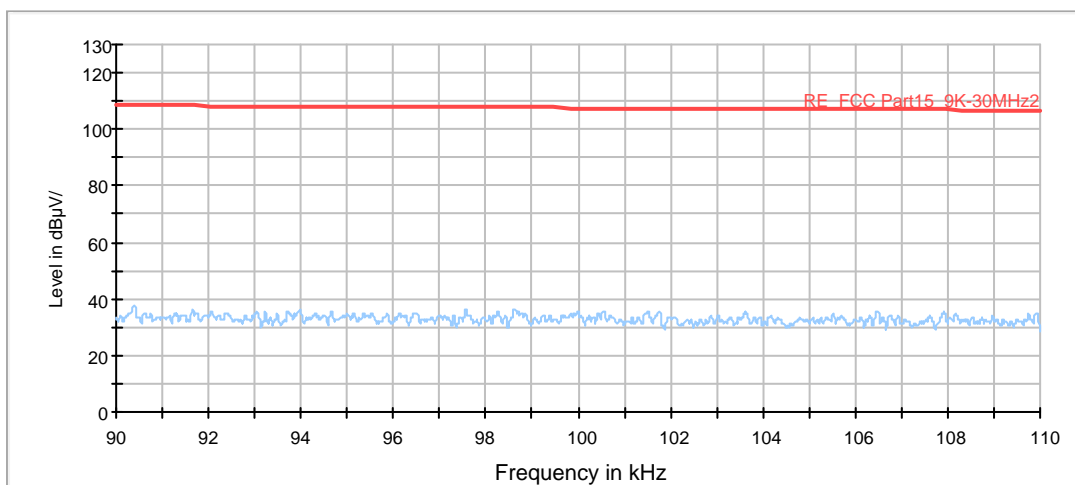

Radiates Emission from 90KHz to 110KHz



FCC RE 110K-490KHz AV

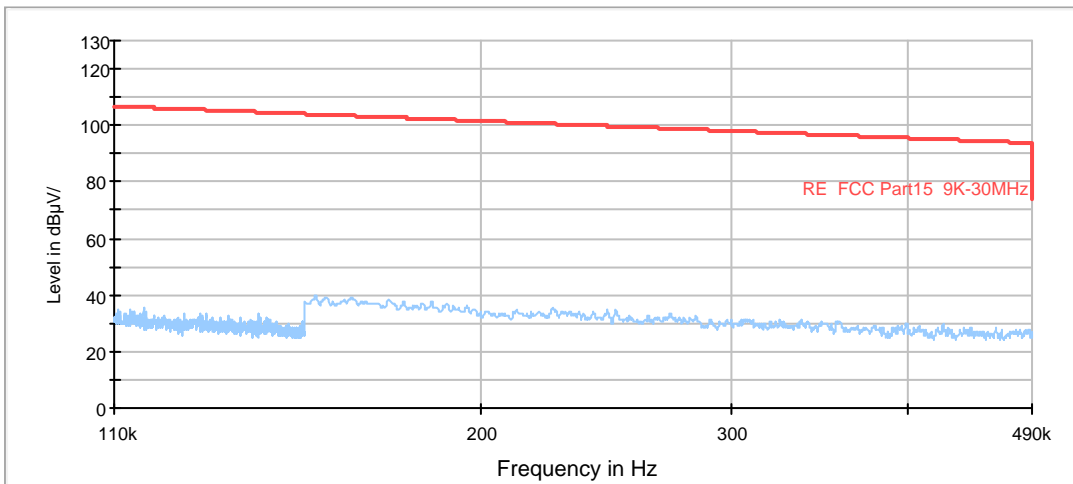

Radiates Emission from 110KHz to 490KHz

FCC RE 490K-30MHz QP

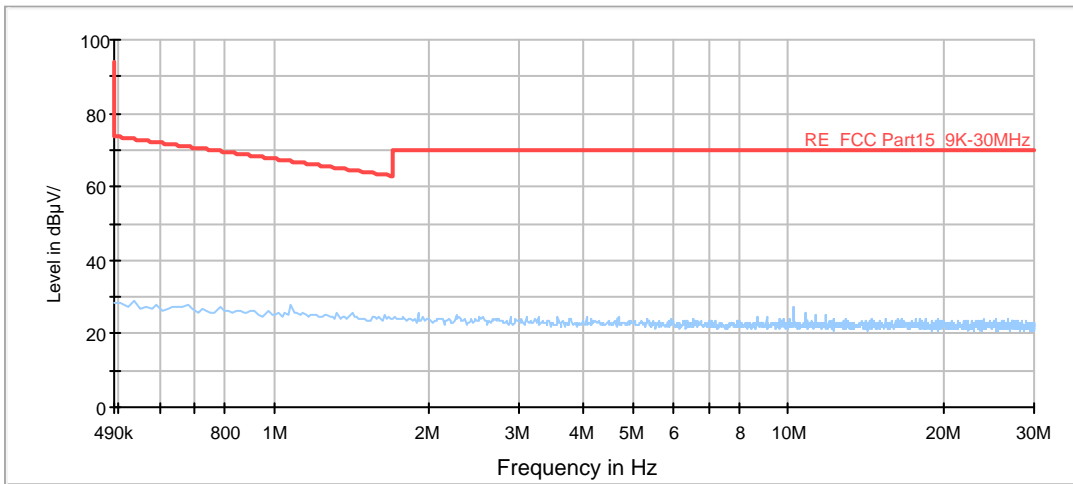

Radiates Emission from 490KHz to 30MHz

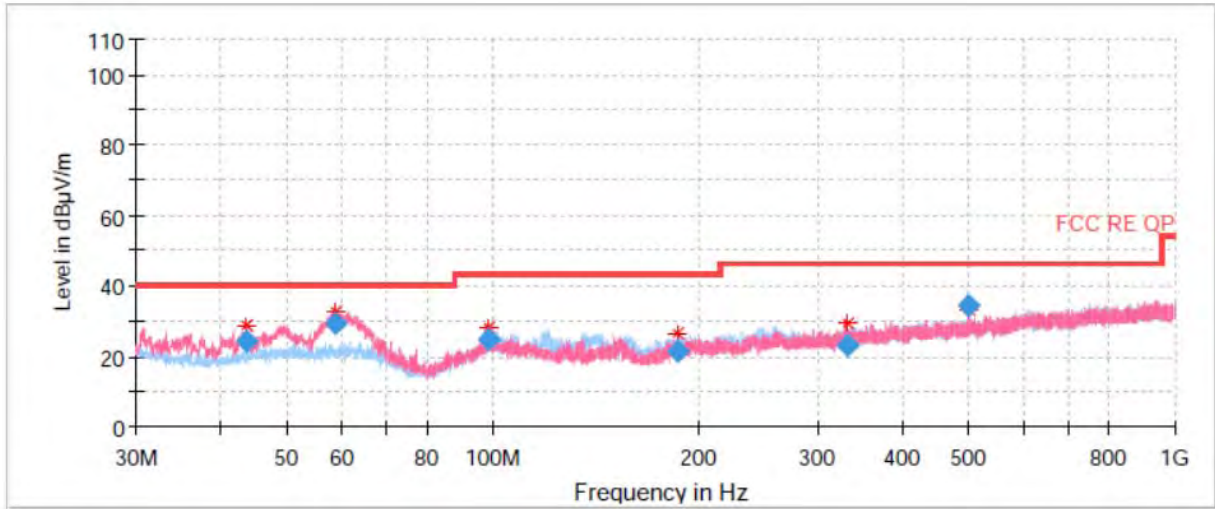

Radiates Emission from 30MHz to 1GHz

Frequency (MHz)	Quasi-Peak (dBuV/m)	Height (cm)	Polarization	Azimuth (deg)	Correct Factor (dB)	Margin (dB)	Limit (dBuV/m)
43.505585	24.31	100.0	V	328.0	-5	15.69	40.00
58.771470	29.26	100.0	V	322.0	-5	10.74	40.00
98.429590	24.96	225.0	H	64.0	-6	18.54	43.50
187.266000	21.55	175.0	H	279.0	-7	21.95	43.50
330.959667	22.95	125.0	V	69.0	-3	23.05	46.00
499.985000	34.36	175.0	H	149.0	0	11.64	46.00

Remark: 1. Correction Factor = Antenna factor+ Insertion loss(cable loss+amplifier gain)

2. Margin = Limit – Quasi-Peak

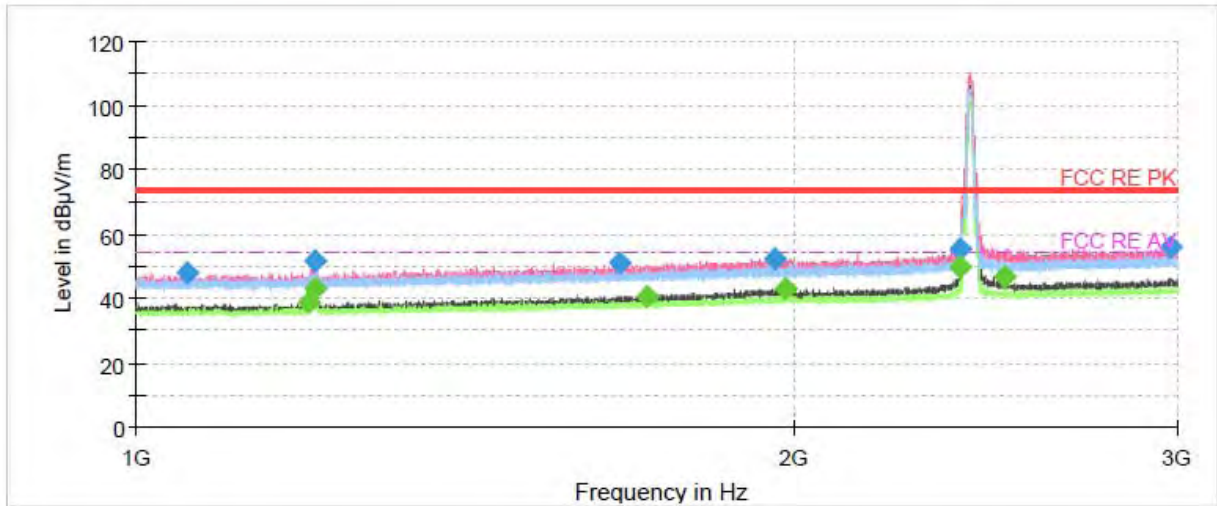
802.11b CH1

Note: The signal beyond the limit is carrier.
Radiates Emission from 1GHz to 3GHz

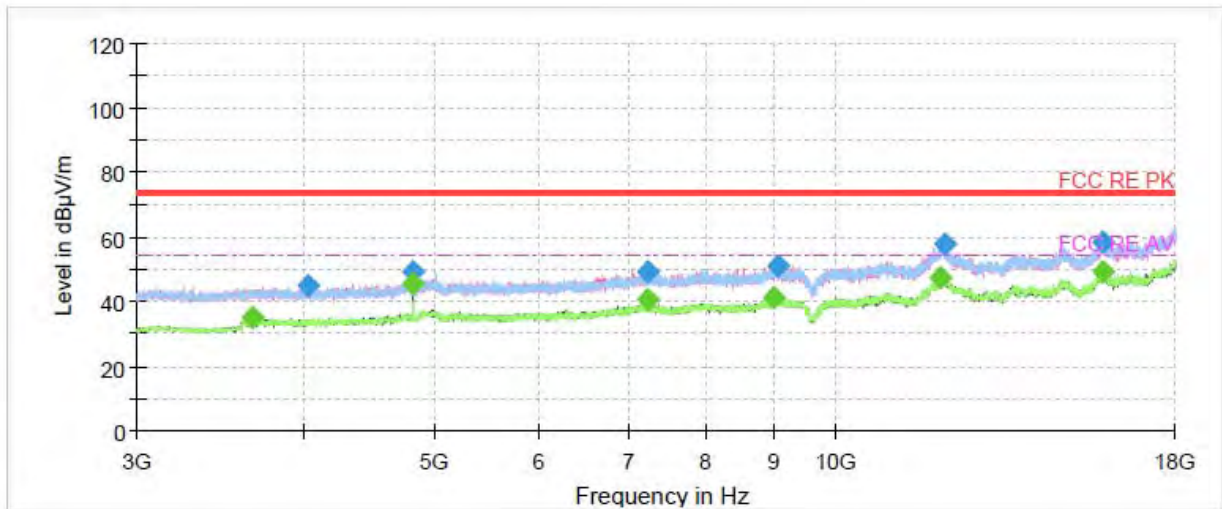

Radiates Emission from 3GHz to 18GHz



Frequency (MHz)	Peak (dBuV/m)	Average (dBuV/m)	Limit (dBuV/m)	Margin (dB)	Height (cm)	Polarization	Azimuth (deg)	Correct Factor (dB)
1055.466667	48.13	---	74.00	25.87	100.0	V	31.0	-10.8
1200.933333	---	38.94	54.00	15.06	200.0	V	95.0	-10.2
1206.733333	---	43.14	54.00	10.86	100.0	V	77.0	-10.2
1207.466667	51.40	---	74.00	22.60	100.0	V	77.0	-10.2
1664.800000	51.04	---	74.00	22.96	100.0	V	15.0	-7.4
1712.800000	---	40.75	54.00	13.25	200.0	V	287.0	-7.1
1963.133333	52.39	---	74.00	21.61	100.0	V	170.0	-5.8
1985.333333	---	43.23	54.00	10.77	200.0	V	324.0	-5.7
2387.266667	---	49.97	54.00	4.03	100.0	V	133.0	-4.6
2387.933333	55.69	---	74.00	18.31	100.0	V	109.0	-4.6
2499.133333	---	47.07	54.00	6.93	100.0	V	101.0	-4.5
2978.733333	55.92	---	74.00	18.08	200.0	V	179.0	-2.7
15901.500000	---	49.36	54.00	4.64	200.0	V	124.0	6.7

Remark: 1. Correction Factor = Antenna factor+ Insertion loss (cable loss + amplifier gain)

802.11b CH6

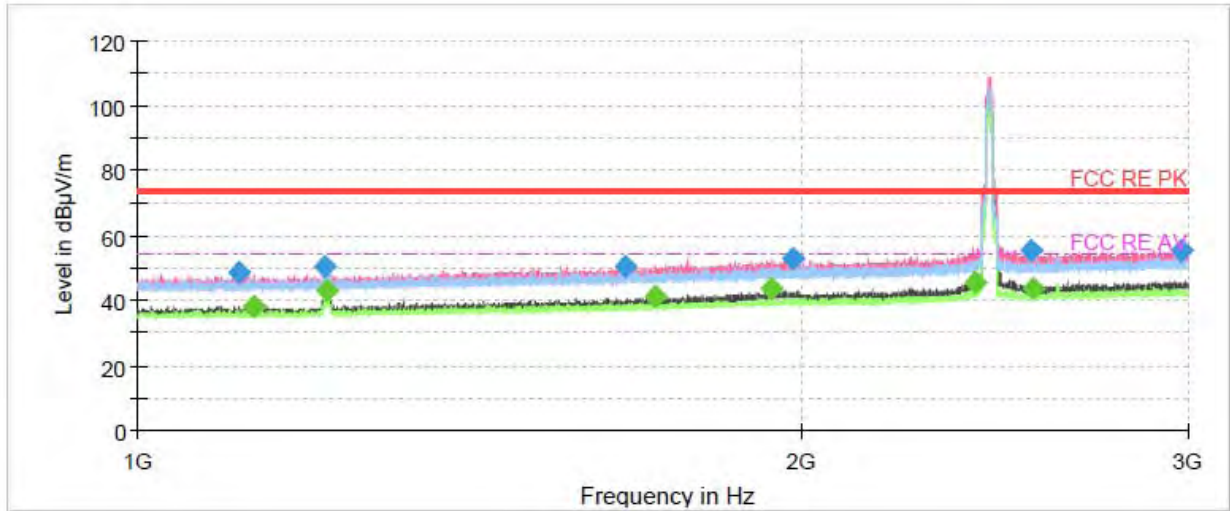

Note: The signal beyond the limit is carrier.
Radiates Emission from 1GHz to 3GHz

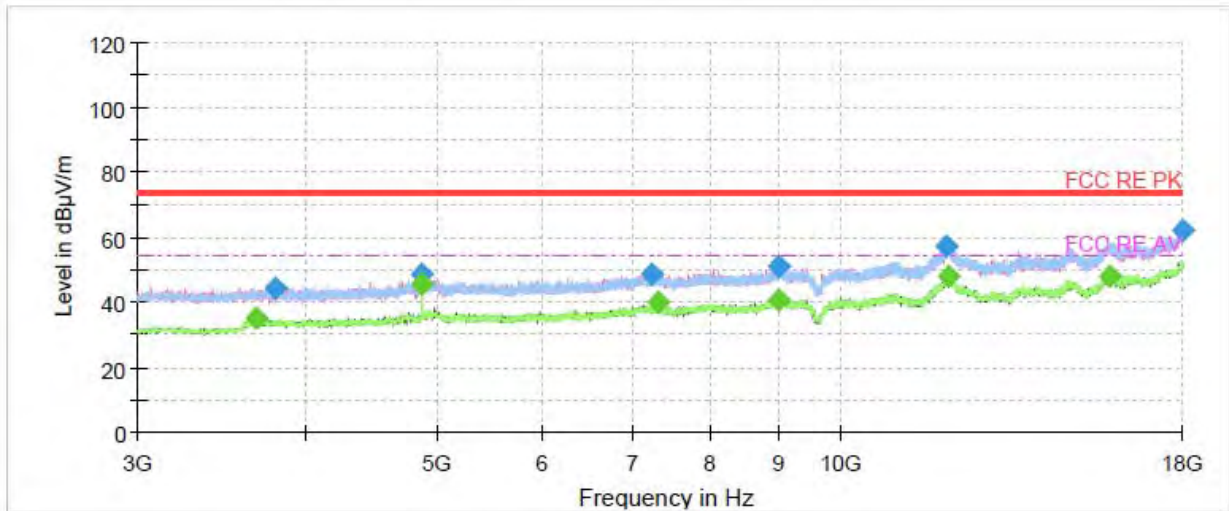

Radiates Emission from 3GHz to 18GHz



Frequency (MHz)	MaxPeak (dB μ V/m)	Average (dB μ V/m)	Limit (dB μ V/m)	Margin (dB)	Height (cm)	Pol	Azimuth (deg)	Corr. (dB/m)
1111.800000	48.35	---	74.00	25.65	200.0	V	286.0	-10.6
1129.600000	---	38.41	54.00	15.59	200.0	V	256.0	-10.6
1217.200000	50.20	---	74.00	23.80	200.0	V	316.0	-10.1
1217.933333	---	43.06	54.00	10.94	200.0	V	316.0	-10.1
1664.866667	50.55	---	74.00	23.45	200.0	V	256.0	-7.4
1719.066667	---	41.17	54.00	12.83	200.0	V	240.0	-7.0
1940.466667	---	43.47	54.00	10.53	200.0	V	256.0	-5.9
1983.733333	53.00	---	74.00	21.00	200.0	V	332.0	-5.7
2400.333333	---	45.55	54.00	8.45	200.0	V	308.0	-4.6
2547.333333	55.41	---	74.00	18.59	200.0	V	324.0	-4.4
2552.533333	---	43.89	54.00	10.11	200.0	V	324.0	-4.4
2978.666667	55.41	---	74.00	18.59	200.0	V	347.0	-2.7
12025.500000	---	48.08	54.00	5.92	100.0	V	301.0	5.9
15853.000000	---	48.25	54.00	5.75	100.0	H	314.0	6.4

Remark: 1. Correction Factor = Antenna factor+ Insertion loss (cable loss + amplifier gain)

802.11b CH11

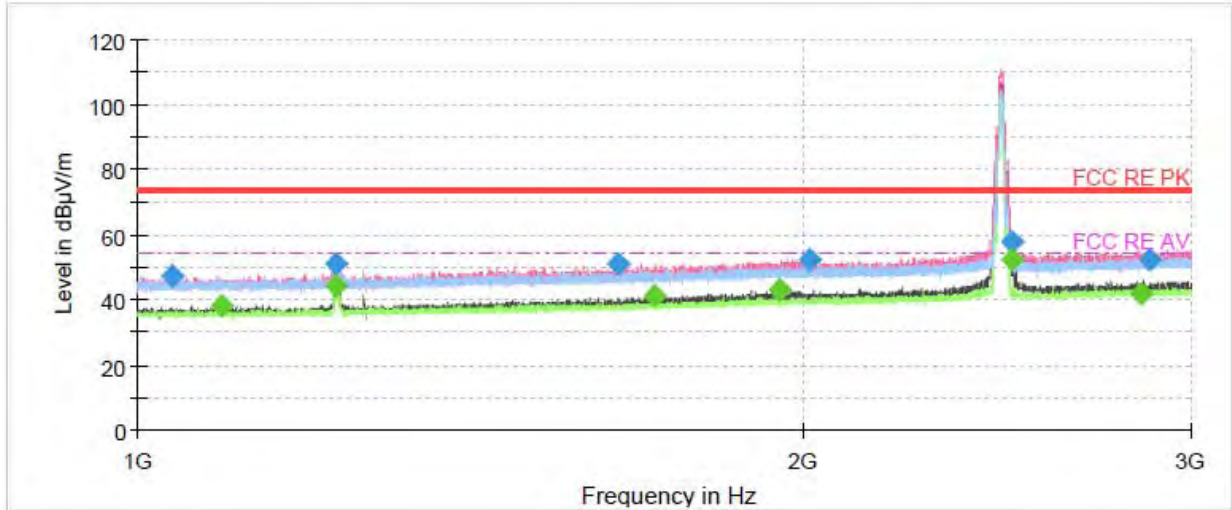

Note: The signal beyond the limit is carrier.
Radiates Emission from 1GHz to 3GHz

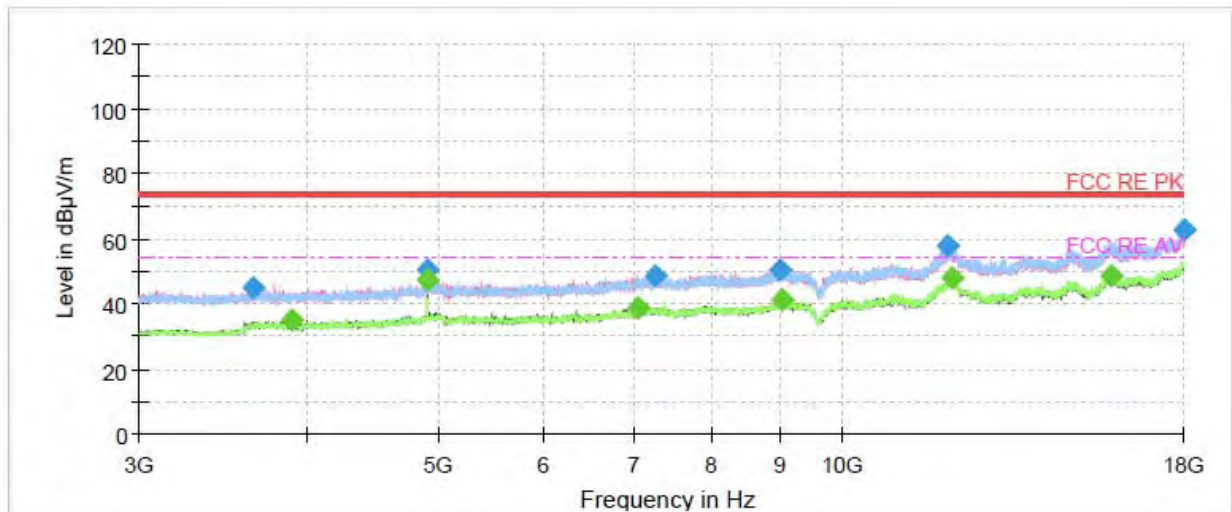

Radiates Emission from 3GHz to 18GHz



Frequency (MHz)	MaxPeak (dB μ V/m)	Average (dB μ V/m)	Limit (dB μ V/m)	Margin (dB)	Height (cm)	Pol	Azimuth (deg)	Corr. (dB/m)
1037.533333	47.53	---	74.00	26.47	200.0	V	29.0	-10.8
1090.666667	---	38.10	54.00	15.90	200.0	V	102.0	-10.7
1229.333333	---	44.28	54.00	9.72	100.0	V	260.0	-10.0
1229.666667	50.88	---	74.00	23.12	100.0	V	251.0	-10.0
1649.133333	50.89	---	74.00	23.11	200.0	V	37.0	-7.5
1715.466667	---	41.18	54.00	12.82	200.0	V	21.0	-7.1
1952.533333	---	42.91	54.00	11.09	200.0	V	21.0	-5.8
2014.266667	52.33	---	74.00	21.67	200.0	V	13.0	-5.5
2490.933333	---	52.16	54.00	1.84	200.0	V	111.0	-4.5
2491.133333	58.08	---	74.00	15.92	200.0	V	102.0	-4.5
2850.133333	---	41.64	54.00	12.36	200.0	H	317.0	-3.2
2877.400000	52.46	---	74.00	21.54	200.0	V	5.0	-3.1
15897.500000	---	48.49	54.00	5.51	100.0	V	0.0	6.7

Remark: 1. Correction Factor = Antenna factor+ Insertion loss (cable loss + amplifier gain)

802.11g CH1

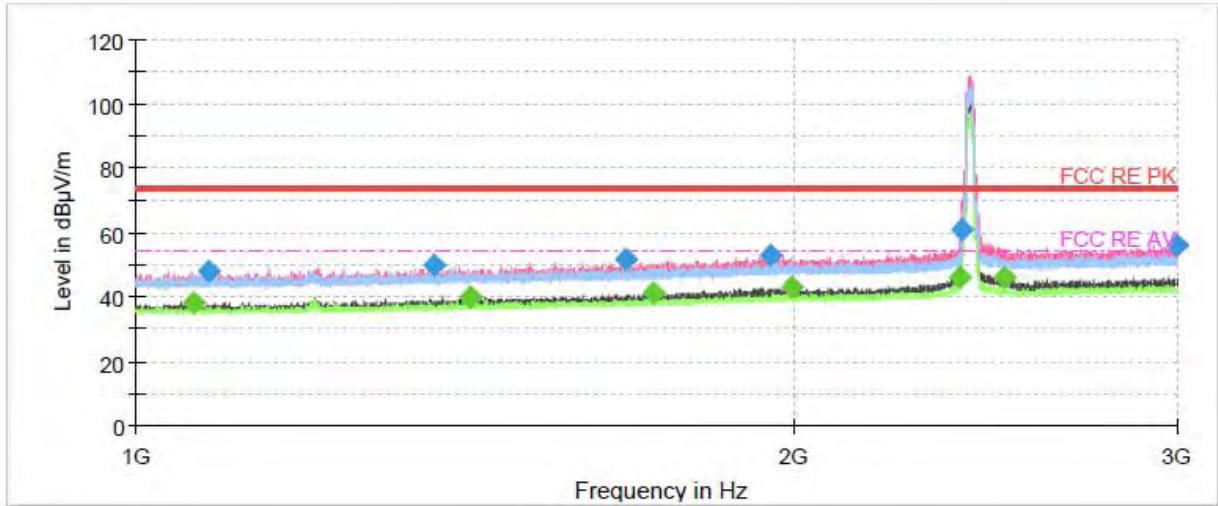

Note: The signal beyond the limit is carrier.
Radiates Emission from 1GHz to 3GHz

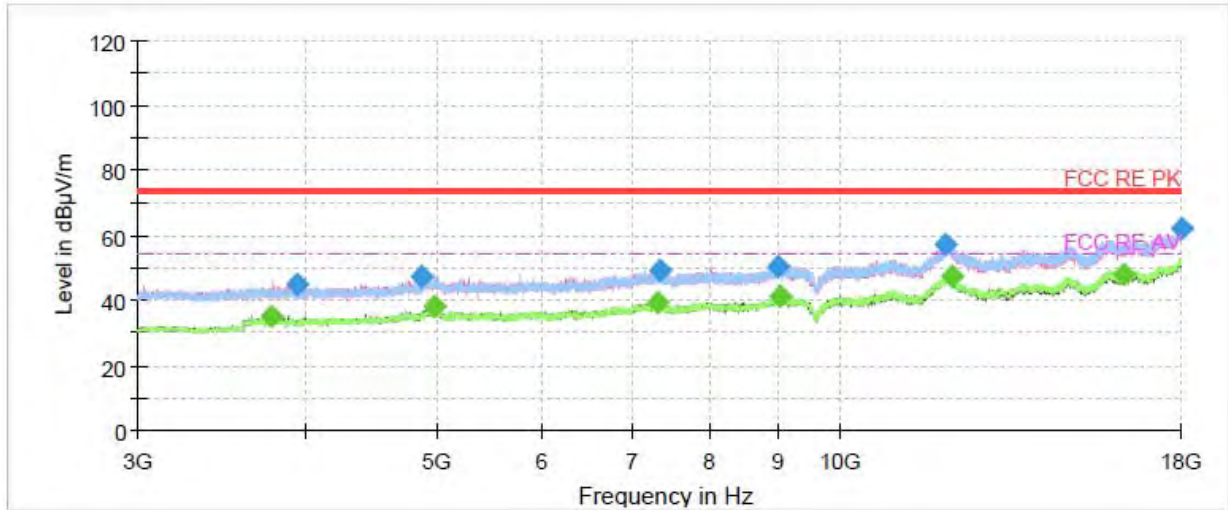

Radiates Emission from 3GHz to 18GHz



Frequency (MHz)	MaxPeak (dB μ V/m)	Average (dB μ V/m)	Limit (dB μ V/m)	Margin (dB)	Height (cm)	Pol	Azimuth (deg)	Corr. (dB/m)
1063.466667	---	38.21	54.00	15.79	100.0	V	7.0	-10.7
1079.466667	47.96	---	74.00	26.04	100.0	V	30.0	-10.7
1370.266667	49.55	---	74.00	24.45	100.0	V	7.0	-9.1
1422.266667	---	39.97	54.00	14.03	100.0	V	38.0	-8.8
1677.600000	51.85	---	74.00	22.15	100.0	V	55.0	-7.3
1727.400000	---	41.35	54.00	12.65	100.0	V	15.0	-7.0
1952.200000	52.94	---	74.00	21.06	100.0	V	47.0	-5.8
1996.400000	---	42.91	54.00	11.09	100.0	V	0.0	-5.6
2386.466667	---	46.34	54.00	7.66	100.0	V	92.0	-4.6
2388.466667	61.23	---	74.00	12.77	100.0	V	114.0	-4.6
2499.200000	---	46.17	54.00	7.83	100.0	V	55.0	-4.5
2998.666667	55.80	---	74.00	18.20	100.0	V	72.0	-2.7

Remark: 1. Correction Factor = Antenna factor+ Insertion loss (cable loss + amplifier gain)

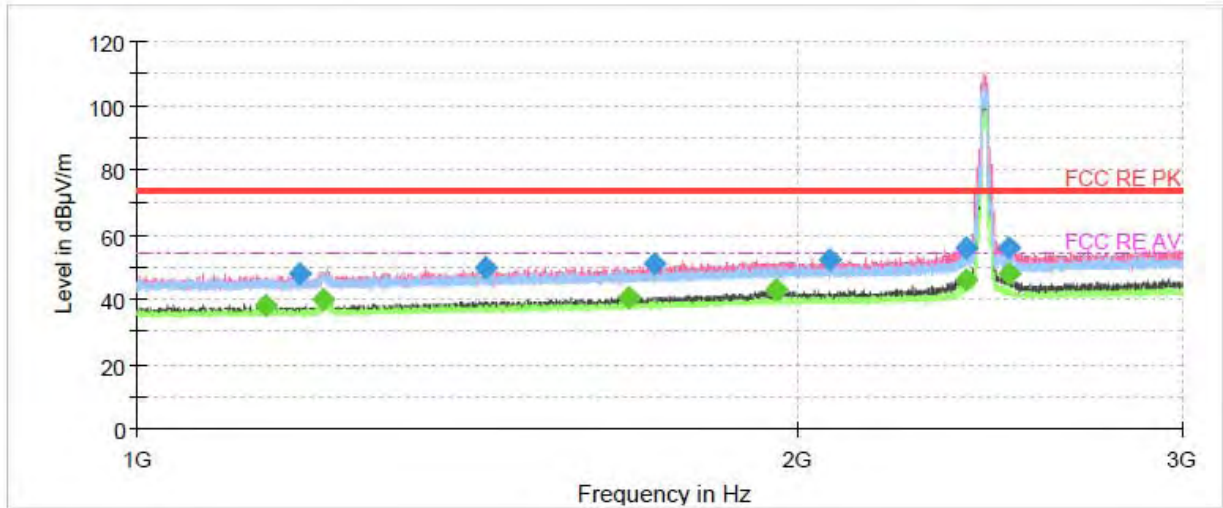
802.11g CH6

Note: The signal beyond the limit is carrier.
Radiates Emission from 1GHz to 3GHz

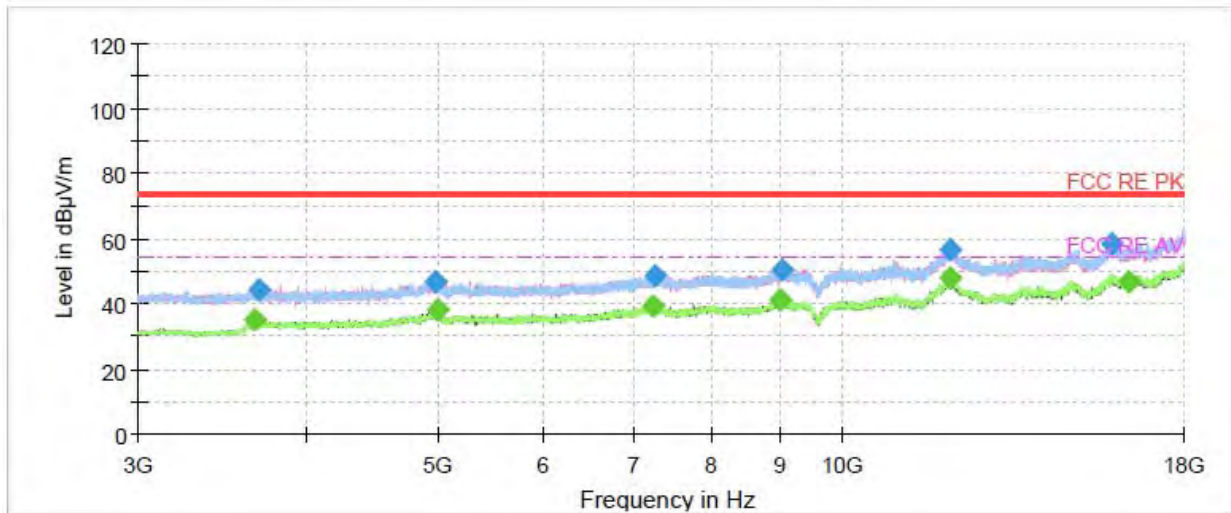

Radiates Emission from 3GHz to 18GHz



Frequency (MHz)	MaxPeak (dB μ V/m)	Average (dB μ V/m)	Limit (dB μ V/m)	Margin (dB)	Height (cm)	Pol	Azimuth (deg)	Corr. (dB/m)
1144.400000	---	38.01	54.00	15.99	100.0	V	1.0	-10.4
1187.266667	47.92	---	74.00	26.08	100.0	V	61.0	-10.2
1215.533333	---	40.16	54.00	13.84	100.0	H	214.0	-10.1
1441.600000	49.64	---	74.00	24.36	100.0	V	12.0	-8.7
1676.533333	---	40.81	54.00	13.19	100.0	V	52.0	-7.3
1722.333333	50.90	---	74.00	23.10	100.0	V	61.0	-7.0
1959.000000	---	43.02	54.00	10.98	100.0	V	44.0	-5.8
2071.733333	52.24	---	74.00	21.76	100.0	V	5.0	-5.4
2388.466667	55.86	---	74.00	18.14	100.0	V	70.0	-4.6
2389.333333	---	46.39	54.00	7.61	200.0	V	200.0	-4.6
2498.200000	---	47.93	54.00	6.07	200.0	V	78.0	-4.5
2499.600000	55.78	---	74.00	18.22	200.0	V	252.0	-4.5

Remark: 1. Correction Factor = Antenna factor+ Insertion loss (cable loss + amplifier gain)

802.11g CH11

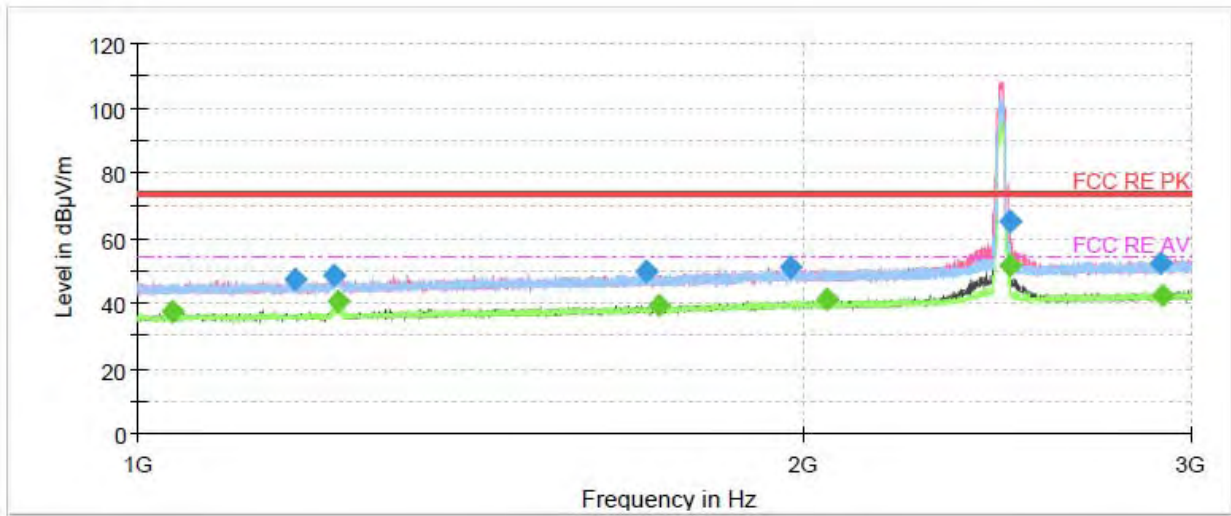

Note: The signal beyond the limit is carrier.
Radiates Emission from 1GHz to 3GHz

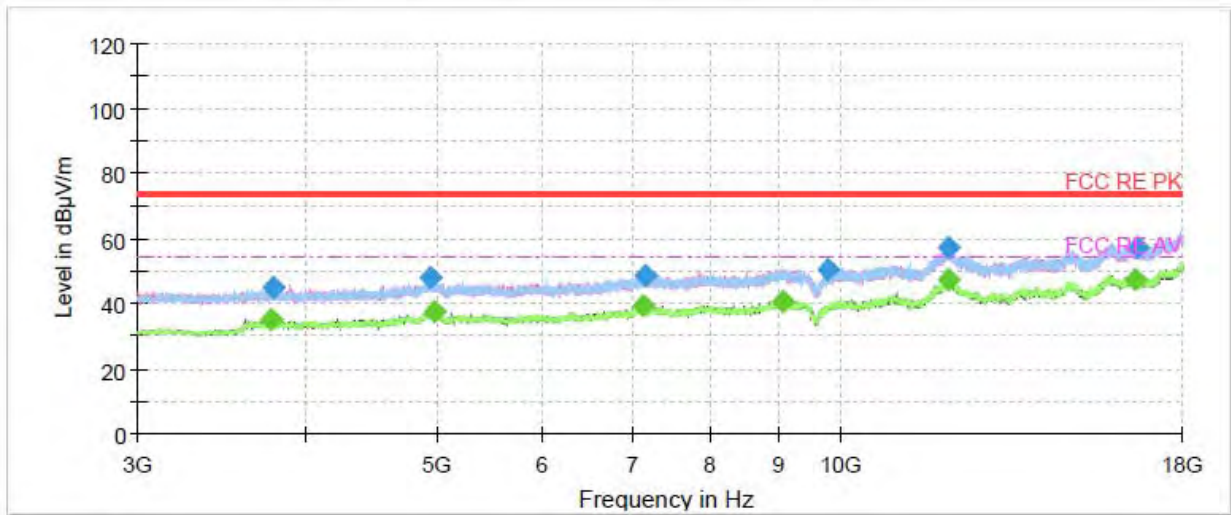

Radiates Emission from 3GHz to 18GHz



Frequency (MHz)	MaxPeak (dB μ V/m)	Average (dB μ V/m)	Limit (dB μ V/m)	Margin (dB)	Height (cm)	Pol	Azimuth (deg)	Corr. (dB/m)
1036.333333	---	37.59	54.00	16.41	100.0	H	346.0	-10.8
1177.200000	47.64	---	74.00	26.36	200.0	V	245.0	-10.3
1228.066667	48.91	---	74.00	25.09	200.0	H	56.0	-10.0
1232.133333	---	40.38	54.00	13.62	100.0	V	99.0	-10.0
1701.133333	49.59	---	74.00	24.41	200.0	V	260.0	-7.2
1723.133333	---	39.58	54.00	14.42	200.0	H	4.0	-7.0
1974.066667	51.22	---	74.00	22.78	100.0	H	338.0	-5.7
2052.800000	---	41.07	54.00	12.93	100.0	H	0.0	-5.5
2483.933333	---	51.45	54.00	2.55	100.0	V	84.0	-4.5
2484.600000	65.07	---	74.00	8.93	100.0	V	77.0	-4.5
2904.666667	52.29	---	74.00	21.71	100.0	V	151.0	-3.0
2913.600000	---	42.48	54.00	11.52	100.0	V	0.0	-3.0

Remark: 1. Correction Factor = Antenna factor+ Insertion loss (cable loss + amplifier gain)

802.11n (HT20) CH1

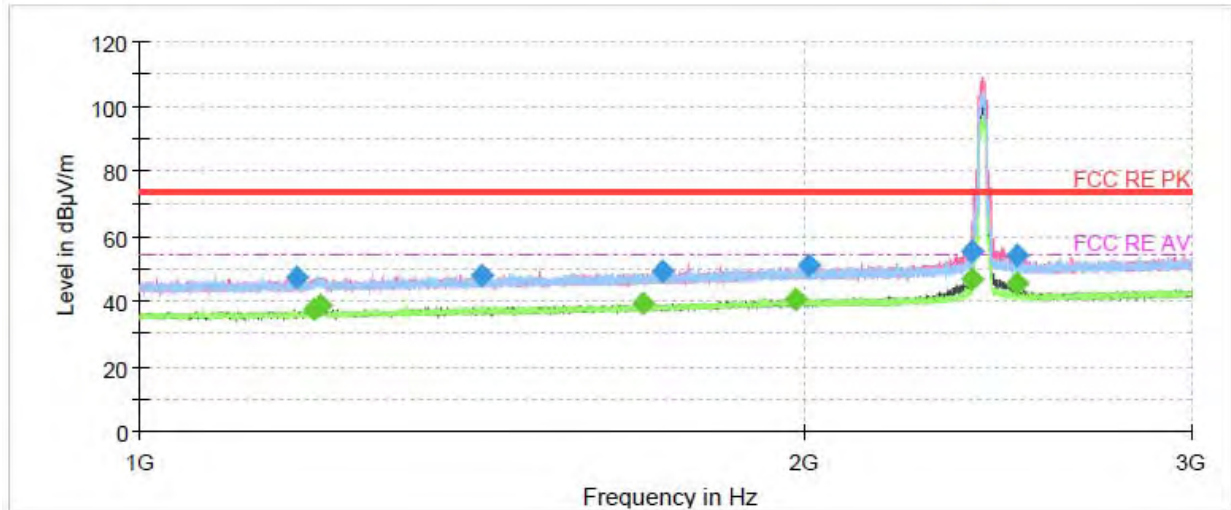

Note: The signal beyond the limit is carrier.
Radiates Emission from 1GHz to 3GHz

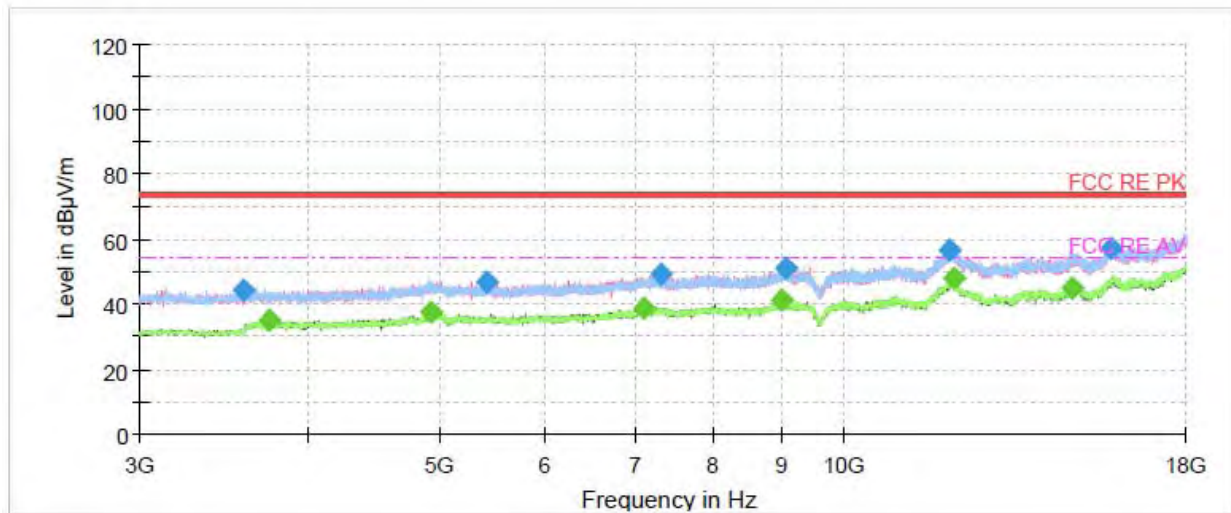

Radiates Emission from 3GHz to 18GHz



Frequency (MHz)	MaxPeak (dB μ V/m)	Average (dB μ V/m)	Limit (dB μ V/m)	Margin (dB)	Height (cm)	Pol	Azimuth (deg)	Corr. (dB/m)
1177.200000	47.37	---	74.00	26.63	100.0	V	28.0	-10.3
1200.666667	---	37.51	54.00	16.49	100.0	V	101.0	-10.2
1206.866667	---	38.83	54.00	15.17	200.0	V	104.0	-10.2
1429.066667	48.00	---	74.00	26.00	200.0	V	247.0	-8.7
1690.200000	---	39.44	54.00	14.56	100.0	H	0.0	-7.2
1724.933333	49.28	---	74.00	24.72	100.0	V	35.0	-7.0
1982.333333	---	40.82	54.00	13.18	100.0	H	120.0	-5.7
2010.533333	51.10	---	74.00	22.90	200.0	H	2.0	-5.6
2383.133333	55.56	---	74.00	18.44	100.0	V	79.0	-4.6
2383.333333	---	46.73	54.00	7.27	100.0	V	93.0	-4.6
2498.333333	54.24	---	74.00	19.76	100.0	V	245.0	-4.5
2498.733333	---	45.73	54.00	8.27	100.0	V	116.0	-4.5

Remark: 1. Correction Factor = Antenna factor+ Insertion loss (cable loss + amplifier gain)

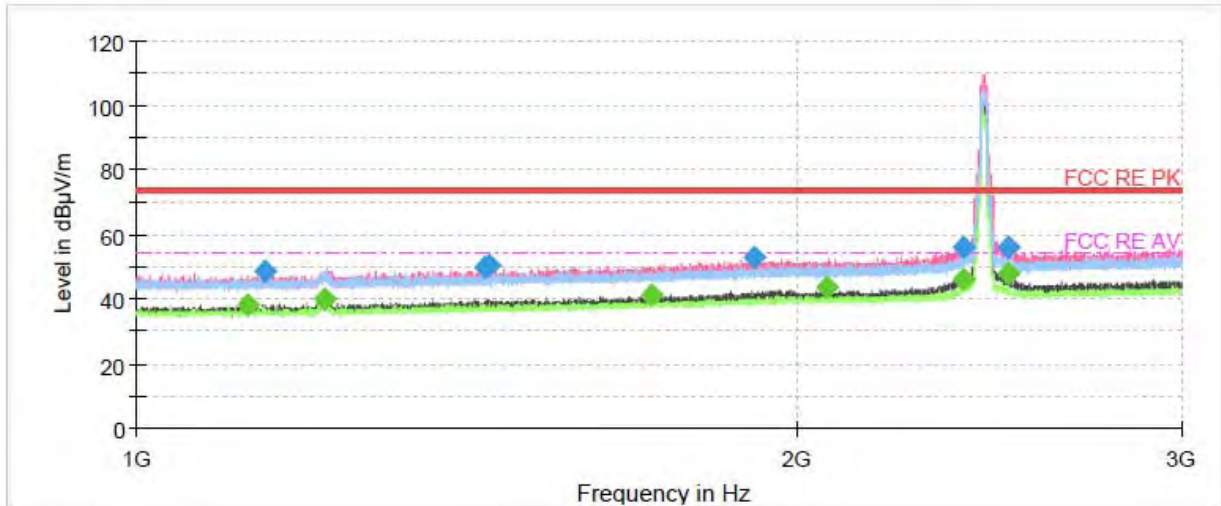
802.11n (HT20) CH6

Note: The signal beyond the limit is carrier.
Radiates Emission from 1GHz to 3GHz

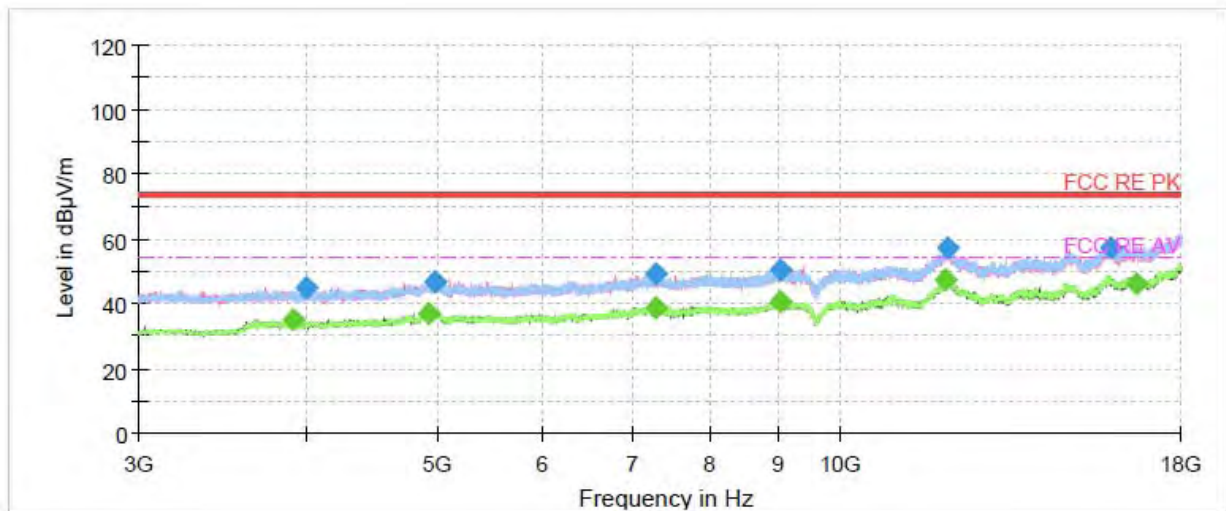

Radiates Emission from 3GHz to 18GHz



Frequency (MHz)	MaxPeak (dB μ V/m)	Average (dB μ V/m)	Limit (dB μ V/m)	Margin (dB)	Height (cm)	Pol	Azimuth (deg)	Corr. (dB/m)
1123.600000	---	38.23	54.00	15.77	100.0	V	19.0	-10.6
1143.866667	48.79	---	74.00	25.21	100.0	V	3.0	-10.4
1219.333333	---	40.21	54.00	13.79	100.0	H	198.0	-10.1
1441.200000	50.00	---	74.00	24.00	100.0	V	34.0	-8.7
1448.200000	50.68	---	74.00	23.32	100.0	V	0.0	-8.6
1717.066667	---	41.30	54.00	12.70	100.0	V	60.0	-7.0
1915.733333	53.12	---	74.00	20.88	100.0	V	60.0	-6.0
2064.266667	---	43.69	54.00	10.31	100.0	V	19.0	-5.5
2387.933333	56.11	---	74.00	17.89	100.0	V	69.0	-4.6
2388.066667	---	46.30	54.00	7.70	200.0	V	206.0	-4.6
2498.466667	---	47.80	54.00	6.20	100.0	V	69.0	-4.5
2499.066667	56.18	---	74.00	17.82	200.0	V	259.0	-4.5

Remark: 1. Correction Factor = Antenna factor+ Insertion loss (cable loss + amplifier gain)

802.11n (HT20) CH11

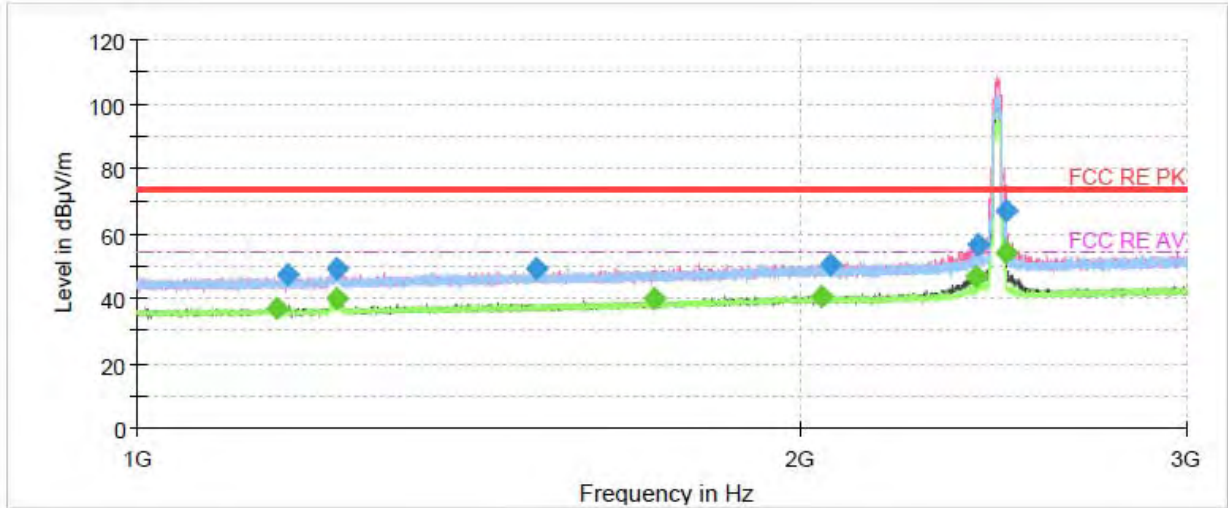

Note: The signal beyond the limit is carrier.
Radiates Emission from 1GHz to 3GHz

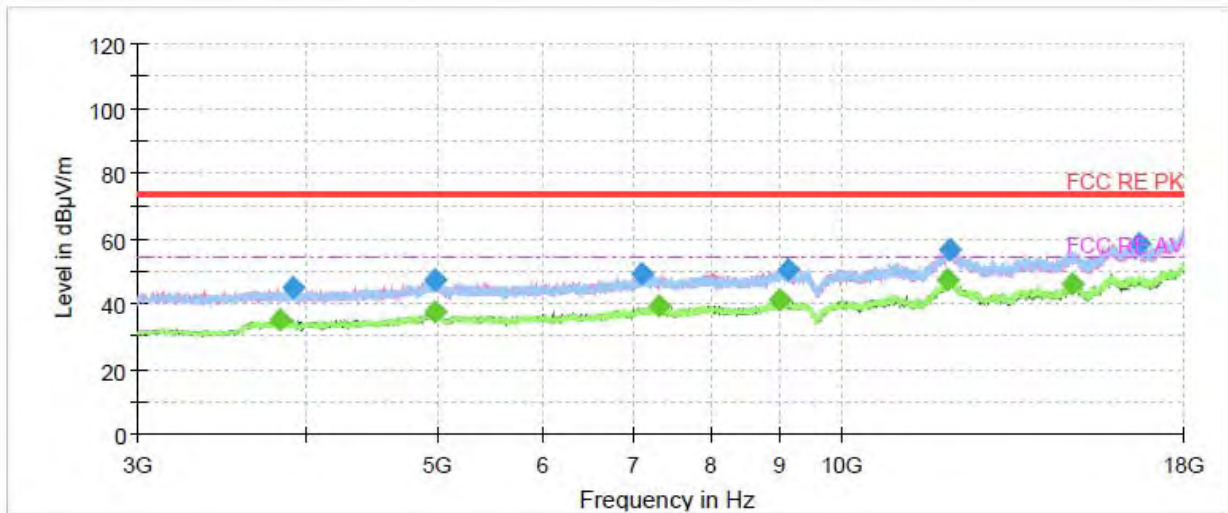

Radiates Emission from 3GHz to 18GHz



Frequency (MHz)	MaxPeak (dB μ V/m)	Average (dB μ V/m)	Limit (dB μ V/m)	Margin (dB)	Height (cm)	Pol	Azimuth (deg)	Corr. (dB/m)
1157.000000	---	37.19	54.00	16.81	100.0	H	284.0	-10.4
1170.933333	47.17	---	74.00	26.83	200.0	V	207.0	-10.3
1231.666667	---	39.80	54.00	14.20	100.0	V	42.0	-10.0
1232.000000	48.99	---	74.00	25.01	100.0	H	217.0	-10.0
1519.733333	49.30	---	74.00	24.70	100.0	V	205.0	-8.2
1719.066667	---	39.85	54.00	14.15	200.0	H	72.0	-7.0
2046.866667	---	40.79	54.00	13.21	200.0	V	281.0	-5.5
2067.466667	50.65	---	74.00	23.35	200.0	V	252.0	-5.5
2407.666667	---	46.71	54.00	7.29	100.0	V	108.0	-4.7
2413.466667	56.75	---	74.00	17.25	100.0	V	64.0	-4.7
2484.600000	---	53.99	54.00	0.01	200.0	V	78.0	-4.5
2484.866667	67.03	---	74.00	6.97	200.0	V	102.0	-4.5

Remark: 1. Correction Factor = Antenna factor+ Insertion loss (cable loss + amplifier gain)

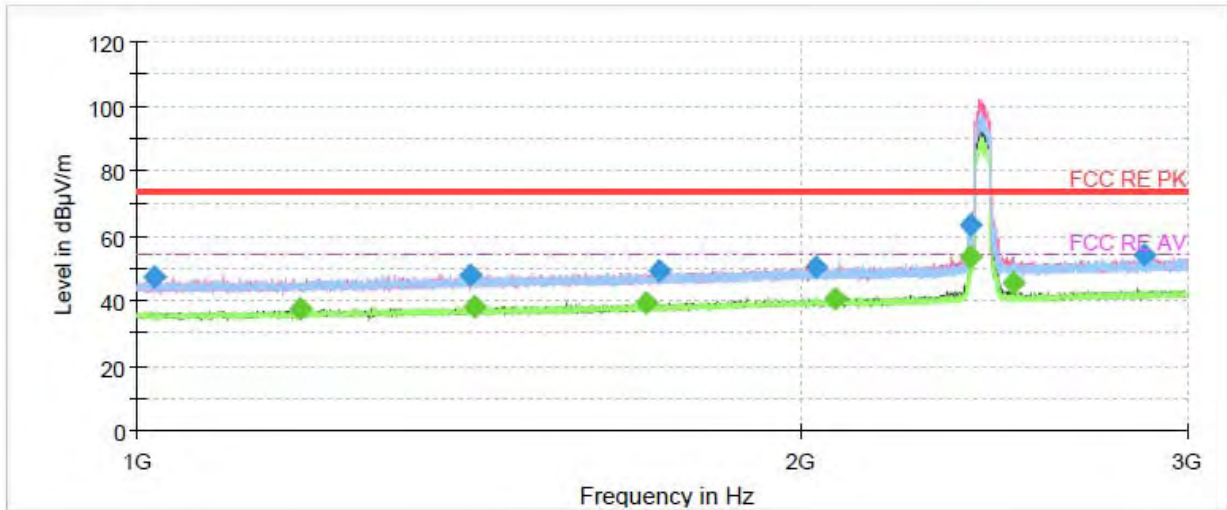
802.11n (HT40) CH3

Note: The signal beyond the limit is carrier.
Radiates Emission from 1GHz to 3GHz

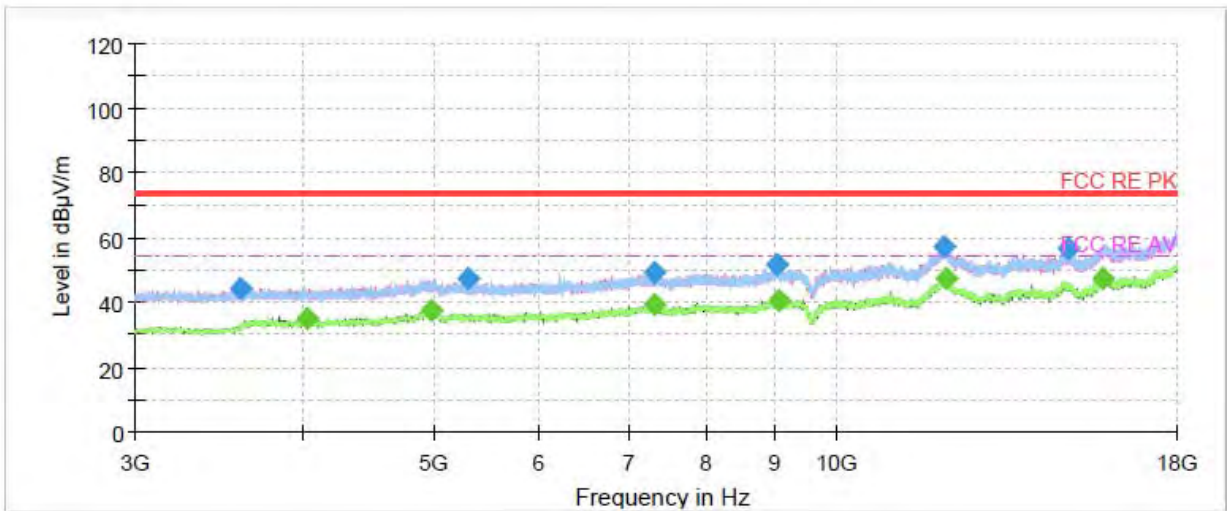

Radiates Emission from 3GHz to 18GHz



Frequency (MHz)	MaxPeak (dB μ V/m)	Average (dB μ V/m)	Limit (dB μ V/m)	Margin (dB)	Height (cm)	Pol	Azimuth (deg)	Corr. (dB/m)
1018.733333	47.51	---	74.00	26.49	200.0	H	207.0	-10.7
1186.800000	---	37.47	54.00	16.53	100.0	H	129.0	-10.2
1415.333333	48.14	---	74.00	25.86	100.0	V	66.0	-8.8
1422.200000	---	38.25	54.00	15.75	100.0	H	322.0	-8.8
1704.200000	---	39.21	54.00	14.79	100.0	H	285.0	-7.2
1724.666667	49.04	---	74.00	24.96	100.0	H	337.0	-7.0
2034.600000	50.57	---	74.00	23.43	100.0	H	300.0	-5.5
2075.400000	---	40.72	54.00	13.28	100.0	H	330.0	-5.4
2389.066667	---	53.68	54.00	0.32	100.0	V	113.0	-4.6
2389.333333	63.36	---	74.00	10.64	100.0	V	74.0	-4.6
2499.333333	---	45.29	54.00	8.71	200.0	V	237.0	-4.5
2867.133333	53.91	---	74.00	20.09	100.0	H	18.0	-3.1

Remark: 1. Correction Factor = Antenna factor+ Insertion loss (cable loss + amplifier gain)

802.11n (HT40) CH6

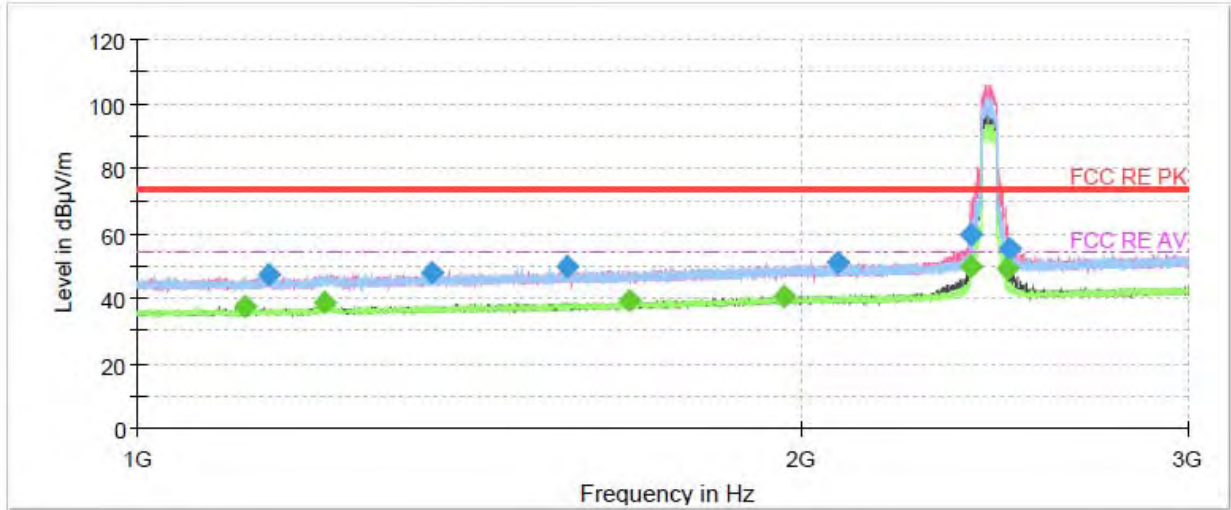

Note: The signal beyond the limit is carrier.
Radiates Emission from 1GHz to 3GHz

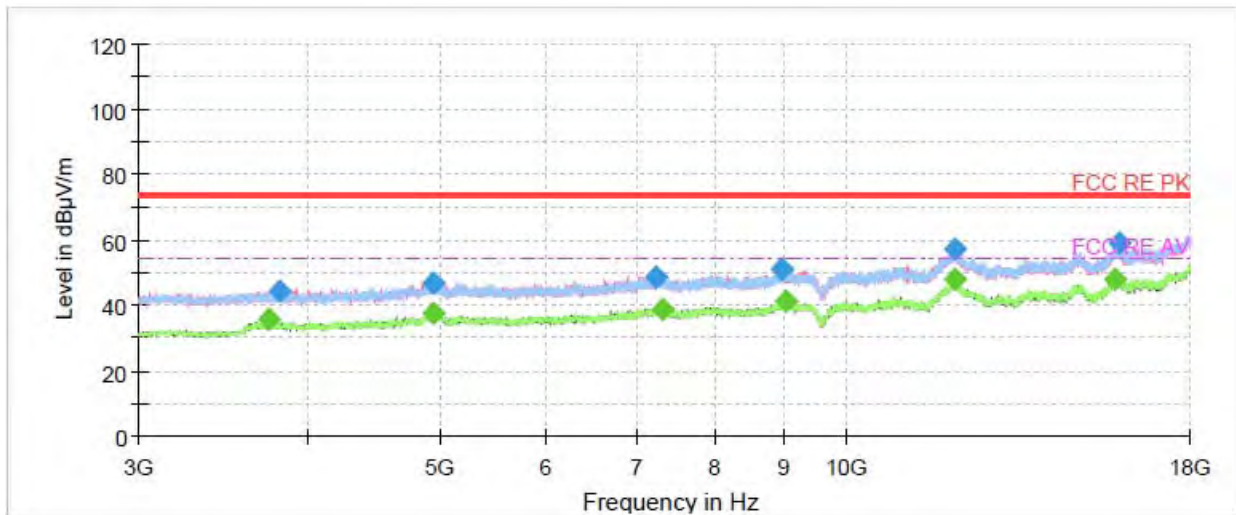

Radiates Emission from 3GHz to 18GHz



Frequency (MHz)	MaxPeak (dB μ V/m)	Average (dB μ V/m)	Limit (dB μ V/m)	Margin (dB)	Height (cm)	Pol	Azimuth (deg)	Corr. (dB/m)
1118.466667	---	37.40	54.00	16.60	100.0	V	283.0	-10.6
1147.533333	47.11	---	74.00	26.89	200.0	V	159.0	-10.4
1215.066667	---	38.47	54.00	15.53	200.0	V	352.0	-10.1
1361.333333	48.14	---	74.00	25.86	200.0	H	92.0	-9.1
1566.866667	49.85	---	74.00	24.15	100.0	H	215.0	-7.9
1671.266667	---	39.14	54.00	14.86	200.0	H	151.0	-7.3
1964.666667	---	40.90	54.00	13.10	100.0	H	304.0	-5.8
2079.466667	50.96	---	74.00	23.04	200.0	V	196.0	-5.4
2389.000000	59.92	---	74.00	14.08	100.0	V	58.0	-4.6
2389.466667	---	50.14	54.00	3.86	100.0	V	81.0	-4.6
2484.266667	---	49.02	54.00	4.98	200.0	V	90.0	-4.5
2488.733333	55.54	---	74.00	18.46	100.0	V	229.0	-4.5

Remark: 1. Correction Factor = Antenna factor+ Insertion loss (cable loss + amplifier gain)

802.11n (HT40) CH9

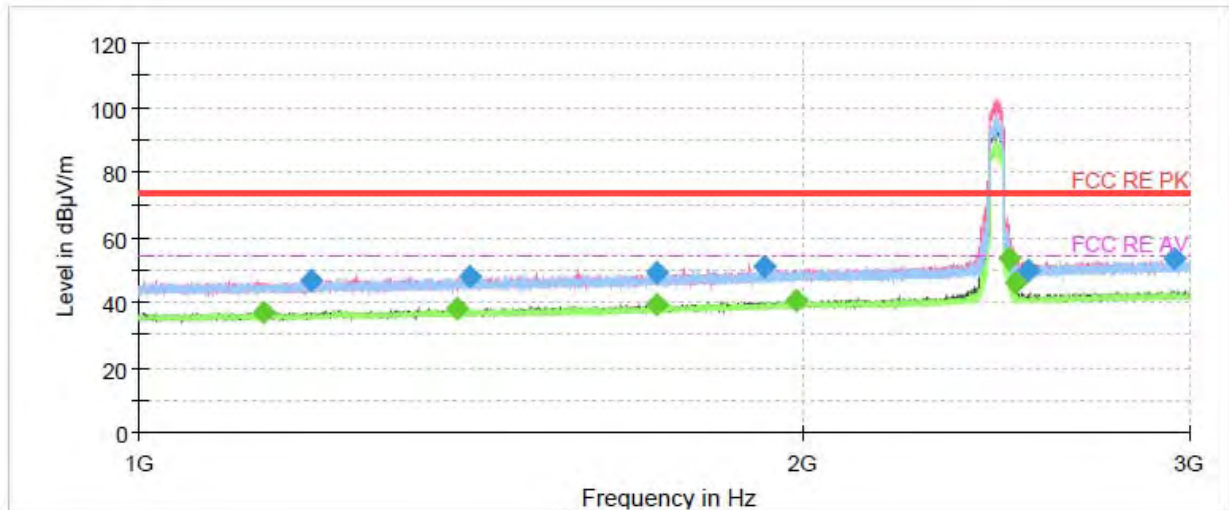

Note: The signal beyond the limit is carrier.
Radiates Emission from 1GHz to 3GHz

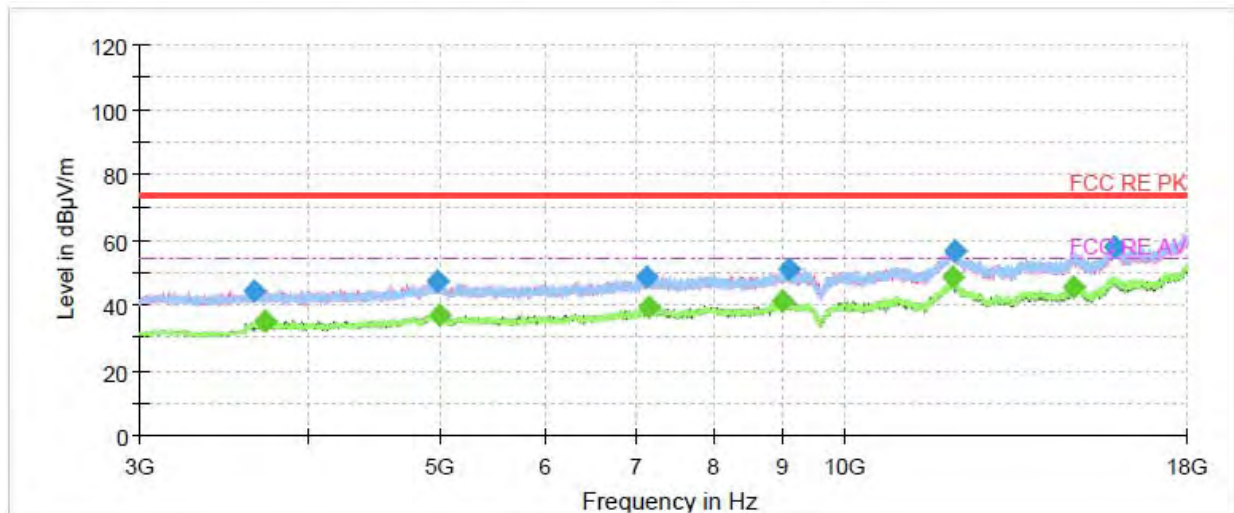

Radiates Emission from 3GHz to 18GHz



Frequency (MHz)	MaxPeak (dB μ V/m)	Average (dB μ V/m)	Limit (dB μ V/m)	Margin (dB)	Height (cm)	Pol	Azimuth (deg)	Corr. (dB/m)
1139.666667	---	37.18	54.00	16.82	100.0	V	84.0	-10.5
1195.933333	46.79	---	74.00	27.21	200.0	H	11.0	-10.2
1395.533333	---	38.05	54.00	15.95	100.0	V	203.0	-8.9
1412.066667	48.07	---	74.00	25.93	100.0	H	239.0	-8.8
1716.866667	49.19	---	74.00	24.81	200.0	H	262.0	-7.0
1718.666667	---	39.33	54.00	14.67	100.0	V	196.0	-7.0
1922.266667	51.23	---	74.00	22.77	100.0	V	69.0	-6.0
1986.933333	---	40.67	54.00	13.33	100.0	V	40.0	-5.7
2483.666667	---	53.27	54.00	0.73	100.0	V	84.0	-4.5
2499.866667	---	46.10	54.00	7.90	100.0	V	84.0	-4.5
2534.600000	49.96	---	74.00	24.04	200.0	V	358.0	-4.4
2956.066667	53.51	---	74.00	20.49	100.0	V	76.0	-2.8
12026.500000	---	48.44	54.00	5.56	100.0	H	197.0	5.9

Remark: 1. Correction Factor = Antenna factor+ Insertion loss (cable loss + amplifier gain)



During the test, the Radiates Emission from 18GHz to 26.5GHz was performed in all modes with all channels, 802.11n (HT20) CH11 are selected as the worst condition. The test data of the worst-case condition was recorded in this report.

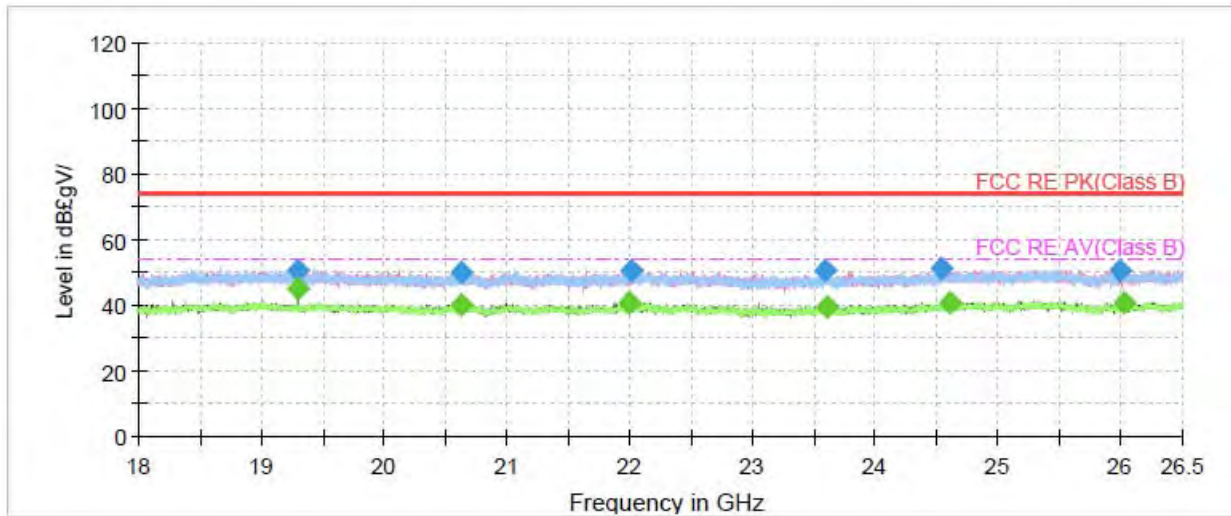

Radiates Emission from 18GHz to 26.5GHz

5.7. Conducted Emission

Ambient condition

Temperature	Relative humidity	Pressure
23°C ~25°C	45%~50%	101.5kPa

Methods of Measurement

The EUT is placed on a non-metallic table of 80cm height above the horizontal metal reference ground plane. During the test, the EUT was operating in its typical mode. The test method is according to ANSI C63.10. Connect the AC power line of the EUT to the L.I.S.N. Use EMI receiver to detect the average and Quasi-peak value. RBW is set to 9 kHz, VBW is set to 30kHz. The measurement result should include both L line and N line. The test is in transmitting mode.

Test Setup

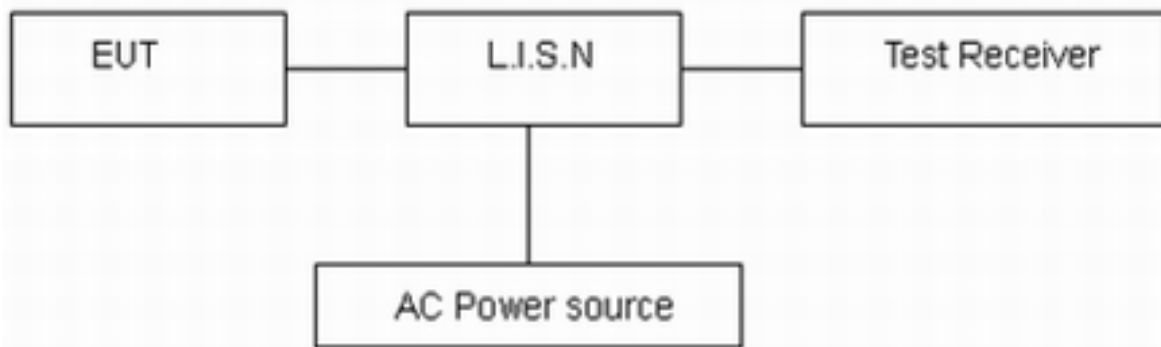

Note: AC Power source is used to change the voltage 110V/60Hz.

Limits

Frequency (MHz)	Conducted Limits(dBμV)	
	Quasi-peak	Average
0.15 - 0.5	66 to 56 *	56 to 46 *
0.5 - 5	56	46
5 - 30	60	50

*: Decreases with the logarithm of the frequency.

Measurement Uncertainty

The assessed measurement uncertainty to ensure 95% confidence level for the normal distribution is with the coverage factor $k = 1.96$, $U = 2.69$ dB.

Test Results:

Following plots, Blue trace uses the peak detection and Green trace uses the average detection. During the test, the Conducted Emission was performed in all modes (WIFI 2.4G) with all channels, 802.11n (HT20) CH11 are selected as the worst condition. The test data of the worst-case condition was recorded in this report.

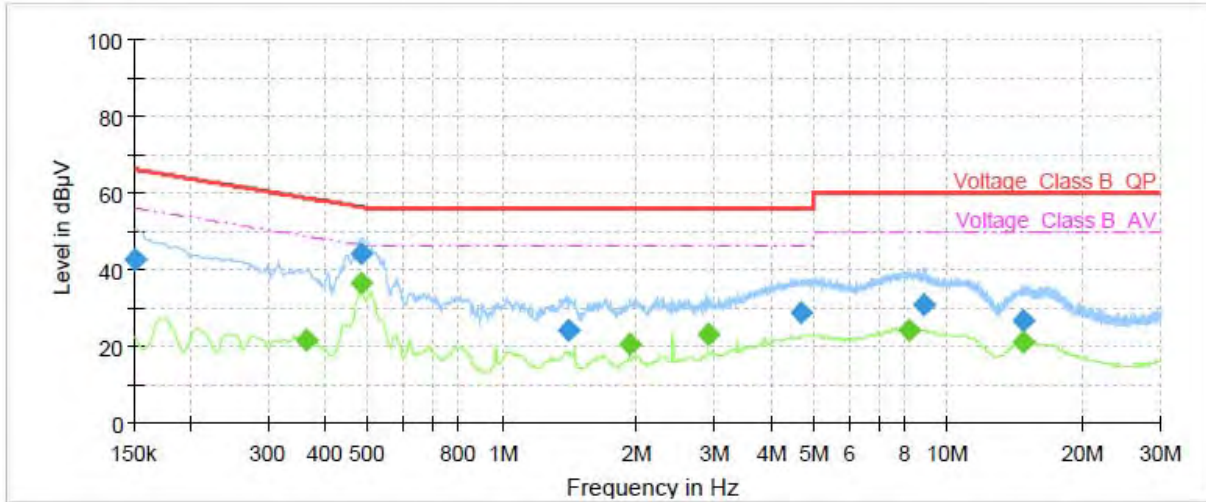

Frequency (MHz)	QuasiPeak (dBµV)	Average (dBµV)	Limit (dBµV)	Margin (dB)	Meas. Time (ms)	Bandwidth (kHz)	Line	Filter	Corr. (dB)
0.15	42.74	---	66.00	23.26	70.0	9.000	L1	ON	21
0.36	---	21.36	48.69	27.33	70.0	9.000	L1	ON	21
0.48	---	36.47	46.29	9.82	70.0	9.000	L1	ON	20
0.49	43.95	---	56.25	12.30	70.0	9.000	L1	ON	20
1.41	24.15	---	56.00	31.85	70.0	9.000	L1	ON	20
1.93	---	20.69	46.00	25.31	70.0	9.000	L1	ON	20
2.90	---	23.20	46.00	22.80	70.0	9.000	L1	ON	19
4.68	28.75	---	56.00	27.25	70.0	9.000	L1	ON	19
8.17	---	24.20	50.00	25.80	70.0	9.000	L1	ON	20
8.87	30.63	---	60.00	29.37	70.0	9.000	L1	ON	20
14.79	---	21.21	50.00	28.79	70.0	9.000	L1	ON	20
14.82	26.59	---	60.00	33.41	70.0	9.000	L1	ON	20

Remark: Correct factor=cable loss + LISN factor

L line Conducted Emission from 150 KHz to 30 MHz

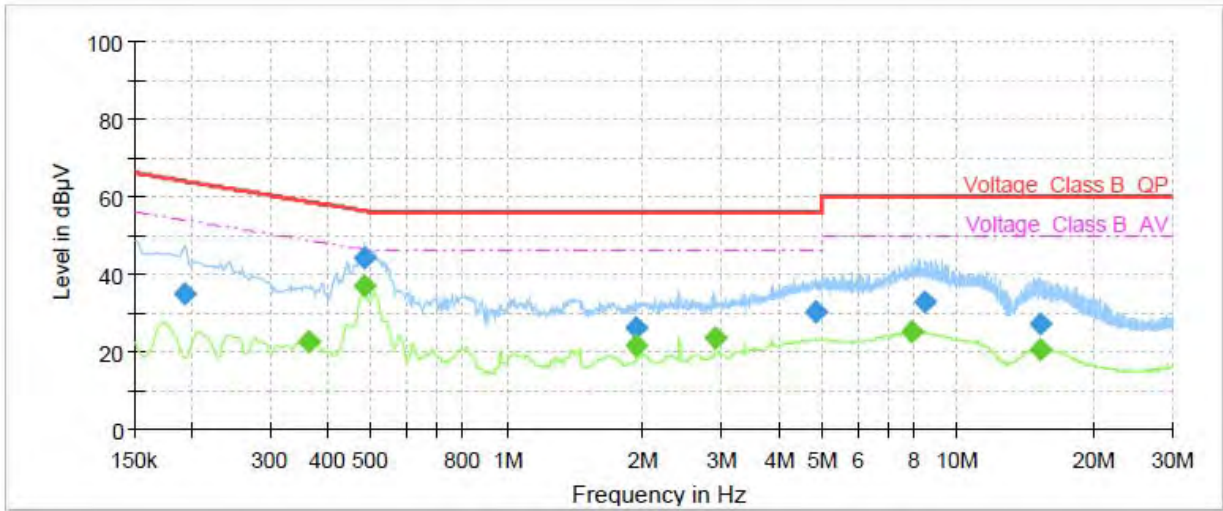

Frequency (MHz)	QuasiPeak (dBµV)	Average (dBµV)	Limit (dBµV)	Margin (dB)	Meas. Time (ms)	Bandwidth (kHz)	Line	Filter	Corr. (dB)
0.19	34.76	---	63.92	29.16	70.0	9.000	N	ON	21
0.36	---	22.59	48.69	26.10	70.0	9.000	N	ON	21
0.48	44.20	---	56.29	12.09	70.0	9.000	N	ON	20
0.48	---	36.93	46.29	9.36	70.0	9.000	N	ON	20
1.93	---	21.48	46.00	24.52	70.0	9.000	N	ON	20
1.93	25.95	---	56.00	30.05	70.0	9.000	N	ON	20
2.90	---	23.76	46.00	22.24	70.0	9.000	N	ON	19
4.84	30.45	---	56.00	25.55	70.0	9.000	N	ON	19
7.90	---	25.03	50.00	24.97	70.0	9.000	N	ON	20
8.45	32.60	---	60.00	27.40	70.0	9.000	N	ON	20
15.18	---	20.47	50.00	29.53	70.0	9.000	N	ON	20
15.23	27.12	---	60.00	32.88	70.0	9.000	N	ON	20

Remark: Correct factor=cable loss + LISN factor

N line Conducted Emission from 150 KHz to 30 MHz



6. Main Test Instruments

Name	Manufacturer	Type	Serial Number	Calibration Date	Expiration Date
Spectrum Analyzer	R&S	FSV30	100815	2020-12-13	2021-12-12
EMI Test Receiver	R&S	ESCI	100948	2021-05-15	2022-05-14
Loop Antenna	SCHWARZBECK	FMZB1519	1519-047	2020-04-02	2023-04-01
TRILOG Broadband Antenna	SCHWARZBECK	VULB 9163	391	2019-12-16	2022-12-15
Horn Antenna	R&S	HF907	102723	2020-08-11	2023-08-10
Standard Gain Horn	QPAR	QMS-00225	19928	2020-02-26	2023-02-25
EMI Test Receiver	R&S	ESR	101667	2021-05-16	2022-05-15
LISN	R&S	ENV216	101171	2018-12-15	2021-12-14
Power Sensor	R&S	NRP18S	101955	2021-05-15	2022-05-14
20dB Attenuator	Star River Highlight	UCL-TS2S-20	18013001	2020-12-14	2021-12-13
RF Cable	Agilent	SMA 15cm	0001	2021-06-13	2021-12-12
Software	R&S	EMC32	9.26.0	/	/

*****END OF REPORT *****



ANNEX A: The EUT Appearance

The EUT Appearance are submitted separately.



ANNEX B: Test Setup Photos

The Test Setup Photos are submitted separately.