



RF TEST REPORT

Applicant Shanghai Smawave Technology Co. ,Ltd
FCC ID 2AU8HMGL6201A
Product LTE Module
Brand Smawave
Model MGL6201A
Report No. R2001A0002-R7
Issue Date March 17, 2020

TA Technology (Shanghai) Co., Ltd. tested the above equipment in accordance with the requirements in **FCC CFR47 Part 2 (2019)/ FCC CFR 47 Part 25 (2019)**. The test results show that the equipment tested is capable of demonstrating compliance with the requirements as documented in this report.

Performed by: Peng Tao

Approved by: Kai Xu

TA Technology (Shanghai) Co., Ltd.

No.145, Jintang Rd, Tangzhen Industry Park, Pudong Shanghai, China

TEL: +86-021-50791141/2/3

FAX: +86-021-50791141/2/3-8000



TABLE OF CONTENT

1. Test Laboratory	4
1.1. Notes of the test report.....	4
1.2. Testing Location	4
2. General Description of Equipment under Test.....	5
2.1. Applicant and Manufacturer Information	5
2.2. General information	5
3. Applied Standards.....	6
4. Test Configuration.....	7
5. Test Case Results.....	8
5.1. RF Power Output and Effective Radiated Power	8
5.2. Occupied Bandwidth	17
5.3. Power Spectral Density	26
5.4. Band Edge Compliance.....	35
5.5. Peak-to-Average Power Ratio (PAPR)	44
5.6. Frequency Stability	46
5.7. Spurious Emissions at Antenna Terminals	50
5.8. Radiates Spurious Emission	59
6. Main Test Instruments	64

Summary of measurement results

No.	Test Case	Clause in FCC rules	Verdict
1	RF power output and Effective Radiated Power	25.149 (4) (iii)	PASS
2	Occupied Bandwidth	2.1049	PASS
3	Band Edge Compliance	25.149 (4) (v)	PASS
4	Peak-to-Average Power Ratio	25.144 (7) (ii)	PASS
5	Frequency Stability	2.1055	PASS
6	Spurious Emissions at Antenna Terminals	2.1051 / 25.202 (11) (fi)	PASS
7	Radiates Spurious Emission	2.1053	PASS
Note: PASS: The EUT complies with the essential requirements in the standard. FAIL: The EUT does not comply with the essential requirements in the standard.			
Date of Testing: November 30, 2019 ~ March 13, 2020			



1. Test Laboratory

1.1. Notes of the test report

This report shall not be reproduced in full or partial, without the written approval of **TA technology (shanghai) co., Ltd.** The results documented in this report apply only to the tested sample, under the conditions and modes of operation as described herein. Measurement Uncertainties were not taken into account and are published for informational purposes only. This report is written to support regulatory compliance of the applicable standards stated above.

1.2. Testing Location

Company: TA Technology (Shanghai) Co., Ltd.
Address: No.145, Jintang Rd, Tangzhen Industry Park, Pudong
City: Shanghai
Post code: 201201
Country: P. R. China
Contact: Xu Kai
Telephone: +86-021-50791141/2/3
Fax: +86-021-50791141/2/3-8000
Website: <http://www.ta-shanghai.com>
E-mail: xukai@ta-shanghai.com

2. General Description of Equipment under Test

2.1. Applicant and Manufacturer Information

Applicant	Shanghai Smawave Technology Co. ,Ltd
Applicant address	3/F, Building 8, 1001 North Qinzhou Road, Xuhui District, Shanghai, China
Manufacturer	Shanghai Smawave Technology Co. ,Ltd
Manufacturer address	3/F, Building 8, 1001 North Qinzhou Road, Xuhui District, Shanghai, China

2.2. General information

EUT Description			
Model	MGL6201A		
IMEI	860524031979550		
Hardware Version	V2.0		
Software Version	CAT12-A		
Power Supply	External Power Supply		
Antenna Type	External Antenna		
Antenna Gain	4.22 dBi		
Test Mode(s)	LTE Band 53;		
Test Modulation	(LTE)QPSK, 16QAM, 64QAM;		
LTE Category	12		
Maximum E.I.R.P	LTE Band 53:	25.64 dBm	
Rated Power Supply Voltage	3.3V		
Extreme Voltage	Minimum: 3V Maximum: 3.6V		
Extreme Temperature	Lowest: -40°C Highest: +70°C		
Operating Frequency Range(s)	Band	Tx (MHz)	Rx (MHz)
	LTE Band 53	2483.5 ~ 2495	2483.5 ~ 2495
Note: 1. The information of the EUT is declared by the manufacturer.			



3. Applied Standards

According to the specifications of the manufacturer, it must comply with the requirements of the following standards:

Test standards:

FCC CFR 47 Part 25 (2019)

ANSI C63.26 (2015)

Reference standard:

FCC CFR47 Part 2 (2019)

KDB 971168 D01 Power Meas License Digital Systems v03r01

4. Test Configuration

Radiated measurements are performed by rotating the EUT in three different orthogonal test planes. EUT stand-up position (Z axis), lie-down position (X, Y axis). Receiver antenna polarization (horizontal and vertical), the worst emission was found in position (X axis, horizontal polarization) and the worst case was recorded.

All mode and data rates and positions and RB size and modulations were investigated.

Subsequently, only the worst case emissions are reported.

The following testing in LTE is set based on the maximum RF Output Power.

Test modes are chosen to be reported as the worst case configuration below for LTE Band 53:

Test items	Bandwidth (MHz)				Modulation		RB			Test Channel		
	1.4	3	5	10	QPSK	16QAM	1	50%	100%	L	M	H
RF power output and Effective Isotropic Radiated power	O	O	O	O	O	O	O	O	O	O	O	O
Occupied Bandwidth	O	O	O	O	O	O	-	-	O	O	O	O
Band Edge Compliance	O	O	O	O	O	O	O	-	O	O	-	O
Peak-to-Average Power Ratio	O	O	O	O	O	O	-	-	O	O	O	O
Frequency Stability	O	O	O	O	O	O	-	-	O	-	O	-
Conducted Spurious Emissions	O	O	O	O	O	-	O	-	-	O	O	O
Radiates Spurious Emission	O	-	O	O	O	-	O	-	-	-	O	-
Note	1. The mark "O" means that this configuration is chosen for testing. 2. The mark "-" means that this configuration is not testing.											

5. Test Case Results

5.1.RF Power Output and Effective Radiated Power

Ambient condition

Temperature	Relative humidity	Pressure
23°C ~25°C	45%~50%	101.5kPa

Methods of Measurement

During the process of the testing, The EUT is controlled by the Base Station Simulator to ensure max power transmission and proper modulation.

The testing follows FCC KDB 971168 v03r01 Section 5.8 and ANSI C63.26 (2015).

- a) Connect the equipment as illustrated. Mount the equipment with the manufacturer specified antenna in a vertical orientation on a manufacturer specified mounting surface located on a non-conducting rotating platform of a RF anechoic chamber (preferred) or a standard radiation site.
- b) Key the transmitter, then rotate the EUT 360° azimuthally and record spectrum analyzer power level (LVL) measurements at angular increments that are sufficiently small to permit resolution of all peaks. If a standard radiation test site is used, raise and lower the test antenna to obtain a maximum reading at each angular increment. (Note: several batteries may be needed to offset the effect of battery voltage droop, which should not exceed 5% of the manufactured specified battery voltage during transmission).
- c) Replace the transmitter under test with a vertically polarized half-wave dipole (or an antenna whose gain is known relative to an ideal half-wave dipole). The center of the antenna should be at the same location as the center of the antenna under test.
- d) Connect the antenna to a signal generator with a known output power and record the path loss (in dB) as LOSS. If a standard radiation test site is used, raise and lower the test antenna to obtain a maximum reading. $LOSS = \text{Generator Output Power (dBm)} - \text{Analyzer reading (dBm)}$
- e) Determine the effective radiated output power at each angular position from the readings in steps b) and d) using the following equation: $ERP \text{ (dBm)} = \text{LVL (dBm)} + \text{LOSS (dB)}$
- f) The maximum ERP is the maximum value determined in the preceding step.
- g) When calculating ERP, in addition to knowing the antenna radiation and matching characteristics, it is necessary to know the loss values of all elements (e.g. transmission line attenuation, mismatches, filters, combiners) interposed between the point where transmitter output power is measured, and the point where power is applied to the antenna. ERP can then be calculated as follows:
 $EIRP \text{ (dBm)} = \text{Output Power (dBm)} - \text{Losses (dB)} + \text{Antenna Gain (dBi)}$
where:dBd refers to gain relative to an ideal dipole.
 $EIRP \text{ (dBm)} = \text{ERP (dBm)} + 2.15 \text{ (dB.)}$

The RB allocation refers to section 5.1, using the maximum output power configuration.

Test Setup

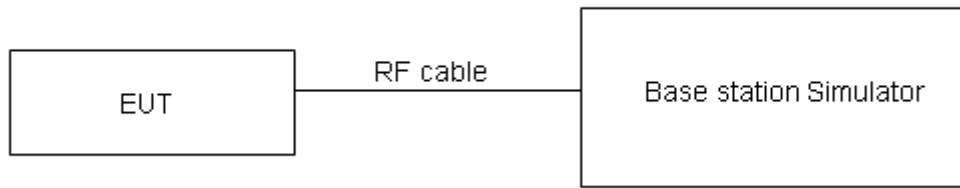

The loss between RF output port of the EUT and the input port of the tester has been taken into consideration.

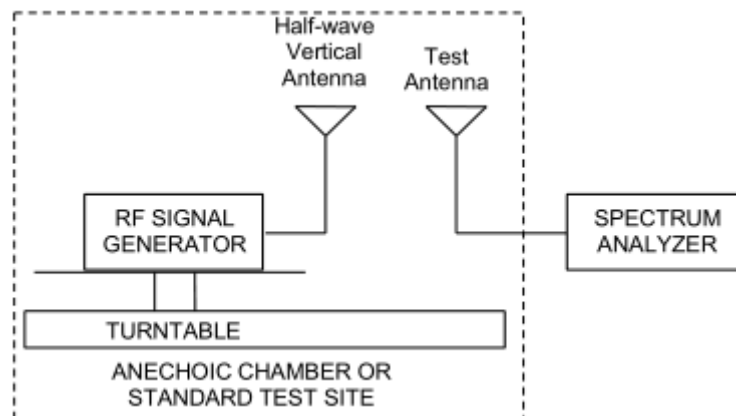
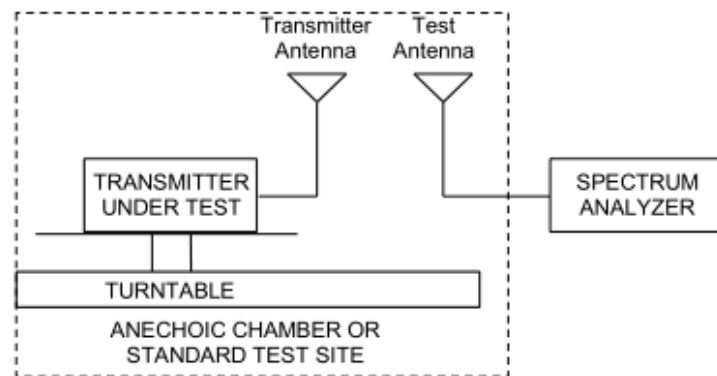

Limits

The maximum transmit power is no more than 1 W with a peak EIRP of no more than 6 dBW;

power Limit	$\leq 1 \text{ W}$ (30 dBm)
peak EIRP Limit	$\leq 6 \text{ dBW}$ (36dBm)

Measurement Uncertainty

The assessed measurement uncertainty to ensure 95% confidence level for the normal distribution is with the coverage factor $k = 2$, $U = 0.4 \text{ dB}$ for RF power output, $k = 2$, $U = 1.19 \text{ dB}$ for EIRP.

**Test Results**

BAND	Bandwidth	Modulation	Channel	RB Configuration	Conducted Power(dBm)	EIRP(dBm)
LTE Band 53	1.4M	QPSK	60147	1RB#0	20.72	24.94
LTE Band 53	1.4M	QPSK	60147	1RB#2	20.59	24.81
LTE Band 53	1.4M	QPSK	60147	1RB#5	20.97	25.19
LTE Band 53	1.4M	QPSK	60147	3RB#0	20.56	24.78
LTE Band 53	1.4M	QPSK	60147	3RB#2	20.64	24.86
LTE Band 53	1.4M	QPSK	60147	3RB#3	20.85	25.07
LTE Band 53	1.4M	QPSK	60147	6RB#0	20.71	24.93
LTE Band 53	1.4M	QPSK	60197	1RB#0	20.82	25.04
LTE Band 53	1.4M	QPSK	60197	1RB#2	20.70	24.92
LTE Band 53	1.4M	QPSK	60197	1RB#5	21.00	25.22
LTE Band 53	1.4M	QPSK	60197	3RB#0	20.60	24.82
LTE Band 53	1.4M	QPSK	60197	3RB#2	20.75	24.97
LTE Band 53	1.4M	QPSK	60197	3RB#3	20.74	24.96
LTE Band 53	1.4M	QPSK	60197	6RB#0	20.73	24.95
LTE Band 53	1.4M	QPSK	60248	1RB#0	20.93	25.15
LTE Band 53	1.4M	QPSK	60248	1RB#2	20.85	25.07
LTE Band 53	1.4M	QPSK	60248	1RB#5	20.90	25.12
LTE Band 53	1.4M	QPSK	60248	3RB#0	20.73	24.95
LTE Band 53	1.4M	QPSK	60248	3RB#2	20.70	24.92
LTE Band 53	1.4M	QPSK	60248	3RB#3	20.76	24.98
LTE Band 53	1.4M	QPSK	60248	6RB#0	20.87	25.09
LTE Band 53	1.4M	16QAM	60147	1RB#0	21.00	25.22
LTE Band 53	1.4M	16QAM	60147	1RB#2	20.86	25.08
LTE Band 53	1.4M	16QAM	60147	1RB#5	21.27	25.49
LTE Band 53	1.4M	16QAM	60147	3RB#0	20.61	24.83
LTE Band 53	1.4M	16QAM	60147	3RB#2	20.75	24.97
LTE Band 53	1.4M	16QAM	60147	3RB#3	20.76	24.98
LTE Band 53	1.4M	16QAM	60147	6RB#0	20.87	25.09
LTE Band 53	1.4M	16QAM	60197	1RB#0	21.07	25.29
LTE Band 53	1.4M	16QAM	60197	1RB#2	20.91	25.13
LTE Band 53	1.4M	16QAM	60197	1RB#5	21.31	25.53
LTE Band 53	1.4M	16QAM	60197	3RB#0	20.60	24.82
LTE Band 53	1.4M	16QAM	60197	3RB#2	20.80	25.02
LTE Band 53	1.4M	16QAM	60197	3RB#3	20.69	24.91
LTE Band 53	1.4M	16QAM	60197	6RB#0	20.84	25.06
LTE Band 53	1.4M	16QAM	60248	1RB#0	21.20	25.42



LTE Band 53	1.4M	16QAM	60248	1RB#2	21.10	25.32
LTE Band 53	1.4M	16QAM	60248	1RB#5	21.05	25.27
LTE Band 53	1.4M	16QAM	60248	3RB#0	20.77	24.99
LTE Band 53	1.4M	16QAM	60248	3RB#2	20.78	25.00
LTE Band 53	1.4M	16QAM	60248	3RB#3	20.69	24.91
LTE Band 53	1.4M	16QAM	60248	6RB#0	21.00	25.22
LTE Band 53	1.4M	64QAM	60147	1RB#0	20.74	24.96
LTE Band 53	1.4M	64QAM	60147	1RB#2	20.58	24.80
LTE Band 53	1.4M	64QAM	60147	1RB#5	20.92	25.14
LTE Band 53	1.4M	64QAM	60147	3RB#0	20.68	24.90
LTE Band 53	1.4M	64QAM	60147	3RB#2	20.79	25.01
LTE Band 53	1.4M	64QAM	60147	3RB#3	20.84	25.06
LTE Band 53	1.4M	64QAM	60147	6RB#0	20.81	25.03
LTE Band 53	1.4M	64QAM	60197	1RB#0	20.82	25.04
LTE Band 53	1.4M	64QAM	60197	1RB#2	20.69	24.91
LTE Band 53	1.4M	64QAM	60197	1RB#5	20.95	25.17
LTE Band 53	1.4M	64QAM	60197	3RB#0	20.71	24.93
LTE Band 53	1.4M	64QAM	60197	3RB#2	20.89	25.11
LTE Band 53	1.4M	64QAM	60197	3RB#3	20.73	24.95
LTE Band 53	1.4M	64QAM	60197	6RB#0	20.83	25.05
LTE Band 53	1.4M	64QAM	60248	1RB#0	20.92	25.14
LTE Band 53	1.4M	64QAM	60248	1RB#2	20.84	25.06
LTE Band 53	1.4M	64QAM	60248	1RB#5	20.81	25.03
LTE Band 53	1.4M	64QAM	60248	3RB#0	20.83	25.05
LTE Band 53	1.4M	64QAM	60248	3RB#2	20.83	25.05
LTE Band 53	1.4M	64QAM	60248	3RB#3	20.77	24.99
LTE Band 53	1.4M	64QAM	60248	6RB#0	20.97	25.19
LTE Band 53	3M	QPSK	60155	1RB#0	20.74	24.96
LTE Band 53	3M	QPSK	60155	1RB#7	20.62	24.84
LTE Band 53	3M	QPSK	60155	1RB#14	21.00	25.22
LTE Band 53	3M	QPSK	60155	8RB#0	20.64	24.86
LTE Band 53	3M	QPSK	60155	8RB#4	20.74	24.96
LTE Band 53	3M	QPSK	60155	8RB#7	20.93	25.15
LTE Band 53	3M	QPSK	60155	15RB#0	20.74	24.96
LTE Band 53	3M	QPSK	60197	1RB#0	20.86	25.08
LTE Band 53	3M	QPSK	60197	1RB#7	20.75	24.97
LTE Band 53	3M	QPSK	60197	1RB#14	21.05	25.27
LTE Band 53	3M	QPSK	60197	8RB#0	20.70	24.92
LTE Band 53	3M	QPSK	60197	8RB#4	20.83	25.05
LTE Band 53	3M	QPSK	60197	8RB#7	20.83	25.05



LTE Band 53	3M	QPSK	60197	15RB#0	20.77	24.99
LTE Band 53	3M	QPSK	60240	1RB#0	20.96	25.18
LTE Band 53	3M	QPSK	60240	1RB#7	20.89	25.11
LTE Band 53	3M	QPSK	60240	1RB#14	20.94	25.16
LTE Band 53	3M	QPSK	60240	8RB#0	20.84	25.06
LTE Band 53	3M	QPSK	60240	8RB#4	20.80	25.02
LTE Band 53	3M	QPSK	60240	8RB#7	20.84	25.06
LTE Band 53	3M	QPSK	60240	15RB#0	20.90	25.12
LTE Band 53	3M	16QAM	60155	1RB#0	21.03	25.25
LTE Band 53	3M	16QAM	60155	1RB#7	20.89	25.11
LTE Band 53	3M	16QAM	60155	1RB#14	21.29	25.51
LTE Band 53	3M	16QAM	60155	8RB#0	20.70	24.92
LTE Band 53	3M	16QAM	60155	8RB#4	20.84	25.06
LTE Band 53	3M	16QAM	60155	8RB#7	20.84	25.06
LTE Band 53	3M	16QAM	60155	15RB#0	20.90	25.12
LTE Band 53	3M	16QAM	60197	1RB#0	21.09	25.31
LTE Band 53	3M	16QAM	60197	1RB#7	20.96	25.18
LTE Band 53	3M	16QAM	60197	1RB#14	21.35	25.57
LTE Band 53	3M	16QAM	60197	8RB#0	20.71	24.93
LTE Band 53	3M	16QAM	60197	8RB#4	20.91	25.13
LTE Band 53	3M	16QAM	60197	8RB#7	20.79	25.01
LTE Band 53	3M	16QAM	60197	15RB#0	20.88	25.10
LTE Band 53	3M	16QAM	60240	1RB#0	21.23	25.45
LTE Band 53	3M	16QAM	60240	1RB#7	21.14	25.36
LTE Band 53	3M	16QAM	60240	1RB#14	21.08	25.30
LTE Band 53	3M	16QAM	60240	8RB#0	20.87	25.09
LTE Band 53	3M	16QAM	60240	8RB#4	20.88	25.10
LTE Band 53	3M	16QAM	60240	8RB#7	20.80	25.02
LTE Band 53	3M	16QAM	60240	15RB#0	21.03	25.25
LTE Band 53	3M	64QAM	60155	1RB#0	20.76	24.98
LTE Band 53	3M	64QAM	60155	1RB#7	20.61	24.83
LTE Band 53	3M	64QAM	60155	1RB#14	20.95	25.17
LTE Band 53	3M	64QAM	60155	8RB#0	20.76	24.98
LTE Band 53	3M	64QAM	60155	8RB#4	20.89	25.11
LTE Band 53	3M	64QAM	60155	8RB#7	20.92	25.14
LTE Band 53	3M	64QAM	60155	15RB#0	20.84	25.06
LTE Band 53	3M	64QAM	60197	1RB#0	20.86	25.08
LTE Band 53	3M	64QAM	60197	1RB#7	20.74	24.96
LTE Band 53	3M	64QAM	60197	1RB#14	21.00	25.22
LTE Band 53	3M	64QAM	60197	8RB#0	20.81	25.03



LTE Band 53	3M	64QAM	60197	8RB#4	20.97	25.19
LTE Band 53	3M	64QAM	60197	8RB#7	20.82	25.04
LTE Band 53	3M	64QAM	60197	15RB#0	20.87	25.09
LTE Band 53	3M	64QAM	60240	1RB#0	20.95	25.17
LTE Band 53	3M	64QAM	60240	1RB#7	20.88	25.10
LTE Band 53	3M	64QAM	60240	1RB#14	20.85	25.07
LTE Band 53	3M	64QAM	60240	8RB#0	20.94	25.16
LTE Band 53	3M	64QAM	60240	8RB#4	20.93	25.15
LTE Band 53	3M	64QAM	60240	8RB#7	20.85	25.07
LTE Band 53	3M	64QAM	60240	15RB#0	21.00	25.22
LTE Band 53	5M	QPSK	60165	1RB#0	20.78	25.00
LTE Band 53	5M	QPSK	60165	1RB#13	20.69	24.91
LTE Band 53	5M	QPSK	60165	1RB#24	21.06	25.28
LTE Band 53	5M	QPSK	60165	12RB#0	20.71	24.93
LTE Band 53	5M	QPSK	60165	12RB#6	20.79	25.01
LTE Band 53	5M	QPSK	60165	12RB#13	21.00	25.22
LTE Band 53	5M	QPSK	60165	25RB#0	20.82	25.04
LTE Band 53	5M	QPSK	60197	1RB#0	20.98	25.20
LTE Band 53	5M	QPSK	60197	1RB#13	20.80	25.02
LTE Band 53	5M	QPSK	60197	1RB#24	21.12	25.34
LTE Band 53	5M	QPSK	60197	12RB#0	20.74	24.96
LTE Band 53	5M	QPSK	60197	12RB#6	20.88	25.10
LTE Band 53	5M	QPSK	60197	12RB#13	20.93	25.15
LTE Band 53	5M	QPSK	60197	25RB#0	20.86	25.08
LTE Band 53	5M	QPSK	60230	1RB#0	21.01	25.23
LTE Band 53	5M	QPSK	60230	1RB#13	20.96	25.18
LTE Band 53	5M	QPSK	60230	1RB#24	21.03	25.25
LTE Band 53	5M	QPSK	60230	12RB#0	20.90	25.12
LTE Band 53	5M	QPSK	60230	12RB#6	20.84	25.06
LTE Band 53	5M	QPSK	60230	12RB#13	20.84	25.06
LTE Band 53	5M	QPSK	60230	25RB#0	20.91	25.13
LTE Band 53	5M	16QAM	60165	1RB#0	21.05	25.27
LTE Band 53	5M	16QAM	60165	1RB#13	20.91	25.13
LTE Band 53	5M	16QAM	60165	1RB#24	21.31	25.53
LTE Band 53	5M	16QAM	60165	12RB#0	20.74	24.96
LTE Band 53	5M	16QAM	60165	12RB#6	20.86	25.08
LTE Band 53	5M	16QAM	60165	12RB#13	20.89	25.11
LTE Band 53	5M	16QAM	60165	25RB#0	20.93	25.15
LTE Band 53	5M	16QAM	60197	1RB#0	21.11	25.33
LTE Band 53	5M	16QAM	60197	1RB#13	21.03	25.25



LTE Band 53	5M	16QAM	60197	1RB#24	21.42	25.64
LTE Band 53	5M	16QAM	60197	12RB#0	20.75	24.97
LTE Band 53	5M	16QAM	60197	12RB#6	20.95	25.17
LTE Band 53	5M	16QAM	60197	12RB#13	20.79	25.01
LTE Band 53	5M	16QAM	60197	25RB#0	20.89	25.11
LTE Band 53	5M	16QAM	60230	1RB#0	21.27	25.49
LTE Band 53	5M	16QAM	60230	1RB#13	21.18	25.40
LTE Band 53	5M	16QAM	60230	1RB#24	21.11	25.33
LTE Band 53	5M	16QAM	60230	12RB#0	20.92	25.14
LTE Band 53	5M	16QAM	60230	12RB#6	20.93	25.15
LTE Band 53	5M	16QAM	60230	12RB#13	20.83	25.05
LTE Band 53	5M	16QAM	60230	25RB#0	21.04	25.26
LTE Band 53	5M	64QAM	60165	1RB#0	20.80	25.02
LTE Band 53	5M	64QAM	60165	1RB#13	20.68	24.90
LTE Band 53	5M	64QAM	60165	1RB#24	21.01	25.23
LTE Band 53	5M	64QAM	60165	12RB#0	20.83	25.05
LTE Band 53	5M	64QAM	60165	12RB#6	20.94	25.16
LTE Band 53	5M	64QAM	60165	12RB#13	20.99	25.21
LTE Band 53	5M	64QAM	60165	25RB#0	20.92	25.14
LTE Band 53	5M	64QAM	60197	1RB#0	20.98	25.20
LTE Band 53	5M	64QAM	60197	1RB#13	20.79	25.01
LTE Band 53	5M	64QAM	60197	1RB#24	21.07	25.29
LTE Band 53	5M	64QAM	60197	12RB#0	20.85	25.07
LTE Band 53	5M	64QAM	60197	12RB#6	21.02	25.24
LTE Band 53	5M	64QAM	60197	12RB#13	20.92	25.14
LTE Band 53	5M	64QAM	60197	25RB#0	20.96	25.18
LTE Band 53	5M	64QAM	60230	1RB#0	21.00	25.22
LTE Band 53	5M	64QAM	60230	1RB#13	20.95	25.17
LTE Band 53	5M	64QAM	60230	1RB#24	20.94	25.16
LTE Band 53	5M	64QAM	60230	12RB#0	21.00	25.22
LTE Band 53	5M	64QAM	60230	12RB#6	20.97	25.19
LTE Band 53	5M	64QAM	60230	12RB#13	20.85	25.07
LTE Band 53	5M	64QAM	60230	25RB#0	21.01	25.23
LTE Band 53	10M	QPSK	60190	1RB#0	20.69	24.91
LTE Band 53	10M	QPSK	60190	1RB#25	20.60	24.82
LTE Band 53	10M	QPSK	60190	1RB#49	20.94	25.16
LTE Band 53	10M	QPSK	60190	25RB#0	20.59	24.81
LTE Band 53	10M	QPSK	60190	25RB#13	20.70	24.92
LTE Band 53	10M	QPSK	60190	25RB#25	20.87	25.09
LTE Band 53	10M	QPSK	60190	50RB#0	20.75	24.97



LTE Band 53	10M	QPSK	60197	1RB#0	20.77	24.99
LTE Band 53	10M	QPSK	60197	1RB#25	20.71	24.93
LTE Band 53	10M	QPSK	60197	1RB#49	20.98	25.20
LTE Band 53	10M	QPSK	60197	25RB#0	20.61	24.83
LTE Band 53	10M	QPSK	60197	25RB#13	20.75	24.97
LTE Band 53	10M	QPSK	60197	25RB#25	20.77	24.99
LTE Band 53	10M	QPSK	60197	50RB#0	20.69	24.91
LTE Band 53	10M	QPSK	60205	1RB#0	20.90	25.12
LTE Band 53	10M	QPSK	60205	1RB#25	20.85	25.07
LTE Band 53	10M	QPSK	60205	1RB#49	20.86	25.08
LTE Band 53	10M	QPSK	60205	25RB#0	20.77	24.99
LTE Band 53	10M	QPSK	60205	25RB#13	20.72	24.94
LTE Band 53	10M	QPSK	60205	25RB#25	20.77	24.99
LTE Band 53	10M	QPSK	60205	50RB#0	20.83	25.05
LTE Band 53	10M	16QAM	60190	1RB#0	20.95	25.17
LTE Band 53	10M	16QAM	60190	1RB#25	20.83	25.05
LTE Band 53	10M	16QAM	60190	1RB#49	21.24	25.46
LTE Band 53	10M	16QAM	60190	25RB#0	20.65	24.87
LTE Band 53	10M	16QAM	60190	25RB#13	20.77	24.99
LTE Band 53	10M	16QAM	60190	25RB#25	20.79	25.01
LTE Band 53	10M	16QAM	60190	50RB#0	20.86	25.08
LTE Band 53	10M	16QAM	60197	1RB#0	21.02	25.24
LTE Band 53	10M	16QAM	60197	1RB#25	20.93	25.15
LTE Band 53	10M	16QAM	60197	1RB#49	21.28	25.50
LTE Band 53	10M	16QAM	60197	25RB#0	20.66	24.88
LTE Band 53	10M	16QAM	60197	25RB#13	20.83	25.05
LTE Band 53	10M	16QAM	60197	25RB#25	20.70	24.92
LTE Band 53	10M	16QAM	60197	50RB#0	20.80	25.02
LTE Band 53	10M	16QAM	60205	1RB#0	21.15	25.37
LTE Band 53	10M	16QAM	60205	1RB#25	21.08	25.30
LTE Band 53	10M	16QAM	60205	1RB#49	21.02	25.24
LTE Band 53	10M	16QAM	60205	25RB#0	20.82	25.04
LTE Band 53	10M	16QAM	60205	25RB#13	20.80	25.02
LTE Band 53	10M	16QAM	60205	25RB#25	20.73	24.95
LTE Band 53	10M	16QAM	60205	50RB#0	20.95	25.17
LTE Band 53	10M	64QAM	60190	1RB#0	20.71	24.93
LTE Band 53	10M	64QAM	60190	1RB#25	20.59	24.81
LTE Band 53	10M	64QAM	60190	1RB#49	20.89	25.11
LTE Band 53	10M	64QAM	60190	25RB#0	20.71	24.93
LTE Band 53	10M	64QAM	60190	25RB#13	20.85	25.07



LTE Band 53	10M	64QAM	60190	25RB#25	20.86	25.08
LTE Band 53	10M	64QAM	60190	50RB#0	20.85	25.07
LTE Band 53	10M	64QAM	60197	1RB#0	20.77	24.99
LTE Band 53	10M	64QAM	60197	1RB#25	20.70	24.92
LTE Band 53	10M	64QAM	60197	1RB#49	20.93	25.15
LTE Band 53	10M	64QAM	60197	25RB#0	20.72	24.94
LTE Band 53	10M	64QAM	60197	25RB#13	20.89	25.11
LTE Band 53	10M	64QAM	60197	25RB#25	20.76	24.98
LTE Band 53	10M	64QAM	60197	50RB#0	20.79	25.01
LTE Band 53	10M	64QAM	60205	1RB#0	20.89	25.11
LTE Band 53	10M	64QAM	60205	1RB#25	20.84	25.06
LTE Band 53	10M	64QAM	60205	1RB#49	20.77	24.99
LTE Band 53	10M	64QAM	60205	25RB#0	20.87	25.09
LTE Band 53	10M	64QAM	60205	25RB#13	20.85	25.07
LTE Band 53	10M	64QAM	60205	25RB#25	20.78	25.00
LTE Band 53	10M	64QAM	60205	50RB#0	20.93	25.15

5.2.Occupied Bandwidth

Ambient condition

Temperature	Relative humidity	Pressure
23°C ~25°C	45%~50%	101.5kPa

Method of Measurement

The EUT was connected to Spectrum Analyzer and Base Station Simulator via power Splitter. The occupied bandwidth is measured using spectrum analyzer.

RBW is set to 51kHz, VBW is set to 160kHz for LTE Band 53 (1.4MHz),

RBW is set to 100kHz,VBW is set to 300kHz for LTE Band 53 (3MHz/5MHz),

RBW is set to 300kHz,VBW is set to 1MHz for LTE Band 53 (10MHz).

99% power and -26dBc occupied bandwidths are recorded. Spectrum analyzer plots are included on the following pages.

Test Setup

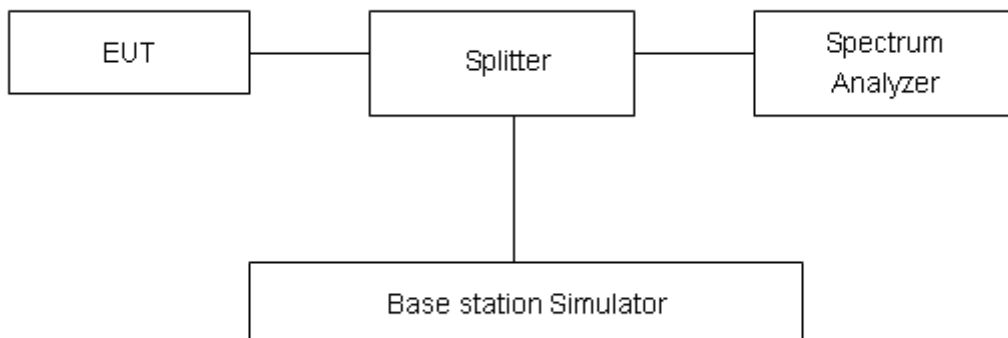

Limits

The 6 dB bandwidth is at least 500 kHz;

Measurement Uncertainty

The assessed measurement uncertainty to ensure 95% confidence level for the normal distribution is with the coverage factor $k = 2$, $U = 624\text{Hz}$.

Test Result

LTE Band 53					
Modulation	Bandwidth (MHz)	Channel	Frequency (MHz)	99% Power Bandwidth(MHz)	-6dBc Bandwidth(MHz)
QPSK	1.4	60147	2484.2	1.1707	1.097
		60197	2489.2	1.1641	1.102
		60248	2494.3	1.1679	1.112
	3	60155	2485	2.7919	2.751
		60197	2489.2	2.7867	2.717
		60240	2493.5	2.767	2.723
	5	60165	2486	4.5332	4.523
		60197	2489.2	4.5193	4.512
		60230	2492.5	4.5264	4.508
	10	60190	2488.5	9.0341	8.999
		60197	2489.2	9.022	8.981
		60205	2490	9.0095	8.996
16QAM	1.4	60147	2484.2	1.1451	1.086
		60197	2489.2	1.1422	1.099
		60248	2494.3	1.1501	1.102
	3	60155	2485	2.7834	2.736
		60197	2489.2	2.7657	2.727
		60240	2493.5	2.7661	2.704
	5	60165	2486	4.5318	4.546
		60197	2489.2	4.5269	4.537
		60230	2492.5	4.5085	4.519
	10	60190	2488.5	9.0096	8.966
		60197	2489.2	9.0048	8.993
		60205	2490	8.986	8.914
64QAM	1.4	60147	2484.2	1.1586	1.101
		60197	2489.2	1.1544	1.084
		60248	2494.3	1.1561	1.093
	3	60155	2485	2.7528	2.721
		60197	2489.2	2.7533	2.708
		60240	2493.5	2.7497	2.705



	5	60165	2486	4.5261	4.526
		60197	2489.2	4.5127	4.477
		60230	2492.5	4.5172	4.521
	10	60190	2488.5	9.0242	8.939
		60197	2489.2	8.9961	8.824
		60205	2490	8.986	8.867



-6dBc Power Bandwidth

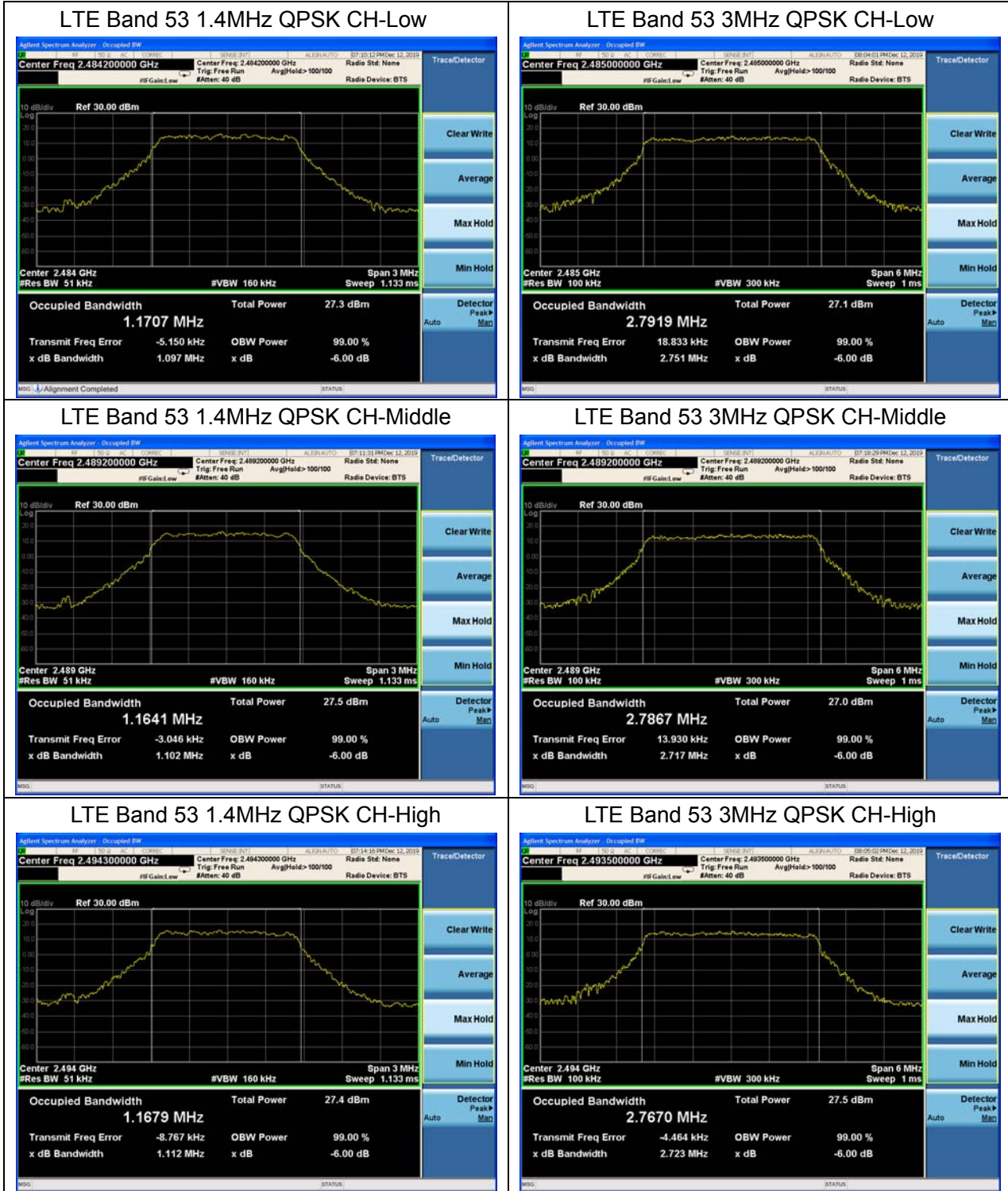

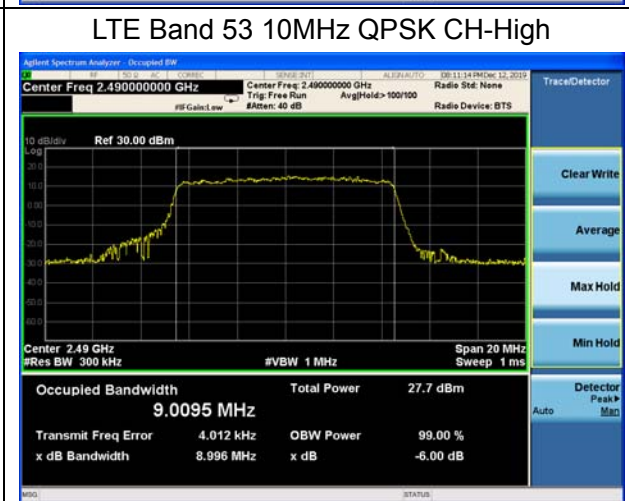
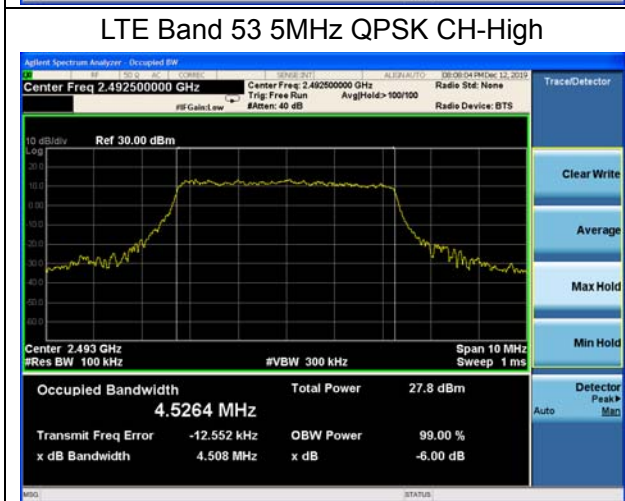
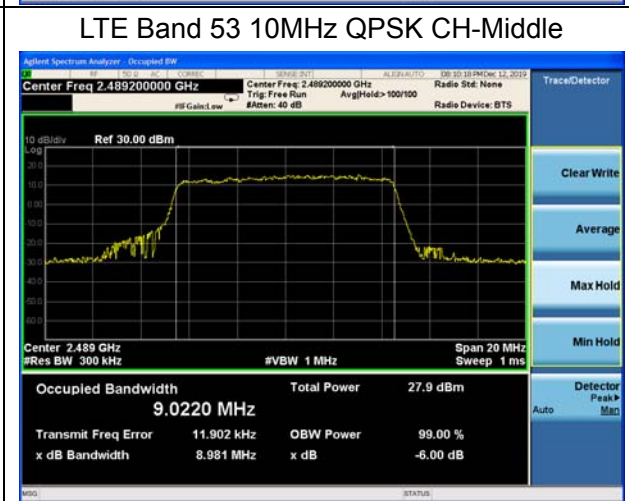
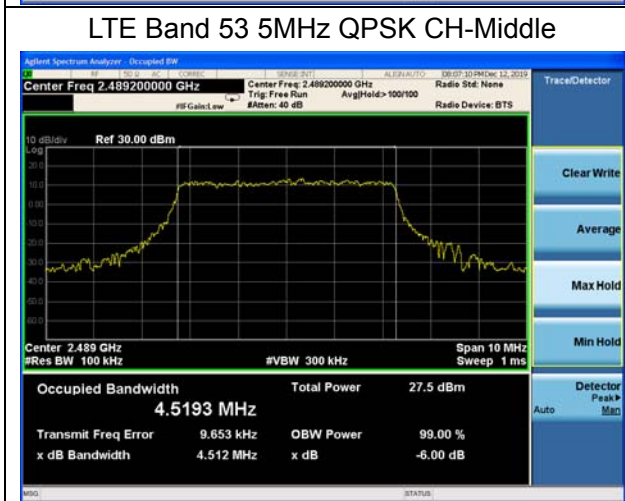
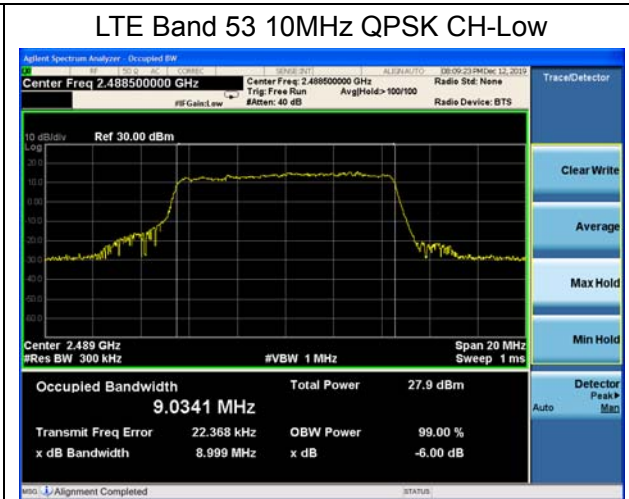
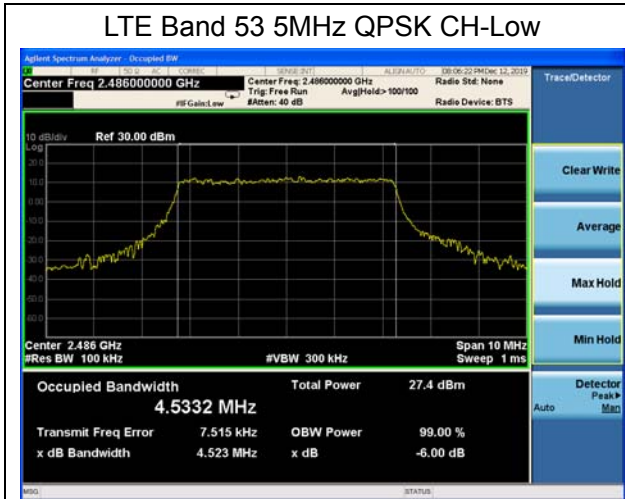

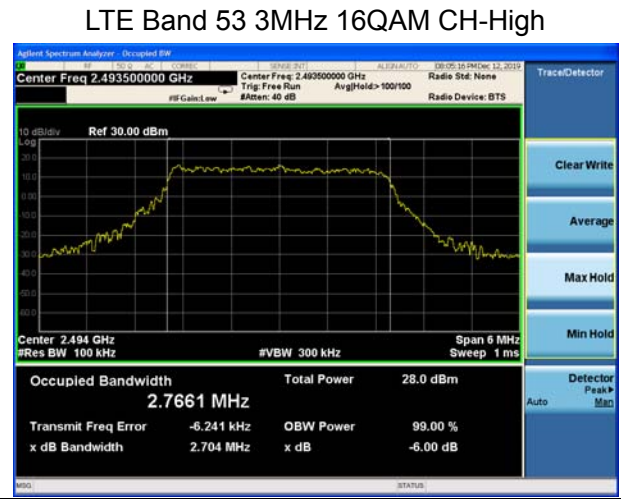
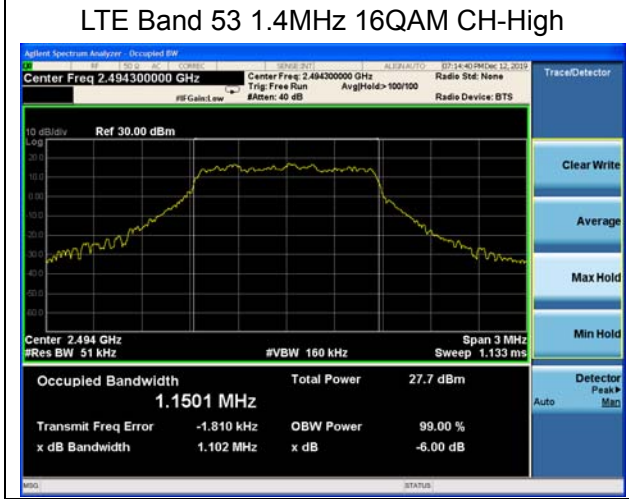
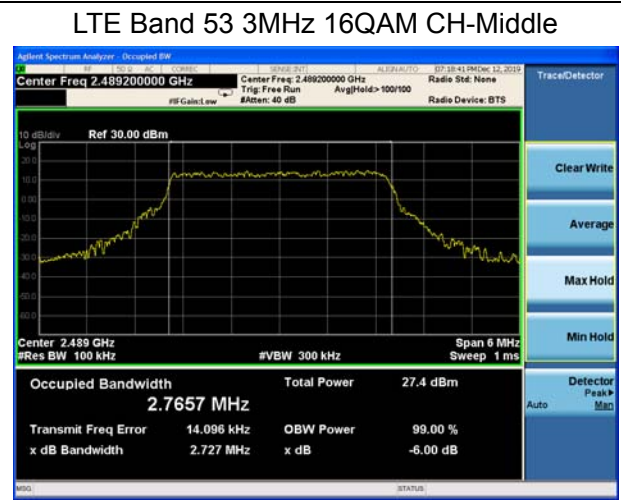
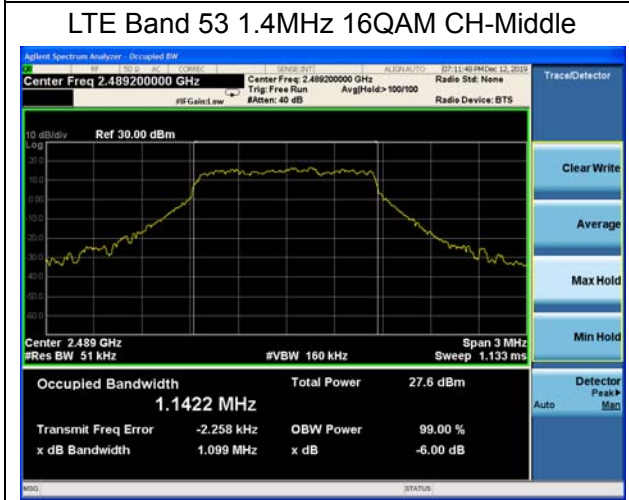
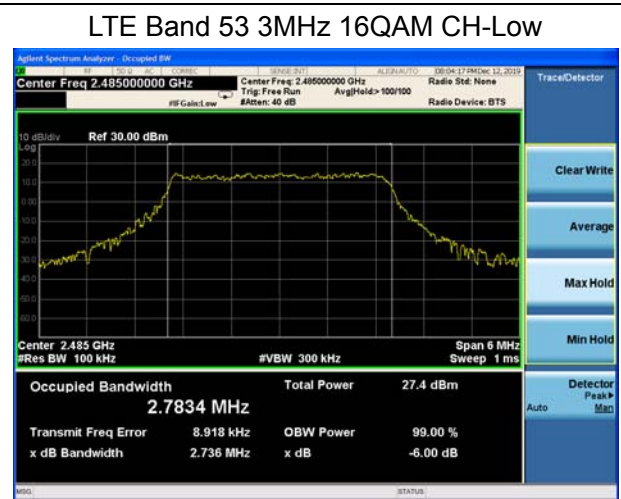
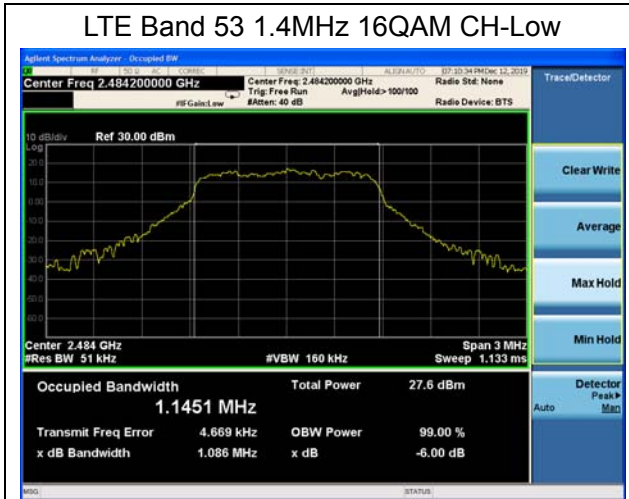

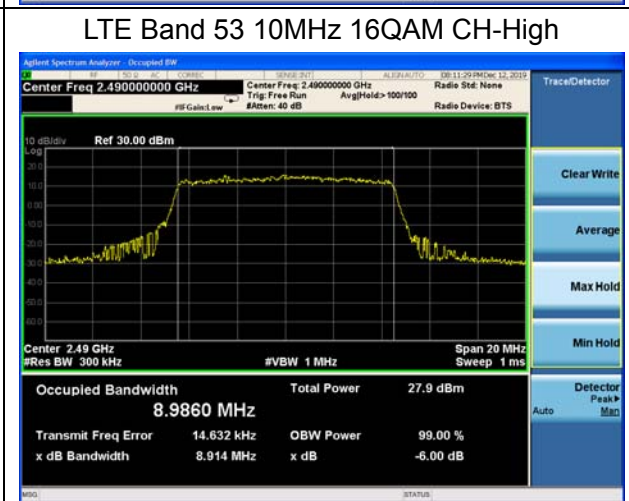
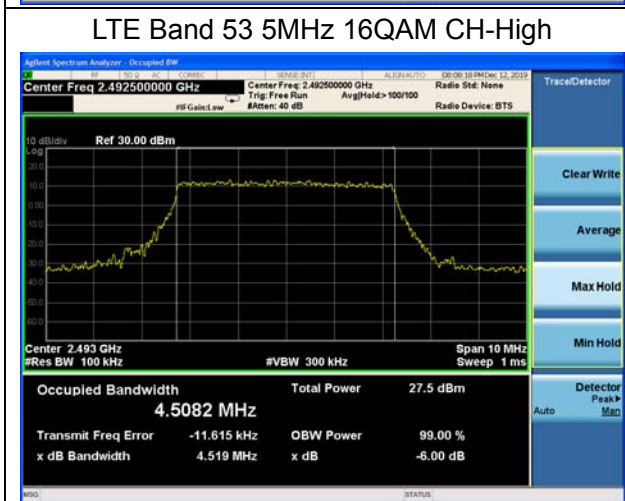
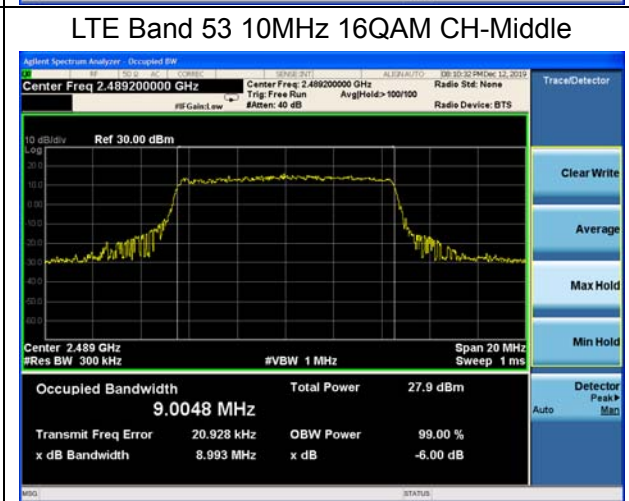
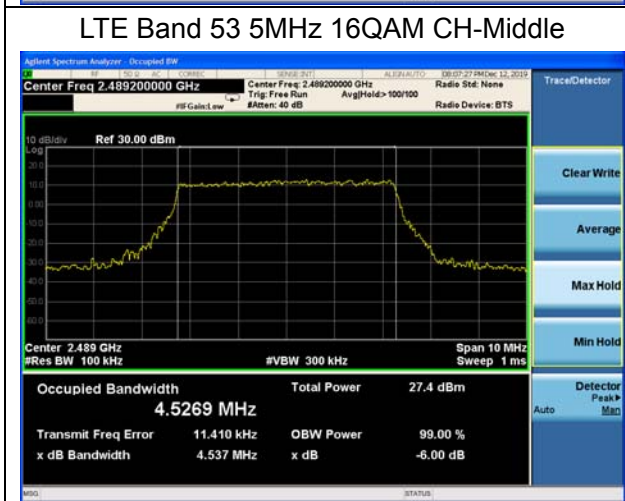
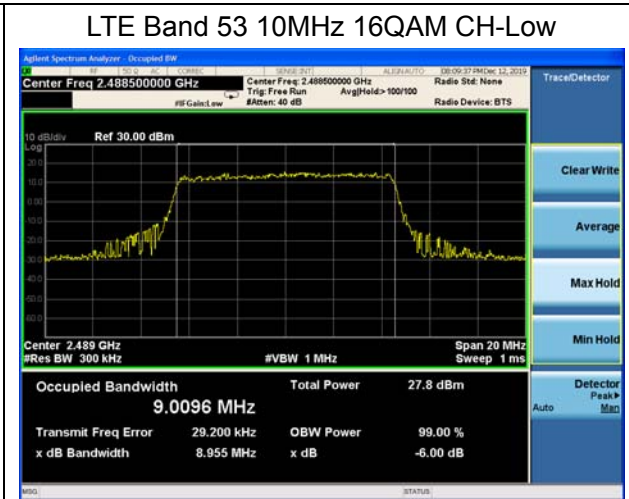
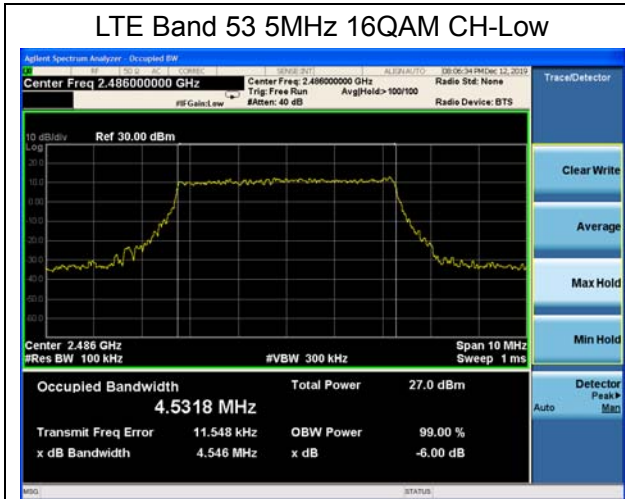

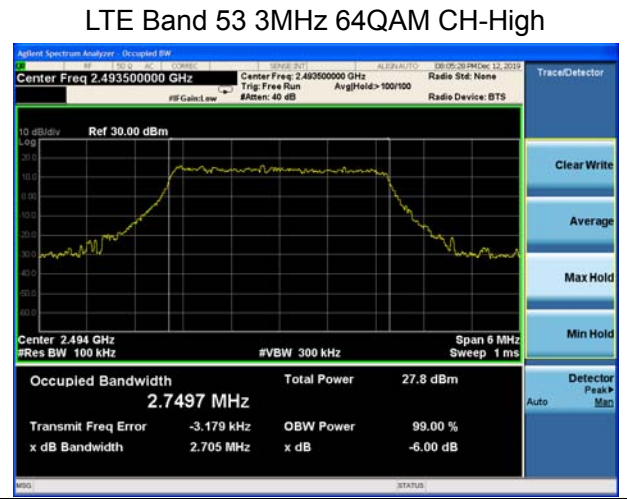
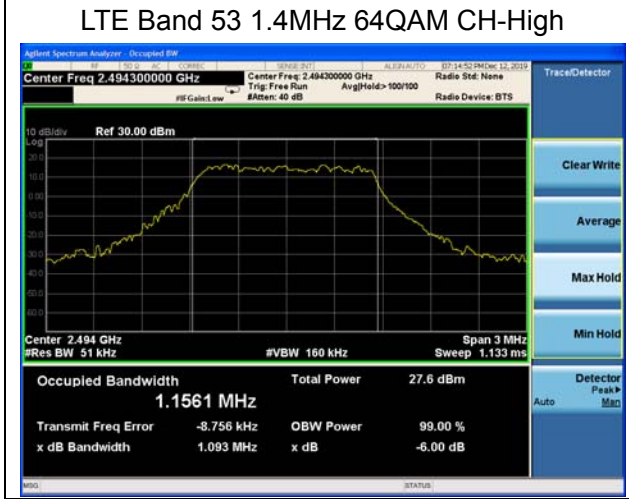
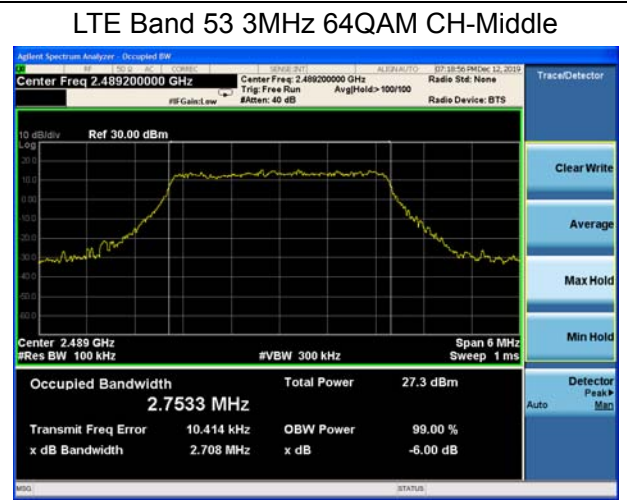
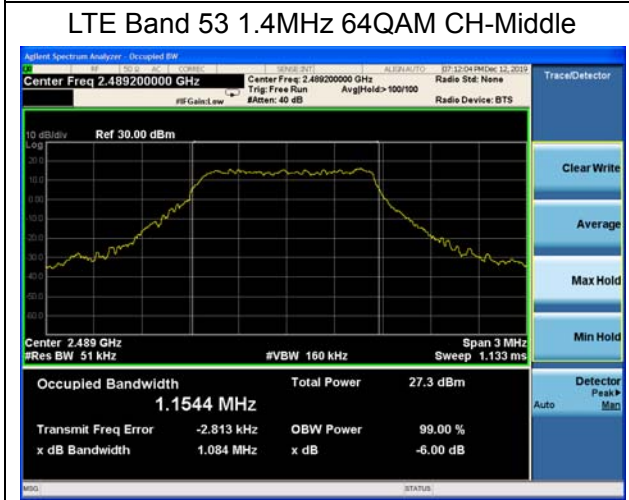
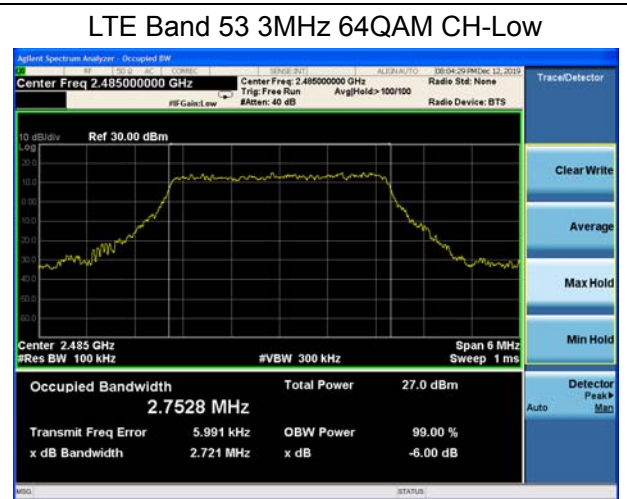
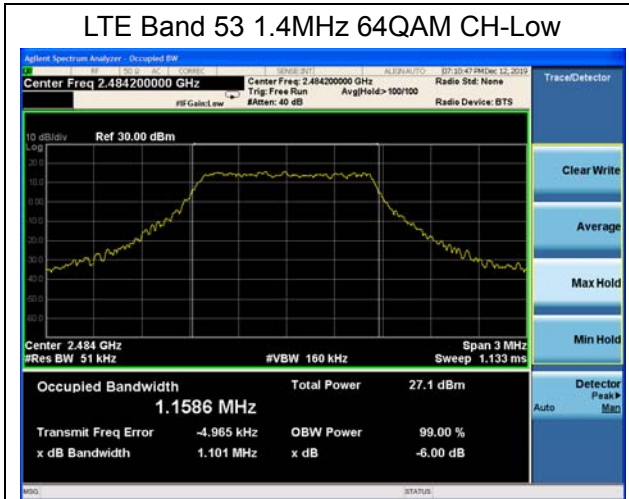

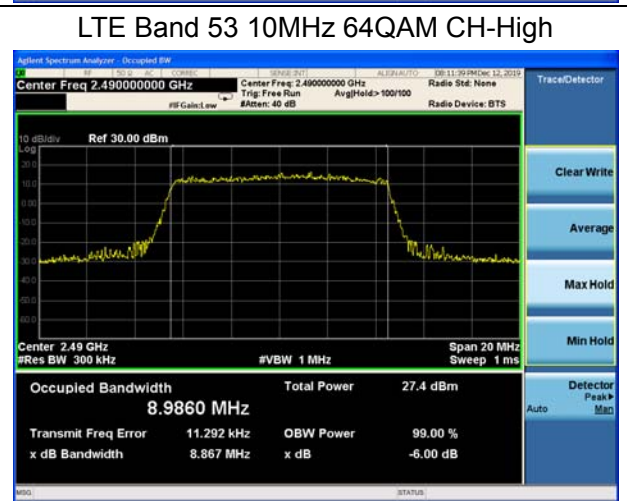
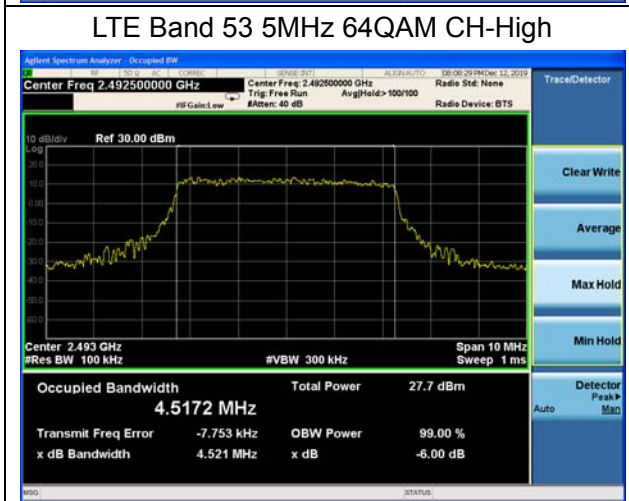
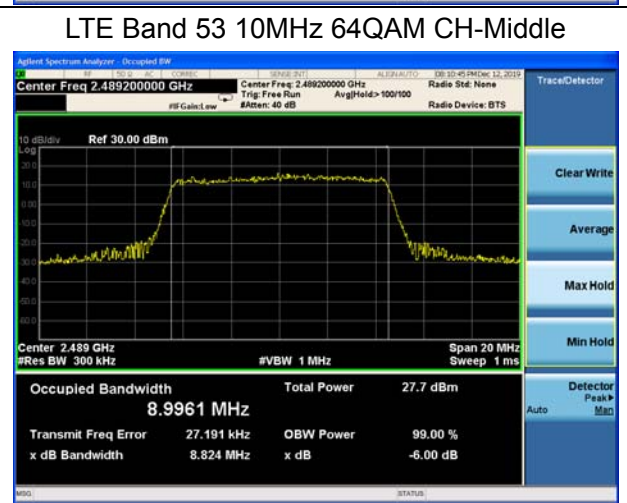
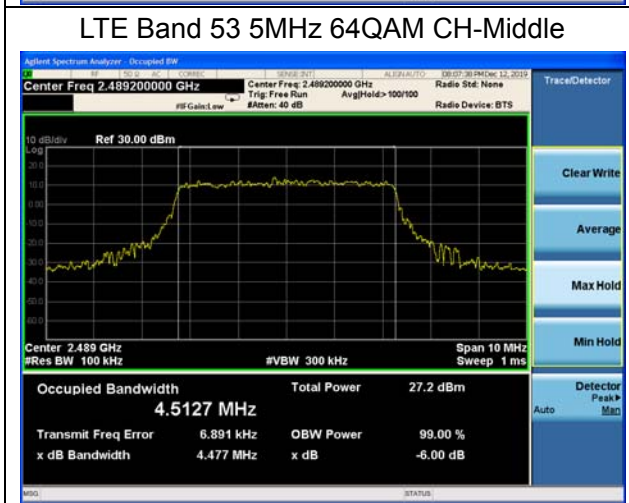
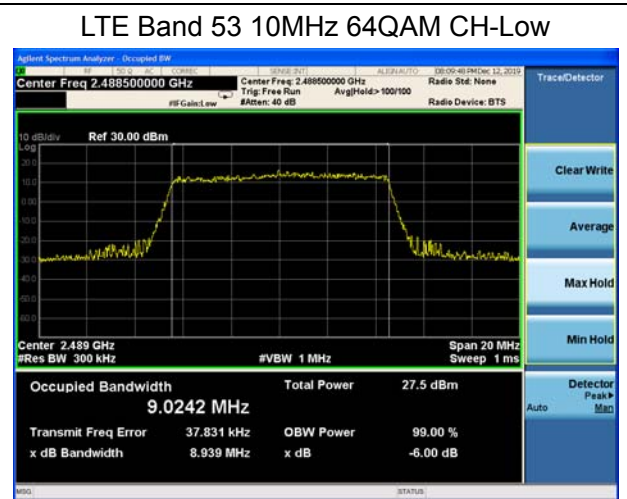
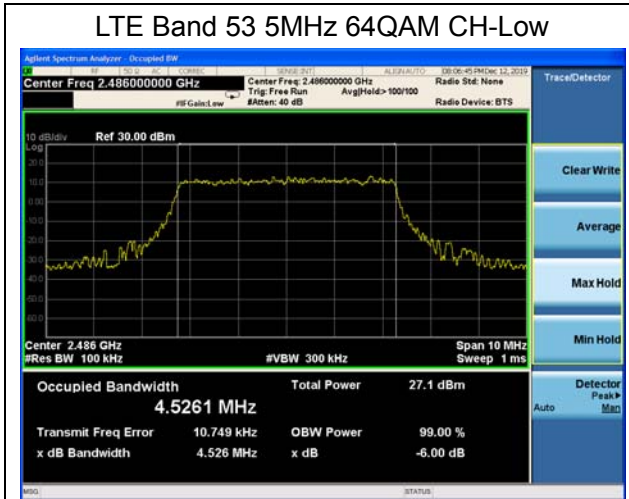

5.3. Power Spectral Density

Ambient condition

Temperature	Relative humidity	Pressure
23°C ~25°C	45%~50%	101.5kPa

Method of Measurement

During the process of the testing, The EUT was connected to Spectrum Analyzer with a known loss. The EUT is max power transmission with proper modulation.

Test setup

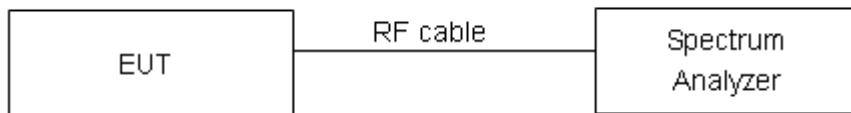

Limits

The maximum power spectral density conducted to the antenna is not greater than 8 dBm in any 3 kHz band during any time interval of continuous transmission;

Limits	$\leq 8 \text{ dBm} / 3\text{kHz}$
--------	------------------------------------

Measurement Uncertainty

The assessed measurement uncertainty to ensure 95% confidence level for the normal distribution is with the coverage factor $k = 2$, $U = 0.75\text{dB}$.



Test Results:

LTE Band 53						
Modulation	Bandwidth (MHz)	Channel	Frequency (MHz)	Power Spectral Density (dBm / 3kHz)	Limit (dBm / 3kHz)	Conclusion
QPSK	1.4	60147	2484.2	-6.566	8	PASS
		60197	2489.2	-5.442	8	PASS
		60248	2494.3	-6.090	8	PASS
	3	60155	2485	-10.070	8	PASS
		60197	2489.2	-10.254	8	PASS
		60240	2493.5	-9.881	8	PASS
	5	60165	2486	-12.460	8	PASS
		60197	2489.2	-12.143	8	PASS
		60230	2492.5	-12.253	8	PASS
	10	60190	2488.5	-14.398	8	PASS
		60197	2489.2	-13.817	8	PASS
		60205	2490	-14.435	8	PASS
16QAM	1.4	60147	2484.2	-5.184	8	PASS
		60197	2489.2	-4.941	8	PASS
		60248	2494.3	-6.463	8	PASS
	3	60155	2485	-10.586	8	PASS
		60197	2489.2	-9.548	8	PASS
		60240	2493.5	-9.251	8	PASS
	5	60165	2486	-12.858	8	PASS
		60197	2489.2	-12.053	8	PASS
		60230	2492.5	-12.253	8	PASS
	10	60190	2488.5	-13.811	8	PASS
		60197	2489.2	-13.902	8	PASS
		60205	2490	-13.690	8	PASS
64QAM	1.4	60147	2484.2	-5.600	8	PASS
		60197	2489.2	-5.587	8	PASS
		60248	2494.3	-6.302	8	PASS
	3	60155	2485	-10.269	8	PASS
		60197	2489.2	-10.124	8	PASS
		60240	2493.5	-10.467	8	PASS



	5	60165	2486	-11.457	8	PASS
		60197	2489.2	-11.692	8	PASS
		60230	2492.5	-11.481	8	PASS
	10	60190	2488.5	-13.546	8	PASS
		60197	2489.2	-13.202	8	PASS
		60205	2490	-13.281	8	PASS

LTE Band 53 1.4MHz QPSK 1RB CH-Low

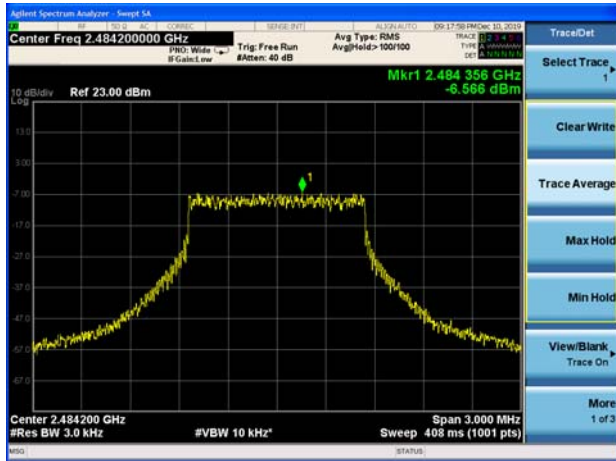

LTE Band 53 3MHz QPSK 1RB CH-Low

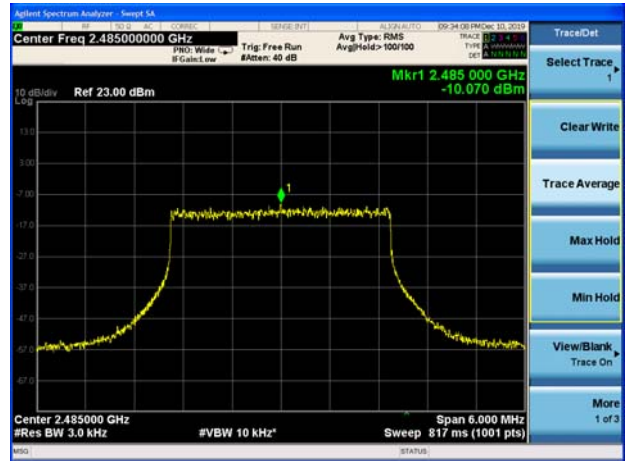

LTE Band 53 1.4MHz QPSK 1RB CH-Middle

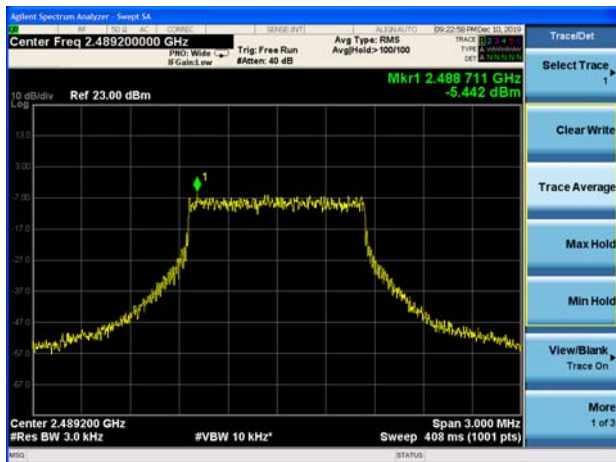

LTE Band 53 3MHz QPSK 1RB CH-Middle

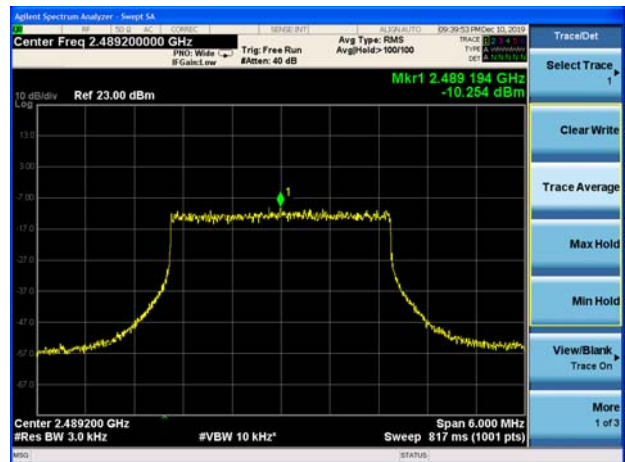

LTE Band 53 1.4MHz QPSK 1RB CH-High

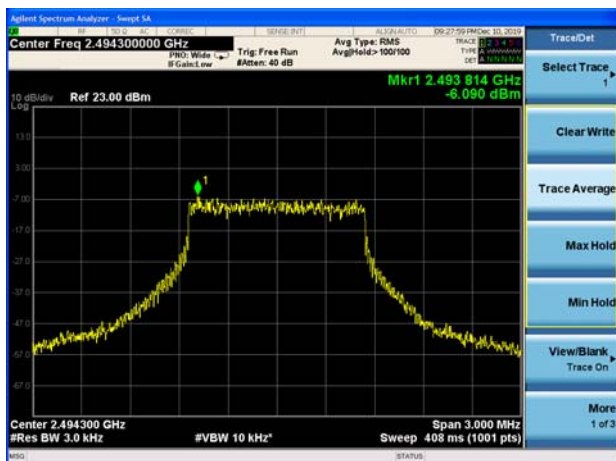

LTE Band 53 3MHz QPSK 1RB CH-High

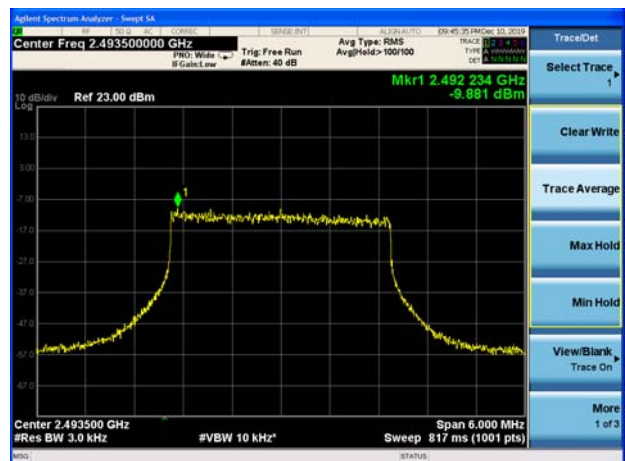

LTE Band 53 5MHz QPSK 1RB CH-Low

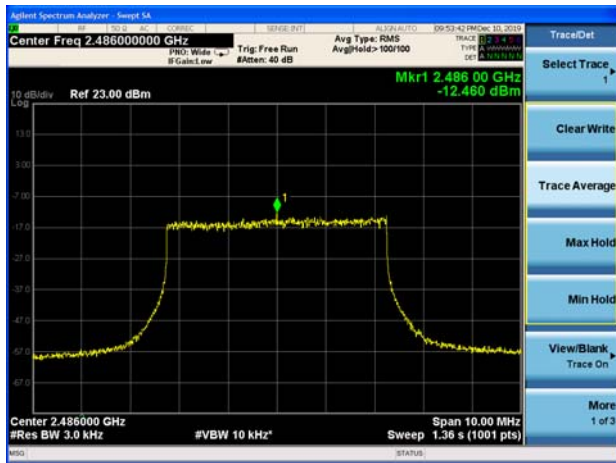

LTE Band 53 10MHz QPSK 1RB CH-Low

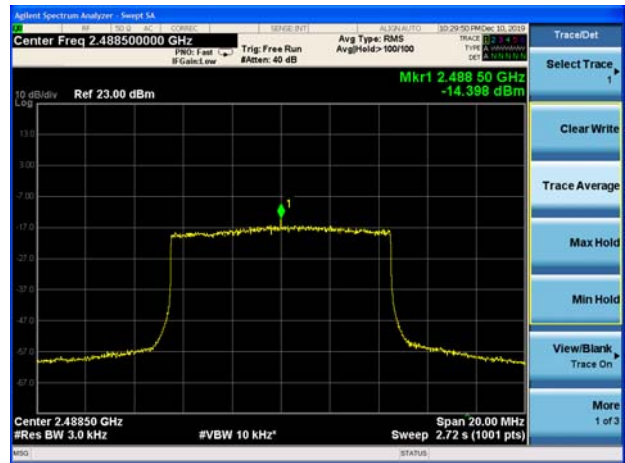

LTE Band 53 5MHz QPSK 1RB CH-Middle

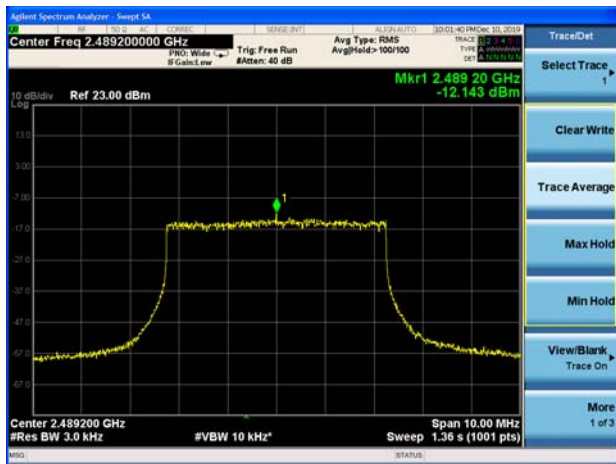

LTE Band 53 10MHz QPSK 1RB CH-Middle

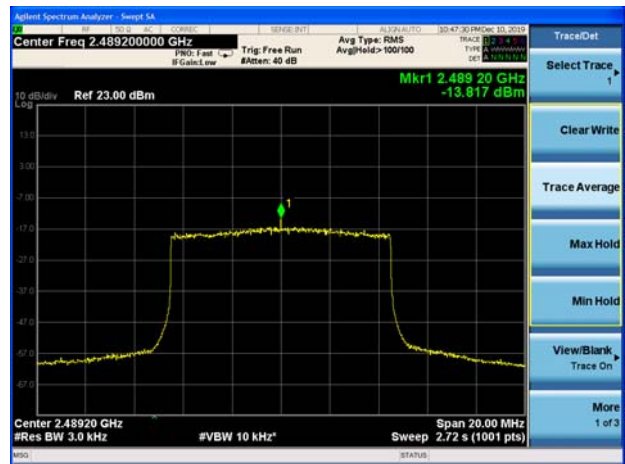

LTE Band 53 5MHz QPSK 1RB CH-High

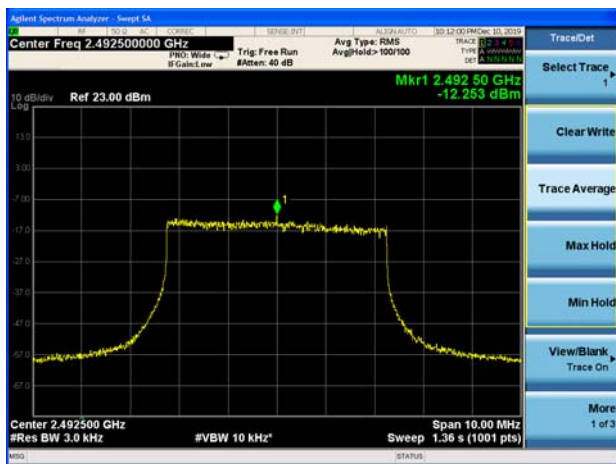

LTE Band 53 10MHz QPSK 1RB CH-High

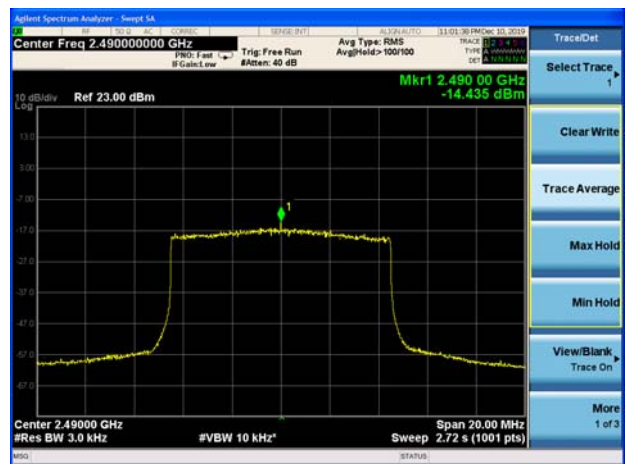



LTE Band 53 1.4MHz 16QAM 1RB CH-Low

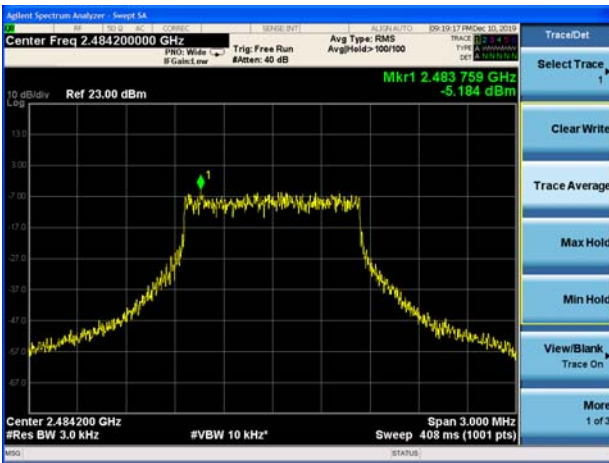

LTE Band 53 3MHz 16QAM 1RB CH-Low

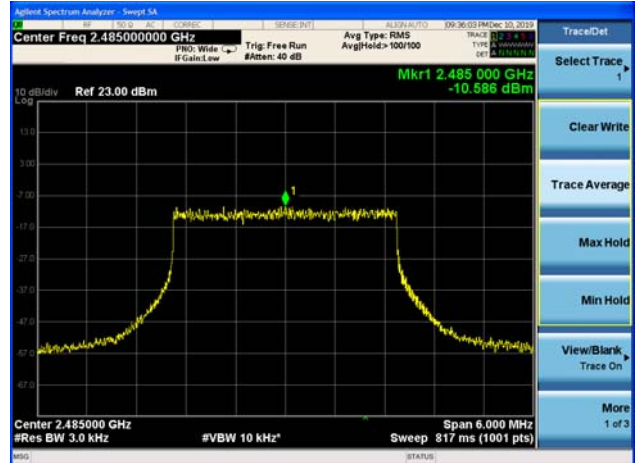

LTE Band 53 1.4MHz 16QAM 1RB CH-Middle

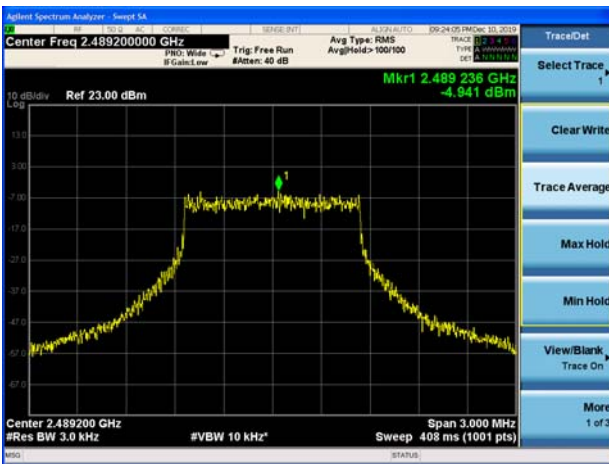

LTE Band 53 3MHz 16QAM 1RB CH-Middle

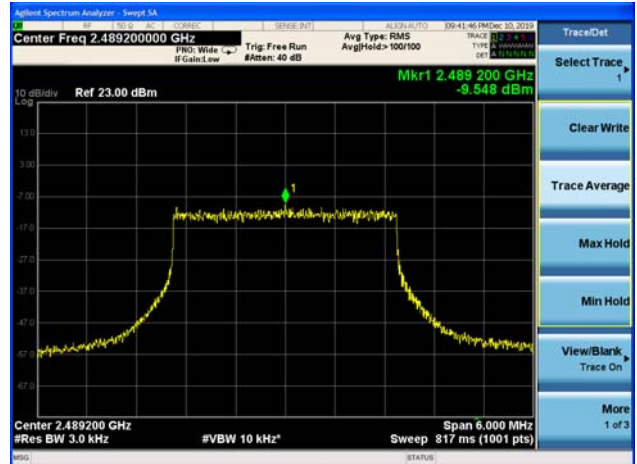

LTE Band 53 1.4MHz 16QAM 1RB CH-High

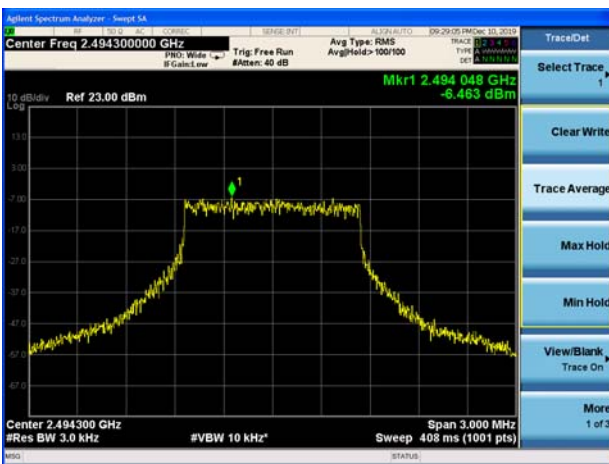

LTE Band 53 3MHz 16QAM 1RB CH-High

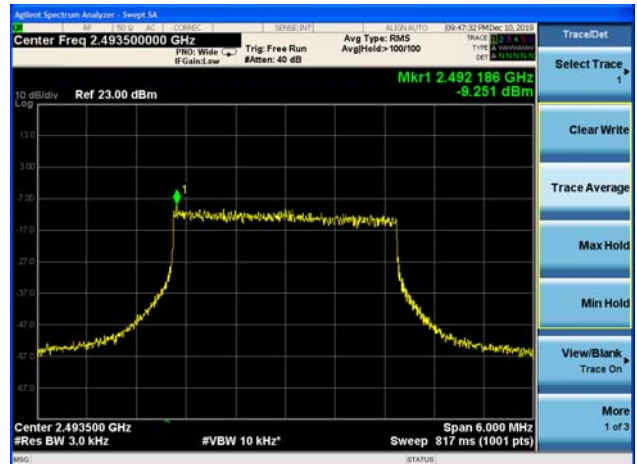

LTE Band 53 5MHz 16QAM 1RB CH-Low

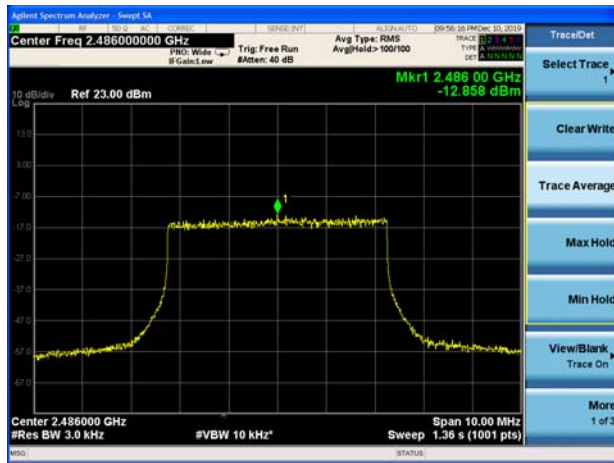

LTE Band 53 10MHz 16QAM 1RB CH-Low

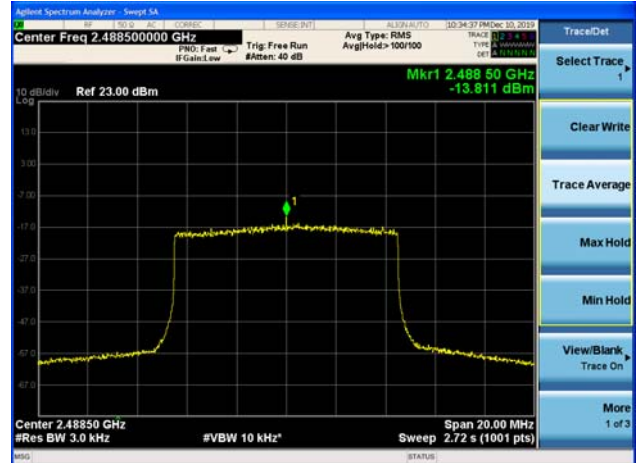

LTE Band 53 5MHz 16QAM 1RB CH-Middle

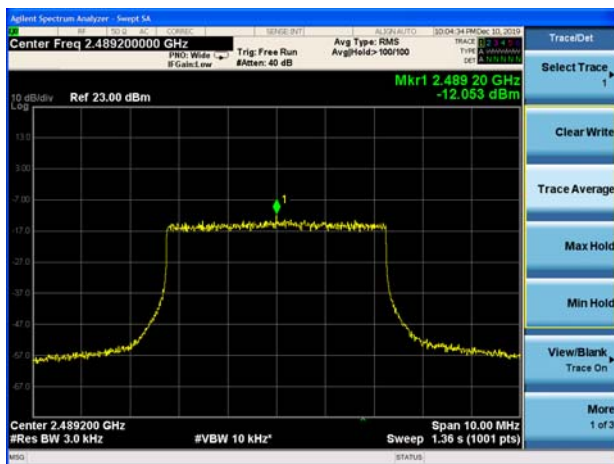

LTE Band 53 10MHz 16QAM 1RB CH-Middle

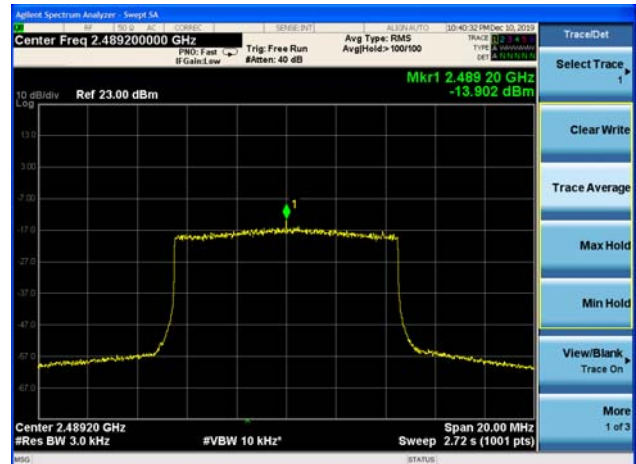

LTE Band 53 5MHz 16QAM 1RB CH-High

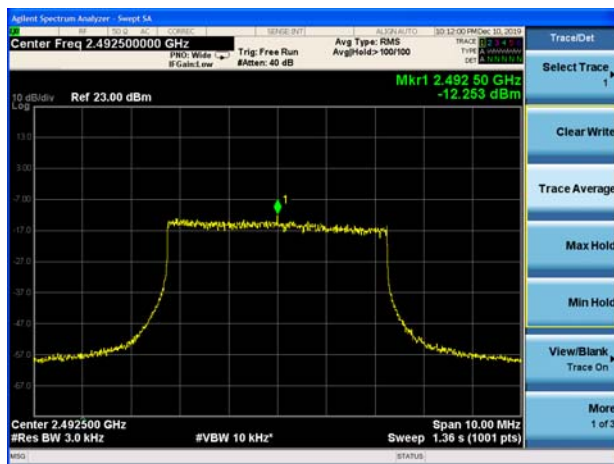

LTE Band 53 10MHz 16QAM 1RB CH-High

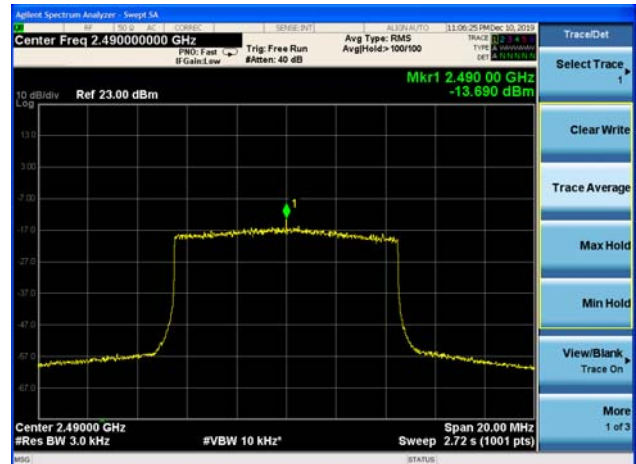

LTE Band 53 1.4MHz 64QAM 1RB CH-Low

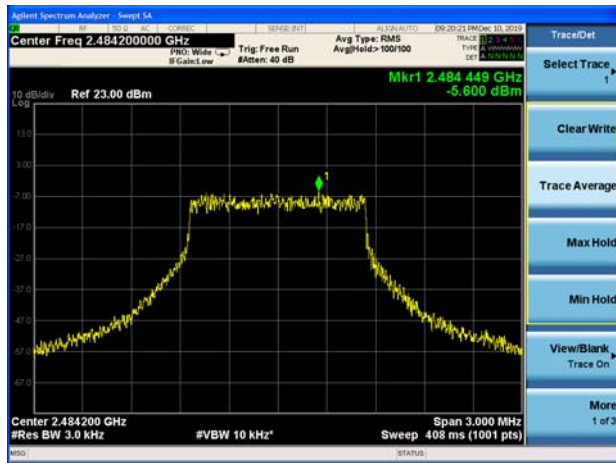

LTE Band 53 3MHz 64QAM 1RB CH-Low

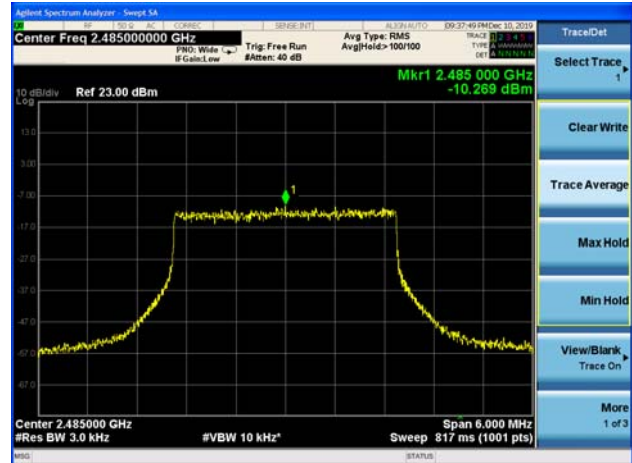

LTE Band 53 1.4MHz 64QAM 1RB CH-Middle

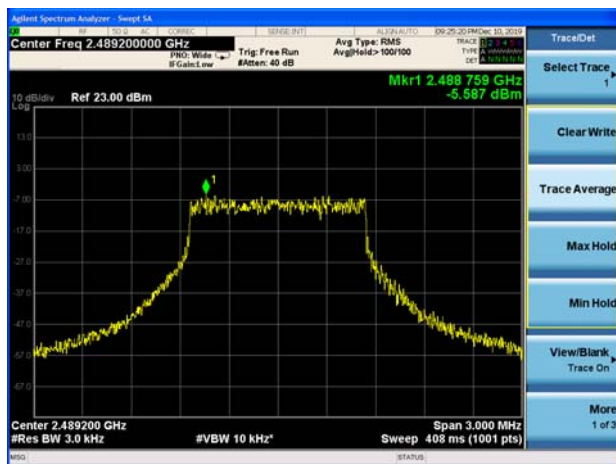

LTE Band 53 3MHz 64QAM 1RB CH-Middle

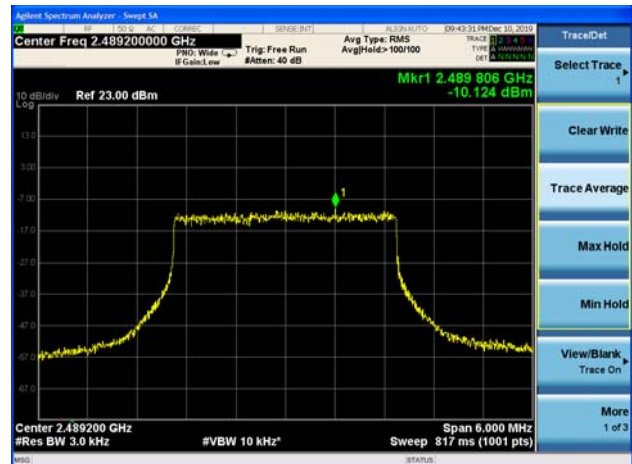

LTE Band 53 1.4MHz 64QAM 1RB CH-High

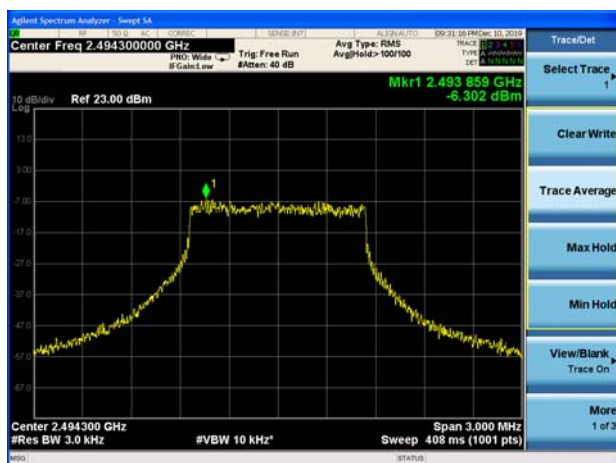

LTE Band 53 3MHz 64QAM 1RB CH-High

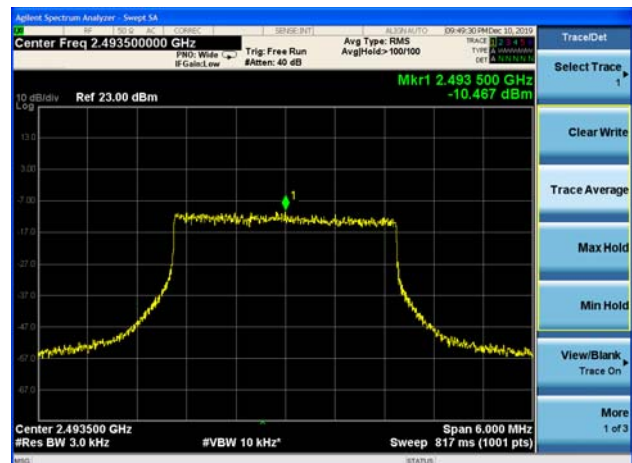



LTE Band 53 5MHz 64QAM 1RB CH-Low

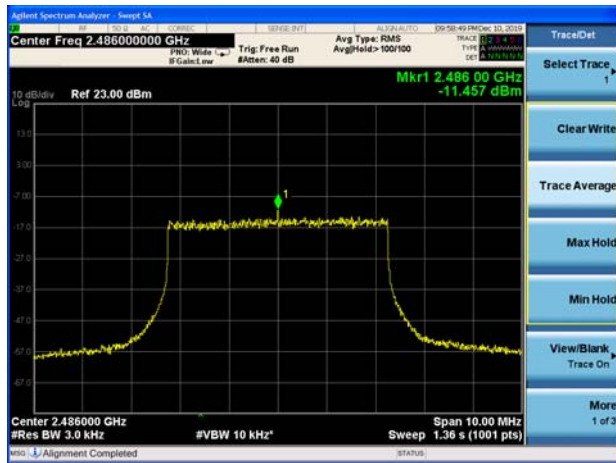

LTE Band 53 10MHz 64QAM 1RB CH-Low

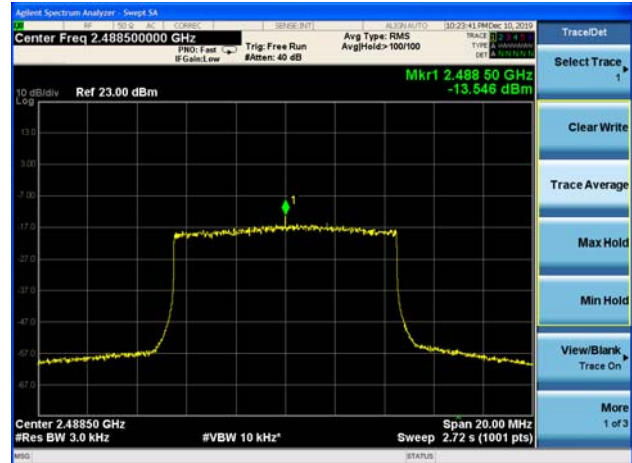

LTE Band 53 5MHz 64QAM 1RB CH-Middle

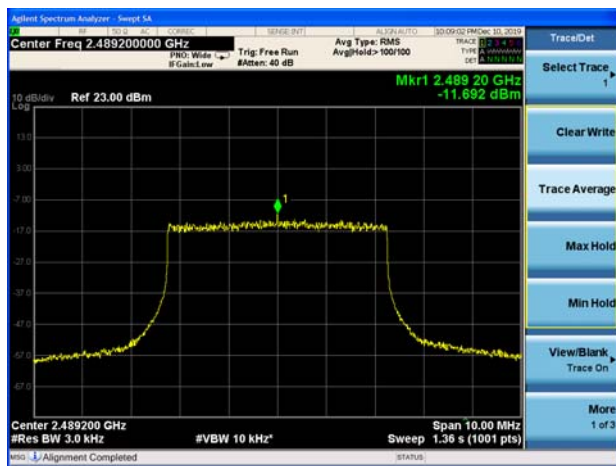

LTE Band 53 10MHz 64QAM 1RB CH-Middle

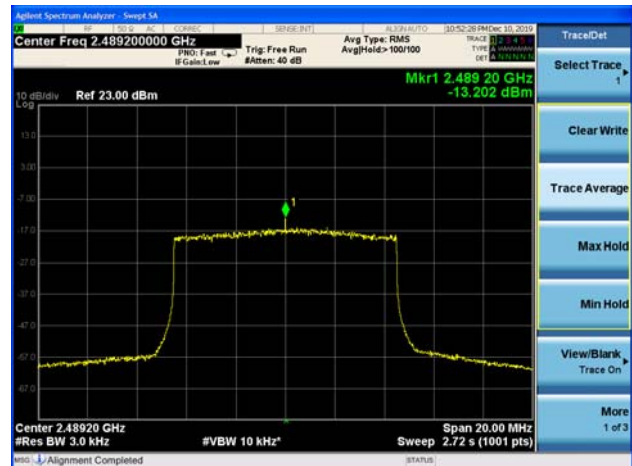

LTE Band 53 5MHz 64QAM 1RB CH-High

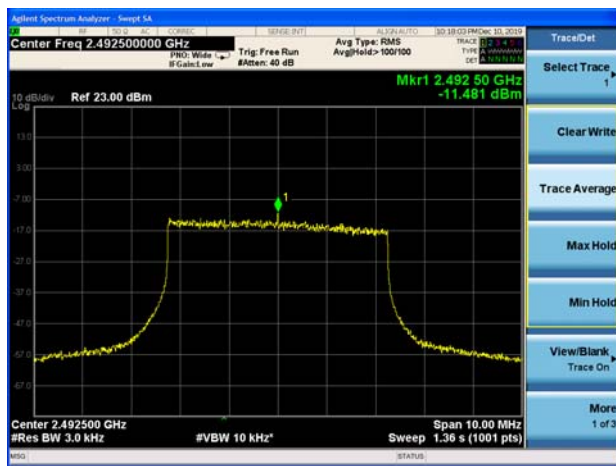

LTE Band 53 10MHz 64QAM 1RB CH-High

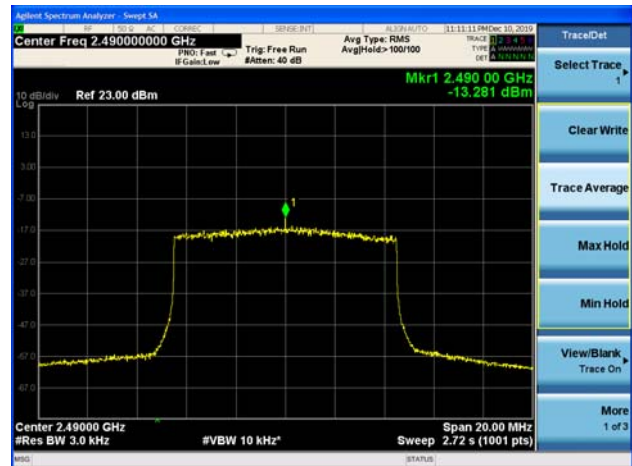

5.4. Band Edge Compliance

Ambient condition

Temperature	Relative humidity	Pressure
23°C ~25°C	45%~50%	101.5kPa

Method of Measurement

The EUT was connected to Spectrum Analyzer and Base Station Simulator via power Splitter. The band edge of the lowest and highest channels were measured. The Average detector is used. Spectrum analyzer plots are included on the following pages.

Test Setup

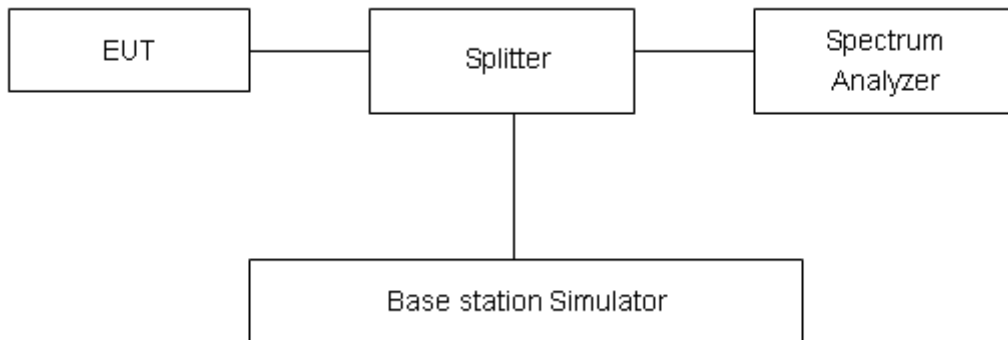

Limits

Emissions below 2483.5 MHz are attenuated below the transmitter power (P) measured in watts by a factor of at least $40 + 10 \log (P)$ dB at the channel edge at 2483.5 MHz, $43 + 10 \log (P)$ dB at 5 MHz from the channel edge, and $55 + 10 \log (P)$ dB at X MHz from the channel edge where X is the greater of 6 MHz or the actual emission bandwidth.

Emissions above 2495 MHz are attenuated below the transmitter power (P) measured in watts by a factor of at least $43 + 10 \log (P)$ dB on all frequencies between the channel edge at 2495 MHz and X MHz from this channel edge and $55 + 10 \log (P)$ dB on all frequencies more than X MHz from this channel edge, where X is the greater of 6 MHz or the actual emission bandwidth;

Measurement Uncertainty

The assessed measurement uncertainty to ensure 95% confidence level for the normal distribution is with the coverage factor $k = 1.96$, $U=0.684$ dB.



Test Result:

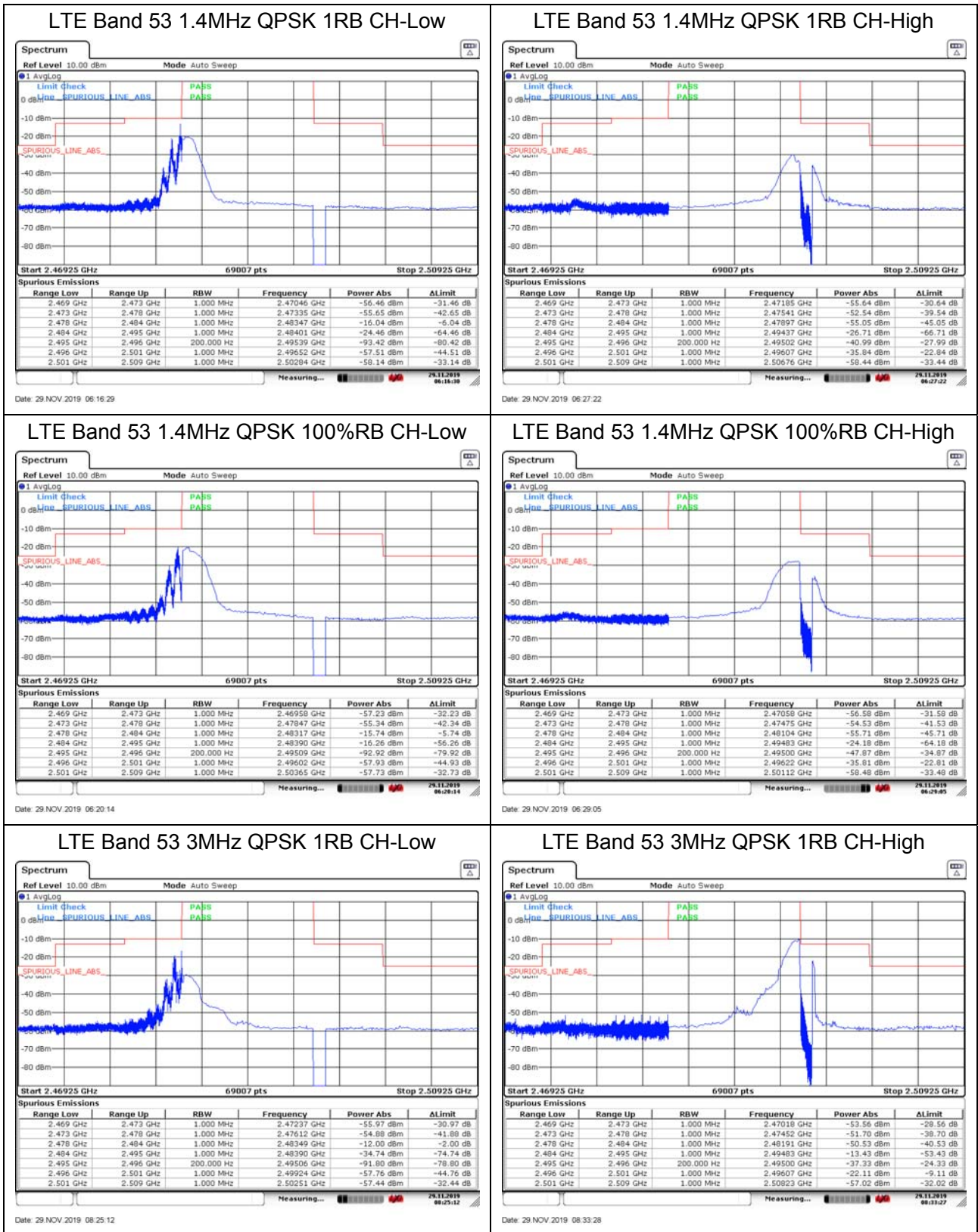



LTE Band 53 3MHz QPSK 100%RB CH-Low

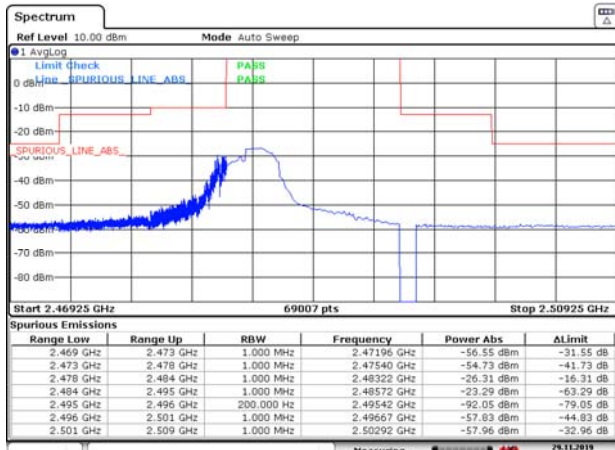

Date: 29 NOV 2019 08:28:18

LTE Band 53 3MHz QPSK 100%RB CH-High

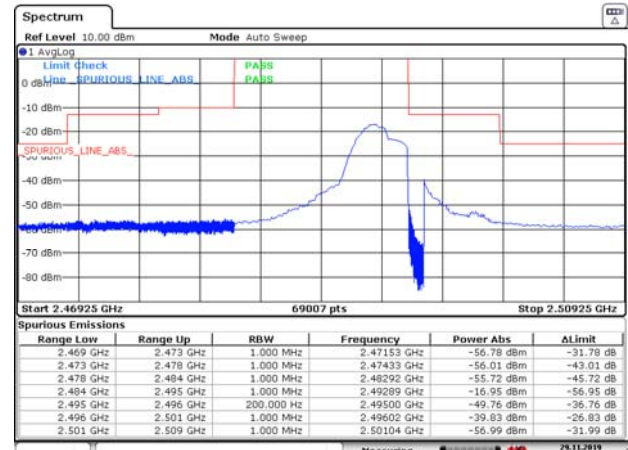

Date: 29 NOV 2019 08:42:07

LTE Band 53 5MHz QPSK 1RB CH-Low

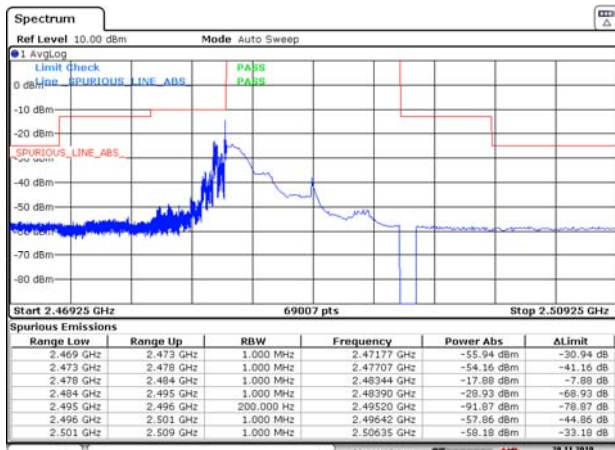

Date: 29 NOV 2019 08:53:37

LTE Band 53 5MHz QPSK 1RB CH-High

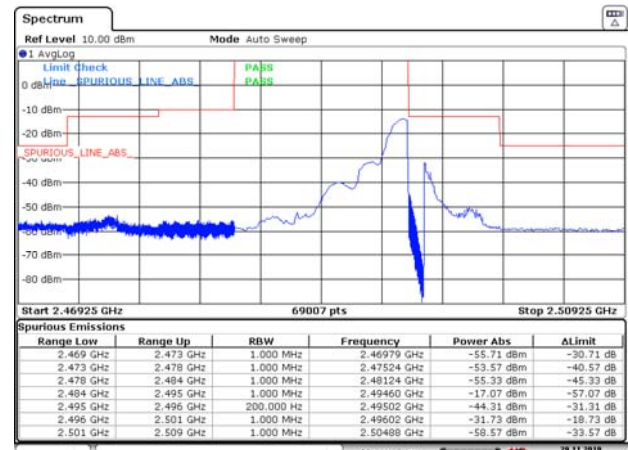

Date: 29 NOV 2019 09:00:54

LTE Band 53 5MHz QPSK 100%RB CH-Low

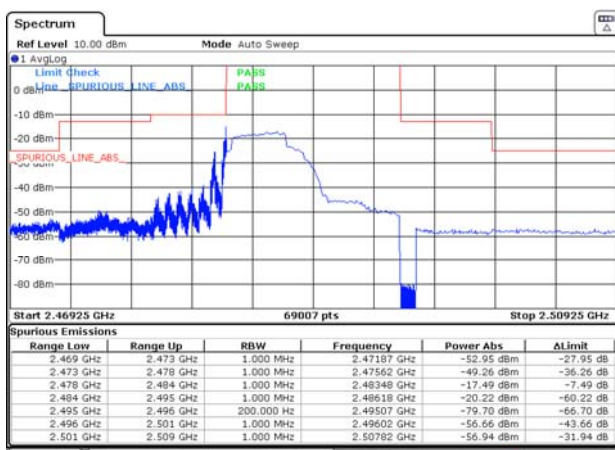

Date: 29 NOV 2019 08:54:28

LTE Band 53 5MHz QPSK 100%RB CH-High

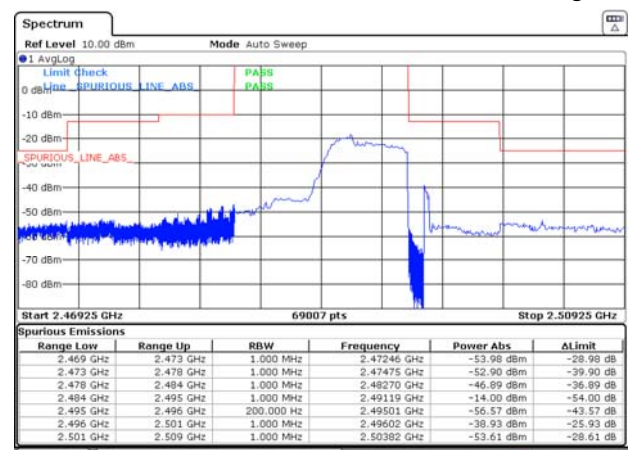

Date: 29 NOV 2019 09:01:37



LTE Band 53 10MHz QPSK 1RB CH-Low

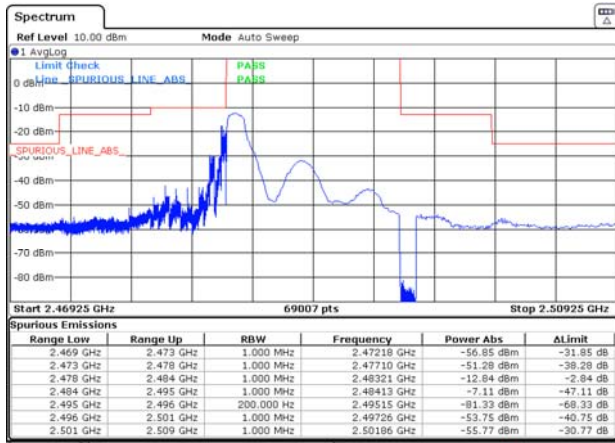

Date: 29 NOV 2019 09:23:25

LTE Band 53 10MHz QPSK 1RB CH-High

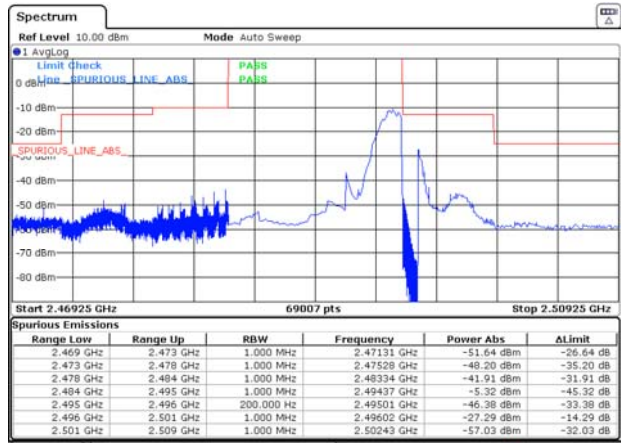

Date: 29 NOV 2019 09:43:34

LTE Band 53 10MHz QPSK 100%RB CH-Low

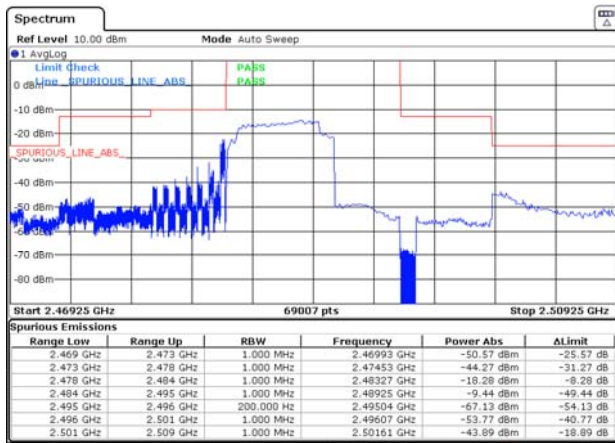

Date: 29 NOV 2019 09:34:42

LTE Band 53 10MHz QPSK 100%RB CH-High

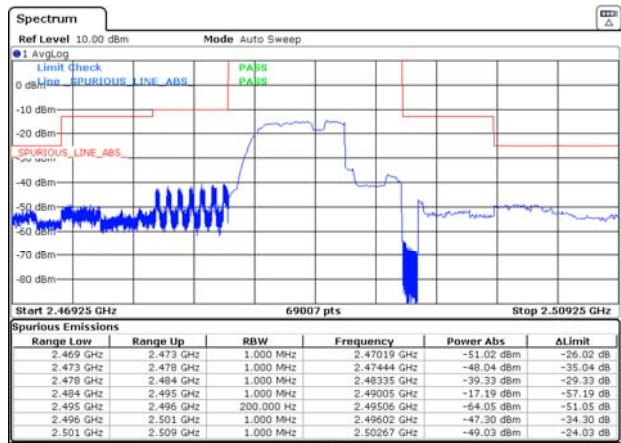

Date: 29 NOV 2019 09:45:40

LTE Band 53 1.4MHz 16QAM 1RB CH-Low

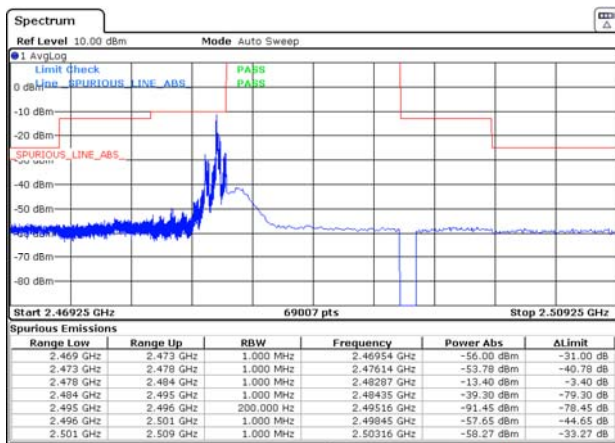

Date: 29 NOV 2019 06:21:28

LTE Band 53 1.4MHz 16QAM 1RB CH-High

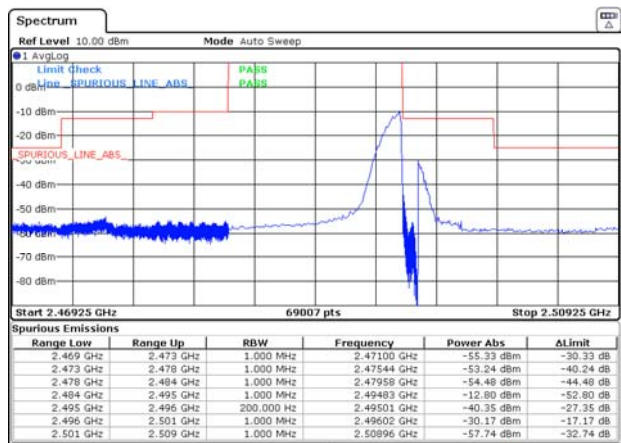

Date: 29 NOV 2019 06:28:54



LTE Band 53 1.4MHz 16QAM 100%RB CH-Low

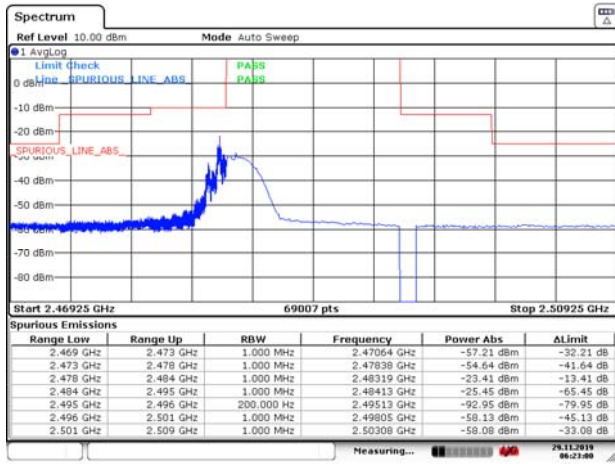

Date: 29 NOV 2019 06:23:00

LTE Band 53 1.4MHz 16QAM 100%RB CH-High

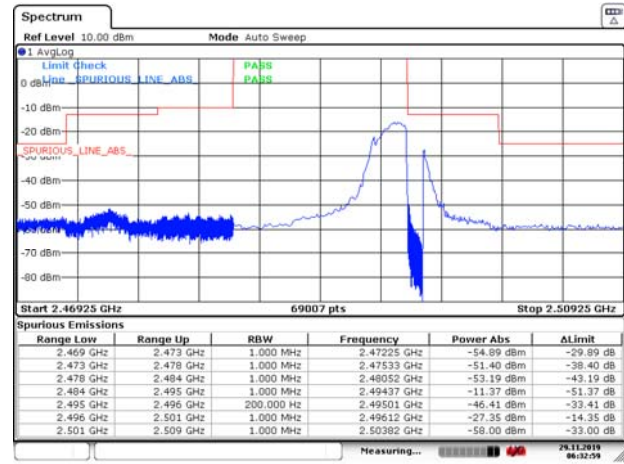

Date: 29 NOV 2019 06:32:59

LTE Band 53 3MHz 16QAM 1RB CH-Low

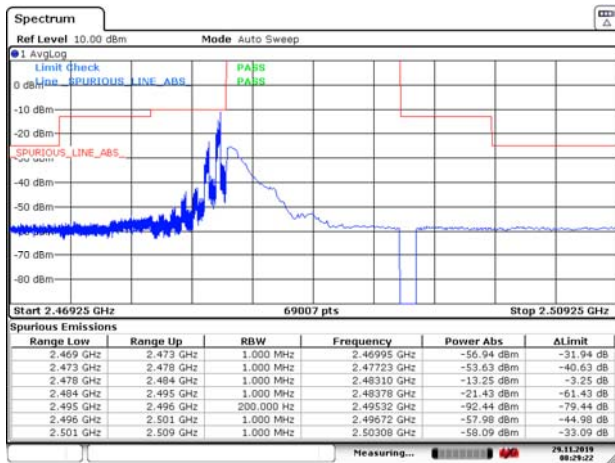

Date: 29 NOV 2019 08:29:21

LTE Band 53 3MHz 16QAM 1RB CH-High

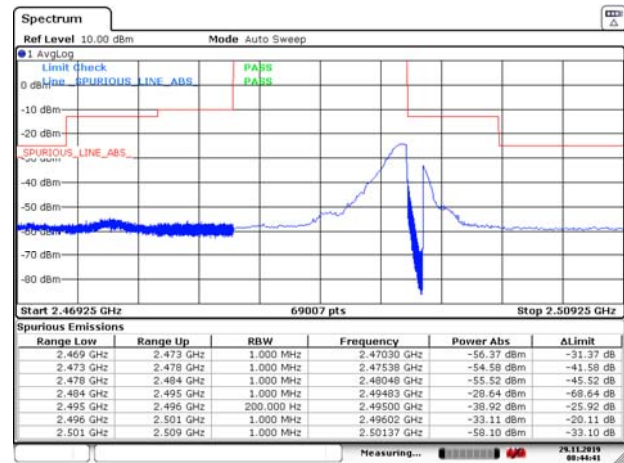

Date: 29 NOV 2019 08:44:41

LTE Band 53 3MHz 16QAM 100%RB CH-Low

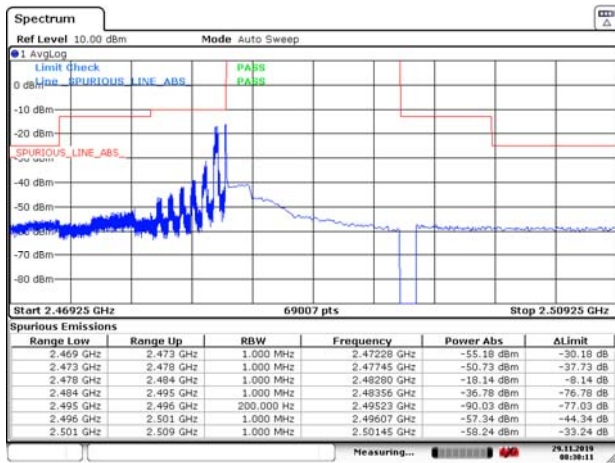

Date: 29 NOV 2019 08:30:11

LTE Band 53 3MHz 16QAM 100%RB CH-High

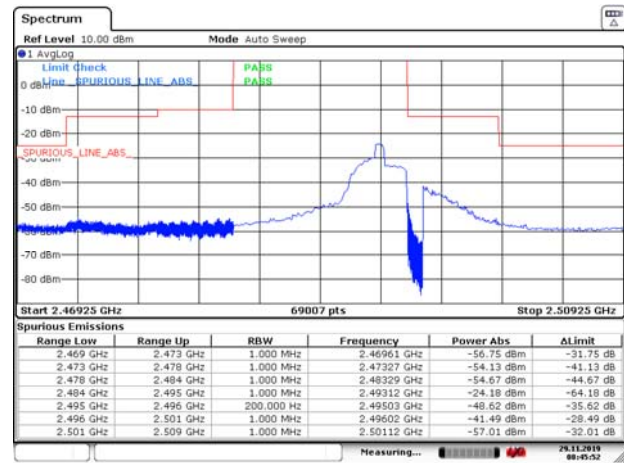

Date: 29 NOV 2019 08:45:53



LTE Band 53 5MHz 16QAM 1RB CH-Low

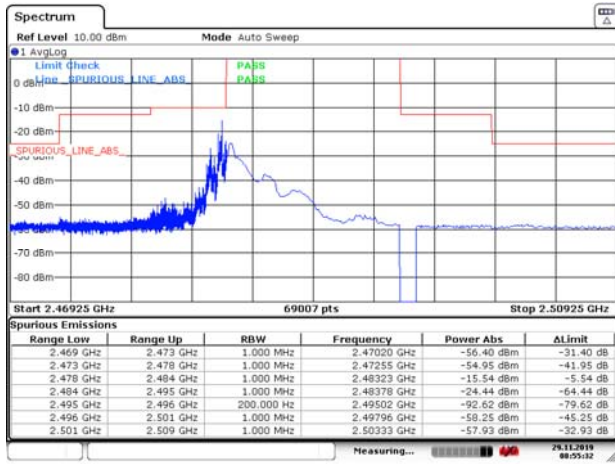

Date: 29 NOV 2019 08:55:32

LTE Band 53 5MHz 16QAM 1RB CH-High

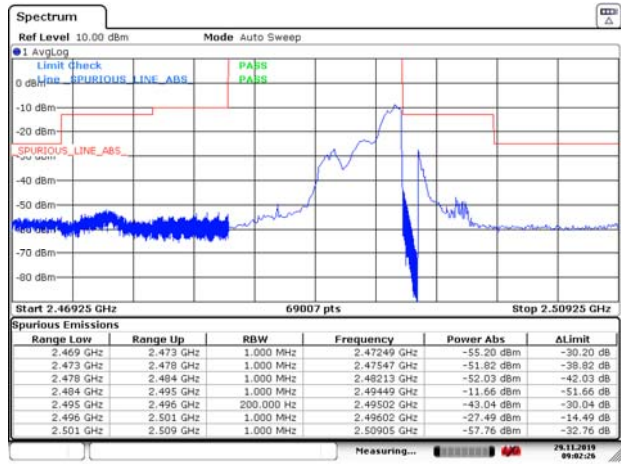

Date: 29 NOV 2019 09:02:26

LTE Band 53 5MHz 16QAM 100%RB CH-Low

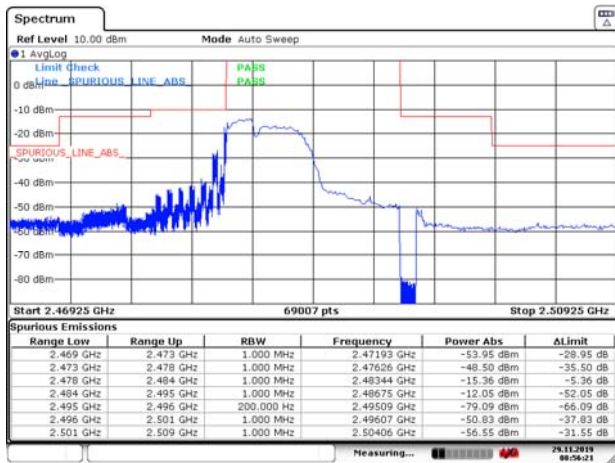

Date: 29 NOV 2019 08:56:21

LTE Band 53 5MHz 16QAM 100%RB CH-High

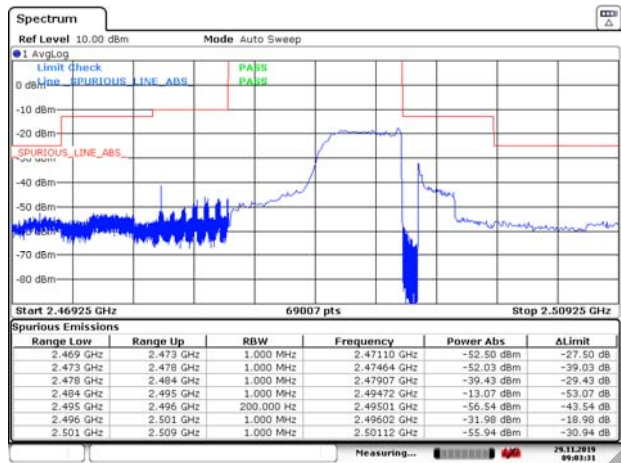

Date: 29 NOV 2019 09:03:31

LTE Band 53 10MHz 16QAM 1RB CH-Low

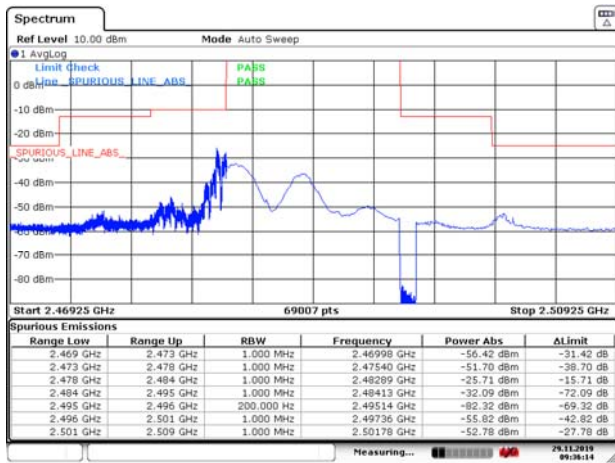

Date: 29 NOV 2019 09:36:14

LTE Band 53 10MHz 16QAM 1RB CH-High

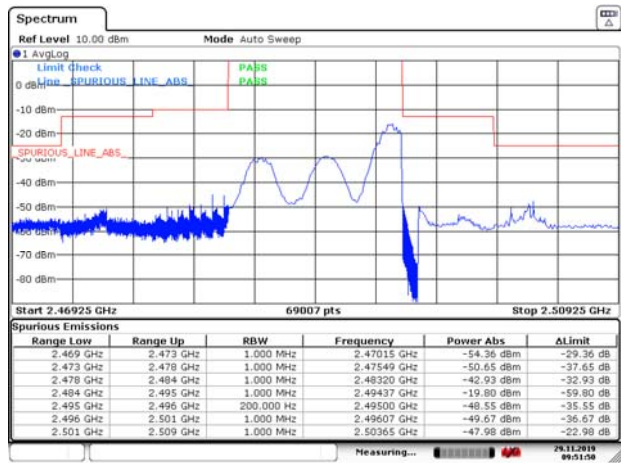

Date: 29 NOV 2019 09:51:50



LTE Band 53 10MHz 16QAM 100%RB CH-Low

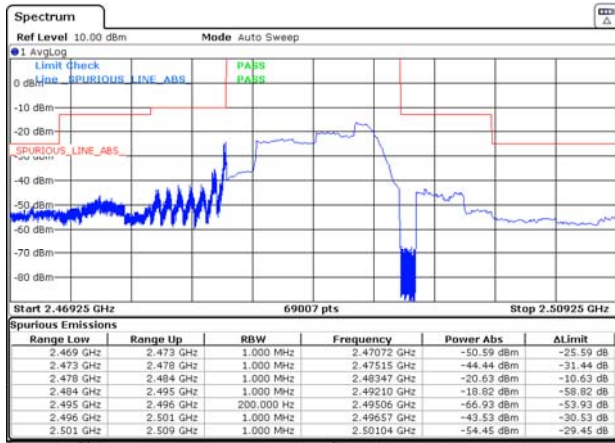

Date: 29 NOV 2019 09:39:40

LTE Band 53 10MHz 16QAM 100%RB CH-High

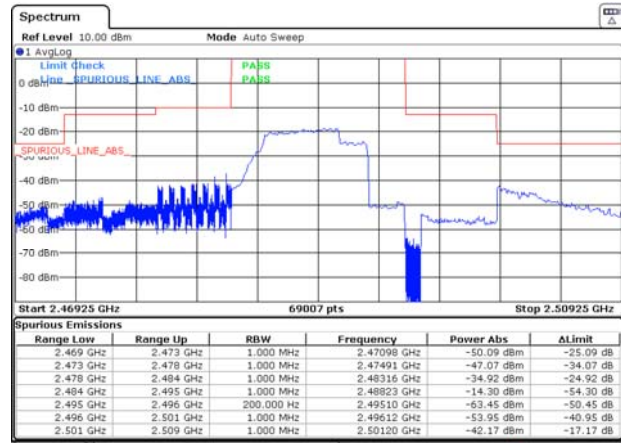

Date: 29 NOV 2019 09:52:53

LTE Band 53 1.4MHz 64QAM 1RB CH-Low

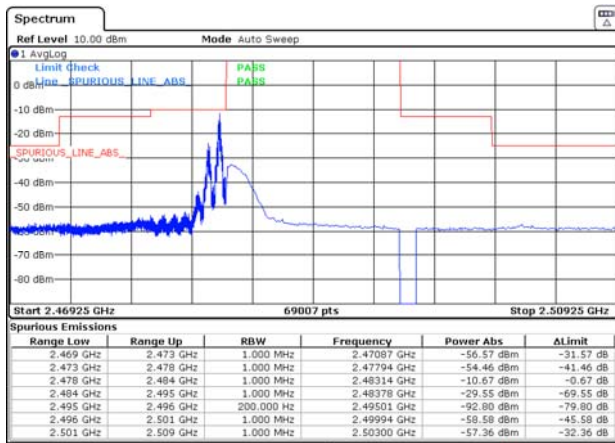

Date: 29 NOV 2019 06:24:25

LTE Band 53 1.4MHz 64QAM 1RB CH-High

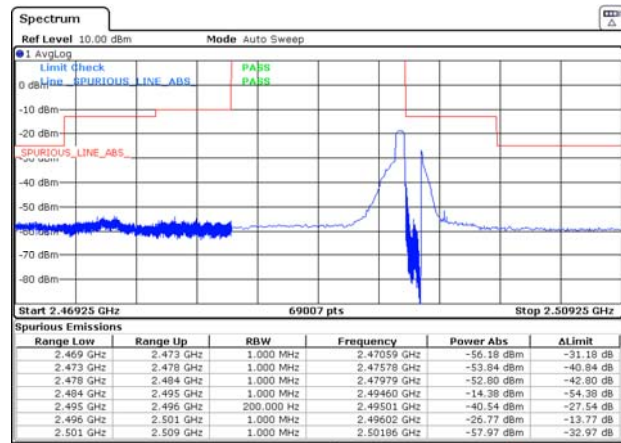

Date: 29 NOV 2019 06:34:11

LTE Band 53 1.4MHz 64QAM 100%RB CH-Low

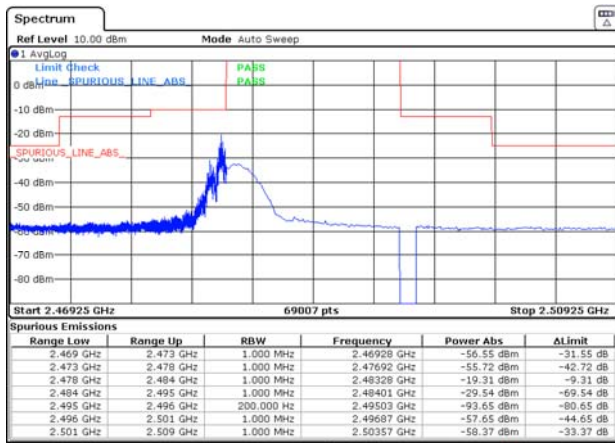

Date: 29 NOV 2019 06:25:55

LTE Band 53 1.4MHz 64QAM 100%RB CH-High

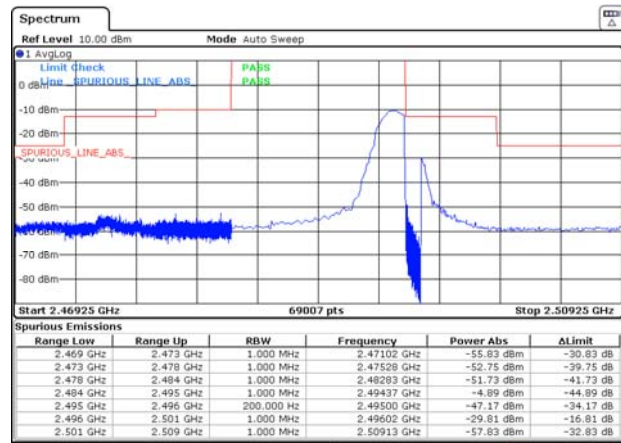

Date: 29 NOV 2019 06:35:02



LTE Band 53 3MHz 64QAM 1RB CH-Low

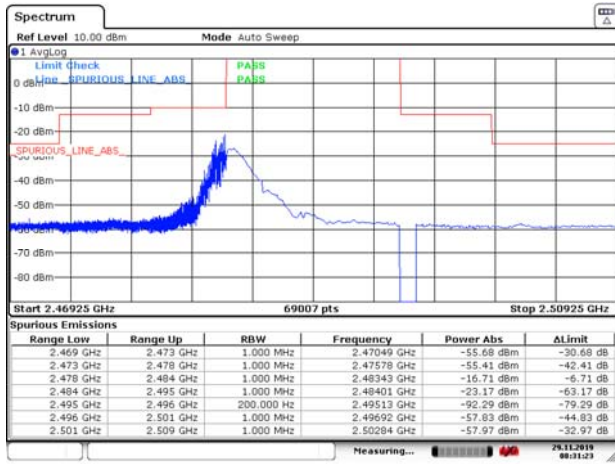

Date: 29 NOV 2019 08:31:23

LTE Band 53 3MHz 64QAM 1RB CH-High

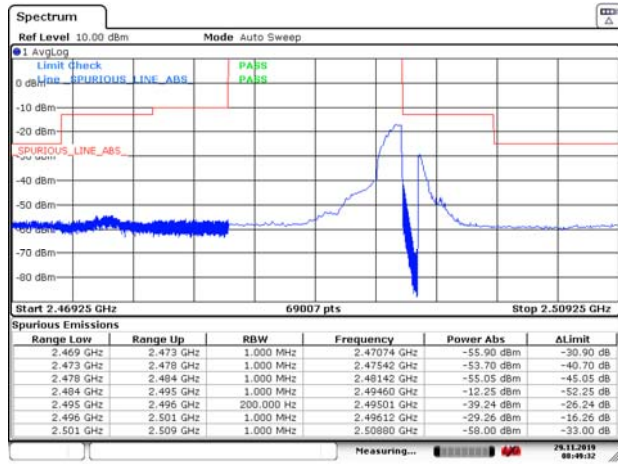

Date: 29 NOV 2019 08:49:32

LTE Band 53 3MHz 64QAM 100%RB CH-Low

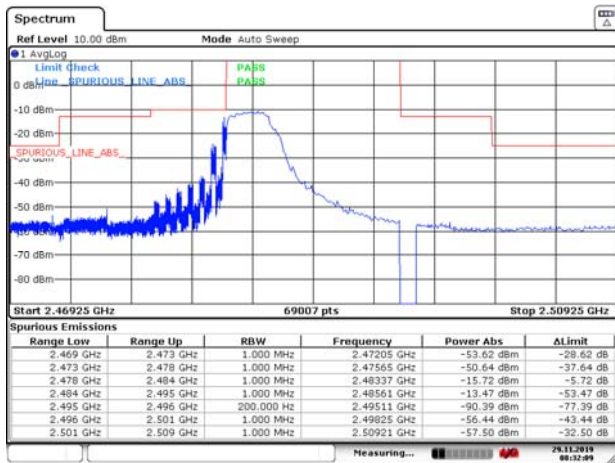

Date: 29 NOV 2019 08:32:09

LTE Band 53 3MHz 64QAM 100%RB CH-High

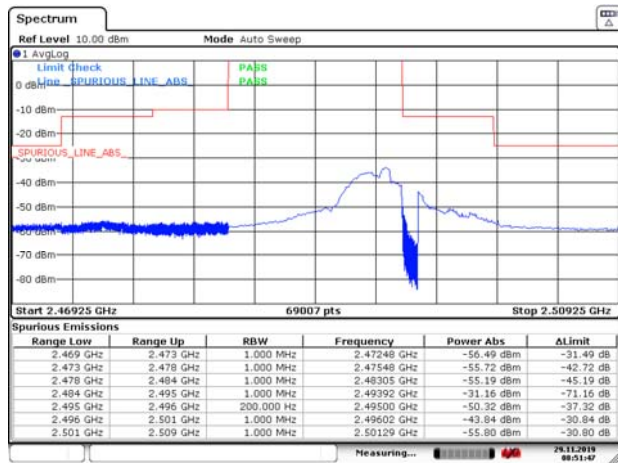

Date: 29 NOV 2019 08:51:47

LTE Band 53 5MHz 64QAM 1RB CH-Low

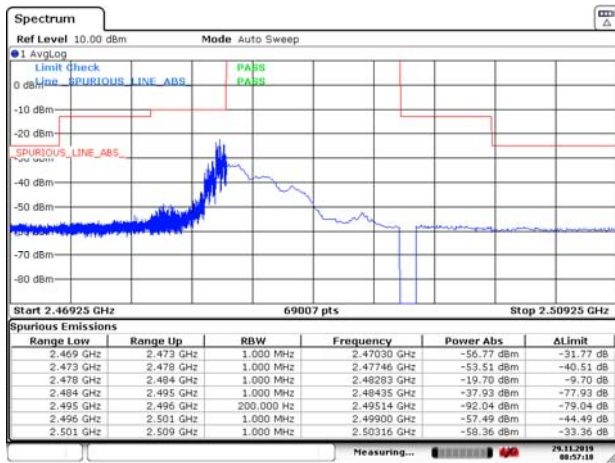

Date: 29 NOV 2019 08:57:18

LTE Band 53 5MHz 64QAM 1RB CH-High

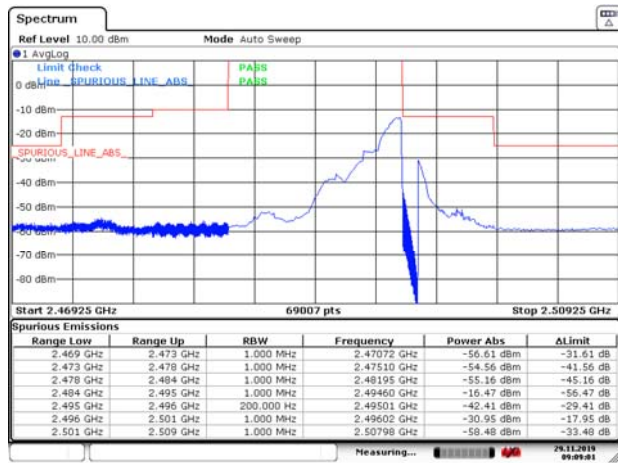

Date: 29 NOV 2019 09:09:00



LTE Band 53 5MHz 64QAM 100%RB CH-Low

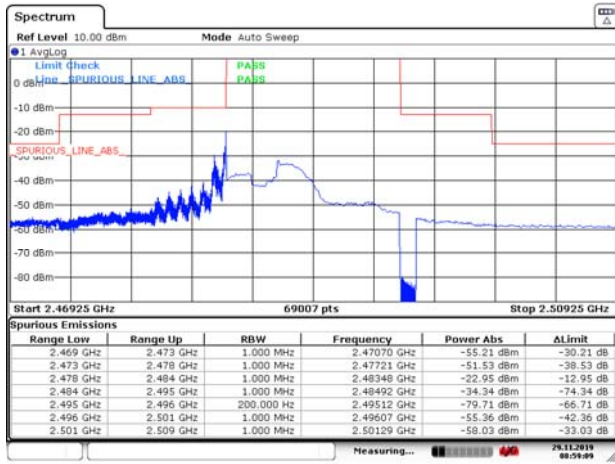

Date: 29 NOV 2019 08:58:10

LTE Band 53 5MHz 64QAM 100%RB CH-High

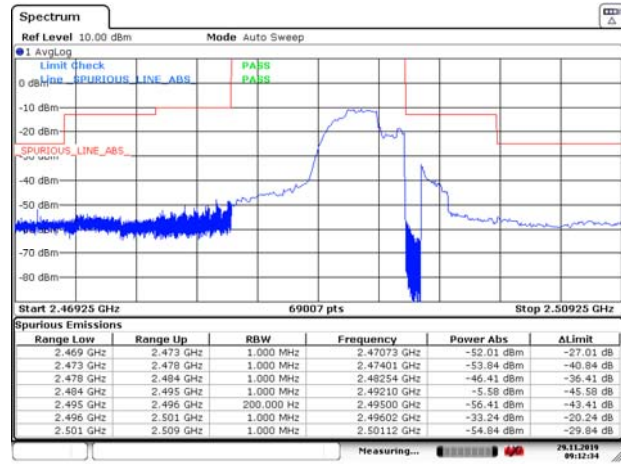

Date: 29 NOV 2019 09:12:35

LTE Band 53 10MHz 64QAM 1RB CH-Low

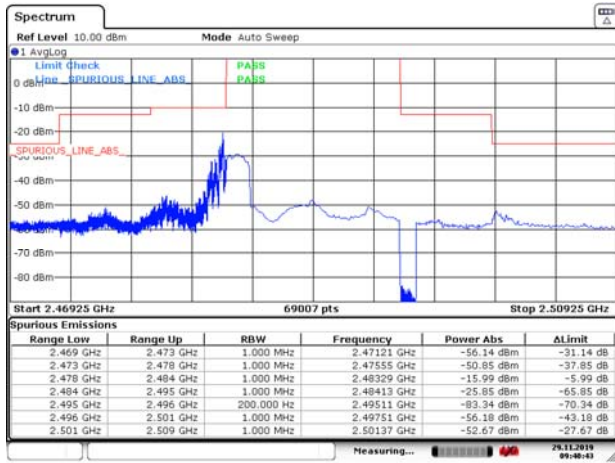

Date: 29 NOV 2019 09:40:43

LTE Band 53 10MHz 64QAM 1RB CH-High

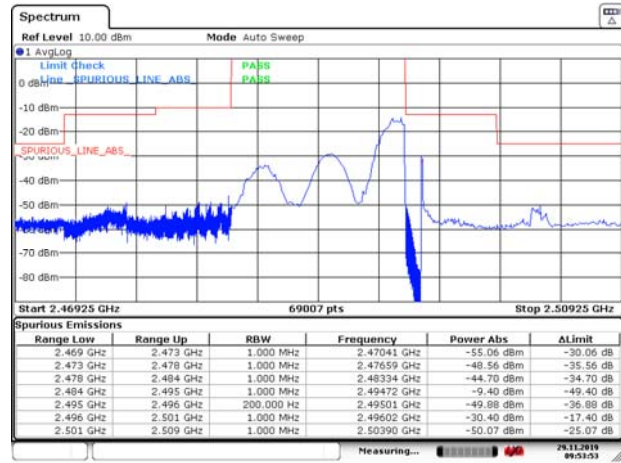

Date: 29 NOV 2019 09:53:53

LTE Band 53 10MHz 64QAM 100%RB CH-Low

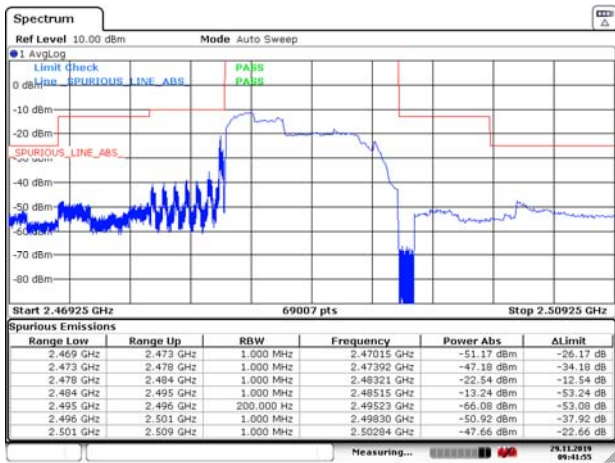

Date: 29 NOV 2019 09:41:55

LTE Band 53 10MHz 64QAM 100%RB CH-High

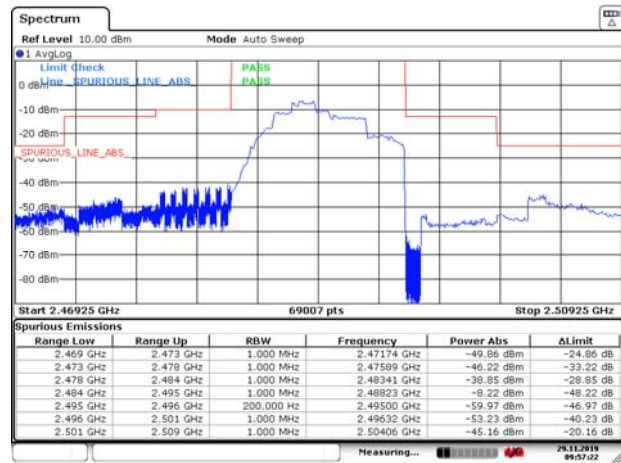

Date: 29 NOV 2019 09:57:21

5.5. Peak-to-Average Power Ratio (PAPR)

Ambient condition

Temperature	Relative humidity	Pressure
23°C ~25°C	45%~50%	101.5kPa

Methods of Measurement

Measure the total peak power and record as PPk. And measure the total average power and record as PAvg. Both the peak and average power levels must be expressed in the same logarithmic units (e.g., dBm). Determine the PAPR from:

$$PAPR (dB) = PPk (dBm) - PAvg (dBm).$$

Test Setup

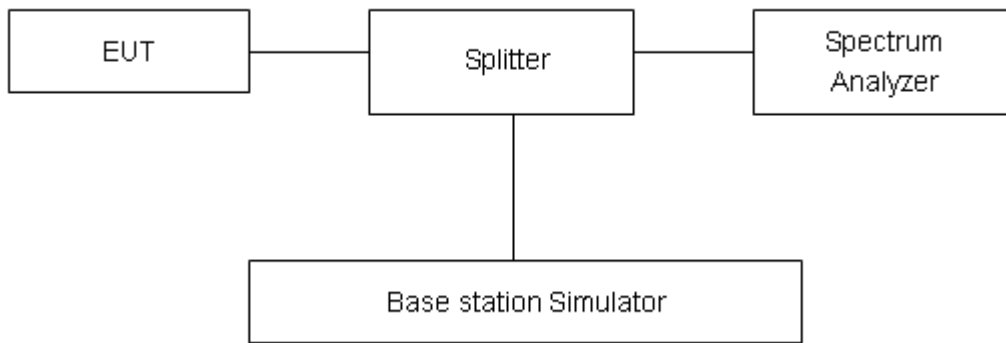

Limits

In measuring transmissions in this band using an average power technique, the peak to-average ratio (PAR) of the transmission may not exceed 13 dB.

Measurement Uncertainty

The assessed measurement uncertainty to ensure 95% confidence level for the normal distribution is with the coverage factor $k = 2$, $U = 0.4$ dB.



Test Results

LTE Band 53								
Modulation	Bandwidth (MHz)	Channel	Frequency (MHz)	Peak (dBm)	Avg (dBm)	PAPR (dB)	Limit (dB)	Conclusion
QPSK	1.4	60147	2484.2	25.99	16.82	9.17	≤13	PASS
		60197	2489.2	26.09	16.36	9.73	≤13	PASS
		60248	2494.3	25.54	16.17	9.37	≤13	PASS
	3	60155	2485	25.65	16.29	9.36	≤13	PASS
		60197	2489.2	25.85	16.43	9.42	≤13	PASS
		60240	2493.5	25.71	16.25	9.46	≤13	PASS
	5	60165	2486	25.30	16.18	9.12	≤13	PASS
		60197	2489.2	25.49	16.23	9.26	≤13	PASS
		60230	2492.5	25.38	16.16	9.22	≤13	PASS
	10	60190	2488.5	25.56	16.78	8.78	≤13	PASS
		60197	2489.2	25.47	16.44	9.03	≤13	PASS
		60205	2490	25.35	16.23	9.12	≤13	PASS
16QAM	1.4	60147	2484.2	26.51	16.64	9.87	≤13	PASS
		60197	2489.2	26.74	17.19	9.55	≤13	PASS
		60248	2494.3	26.06	16.00	10.06	≤13	PASS
	3	60155	2485	26.48	16.39	10.09	≤13	PASS
		60197	2489.2	26.74	16.95	9.79	≤13	PASS
		60240	2493.5	26.56	16.61	9.95	≤13	PASS
	5	60165	2486	25.80	16.01	9.79	≤13	PASS
		60197	2489.2	26.07	16.40	9.67	≤13	PASS
		60230	2492.5	25.92	16.06	9.86	≤13	PASS
	10	60190	2488.5	26.15	16.29	9.86	≤13	PASS
		60197	2489.2	26.16	16.61	9.55	≤13	PASS
		60205	2490	26.11	16.19	9.92	≤13	PASS
64QAM	1.4	60147	2484.2	26.59	16.91	9.68	≤13	PASS
		60197	2489.2	26.79	16.99	9.80	≤13	PASS
		60248	2494.3	26.12	16.11	10.01	≤13	PASS
	3	60155	2485	26.33	16.27	10.06	≤13	PASS
		60197	2489.2	26.61	16.82	9.79	≤13	PASS
		60240	2493.5	26.44	16.43	10.01	≤13	PASS
	5	60165	2486	25.92	16.07	9.85	≤13	PASS
		60197	2489.2	26.16	16.30	9.86	≤13	PASS
		60230	2492.5	26.11	16.37	9.74	≤13	PASS
	10	60190	2488.5	26.32	16.28	10.04	≤13	PASS
		60197	2489.2	26.29	16.51	9.78	≤13	PASS
		60205	2490	26.30	16.63	9.67	≤13	PASS

5.6. Frequency Stability

Ambient condition

Temperature	Relative humidity	Pressure
23°C ~25°C	45%~50%	101.5kPa

Method of Measurement

Frequency Stability (Temperature Variation)

The temperature inside the climate chamber is varied from -40°C to +70°C in 10°C step size,

(1) With all power removed, the temperature was decreased to 0°C and permitted to stabilize for three hours.

(2) Measure the carrier frequency with the test equipment in a “call mode”. These measurements should be made within 1 minute of powering up the mobile station, to prevent significant self warming.

(3) Repeat the above measurements at 10°C increments from -40°C to +70°C. Allow at least 1.5 hours at each temperature, un-powered, before making measurements.

Frequency Stability (Voltage Variation)

The frequency stability shall be measured with variation of primary supply voltage as follows:

(1) Vary primary supply voltage from 85 to 115 percent of the nominal value for other than hand carried battery equipment.

(2) For hand carried, battery powered equipment, reduce primary supply voltage to the battery-operating end point which shall be specified by the manufacturer.

This transceiver is specified to operate with an input voltage of between 3 V and 3.6V, with a nominal voltage of 3.3V.

Test setup

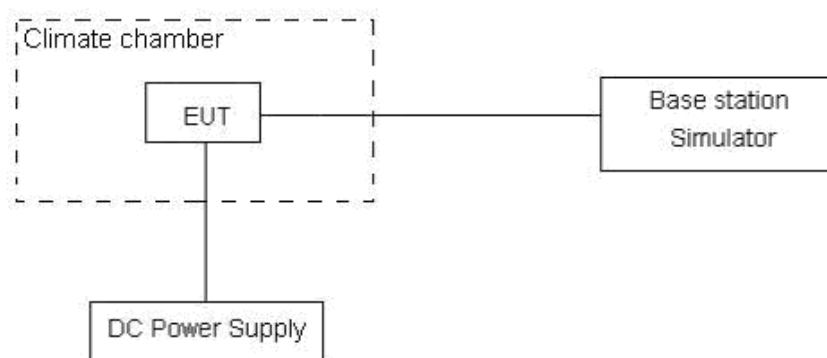

Limits

The frequency stability shall be sufficient to ensure that the fundamental emission stays within the authorized frequency block

Measurement Uncertainty

The assessed measurement uncertainty to ensure 99.75% confidence level for the normal distribution is with the coverage factor $k = 3$, $U = 0.01\text{ppm}$.



Test Result

LTE Band 53								
Condition		Freq.Error (Hz)	Freq.Error (Hz)	Freq.Error (Hz)	Frequency Stability (ppm)	Frequency Stability (ppm)	Frequency Stability (ppm)	Verdict
BANDWIDTH	1.4MHz							
Temperature	Voltage	64QAM	16QAM	QPSK	64QAM	16QAM	QPSK	
Normal (25°C)	Normal	1.36	11.61	11.49	0.00072	0.00618	0.00611	PASS
Extreme (55°C)		10.66	6.09	14.23	0.00567	0.00324	0.00757	PASS
Extreme (70°C)		15.56	4.52	3.20	0.00828	0.00241	0.00170	PASS
Extreme (60°C)		11.41	4.74	8.33	0.00607	0.00252	0.00443	PASS
Extreme (50°C)		11.17	3.61	10.22	0.00594	0.00192	0.00544	PASS
Extreme (40°C)		12.09	15.63	17.49	0.00643	0.00831	0.00930	PASS
Extreme (30°C)		11.75	8.13	12.37	0.00625	0.00433	0.00658	PASS
Extreme (20°C)		7.98	1.87	16.27	0.00425	0.00099	0.00866	PASS
Extreme (10°C)		6.15	2.98	10.30	0.00327	0.00159	0.00548	PASS
Extreme (0°C)		8.07	13.90	2.09	0.00429	0.00739	0.00111	PASS
Extreme (-10°C)		13.79	3.38	5.83	0.00733	0.00180	0.00310	PASS
Extreme (-20°C)		10.04	17.57	15.28	0.00534	0.00935	0.00813	PASS
Extreme (-30°C)		4.40	17.07	6.67	0.00234	0.00908	0.00355	PASS
Extreme (-40°C)		2.75	13.17	13.24	0.00147	0.00701	0.00704	PASS
25°C	LV	13.15	10.39	7.74	0.00699	0.00553	0.00411	PASS
	HV	11.51	9.55	14.50	0.00612	0.00508	0.00771	PASS

LTE Band 53								
Condition		Freq.Error (Hz)	Freq.Error (Hz)	Freq.Error (Hz)	Frequency Stability (ppm)	Frequency Stability (ppm)	Frequency Stability (ppm)	Verdict
BANDWIDTH	3MHz							
Temperature	Voltage	64QAM	16QAM	QPSK	64QAM	16QAM	QPSK	
Normal (25°C)	Normal	2.81	7.20	6.65	0.00150	0.00383	0.00354	PASS
Extreme (55°C)		4.41	1.69	1.60	0.00234	0.00090	0.00085	PASS
Extreme (70°C)		2.12	4.64	6.82	0.00113	0.00247	0.00363	PASS
Extreme (60°C)		17.95	16.46	8.48	0.00955	0.00875	0.00451	PASS
Extreme (50°C)		13.73	14.50	15.17	0.00730	0.00772	0.00807	PASS
Extreme (40°C)		8.67	1.50	12.34	0.00461	0.00080	0.00656	PASS
Extreme (30°C)		2.67	14.00	12.55	0.00142	0.00745	0.00668	PASS
Extreme (20°C)		10.57	13.44	5.44	0.00562	0.00715	0.00289	PASS
Extreme (10°C)		10.57	12.90	3.98	0.00562	0.00686	0.00212	PASS
Extreme (0°C)		5.37	4.23	9.50	0.00285	0.00225	0.00506	PASS



Extreme (-10°C)		11.44	5.32	9.28	0.00608	0.00283	0.00494	PASS
Extreme (-20°C)		17.19	16.12	14.20	0.00914	0.00858	0.00755	PASS
Extreme (-30°C)		7.15	7.97	4.74	0.00381	0.00424	0.00252	PASS
Extreme (-40°C)		3.83	14.56	17.57	0.00204	0.00774	0.00934	PASS
25°C	LV	16.71	5.57	10.16	0.00889	0.00296	0.00540	PASS
	HV	11.06	14.28	15.96	0.00588	0.00760	0.00849	PASS

LTE Band 53								
Condition		Freq.Error (Hz)	Freq.Error (Hz)	Freq.Error (Hz)	Frequency Stability (ppm)	Frequency Stability (ppm)	Frequency Stability (ppm)	Verdict
BANDWIDTH	5MHz							
Temperature	Voltage	64QAM	16QAM	QPSK	64QAM	16QAM	QPSK	
Normal (25°C)	Normal	11.94	12.10	1.34	0.00635	0.00644	0.00071	PASS
Extreme (55°C)		2.39	10.53	7.82	0.00127	0.00560	0.00416	PASS
Extreme (70°C)		4.38	11.57	6.41	0.00233	0.00616	0.00341	PASS
Extreme (60°C)		16.05	13.38	17.22	0.00854	0.00712	0.00916	PASS
Extreme (50°C)		1.46	12.40	10.85	0.00078	0.00659	0.00577	PASS
Extreme (40°C)		2.12	9.73	2.07	0.00113	0.00518	0.00110	PASS
Extreme (30°C)		4.01	14.03	12.61	0.00213	0.00746	0.00671	PASS
Extreme (20°C)		14.12	5.54	16.36	0.00751	0.00295	0.00870	PASS
Extreme (10°C)		17.62	8.80	2.02	0.00937	0.00468	0.00108	PASS
Extreme (0°C)		9.12	3.97	6.44	0.00485	0.00211	0.00343	PASS
Extreme (-10°C)		7.07	15.14	12.14	0.00376	0.00805	0.00646	PASS
Extreme (-20°C)		17.25	15.18	3.62	0.00918	0.00807	0.00192	PASS
Extreme (-30°C)		10.25	6.91	12.26	0.00545	0.00368	0.00652	PASS
Extreme (-40°C)		3.74	12.54	9.31	0.00199	0.00667	0.00495	PASS
25°C	LV	14.97	2.94	2.77	0.00796	0.00156	0.00147	PASS
	HV	13.20	16.62	2.38	0.00702	0.00884	0.00127	PASS



LTE Band 53								
Condition		Freq.Error (Hz)	Freq.Error (Hz)	Freq.Error (Hz)	Frequency Stability (ppm)	Frequency Stability (ppm)	Frequency Stability (ppm)	Verdict
BANDWIDTH	10MHz							
Temperature	Voltage	64QAM	16QAM	QPSK	64QAM	16QAM	QPSK	
Normal (25°C)	Normal	9.49	8.11	17.57	0.00505	0.00431	0.00934	PASS
Extreme (55°C)		11.67	11.11	11.51	0.00621	0.00591	0.00612	PASS
Extreme (70°C)		5.70	10.31	15.00	0.00303	0.00548	0.00798	PASS
Extreme (60°C)		10.36	17.61	8.71	0.00551	0.00937	0.00464	PASS
Extreme (50°C)		5.50	17.99	16.33	0.00293	0.00957	0.00868	PASS
Extreme (40°C)		4.38	7.37	2.72	0.00233	0.00392	0.00145	PASS
Extreme (30°C)		9.90	5.10	15.99	0.00527	0.00272	0.00850	PASS
Extreme (20°C)		4.87	10.95	1.52	0.00259	0.00583	0.00081	PASS
Extreme (10°C)		8.78	5.56	7.88	0.00467	0.00296	0.00419	PASS
Extreme (0°C)		1.59	11.37	4.10	0.00084	0.00605	0.00218	PASS
Extreme (-10°C)		12.41	17.54	10.14	0.00660	0.00933	0.00539	PASS
Extreme (-20°C)		14.57	8.05	16.28	0.00775	0.00428	0.00866	PASS
Extreme (-30°C)		11.34	7.09	2.10	0.00603	0.00377	0.00112	PASS
Extreme (-40°C)		12.89	7.16	2.00	0.00686	0.00381	0.00106	PASS
25°C	LV	14.65	17.89	8.97	0.00779	0.00951	0.00477	PASS
	HV	5.42	16.49	1.53	0.00288	0.00877	0.00082	PASS

5.7. Spurious Emissions at Antenna Terminals

Ambient condition

Temperature	Relative humidity	Pressure
23°C ~25°C	45%~50%	101.5kPa

Method of Measurement

The EUT was connected to Spectrum Analyzer and Base Station Simulator via power Splitter. The measurement is carried out using a spectrum analyzer. The spectrum analyzer scans from 9kHz to the 10th harmonic of the carrier. The peak detector is used.

RBW is set to 100kHz, VBW is set to 300kHz for 30MHz~1GHz

RBW is set to 1MHz, VBW is set to 3MHz for above 1GHz, Sweep is set to ATUO.

The modulation mode and RB allocation refer to section 5.1, using the maximum output power configuration.

Test setup

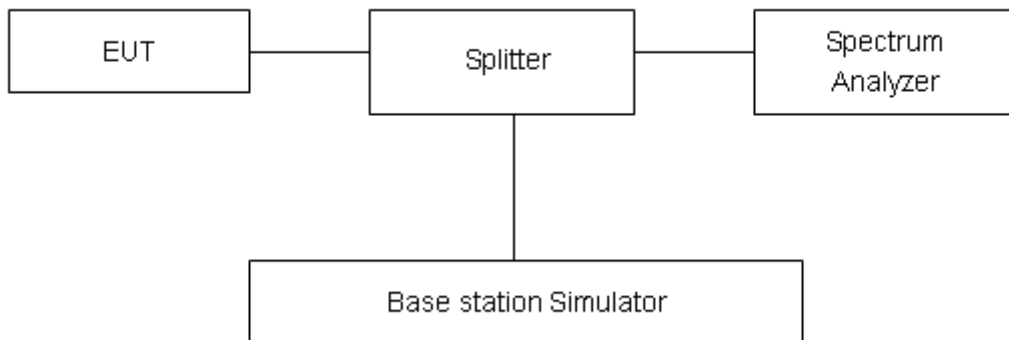

Limits

On any frequency outside a licensee's frequency block, the power of any emission shall be attenuated below the transmitter power (P) by at least $43 + 10 \log_{10} (P)$ dB.”

Limit	-13 dBm
-------	---------

Measurement Uncertainty

The assessed measurement uncertainty to ensure 99.75% confidence level for the normal distribution is with the coverage factor $k = 1.96$.

Frequency	Uncertainty
9kHz-1GHz	0.684 dB
1GHz-20GHz	1.407 dB



Test Result

Sweep the whole frequency band through the range from 9kHz to the 10th harmonic of the carrier, the emissions more than 20 dB below the limit are not reported.

The signal beyond the limit is carrier.

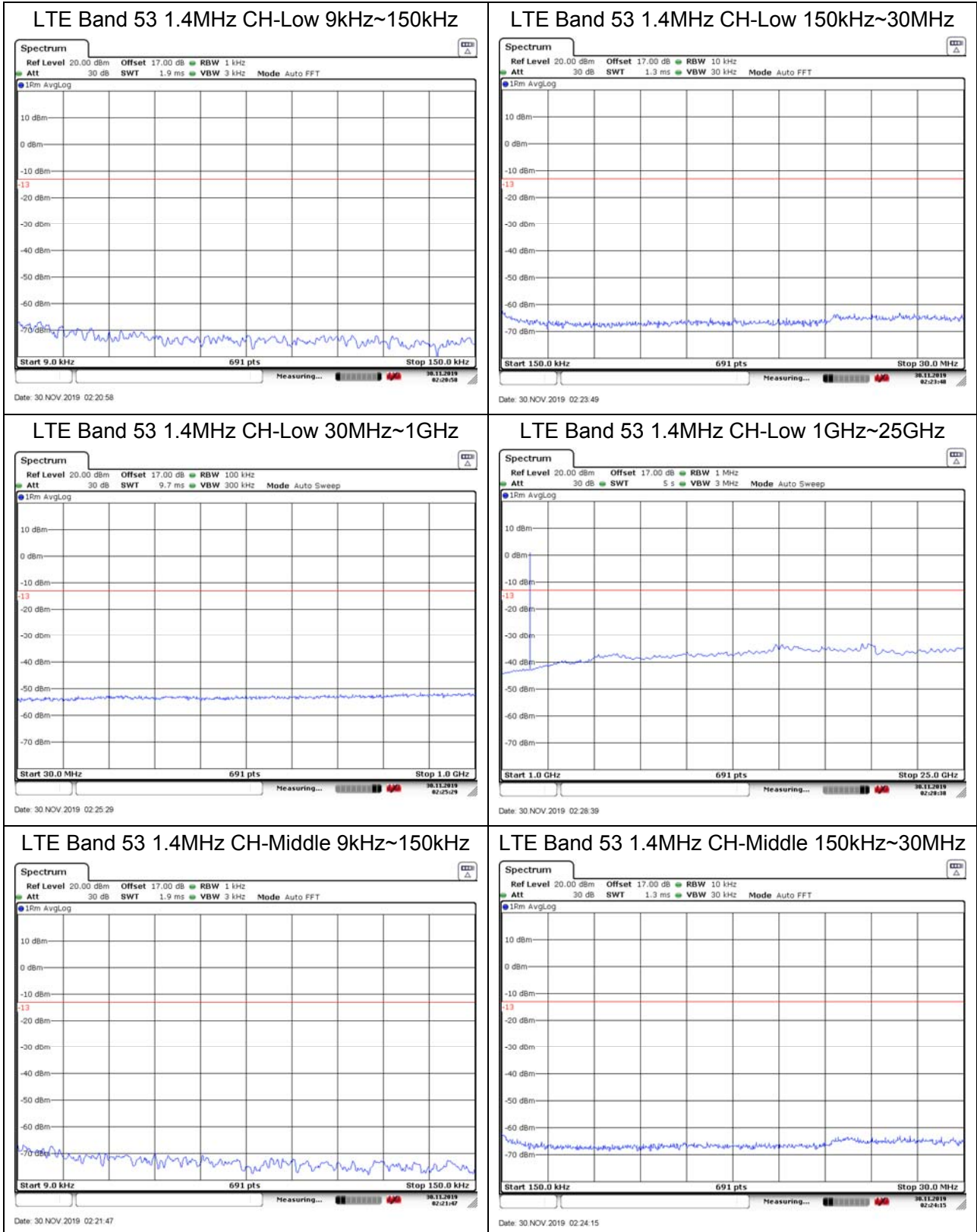

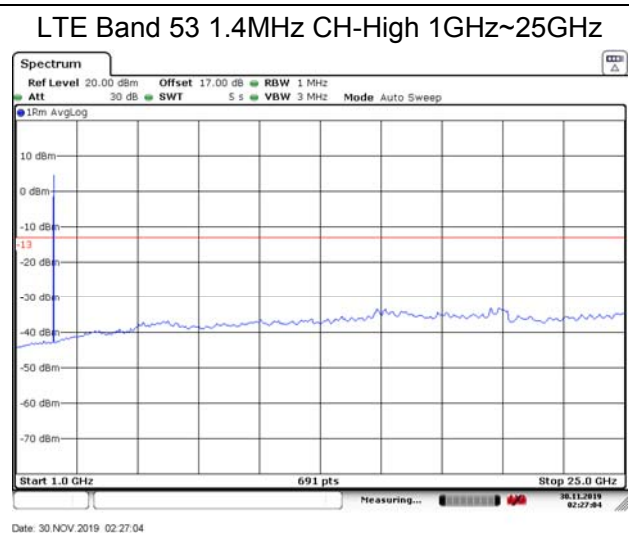
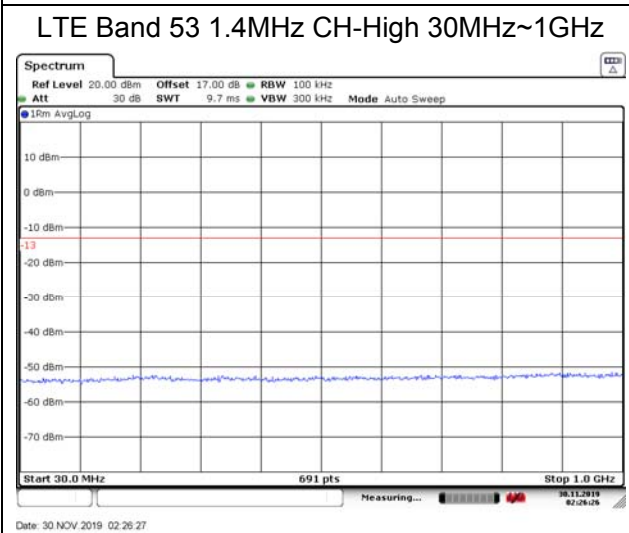
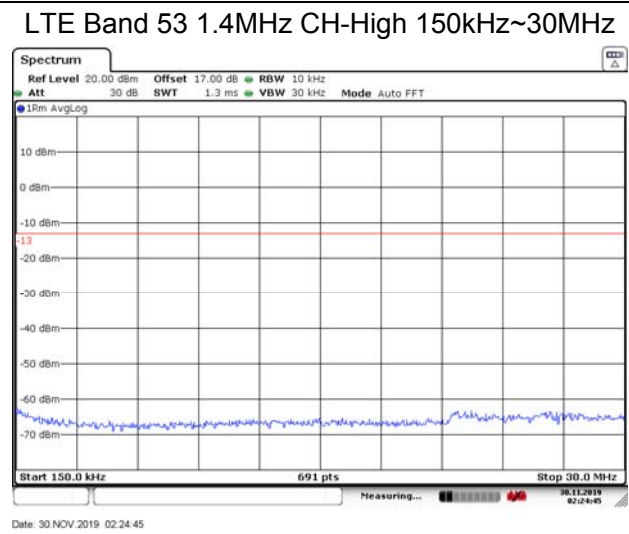
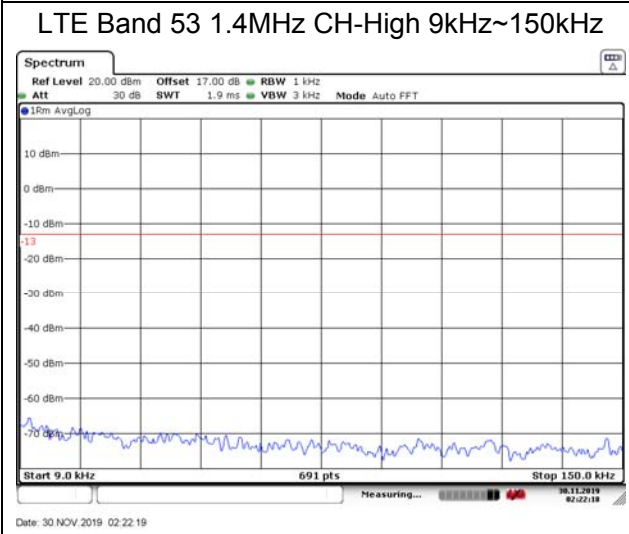
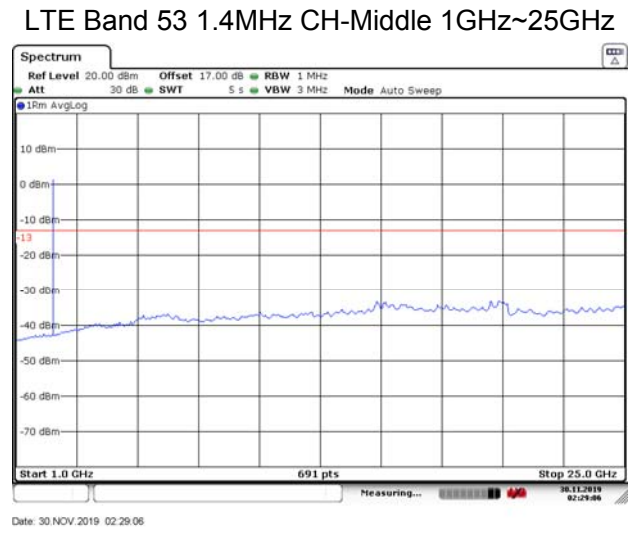
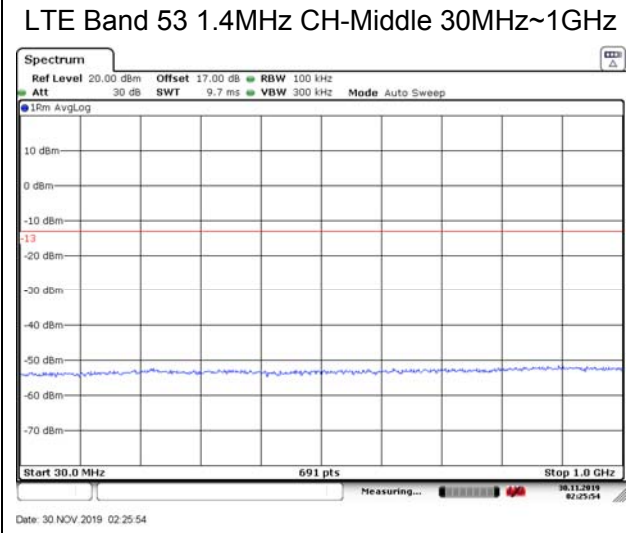

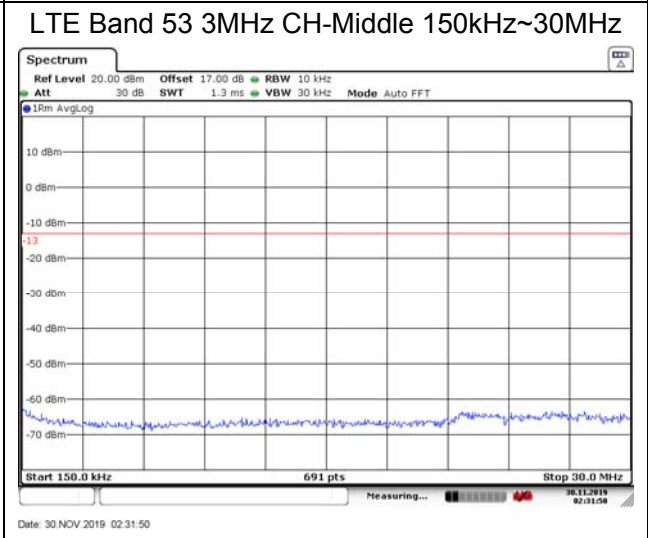
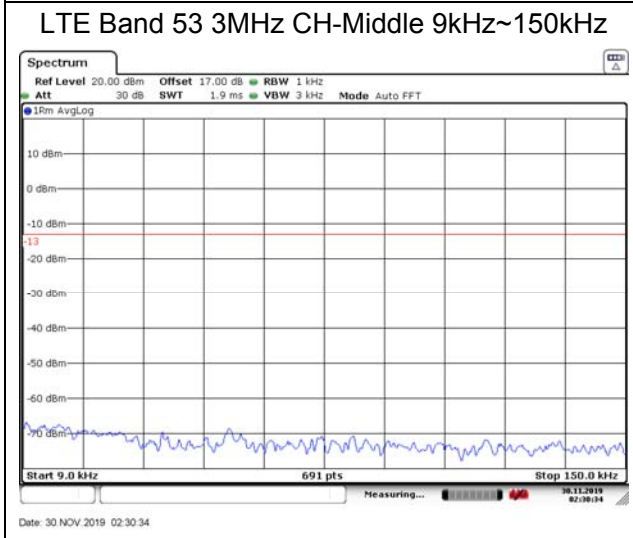
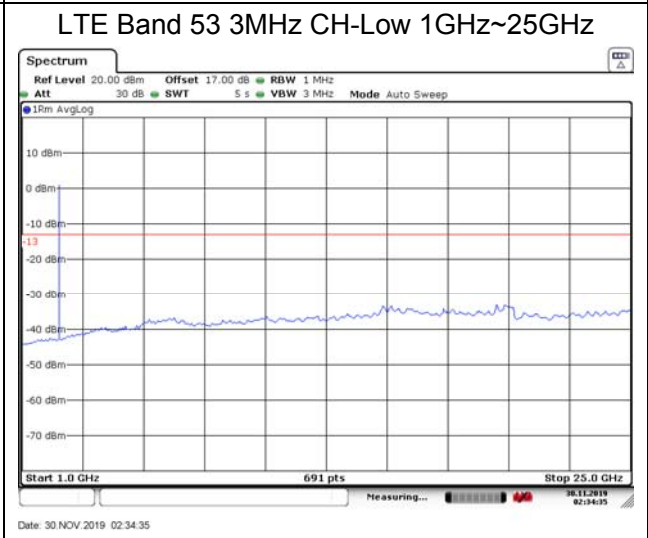
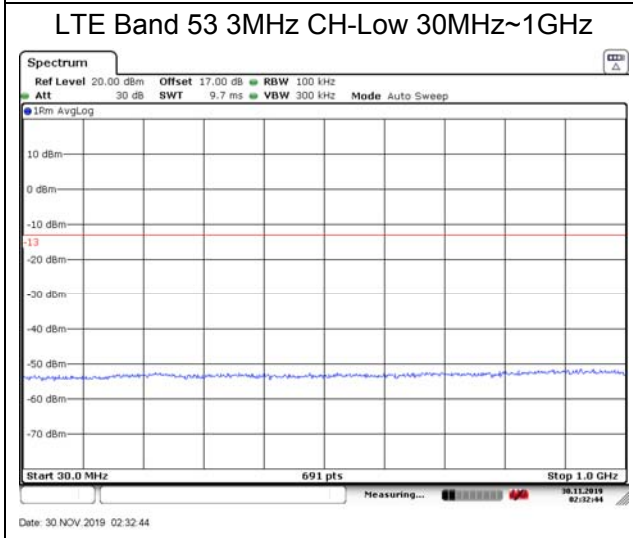
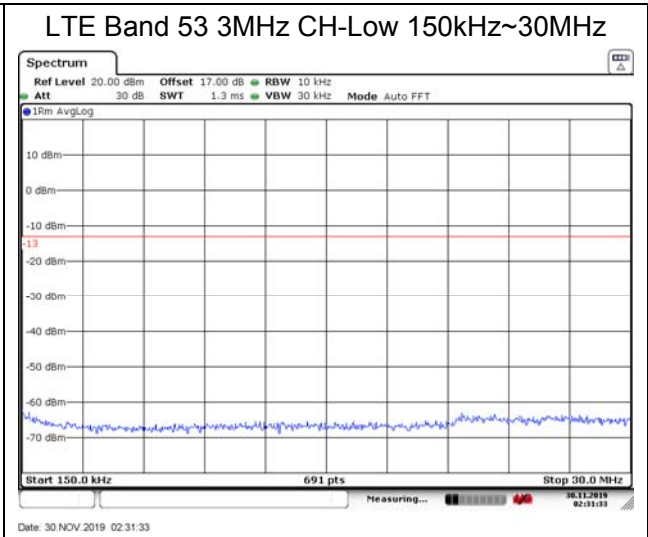
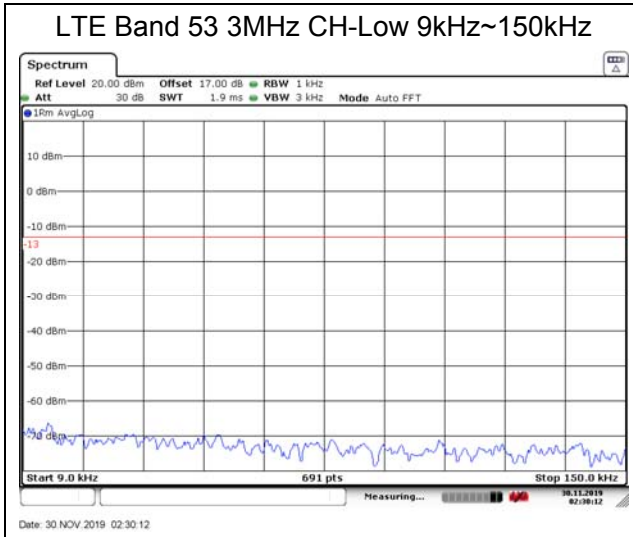



LTE Band 53 3MHz CH-Middle 30MHz~1GHz

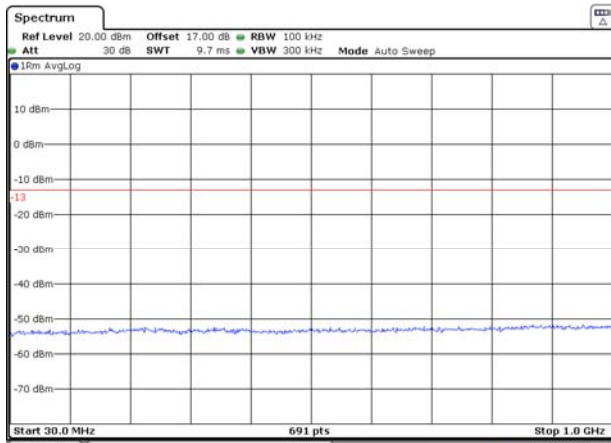

LTE Band 53 3MHz CH-Middle 1GHz~25GHz

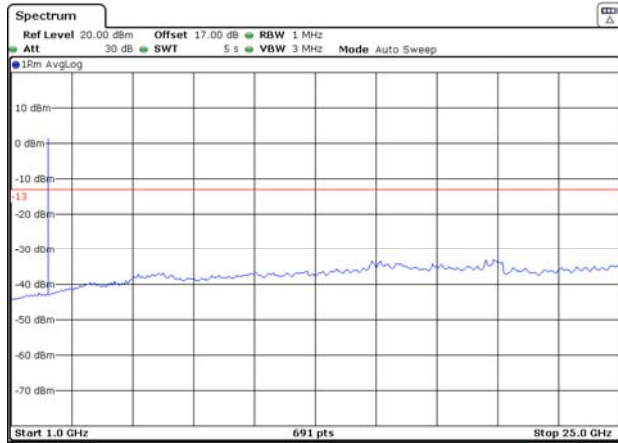

LTE Band 53 3MHz CH-High 9kHz~150kHz

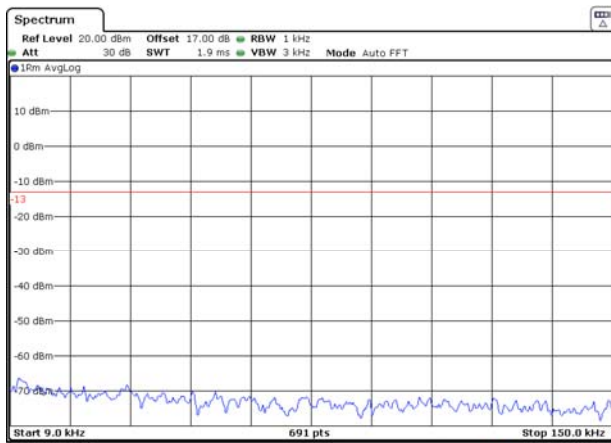

LTE Band 53 3MHz CH-High 150kHz~30MHz

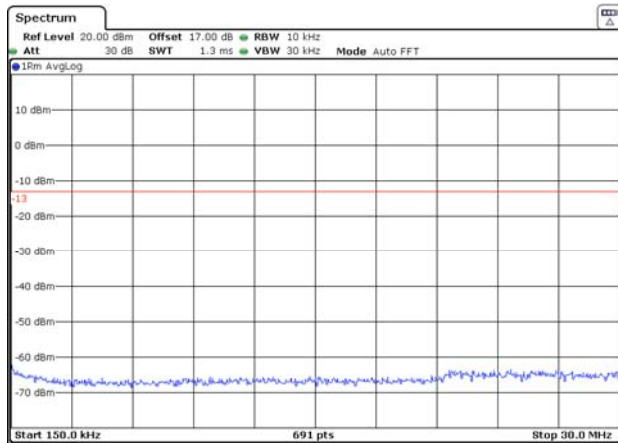

LTE Band 53 3MHz CH-High 30MHz~1GHz

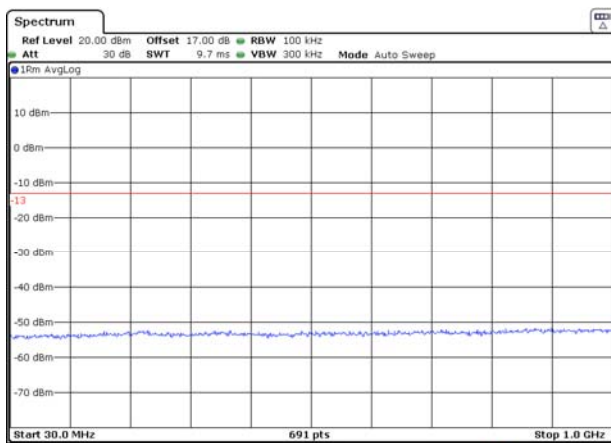

LTE Band 53 3MHz CH-High 1GHz~25GHz

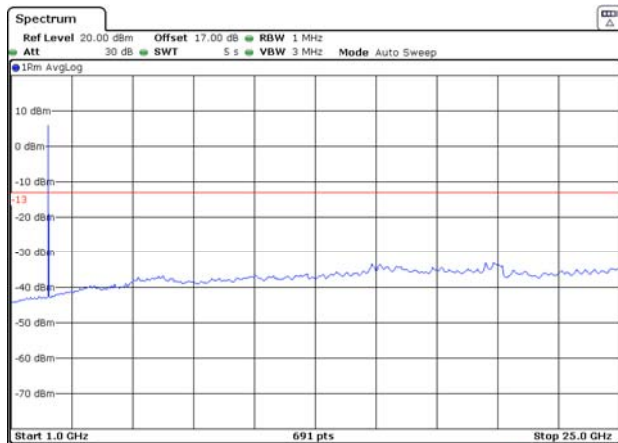



LTE Band 53 5MHz CH-Low 9kHz~150kHz

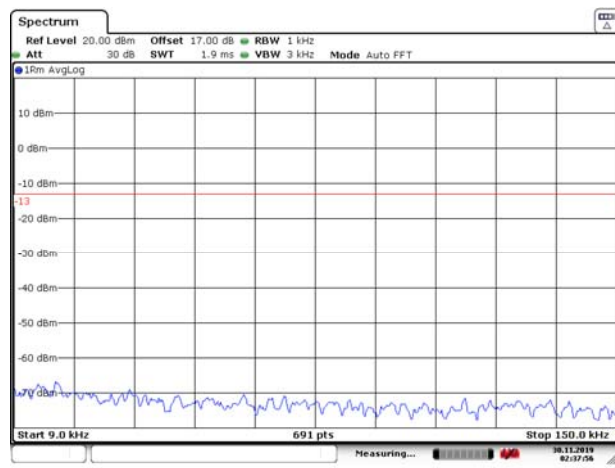

LTE Band 53 5MHz CH-Low 150kHz~30MHz

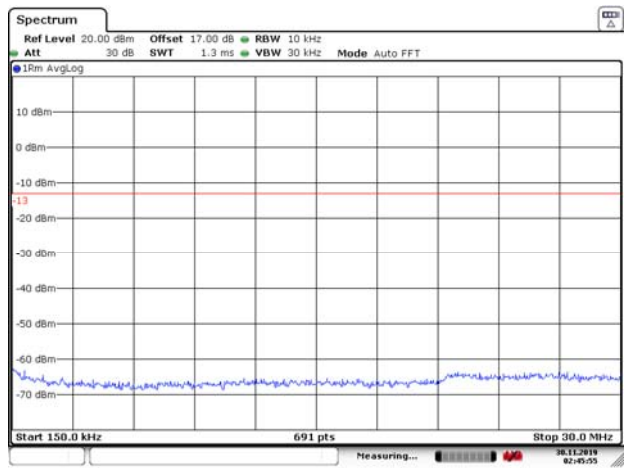

LTE Band 53 5MHz CH-Low 30MHz~1GHz

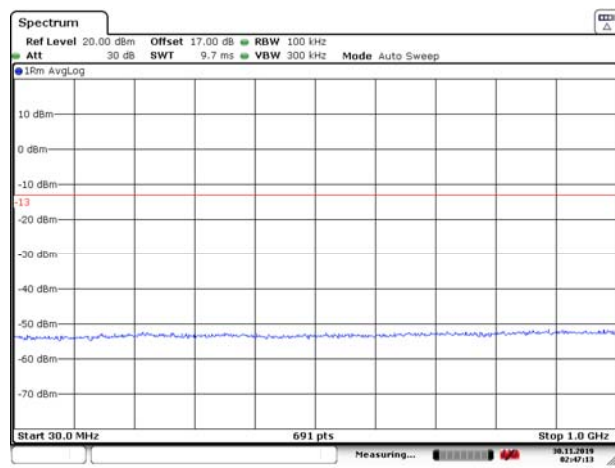

LTE Band 53 5MHz CH-Low 1GHz~25GHz

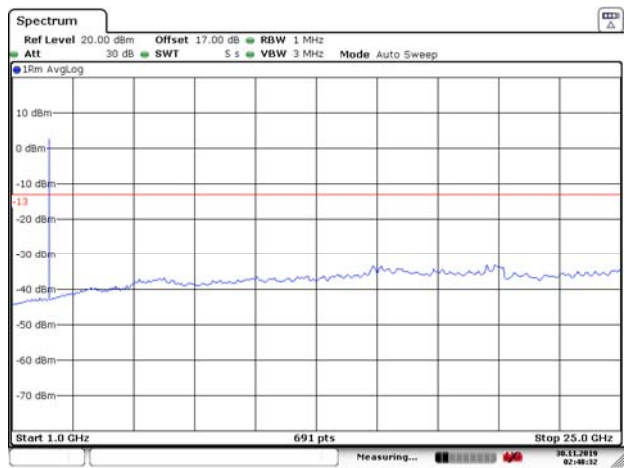

LTE Band 53 5MHz CH-Middle 9kHz~150kHz

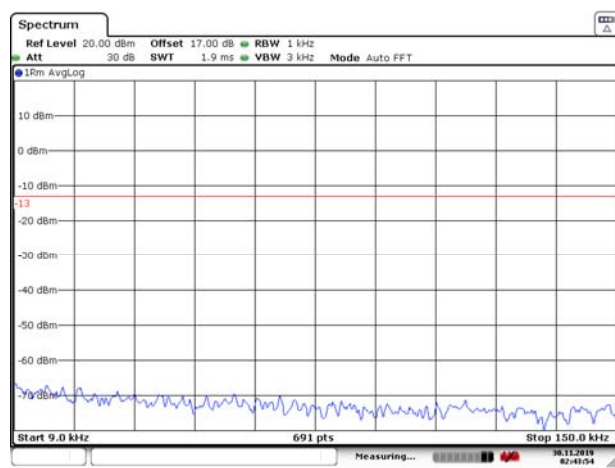

LTE Band 53 5MHz CH-Middle 150kHz~30MHz

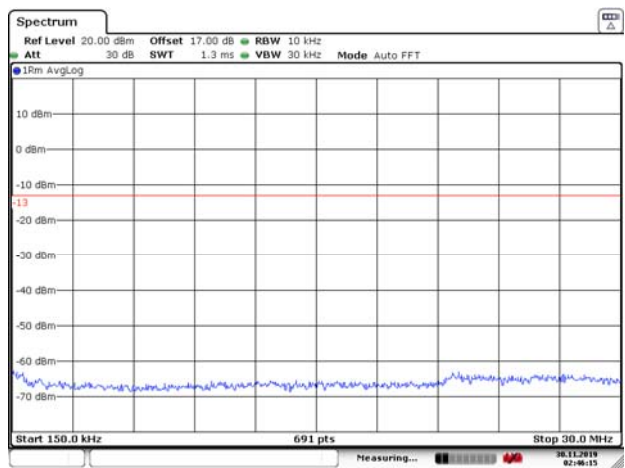



LTE Band 53 5MHz CH-Middle 30MHz~1GHz

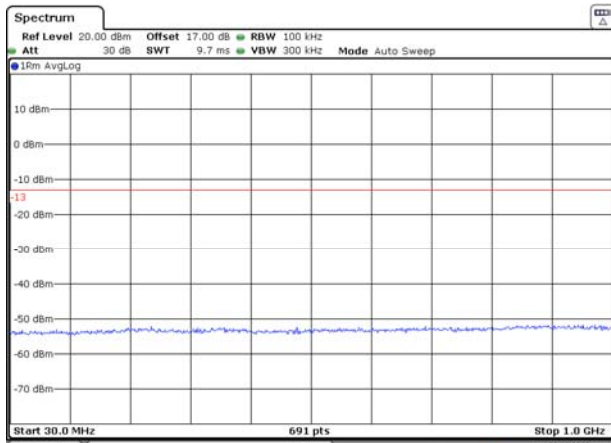

LTE Band 53 5MHz CH-Middle 1GHz~25GHz

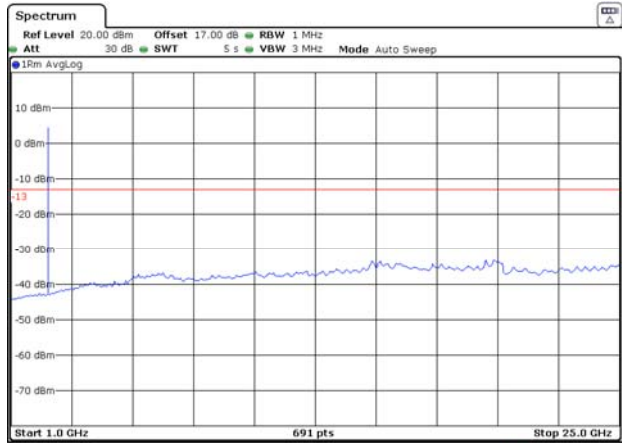

LTE Band 53 5MHz CH-High 9kHz~150kHz

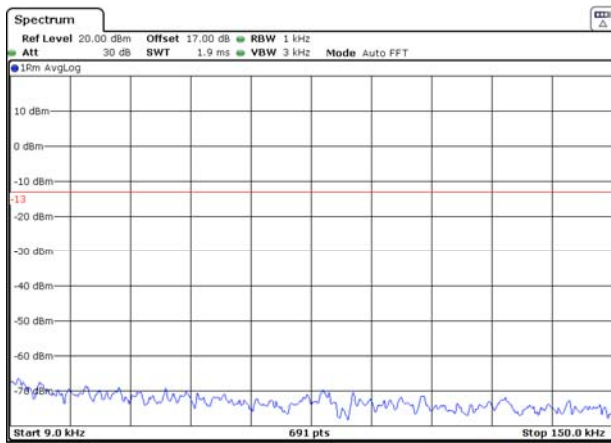

LTE Band 53 5MHz CH-High 150kHz~30MHz

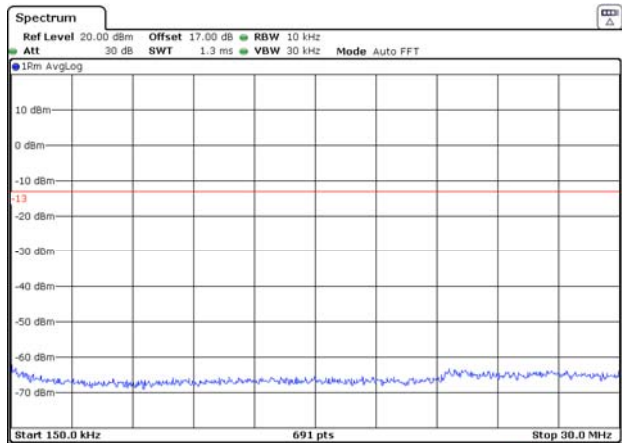

LTE Band 53 5MHz CH-High 30MHz~1GHz

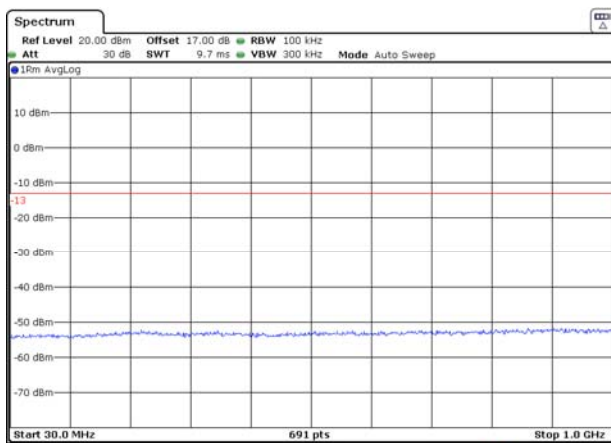

LTE Band 53 5MHz CH-High 1GHz~25GHz

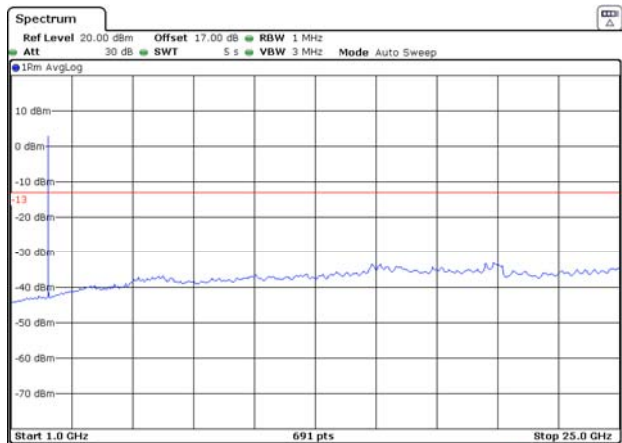



LTE Band 53 10MHz CH-Low 9kHz~150kHz

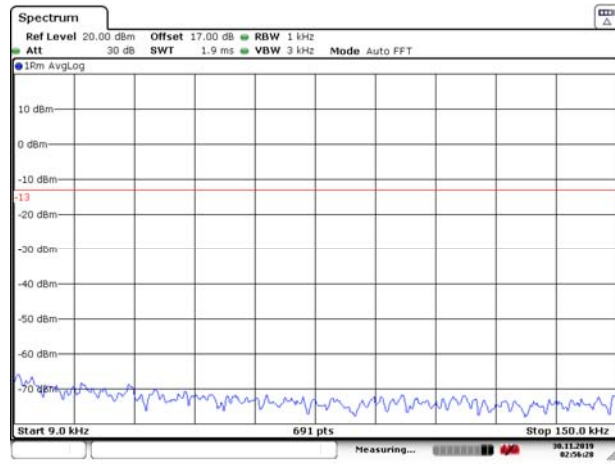

LTE Band 53 10MHz CH-Low 150kHz~30MHz

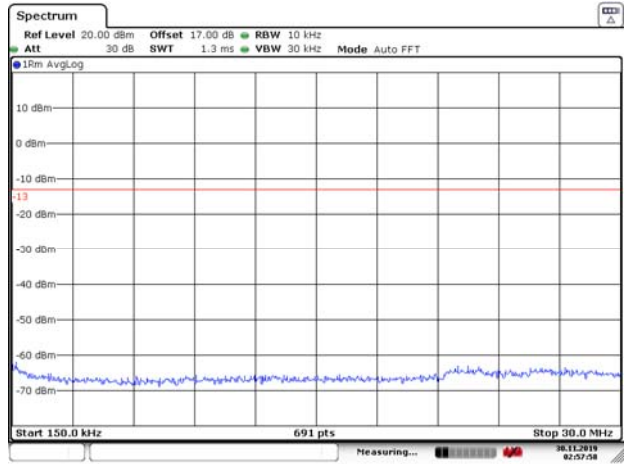

LTE Band 53 10MHz CH-Low 30MHz~1GHz

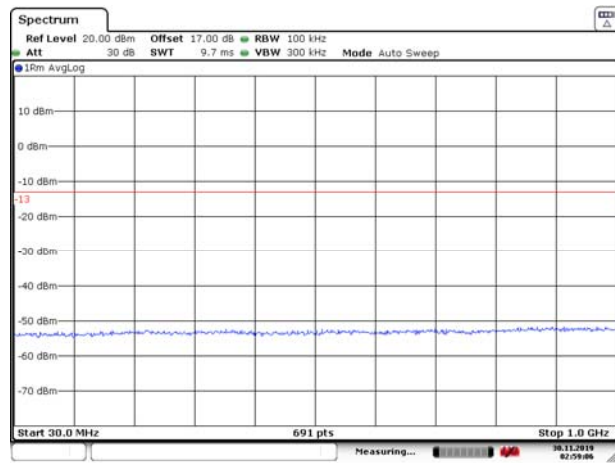

LTE Band 53 10MHz CH-Low 1GHz~25GHz

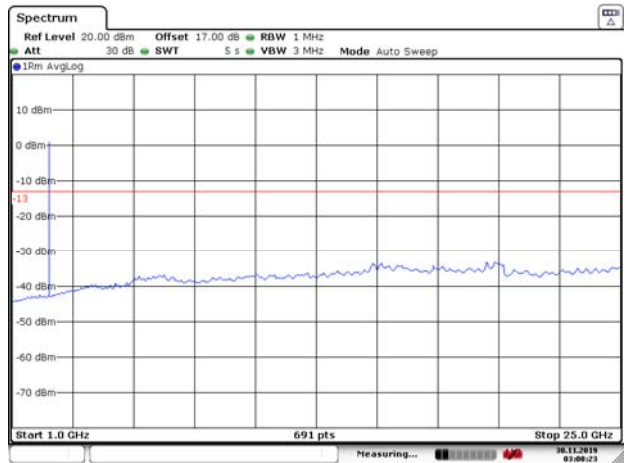

LTE Band 53 10MHz CH-Middle 9kHz~150kHz

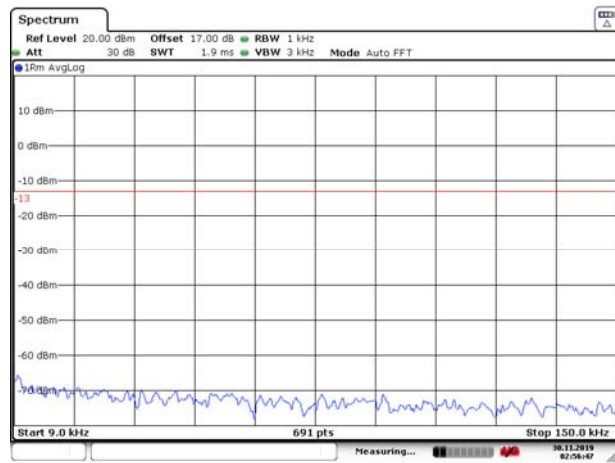

LTE Band 53 10MHz CH-Middle 150kHz~30MHz

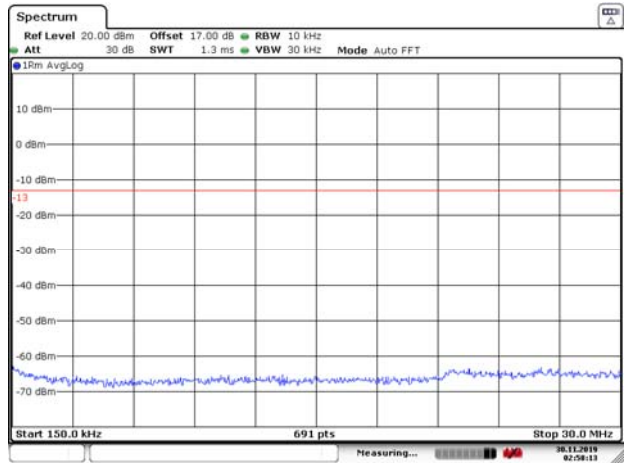



LTE Band 53 10MHz CH-Middle 30MHz~1GHz

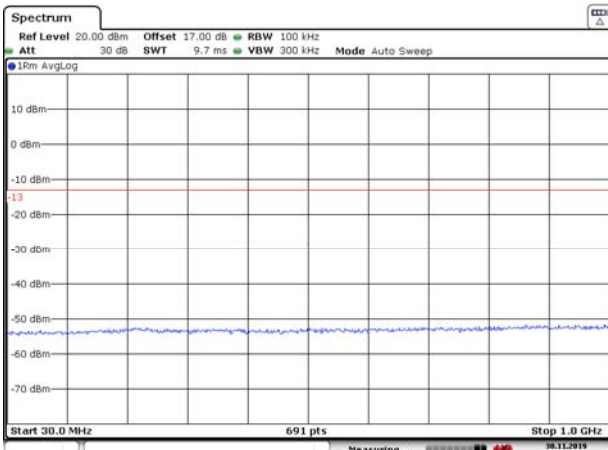

LTE Band 53 10MHz CH-Middle 1GHz~25GHz

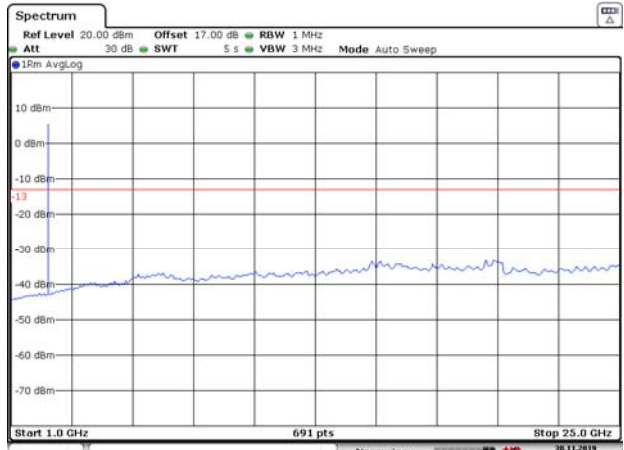

LTE Band 53 10MHz CH-High 9kHz~150kHz

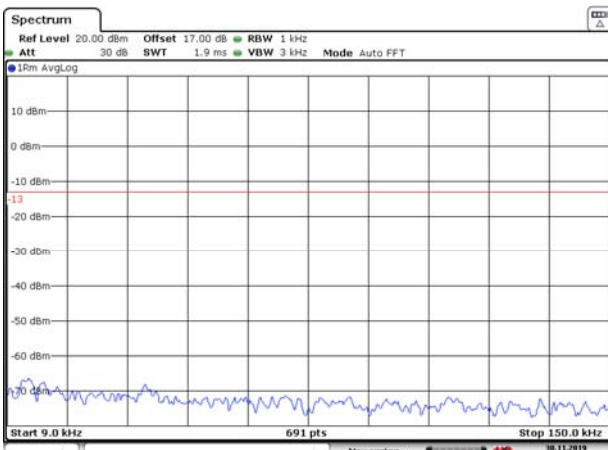

LTE Band 53 10MHz CH-High 150kHz~30MHz

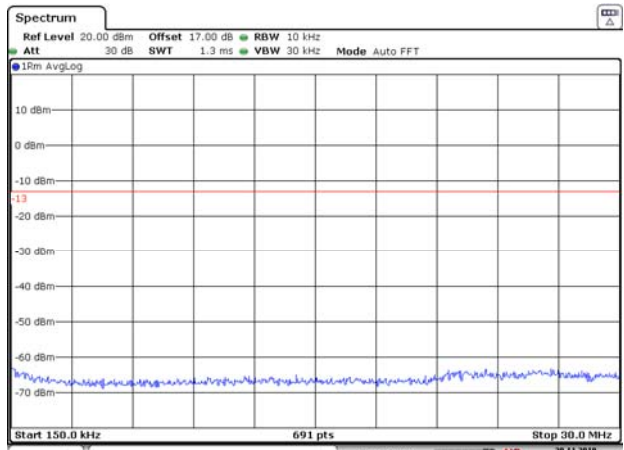

LTE Band 53 10MHz CH-High 30MHz~1GHz

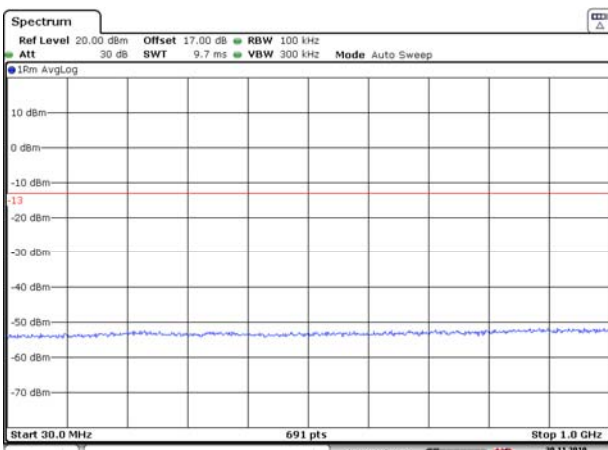

LTE Band 53 10MHz CH-High 1GHz~25GHz

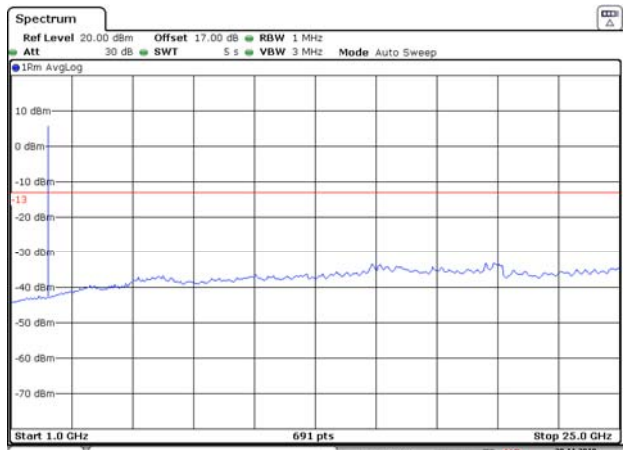

5.8. Radiates Spurious Emission

Ambient condition

Temperature	Relative humidity	Pressure
23°C ~25°C	45%~50%	101.5kPa

Method of Measurement

1. The testing follows FCC KDB 971168 v03r01 Section 5.8 and ANSI C63.26 (2015).
2. Below 1GHz: The EUT is placed on a turntable 0.8 meters above the ground in the chamber, 3 meter away from the antenna. The maximal emission value is acquired by adjusting the antenna height, polarisation and turntable azimuth. Normally, the height range of antenna is 1 m to 4 m, the azimuth range of turntable is 0° to 360°, and the receive antenna has two polarizations Vertical (V) and Horizontal (H). Above 1GHz: (Note: the FCC's permission to use 1.5m as an alternative per TCBC Conf call of Dec. 2, 2014.) The EUT is placed on a turntable 1.5 meters above the ground in the chamber, 3 meter away from the antenna. The maximal emission value is acquired by adjusting the antenna height, polarisation and turntable azimuth. Normally, the height range of antenna is 1 m to 4 m, the azimuth range of turntable is 0° to 360°, and the receive antenna has two polarizations Vertical (V) and Horizontal (H).
3. A loop antenna, A log-periodic antenna or horn antenna shall be substituted in place of the EUT. The log-periodic antenna will be driven by a signal generator and the level will be adjusted till the same power value on the spectrum analyzer or receiver. The level of the spurious emissions can be calculated through the level of the signal generator, cable loss, the gain of the substitution antenna and the reading of the spectrum analyzer or receiver.
4. The EUT is then put into continuously transmitting mode at its maximum power level during the test. Set Test Receiver or Spectrum RBW=200Hz,VBW=600Hz for 9kHz150kHz , RBW=10kHz, VBW=30kHz 150kHz-30MHz , RBW=100kHz,VBW=300kHz for 30MHz to 1GHz and RBW=1MHz, VBW=3MHz for above 1GHz, And the maximum value of the receiver should be recorded as (Pr).
5. The EUT shall be replaced by a substitution antenna. In the chamber, an substitution antenna for the frequency band of interest is placed at the reference point of the chamber. An RF Signal source for the frequency band of interest is connected to the substitution antenna with a cable that has been constructed to not interfere with the radiation pattern of the antenna. A power (PMea) is applied to the input of the substitution antenna, and adjust the level of the signal generator output until the value of the receiver reach the previously recorded (Pr). The power of signal source (PMea) is recorded. The test should be performed by rotating the test item and adjusting the receiving antenna polarization.
6. A amplifier should be connected to the Signal Source output port. And the cable should be connect between the Amplifier and the Substitution Antenna. The cable loss (Pcl) ,the Substitution Antenna Gain (Ga) and the Amplifier Gain (PAg) should be recorded after test.
7. The measurement results are obtained as described below:
$$\text{Power(EIRP)} = \text{PMea} - \text{PAg} - \text{Pcl} + \text{Ga}$$
The measurement results are amend as described below:
$$\text{Power(EIRP)} = \text{PMea} - \text{Pcl} + \text{Ga}$$
8. This value is EIRP since the measurement is calibrated using an antenna of known gain (2.15 dBi)

and known input power. ERP can be calculated from EIRP by subtracting the gain of the dipole, $ERP = EIRP - 2.15\text{dBi}$.

The modulation mode and RB allocation refer to section 5.1, using the maximum output power configuration.

Test setup

9KHz ~ 30MHz

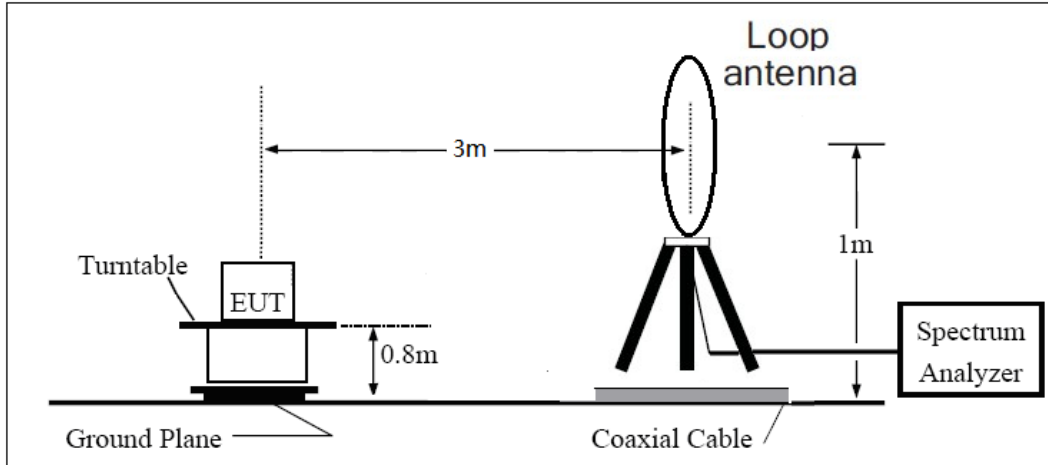

30MHz ~ 1GHz

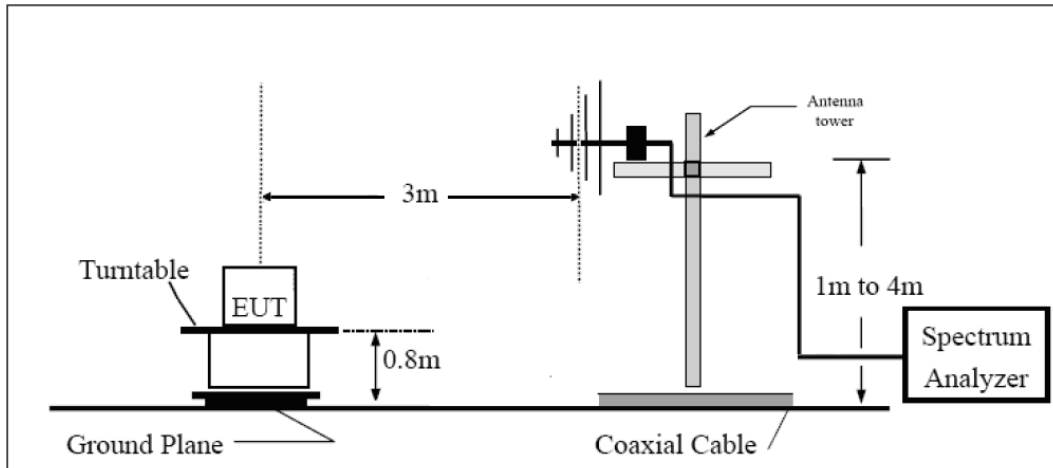

Above 1GHz

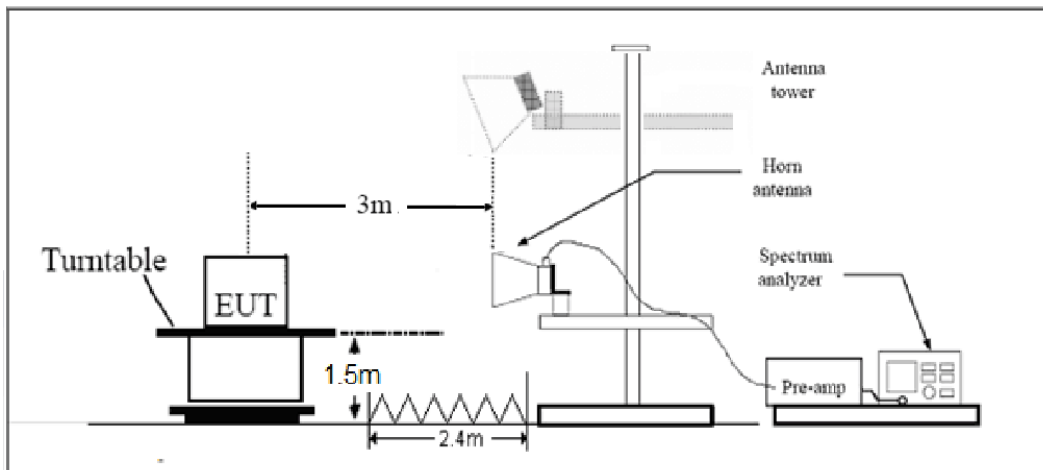



Note: Area side: 2.4mX3.6m

Limits

On any frequency outside a licensee's frequency block, the power of any emission shall be attenuated below the transmitter power (P) by at least $43 + 10 \log_{10} (P)$ dB.”

Limit	-13 dBm
-------	---------

Measurement Uncertainty

The assessed measurement uncertainty to ensure 95% confidence level for the normal distribution is with the coverage factor $k = 1.96$, $U = 3.55$ dB.

**Test Result**

Sweep the whole frequency band through the range from 9kHz to the 10th harmonic of the carrier, the emissions below the noise floor will not be recorded in the report.

LTE Band 53 1.4MHz CH-Middle

Harmonic	Frequency (MHz)	SG (dBm)	Cable Loss (dB)	Gain (dBi)	Antenna Polarization	EIRP Level (dBm)	Limit (dBm)	Margin (dB)	Azimuth (deg)
2	4978.40	-40.14	2.00	10.15	Horizontal	-34.14	-13.00	21.14	315
3	7467.60	-56.50	2.50	11.35	Horizontal	-49.80	-13.00	36.80	45
4	9956.80	-53.72	4.20	12.05	Horizontal	-48.02	-13.00	35.02	225
5	12446.00	-53.19	5.20	14.85	Horizontal	-45.69	-13.00	32.69	90
6	14935.20	-50.25	5.50	13.23	Horizontal	-44.67	-13.00	31.67	180
7	17424.40	-49.68	6.80	14.25	Horizontal	-44.38	-13.00	31.38	270
8	19913.60	/	/	/	/	/	/	/	/
9	22402.80	/	/	/	/	/	/	/	/
10	24892.00	/	/	/	/	/	/	/	/

Note: 1.The other Spurious RF Radiated emissions level is no more than noise floor.
2. The worst emission was found in the antenna is Horizontal position.

LTE Band 53 5MHz CH-Middle

Harmonic	Frequency (MHz)	SG (dBm)	Cable Loss (dB)	Gain (dBi)	Antenna Polarization	EIRP Level (dBm)	Limit (dBm)	Margin (dB)	Azimuth (deg)
2	4978.40	-46.13	2.00	10.15	Horizontal	-40.13	-13.00	27.13	135
3	7467.60	-57.27	2.50	11.35	Horizontal	-50.57	-13.00	37.57	180
4	9956.80	-54.92	4.20	12.05	Horizontal	-49.22	-13.00	36.22	45
5	12446.00	-52.90	5.20	14.85	Horizontal	-45.40	-13.00	32.40	225.0
6	14935.20	-49.01	5.50	13.23	Horizontal	-43.43	-13.00	30.43	315.0
7	17424.40	/	/	/	/	/	/	/	/
8	19913.60	/	/	/	/	/	/	/	/
9	22402.80	/	/	/	/	/	/	/	/
10	24892.00	/	/	/	/	/	/	/	/

Note: 1.The other Spurious RF Radiated emissions level is no more than noise floor.
2. The worst emission was found in the antenna is Horizontal position.



LTE Band 53 10MHz CH-Middle

Harmonic	Frequency (MHz)	SG (dBm)	Cable Loss (dB)	Gain (dBi)	Antenna Polarization	EIRP Level (dBm)	Limit (dBm)	Margin (dB)	Azimuth (deg)
2	4978.40	-46.41	2.00	10.15	Horizontal	-40.41	-13.00	27.41	225
3	7467.60	-56.97	2.50	11.35	Horizontal	-50.27	-13.00	37.27	45
4	9956.80	-53.21	4.20	12.05	Horizontal	-47.51	-13.00	34.51	180
5	12446.00	-53.50	5.20	14.85	Horizontal	-46.00	-13.00	33.00	0.0
6	14935.20	-49.77	5.50	13.23	Horizontal	-44.19	-13.00	31.19	315.0
7	17424.40	-49.48	6.80	14.25	Horizontal	-44.18	-13.00	31.18	90.0
8	19913.60	/	/	/	/	/	/	/	/
9	22402.80	/	/	/	/	/	/	/	/
10	24892.00	/	/	/	/	/	/	/	/

Note: 1. The other Spurious RF Radiated emissions level is no more than noise floor.

2. The worst emission was found in the antenna is Horizontal position.

6. Main Test Instruments

Name	Manufacturer	Type	Serial Number	Calibration Date	Expiration Date
Base Station Simulator	R&S	CMU200	118133	2019-05-19	2020-05-18
Base Station Simulator	R&S	CMW500	113824	2019-05-19	2020-05-18
Power Splitter	Hua Xiang	SHX-GF2-2-13	10120101	/	/
Spectrum Analyzer	Key sight	N9010A	MY50210259	2019-05-19	2020-05-18
Universal Radio Communication Tester	Key sight	E5515C	MY48367192	2019-05-19	2020-05-18
Signal Analyzer	R&S	FSV30	100815	2018-12-16	2019-12-15
Loop Antenna	SCHWARZBECK	FMZB1519	1519-047	2017-09-26	2020-09-25
Trilog Antenna	SCHWARZBECK	VUBL 9163	9163-201	2017-11-18	2020-11-17
Horn Antenna	R&S	HF907	100126	2018-07-07	2020-07-06
Horn Antenna	ETS-Lindgren	3160-09	00102643	2018-06-20	2020-06-19
Signal generator	R&S	SMB 100A	102594	2019-05-19	2020-05-18
Climatic Chamber	ESPEC	SU-242	93000506	2017-12-17	2020-12-16
Preampflier	R&S	SCU18	102327	2019-05-19	2020-05-18
MOB COMMS DC SUPPLY	Keysight	66319D	MY43004105	2019-05-19	2020-05-18
RF Cable	Agilent	SMA 15cm	0001	2019-12-14	2020-06-13
Software	R&S	EMC32	9.26.0	/	/

*****END OF REPORT *****