



# RF TEST REPORT

**Applicant** Shanghai Smawave Technology Co. ,Ltd  
**FCC ID** 2AU8HMGL6201A  
**Product** LTE Module  
**Brand** Smawave  
**Model** MGL6201A  
**Report No.** R2001A0002-R5V1  
**Issue Date** February 20, 2020

TA Technology (Shanghai) Co., Ltd. tested the above equipment in accordance with the requirements in **FCC CFR47 Part 2 (2019)/ FCC CFR 47 Part 90S (2019)**. The test results show that the equipment tested is capable of demonstrating compliance with the requirements as documented in this report.

Performed by: Peng Tao

Approved by: Kai Xu

---

## TA Technology (Shanghai) Co., Ltd.

No.145, Jintang Rd, Tangzhen Industry Park, Pudong Shanghai, China

TEL: +86-021-50791141/2/3

FAX: +86-021-50791141/2/3-8000



## TABLE OF CONTENT

1. Test Laboratory.....	4
1.1. Notes of the Test Report.....	4
1.2. Testing Location.....	4
2. General Description of Equipment under Test.....	5
2.1. Applicant and Manufacturer Information.....	5
2.2. General Information.....	5
3. Applied Standards.....	6
4. Test Configuration.....	7
5. Test Case Results.....	8
5.1. RF Power Output and Effective Radiated Power.....	8
5.2. Occupied Bandwidth.....	15
5.3. Emission Mask.....	23
5.4. Peak-to-Average Power Ratio (PAPR).....	32
5.5. Frequency Stability.....	34
5.6. Spurious Emissions at Antenna Terminals.....	38
5.7. Radiates Spurious Emission.....	43
6. Main Test Instruments.....	48



### Summary of measurement results

No.	Test Case	Clause in FCC rules	Verdict
1	RF power output	2.1046/90.635(b)	PASS
2	Effective Radiated Power	90.635(b)	PASS
3	Occupied Bandwidth	2.1049/ 90.209	PASS
4	Emission Masks	2.1051 / 90.691	PASS
5	Peak-to-Average Power Ratio	KDB 971168 D01(5.7)	PASS
6	Frequency Stability	2.1055 / 90.213	PASS
7	Spurious Emissions at Antenna Terminals	2.1051 / 90.691	PASS
8	Radiates Spurious Emission	2.1053 /90.691	PASS

Date of Testing: October 1, 2019~ November 7, 2019 and December 31, 2019



## 1. Test Laboratory

### 1.1. Notes of the Test Report

This report shall not be reproduced in full or partial, without the written approval of **TA technology (shanghai) co., Ltd.** The results documented in this report apply only to the tested sample, under the conditions and modes of operation as described herein .Measurement Uncertainties were not taken into account and are published for informational purposes only. This report is written to support regulatory compliance of the applicable standards stated above.

### 1.2. Testing Location

Company: TA Technology (Shanghai) Co., Ltd.  
Address: No.145, Jintang Rd, Tangzhen Industry Park, Pudong  
City: Shanghai  
Post code: 201201  
Country: P. R. China  
Contact: Xu Kai  
Telephone: +86-021-50791141/2/3  
Fax: +86-021-50791141/2/3-8000  
Website: <http://www.ta-shanghai.com>  
E-mail: [xukai@ta-shanghai.com](mailto:xukai@ta-shanghai.com)

## 2. General Description of Equipment under Test

### 2.1. Applicant and Manufacturer Information

Applicant	Shanghai Smawave Technology Co. ,Ltd
Applicant address	3/F, Building 8, 1001 North Qinzhou Road, Xuhui District, Shanghai, China
Manufacturer	Shanghai Smawave Technology Co. ,Ltd
Manufacturer address	3/F, Building 8, 1001 North Qinzhou Road, Xuhui District, Shanghai, China

### 2.2. General Information

EUT Description			
Model	MGL6201A		
Product IMEI	860524031979550		
Hardware Version	V2.0		
Software Version	CAT12-A		
Power Supply	External Power Supply		
Antenna Type	External Antenna		
Antenna Gain	2.78dBi		
Test Mode(s)	LTE Band 26;		
Test Modulation	QPSK 16QAM 64QAM;		
LTE Category	12		
Maximum E.R.P.	LTE Band 26:	21.59dBm	
Rated Power Supply Voltage	3.3V		
Extreme Voltage	Minimum: 3V    Maximum: 3.6V		
Extreme Temperature	Lowest: -40°C    Highest: +70°C		
Operating Frequency Range(s)	Band	Tx (MHz)	Rx (MHz)
	LTE Band 26	814 ~ 824	859 ~ 869
Note: The information of the EUT is declared by the manufacturer.			



### **3. Applied Standards**

According to the specifications of the manufacturer, it must comply with the requirements of the following standards:

**Test standards:**

**FCC CFR 47 Part 90S (2019)**

**ANSI C63.26 (2015)**

**Reference standard:**

**FCC CFR47 Part 2 (2019)**

**KDB 971168 D01 Power Meas License Digital Systems v03r01**

### 4. Test Configuration

Radiated measurements are performed by rotating the EUT in three different orthogonal test planes. EUT stand-up position (Z axis), lie-down position (X, Y axis). Receiver antenna polarization (horizontal and vertical), the worst emission was found in position (X axis, horizontal polarization) and the worst case was recorded.

All mode and data rates and positions were investigated.

The following testing in LTE is set based on the maximum RF Output Power.

Test modes are chosen as the worst case configuration below for LTE Band 26

Test items	Bandwidth (MHz)					Modulation			RB			Test Channel		
	1.4	3	5	10	15	QPSK	16QAM	64QAM	1	50%	100%	L	M	H
RF power output and Effective Isotropic Radiated power	O	O	O	O	O	O	O	O	O	O	O	O	O	O
Occupied Bandwidth	O	O	O	O	O	O	O	O	-	-	O	O	O	O
Emission Mask	O	O	O	O	O	O	O	O	O	-	O	O	-	O
Peak-to-Average Power Ratio	O	O	O	O	O	O	O	O	-	-	O	O	O	O
Frequency Stability	O	O	O	O	O	O	O	O	-	-	O	-	O	-
Spurious Emissions at Antenna Terminals	O	O	O	O	O	O	-	-	O	-	-	O	O	O
Radiates Spurious Emission	O	-	O	-	O	O	-	-	O	-	-	-	O	-
Note	1. The mark "O" means that this configuration is chosen for testing. 2. The mark "-" means that this configuration is not testing.													

## 5. Test Case Results

### 5.1. RF Power Output and Effective Radiated Power

#### Ambient condition

Temperature	Relative humidity
21°C ~25°C	40%~60%

#### Methods of Measurement

During the process of the testing, The EUT is controlled by the Base Station Simulator to ensure max power transmission and proper modulation.

The testing follows FCC KDB 971168 v03r01 Section 5.8 and ANSI C63.26 (2015).

- a) Connect the equipment as illustrated. Mount the equipment with the manufacturer specified antenna in a vertical orientation on a manufacturer specified mounting surface located on a non-conducting rotating platform of a RF anechoic chamber (preferred) or a standard radiation site.
- b) Key the transmitter, then rotate the EUT 360° azimuthally and record spectrum analyzer power level (LVL) measurements at angular increments that are sufficiently small to permit resolution of all peaks. If a standard radiation test site is used, raise and lower the test antenna to obtain a maximum reading at each angular increment. (Note: several batteries may be needed to offset the effect of battery voltage droop, which should not exceed 5% of the manufactured specified battery voltage during transmission).
- c) Replace the transmitter under test with a vertically polarized half-wave dipole (or an antenna whose gain is known relative to an ideal half-wave dipole). The center of the antenna should be at the same location as the center of the antenna under test.
- d) Connect the antenna to a signal generator with a known output power and record the path loss (in dB) as LOSS. If a standard radiation test site is used, raise and lower the test antenna to obtain a maximum reading.  $LOSS = \text{Generator Output Power (dBm)} - \text{Analyzer reading (dBm)}$
- e) Determine the effective radiated output power at each angular position from the readings in steps b) and d) using the following equation:  $ERP \text{ (dBm)} = \text{LVL (dBm)} + \text{LOSS (dB)}$
- f) The maximum ERP is the maximum value determined in the preceding step.
- g) When calculating ERP, in addition to knowing the antenna radiation and matching characteristics, it is necessary to know the loss values of all elements (e.g. transmission line attenuation, mismatches, filters, combiners) interposed between the point where transmitter output power is measured, and the point where power is applied to the antenna. ERP can then be calculated as follows:  
 $EIRP \text{ (dBm)} = \text{Output Power (dBm)} - \text{Losses (dB)} + \text{Antenna Gain (dBi)}$   
where: dBd refers to gain relative to an ideal dipole.  
 $EIRP \text{ (dBm)} = ERP \text{ (dBm)} + 2.15 \text{ (dB)}$

The RB allocation refers to section 5.1, using the maximum output power configuration.



**Test Setup**

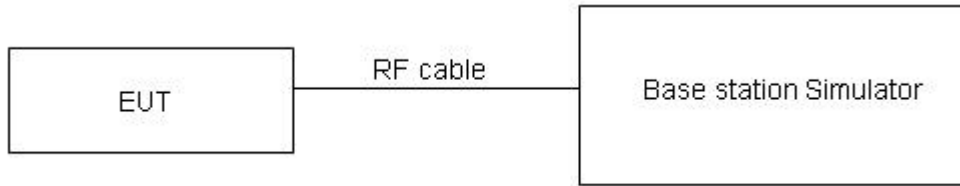

The loss between RF output port of the EUT and the input port of the tester has been taken into consideration.

**Below 1GHz:**

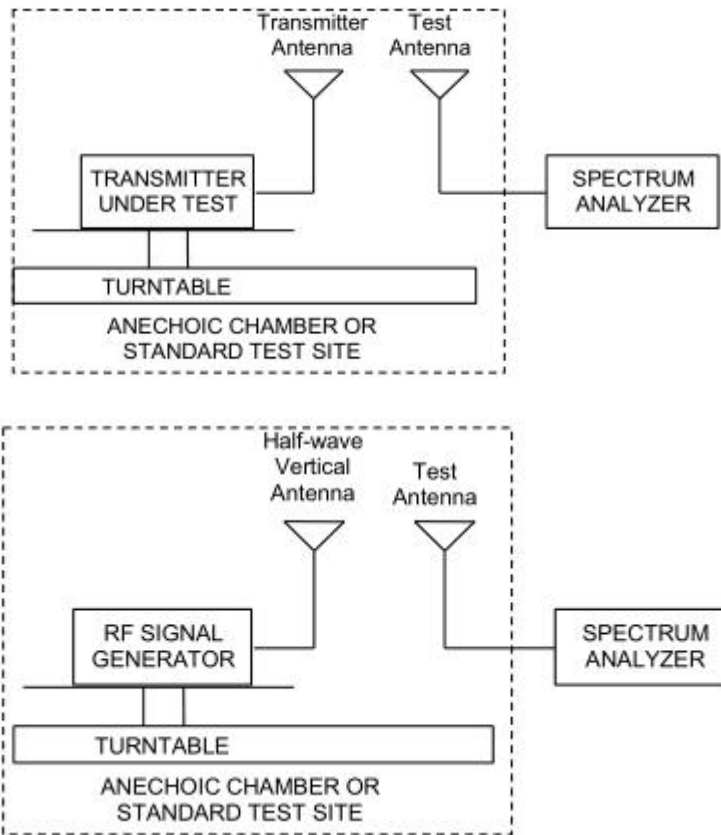

**Limits**

Part 90.635 (b) the maximum output power of the transmitter for mobile stations is 100 watts.

Rule Part 90.635(b) specifies that “The maximum output power of the transmitter for mobile stations is 100 watts”.

Limit	$\leq 100\text{ W}$ (50 dBm)
-------	------------------------------

**Measurement Uncertainty**

The assessed measurement uncertainty to ensure 95% confidence level for the normal distribution is with the coverage factor  $k = 2$ ,  $U = 0.4\text{ dB}$  for RF power output,  $k = 2$ ,  $U = 1.19\text{ dB}$  for ERP .with the coverage factor  $k = 2$ ,  $U = 0.4\text{ dB}$ .

**Test Results**

BAND	Bandwidth	Modulation	Channel	RB Configuration	Conducted Power(dBm)	ERP (dBm)
Band26-part90	1.4M	QPSK	26697	1RB#0	14.84	15.47
Band26-part90	1.4M	QPSK	26697	1RB#2	13.07	13.70
Band26-part90	1.4M	QPSK	26697	1RB#5	11.94	12.57
Band26-part90	1.4M	QPSK	26697	3RB#0	14.37	15.00
Band26-part90	1.4M	QPSK	26697	3RB#2	14.28	14.91
Band26-part90	1.4M	QPSK	26697	3RB#3	12.25	12.88
Band26-part90	1.4M	QPSK	26697	6RB#0	13.20	13.83
Band26-part90	1.4M	QPSK	26740	1RB#0	12.56	13.19
Band26-part90	1.4M	QPSK	26740	1RB#2	12.10	12.73
Band26-part90	1.4M	QPSK	26740	1RB#5	12.67	13.30
Band26-part90	1.4M	QPSK	26740	3RB#0	12.55	13.18
Band26-part90	1.4M	QPSK	26740	3RB#2	12.51	13.14
Band26-part90	1.4M	QPSK	26740	3RB#3	12.10	12.73
Band26-part90	1.4M	QPSK	26740	6RB#0	12.05	12.68
Band26-part90	1.4M	QPSK	26783	1RB#0	11.89	12.52
Band26-part90	1.4M	QPSK	26783	1RB#2	13.35	13.98
Band26-part90	1.4M	QPSK	26783	1RB#5	14.34	14.97
Band26-part90	1.4M	QPSK	26783	3RB#0	12.64	13.27
Band26-part90	1.4M	QPSK	26783	3RB#2	12.58	13.21
Band26-part90	1.4M	QPSK	26783	3RB#3	13.82	14.45
Band26-part90	1.4M	QPSK	26783	6RB#0	12.99	13.62
Band26-part90	1.4M	16QAM	26697	1RB#0	14.97	15.60
Band26-part90	1.4M	16QAM	26697	1RB#2	13.25	13.88
Band26-part90	1.4M	16QAM	26697	1RB#5	12.10	12.73
Band26-part90	1.4M	16QAM	26697	3RB#0	14.24	14.87
Band26-part90	1.4M	16QAM	26697	3RB#2	14.20	14.83
Band26-part90	1.4M	16QAM	26697	3RB#3	12.15	12.78
Band26-part90	1.4M	16QAM	26697	6RB#0	13.14	13.77
Band26-part90	1.4M	16QAM	26740	1RB#0	12.67	13.30
Band26-part90	1.4M	16QAM	26740	1RB#2	12.15	12.78
Band26-part90	1.4M	16QAM	26740	1RB#5	12.86	13.49
Band26-part90	1.4M	16QAM	26740	3RB#0	12.54	13.17
Band26-part90	1.4M	16QAM	26740	3RB#2	12.53	13.16
Band26-part90	1.4M	16QAM	26740	3RB#3	12.17	12.80
Band26-part90	1.4M	16QAM	26740	6RB#0	12.13	12.76
Band26-part90	1.4M	16QAM	26783	1RB#0	11.77	12.40
Band26-part90	1.4M	16QAM	26783	1RB#2	13.25	13.88
Band26-part90	1.4M	16QAM	26783	1RB#5	14.23	14.86
Band26-part90	1.4M	16QAM	26783	3RB#0	12.62	13.25



Band26-part90	1.4M	16QAM	26783	3RB#2	12.63	13.26
Band26-part90	1.4M	16QAM	26783	3RB#3	13.79	14.42
Band26-part90	1.4M	16QAM	26783	6RB#0	13.14	13.77
Band26-part90	1.4M	64QAM	26697	1RB#0	20.67	21.30
Band26-part90	1.4M	64QAM	26697	1RB#2	20.35	20.98
Band26-part90	1.4M	64QAM	26697	1RB#5	19.91	20.54
Band26-part90	1.4M	64QAM	26697	3RB#0	20.57	21.20
Band26-part90	1.4M	64QAM	26697	3RB#2	20.56	21.19
Band26-part90	1.4M	64QAM	26697	3RB#3	20.15	20.78
Band26-part90	1.4M	64QAM	26697	6RB#0	20.14	20.77
Band26-part90	1.4M	64QAM	26740	1RB#0	17.98	18.61
Band26-part90	1.4M	64QAM	26740	1RB#2	18.22	18.85
Band26-part90	1.4M	64QAM	26740	1RB#5	18.11	18.74
Band26-part90	1.4M	64QAM	26740	3RB#0	17.84	18.47
Band26-part90	1.4M	64QAM	26740	3RB#2	17.80	18.43
Band26-part90	1.4M	64QAM	26740	3RB#3	18.01	18.64
Band26-part90	1.4M	64QAM	26740	6RB#0	17.89	18.52
Band26-part90	1.4M	64QAM	26783	1RB#0	19.98	20.61
Band26-part90	1.4M	64QAM	26783	1RB#2	20.21	20.84
Band26-part90	1.4M	64QAM	26783	1RB#5	20.19	20.82
Band26-part90	1.4M	64QAM	26783	3RB#0	20.51	21.14
Band26-part90	1.4M	64QAM	26783	3RB#2	20.52	21.15
Band26-part90	1.4M	64QAM	26783	3RB#3	20.66	21.29
Band26-part90	1.4M	64QAM	26783	6RB#0	20.55	21.18
Band26-part90	3M	QPSK	26705	1RB#0	14.86	15.49
Band26-part90	3M	QPSK	26705	1RB#7	13.10	13.73
Band26-part90	3M	QPSK	26705	1RB#14	11.97	12.60
Band26-part90	3M	QPSK	26705	8RB#0	14.45	15.08
Band26-part90	3M	QPSK	26705	8RB#4	14.38	15.01
Band26-part90	3M	QPSK	26705	8RB#7	12.33	12.96
Band26-part90	3M	QPSK	26705	15RB#0	13.23	13.86
Band26-part90	3M	QPSK	26740	1RB#0	12.60	13.23
Band26-part90	3M	QPSK	26740	1RB#7	12.15	12.78
Band26-part90	3M	QPSK	26740	1RB#14	12.72	13.35
Band26-part90	3M	QPSK	26740	8RB#0	12.65	13.28
Band26-part90	3M	QPSK	26740	8RB#4	12.59	13.22
Band26-part90	3M	QPSK	26740	8RB#7	12.19	12.82
Band26-part90	3M	QPSK	26740	15RB#0	12.09	12.72
Band26-part90	3M	QPSK	26775	1RB#0	11.92	12.55
Band26-part90	3M	QPSK	26775	1RB#7	13.39	14.02
Band26-part90	3M	QPSK	26775	1RB#14	14.38	15.01
Band26-part90	3M	QPSK	26775	8RB#0	12.75	13.38
Band26-part90	3M	QPSK	26775	8RB#4	12.68	13.31



Band26-part90	3M	QPSK	26775	8RB#7	13.90	14.53
Band26-part90	3M	QPSK	26775	15RB#0	13.02	13.65
Band26-part90	3M	16QAM	26705	1RB#0	15.00	15.63
Band26-part90	3M	16QAM	26705	1RB#7	13.28	13.91
Band26-part90	3M	16QAM	26705	1RB#14	12.12	12.75
Band26-part90	3M	16QAM	26705	8RB#0	14.33	14.96
Band26-part90	3M	16QAM	26705	8RB#4	14.29	14.92
Band26-part90	3M	16QAM	26705	8RB#7	12.23	12.86
Band26-part90	3M	16QAM	26705	15RB#0	13.17	13.80
Band26-part90	3M	16QAM	26740	1RB#0	12.69	13.32
Band26-part90	3M	16QAM	26740	1RB#7	12.20	12.83
Band26-part90	3M	16QAM	26740	1RB#14	12.90	13.53
Band26-part90	3M	16QAM	26740	8RB#0	12.65	13.28
Band26-part90	3M	16QAM	26740	8RB#4	12.64	13.27
Band26-part90	3M	16QAM	26740	8RB#7	12.27	12.90
Band26-part90	3M	16QAM	26740	15RB#0	12.17	12.80
Band26-part90	3M	16QAM	26775	1RB#0	11.80	12.43
Band26-part90	3M	16QAM	26775	1RB#7	13.29	13.92
Band26-part90	3M	16QAM	26775	1RB#14	14.26	14.89
Band26-part90	3M	16QAM	26775	8RB#0	12.72	13.35
Band26-part90	3M	16QAM	26775	8RB#4	12.73	13.36
Band26-part90	3M	16QAM	26775	8RB#7	13.90	14.53
Band26-part90	3M	16QAM	26775	15RB#0	13.17	13.80
Band26-part90	3M	64QAM	26705	1RB#0	18.04	18.67
Band26-part90	3M	64QAM	26705	1RB#7	19.63	20.26
Band26-part90	3M	64QAM	26705	1RB#14	18.67	19.30
Band26-part90	3M	64QAM	26705	8RB#0	20.38	21.01
Band26-part90	3M	64QAM	26705	8RB#4	20.36	20.99
Band26-part90	3M	64QAM	26705	8RB#7	19.13	19.76
Band26-part90	3M	64QAM	26705	15RB#0	19.52	20.15
Band26-part90	3M	64QAM	26740	1RB#0	17.83	18.46
Band26-part90	3M	64QAM	26740	1RB#7	17.87	18.50
Band26-part90	3M	64QAM	26740	1RB#14	18.22	18.85
Band26-part90	3M	64QAM	26740	8RB#0	18.62	19.25
Band26-part90	3M	64QAM	26740	8RB#4	18.61	19.24
Band26-part90	3M	64QAM	26740	8RB#7	18.00	18.63
Band26-part90	3M	64QAM	26740	15RB#0	18.01	18.64
Band26-part90	3M	64QAM	26775	1RB#0	19.19	19.82
Band26-part90	3M	64QAM	26775	1RB#7	20.26	20.89
Band26-part90	3M	64QAM	26775	1RB#14	20.53	21.16
Band26-part90	3M	64QAM	26775	8RB#0	20.29	20.92
Band26-part90	3M	64QAM	26775	8RB#4	20.26	20.89
Band26-part90	3M	64QAM	26775	8RB#7	20.11	20.74



Band26-part90	3M	64QAM	26775	15RB#0	19.84	20.47
Band26-part90	5M	QPSK	26715	1RB#0	14.81	15.44
Band26-part90	5M	QPSK	26715	1RB#13	13.08	13.71
Band26-part90	5M	QPSK	26715	1RB#24	11.91	12.54
Band26-part90	5M	QPSK	26715	12RB#0	14.40	15.03
Band26-part90	5M	QPSK	26715	12RB#6	14.34	14.97
Band26-part90	5M	QPSK	26715	12RB#13	12.27	12.90
Band26-part90	5M	QPSK	26715	25RB#0	13.24	13.87
Band26-part90	5M	QPSK	26740	1RB#0	12.51	13.14
Band26-part90	5M	QPSK	26740	1RB#13	12.11	12.74
Band26-part90	5M	QPSK	26740	1RB#24	12.65	13.28
Band26-part90	5M	QPSK	26740	12RB#0	12.56	13.19
Band26-part90	5M	QPSK	26740	12RB#6	12.51	13.14
Band26-part90	5M	QPSK	26740	12RB#13	12.13	12.76
Band26-part90	5M	QPSK	26740	25RB#0	12.01	12.64
Band26-part90	5M	QPSK	26765	1RB#0	11.86	12.49
Band26-part90	5M	QPSK	26765	1RB#13	13.35	13.98
Band26-part90	5M	QPSK	26765	1RB#24	14.30	14.93
Band26-part90	5M	QPSK	26765	12RB#0	12.68	13.31
Band26-part90	5M	QPSK	26765	12RB#6	12.60	13.23
Band26-part90	5M	QPSK	26765	12RB#13	13.83	14.46
Band26-part90	5M	QPSK	26765	25RB#0	12.95	13.58
Band26-part90	5M	16QAM	26715	1RB#0	14.92	15.55
Band26-part90	5M	16QAM	26715	1RB#13	13.22	13.85
Band26-part90	5M	16QAM	26715	1RB#24	12.07	12.70
Band26-part90	5M	16QAM	26715	12RB#0	14.28	14.91
Band26-part90	5M	16QAM	26715	12RB#6	14.22	14.85
Band26-part90	5M	16QAM	26715	12RB#13	12.18	12.81
Band26-part90	5M	16QAM	26715	25RB#0	13.13	13.76
Band26-part90	5M	16QAM	26740	1RB#0	12.62	13.25
Band26-part90	5M	16QAM	26740	1RB#13	12.17	12.80
Band26-part90	5M	16QAM	26740	1RB#24	12.83	13.46
Band26-part90	5M	16QAM	26740	12RB#0	12.60	13.23
Band26-part90	5M	16QAM	26740	12RB#6	12.56	13.19
Band26-part90	5M	16QAM	26740	12RB#13	12.18	12.81
Band26-part90	5M	16QAM	26740	25RB#0	12.09	12.72
Band26-part90	5M	16QAM	26765	1RB#0	11.72	12.35
Band26-part90	5M	16QAM	26765	1RB#13	13.23	13.86
Band26-part90	5M	16QAM	26765	1RB#24	14.20	14.83
Band26-part90	5M	16QAM	26765	12RB#0	12.67	13.30
Band26-part90	5M	16QAM	26765	12RB#6	12.65	13.28
Band26-part90	5M	16QAM	26765	12RB#13	13.83	14.46
Band26-part90	5M	16QAM	26765	25RB#0	13.09	13.72



Band26-part90	5M	64QAM	26715	1RB#0	20.32	20.95
Band26-part90	5M	64QAM	26715	1RB#13	18.62	19.25
Band26-part90	5M	64QAM	26715	1RB#24	17.75	18.38
Band26-part90	5M	64QAM	26715	12RB#0	19.77	20.40
Band26-part90	5M	64QAM	26715	12RB#6	19.76	20.39
Band26-part90	5M	64QAM	26715	12RB#13	17.77	18.40
Band26-part90	5M	64QAM	26715	25RB#0	18.76	19.39
Band26-part90	5M	64QAM	26740	1RB#0	18.13	18.76
Band26-part90	5M	64QAM	26740	1RB#13	17.97	18.60
Band26-part90	5M	64QAM	26740	1RB#24	18.68	19.31
Band26-part90	5M	64QAM	26740	12RB#0	18.47	19.10
Band26-part90	5M	64QAM	26740	12RB#6	18.51	19.14
Band26-part90	5M	64QAM	26740	12RB#13	17.94	18.57
Band26-part90	5M	64QAM	26740	25RB#0	17.81	18.44
Band26-part90	5M	64QAM	26765	1RB#0	17.89	18.52
Band26-part90	5M	64QAM	26765	1RB#13	19.45	20.08
Band26-part90	5M	64QAM	26765	1RB#24	20.19	20.82
Band26-part90	5M	64QAM	26765	12RB#0	18.90	19.53
Band26-part90	5M	64QAM	26765	12RB#6	18.90	19.53
Band26-part90	5M	64QAM	26765	12RB#13	19.67	20.30
Band26-part90	5M	64QAM	26765	25RB#0	18.86	19.49
Band26-part90	10M	QPSK	26740	1RB#0	14.94	15.57
Band26-part90	10M	QPSK	26740	1RB#25	11.91	12.54
Band26-part90	10M	QPSK	26740	1RB#49	14.48	15.11
Band26-part90	10M	QPSK	26740	25RB#0	13.19	13.82
Band26-part90	10M	QPSK	26740	25RB#13	13.15	13.78
Band26-part90	10M	QPSK	26740	25RB#25	12.98	13.61
Band26-part90	10M	QPSK	26740	50RB#0	13.01	13.64
Band26-part90	10M	16QAM	26740	1RB#0	14.98	15.61
Band26-part90	10M	16QAM	26740	1RB#25	12.07	12.70
Band26-part90	10M	16QAM	26740	1RB#49	14.69	15.32
Band26-part90	10M	16QAM	26740	25RB#0	13.09	13.72
Band26-part90	10M	16QAM	26740	25RB#13	13.07	13.70
Band26-part90	10M	16QAM	26740	25RB#25	12.97	13.60
Band26-part90	10M	16QAM	26740	50RB#0	13.00	13.63
Band26-part90	10M	64QAM	26740	1RB#0	20.55	21.18
Band26-part90	10M	64QAM	26740	1RB#25	18.02	18.65
Band26-part90	10M	64QAM	26740	1RB#49	20.96	21.59
Band26-part90	10M	64QAM	26740	25RB#0	18.80	19.43
Band26-part90	10M	64QAM	26740	25RB#13	18.81	19.44
Band26-part90	10M	64QAM	26740	25RB#25	19.26	19.89
Band26-part90	10M	64QAM	26740	50RB#0	18.92	19.55

## 5.2. Occupied Bandwidth

### Ambient condition

Temperature	Relative humidity
21°C ~25°C	40%~60%

### Method of Measurement

The EUT was connected to Spectrum Analyzer and Base Station Simulator via power Splitter. The occupied bandwidth is measured using spectrum analyzer.

RBW is set to 51 kHz, VBW is set to 160 kHz for LTE Band 26 (1.4MHz),

RBW is set to 100 kHz, VBW is set to 300 kHz for LTE Band 26 (3MHz/5MHz).

RBW is set to 300 kHz, VBW is set to 1MHz for LTE Band 26 (10MHz).

99% power and -26dBc occupied bandwidths are recorded. Spectrum analyzer plots are included on the following pages.

### Test Setup

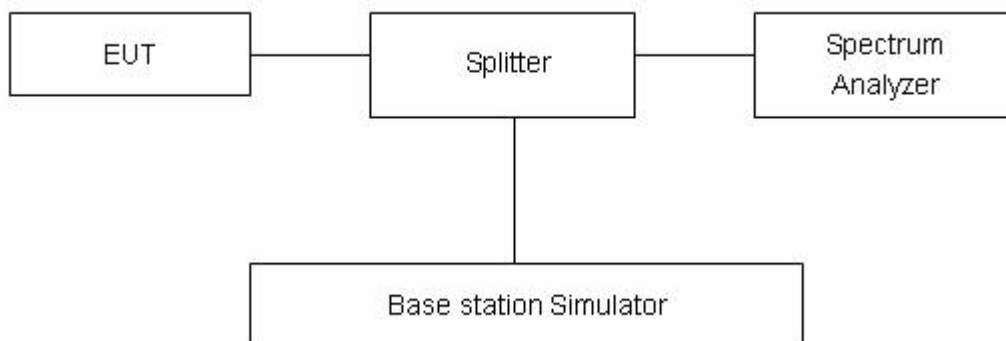

### Limits

No specific occupied bandwidth requirements in part 2.1049.

Part 90.209 (a) Each authorization issued to a station licensed under this part will show an emission designator representing the class of emission authorized. The designator will be prefixed by a specified necessary bandwidth. This number does not necessarily indicate the bandwidth occupied by the emission at any instant. In those cases where part 2.202 of this chapter does not provide a formula for the computation of necessary bandwidth, the occupied bandwidth, as defined in part 2 of this chapter, may be used in lieu of the necessary bandwidth.

### Measurement Uncertainty

The assessed measurement uncertainty to ensure 95% confidence level for the normal distribution is with the coverage factor  $k = 2$ ,  $U = 624\text{Hz}$ .



## Test Result

LTE Band 26							
RB	Modulation	Bandwidth (MHz)	Channel	Frequency (MHz)	99% Power Bandwidth(MHz)	-26dBc Bandwidth(MHz)	
100%	QPSK	1.4	26697	814.7	1.1727	1.618	
			26740	819	1.1541	1.553	
			26783	823.3	1.1836	1.783	
		3	26705	815.5	2.7941	3.477	
			26740	819	2.7720	3.459	
			26775	822.5	2.7952	3.690	
		5	26715	816.5	4.5554	5.459	
			26740	819	4.5526	5.427	
			26765	821.5	4.5489	5.455	
		10	26740	819	9.1415	10.420	
		16QAM	1.4	26697	814.7	1.1575	1.606
				26740	819	1.1789	1.556
	26783			823.3	1.1914	1.955	
	3		26705	815.5	2.8091	3.607	
			26740	819	2.7984	3.546	
			26775	822.5	2.8758	4.413	
	5		26715	816.5	4.5859	5.526	
			26740	819	4.5775	5.492	
			26765	821.5	4.5318	5.283	
	10		26740	819	9.1231	10.280	
	64QAM		1.4	26697	814.7	1.1220	1.508
				26740	819	1.1040	1.488
		26783		823.3	1.1150	1.461	
		3	26705	815.5	2.7300	3.459	
			26740	819	2.7190	3.284	
			26775	822.5	2.7170	3.355	
		5	26715	816.5	4.5470	5.367	
			26740	819	4.5580	5.316	
			26765	821.5	4.5570	5.365	
		10	26740	819	9.0250	10.042	



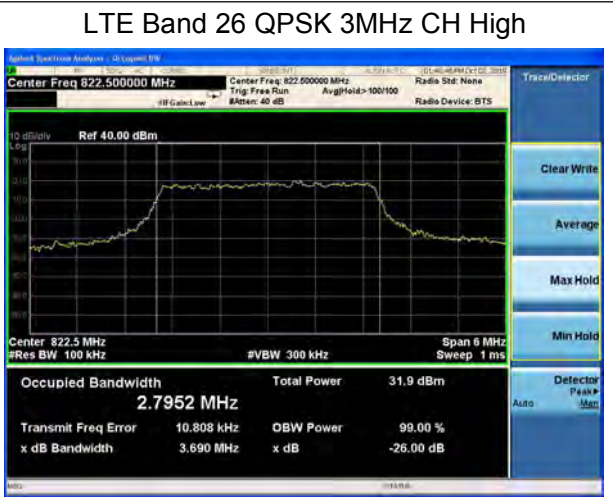
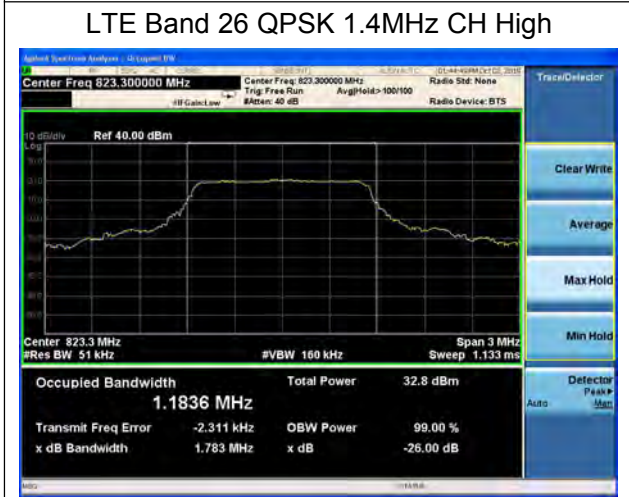
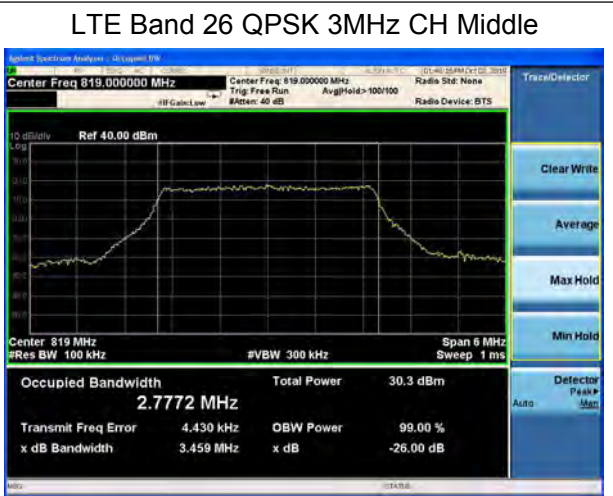
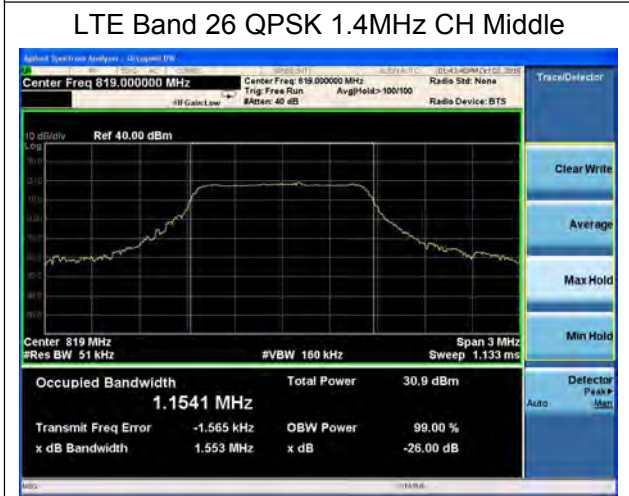
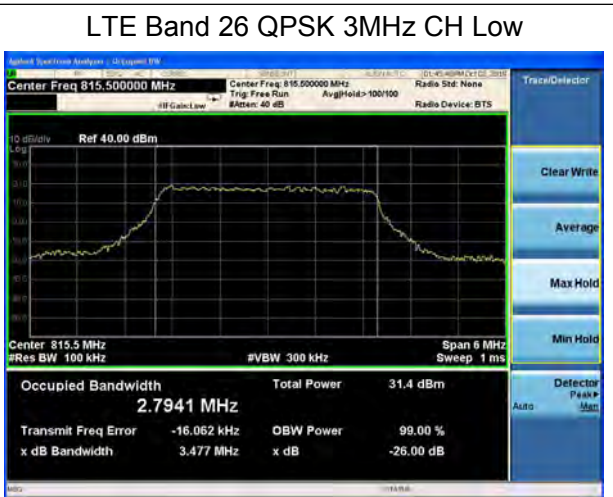
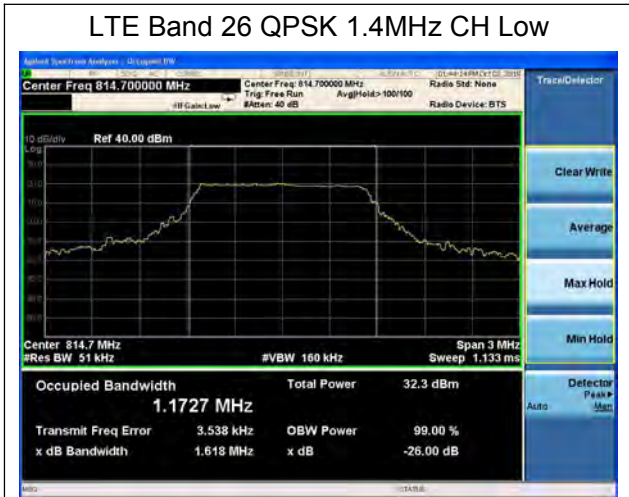



### LTE Band 26 QPSK 5MHz CH Low



### LTE Band 26 QPSK 5MHz CH Middle



### LTE Band 26 QPSK 5MHz CH High

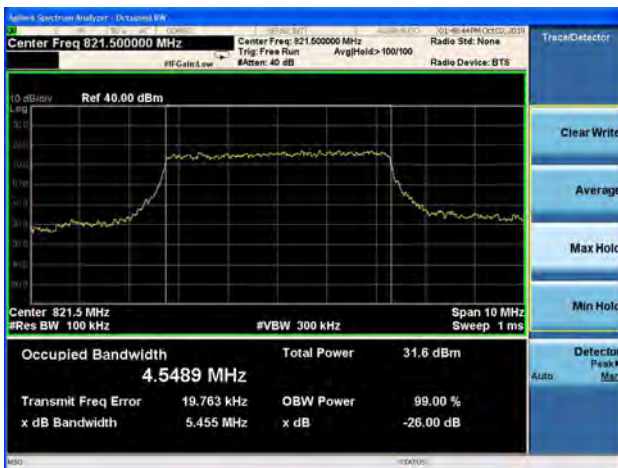

### LTE Band 26 QPSK 10MHz CH Middle





LTE Band 26 16QAM 1.4MHz CH Low



LTE Band 26 16QAM 3MHz CH Low



LTE Band 26 16QAM 1.4MHz CH Middle

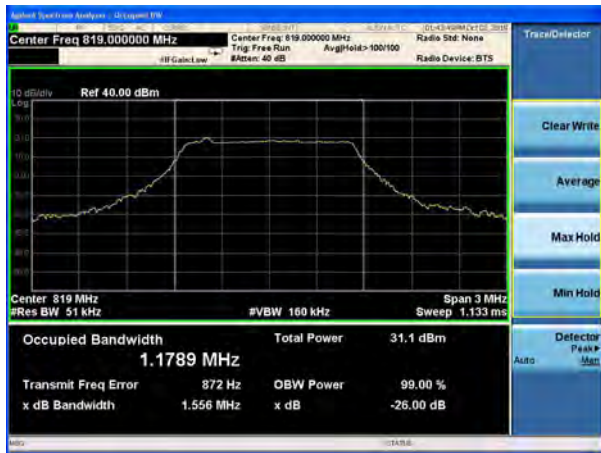

LTE Band 26 16QAM 3MHz CH Middle

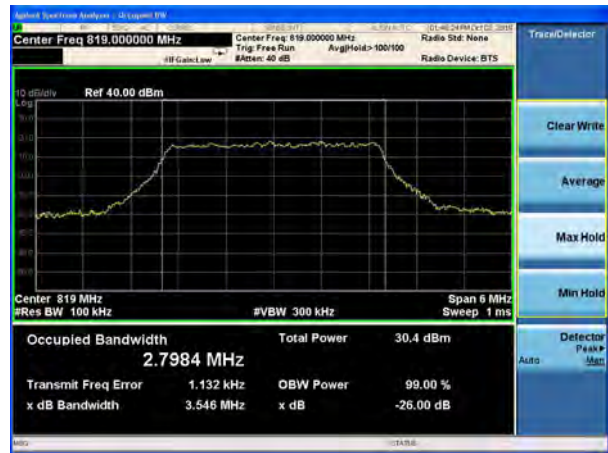

LTE Band 26 16QAM 1.4MHz CH High

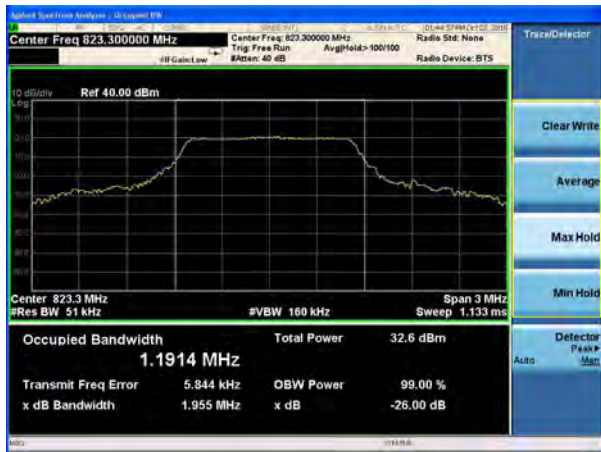

LTE Band 26 16QAM 3MHz CH High





### LTE Band 26 16QAM 5MHz CH Low



### LTE Band 26 16QAM 5MHz CH Middle



### LTE Band 26 16QAM 5MHz CH High



### LTE Band 26 16QAM 10MHz CH Middle





LTE Band 26 64QAM 1.4MHz CH Low



LTE Band 26 64QAM 3MHz CH Low



LTE Band 26 64QAM 1.4MHz CH Middle

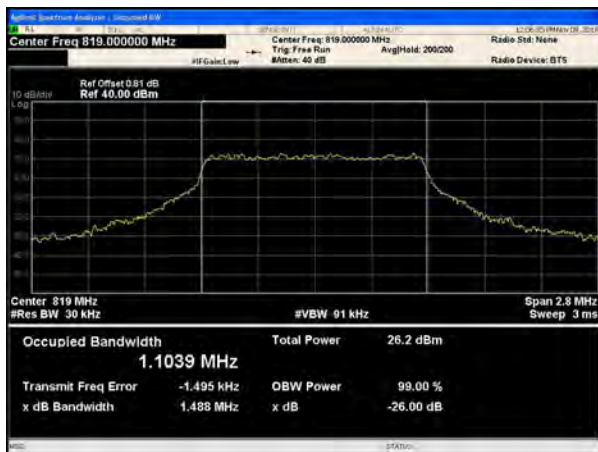

LTE Band 26 64QAM 3MHz CH Middle

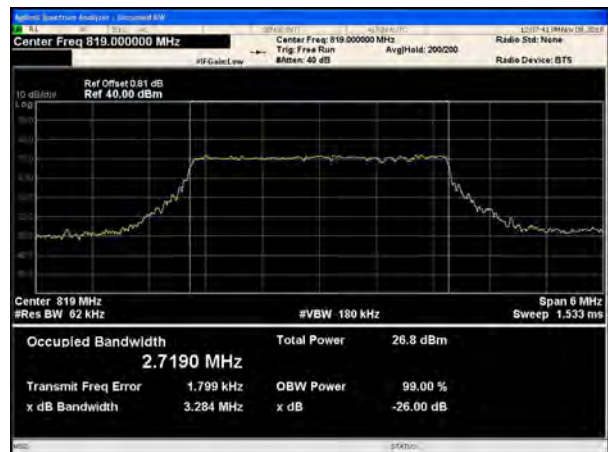

LTE Band 26 64QAM 1.4MHz CH High

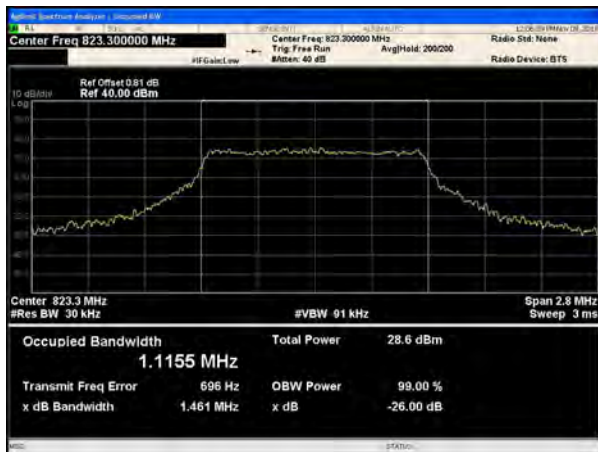

LTE Band 26 64QAM 3MHz CH High

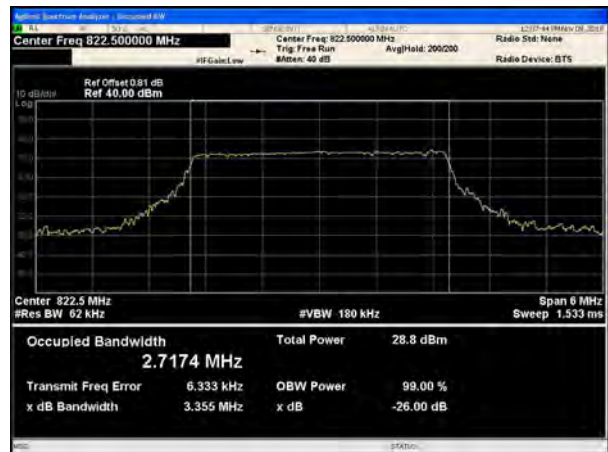



### LTE Band 26 64QAM 5MHz CH Low

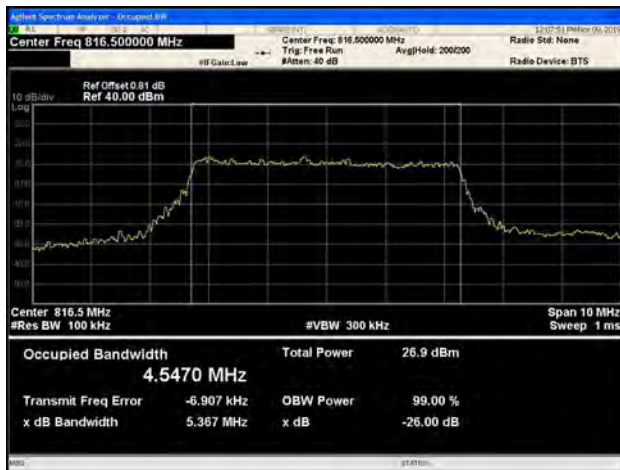

### LTE Band 26 64QAM 5MHz CH Middle

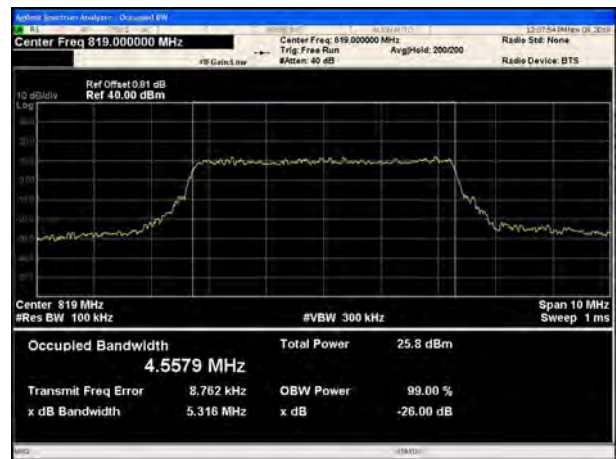

### LTE Band 26 64QAM 5MHz CH High

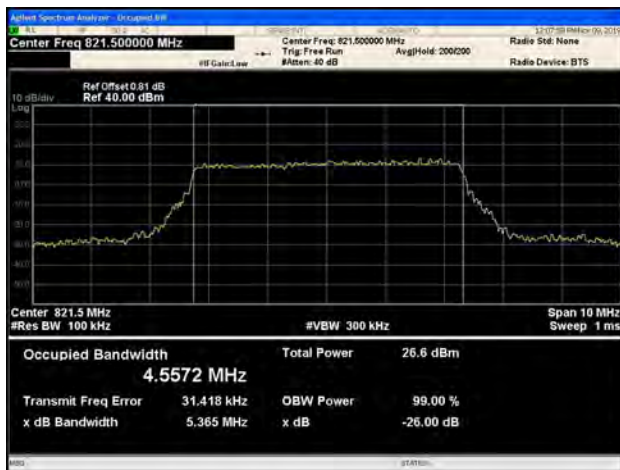

### LTE Band 26 64QAM 10MHz CH Middle

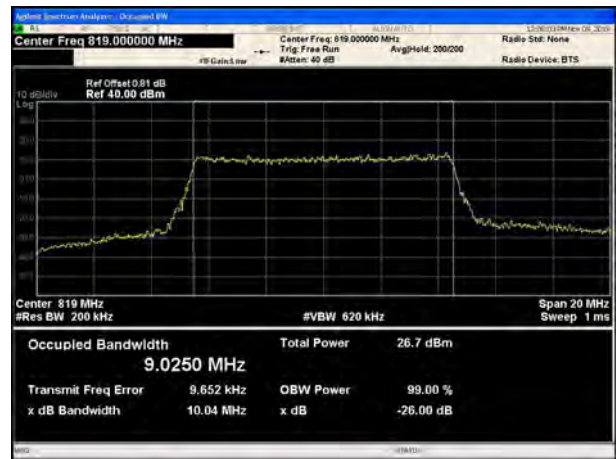

### 5.3. Emission Mask

#### Ambient condition

Temperature	Relative humidity
21°C ~25°C	40%~60%

#### Method of Measurement

The EUT was connected to Spectrum Analyzer and Base Station Simulator via power Splitter. The band edge of the lowest and highest channels were measured. The average detector is used.

RBW is set to 20kHz, VBW is set to 100kHz for LTE Band 26 (1.4MHz).

RBW is set to 30kHz, VBW is set to 100kHz for LTE Band 26 (3MHz).

RBW is set to 50kHz, VBW is set to 200kHz for LTE Band 26 (5MHz).

RBW is set to 100kHz, VBW is set to 300kHz for LTE Band 26 (10MHz).

Spectrum analyzer plots are included on the following pages.

#### Test Setup

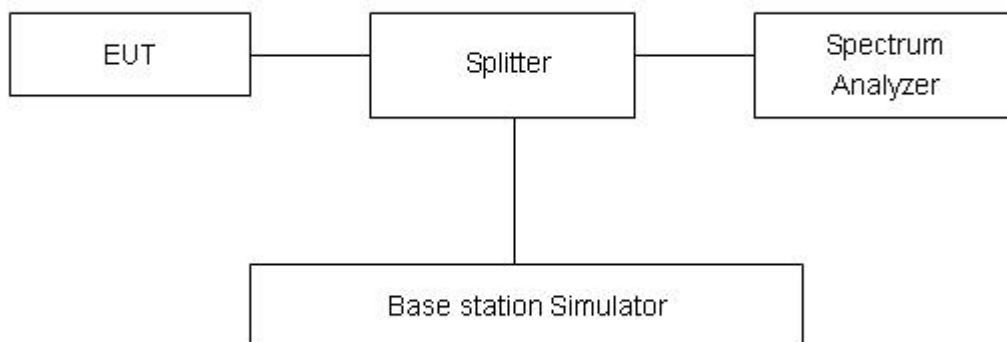

#### Limits

Rule Part 90.691(a) specifies that “ For any frequency removed from the EA licensee’s frequency block by up to and including 37.5 kHz, the power of any emission shall be attenuated below the transmitter power (P) in watts by at least  $116 \text{ Log}_{10}(f/6.1)$  decibels or  $50 + 10 \text{ Log}_{10}(P)$  decibels or 80 decibels, whichever is the lesser attenuation, where f is the frequency removed from the center of the outer channel in the block in kilohertz and where f is greater than 12.5 kHz.”

#### Measurement Uncertainty

The assessed measurement uncertainty to ensure 95% confidence level for the normal distribution is with the coverage factor  $k = 1.96$ ,  $U=0.684\text{dB}$ .



Test Result:

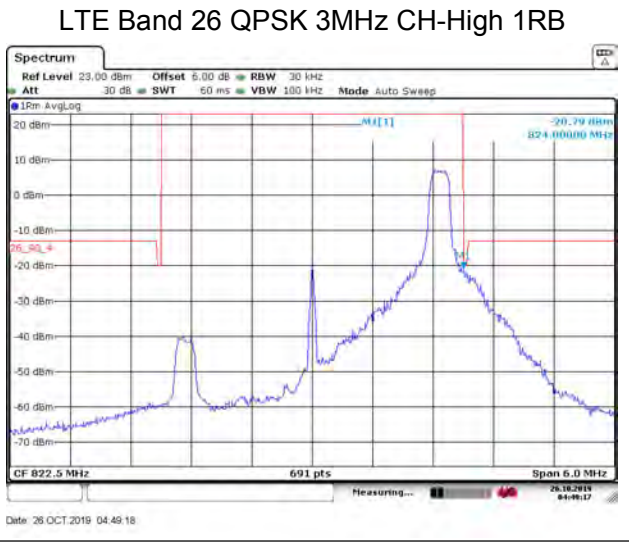
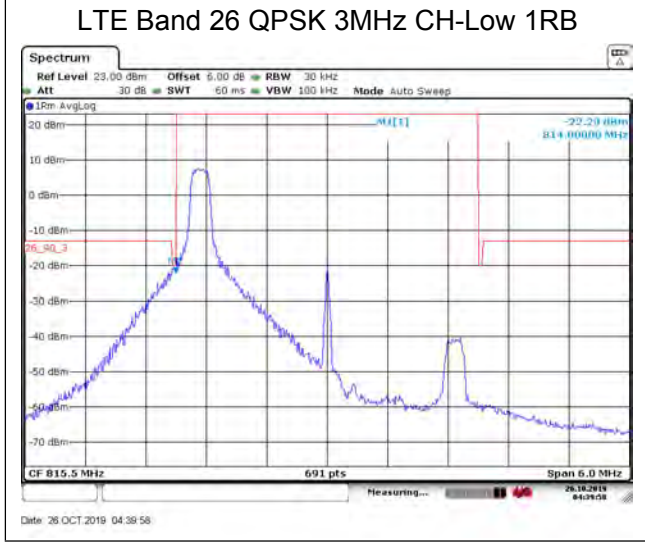
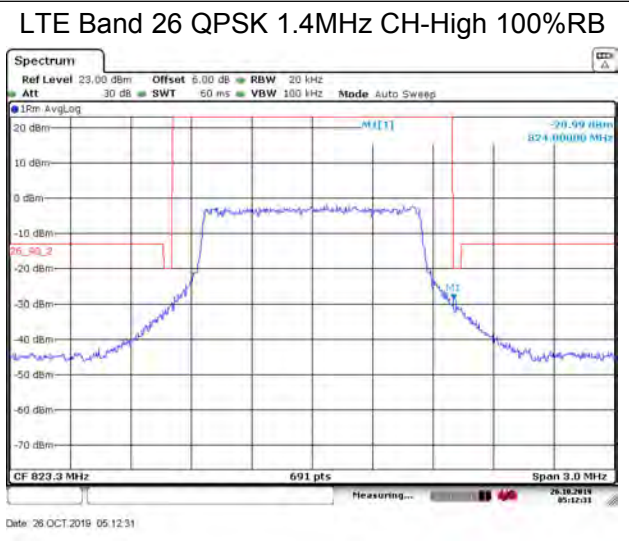
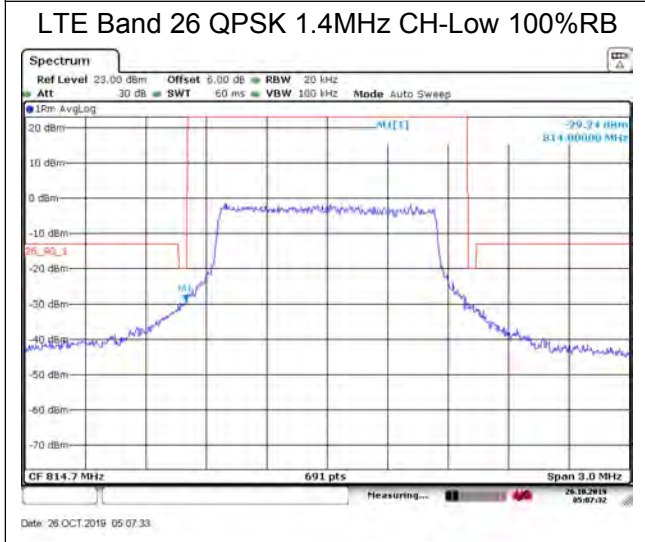
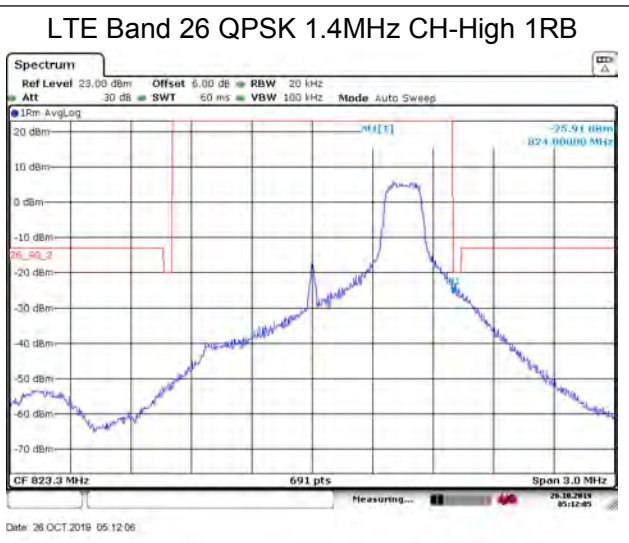
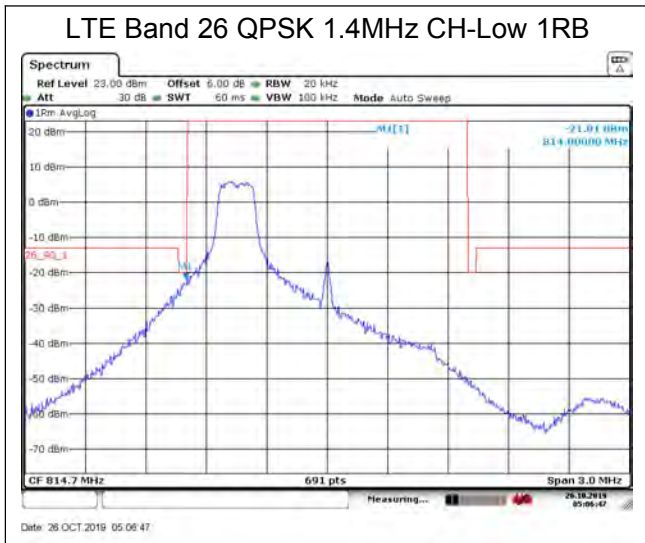





LTE Band 26 QPSK 3MHz CH-Low 100%RB

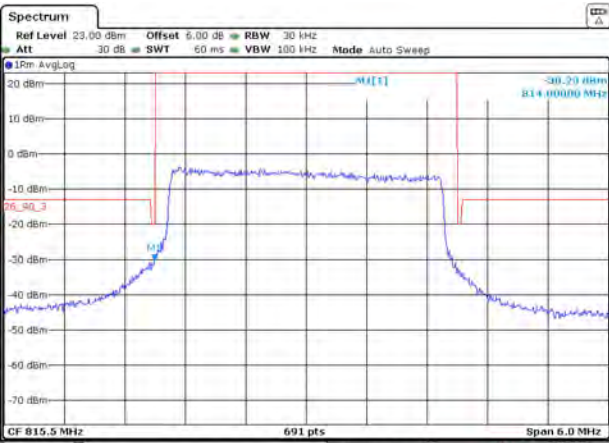

Date: 26 OCT 2019 04:42:49

LTE Band 26 QPSK 3MHz CH-High 100%RB

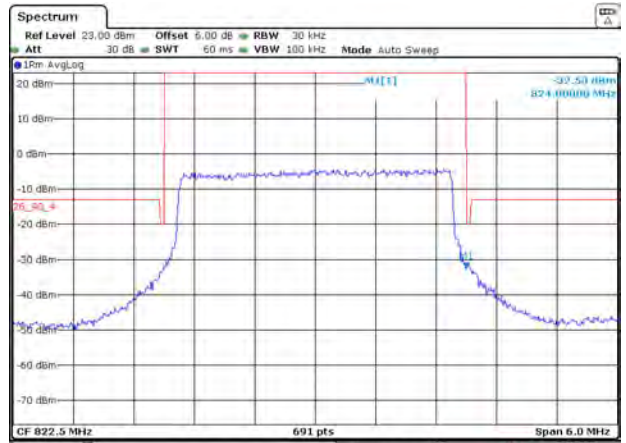

Date: 26 OCT 2019 04:50:17

LTE Band 26 QPSK 5MHz CH-Low 1RB

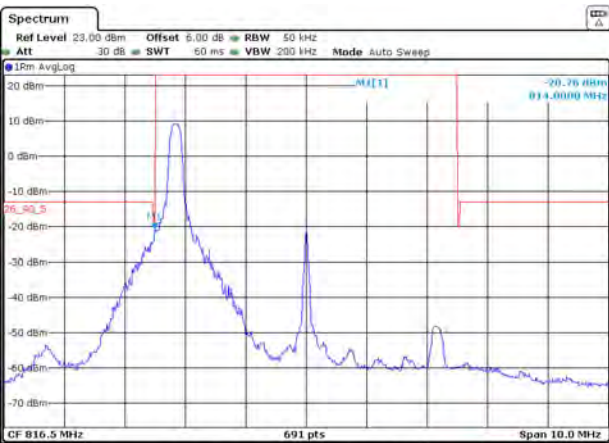

Date: 26 OCT 2019 04:55:45

LTE Band 26 QPSK 5MHz CH-High 1RB

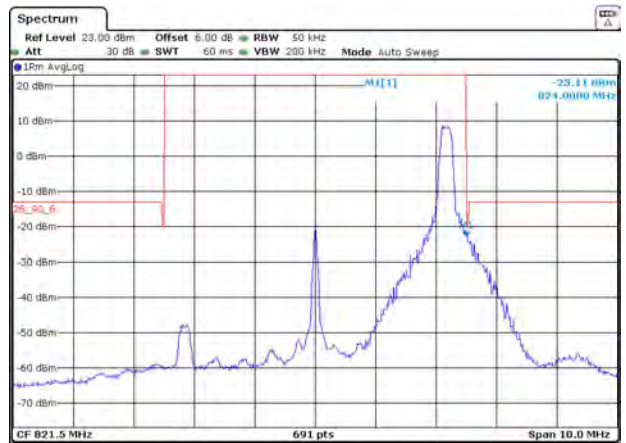

Date: 26 OCT 2019 05:01:17

LTE Band 26 QPSK 5MHz CH-Low 100%RB

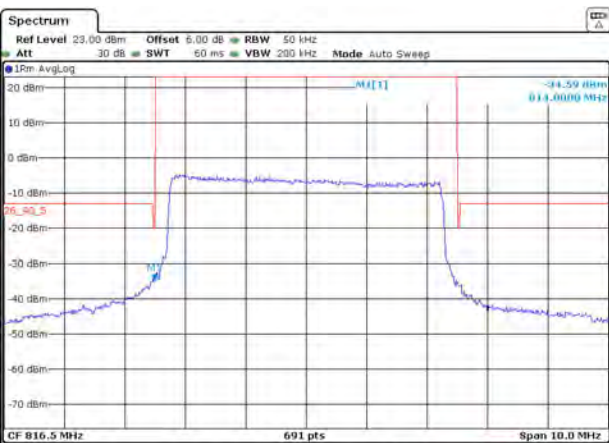

Date: 26 OCT 2019 04:56:10

LTE Band 26 QPSK 5MHz CH-High 100%RB

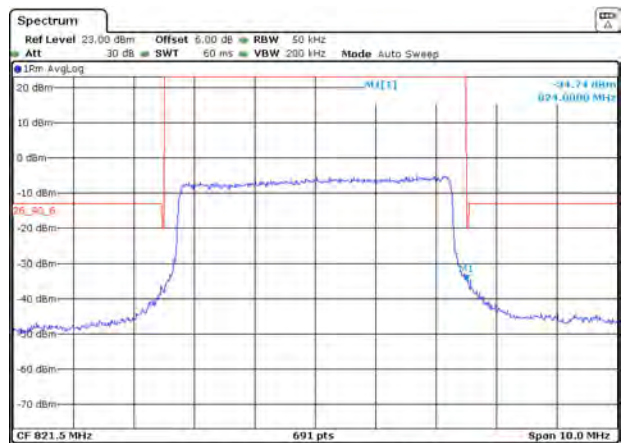

Date: 26 OCT 2019 05:01:35



LTE Band 26 QPSK 10MHz CH-Low 1RB

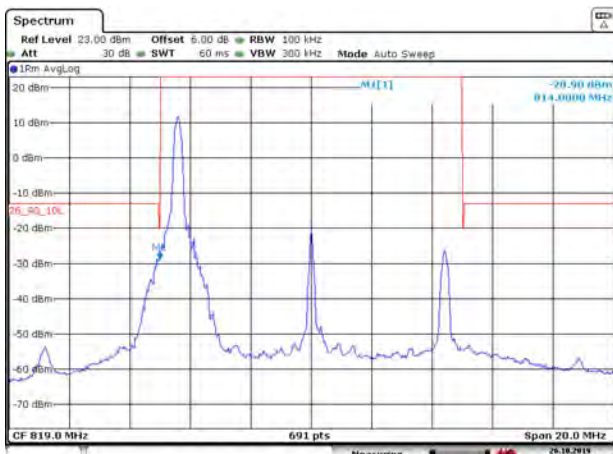

Date: 26 OCT 2019 05:22:47

LTE Band 26 QPSK 10MHz CH-High 1RB

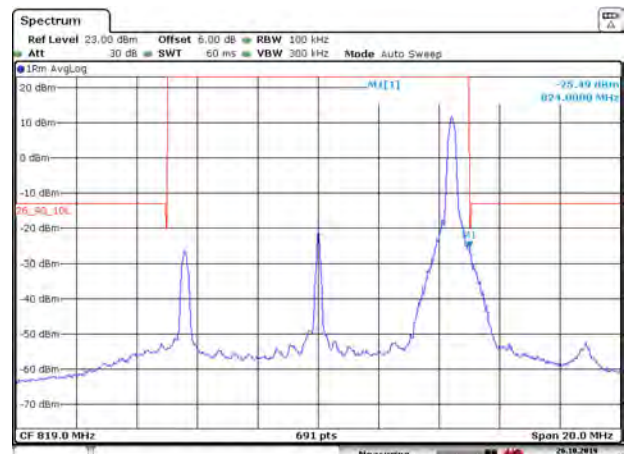

Date: 26 OCT 2019 05:24:32

LTE Band 26 QPSK 10MHz CH-Low 100%RB

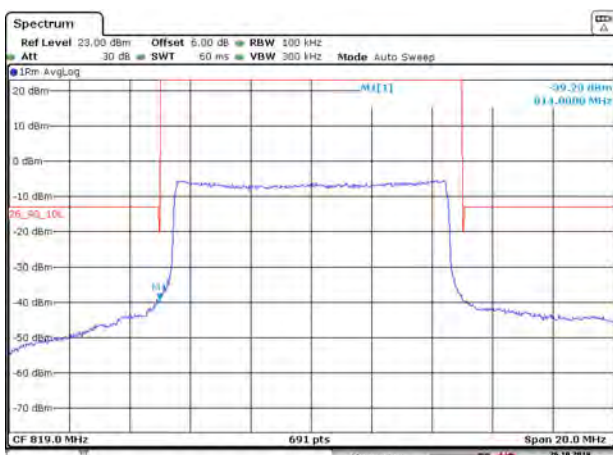

Date: 26 OCT 2019 05:23:05

LTE Band 26 QPSK 10MHz CH-High 100%RB

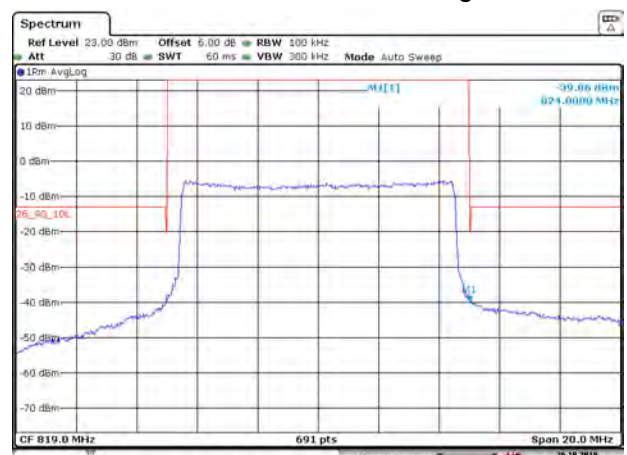

Date: 26 OCT 2019 05:24:47

LTE Band 26 16QAM 1.4MHz CH-Low 1RB

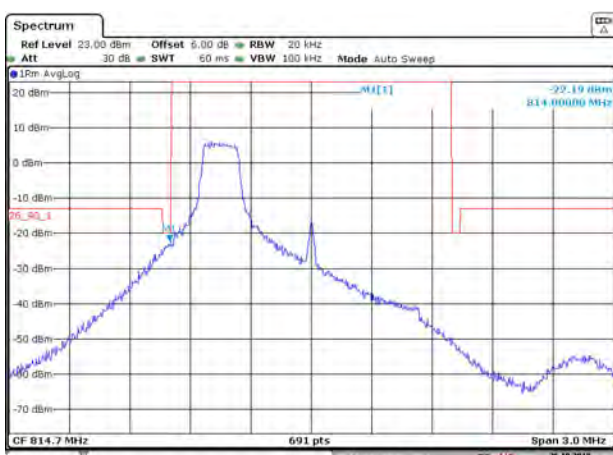

Date: 26 OCT 2019 05:07:52

LTE Band 26 16QAM 1.4MHz CH-High 1RB

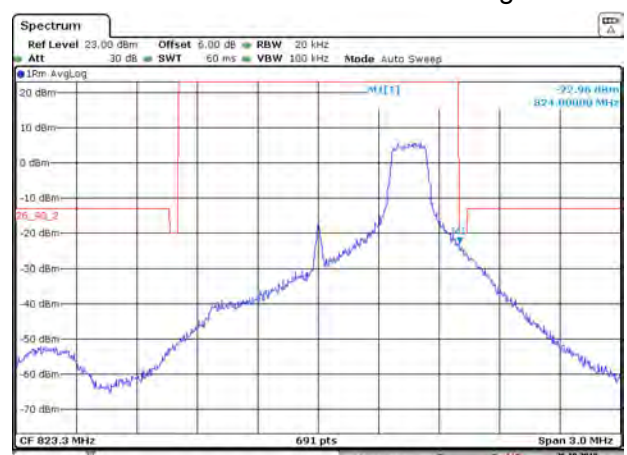

Date: 26 OCT 2019 05:12:47



LTE Band 26 16QAM 1.4MHz CH-Low 100%RB

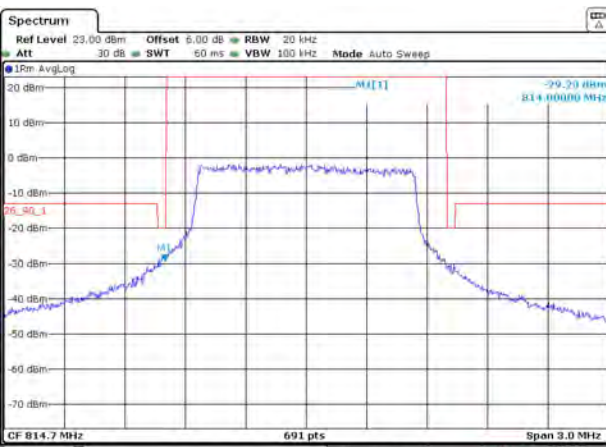

Date: 26 OCT 2019 05:08:15

LTE Band 26 16QAM 1.4MHz CH-High 100%RB

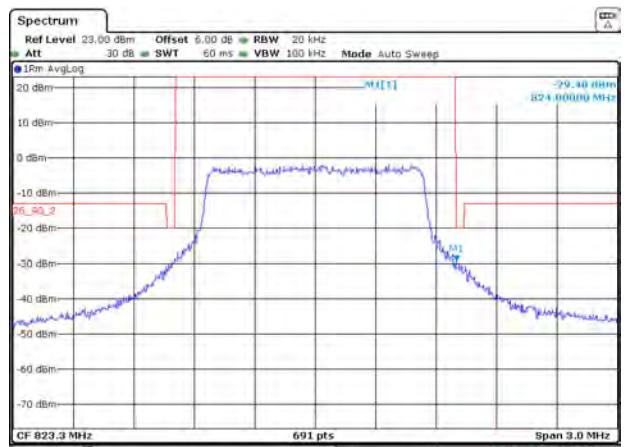

Date: 26 OCT 2019 05:13:03

LTE Band 26 16QAM 3MHz CH-Low 1RB

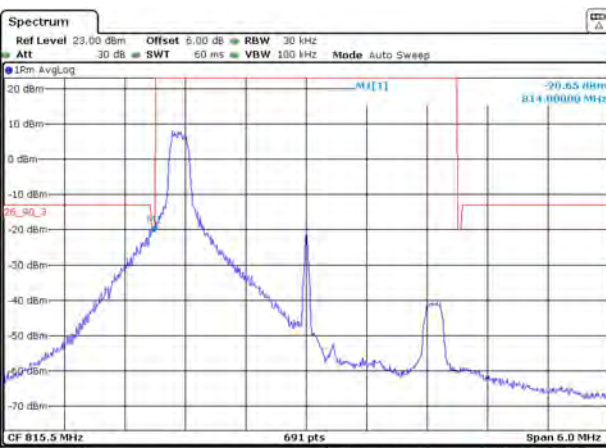

Date: 26 OCT 2019 04:43:13

LTE Band 26 16QAM 3MHz CH-High 1RB

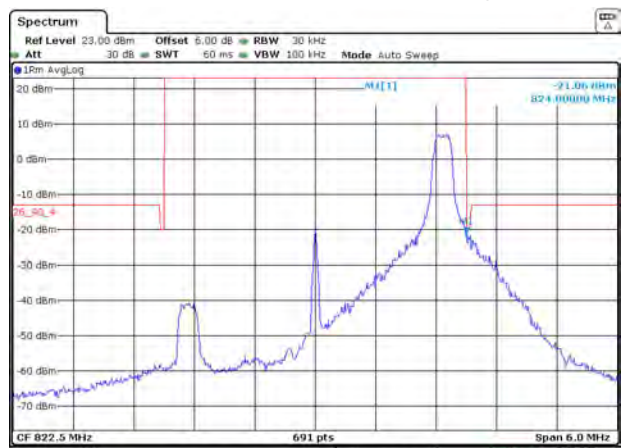

Date: 26 OCT 2019 04:50:41

LTE Band 26 16QAM 3MHz CH-Low 100%RB

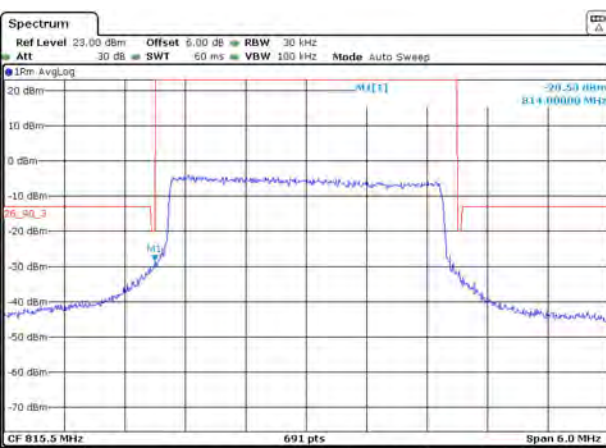

Date: 26 OCT 2019 04:44:48

LTE Band 26 16QAM 3MHz CH-High 100%RB



Date: 26 OCT 2019 04:51:20



LTE Band 26 16QAM 5MHz CH-Low 1RB

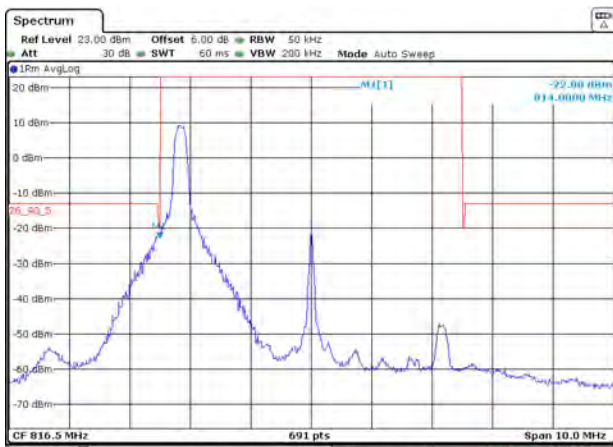

Date: 26 OCT 2019 04:56:28

LTE Band 26 16QAM 5MHz CH-High 1RB

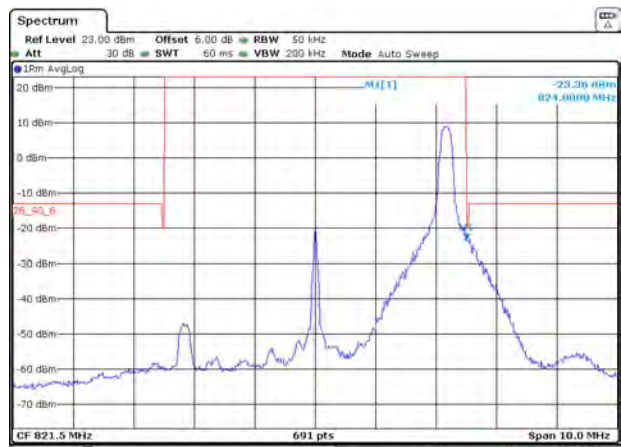

Date: 26 OCT 2019 05:01:54

LTE Band 26 16QAM 5MHz CH-Low 100%RB

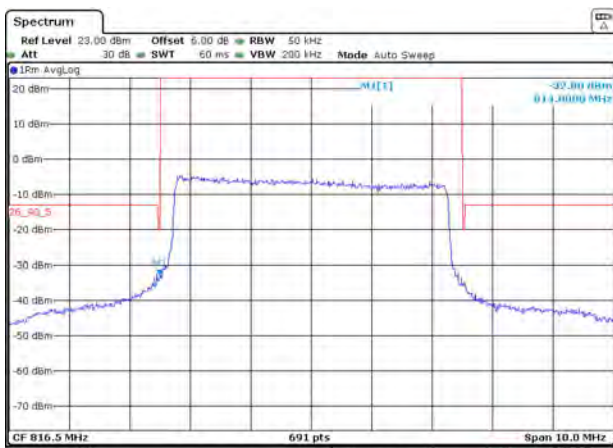

Date: 26 OCT 2019 04:56:47

LTE Band 26 16QAM 5MHz CH-High 100%RB

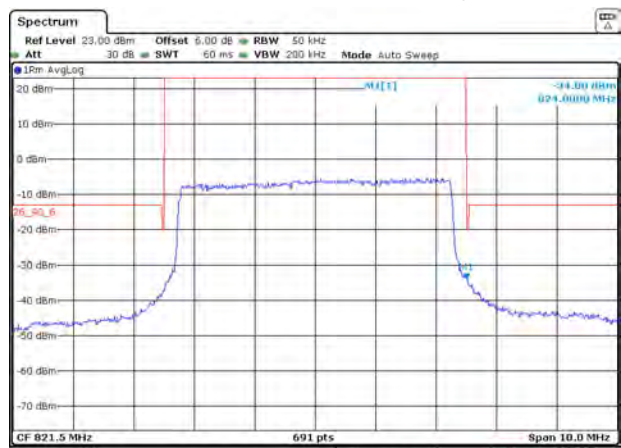

Date: 26 OCT 2019 05:02:11

LTE Band 26 16QAM 10MHz CH-Low 1RB

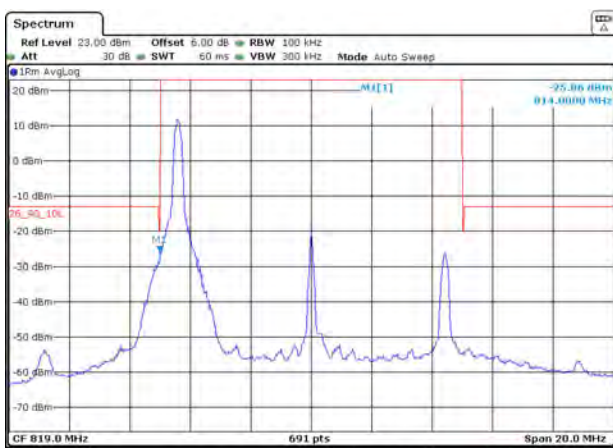

Date: 26 OCT 2019 05:23:26

LTE Band 26 16QAM 10MHz CH-High 1RB

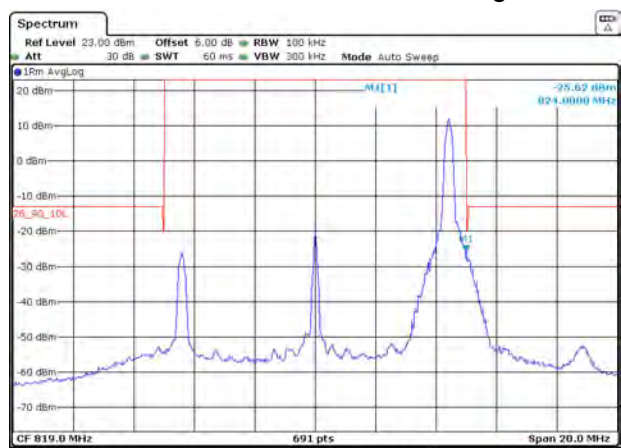

Date: 26 OCT 2019 05:25:02



LTE Band 26 16QAM 10MHz CH-Low 100%RB

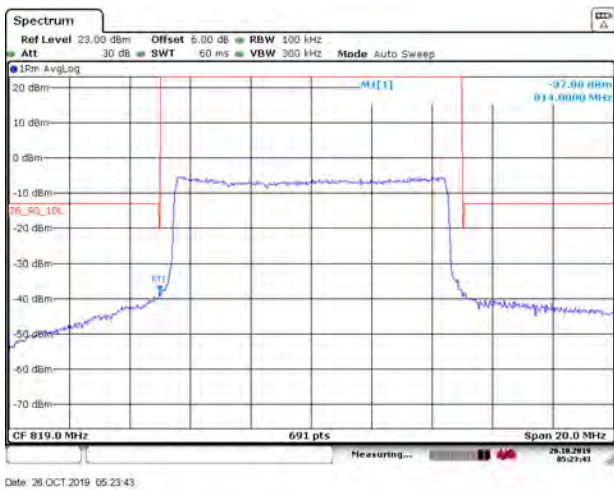

LTE Band 26 16QAM 10MHz CH-High 100%RB

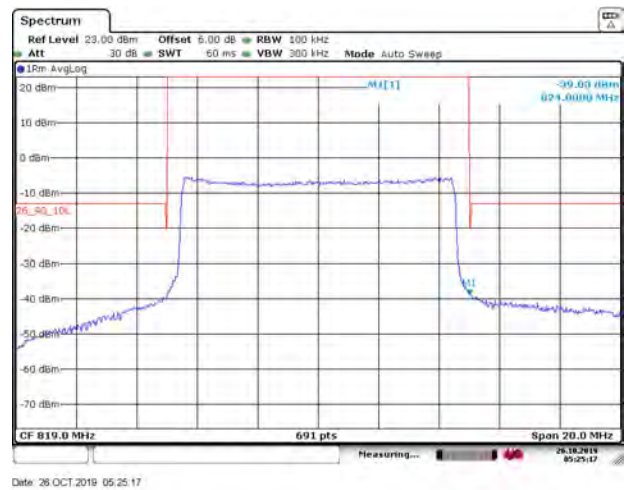

LTE Band 26 64QAM 1.4MHz CH-Low 1RB

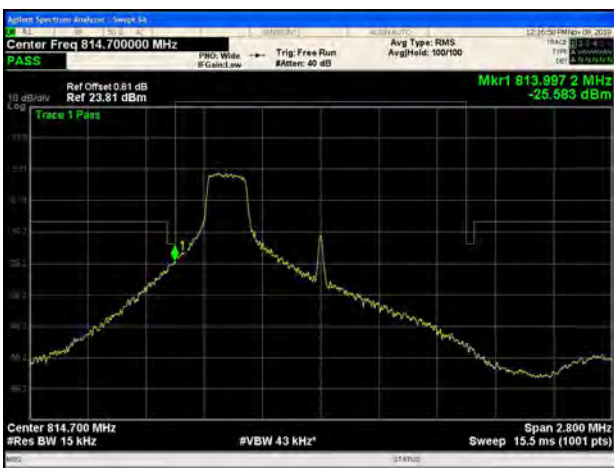

LTE Band 26 64QAM 1.4MHz CH-High 1RB

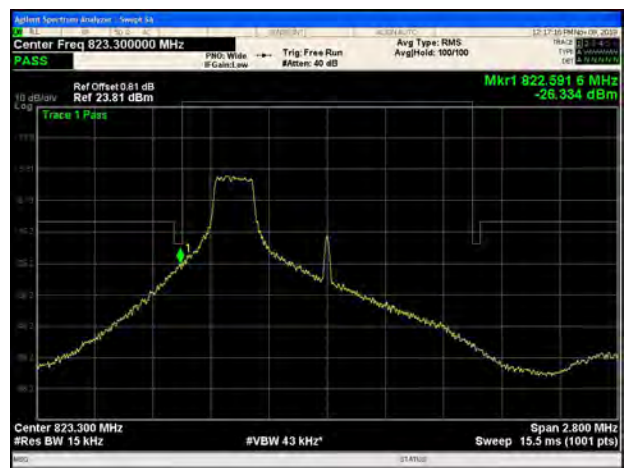

LTE Band 26 64QAM 1.4MHz CH-Low 100%RB

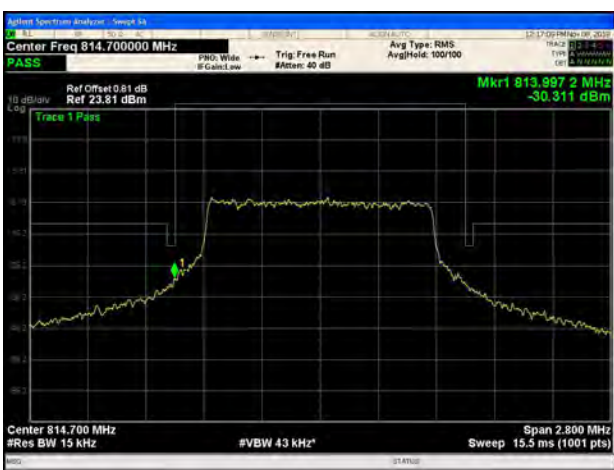

LTE Band 26 64QAM 1.4MHz CH-High 100%RB





LTE Band 26 64QAM 3MHz CH-Low 1RB

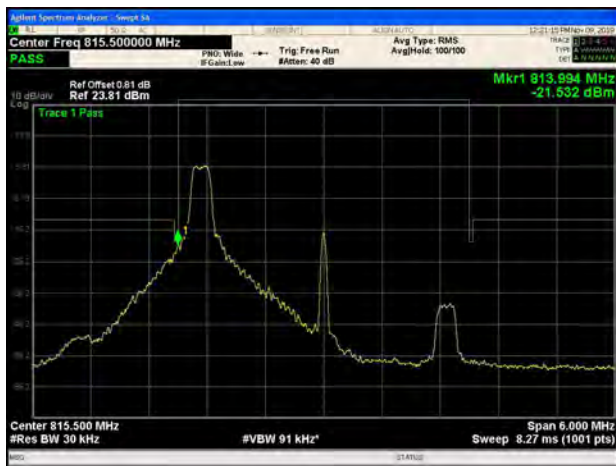

LTE Band 26 64QAM 3MHz CH-High 1RB

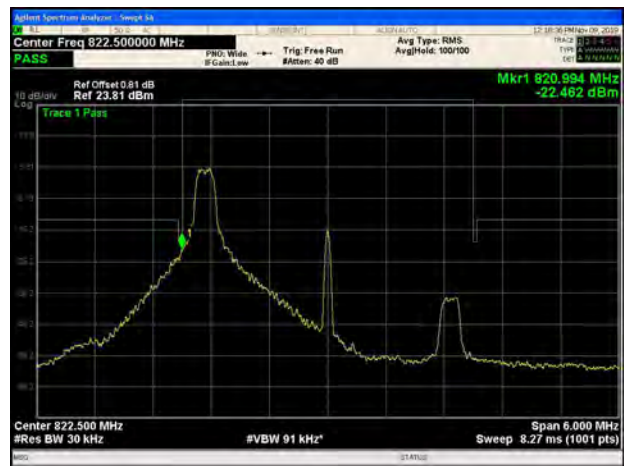

LTE Band 26 64QAM 3MHz CH-Low 100%RB

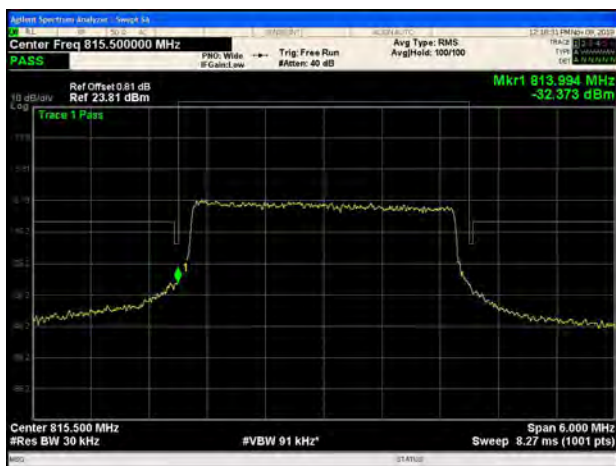

LTE Band 26 64QAM 3MHz CH-High 100%RB

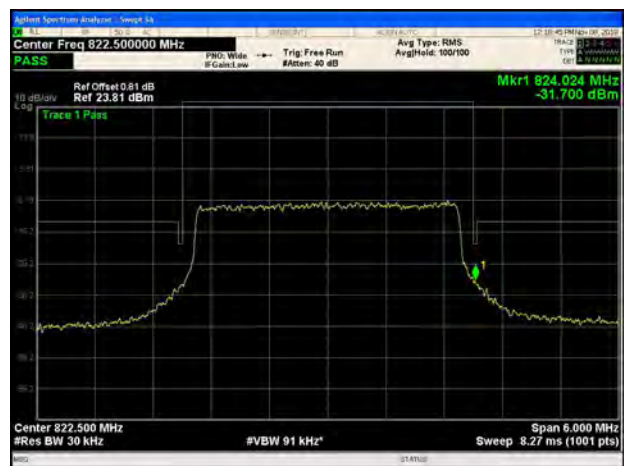

LTE Band 26 64QAM 5MHz CH-Low 1RB

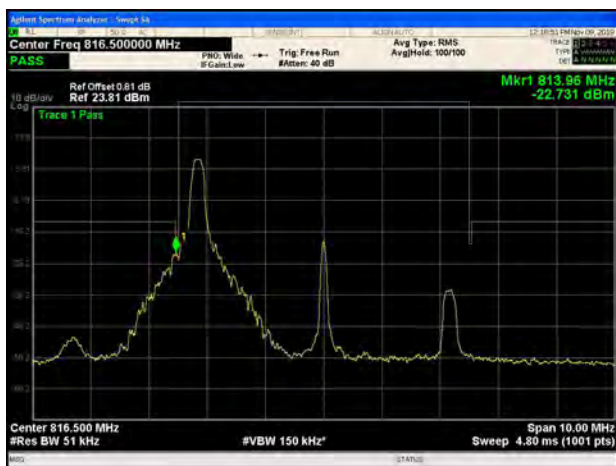

LTE Band 26 64QAM 5MHz CH-High 1RB

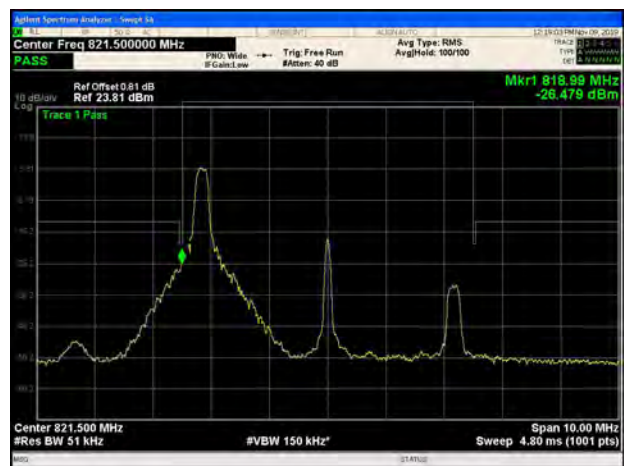



LTE Band 26 64QAM 5MHz CH-Low 100%RB

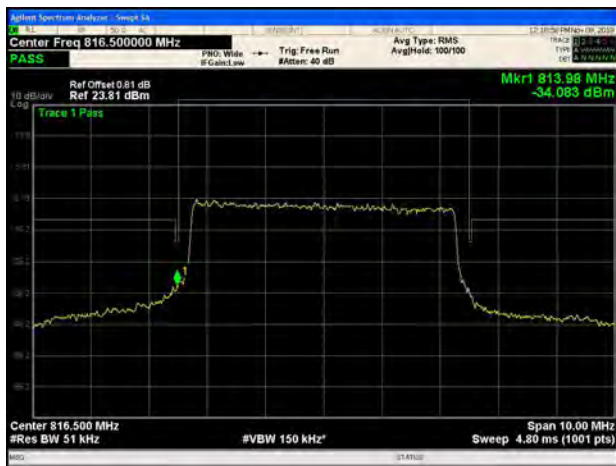

LTE Band 26 64QAM 5MHz CH-High 100%RB

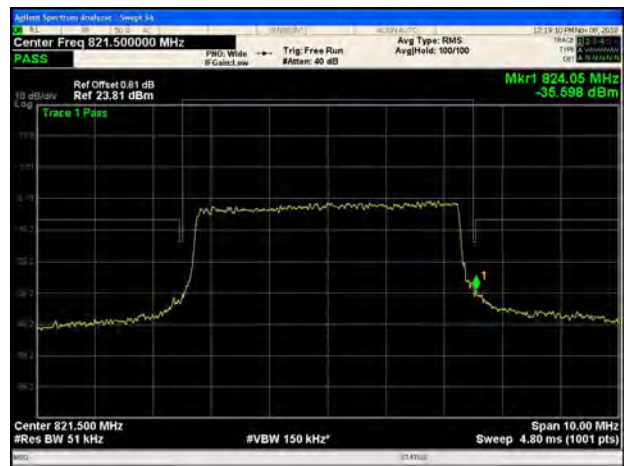

LTE Band 26 64QAM 10MHz CH-Middle 1RB

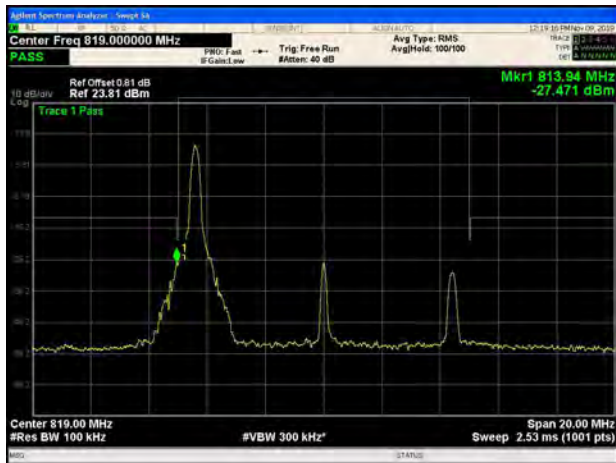

LTE Band 26 64QAM 10MHz CH-Middle 100%RB

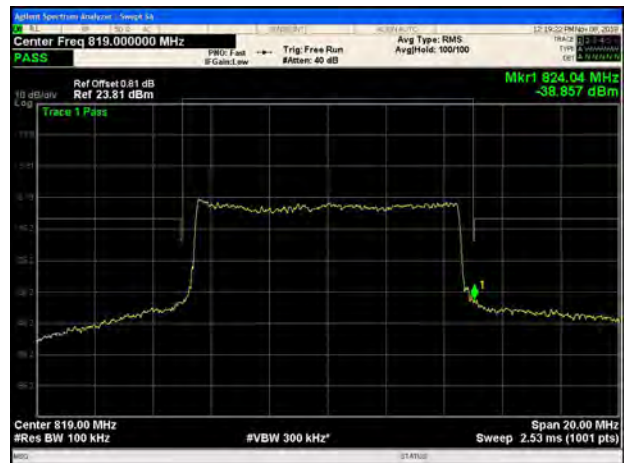

### 5.4. Peak-to-Average Power Ratio (PAPR)

#### Ambient condition

Temperature	Relative humidity
21°C ~25°C	40%~60%

#### Methods of Measurement

Measure the total peak power and record as PPK. And measure the total average power and record as PAvg. Both the peak and average power levels must be expressed in the same logarithmic units (e.g., dBm). Determine the PAPR from:

$$PAPR (dB) = PPK (dBm) - PAvg (dBm).$$

#### Test Setup

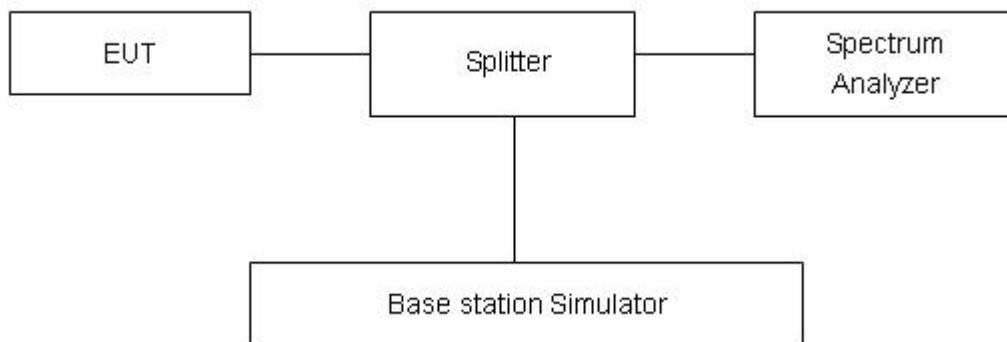

#### Limits

In measuring transmissions in this band using an average power technique, the peak-to-average ratio (PAR) of the transmission may not exceed 13 dB in 24.232(d).

#### Measurement Uncertainty

The assessed measurement uncertainty to ensure 95% confidence level for the normal distribution is with the coverage factor  $k = 2$ ,  $U = 0.4$  dB.





## Test Results

LTE Band 26							
RB	Modulation	Bandwidth (MHz)	Channel	Peak	Avg	PAPR	
100%	QPSK	1.4M	L	21.12	15.66	5.46	
			M	18.49	12.89	5.60	
			H	21.00	15.20	5.80	
		3M	L	20.54	15.03	5.51	
			M	18.63	12.99	5.64	
			H	20.39	14.68	5.71	
		5M	L	19.68	14.01	5.67	
			M	18.42	12.77	5.65	
			H	19.28	13.53	5.75	
		10M	M	19.43	13.57	5.86	
		16QAM	1.4M	L	21.98	15.70	6.28
				M	19.12	12.88	6.24
	H			21.68	15.23	6.45	
	3M		L	21.13	15.03	6.10	
			M	19.32	12.99	6.33	
			H	21.17	14.71	6.46	
	5M		L	20.17	14.01	6.16	
			M	18.92	12.77	6.15	
			H	19.87	13.53	6.34	
	10M		M	20.11	13.66	6.45	
	64QAM		1.4M	L	25.93	20.31	5.62
				M	24.12	17.95	6.17
		H		26.16	20.55	5.61	
		3M	L	24.03	17.90	6.13	
			M	24.06	17.93	6.13	
			H	26.04	20.20	5.84	
		5M	L	25.04	18.76	6.28	
			M	23.81	17.73	6.08	
			H	24.75	18.78	5.97	
		10M	M	25.14	18.85	6.29	

## 5.5. Frequency Stability

### Ambient condition

Temperature	Relative humidity
21°C ~25°C	40%~60%

### Method of Measurement

#### 1. Frequency Stability (Temperature Variation)

The temperature inside the climate chamber is varied from -40°C to +70°C in 10°C step size,

(1) With all power removed, the temperature was decreased to 0°C and permitted to stabilize for three hours.

(2) Measure the carrier frequency with the test equipment in a “call mode”. These measurements should be made within 1 minute of powering up the mobile station, to prevent significant self warming.

(3) Repeat the above measurements at 10°C increments from -40°C to +70°C. Allow at least 1.5 hours at each temperature, un-powered, before making measurements.

#### 2. Frequency Stability (Voltage Variation)

The frequency stability shall be measured with variation of primary supply voltage as follows:

(1) Vary primary supply voltage from 85 to 115 percent of the nominal value for other than hand carried battery equipment.

(2) For hand carried, battery powered equipment, reduce primary supply voltage to the battery-operating end point which shall be specified by the manufacturer.

This transceiver is specified to operate with an input voltage of between 3V and 3.6V, with a nominal voltage of 3.3V.

### Test setup

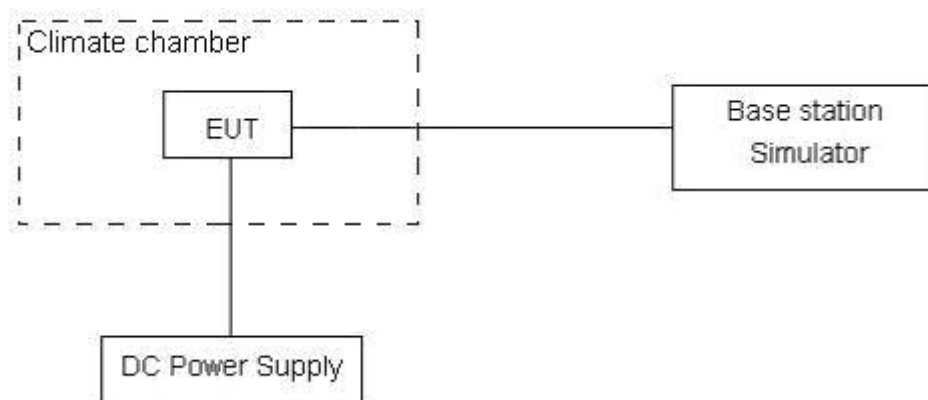

**Limits**

According to the Sec. 90.213.(a) Unless noted elsewhere, transmitters used in the services governed by this part must have a minimum frequency stability as specified in the following table.

Minimum Frequency Stability

[Parts per million (ppm)]

Frequency range (MHz)	Fixed and base stations	Mobile stations	
		Over 2 watts output power	2 watts or less output power
809-824	1.5	2.5	2.5

**Measurement Uncertainty**

The assessed measurement uncertainty to ensure 99.75% confidence level for the normal distribution is with the coverage factor  $k = 3, U = 0.01\text{ppm}$ .



## Test Result

LTE Band 26								
Condition		Freq. Error (Hz)	Freq. Error (Hz)	Freq. Error (Hz)	Frequency Stability (ppm)	Frequency Stability (ppm)	Frequency Stability (ppm)	Verdict
BANDWIDTH	1.4MHz	16QAM	QPSK	64QAM	16QAM	QPSK	64QAM	
Temperature	Voltage	16QAM	QPSK	64QAM	16QAM	QPSK	64QAM	
Normal (25°C)	Normal	1.25	5.28	9.71	0.00067	0.00281	0.00516	PASS
Extreme (70°C)		11.54	17.98	17.97	0.00614	0.00956	0.00956	PASS
Extreme (60°C)		3.86	16.01	2.16	0.00205	0.00852	0.00115	PASS
Extreme (50°C)		11.86	7.28	13.61	0.00631	0.00387	0.00724	PASS
Extreme (40°C)		8.38	2.76	7.71	0.00446	0.00147	0.00410	PASS
Extreme (30°C)		1.52	5.66	15.52	0.00081	0.00301	0.00826	PASS
Extreme (20°C)		10.05	5.82	4.98	0.00534	0.00309	0.00265	PASS
Extreme (10°C)		5.18	11.85	4.05	0.00276	0.00631	0.00216	PASS
Extreme (0°C)		16.67	7.24	8.31	0.00887	0.00385	0.00442	PASS
Extreme (-10°C)		5.95	14.22	16.50	0.00316	0.00756	0.00878	PASS
Extreme (-20°C)		9.47	4.17	17.50	0.00504	0.00222	0.00931	PASS
Extreme (-30°C)		13.90	5.59	14.25	0.00739	0.00297	0.00758	PASS
Extreme (-40°C)		9.39	1.43	6.58	0.00499	0.00076	0.00350	PASS
25°C		LV	2.58	8.14	8.04	0.00137	0.00433	0.00427
	HV	1.96	12.47	7.52	0.00104	0.00664	0.00400	PASS
Condition		Freq. Error (Hz)	Freq. Error (Hz)	Freq. Error (Hz)	Frequency Stability (ppm)	Frequency Stability (ppm)	Frequency Stability (ppm)	Verdict
BANDWIDTH	3MHz	16QAM	QPSK	64QAM	16QAM	QPSK	64QAM	
Temperature	Voltage	16QAM	QPSK	64QAM	16QAM	QPSK	64QAM	
Normal (25°C)	Normal	11.68	12.02	7.93	0.00621	0.00639	0.00422	PASS
Extreme (70°C)		11.62	5.13	3.34	0.00618	0.00273	0.00178	PASS
Extreme (60°C)		11.50	1.11	9.18	0.00612	0.00059	0.00488	PASS
Extreme (50°C)		7.39	2.05	16.62	0.00393	0.00109	0.00884	PASS
Extreme (40°C)		10.71	16.61	16.78	0.00570	0.00884	0.00892	PASS
Extreme (30°C)		2.17	1.28	16.54	0.00115	0.00068	0.00880	PASS
Extreme (20°C)		5.75	14.83	14.02	0.00306	0.00789	0.00746	PASS
Extreme (10°C)		12.43	5.98	14.58	0.00661	0.00318	0.00776	PASS
Extreme (0°C)		11.99	12.38	11.23	0.00638	0.00658	0.00597	PASS
Extreme (-10°C)		17.60	15.65	14.17	0.00936	0.00833	0.00753	PASS
Extreme (-20°C)		4.40	15.47	12.83	0.00234	0.00823	0.00683	PASS
Extreme (-30°C)		9.29	8.50	4.90	0.00494	0.00452	0.00261	PASS
Extreme (-40°C)		15.07	2.98	3.60	0.00802	0.00158	0.00192	PASS
25°C		LV	8.02	8.67	10.98	0.00427	0.00461	0.00584
	HV	10.99	8.51	6.54	0.00584	0.00453	0.00348	PASS



Condition		Freq. Error (Hz)	Freq. Error (Hz)	Freq. Error (Hz)	Frequency Stability (ppm)	Frequency Stability (ppm)	Frequency Stability (ppm)	Verdict
BANDWIDTH	5MHz	(Hz)	(Hz)	(Hz)	(ppm)	(ppm)	(ppm)	
Temperature	Voltage	16QAM	QPSK	64QAM	16QAM	QPSK	64QAM	
Normal (25°C)	Normal	11.31	12.25	9.68	0.00602	0.00652	0.00515	PASS
Extreme (70°C)		4.92	14.76	11.89	0.00262	0.00785	0.00633	PASS
Extreme (60°C)		13.21	9.44	11.44	0.00703	0.00502	0.00608	PASS
Extreme (50°C)		6.98	4.85	1.06	0.00371	0.00258	0.00056	PASS
Extreme (40°C)		2.13	16.08	16.81	0.00114	0.00855	0.00894	PASS
Extreme (30°C)		16.44	14.10	14.36	0.00874	0.00750	0.00764	PASS
Extreme (20°C)		9.18	15.66	4.88	0.00488	0.00833	0.00259	PASS
Extreme (10°C)		15.99	2.09	16.69	0.00850	0.00111	0.00888	PASS
Extreme (0°C)		12.29	7.44	10.91	0.00654	0.00395	0.00580	PASS
Extreme (-10°C)		11.72	12.09	8.99	0.00624	0.00643	0.00478	PASS
Extreme (-20°C)		9.56	2.29	17.80	0.00509	0.00122	0.00947	PASS
Extreme (-30°C)		17.15	12.09	3.07	0.00912	0.00643	0.00163	PASS
Extreme (-40°C)		11.76	17.92	14.63	0.00626	0.00953	0.00778	PASS
25°C	LV	12.49	5.41	14.81	0.00664	0.00288	0.00788	PASS
	HV	5.55	12.31	4.26	0.00295	0.00655	0.00226	PASS
Condition		Freq. Error (Hz)	Freq. Error (Hz)	Freq. Error (Hz)	Frequency Stability (ppm)	Frequency Stability (ppm)	Frequency Stability (ppm)	0.00515
BANDWIDTH	10MHz	(Hz)	(Hz)	(Hz)	(ppm)	(ppm)	(ppm)	
Temperature	Voltage	16QAM	QPSK	64QAM	16QAM	QPSK	64QAM	
Normal (25°C)	Normal	14.69	7.92	9.60	0.00782	0.00421	0.00511	PASS
Extreme (70°C)		1.89	2.55	3.19	0.00100	0.00136	0.00170	PASS
Extreme (60°C)		12.29	15.86	1.75	0.00653	0.00844	0.00093	PASS
Extreme (50°C)		15.88	15.09	15.24	0.00845	0.00803	0.00811	PASS
Extreme (40°C)		11.89	2.41	11.29	0.00632	0.00128	0.00601	PASS
Extreme (30°C)		5.39	1.64	2.44	0.00286	0.00087	0.00130	PASS
Extreme (20°C)		4.01	16.32	11.66	0.00213	0.00868	0.00620	PASS
Extreme (10°C)		7.53	1.99	9.04	0.00400	0.00106	0.00481	PASS
Extreme (0°C)		8.59	17.86	9.37	0.00457	0.00950	0.00499	PASS
Extreme (-10°C)		13.65	7.24	5.68	0.00726	0.00385	0.00302	PASS
Extreme (-20°C)		1.76	9.17	15.79	0.00094	0.00488	0.00840	PASS
Extreme (-30°C)		7.20	13.73	8.70	0.00383	0.00731	0.00463	PASS
Extreme (-40°C)		10.87	9.22	11.66	0.00578	0.00490	0.00620	PASS
25°C	LV	4.99	17.19	17.38	0.00265	0.00915	0.00925	PASS
	HV	13.93	10.50	4.80	0.00741	0.00558	0.00255	PASS

## 5.6. Spurious Emissions at Antenna Terminals

### Ambient condition

Temperature	Relative humidity
21°C ~25°C	40%~60%

### Method of Measurement

The EUT was connected to Spectrum Analyzer and Base Station Simulator via power Splitter. The measurement is carried out using a spectrum analyzer. The spectrum analyzer scans from 30MHz to the 10th harmonic of the carrier. The peak detector is used. RBW set to 100 kHz and VBW set to 300 kHz, Sweep is set to ATUO.

### Test setup

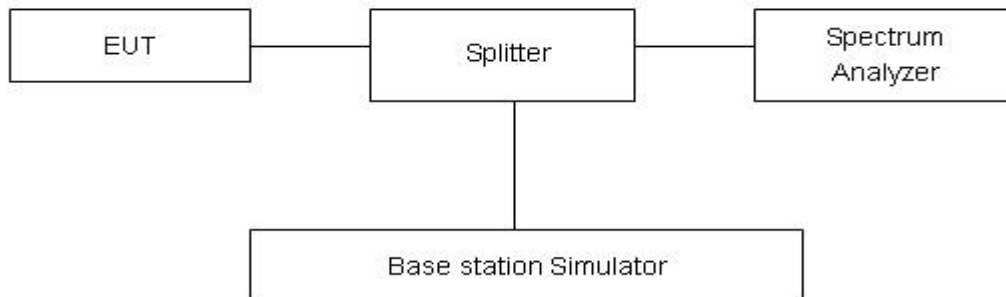

### Limits

Rule Part 90.691 specifies that “The power of any emission outside of the authorized operating frequency ranges must be attenuated below the transmitting power (P) by a factor of at least 43 + 10 log (P) dB.”

Limit	-13 dBm
-------	---------

### Measurement Uncertainty

The assessed measurement uncertainty to ensure 99.75% confidence level for the normal distribution is with the coverage factor  $k = 1.96$ .

Frequency	Uncertainty
100kHz-1GHz	0.684 dB
1GHz-12.75GHz	1.407 dB



### Test Result

If disturbances were found more than 20dB below limit line, the mark is not required for the EUT. The signal beyond the limit is carrier.

#### LTE Band 26 1.4MHz CH-Low 9kHz~1GHz

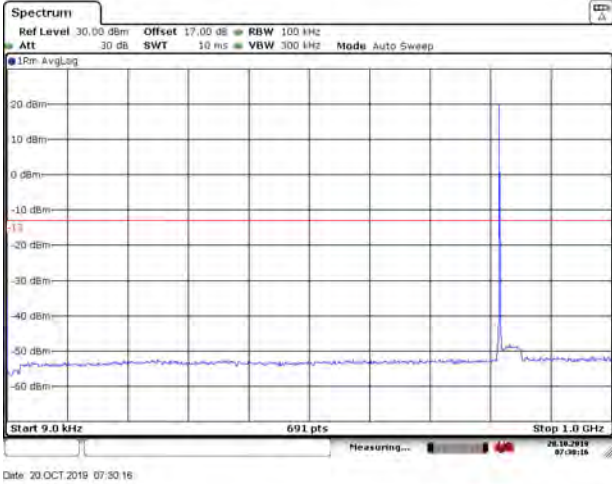

#### LTE Band 26 1.4MHz CH-Low 1GHz~9GHz

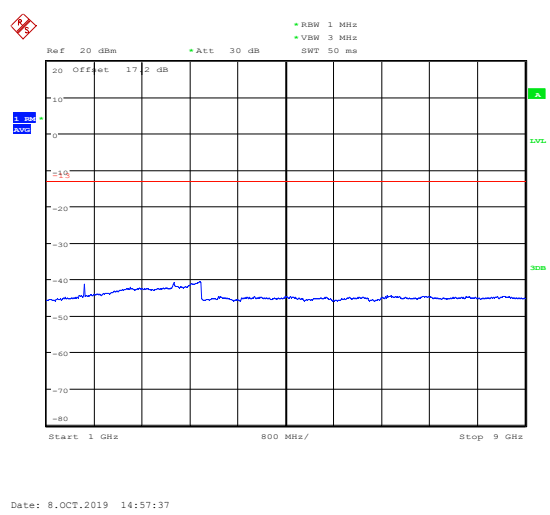

#### LTE Band 26 1.4MHz CH-Middle 9kHz~1GHz

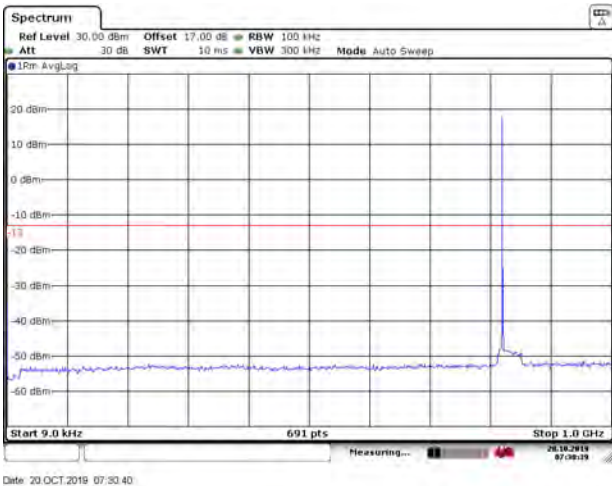

#### LTE Band 26 1.4MHz CH-Middle 1GHz~9GHz

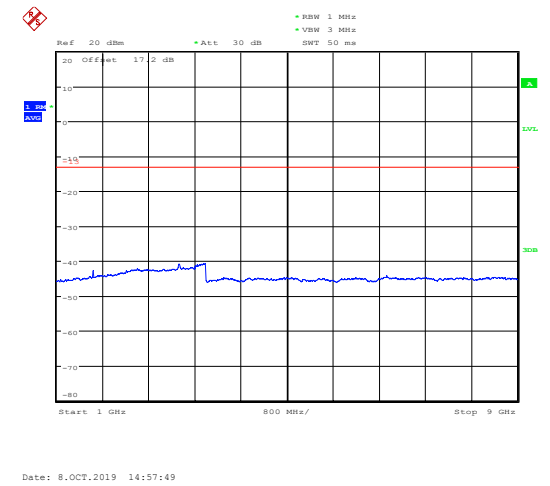

#### LTE Band 26 1.4MHz CH-High 9kHz~1GHz

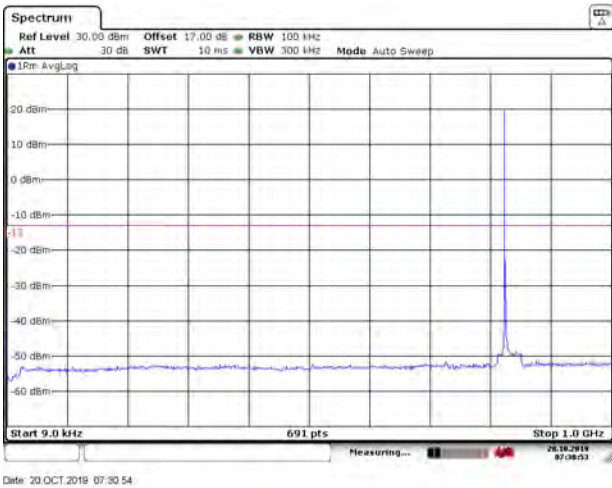

#### LTE Band 26 1.4MHz CH-High 1GHz~9GHz

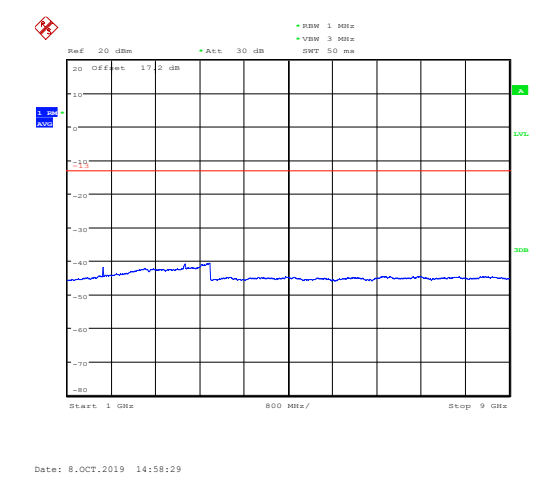



### LTE Band 26 3MHz CH-Low 9kHz~1GHz

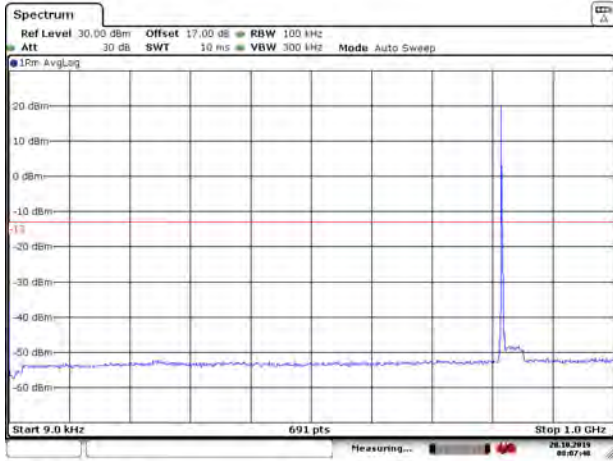

### LTE Band 26 3MHz CH-Low 1GHz~9GHz

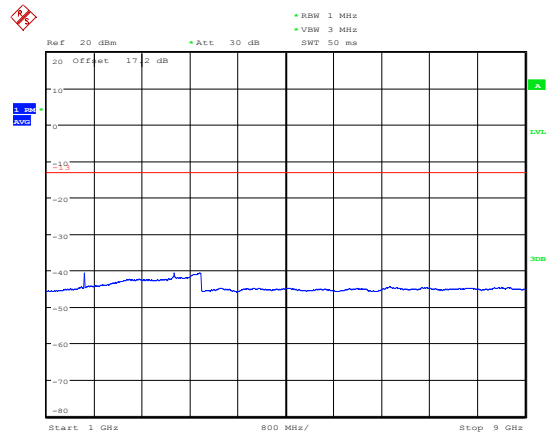

### LTE Band 26 3MHz CH-Middle 9kHz~1GHz

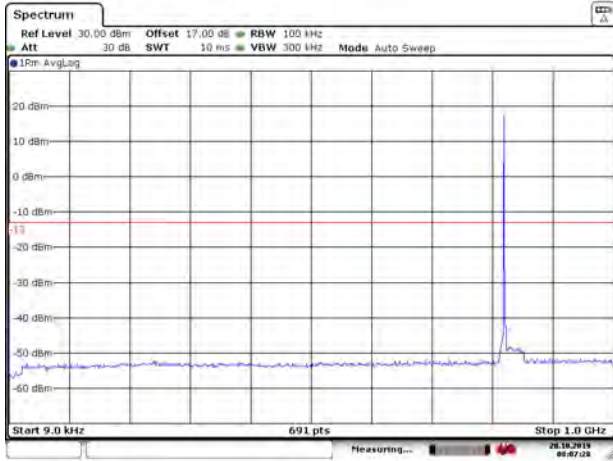

### LTE Band 26 3MHz CH-Middle 1GHz~9GHz

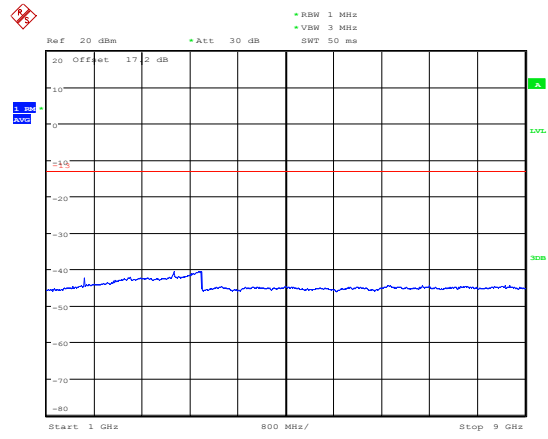

### LTE Band 26 3MHz CH-High 9kHz~1GHz

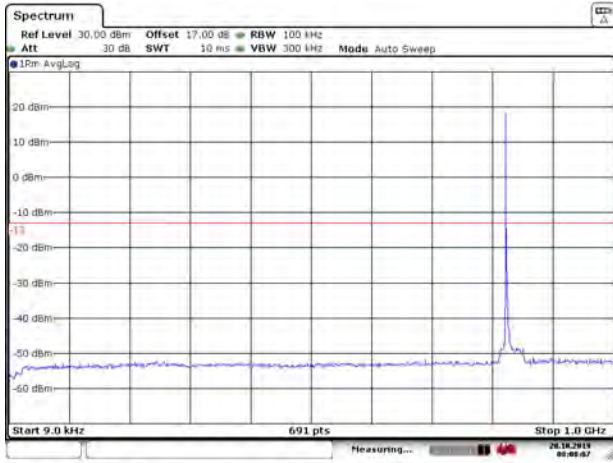

### LTE Band 26 3MHz CH-High 1GHz~9GHz

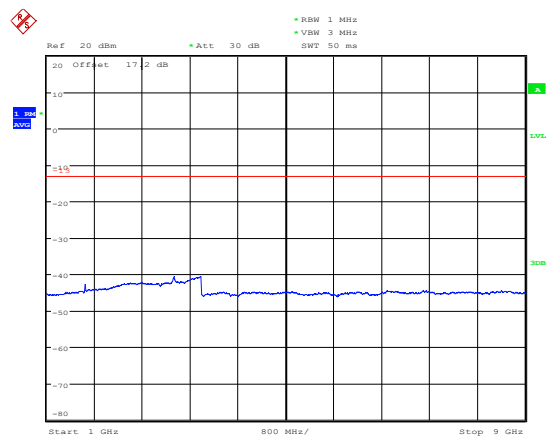





### LTE Band 26 5MHz CH-Low 9kHz~1GHz

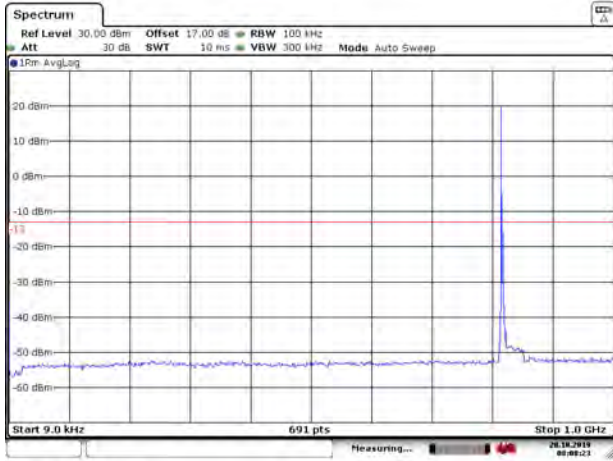

### LTE Band 26 5MHz CH-Low 1GHz~9GHz

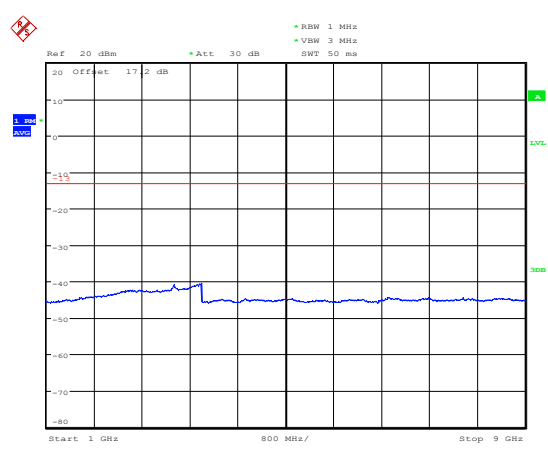

### LTE Band 26 5MHz CH-Middle 9kHz~1GHz

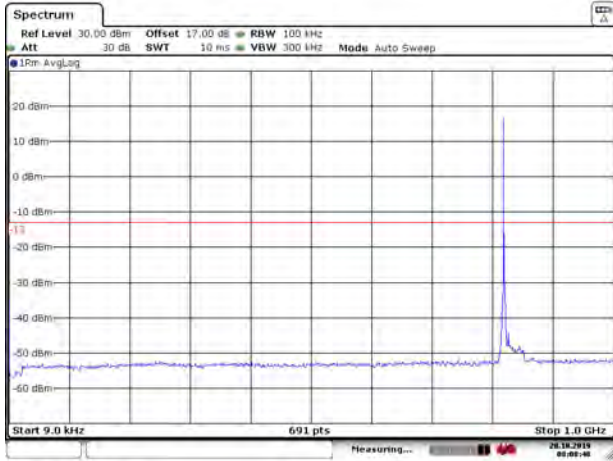

### LTE Band 26 5MHz CH-Middle 1GHz~9GHz

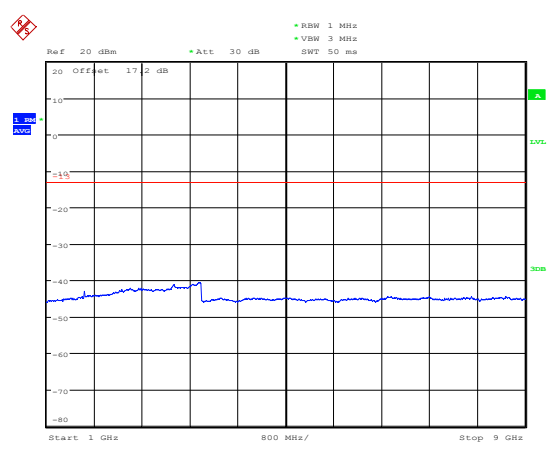

### LTE Band 26 5MHz CH-High 9kHz~1GHz

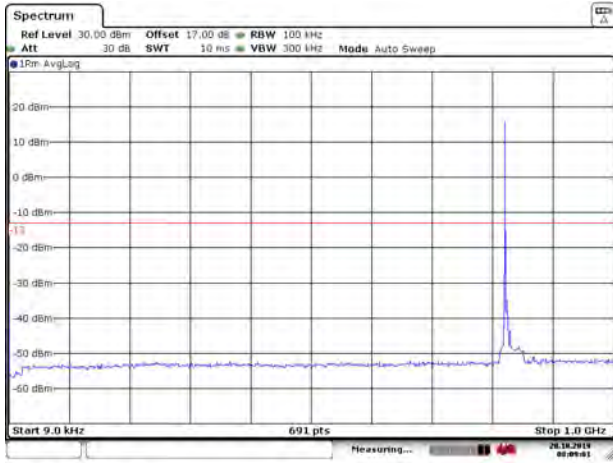

### LTE Band 26 5MHz CH-High 1GHz~9GHz

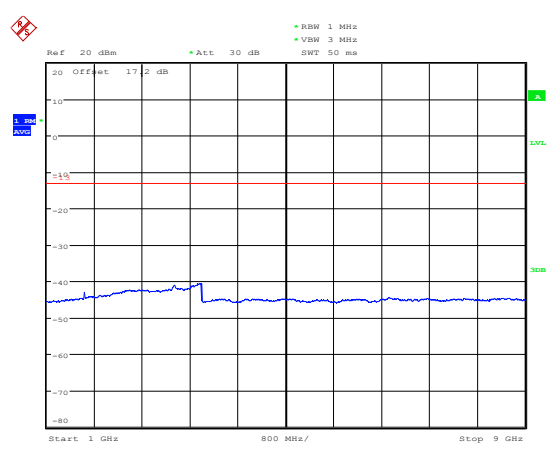



### LTE Band 26 10MHz CH-Middle 9kHz~1GHz

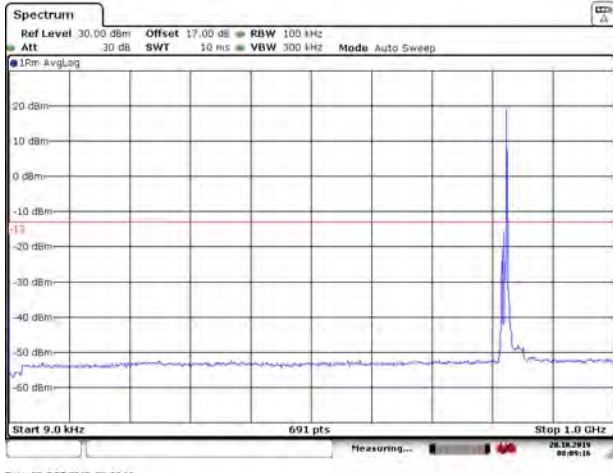

### LTE Band 26 10MHz CH-Middle 1GHz~9GHz

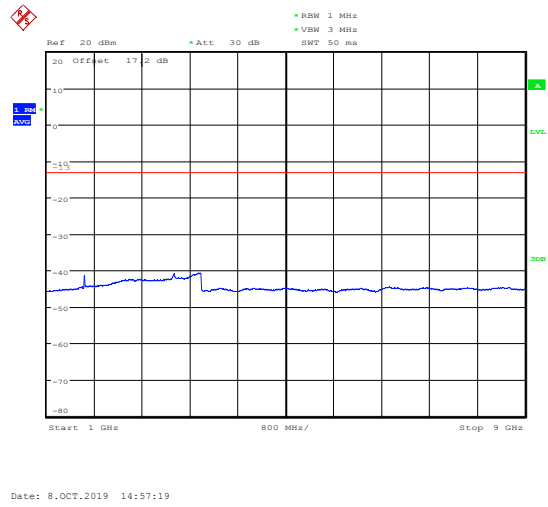



## 5.7. Radiates Spurious Emission

### Ambient condition

Temperature	Relative humidity
21°C ~25°C	40%~60%

### Method of Measurement

1. The testing follows FCC KDB 971168 v03r01 Section 5.8 and ANSI C63.26 (2015).
2. Below 1GHz: The EUT is placed on a turntable 0.8 meters above the ground in the chamber, 3 meter away from the antenna. The maximal emission value is acquired by adjusting the antenna height, polarisation and turntable azimuth. Normally, the height range of antenna is 1 m to 4 m, the azimuth range of turntable is 0° to 360°, and the receive antenna has two polarizations Vertical (V) and Horizontal (H). Above 1GHz: (Note: the FCC's permission to use 1.5m as an alternative per TCBC Conf call of Dec. 2, 2014.) The EUT is placed on a turntable 1.5 meters above the ground in the chamber, 3 meter away from the antenna. The maximal emission value is acquired by adjusting the antenna height, polarisation and turntable azimuth. Normally, the height range of antenna is 1 m to 4 m, the azimuth range of turntable is 0° to 360°, and the receive antenna has two polarizations Vertical (V) and Horizontal (H).
3. A loop antenna, A log-periodic antenna or horn antenna shall be substituted in place of the EUT. The log-periodic antenna will be driven by a signal generator and the level will be adjusted till the same power value on the spectrum analyzer or receiver. The level of the spurious emissions can be calculated through the level of the signal generator, cable loss, the gain of the substitution antenna and the reading of the spectrum analyzer or receiver.
4. The EUT is then put into continuously transmitting mode at its maximum power level during the test. Set Test Receiver or Spectrum RBW=200Hz,VBW=600Hz for 9kHz150kHz , RBW=10kHz, VBW=30kHz 150kHz-30MHz , RBW=100kHz,VBW=300kHz for 30MHz to 1GHz and RBW=1MHz, VBW=3MHz for above 1GHz, And the maximum value of the receiver should be recorded as (Pr).
5. The EUT shall be replaced by a substitution antenna. In the chamber, an substitution antenna for the frequency band of interest is placed at the reference point of the chamber. An RF Signal source for the frequency band of interest is connected to the substitution antenna with a cable that has been constructed to not interfere with the radiation pattern of the antenna. A power (PMea) is applied to the input of the substitution antenna, and adjust the level of the signal generator output until the value of the receiver reach the previously recorded (Pr). The power of signal source (PMea) is recorded. The test should be performed by rotating the test item and adjusting the receiving antenna polarization.
6. A amplifier should be connected to the Signal Source output port. And the cable should be connect between the Amplifier and the Substitution Antenna. The cable loss (Pcl) ,the Substitution Antenna Gain (Ga) and the Amplifier Gain (PAg) should be recorded after test.
7. The measurement results are obtained as described below:  
Power(EIRP)=PMea- PAg - Pcl + Ga  
The measurement results are amend as described below:  
Power(EIRP)=PMea- Pcl + Ga
8. This value is EIRP since the measurement is calibrated using an antenna of known gain (2.15 dBi)

and known input power. ERP can be calculated from EIRP by subtracting the gain of the dipole,  $ERP = EIRP - 2.15\text{dBi}$ .

The modulation mode and RB allocation refer to section 5.1, using the maximum output power configuration.

**Test setup**

**9KHz ~ 30MHz**

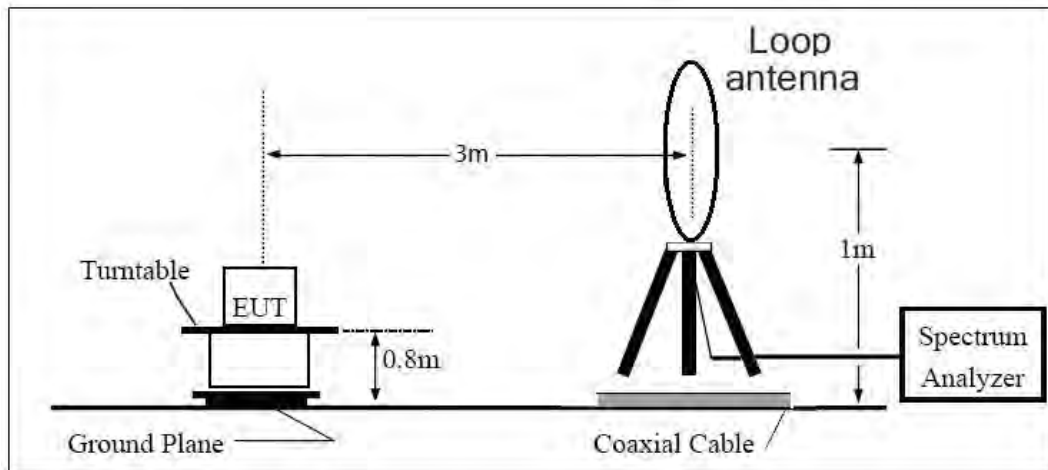

**30MHz ~ 1GHz**

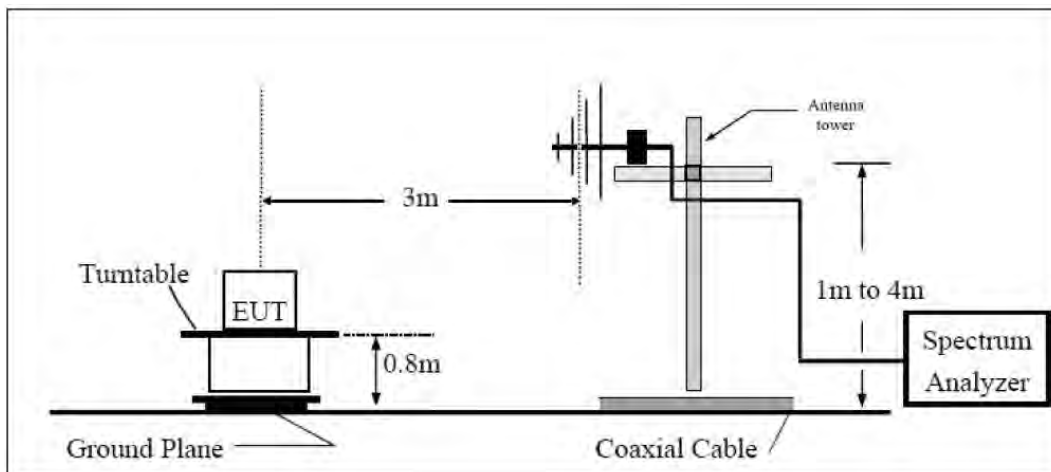

**Above 1GHz**

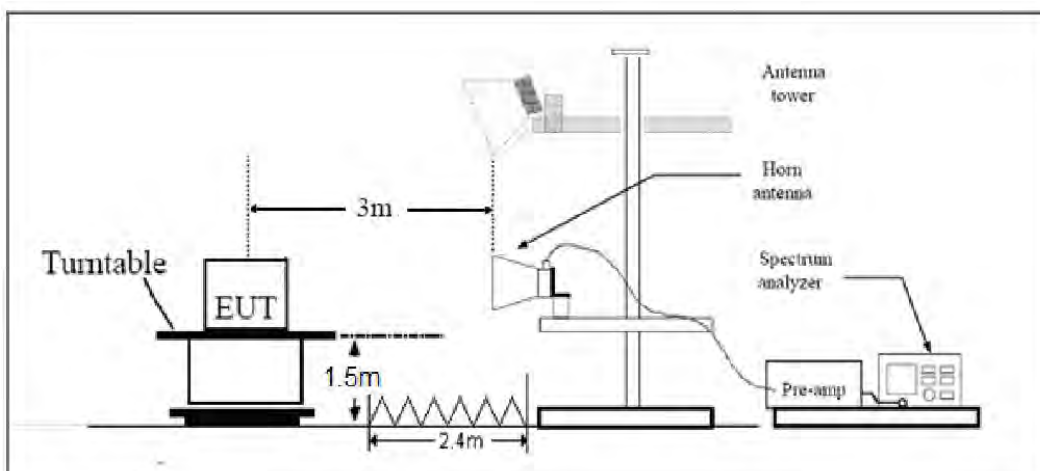

**Limits**

Rule Part 90.691 specifies that “The power of any emission outside of the authorized operating frequency ranges must be attenuated below the transmitting power (P) by a factor of at least  $43 + 10 \log(P)$  dB.”

Limit	-13 dBm
-------	---------

**Measurement Uncertainty**

The assessed measurement uncertainty to ensure 95% confidence level for the normal distribution is with the coverage factor  $k = 1.96$ ,  $U = 3.55$  dB.

**Test Result**

Sweep the whole frequency band through the range from 30MHz to the 10th harmonic of the carrier, the emissions below the noise floor will not be recorded in the report.

## LTE Band 26 1.4MHz CH Middle

Harmonic	Frequency (MHz)	SG (dBm)	Cable Loss (dB)	Gain (dBi)	Antenna Polarization	ERP Level (dBm)	Limit (dBm)	Margin (dB)	Azimuth (deg)
2	1636.88	-60.76	2.00	10.75	vertical	-54.16	-13.00	41.16	45
3	2455.69	-58.67	2.51	11.05	vertical	-52.28	-13.00	39.28	225
4	3726.0	-57.58	4.20	11.15	vertical	-52.78	-13.00	39.78	315
5	4095.0	-58.10	5.20	11.15	vertical	-54.30	-13.00	41.30	180
6	4914.0	-57.08	5.50	11.95	vertical	-52.78	-13.00	39.78	315
7	5733.0	-60.00	5.70	13.55	vertical	-54.30	-13.00	41.30	180
8	6552.0	-58.08	6.30	13.75	vertical	-52.78	-13.00	39.78	315
9	7371.05	-59.20	6.80	13.85	vertical	-54.30	-13.00	41.30	180
10	8190.0	-57.98	6.90	14.25	vertical	-52.78	-13.00	39.78	315

Note: 1.The other Spurious RF Radiated emissions level is no more than noise floor.  
2.The worst emission was found in the antenna is Horizontal position.

## LTE Band 26 5MHz CH Middle

Harmonic	Frequency (MHz)	SG (dBm)	Cable Loss (dB)	Gain (dBi)	Antenna Polarization	ERP Level (dBm)	Limit (dBm)	Margin (dB)	Azimuth (deg)
2	1633.69	-58.93	2.00	10.75	vertical	-52.33	-13.00	39.33	135
3	2450.63	-64.33	2.51	11.05	vertical	-57.94	-13.00	44.94	270
4	3276.0	-55.07	4.20	11.15	vertical	-50.27	-13.00	37.27	0
5	4095.0	-53.49	5.20	11.15	vertical	-49.69	-13.00	36.69	0
6	4914.0	-59.30	5.50	11.95	vertical	-55.00	-13.00	42.00	315
7	5733.0	-60.40	5.70	13.55	vertical	-54.70	-13.00	41.70	135
8	6552.0	-57.93	6.30	13.75	vertical	-52.63	-13.00	39.63	45
9	7371.0	-54.22	6.80	13.85	vertical	-49.32	-13.00	36.32	225
10	8190.0	-54.39	6.90	14.25	vertical	-49.19	-13.00	36.19	90

Note: 1.The other Spurious RF Radiated emissions level is no more than noise floor.  
2.The worst emission was found in the antenna is Horizontal position.



## LTE Band 26 10MHz CH Middle

Harmonic	Frequency (MHz)	SG (dBm)	Cable Loss (dB)	Gain (dBi)	Antenna Polarization	ERP Level (dBm)	Limit (dBm)	Margin (dB)	Azimuth (deg)
2	1629.19	c	2.00	10.75	vertical	-52.78	-13.00	39.78	315
3	2444.25	-60.69	2.51	11.05	vertical	-54.30	-13.00	41.30	180
4	3258.0	-56.72	4.20	11.15	vertical	-51.92	-13.00	38.92	180
5	4095.0	-54.24	5.20	11.15	vertical	-50.44	-13.00	37.44	225
6	4914.0	-60.32	5.50	11.95	vertical	-56.02	-13.00	43.02	90
7	5733.0	-60.61	5.70	13.55	vertical	-54.91	-13.00	41.91	315
8	6552.0	-57.64	6.30	13.75	vertical	-52.34	-13.00	39.34	45
9	7371.0	-54.15	6.80	13.85	vertical	-49.25	-13.00	36.25	135
10	8190.0	-54.57	6.90	14.25	vertical	-49.37	-13.00	36.37	0

Note: 1.The other Spurious RF Radiated emissions level is no more than noise floor.

2.The worst emission was found in the antenna is Horizontal position.



## 6. Main Test Instruments

Name	Manufacturer	Type	Serial Number	Calibration Date	Expiration Date
Base Station Simulator	R&S	CMW500	113824	2019-05-19	2020-05-18
Power Splitter	Hua Xiang	SHX-GF2-2-13	10120101	/	/
Spectrum Analyzer	Agilent	N9010A	MY50210259	2019-05-19	2020-05-18
Signal Analyzer	R&S	FSV30	100815	2019-12-16	2020-12-15
Trilog Antenna	SCHWARZBECK	VUBL 9163	01111	2019-09-12	2021-09-11
Horn Antenna	R&S	HF907	100126	2018-07-07	2020-07-06
Signal generator	R&S	SMF 100A	102235	2019-05-19	2020-05-18
Climatic Chamber	ESPEC	SU-242	93000506	2017-12-17	2020-12-16
RF Cable	Agilent	SMA 15cm	0001	2019-06-14	2020-06-13
Software	R&S	EMC32	9.26.0	/	/

\*\*\*\*\*END OF REPORT \*\*\*\*\*