

天线规格书-测试报告

Antenna Specification – Test Report

一、天线概要 Antenna overview:

公司名字 Company name	飞腾云科技有限公司
公司地址 Company address	深圳市光明区松柏路 7002 号埃迪蒙托工业园 c 栋 6 楼
产品名称 Product name	FTN1901BU-5221CV05U
产品型号 Product model	BP-2045A0
产品类型 Product type	WIFI 天线 WIFI antenna
适用频率 Applicable frequency	2400Mhz-2500Mhz 5150-5850Mhz
最大增益 maximumGain	3.56dBi@2400 ~ 2500 MHz 3.90dBi@5150 ~ 5850MHz
极化 Polarization	水平极化
方位波束图 Azimuth Beam Pattern	
抗阻 Impedance	50±100hm

二、天线尺寸 Antenna size:

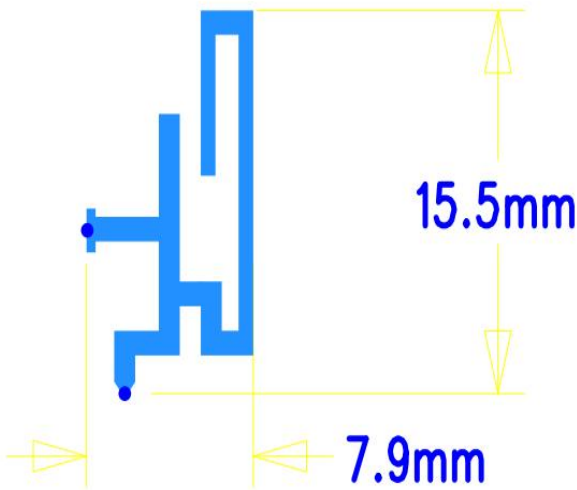
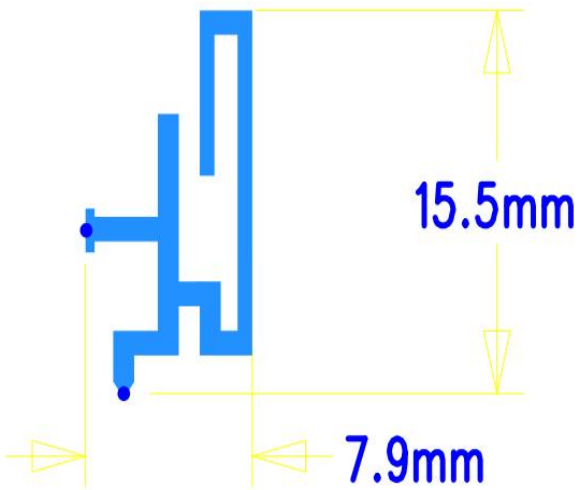
	
外观尺寸 Appearance size	内芯尺寸 Core size

三、2D 测试图 2D test diagram:

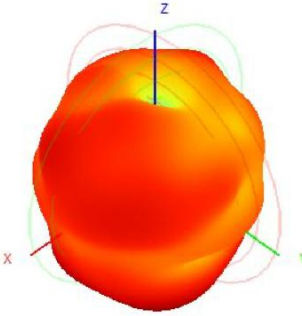
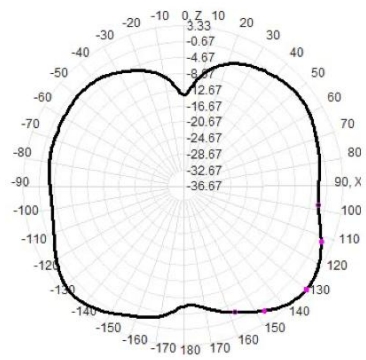
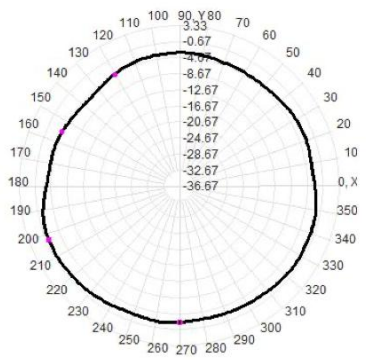
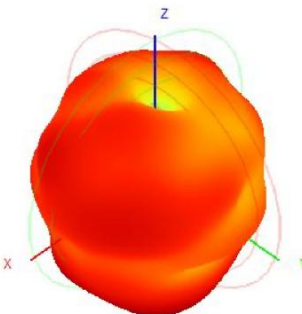
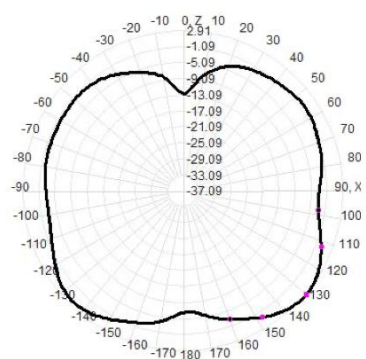
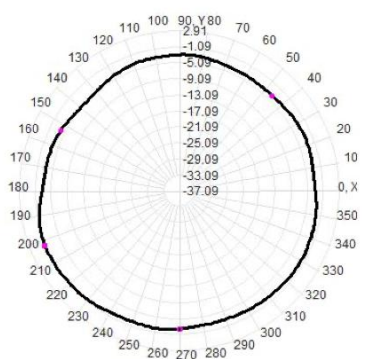
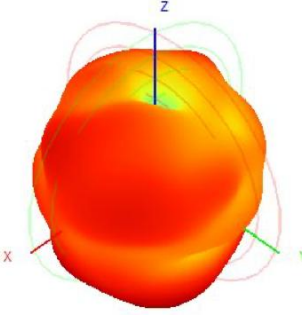
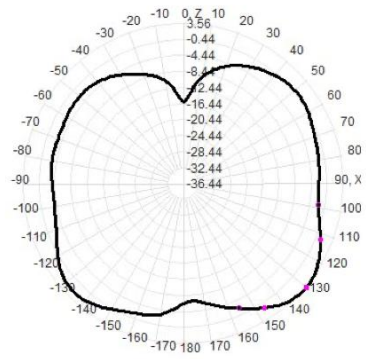
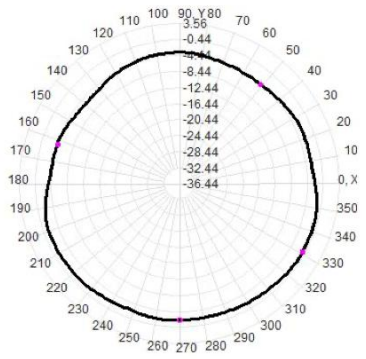
频点 Frequency point	2400Mhz-2500Mhz		
方向 Directions	水平极化		
最大功率 Maximum power	4.0±1dBi		
刻度大小 Scale size			
			
2.4G	Gain(Peak):3.33dBi	Efficiency:61.5%	
			
2.45G	Gain(Peak):2.91dBi	Efficiency:60.8%	
			
2.5G	Gain(Peak):3.56dBi	Efficiency:63.4%	
测试图 Test diagram			

频点 Frequency point	5150Mhz-5850Mhz
方向 Directions	水平极化
最大功率 Maximum power	4.0±1dBi
刻度大小 Scale size	4dbi

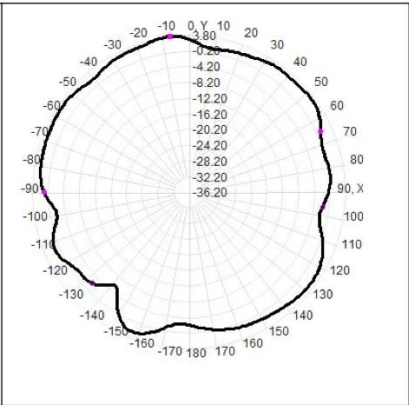
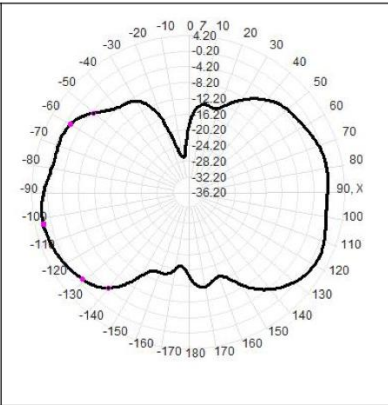
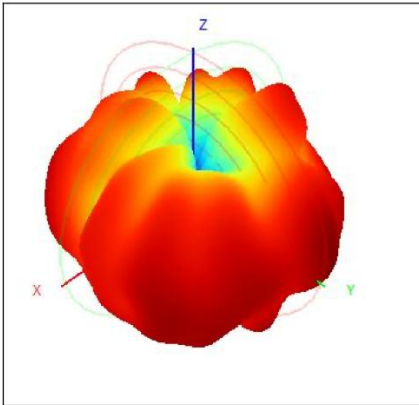

5.15G

Gain(Peak):3.8dBi

Efficiency:64.1%

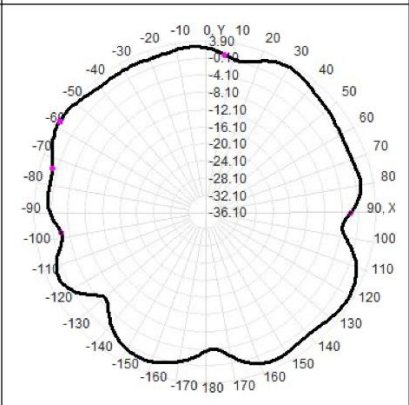
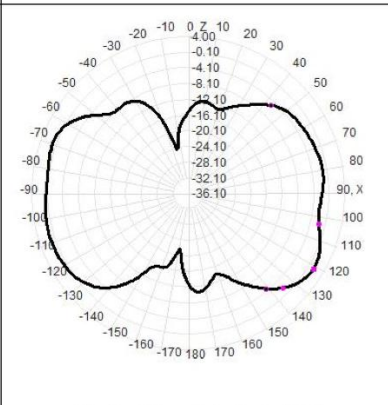
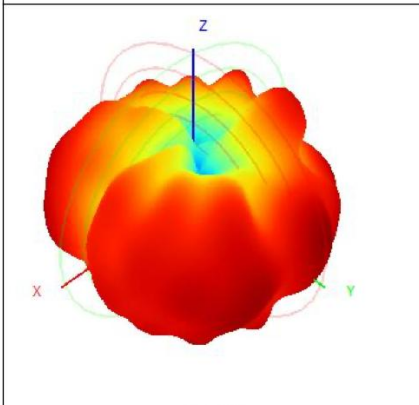

5.5G

Gain(Peak):3.9dBi

Efficiency65.2%

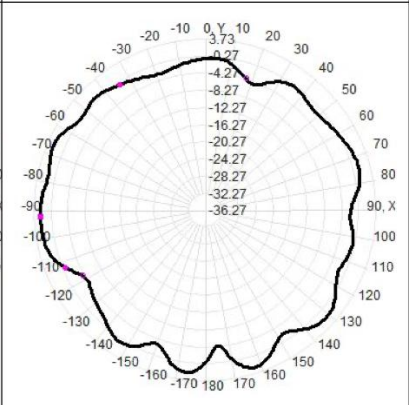
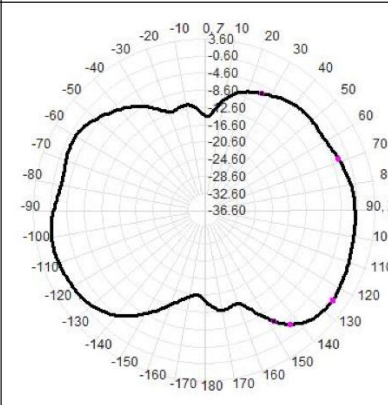
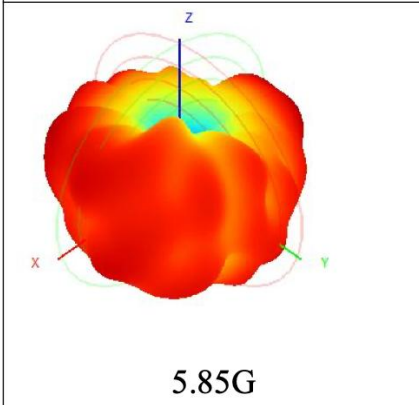

5.85G

Gain(Peak):3.4dBi

Efficiency:64.3%

测试图 Test diagram