



# TEST REPORT

## FCC PART 15.247

Report Reference No. ....: **CTL1908174031-WF01**

Compiled by: Happy Guo  
( position+printed name+signature) (File administrators)

Happy Guo

Tested by: Nice Nong  
( position+printed name+signature) (Test Engineer)

Nice Nong

Approved by: Ivan Xie  
( position+printed name+signature) (Manager)

Ivan Xie

Product Name.....: WiFi AP/CPE

Model/Type reference .....: WiFi AP/CPE-2458-3x3-AC

List Model(s).....: N/A

Trade Mark.....: Nodes

FCC ID.....: 2AU5Y-WIFIAP

Applicant's name .....: **Beijing Nodes Network Technology Co., Ltd.**

Address of applicant .....: Rm705, Shenzhou Building, No.31 Zhongguancun South Street,  
Haidian District, Beijing 100081 China

Test Firm .....: **Shenzhen CTL Testing Technology Co., Ltd.**

Address of Test Firm .....: Floor 1-A, Baisha Technology Park, No.3011, Shahexi Road,  
Nanshan District, Shenzhen, China 518055

Test specification.....:

Standard.....: **FCC Part 15.247:** Operation within the bands 902-928 MHz,  
2400-2483.5 MHz and 5725-5850 MHz.

TRF Originator .....: Shenzhen CTL Testing Technology Co., Ltd.

Master TRF .....: Dated 2011-01

Date of receipt of test item.....: Sep. 05, 2019

Date of sampling.....: Sep. 05, 2019

Date of Test Date.....: Sep. 05, 2019–Oct. 23, 2019

Data of Issue.....: Oct. 25, 2019

Result.....: **Pass**

**Shenzhen CTL Testing Technology Co., Ltd. All rights reserved.**

This publication may be reproduced in whole or in part for non-commercial purposes as long as the Shenzhen CTL Testing Technology Co., Ltd. is acknowledged as copyright owner and source of the material. Shenzhen CTL Testing Technology Co., Ltd. takes no responsibility for and will not assume liability for damages resulting from the reader's interpretation of the reproduced material due to its placement and context.

# TEST REPORT

<b>Test Report No. :</b>	<b>CTL1908174031-WF01</b>	Oct. 25, 2019
		Date of issue

Equipment under Test : WiFi AP/CPE

Model /Type : WiFi AP/CPE-2458-3x3-AC

Listed Models : N/A

**Applicant** : **Beijing Nodes Network Technology Co., Ltd.**

Address : Rm705, Shenzhou Building, No.31 Zhongguancun South Street, Haidian District, Beijing 100081 China

**Manufacturer** : **Beijing Nodes Network Technology Co., Ltd.**

Address : Rm705, Shenzhou Building, No.31 Zhongguancun South Street, Haidian District, Beijing 100081 China

<b>Test result</b>	<b>Pass *</b>
--------------------	---------------

\* In the configuration tested, the EUT complied with the standards specified page 5.

The test results presented in this report relate only to the object tested.

This report shall not be reproduced, except in full, without the written approval of the issuing testing laboratory.



## Table of Contents

Page

<b>1. SUMMARY.....</b>	<b>5</b>
1.1. TEST STANDARDS.....	5
1.2. TEST DESCRIPTION.....	5
1.3. TEST FACILITY.....	6
1.4. STATEMENT OF THE MEASUREMENT UNCERTAINTY.....	6
<b>2. GENERAL INFORMATION.....</b>	<b>8</b>
2.1. ENVIRONMENTAL CONDITIONS.....	8
2.2. GENERAL DESCRIPTION OF EUT.....	8
2.3. DESCRIPTION OF TEST MODES AND TEST FREQUENCY.....	8
2.4. EQUIPMENTS USED DURING THE TEST.....	9
2.5. RELATED SUBMITTAL(S) / GRANT (S).....	10
2.6. MODIFICATIONS.....	10
<b>3. TEST CONDITIONS AND RESULTS.....</b>	<b>11</b>
3.1. CONDUCTED EMISSIONS TEST.....	11
3.2. RADIATED EMISSIONS AND BAND EDGE.....	14
3.3. MAXIMUM CONDUCTED OUTPUT POWER.....	21
3.4. POWER SPECTRAL DENSITY.....	22
3.5. 6DB BANDWIDTH.....	29
3.6. OUT-OF-BAND EMISSIONS.....	36
3.7. ANTENNA REQUIREMENT.....	59
<b>4. TEST SETUP PHOTOS OF THE EUT.....</b>	<b>60</b>
<b>5. PHOTOS OF THE EUT.....</b>	<b>61</b>

# 1. SUMMARY

## 1.1. TEST STANDARDS

The tests were performed according to following standards:

[FCC Rules Part 15.247](#): Frequency Hopping, Direct Spread Spectrum and Hybrid Systems that are in operation within the bands of 902-928 MHz, 2400-2483.5 MHz, and 5725-5850 MHz

[ANSI C63.10: 2013](#): American National Standard for Testing Unlicensed Wireless Devices

[KDB558074 D01 15.247 Meas Guidance v05r02](#): Guidance for Performing Compliance Measurements on Digital Transmission Systems (DTS) Operating Under §15.247

## 1.2. Test Description

FCC PART 15.247		
FCC Part 15.207	AC Power Conducted Emission	PASS
FCC Part 15.247(a)(2)	6dB Bandwidth	PASS
FCC Part 15.247(d)	Spurious RF Conducted Emission	PASS
FCC Part 15.247(b)	Maximum Conducted Output Power	PASS
FCC Part 15.247(e)	Power Spectral Density	PASS
FCC Part 15.109/ 15.205/ 15.209	Radiated Emissions	PASS
FCC Part 15.247(d)	Band Edge	PASS
FCC Part 15.203/15.247 (b)	Antenna Requirement	PASS

## 1.3. Test Facility

### 1.3.1 Address of the test laboratory

Shenzhen CTL Testing Technology Co., Ltd.

Floor 1-A, Baisha Technology Park, No. 3011, Shahexi Road, Nanshan, Shenzhen 518055 China

There is one 3m semi-anechoic chamber and two line conducted labs for final test. The Test Sites meet the requirements in documents ANSI C63.4 and CISPR 22/EN 55022 requirements.

### 1.3.2 Laboratory accreditation

The test facility is recognized, certified, or accredited by the following organizations:

#### CNAS-Lab Code: L7497

Shenzhen CTL Testing Technology Co., Ltd. has been assessed and proved to be in compliance with CNAS-CL01 Accreditation Criteria for Testing and Calibration Laboratories (identical to ISO/IEC 17025: 2005 General Requirements) for the Competence of Testing and Calibration Laboratories.

#### A2LA-Lab Cert. No. 4343.01

Shenzhen CTL Testing Technology Co., Ltd. EMC Laboratory has been accredited by A2LA for technical competence in the field of electrical testing, and proved to be in compliance with ISO/IEC 17025: 2005 General Requirements for the Competence of Testing and Calibration Laboratories and any additional program requirements in the identified field of testing.

#### IC Registration No.: 9518B

#### CAB identifier: CN0041

The 3m alternate test site of Shenzhen CTL Testing Technology Co., Ltd. EMC Laboratory has been registered by Innovation, Science and Economic Development Canada to test to Canadian radio equipment requirements with Registration No.: 9518B on Jan. 22, 2019.

#### FCC-Registration No.: 399832

#### Designation No.: CN1216

Shenzhen CTL Testing Technology Co., Ltd. EMC Laboratory has been registered and fully described in a report filed with the (FCC) Federal Communications Commission. The acceptance letter from the FCC is maintained in our files. Registration 399832, December 08, 2017.

## 1.4. Statement of the measurement uncertainty

The data and results referenced in this document are true and accurate. The reader is cautioned that there may be errors within the calibration limits of the equipment and facilities. The measurement uncertainty was calculated for all measurements listed in this test report acc. to CISPR 16 - 4 "Specification for radio disturbance and immunity measuring apparatus and methods – Part 4: Uncertainty in EMC Measurements" and is documented in the Shenzhen CTL Testing Technology Co., Ltd. quality system acc. to DIN EN ISO/IEC 17025. Furthermore, component and process variability of devices similar to that tested may result in additional deviation. The manufacturer has the sole responsibility of continued compliance of the device.

Hereafter the best measurement capability for CTL laboratory is reported:

Test	Measurement Uncertainty	Notes
Transmitter power conducted	±0.57 dB	(1)
Transmitter power Radiated	±2.20 dB	(1)
Conducted spurious emission 9KHz-40 GHz	±2.20 dB	(1)
Occupied Bandwidth	±0.01ppm	(1)
Radiated Emission 30~1000MHz	±4.10dB	(1)
Radiated Emission Above 1GHz	±4.32dB	(1)

Conducted Disturbance0.15~30MHz	$\pm 3.20\text{dB}$	(1)
---------------------------------	---------------------	-----

(1) This uncertainty represents an expanded uncertainty expressed at approximately the 95% confidence level using a coverage factor of  $k=2$ .

## 2. GENERAL INFORMATION

### 2.1. Environmental conditions

During the measurement the environmental conditions were within the listed ranges:

Normal Temperature:	25°C
Relative Humidity:	55 %
Air Pressure:	101 kPa

### 2.2. General Description of EUT

Product Name:	WiFi AP/CPE
Model/Type reference:	WiFi AP/CPE-2458-3x3-AC
Power supply:	DC 56V from Adapter
Adapter information:	Model:GRT-560110A Input:AC100~240V 50/60Hz 1.5A MAX Output:DC 56V --- 1000mA
Hardware version:	HW1.4
Software version:	V2.2.1.402
<b>WIFI :</b>	
Supported type:	802.11b/802.11g/802.11n(H20)/802.11n(H40)
Modulation:	802.11b: DSSS 802.11g/802.11n(H20)/802.11n(H40): OFDM
Operation frequency:	802.11b/802.11g/802.11n(H20): 2412MHz~2462MHz 802.11n(H40): 2422MHz~2452MHz
Channel number:	802.11b/802.11g/802.11n(H20): 11 802.11n(H40): 7
Channel separation:	5MHz
Antenna type:	Integral Antenna
Antenna gain:	2.4G CH0 12dBi 2.4G CH1 12dBi 2.4G CH2 12dBi
Direction gain:	16.77 dBi (GANT + 10 log(NANT) dBi)

Note: For more details, please refer to the user's manual of the EUT.

### 2.3. Description of Test Modes and Test Frequency

The Applicant provides communication tools software to control the EUT for staying in continuous transmitting (Duty Cycle more than 98%) and receiving mode for testing.

There are 11 channels provided to the EUT and Channel 01/06/11 were selected for WIFI test.

#### Operation Frequency WIFI :

Channel	Frequency(MHz)	Channel	Frequency(MHz)
<b>1</b>	<b>2412</b>	8	2447
2	2417	9	2452
3	2422	10	2457
4	2427	<b>11</b>	<b>2462</b>
5	2432		
<b>6</b>	<b>2437</b>		
7	2442		

Note: The line display in grey were the channel selected for testing



**Data Rate Used:**

Preliminary tests were performed in different data rate to find the worst radiated emission. The data rate shown in the table below is the worst-case rate with respect to the specific test item. Investigation has been done on all the possible configurations for searching the worst cases. The following table is a list of the test modes shown in this test report.

Test Items	Mode	Data Rate	Channel
Maximum Conducted Output Power Power Spectral Density 6dB Bandwidth Spurious RF conducted emission Radiated Emission 9kHz~1GHz& Radiated Emission 1GHz~10th Harmonic	11b/DSSS	1 Mbps	1/6/11
	11g/OFDM	6 Mbps	1/6/11
	11n(20MHz)/OFDM	6.5Mbps	1/6/11
	11n(40MHz)/OFDM	13.5Mbps	3/6/9
Band Edge	11b/DSSS	1 Mbps	1/11
	11g/OFDM	6 Mbps	1/11
	11n(20MHz)/OFDM	6.5Mbps	1/11
	11n(40MHz)/OFDM	13.5Mbps	3/9

**2.4. Equipments Used during the Test**

Test Equipment	Manufacturer	Model No.	Serial No.	Calibration Date	Calibration Due Date
LISN	R&S	ENV216	3560.6550.1 2	2019/05/20	2020/05/19
LISN	R&S	ESH2-Z5	860014/010	2019/05/20	2020/05/19
Bilog Antenna	Sunol Sciences Corp.	JB1	A061713	2019/05/20	2020/05/19
EMI Test Receiver	R&S	ESCI	1166.5950.03	2019/05/20	2020/05/19
Spectrum Analyzer	Agilent	E4407B	MY41440676	2019/05/20	2020/05/19
Spectrum Analyzer	Agilent	N9020	US46220290	2019/05/20	2020/05/19
Spectrum Analyzer	Keysight	N9020A	MY53420874	2019/05/20	2020/05/19
Controller	EM Electronics	EM 1000	060859	2019/05/20	2020/05/19
Horn Antenna	Sunol Sciences Corp.	DRH-118	A062013	2019/05/20	2020/05/19
Active Loop Antenna	Da Ze	ZN30900A	/	2019/05/20	2020/05/19
Amplifier	Agilent	8449B	3008A02306	2019/05/20	2020/05/19
Amplifier	Agilent	8447D	2944A10176	2019/05/20	2020/05/19
Temperature/Humidity Meter	Gangxing	CTH-608	02	2019/05/20	2020/05/19
High-Pass Filter	micro-tranics	HPM50108	G174	2019/05/20	2020/05/19
High-Pass Filter	micro-tranics	HPM50111	G142	2019/05/20	2020/05/19
Coaxial Cables	HUBER+SUHNER	SUCOFLEX 104PEA-10M	10m	2019/05/20	2020/05/19

Coaxial Cables	HUBER+SUHNER	SUCOFLEX 104PEA-3M	3m	2019/05/20	2020/05/19
Coaxial Cables	HUBER+SUHNER	SUCOFLEX 104PEA-3M	3m	2019/05/20	2020/05/19
RF Cable	Megalon	RF-A303	N/A	2019/05/20	2020/05/19
Power Sensor	Agilent	U2021XA	MY5365004	2019/05/20	2020/05/19
Power Sensor	Agilent	U2531A	TW53323507	2019/05/20	2020/05/19

The calibration interval was one year

## 2.5. Related Submittal(s) / Grant (s)

This submittal(s) (test report) is intended to comply with Section 15.247 of the FCC Part 15, Subpart C Rules.

## 2.6. Modifications

No modifications were implemented to meet testing criteria.

### 3. TEST CONDITIONS AND RESULTS

#### 3.1. Conducted Emissions Test

##### LIMIT

FCC CFR Title 47 Part 15 Subpart C Section 15.207

Frequency range (MHz)	Limit (dBuV)	
	Quasi-peak	Average
0.15-0.5	66 to 56*	56 to 46*
0.5-5	56	46
5-30	60	50

\* Decreases with the logarithm of the frequency.

##### TEST CONFIGURATION

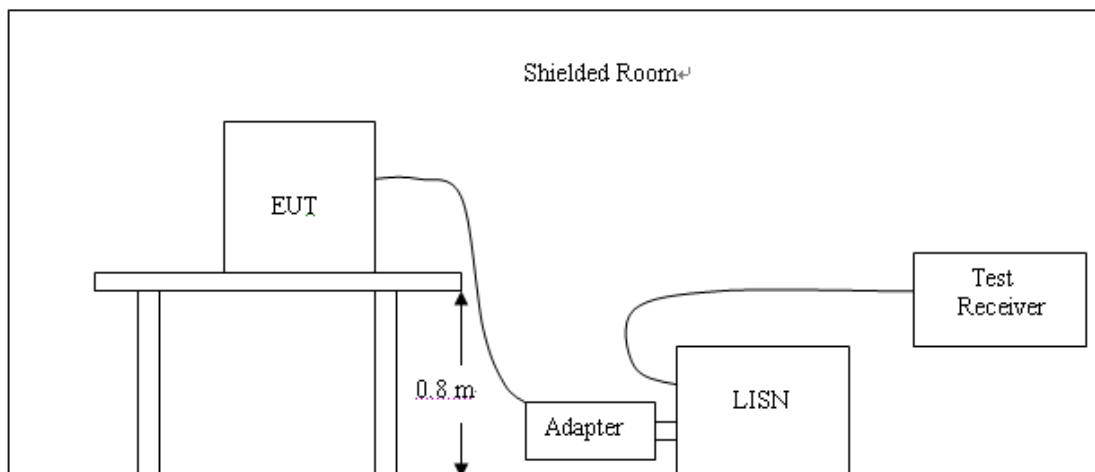

##### TEST PROCEDURE

1. The equipment was set up as per the test configuration to simulate typical actual usage per the user's manual. The EUT is a tabletop system; a wooden table with a height of 0.8 meters is used and is placed on the ground plane as per ANSI C63.10:2013.
2. Support equipment, if needed, was placed as per ANSI C63.10:2013.
3. All I/O cables were positioned to simulate typical actual usage as per ANSI C63.10:2013.
4. The adapter received AC120V/60Hz power through a Line Impedance Stabilization Network (LISN) which supplied power source and was grounded to the ground plane.
5. All support equipments received AC power from a second LISN, if any.
6. The EUT test program was started. Emissions were measured on each current carrying line of the EUT using a spectrum Analyzer / Receiver connected to the LISN powering the EUT. The LISN has two monitoring points: Line 1 (Hot Side) and Line 2 (Neutral Side). Two scans were taken: one with Line 1 connected to Analyzer / Receiver and Line 2 connected to a 50 ohm load; the second scan had Line 1 connected to a 50 ohm load and Line 2 connected to the Analyzer / Receiver.
7. Analyzer / Receiver scanned from 150 KHz to 30MHz for emissions in each of the test modes.
8. During the above scans, the emissions were maximized by cable manipulation.

**TEST RESULTS**

Remark:802.11b/802.11g/802.11n(H20)/802.11n(H40) mode all have been tested, only worse case of 802.11b High Channel was reported.

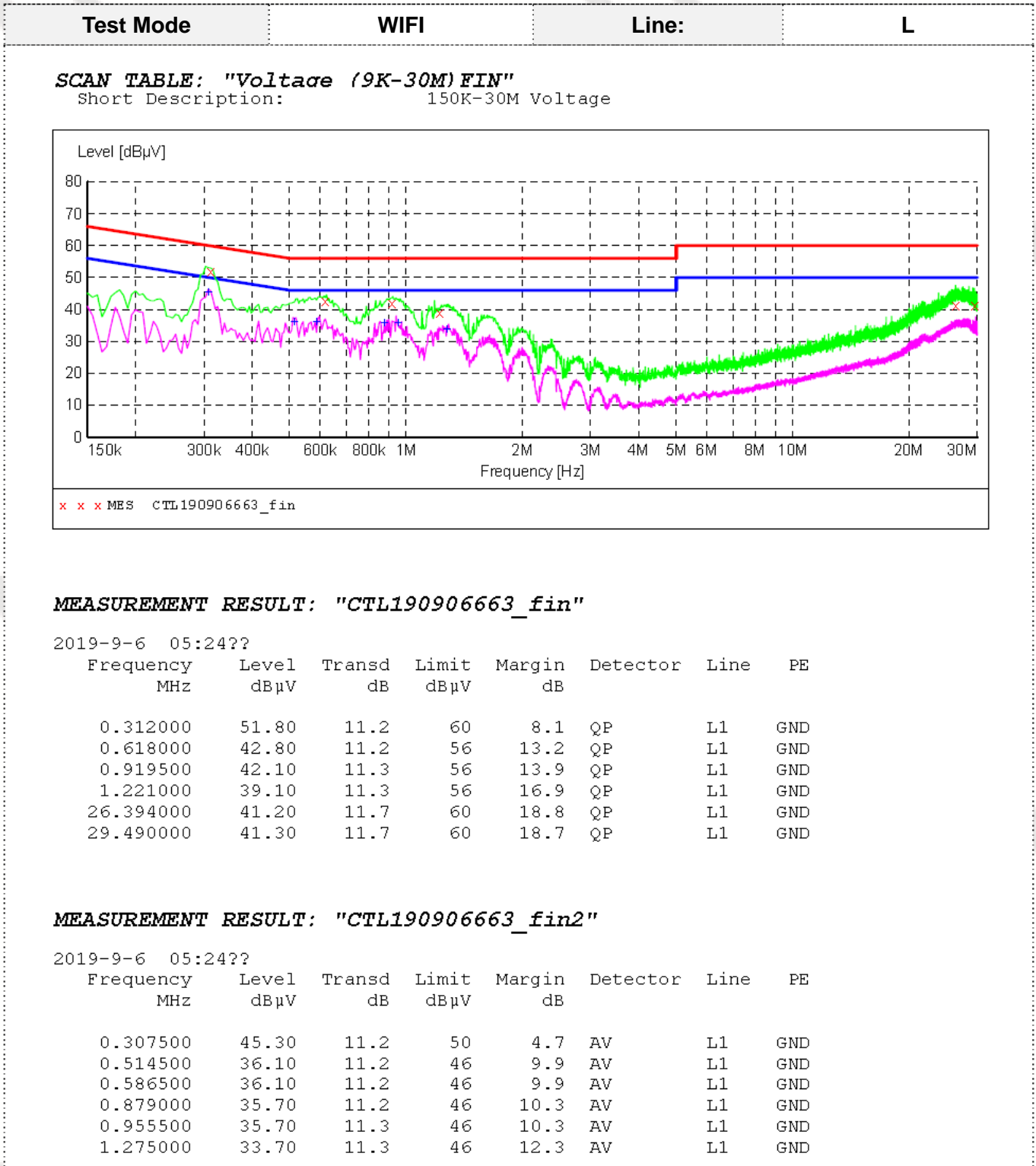

Test Mode	WIFI	Line:	N
-----------	------	-------	---

**SCAN TABLE: "Voltage (9K-30M) FIN"**

Short Description: 150K-30M Voltage

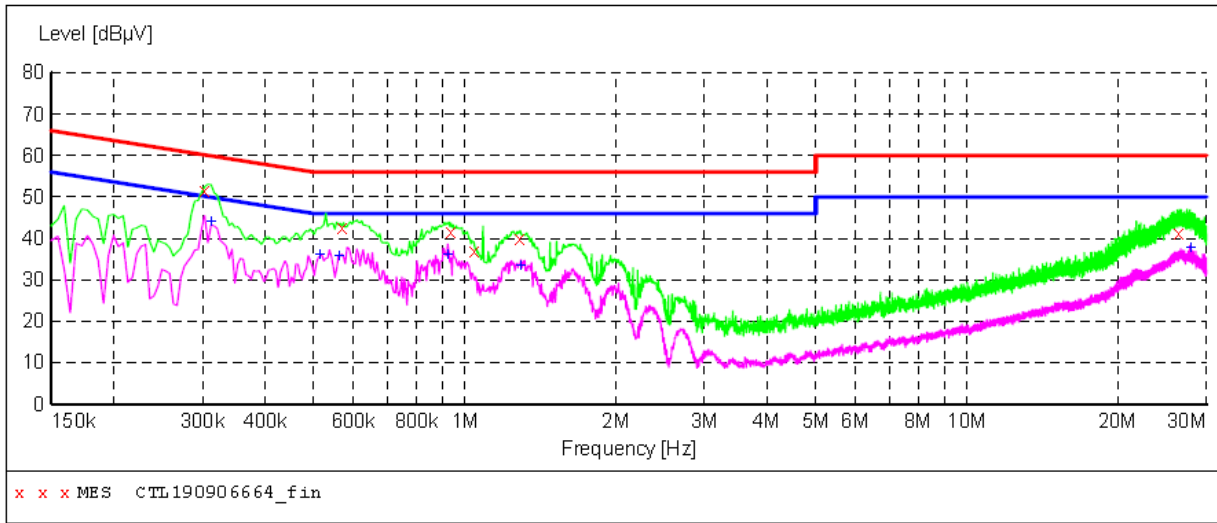

**MEASUREMENT RESULT: "CTL190906664\_fin"**

2019-9-6 05:27??

Frequency MHz	Level dBµV	Transd dB	Limit dBµV	Margin dB	Detector	Line	PE
0.303000	51.60	11.2	60	8.6	QP	N	GND
0.568500	42.50	11.2	56	13.5	QP	N	GND
0.937500	41.80	11.3	56	14.2	QP	N	GND
1.041000	37.10	11.3	56	18.9	QP	N	GND
1.284000	39.90	11.3	56	16.1	QP	N	GND
26.466000	41.20	11.7	60	18.8	QP	N	GND

**MEASUREMENT RESULT: "CTL190906664\_fin2"**

2019-9-6 05:27??

Frequency MHz	Level dBµV	Transd dB	Limit dBµV	Margin dB	Detector	Line	PE
0.312000	44.10	11.2	50	5.8	AV	N	GND
0.514500	36.10	11.2	46	9.9	AV	N	GND
0.559500	35.80	11.2	46	10.2	AV	N	GND
0.924000	36.00	11.3	46	10.0	AV	N	GND
1.293000	33.50	11.3	46	12.5	AV	N	GND
27.838500	37.50	11.7	50	12.5	AV	N	GND

### 3.2. Radiated Emissions and Band Edge

#### Limit

For intentional device, according to § 15.209(a), the general requirement of field strength of radiated emission out of authorized band shall not exceed the following table at a 3 meters measurement distance.

In addition, radiated emissions which fall in the restricted bands, as defined in §15.205(a), must also comply with the radiated emission limits specified in §15.209(a)

Radiated emission limits

Frequency (MHz)	Distance (Meters)	Radiated (dBµV/m)	Radiated (µV/m)
0.009-0.49	3	$20\log(2400/F(\text{KHz}))+40\log(300/3)$	$2400/F(\text{KHz})$
0.49-1.705	3	$20\log(24000/F(\text{KHz}))+40\log(30/3)$	$24000/F(\text{KHz})$
1.705-30	3	$20\log(30)+40\log(30/3)$	30
30-88	3	40.0	100
88-216	3	43.5	150
216-960	3	46.0	200
Above 960	3	54.0	500

#### TEST CONFIGURATION

(A) Radiated Emission Test Set-Up, Frequency Below 30MHz

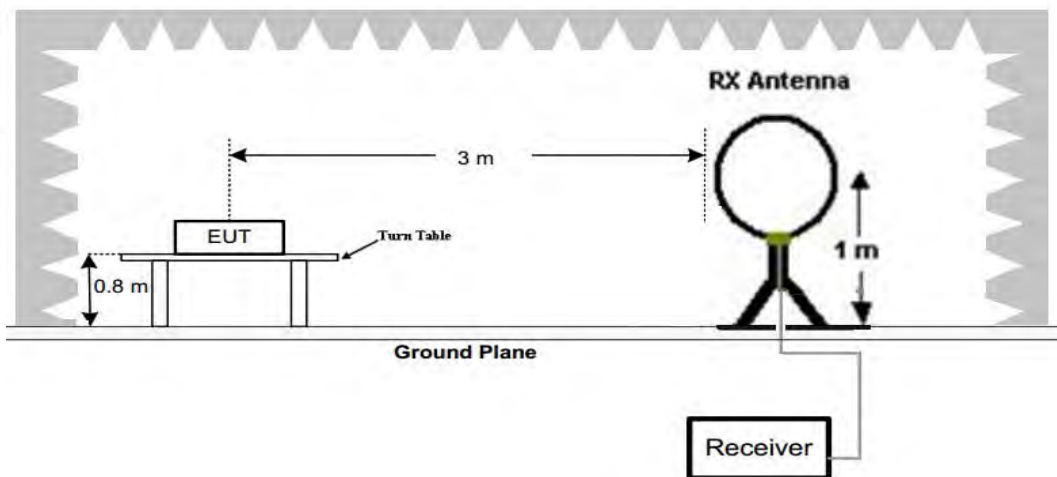

(B) Radiated Emission Test Set-Up, Frequency below 1000MHz

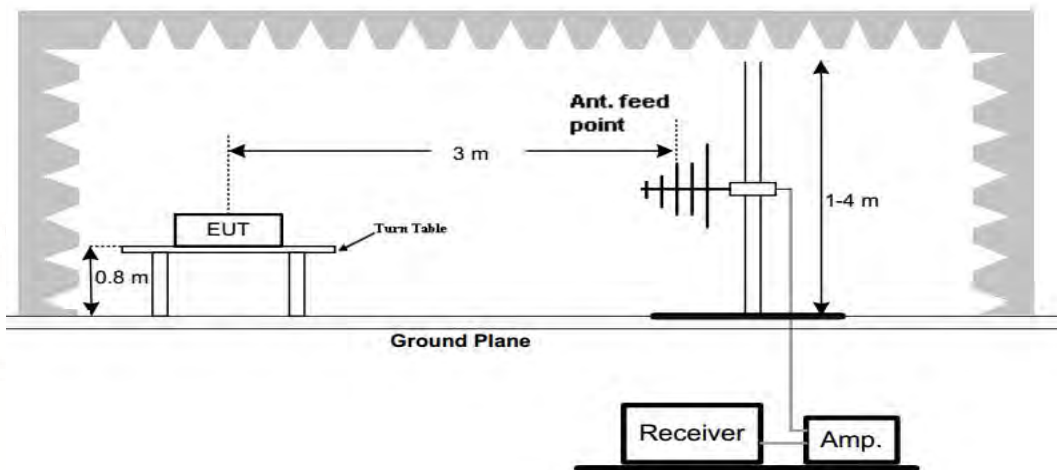

(C) Radiated Emission Test Set-Up, Frequency above 1000MHz

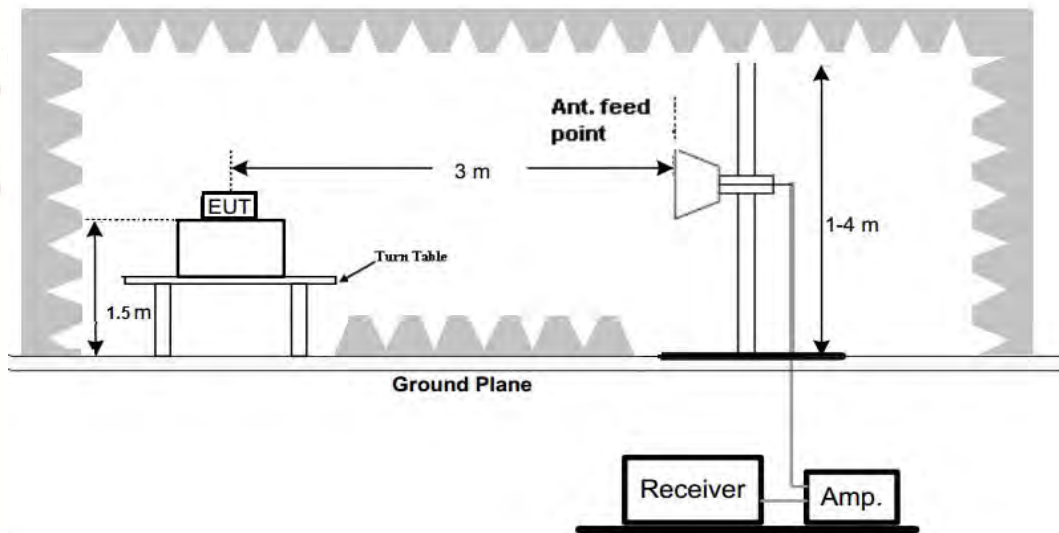

### Test Procedure

1. Below 1GHz measurement the EUT is placed on a turntable which is 0.8m above ground plane, and above 1GHz measurement EUT was placed on a low permittivity and low loss tangent turn table which is 1.5m above ground plane.
2. Maximum procedure was performed by raising the receiving antenna from 1m to 4m and rotating the turn table from 0° to 360° to acquire the highest emissions from EUT
3. And also, each emission was to be maximized by changing the polarization of receiving antenna both horizontal and vertical.
4. Repeat above procedures until all frequency measurements have been completed.

### TEST RESULTS

Remark:

1. All three channels (lowest/middle/highest) of each mode were measured below 1GHz and recorded worst case at 802.11b low channel.
2. All three channels (lowest/middle/highest) of each mode were measured above 1GHz and recorded worst case at 802.11b mode.
3. Radiated emission test from 9 KHz to 10th harmonic of fundamental was verified, and no emission found except system noise floor in 9 KHz to 30MHz and not recorded in this report.

For 30MHz-1GHz

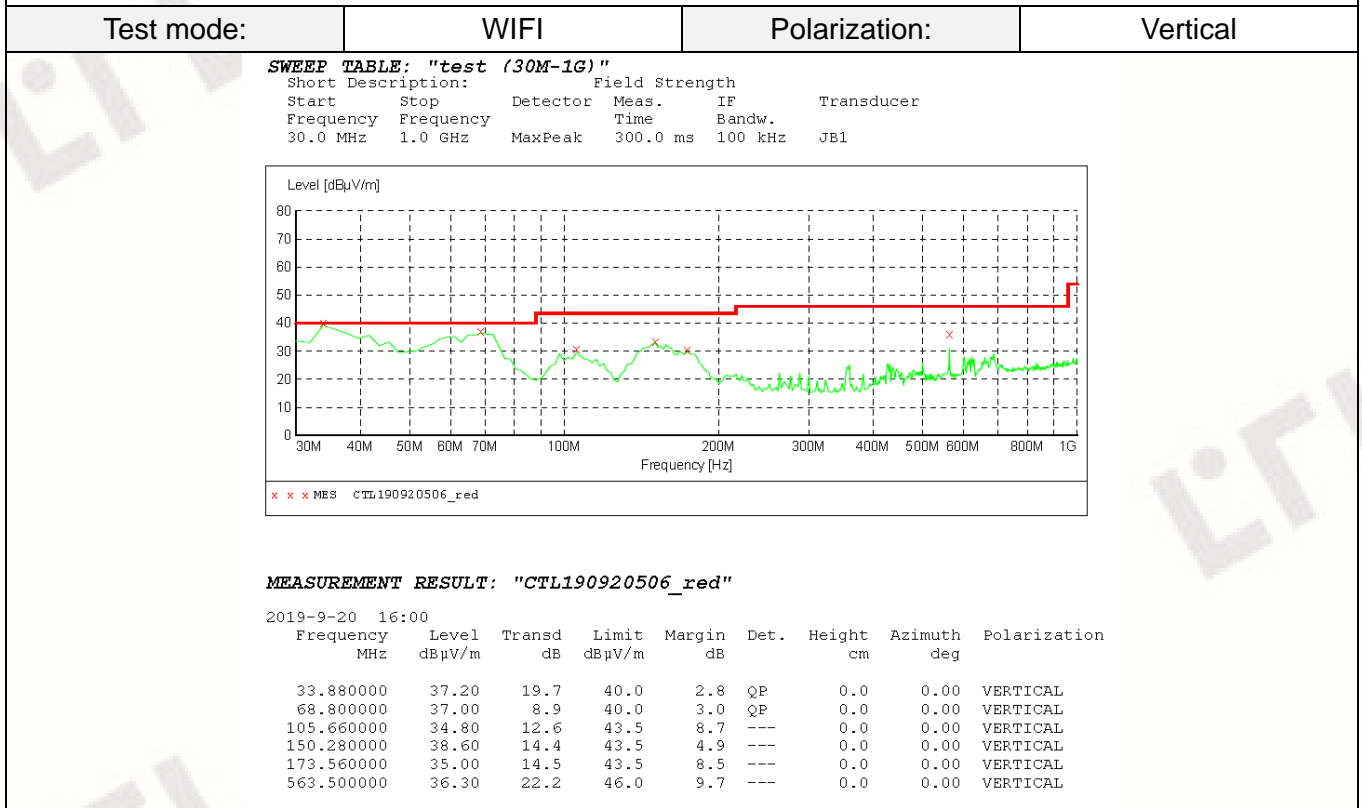
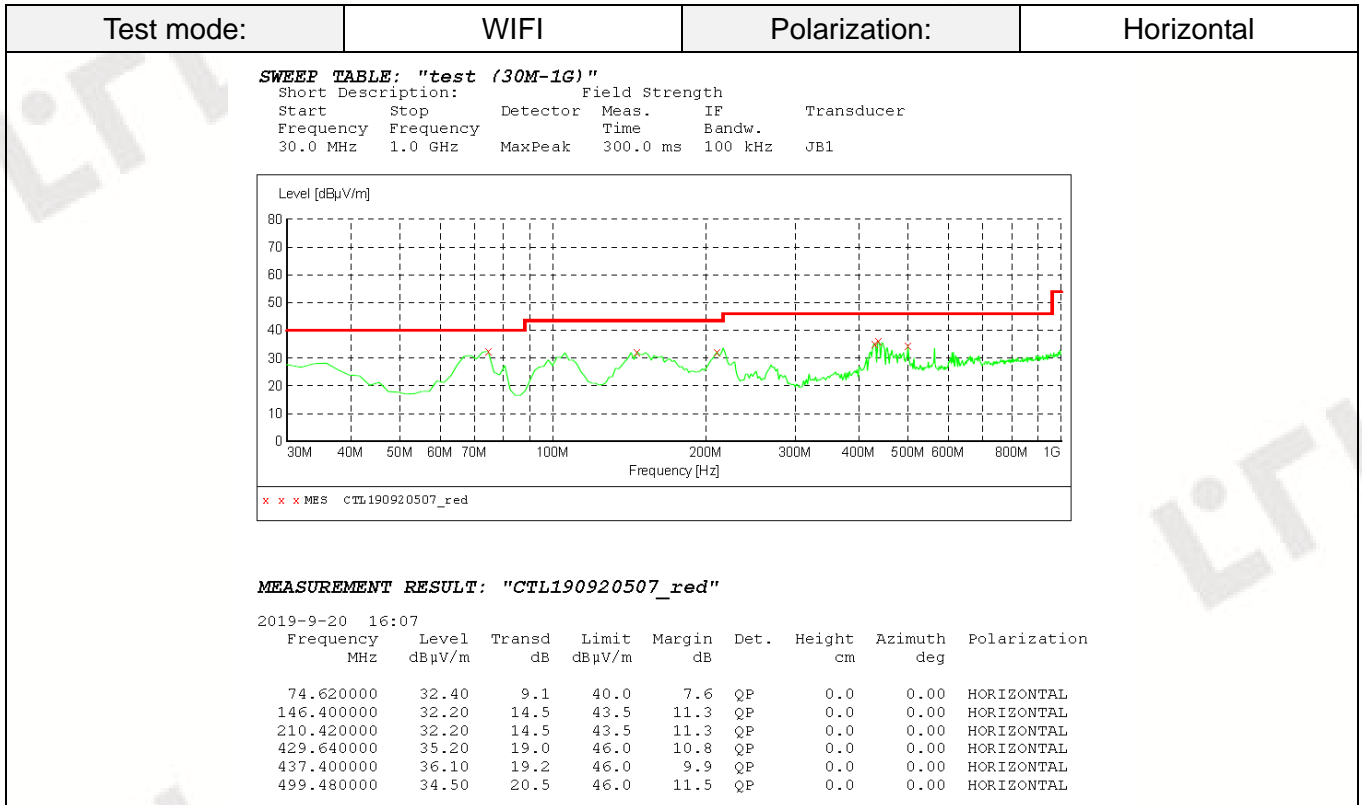



**For 1GHz to 25GHz****802.11b Mode (above 1GHz)**

Note: 802.11b/802.11g/802.11n (H20) all have been tested, only worse case 802.11b is reported

Frequency(MHz):			2412		Polarity:			HORIZONTAL	
Frequency (MHz)	Emission Level (dBuV/m)		Limit (dBuV/m)	Margin (dB)	Raw Value (dBuV)	Antenna Factor (dB/m)	Cable Factor (dB)	Pre-amplifier (dB)	Correction Factor (dB/m)
4824.00	60.28	PK	74	13.72	55.73	33.52	6.92	35.89	4.55
4824.00	50.36	AV	54	3.64	45.81	33.52	6.92	35.89	4.55
5125.75	52.48	PK	74	21.52	45.28	34.38	7.10	34.28	7.20
5125.75	--	AV	54	--	--	--	--	--	--
7236.00	49.36	PK	74	24.64	38.09	37.1	9.19	35.02	11.27
7236.00	--	AV	54	--	--	--	--	--	--

Frequency(MHz):			2412		Polarity:			VERTICAL	
Frequency (MHz)	Emission Level (dBuV/m)		Limit (dBuV/m)	Margin (dB)	Raw Value (dBuV)	Antenna Factor (dB/m)	Cable Factor (dB)	Pre-amplifier (dB)	Correction Factor (dB/m)
4824.00	61.35	PK	74	12.65	56.8	33.52	6.92	35.89	4.55
4824.00	51.38	AV	54	2.62	46.83	33.52	6.92	35.89	4.55
5125.75	52.54	PK	74	21.46	45.34	34.38	7.10	34.28	7.20
5125.75	--	AV	54	--	--	--	--	--	--
7236.00	50.21	PK	74	23.79	38.94	37.1	9.19	35.02	11.27
7236.00	--	AV	54	--	--	--	--	--	--

Frequency(MHz):			2437		Polarity:			HORIZONTAL	
Frequency (MHz)	Emission Level (dBuV/m)		Limit (dBuV/m)	Margin (dB)	Raw Value (dBuV)	Antenna Factor (dB/m)	Cable Factor (dB)	Pre-amplifier (dB)	Correction Factor (dB/m)
4874.00	59.86	PK	74	14.14	53.62	33.59	6.95	34.3	6.24
4874.00	50.02	AV	54	3.98	43.78	33.59	6.95	34.3	6.24
5215.50	49.86	PK	74	24.14	42.26	34.56	7.15	34.11	7.60
5215.50	--	AV	54	--	--	--	--	--	--
7311.00	47.12	PK	74	26.88	35.46	37.44	9.22	35	11.66
7311.00	--	AV	54	--	--	--	--	--	--

Frequency(MHz):			2437		Polarity:			VERTICAL	
Frequency (MHz)	Emission Level (dBuV/m)		Limit (dBuV/m)	Margin (dB)	Raw Value (dBuV)	Antenna Factor (dB/m)	Cable Factor (dB)	Pre-amplifier (dB)	Correction Factor (dB/m)
4874.00	60.08	PK	74	13.92	53.74	33.59	6.95	34.2	6.34
4874.00	50.28	AV	54	3.72	43.94	33.59	6.95	34.2	6.34
5215.50	52.01	PK	74	21.99	45.11	34.07	7.05	34.22	6.90
5215.50	--	AV	54	--	--	--	--	--	--
7311.00	49.25	PK	74	24.75	37.59	37.44	9.22	35	11.66
7311.00	--	AV	54	--	--	--	--	--	--

Frequency(MHz):			2462		Polarity:			HORIZONTAL	
Frequency (MHz)	Emission Level (dBuV/m)		Limit (dBuV/m)	Margin (dB)	Raw Value (dBuV)	Antenna Factor (dB/m)	Cable Factor (dB)	Pre-amplifier (dB)	Correction Factor (dB/m)
4924.00	59.36	PK	74	14.64	53.55	33.71	6.98	35.91	4.78
4924.00	49.52	AV	54	4.48	43.73	33.71	6.98	35.91	4.78
5105.50	51.28	PK	74	22.72	41.24	34.34	7.09	34.27	7.17
5105.50	--	AV	54	--	--	--	--	--	--
7386.00	48.01	PK	74	25.99	37.4	37.61	9.25	34.98	11.88
7386.00	--	AV	54	--	--	--	--	--	--

Frequency(MHz):			2462		Polarity:			VERTICAL	
Frequency (MHz)	Emission Level (dBuV/m)		Limit (dBuV/m)	Margin (dB)	Raw Value (dBuV)	Antenna Factor (dB/m)	Cable Factor (dB)	Pre-amplifier (dB)	Correction Factor (dB/m)
4924.00	60.19	PK	74	13.81	55.41	33.71	6.98	35.91	4.78
4924.00	51.38	AV	54	2.62	46.6	33.71	6.98	35.91	4.78
5105.50	49.12	PK	74	24.88	41.95	34.34	7.09	34.27	7.17
5105.50	--	AV	54	--	--	--	--	--	--
7386.00	48.43	PK	74	25.57	36.55	37.61	9.25	34.98	11.88
7386.00	--	AV	54	--	--	--	--	--	--

## REMARKS:

1. Emission level (dBuV/m) =Raw Value (dBuV)+Correction Factor (dB/m)
2. Correction Factor (dB/m) = Antenna Factor (dB/m)+Cable Factor (dB)-Pre-amplifier Factor
3. Margin value = Limit value- Emission level.
4. -- Mean the PK detector measured value is below average limit.
5. The other emission levels were very low against the limit.
6. RBW1MHz VBW3MHz Peak detector is for PK value; RBW 1MHz VBW10Hz Peak detector is for AV value.

**Results of Band Edges Test (Radiated)**

Note: 802.11b/802.11g/802.11n (H20) all have been tested, only worse case 802.11b is reported

Frequency(MHz):			2412		Polarity:			HORIZONTAL	
Frequency (MHz)	Emission Level (dBuV/m)		Limit (dBuV/m)	Margin (dB)	Raw Value (dBuV)	Antenna Factor (dB/m)	Cable Factor (dB)	Pre-amplifier (dB)	Correction Factor (dB/m)
2412.00	116.03	PK	--	--	82.64	28.78	4.61	0	33.39
2412.00	10.743	AV	--	--	-22.647	28.78	4.61	0	33.39
2357.75	43.93	PK	74	30.07	10.85	28.52	4.56	0	33.08
2357.75	--	AV	54	--	--	--	--	--	--
2390.00	46.87	PK	74	27.13	13.55	28.72	4.60	0	33.32
2390.00	52.38	AV	54	1.62	19.06	28.72	4.60	0	33.32
2400.00	65.51	PK	74	8.49	32.12	28.78	4.61	0	33.39
2400.00	53.12	AV	54	0.88	19.73	28.78	4.61	0	33.39

Frequency(MHz):			2412		Polarity:			VERTICAL	
Frequency (MHz)	Emission Level (dBuV/m)		Limit (dBuV/m)	Margin (dB)	Raw Value (dBuV)	Antenna Factor (dB/m)	Cable Factor (dB)	Pre-amplifier (dB)	Correction Factor (dB/m)
2412.00	115.68	PK	--	--	82.29	28.78	4.61	0	33.39
2412.00	107.34	AV	--	--	73.95	28.78	4.61	0	33.39
2357.75	45.06	PK	74	28.94	11.98	28.52	4.56	0	33.08
2357.75	--	AV	54	--	--	--	--	--	--
2390.00	64.38	PK	74	9.62	31.06	28.72	4.60	0	33.32
2390.00	51.36	AV	54	2.64	18.04	28.72	4.60	0	33.32
2400.00	65.13	PK	74	8.87	31.74	28.78	4.61	0	33.39
2400.00	52.78	AV	54	1.22	19.39	28.78	4.61	0	33.39

Frequency(MHz):			2462		Polarity:			HORIZONTAL	
Frequency (MHz)	Emission Level (dBuV/m)		Limit (dBuV/m)	Margin (dB)	Raw Value (dBuV)	Antenna Factor (dB/m)	Cable Factor (dB)	Pre-amplifier (dB)	Correction Factor (dB/m)
2462.00	115.69	PK	--	--	82.07	28.92	4.7	0	33.62
2462.00	106.67	AV	--	--	73.05	28.92	4.7	0	33.62
2483.50	44.35	PK	74	29.65	10.72	28.93	4.7	0	33.63
2483.50	--	AV	54	--	--	--	--	--	--
2486.75	36.86	PK	74	37.14	3.22	28.94	4.71	0	33.64
2486.75	--	AV	54	--	--	--	--	--	--
2500.00	44.57	PK	74	29.43	10.89	28.96	4.72	0	33.68
2500.00	--	AV	54	--	--	--	--	--	--

Frequency(MHz):			2462		Polarity:			VERTICAL	
Frequency (MHz)	Emission Level (dBuV/m)		Limit (dBuV/m)	Margin (dB)	Raw Value (dBuV)	Antenna Factor (dB/m)	Cable Factor (dB)	Pre-amplifier (dB)	Correction Factor (dB/m)
2462.00	115.32	PK	--	--	81.7	28.92	4.7	0	33.62
2462.00	106.78	AV	--	--	73.16	28.92	4.7	0	33.62
2483.50	45.67	PK	74	28.33	12.04	28.93	4.7	0	33.63
2483.50	--	AV	54	--	--	--	--	--	--
2486.75	42.68	PK	74	31.32	9.04	28.94	4.71	0	33.64
2486.75	--	AV	54	--	--	--	--	--	--
2500.00	43.74	PK	74	30.26	10.06	28.96	4.72	0	33.68
2500.00	--	AV	54	--	--	--	--	--	--

## REMARKS:

1. Emission level (dBuV/m) =Raw Value (dBuV)+Correction Factor (dB/m)
2. Correction Factor (dB/m) = Antenna Factor (dB/m)+Cable Factor (dB)-Pre-amplifier Factor
3. Margin value = Limit value- Emission level.
4. -- Mean the PK detector measured value is below average limit.
5. The other emission levels were very low against the limit.
6. RBW1MHz VBW3MHz Peak detector is for PK value; RBW 1MHz VBW10Hz Peak detector is for AV value.
7. For fundamental frequency, RBW 3MHz VBW 3MHz Peak detector is for PK Value; RMS detector is for AV value.

### 3.3. Maximum Conducted Output Power

#### Limit

The Maximum Peak Output Power Measurement is 30dBm.

#### Test Procedure

Remove the antenna from the EUT and then connect a low loss RF cable from the antenna port to the power sensor.

#### Test Configuration

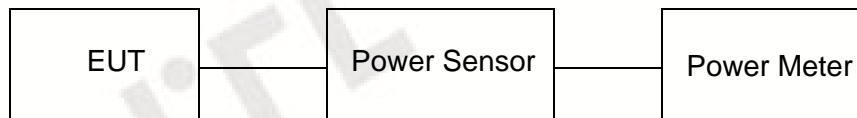

#### Test Results

WIFI							
Type	Channel	Output power Ant1 (dBm)	Output power Ant2 (dBm)	Output power Ant3 (dBm)	Output power Total (dBm)	Limit (dBm)	Result
802.11b	01	14.44	15.01	14.50	/	30	Pass
	06	14.39	15.45	14.79	/		
	11	14.63	15.34	14.96	/		
802.11g	01	17.57	17.82	17.04	/	30	Pass
	06	17.46	17.94	17.48	/		
	11	17.31	17.94	17.87	/		
802.11n(HT20) MIMO	01	14.09	14.11	14.26	18.93	19.23	Pass
	06	14.14	14.21	14.16	18.94		
	11	13.86	13.94	14.08	18.73		
802.11n(HT40) MIMO	03	14.21	14.17	14.07	18.92	19.23	Pass
	06	14.11	13.96	14.13	18.84		
	09	14.08	14.18	13.63	18.74		

Note: 1.The test results including the cable lose.

### 3.4. Power Spectral Density

#### Limit

For digitally modulated systems, the power spectral density conducted from the intentional radiator to the antenna shall not be greater than 8 dBm in any 3 kHz band during any time interval of continuous transmission.

#### Test Procedure

1. Use this procedure when the maximum peak conducted output power in the fundamental emission is used to demonstrate compliance.
2. Set the RBW  $\geq$  3 kHz.
3. Set the VBW  $\geq$  3 $\times$  RBW.
4. Set the span to 1.5 times the DTS channel bandwidth.
5. Detector = peak.
6. Sweep time = auto couple.
7. Trace mode = max hold.
8. Allow trace to fully stabilize.
9. Use the peak marker function to determine the maximum power level.
10. If measured value exceeds limit, reduce RBW (no less than 3 kHz) and repeat.
11. The resulting peak PSD level must be 8dBm.

#### Test Configuration

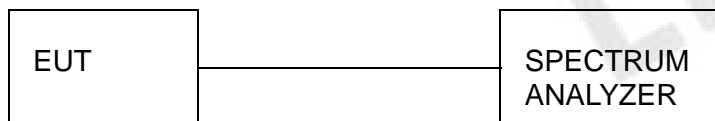

#### Test Results

##### WIFI

Type	Channel	Power Spectral Density Ant1 (dBm/3KHz)	Power Spectral Density Ant2 (dBm/3KHz)	Power Spectral Density Ant3 (dBm/3KHz)	Power Spectral Density Total (dBm/3KHz)	Limit (dBm/3KHz)	Result
802.11b	01	-15.500	-15.240	-15.292	/	8.00	Pass
	06	-15.689	-14.775	-15.330	/		
	11	-15.480	-14.738	-15.087	/		
802.11g	01	-16.710	-16.300	-17.536	/	8.00	Pass
	06	-17.109	-17.302	-16.778	/		
	11	-17.037	-16.985	-15.518	/		
802.11n (HT20)	01	-17.710	-16.401	-17.178	-12.292	-2.77	Pass
	06	-17.116	-16.467	-14.905	-11.290		
	11	-17.214	-16.400	-16.954	-12.071		
802.11n (HT40)	03	-21.396	-21.538	-21.018	-16.541	-2.77	Pass
	06	-21.241	-21.249	-21.462	-16.545		
	09	-21.899	-20.899	-21.628	-16.683		

Test plot as follows:

Ant1

802.11b

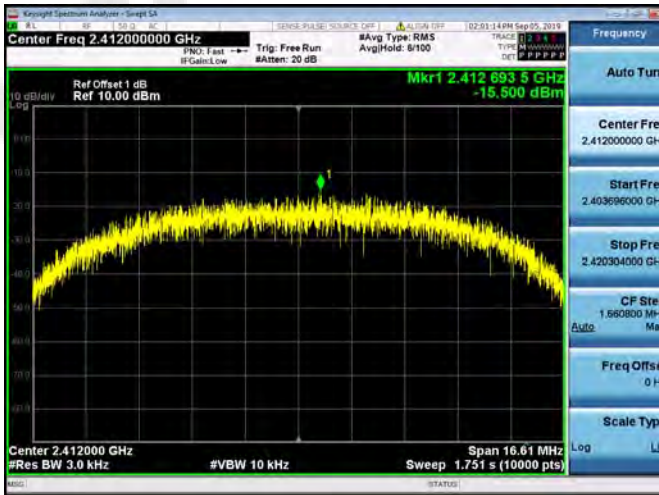

802.11g

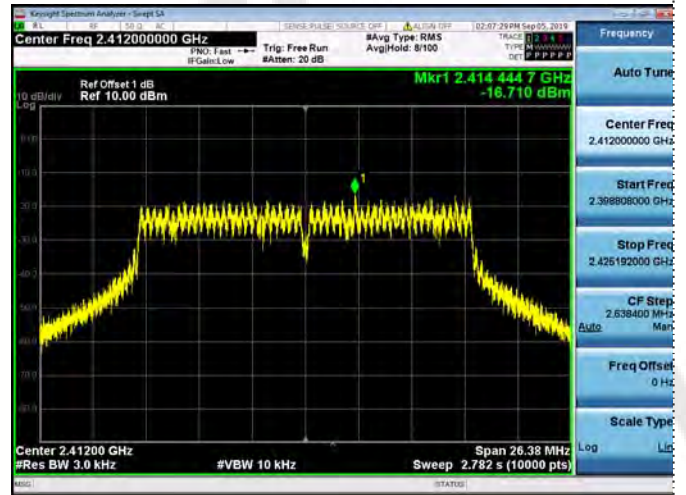

CH01

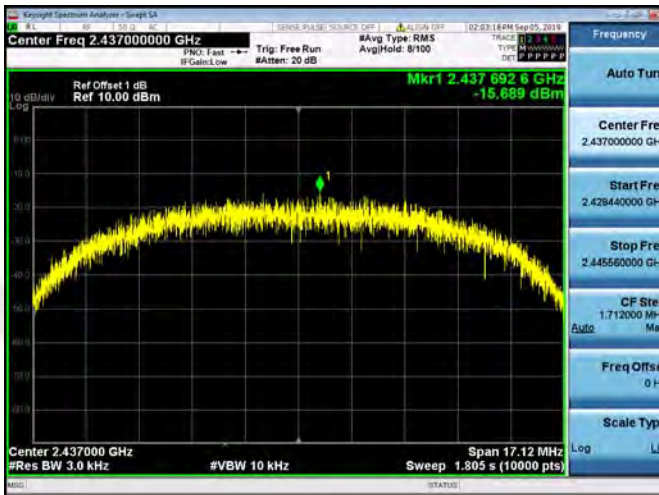

CH01

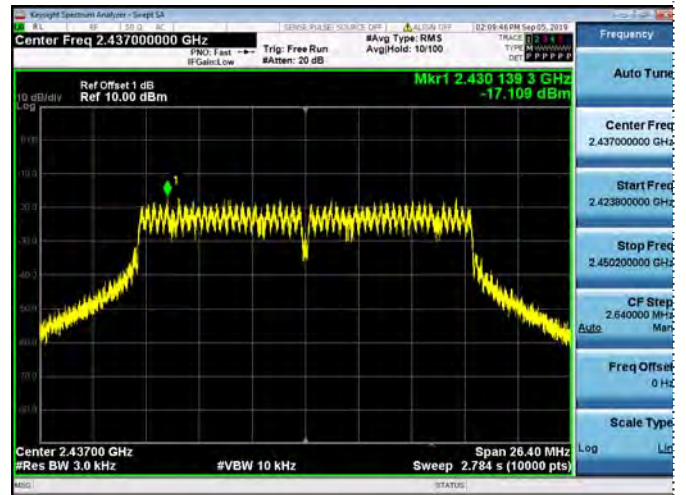

CH06

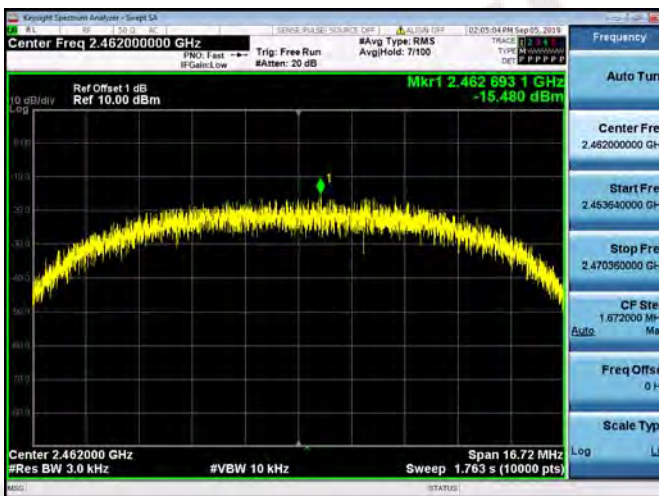

CH06



CH11



CH11



802.11n(HT20)

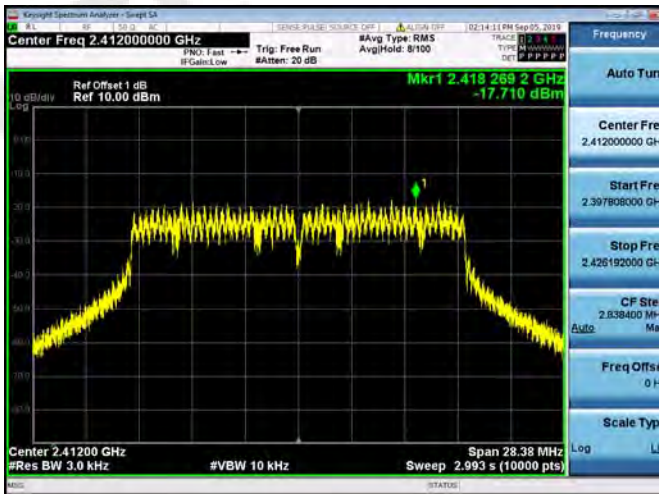

CH01

802.11n(HT40)

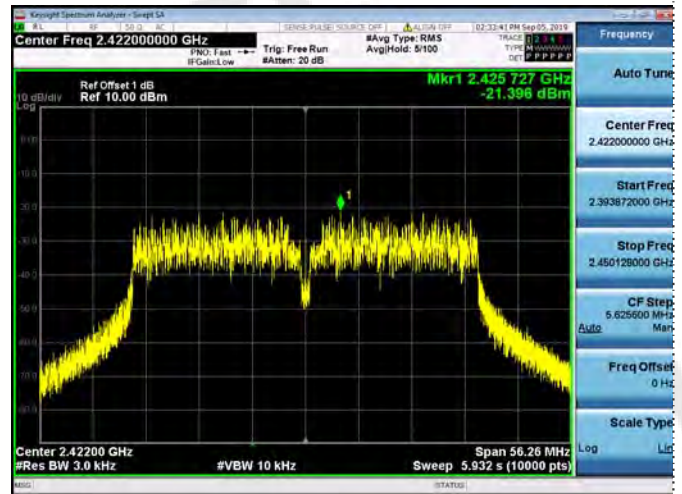

CH03

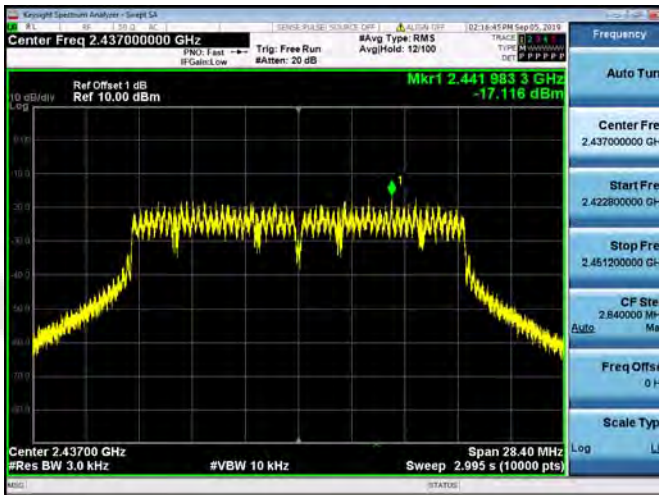

CH06

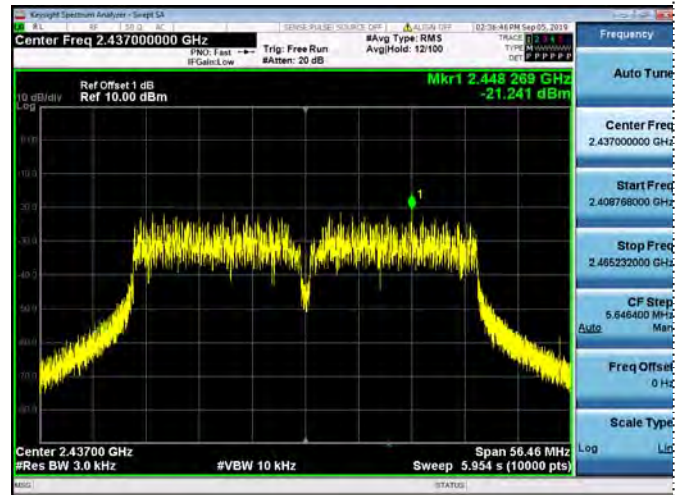

CH06

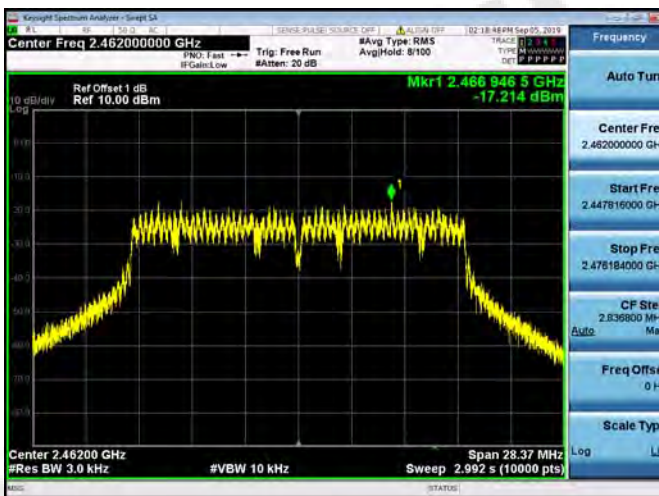

CH11



CH09



Ant2

802.11b

802.11g

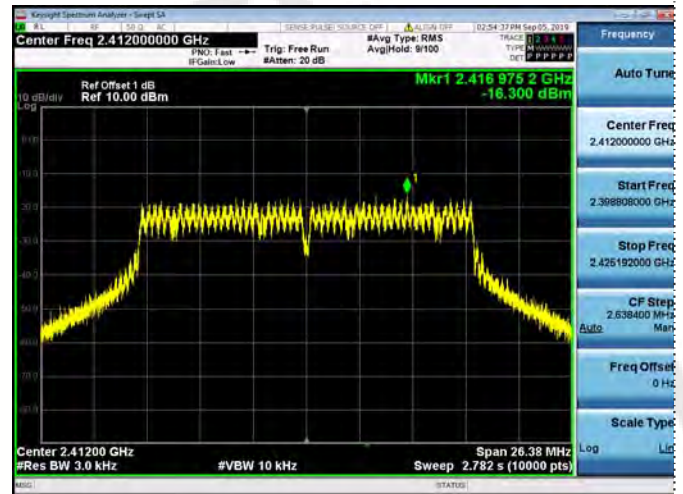
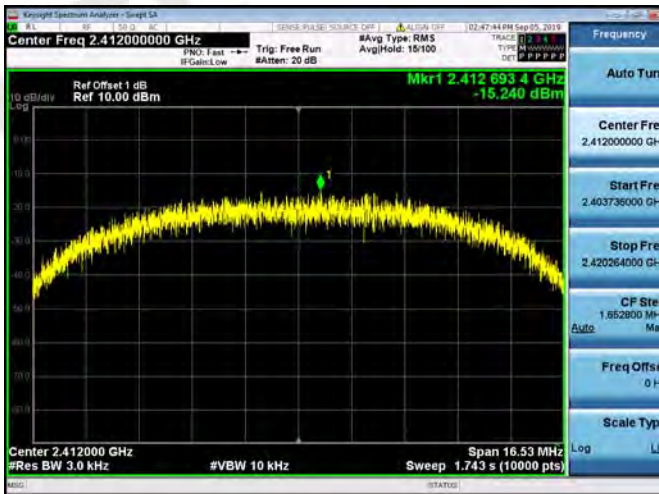

CH01

CH01

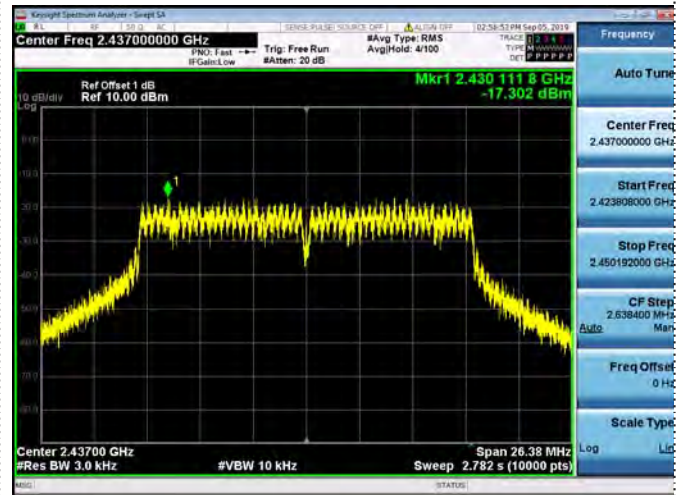

CH06

CH06

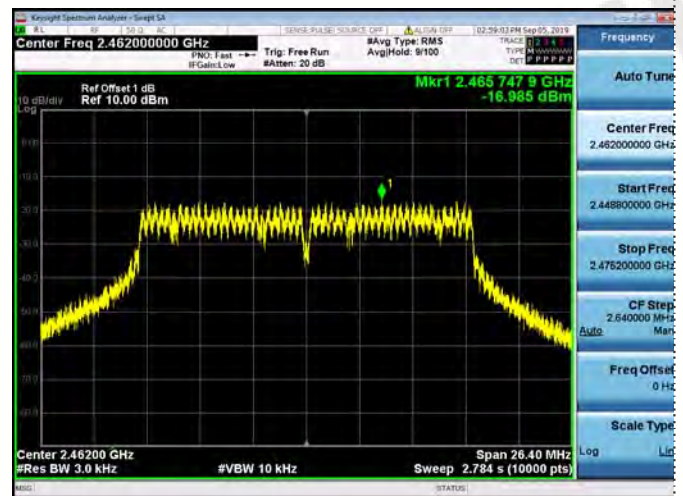
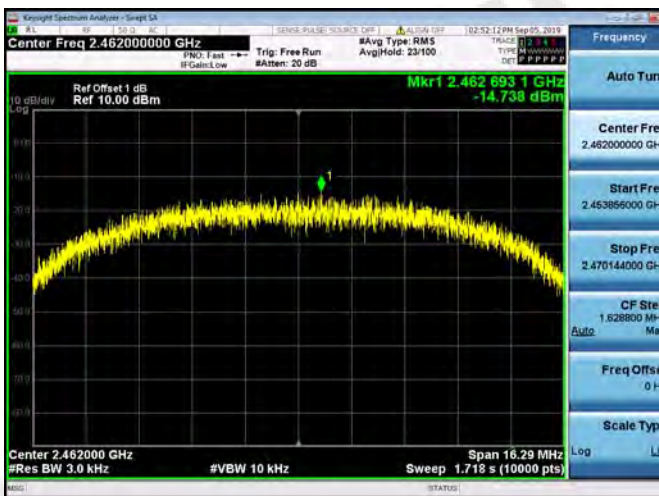

CH11

CH11



Ant3

802.11b

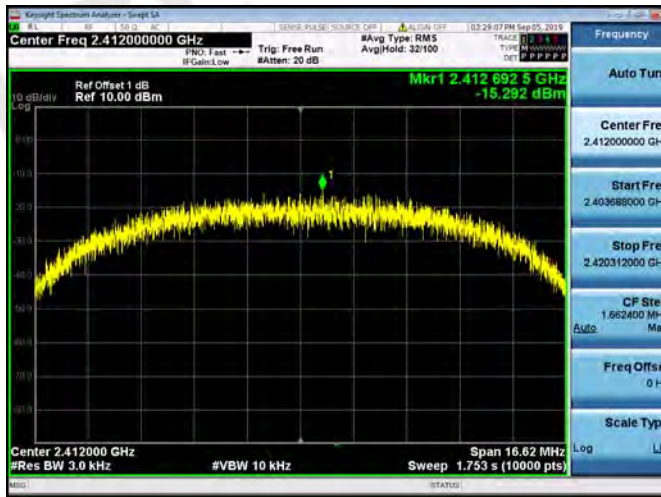

CH01

802.11g

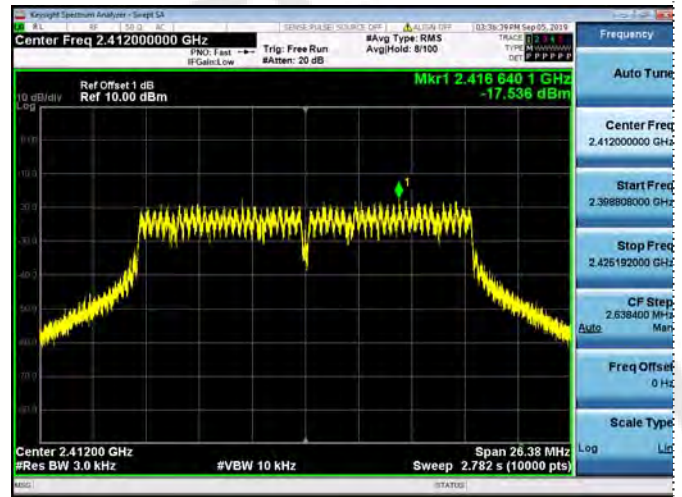

CH01

CH06

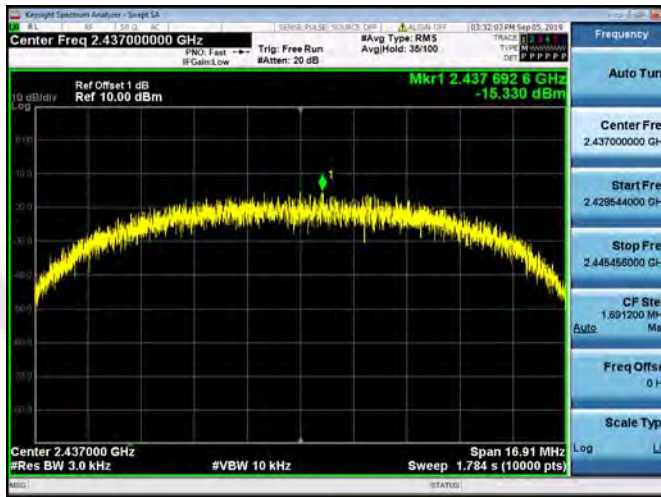

CH06

CH06

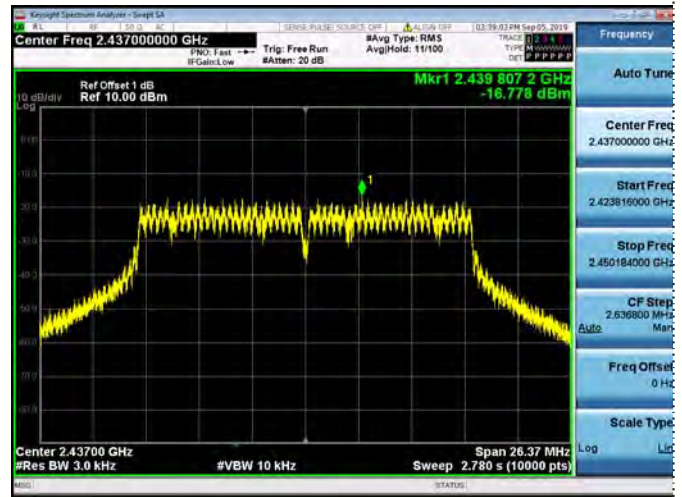

CH06

CH11

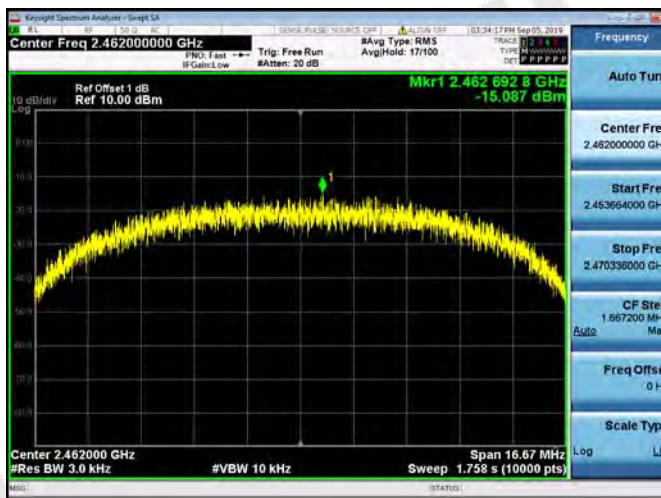

CH11

CH11

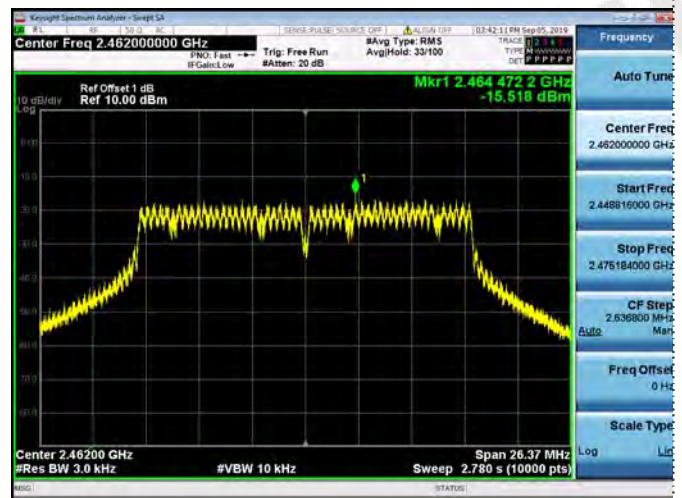

CH11

802.11n(HT20)

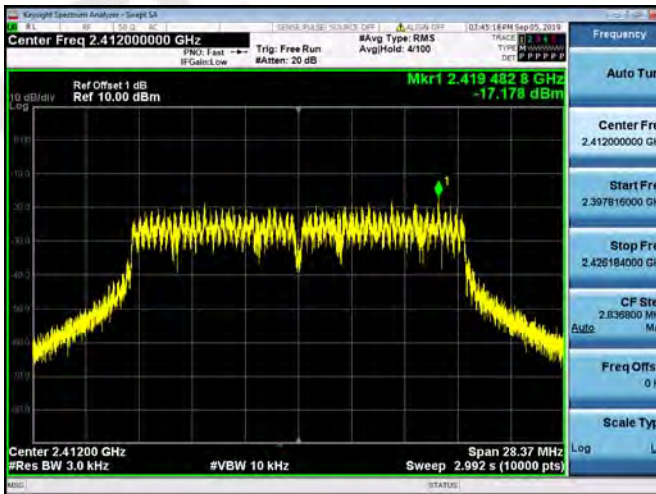

CH01

802.11n(HT40)



CH03

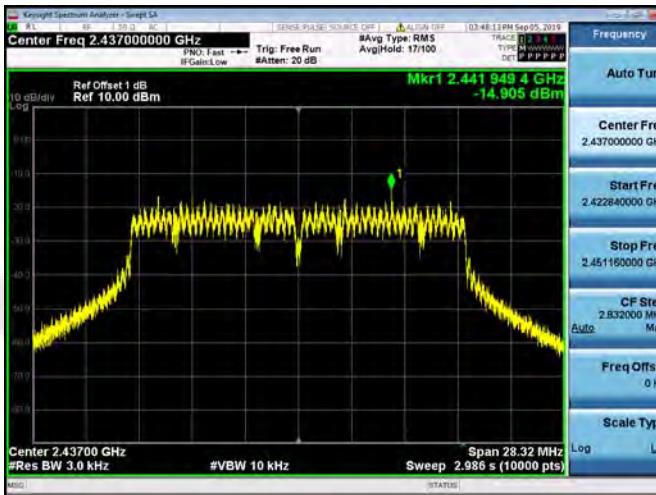

CH06



CH06

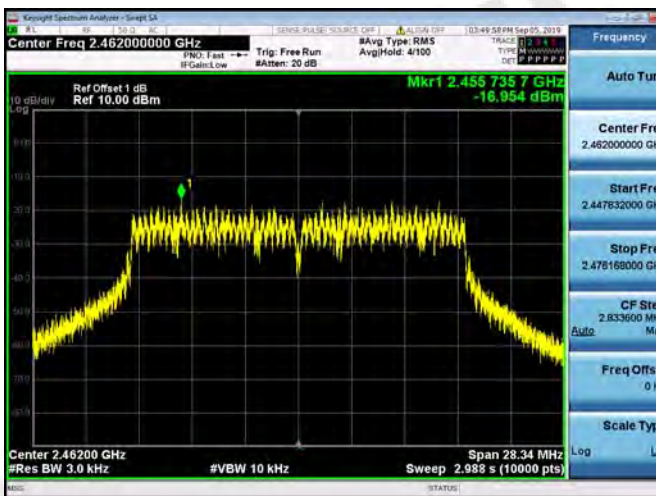

CH11

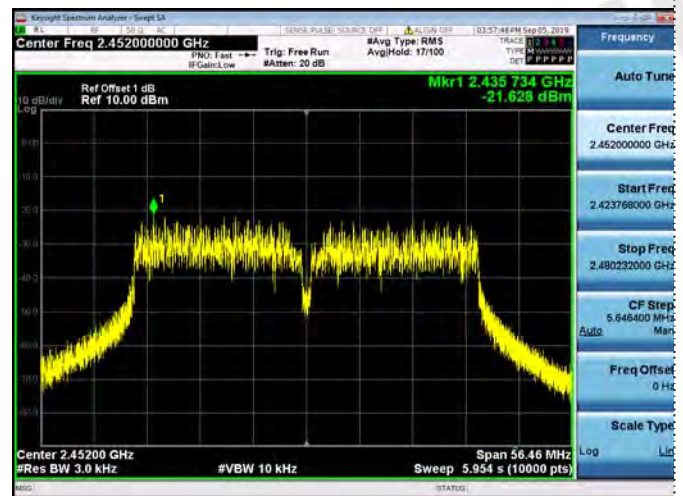

CH09

### 3.5. 6dB Bandwidth

#### Limit

For digital modulation systems, the minimum 6 dB bandwidth shall be at least 500 kHz

#### Test Procedure

The transmitter output was connected to the spectrum analyzer through an attenuator. The bandwidth of the fundamental frequency was measured by spectrum analyzer with 100 KHz RBW and 300 KHz VBW. The 6dB bandwidth is defined as the total spectrum the power of which is higher than peak power minus 6dB.

#### Test Configuration

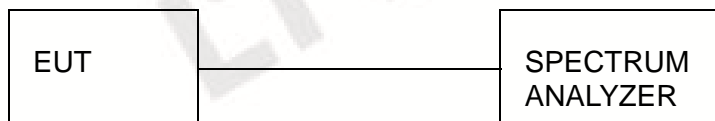

#### Test Results

##### WIFI

Type	Channel	6dB Bandwidth Ant1(MHz)	6dB Bandwidth Ant2(MHz)	6dB Bandwidth Ant3(MHz)	Limit (KHz)	Result
802.11b	01	10.38	10.33	10.39	≥500	Pass
	06	10.70	10.70	10.57		
	11	10.45	10.18	10.42		
802.11g	01	16.49	16.49	16.49	≥500	Pass
	06	16.50	16.49	16.48		
	11	16.50	16.50	16.48		
802.11n(HT20)	01	17.74	17.74	17.73	≥500	Pass
	06	17.75	17.73	17.70		
	11	17.73	17.72	17.71		
802.11n(HT40)	03	35.16	35.17	35.17	≥500	Pass
	06	35.29	35.16	35.17		
	09	35.29	35.29	35.29		

Test plot as follows:

Ant1

802.11b



802.11g

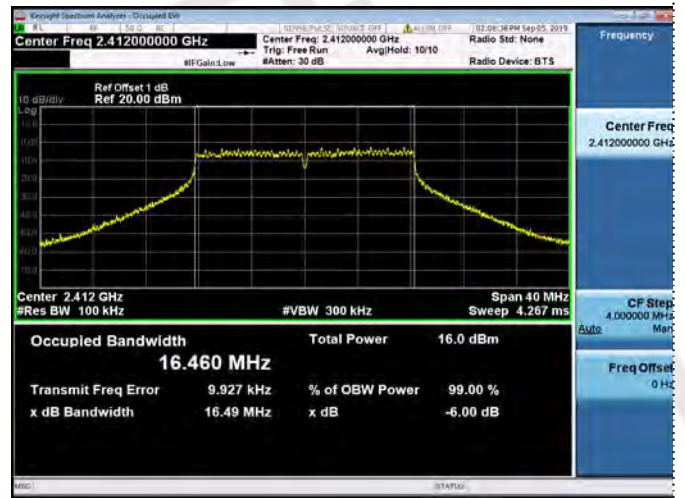

CH01



CH01



CH06

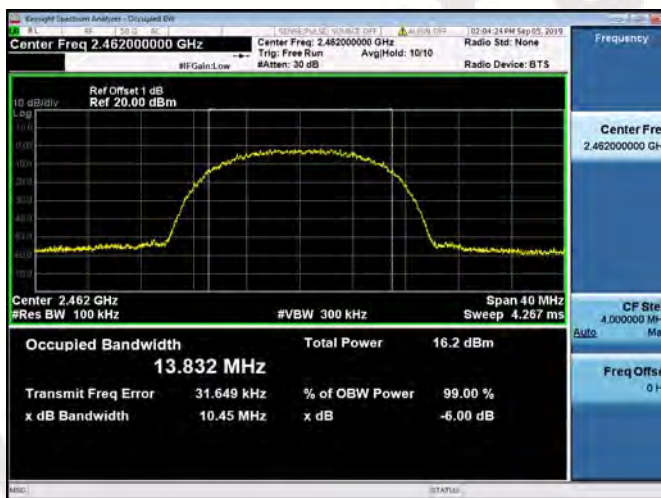

CH06



CH11

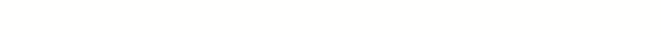

CH11



802.11n(HT20)

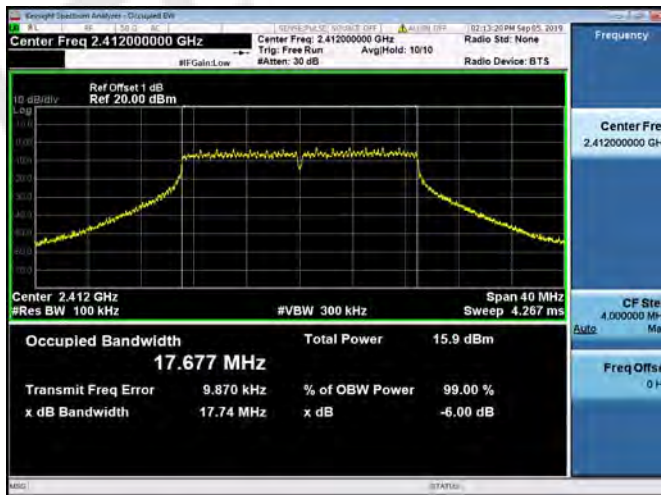

802.11n(HT40)



CH01

CH03



CH06

CH06



CH11

CH09

Ant2

802.11b

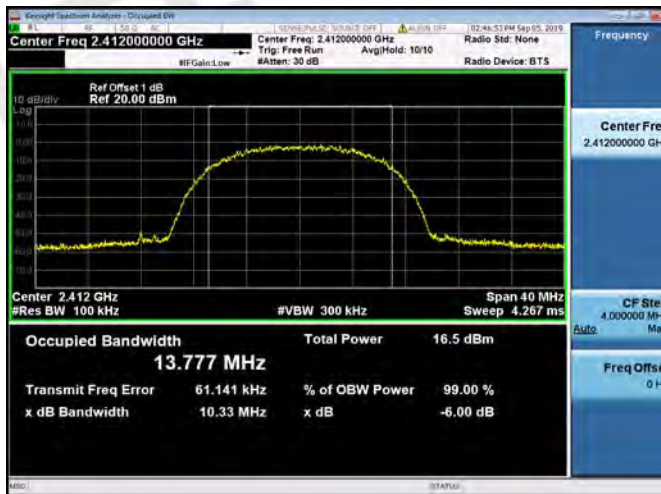

802.11g



CH01

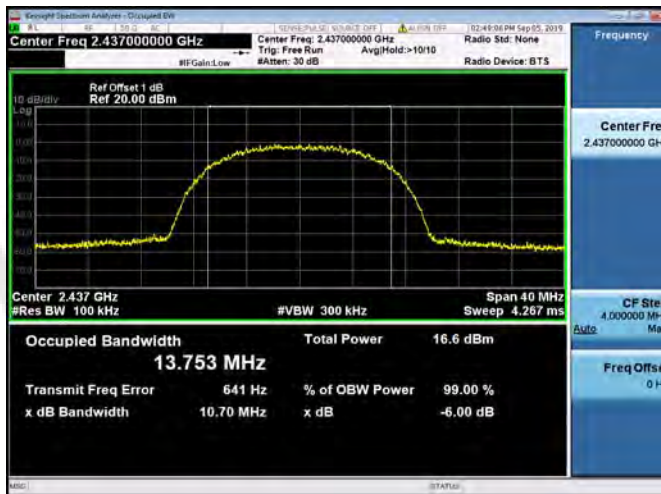

CH01



CH06



CH06



CH11



CH11





802.11n(HT20)

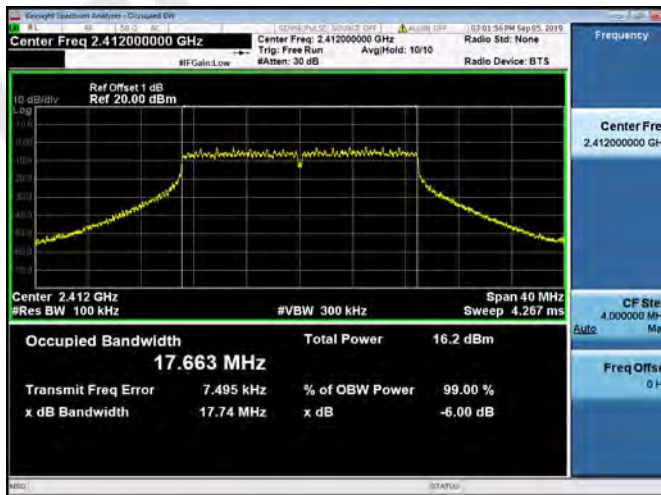

802.11n(HT40)



CH01



CH03



CH06



CH06

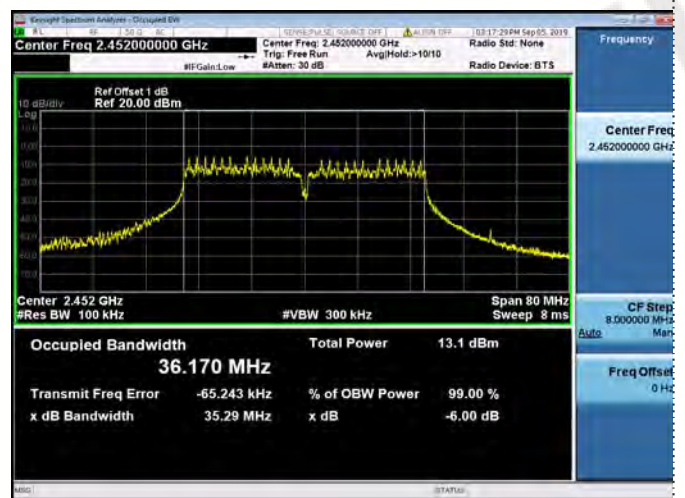

CH11

CH09

Ant3

802.11b

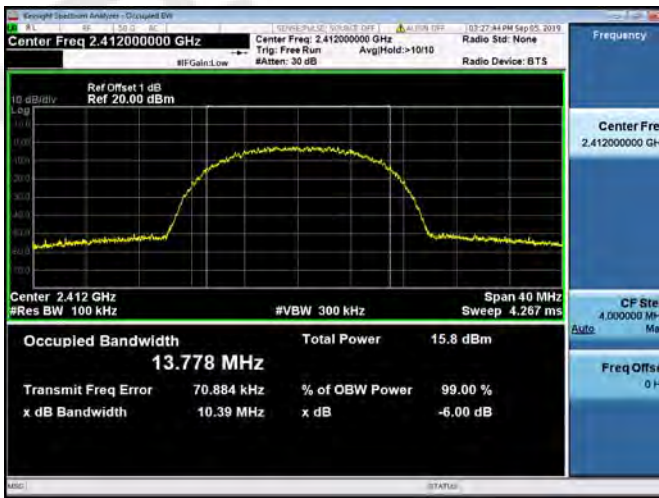

802.11g



CH01



CH01

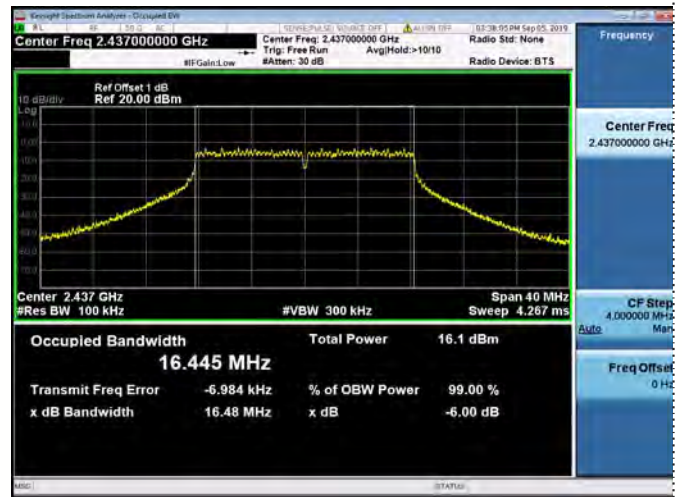

CH06



CH06



CH11



CH11



802.11n(HT20)



802.11n(HT40)

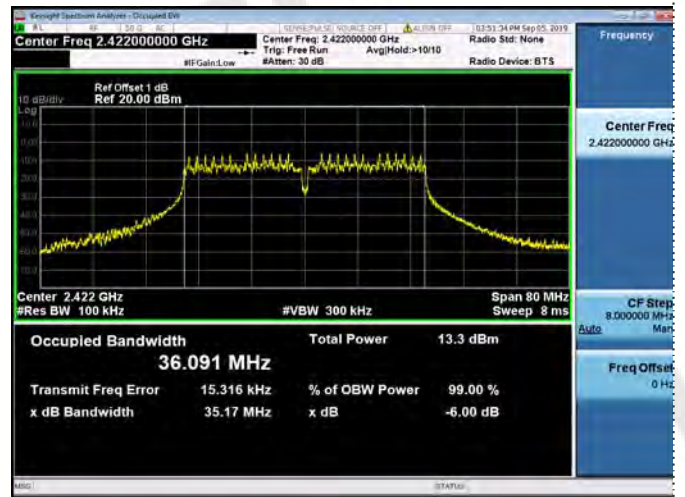

CH01



CH03



CH06



CH06

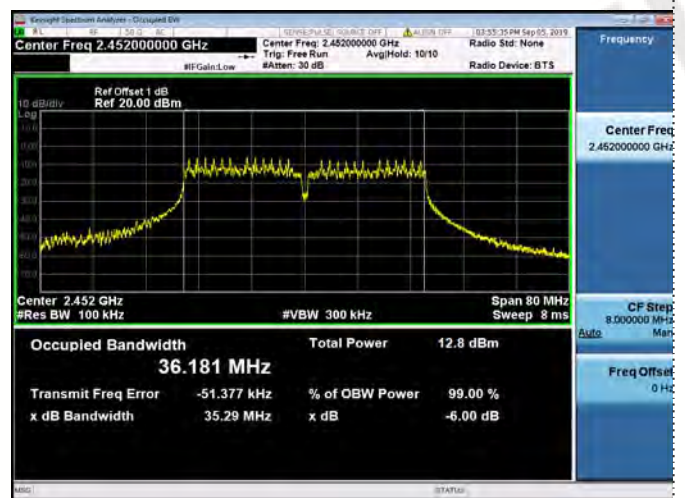

CH11

CH09

### 3.6. Out-of-band Emissions

#### Limit

In any 100 kHz bandwidth outside the frequency band in which the spread spectrum or digitally modulated intentional radiator is operating, the radio frequency power that is produced by the intentional radiator shall be at least 20 dB below that in the 100 kHz bandwidth within the band that contains the highest level of the desired power, based on either an RF conducted or a radiated measurement, provided the transmitter demonstrates compliance with the peak conducted power limits. If the transmitter complies with the conducted power limits based on the use of RMS averaging over a time interval, as permitted under paragraph (b)(3) of this section, the attenuation required under this paragraph shall be 30 dB instead of 20 dB. Attenuation below the general limits specified in §15.209(a) is not required.

#### Test Procedure

Connect the transmitter output to spectrum analyzer using a low loss RF cable, and set the spectrum analyzer to RBW=100 kHz, VBW= 300 kHz, peak detector , and max hold. Measurements utilizing these setting are made of the in-band reference level, bandedge and out-of-band emissions.

#### Test Configuration

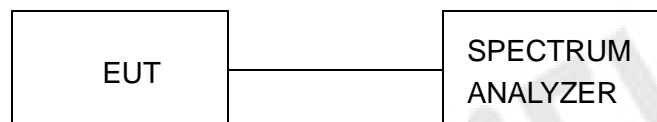

#### Test Results

Remark: The measurement frequency range is from 30MHz to the 10th harmonic of the fundamental frequency. The lowest, middle and highest channels are tested to verify the spurious emissions and bandage measurement data.

Test plot as follows:

Ant1

802.11b CH01

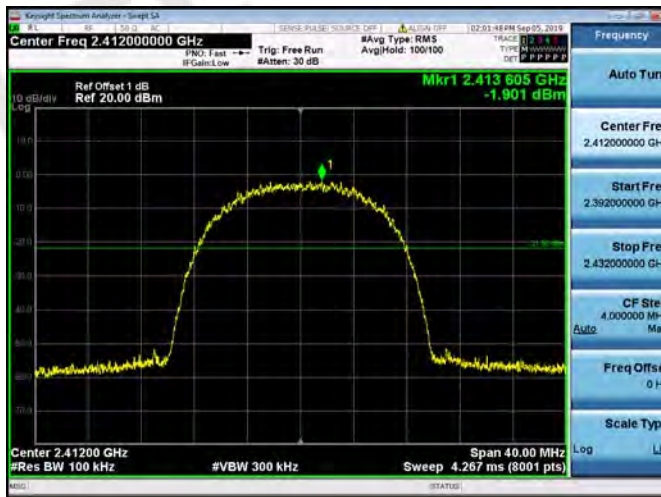

802.11b CH06

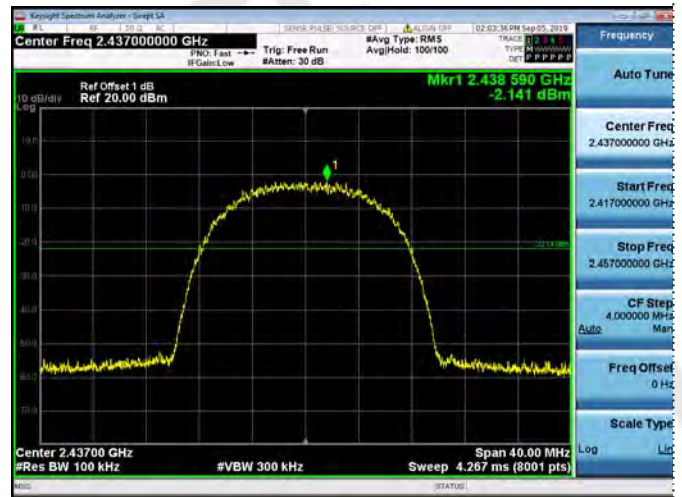

Reference

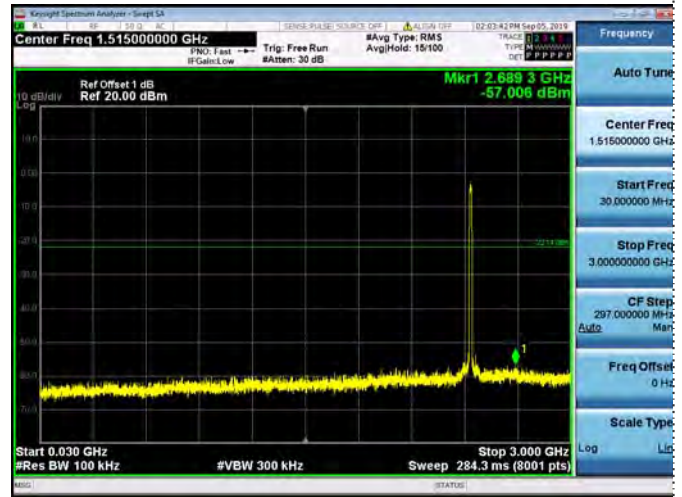
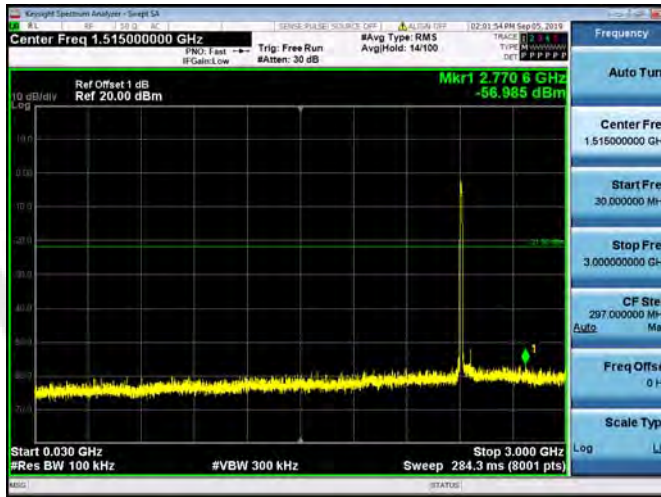

30MHz-3GHz

30MHz-3GHz

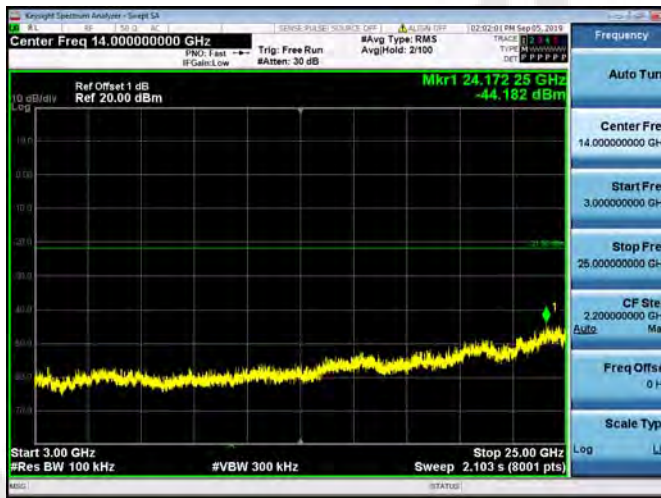

3GHz-25GHz

3GHz-25GHz

802.11b CH11

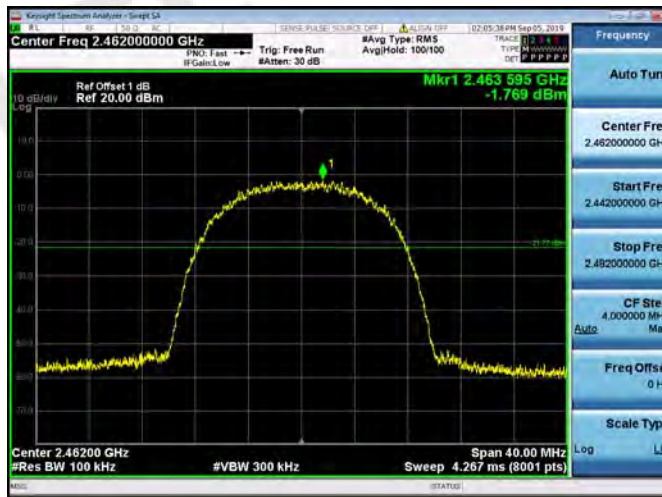

Reference

802.11g CH01

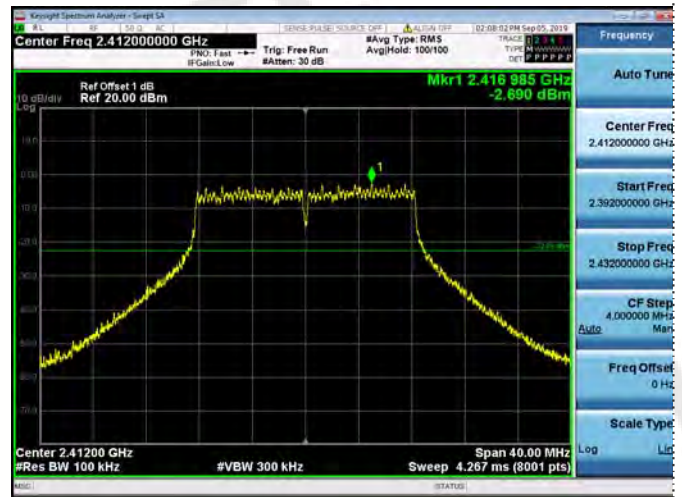

Reference

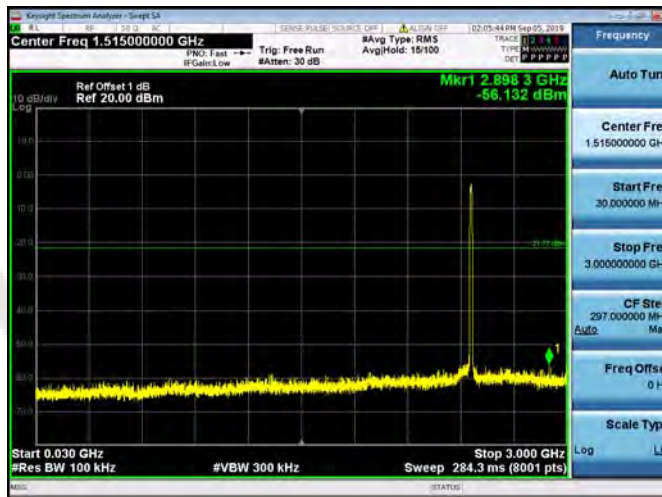

30MHz-3GHz

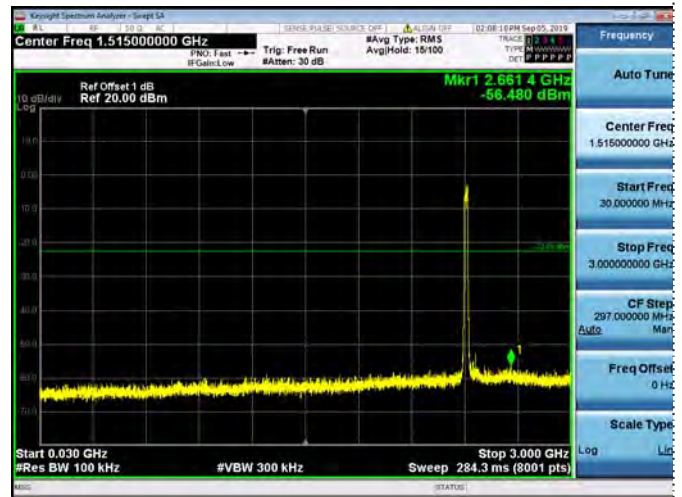

30MHz-3GHz



3GHz-25GHz



3GHz-25GHz

802.11g CH06

802.11g CH11

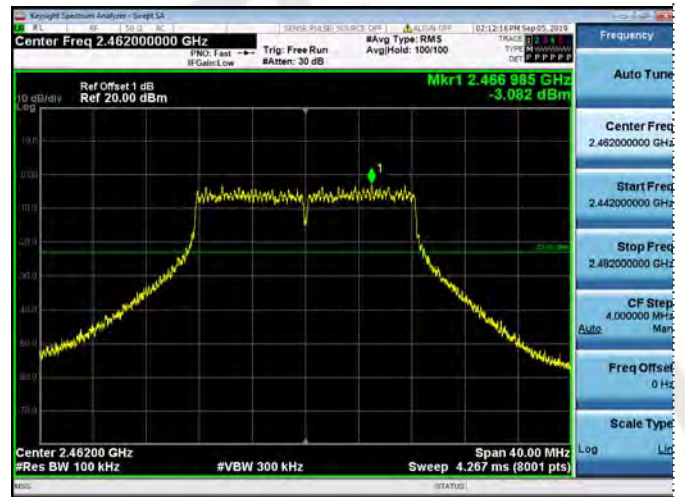
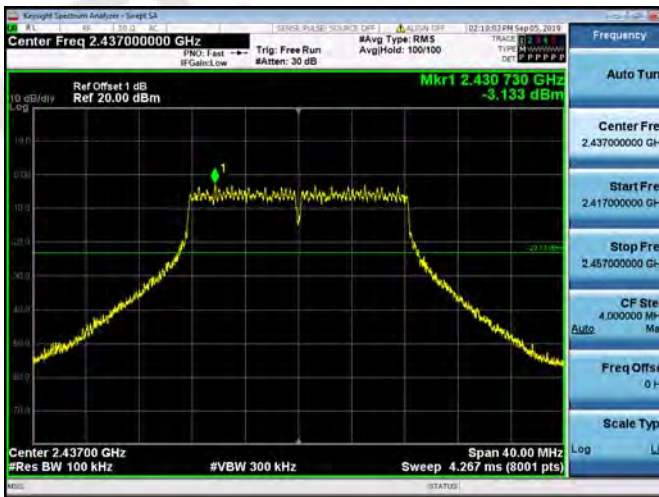

Reference

Reference

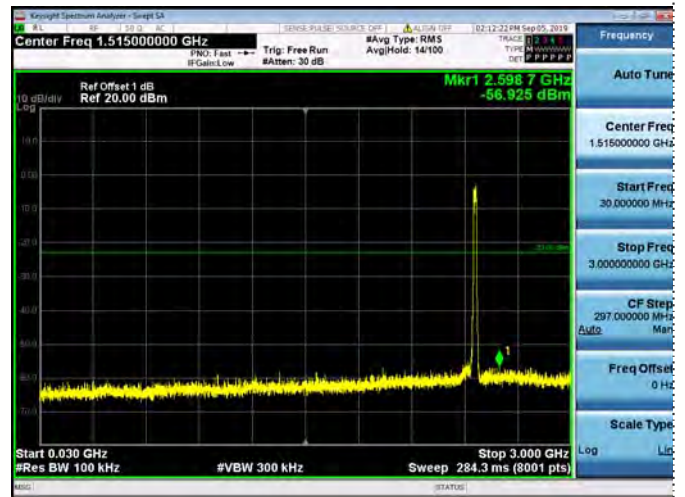
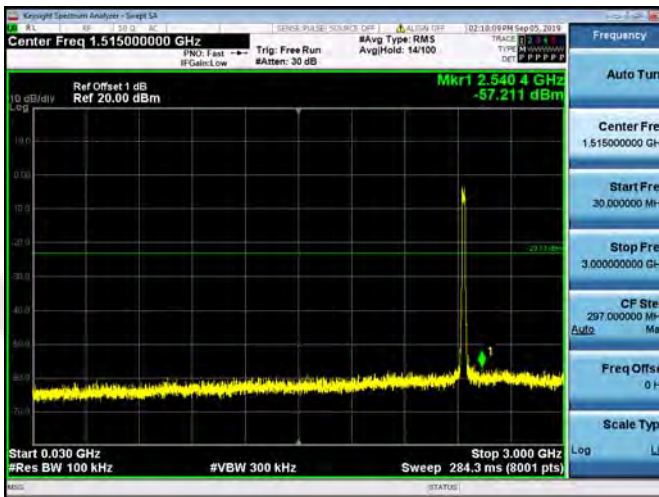

30MHz-3GHz

30MHz-3GHz



3GHz-25GHz

3GHz-25GHz

802.11n(HT20) CH01

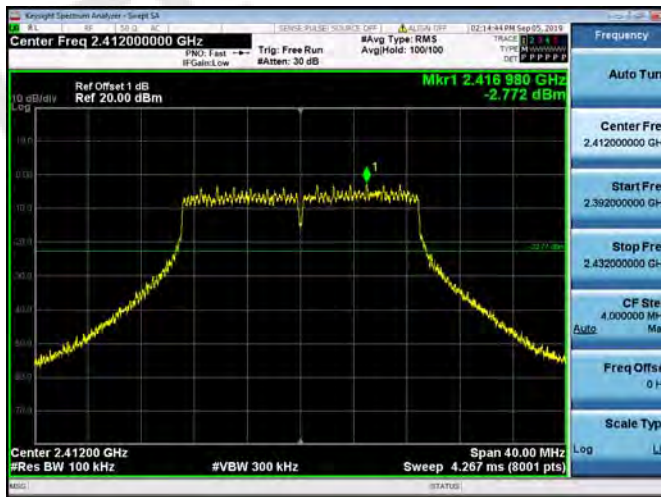

802.11n(HT20) CH06

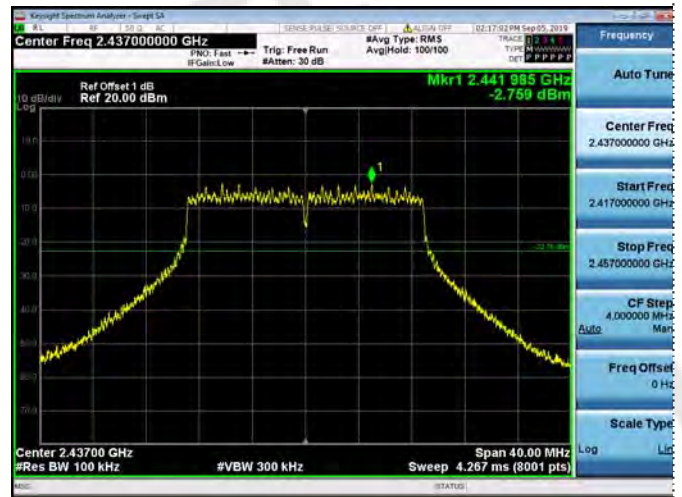

Reference

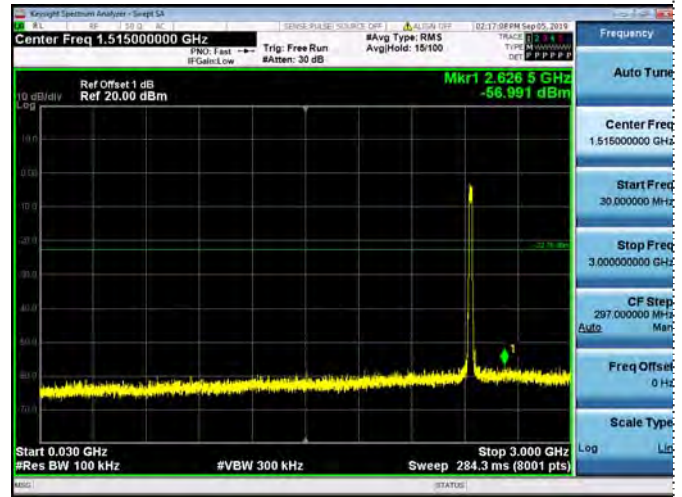
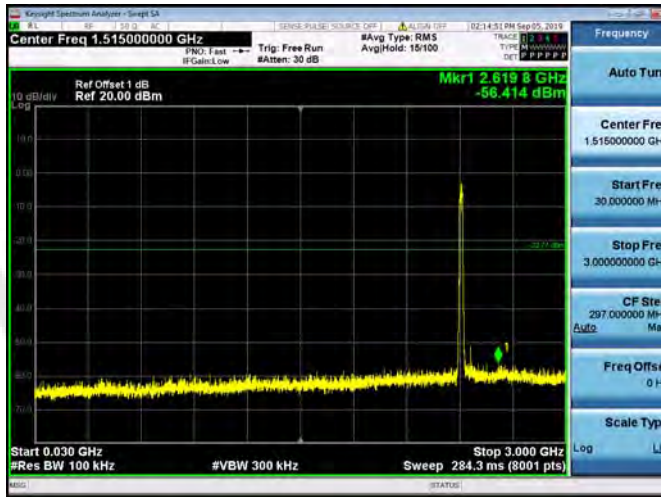

30MHz-3GHz



3GHz-25GHz

3GHz-25GHz



802.11n(HT20) CH11

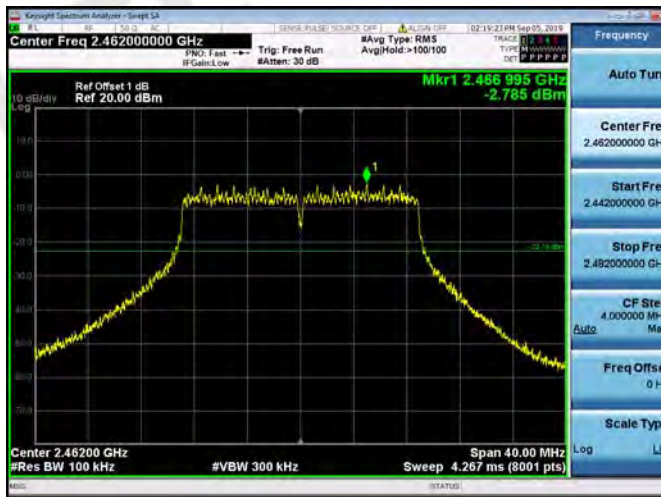

Reference

802.11n(HT40) CH03

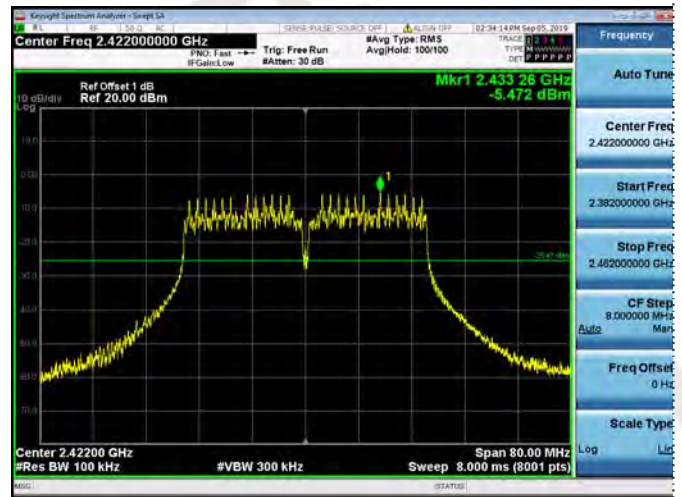

Reference

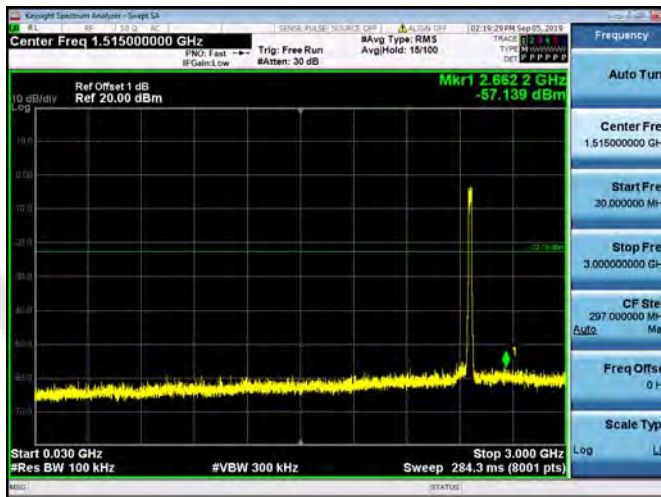

30MHz-3GHz

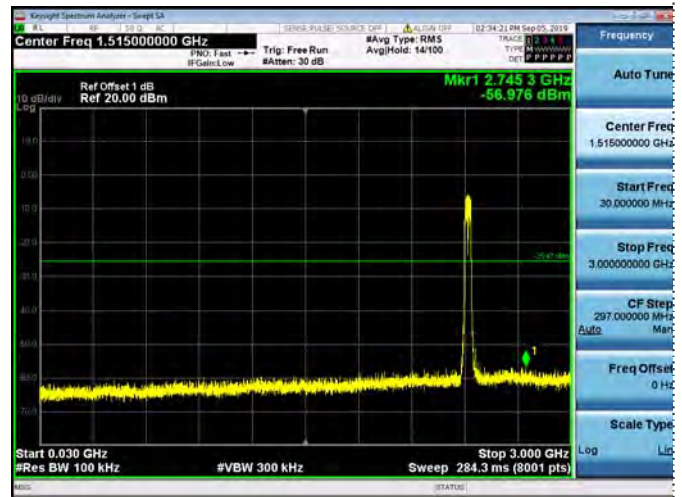

30MHz-3GHz



3GHz-25GHz



3GHz-25GHz

802.11n(HT40) CH06

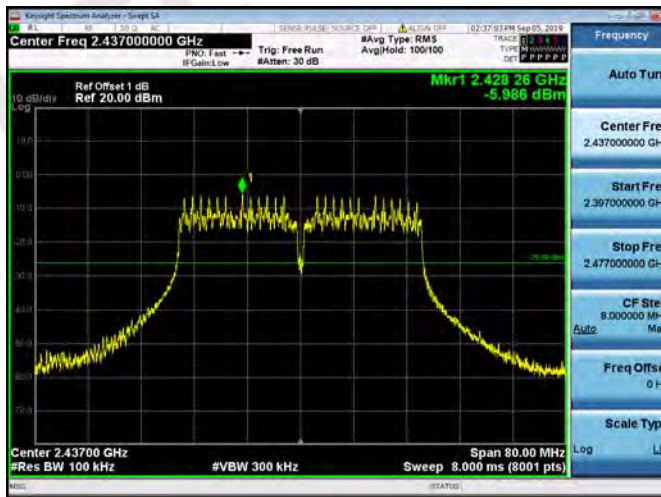

Reference

802.11n(HT40) CH09

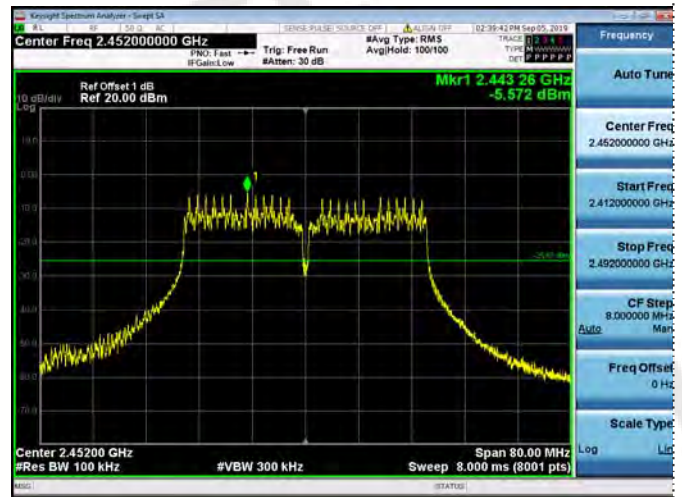

Reference

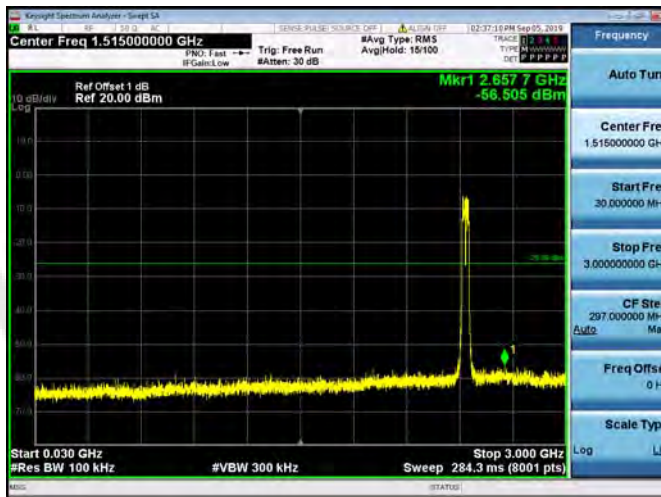

30MHz-3GHz

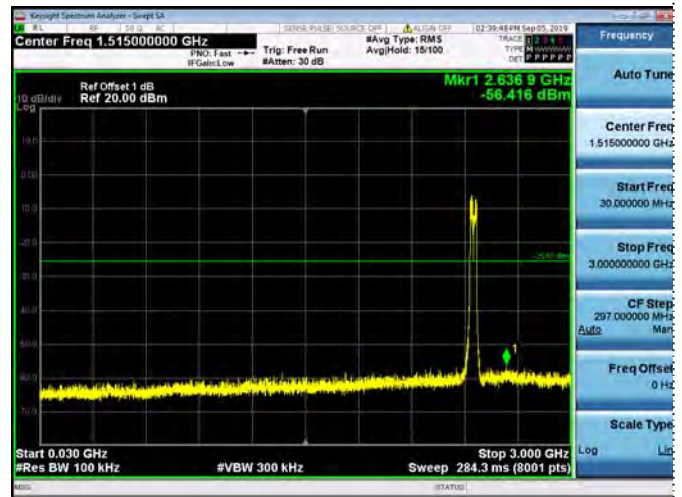

30MHz-3GHz



3GHz-25GHz



3GHz-25GHz

Ant2

802.11b CH01

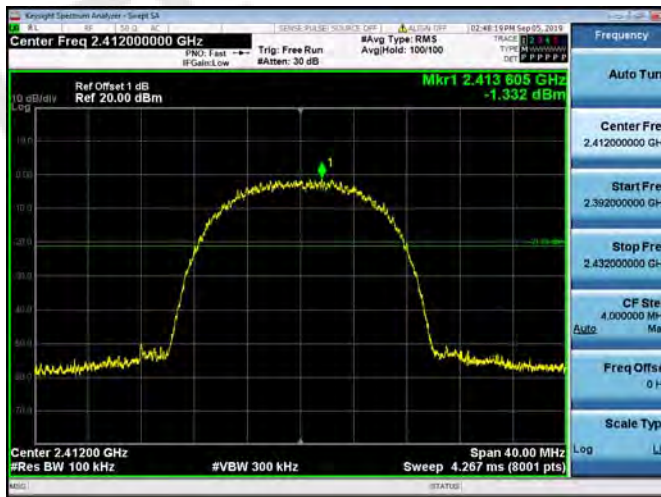

802.11b CH06



Reference

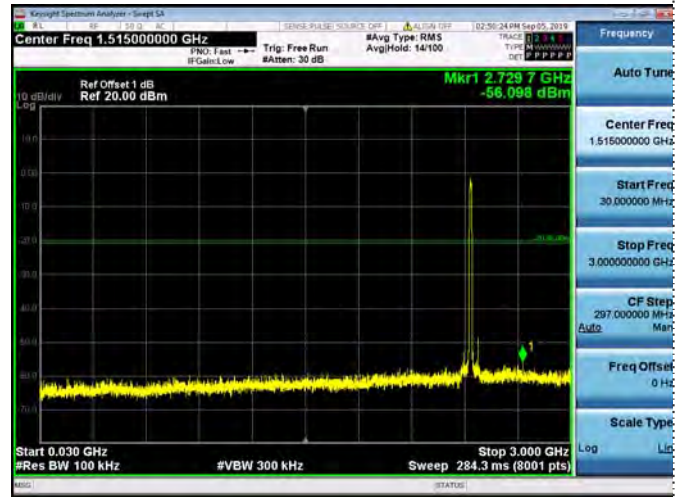
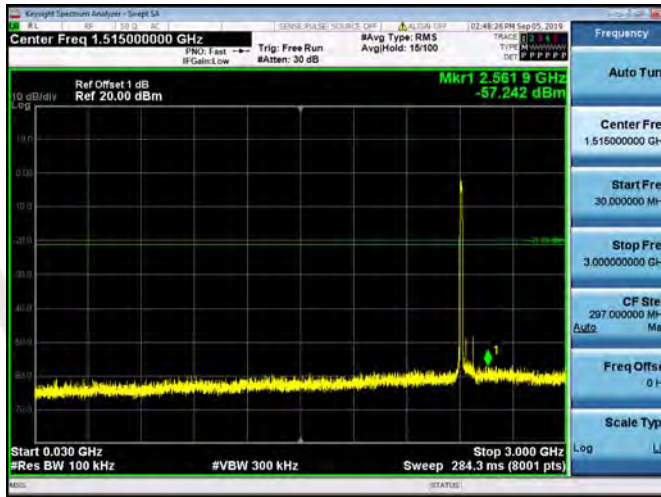

30MHz-3GHz

30MHz-3GHz



3GHz-25GHz

3GHz-25GHz

802.11b CH11

802.11g CH01

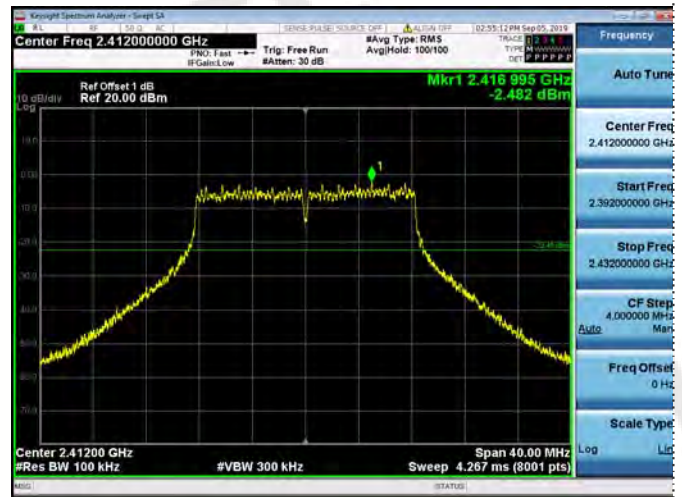

Reference

Reference

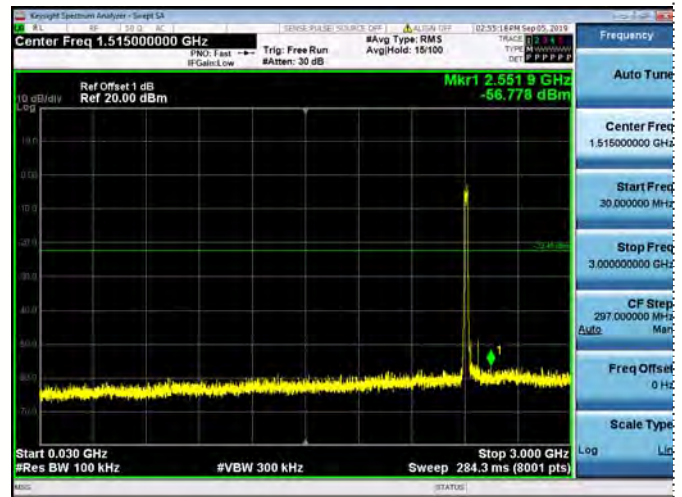
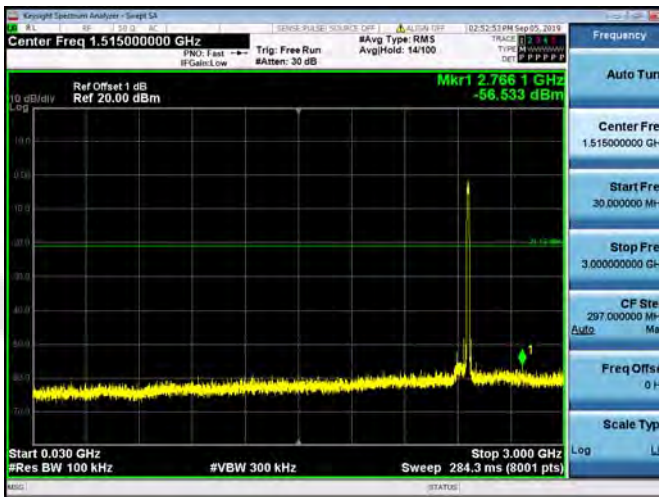

30MHz-3GHz

30MHz-3GHz



3GHz-25GHz

3GHz-25GHz

802.11g CH06

802.11g CH11

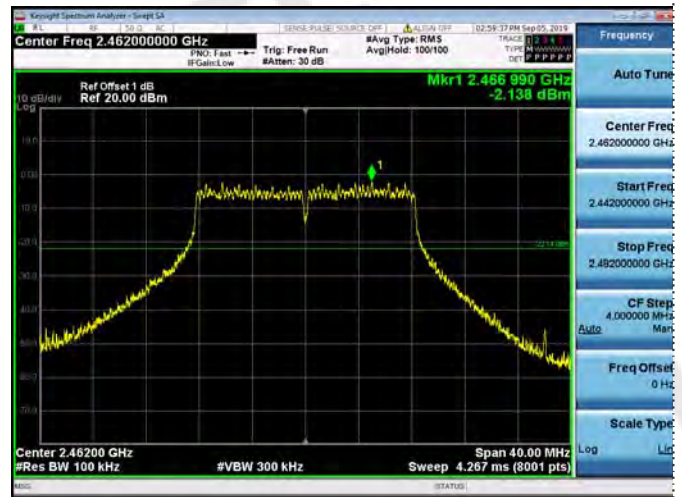
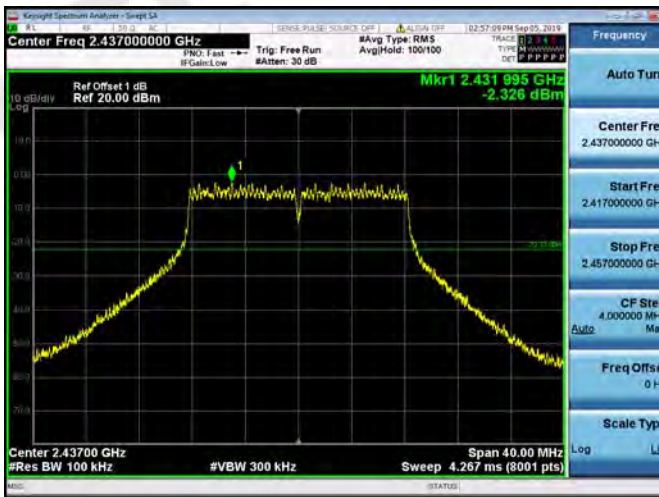

Reference

Reference

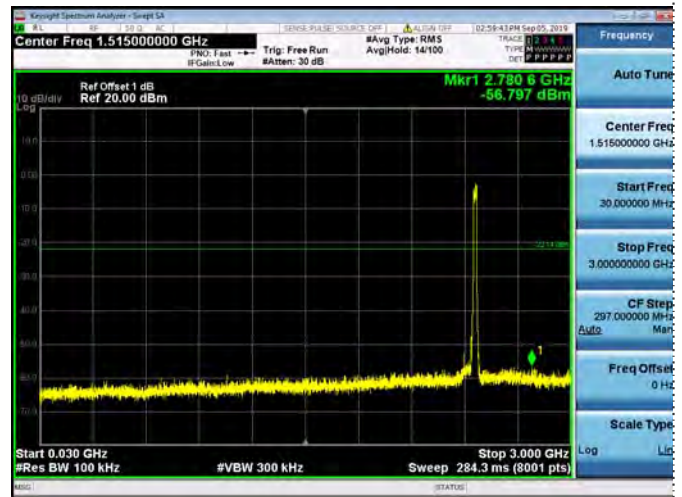
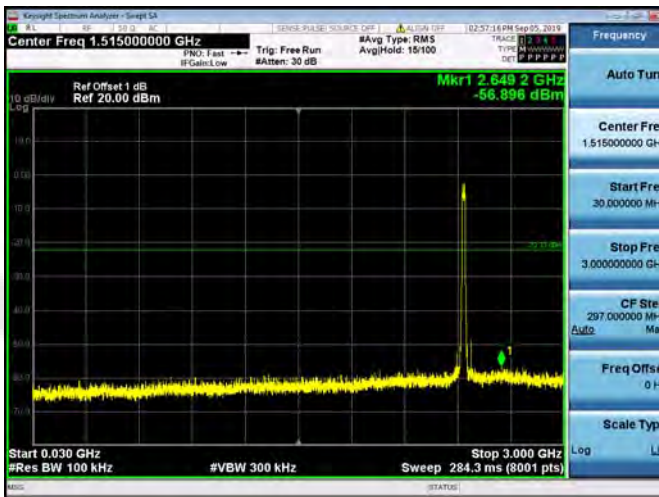

30MHz-3GHz

30MHz-3GHz



3GHz-25GHz

3GHz-25GHz

802.11n(HT20) CH01

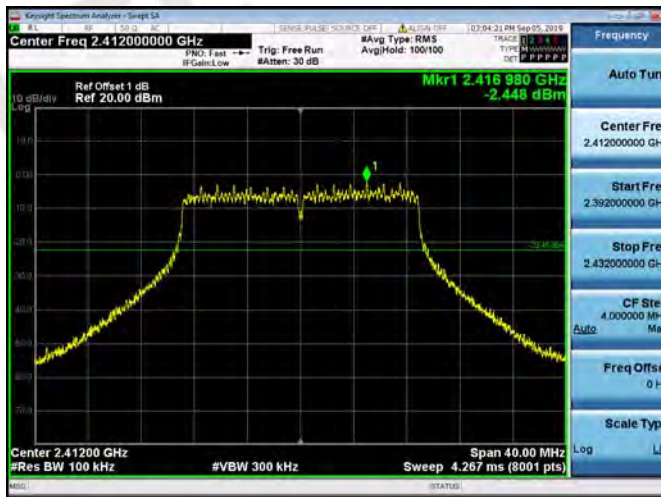

802.11n(HT20) CH06

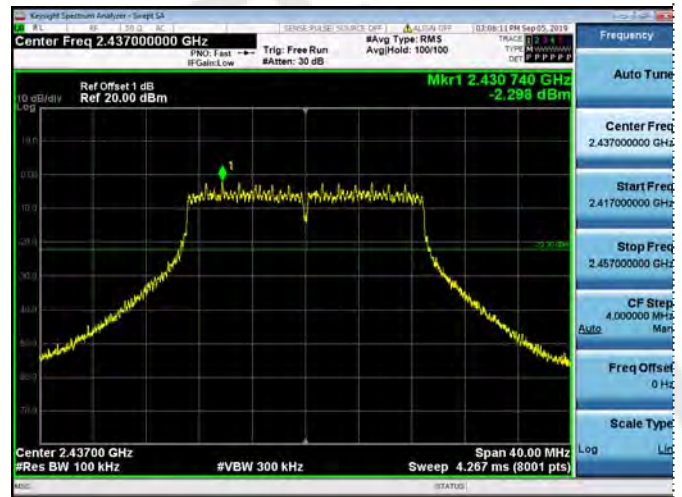

Reference

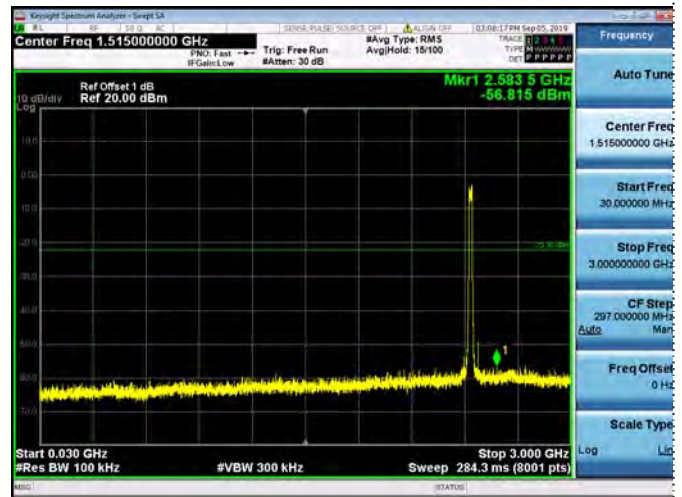
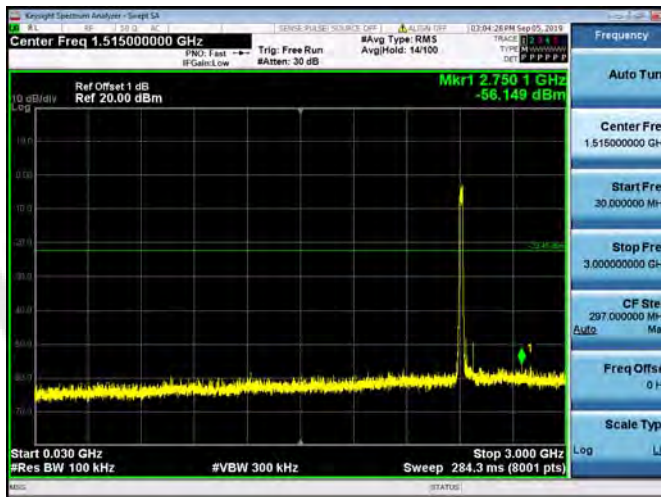

30MHz-3GHz



3GHz-25GHz

3GHz-25GHz

802.11n(HT20) CH11

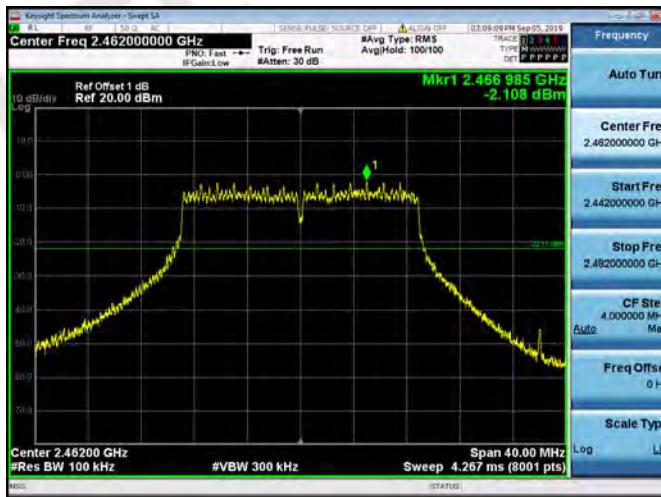

802.11n(HT40) CH03

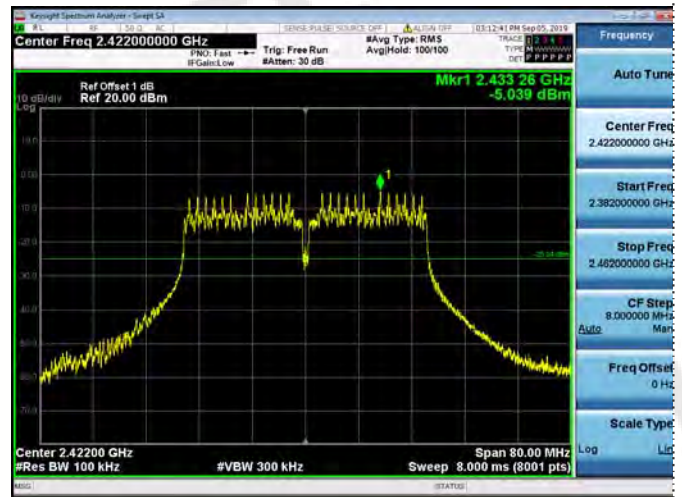

Reference

Reference

30MHz-3GHz

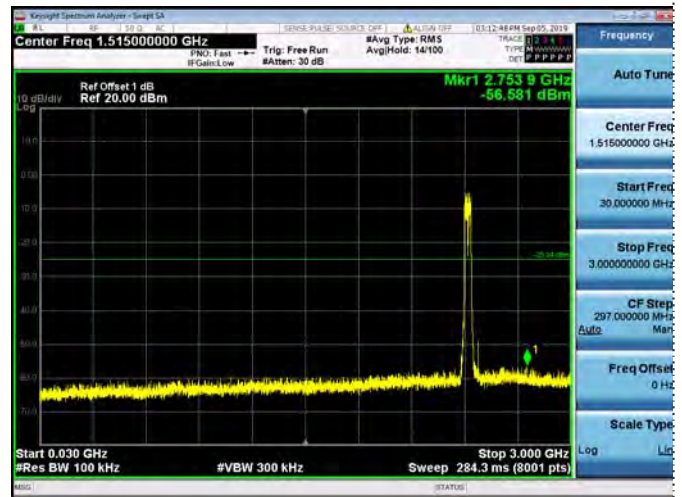
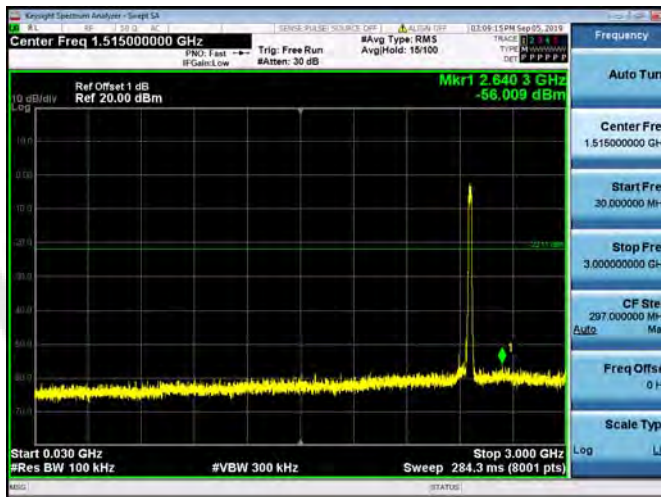

3GHz-25GHz

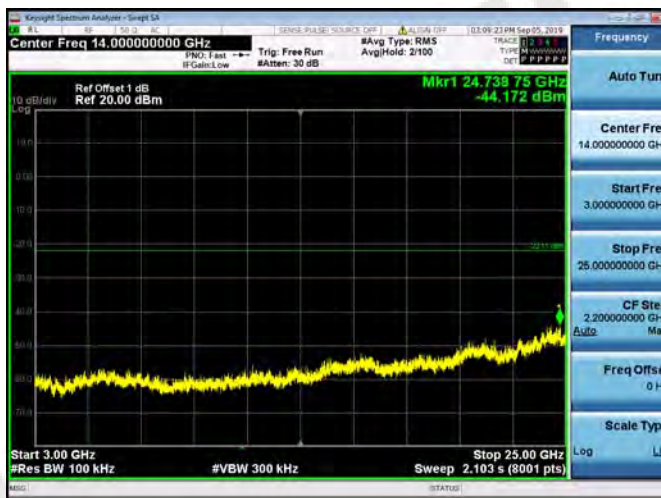

3GHz-25GHz

802.11n(HT40) CH06

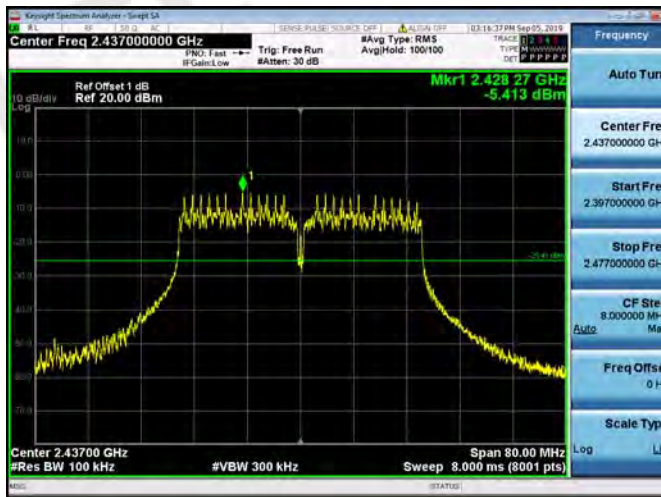

Reference

802.11n(HT40) CH09

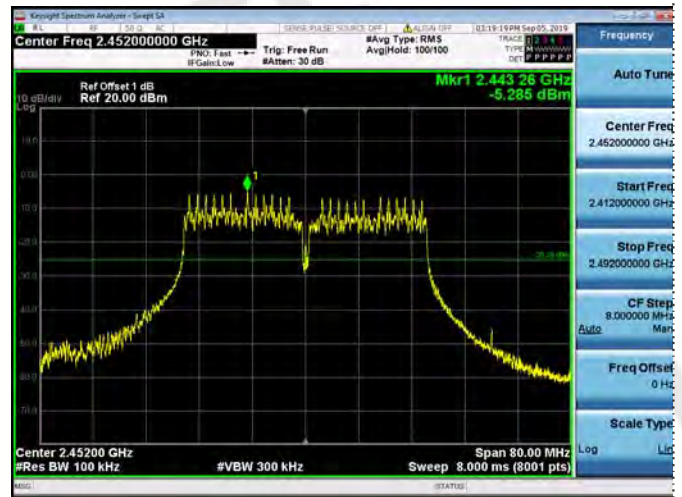

Reference

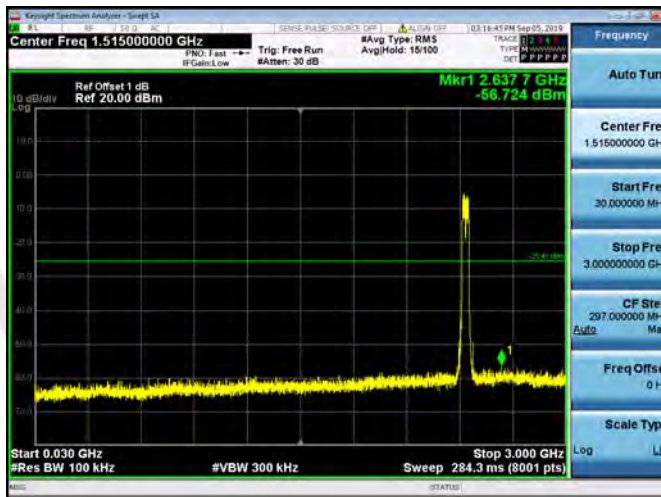

30MHz-3GHz

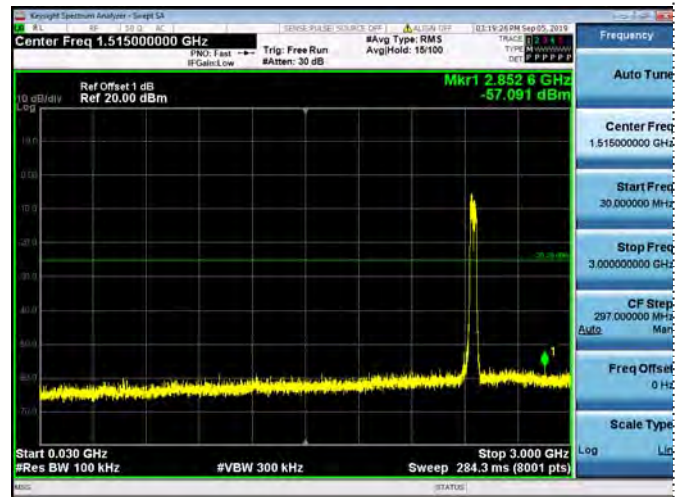

30MHz-3GHz

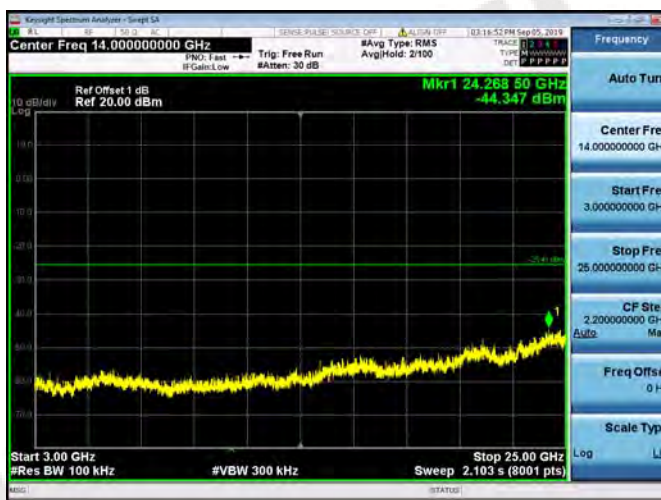

3GHz-25GHz



3GHz-25GHz



Ant3

802.11b CH01

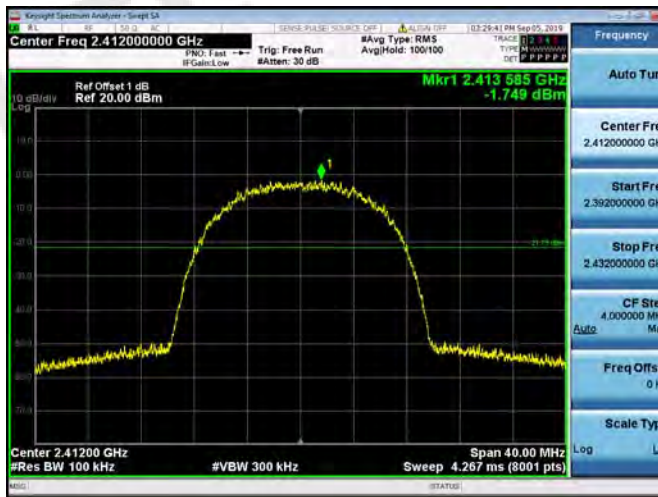

802.11b CH06



Reference

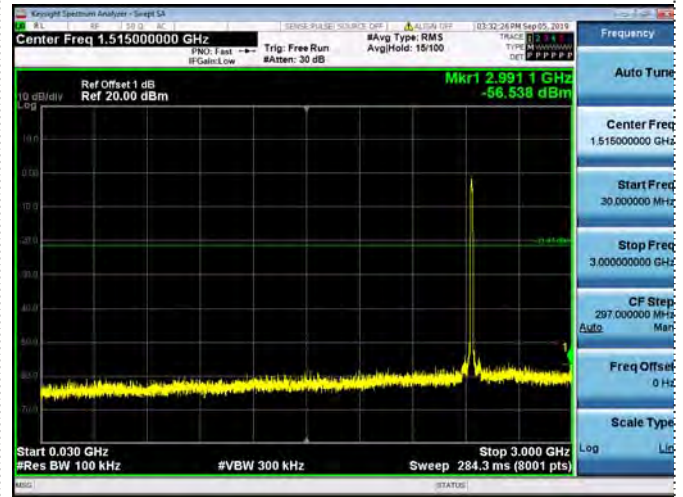
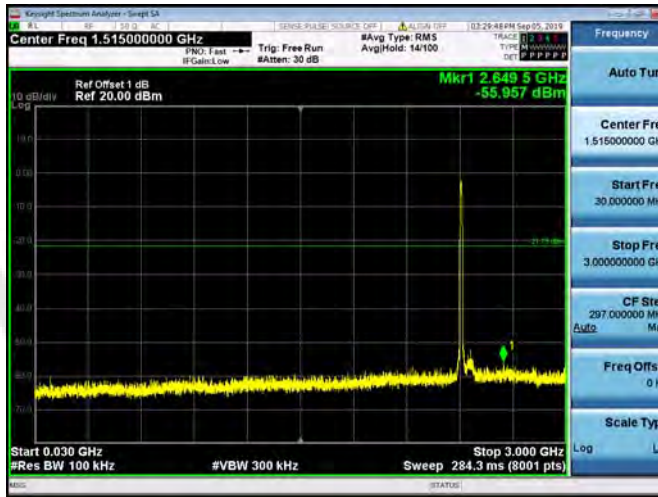

30MHz-3GHz

30MHz-3GHz



3GHz-25GHz

3GHz-25GHz

802.11b CH11

802.11g CH01

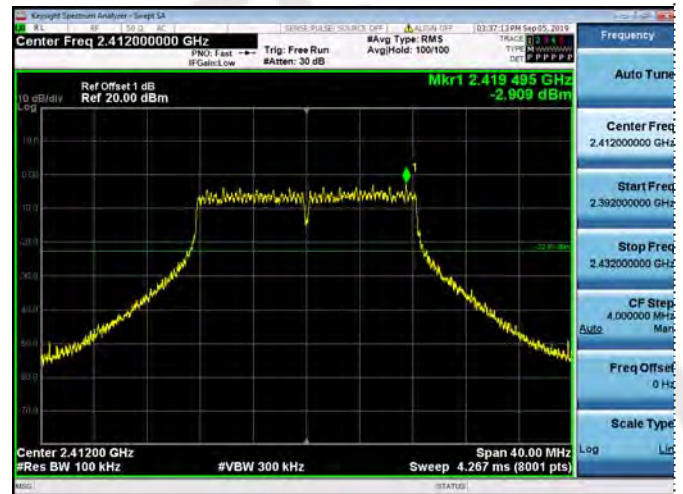
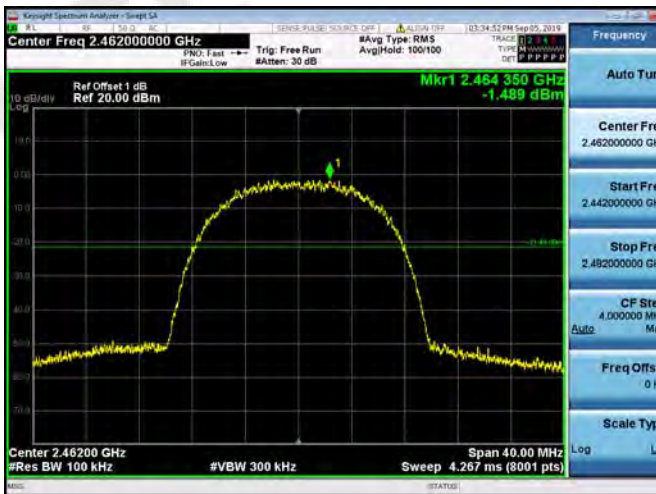

Reference

Reference

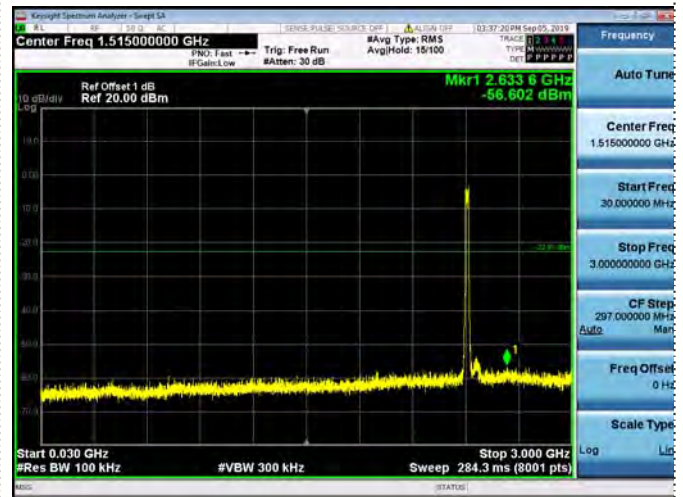
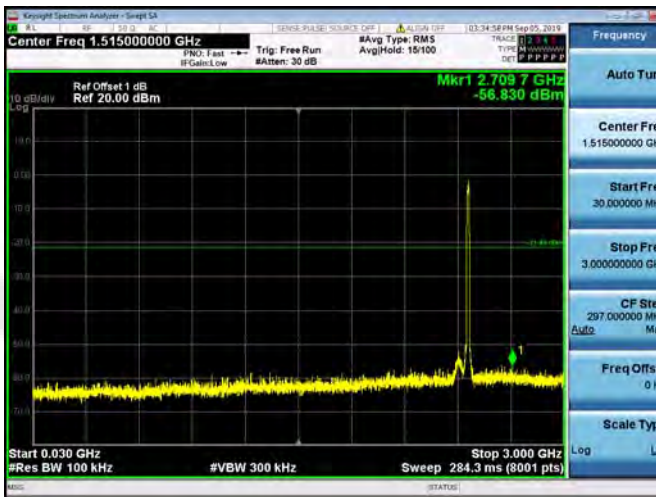

30MHz-3GHz

30MHz-3GHz



3GHz-25GHz

3GHz-25GHz

802.11g CH06

802.11g CH11

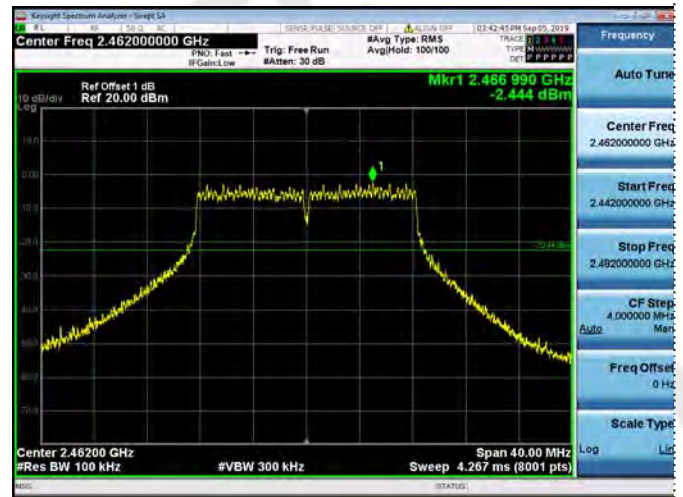
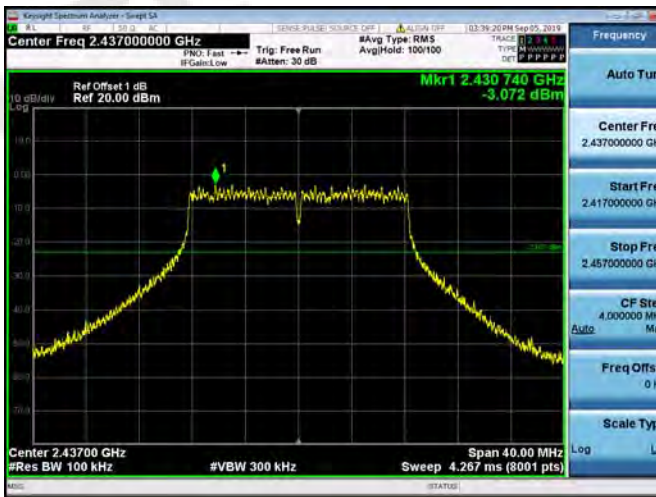

Reference

Reference

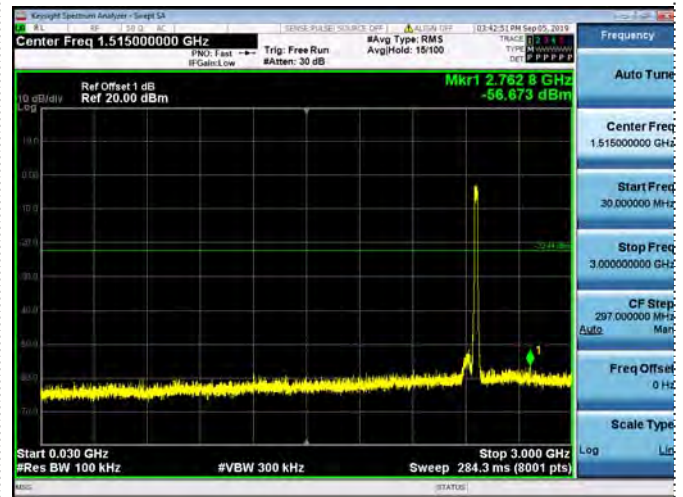
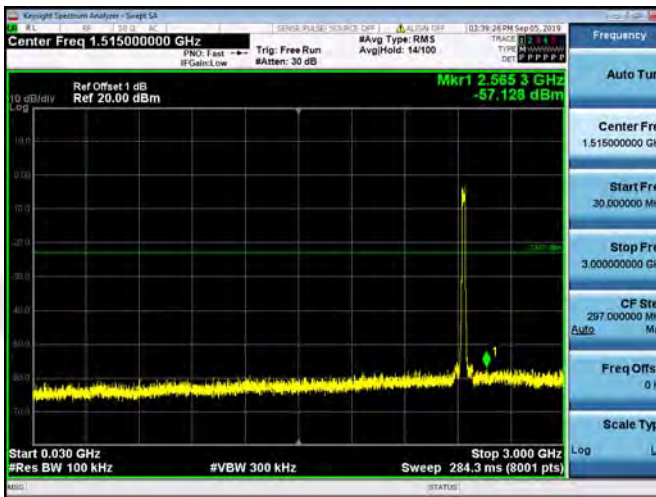

30MHz-3GHz

30MHz-3GHz



3GHz-25GHz

3GHz-25GHz

802.11n(HT20) CH01

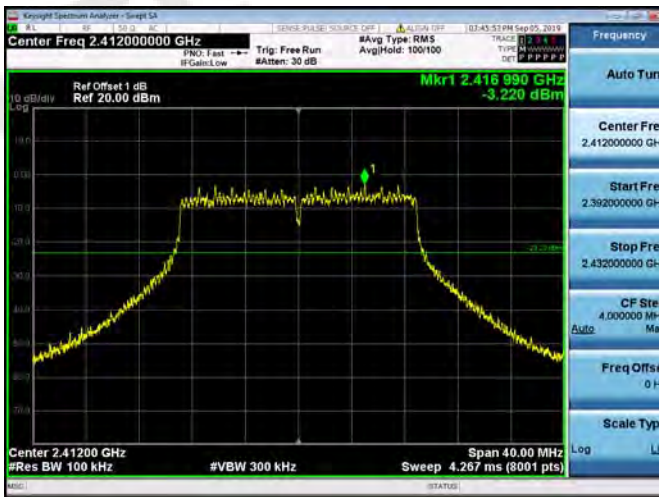

802.11n(HT20) CH06

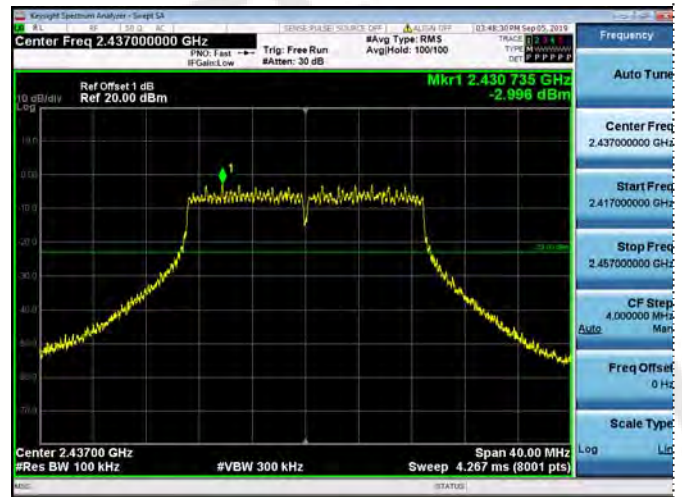

Reference

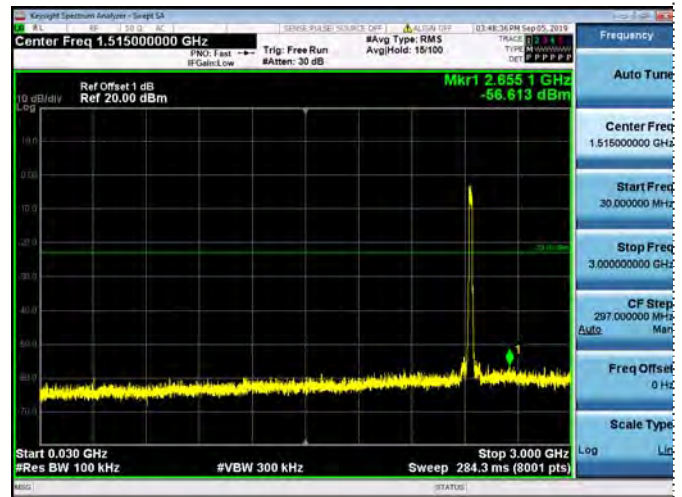
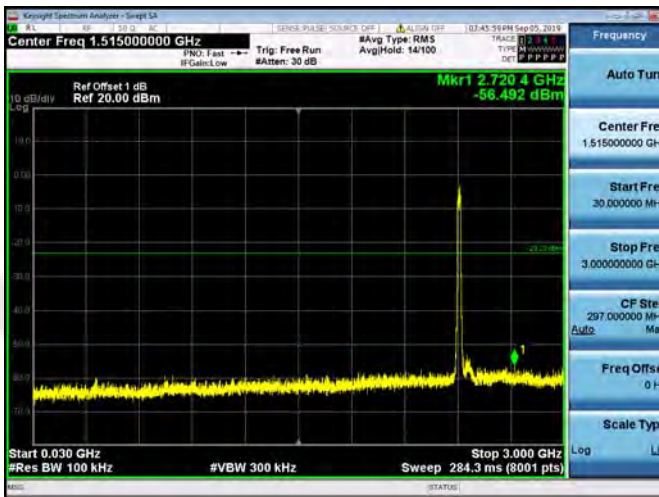

30MHz-3GHz

30MHz-3GHz



3GHz-25GHz

3GHz-25GHz

802.11n(HT20) CH11

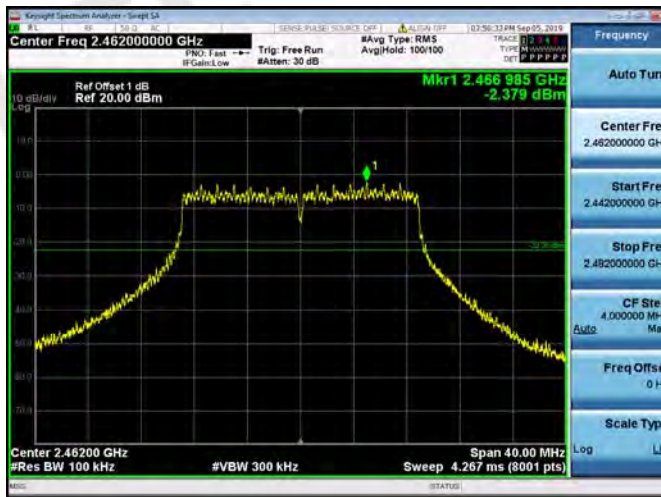

802.11n(HT40) CH03

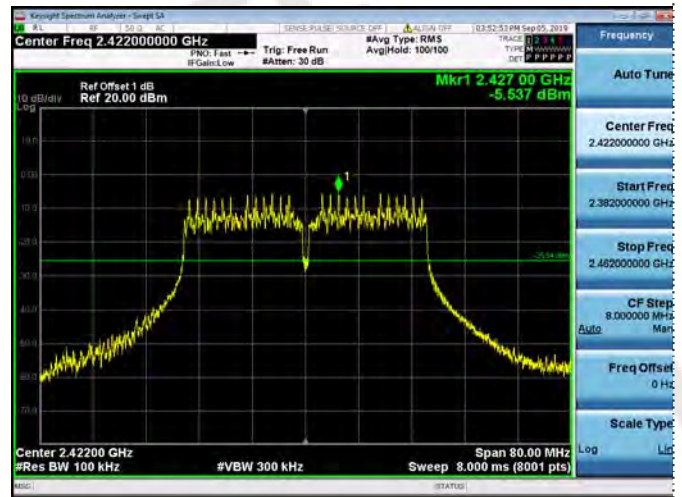

Reference

Reference

30MHz-3GHz

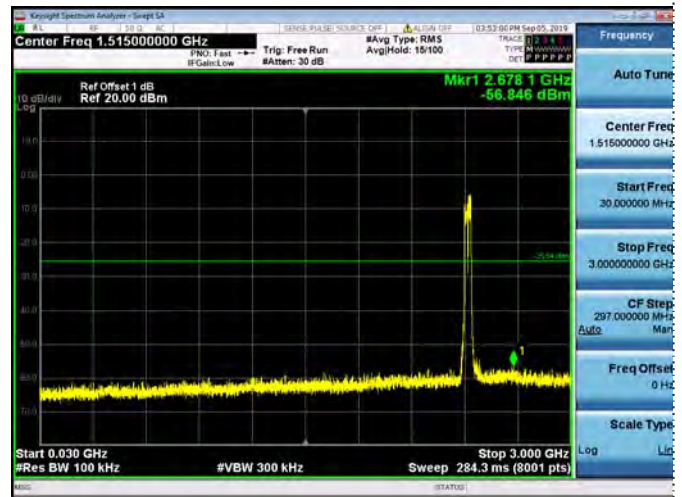
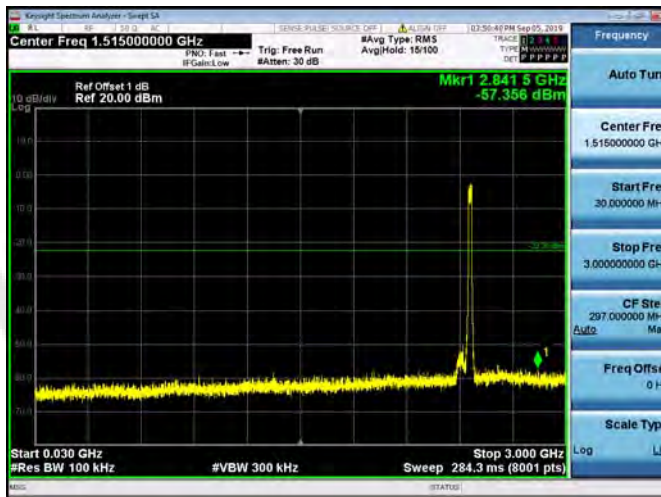

3GHz-25GHz



3GHz-25GHz

802.11n(HT40) CH06

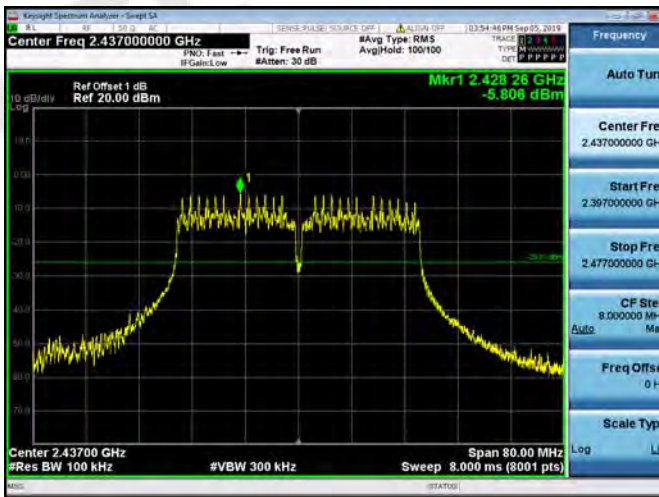

Reference

802.11n(HT40) CH09

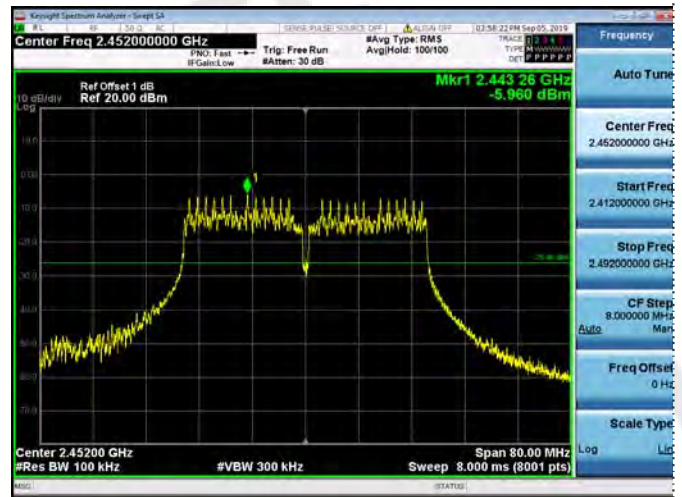

Reference

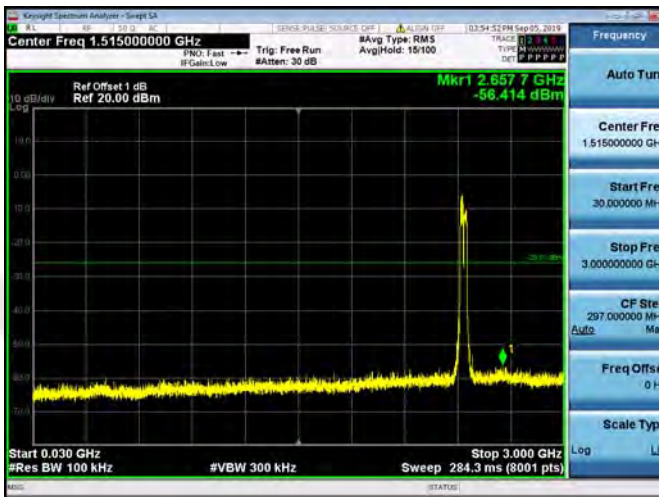

30MHz-3GHz

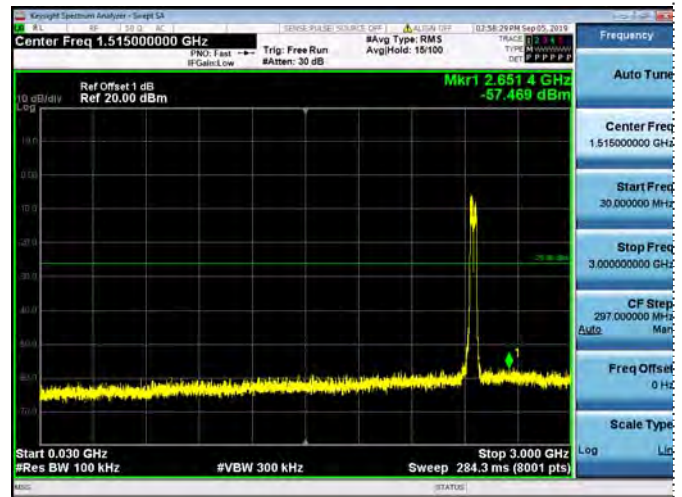

30MHz-3GHz



3GHz-25GHz



3GHz-25GHz

**Band-edge Measurements for RF Conducted Emissions:**

**Ant1  
802.11b**

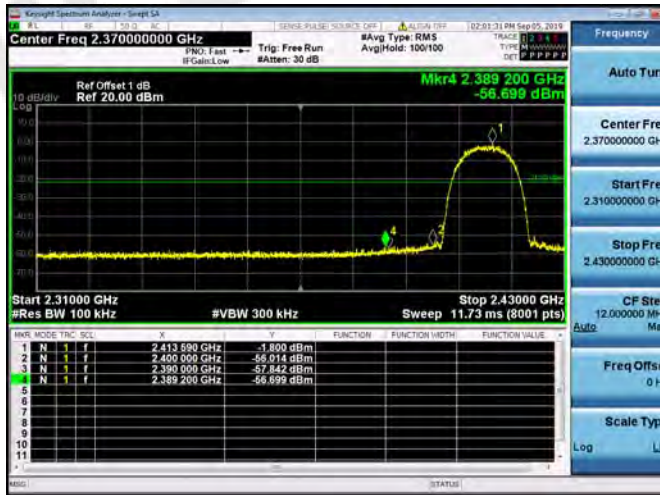

Left bandedge

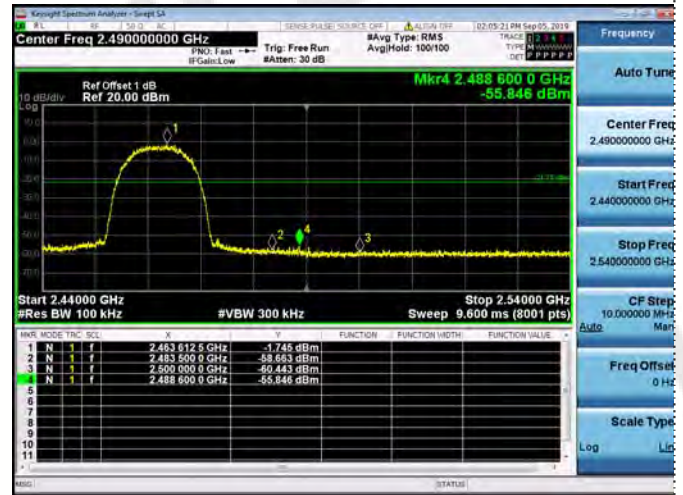

Right bandedge

**802.11g**

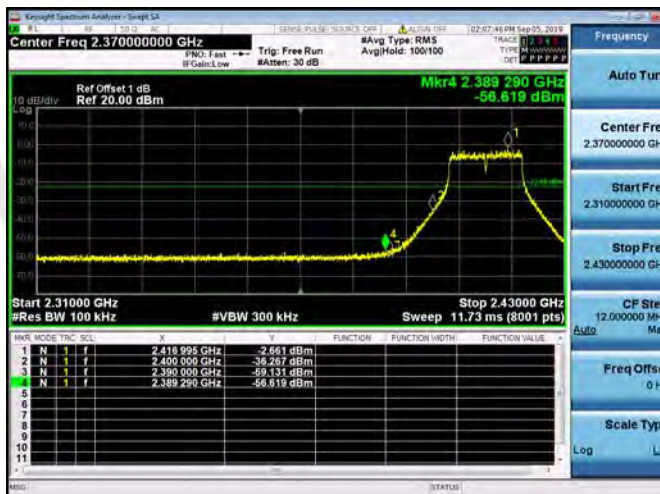

Left bandedge

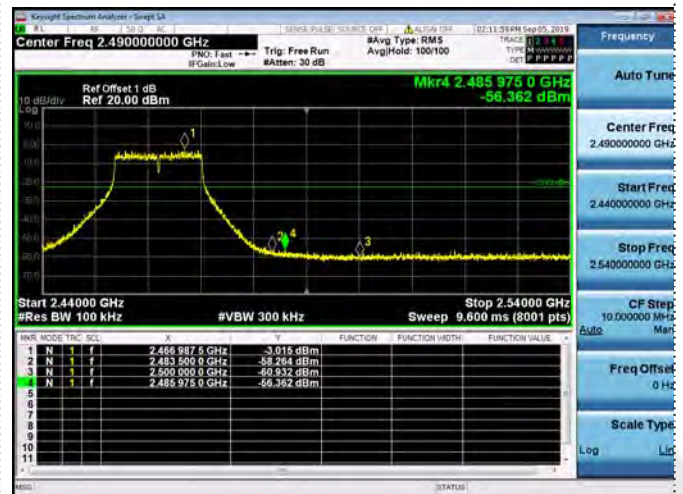

Right bandedge

**802.11n(HT20)**

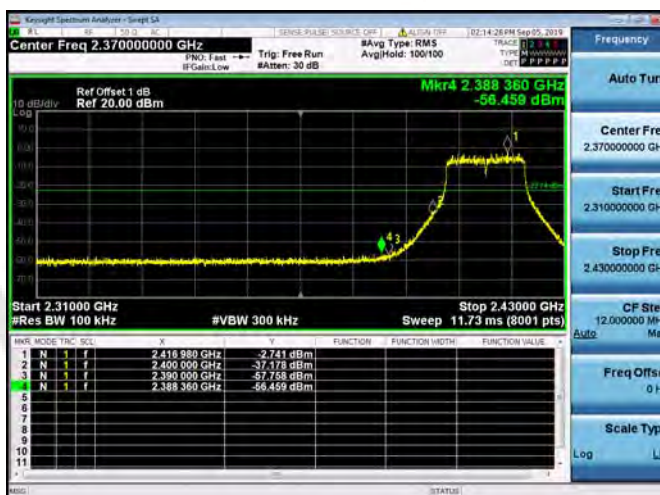

Left bandedge

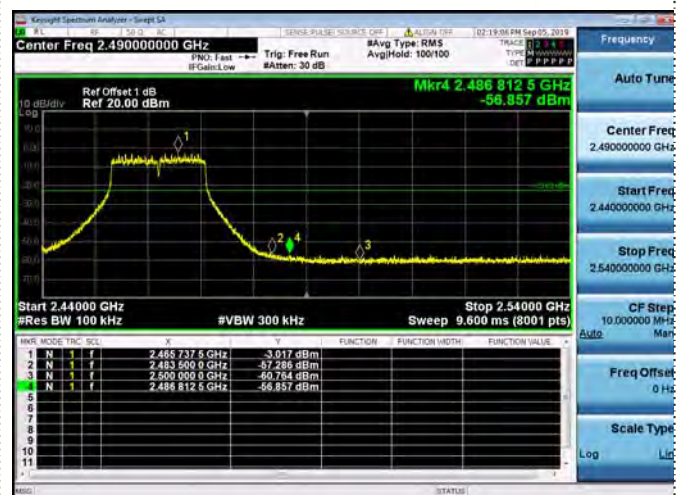

Right bandedge

### 802.11n(HT40)

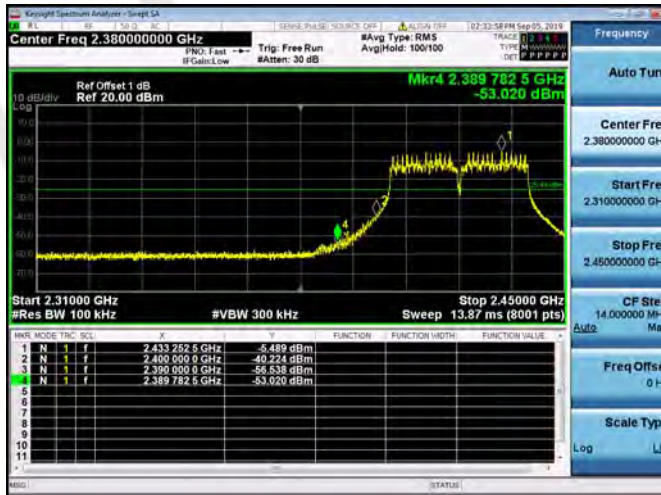

Left bandedge

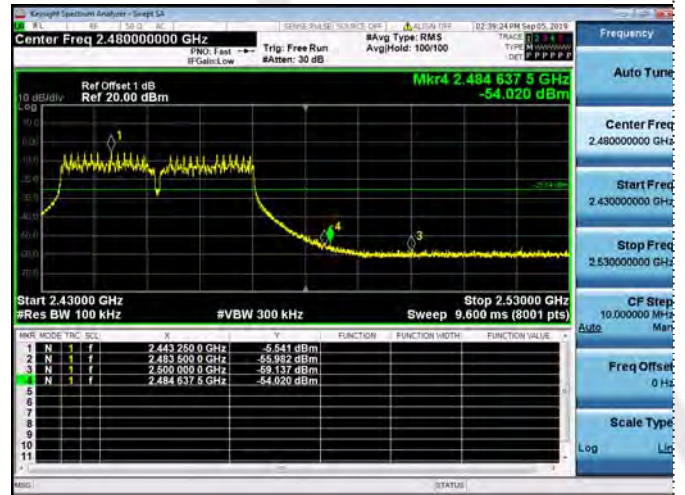

Right bandedge

### Ant2

### 802.11b

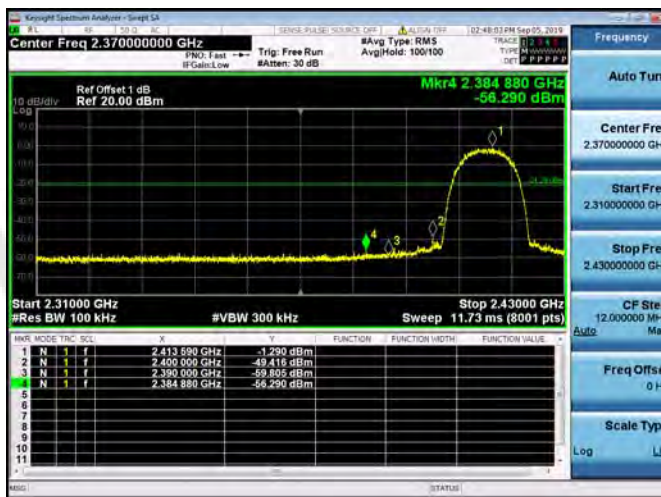

Left bandedge

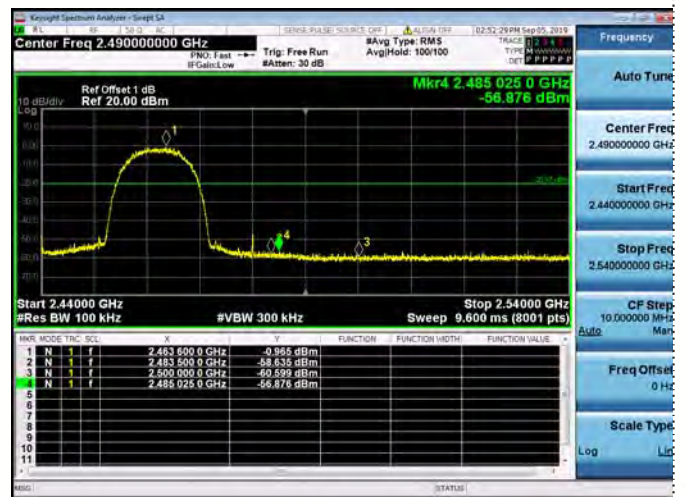

Right bandedge

### 802.11g

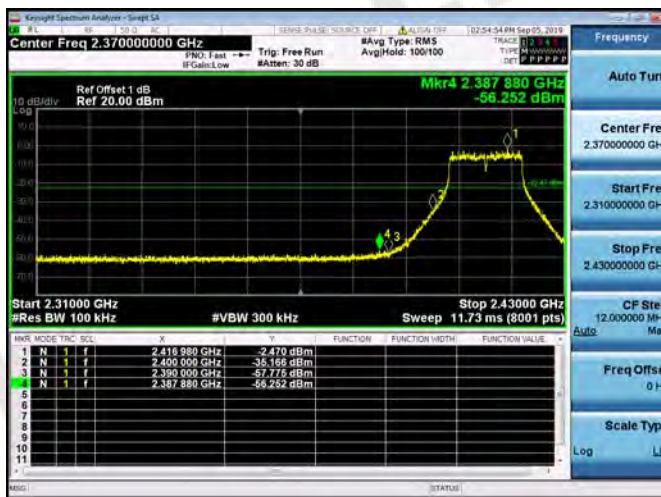

Left bandedge

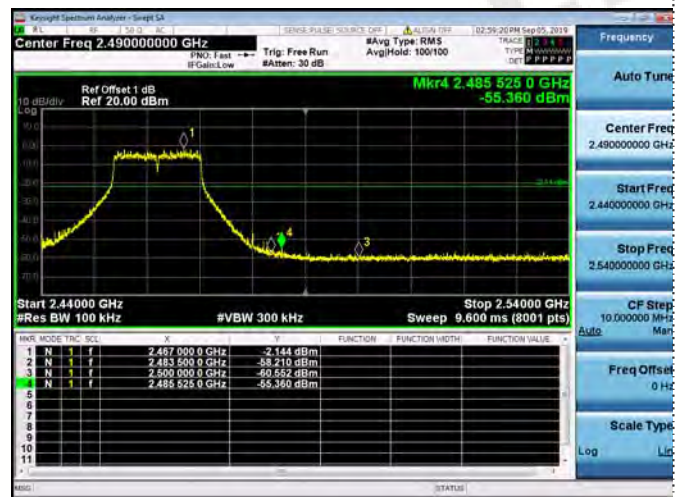

Right bandedge



### 802.11n(HT20)

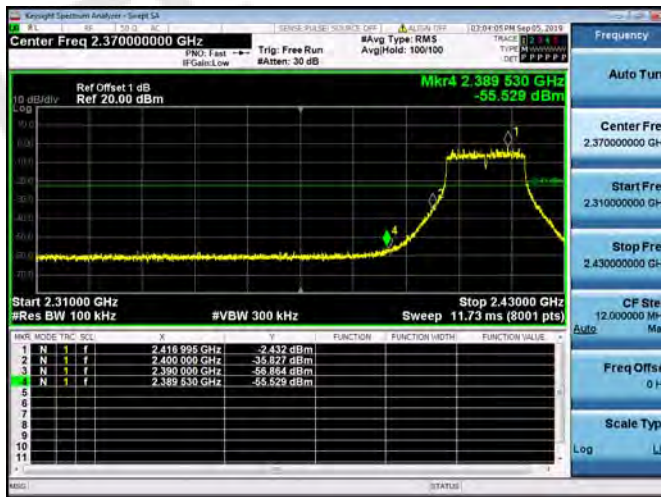

Left bandedge

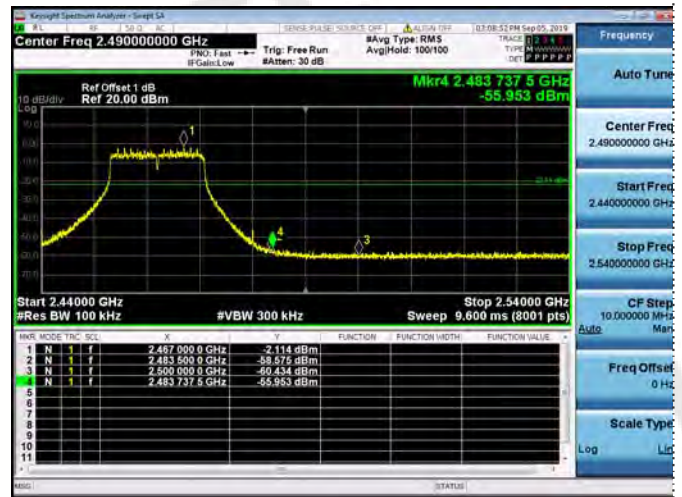

Right bandedge

### 802.11n(HT40)

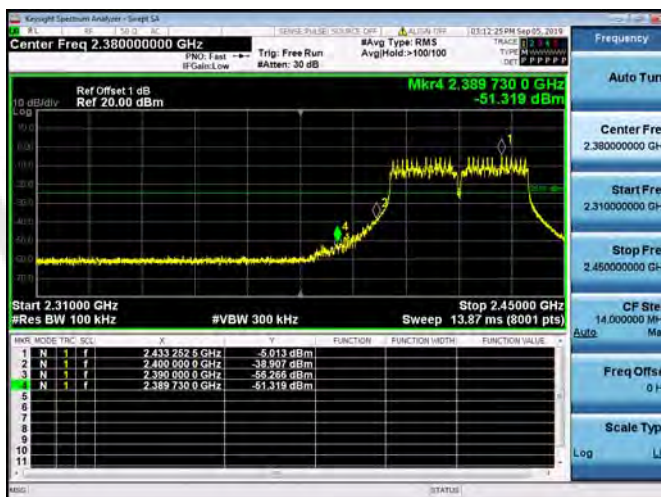

Left bandedge

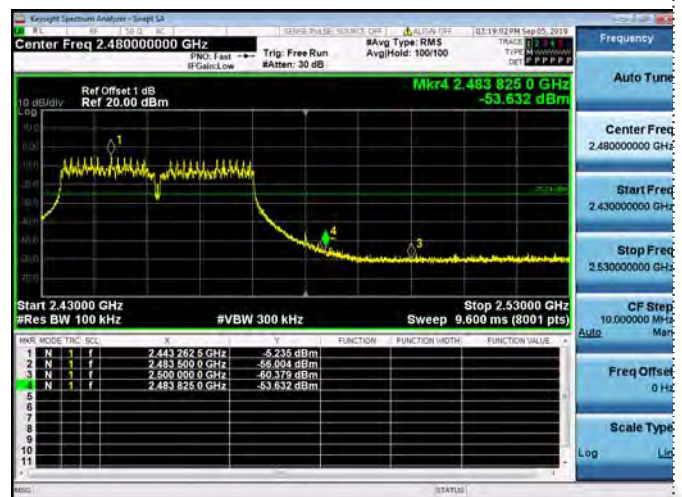

Right bandedge

### Ant3

### 802.11b

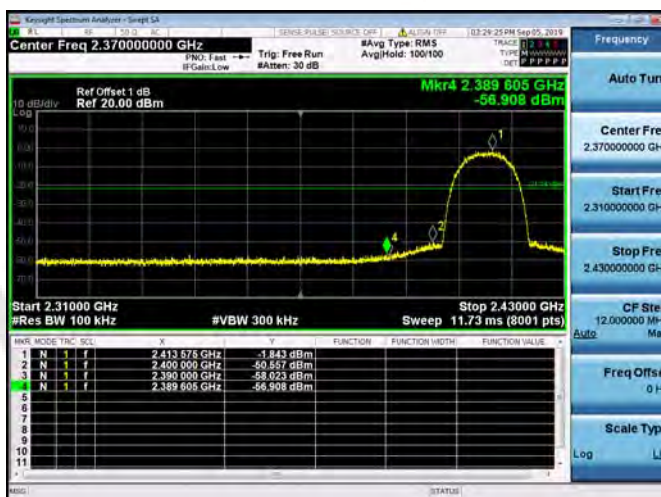

Left bandedge

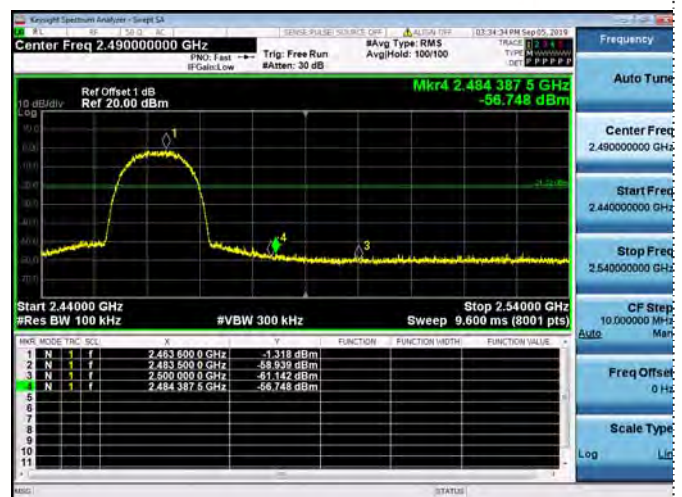

Right bandedge

### 802.11g

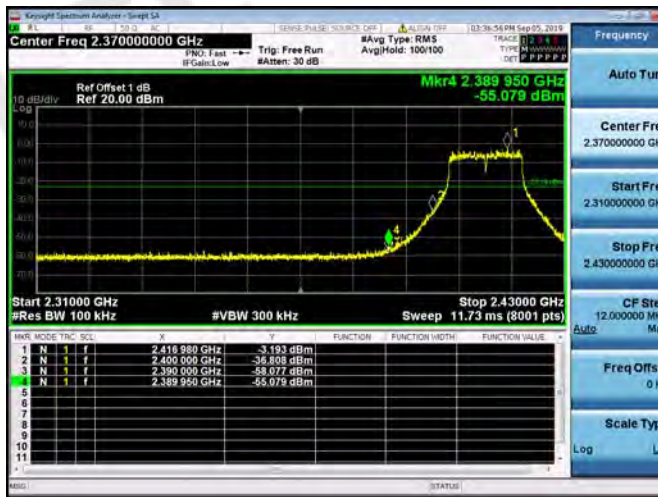

Left bandedge



Right bandedge

### 802.11n(HT20)

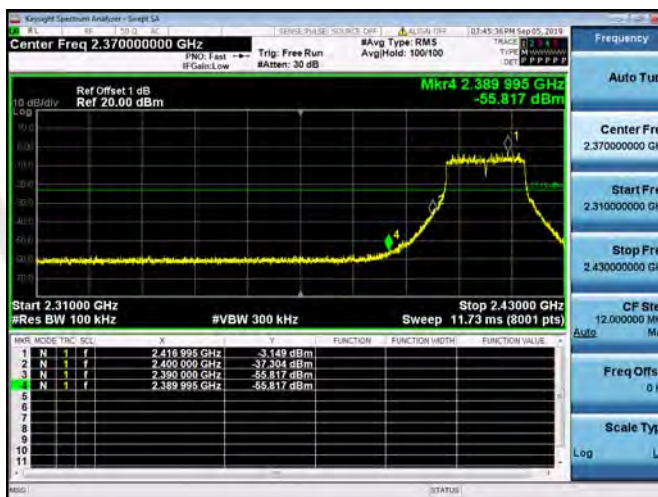

Left bandedge

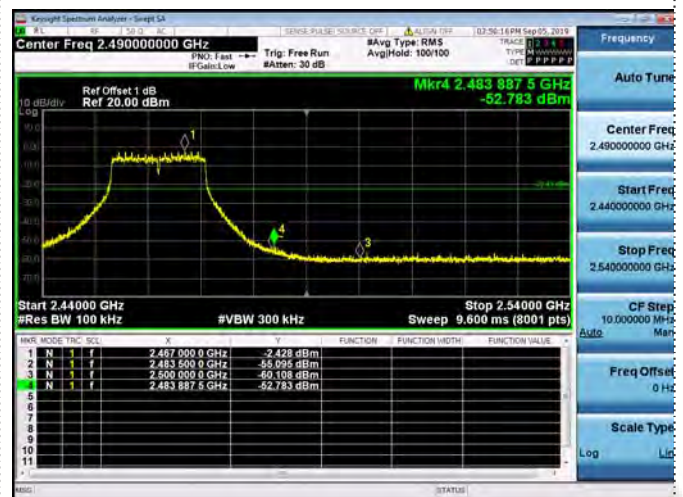

Right bandedge

### 802.11n(HT40)

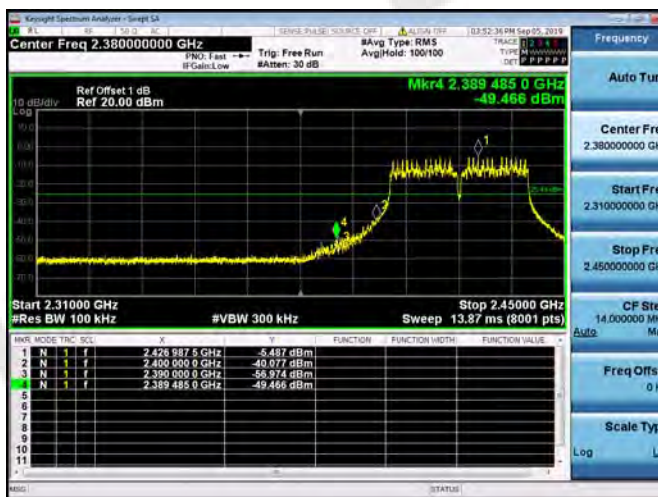

Left bandedge

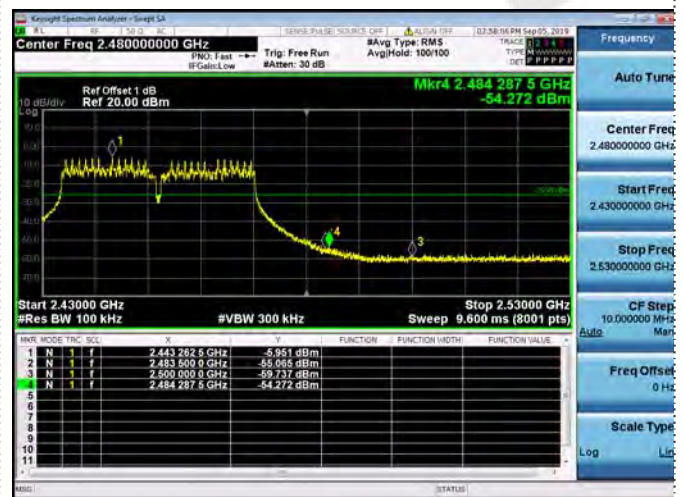

Right bandedge

### 3.7. Antenna Requirement

#### Standard Applicable

**For intentional device, according to FCC 47 CFR Section 15.203:**

An intentional radiator shall be designed to ensure that no antenna other than that furnished by the responsible party shall be used with the device. The use of a permanently attached antenna or of an antenna that uses a unique coupling to the intentional radiator, the manufacturer may design the unit so that a broken antenna can be replaced by the user, but the use of a standard antenna jack or electrical connector is prohibited

**FCC CFR Title 47 Part 15 Subpart C Section 15.247(c) (1) (I):**

(i) Systems operating in the 2400-2483.5 MHz band that is used exclusively for fixed. Point-to-point operations may employ transmitting antennas with directional gain greater than 6dBi provided the maximum conducted output power of the intentional radiator is reduced by 1 dB for every 3 dB that the directional gain of the antenna exceeds 6dBi.

#### Test Result:

The maximum gain of antenna was 12dBi.

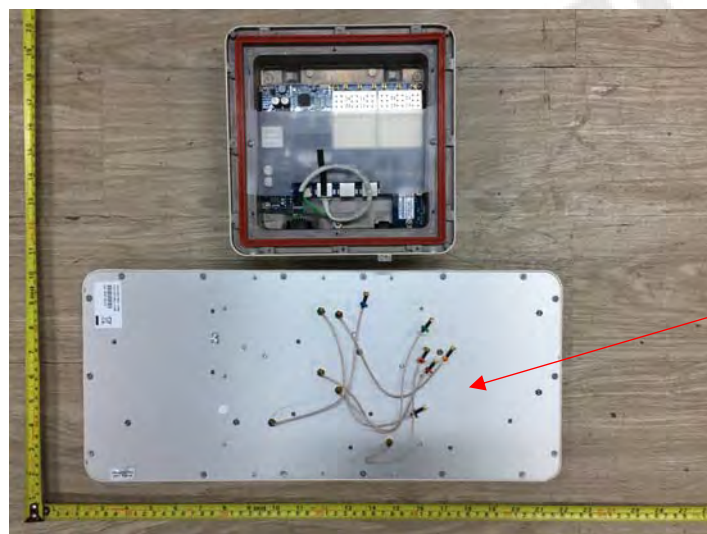

Antenna

#### 4. Test Setup Photos of the EUT



## 5. Photos of the EUT

### External Photos of EUT





**Internal Photos of EUT**

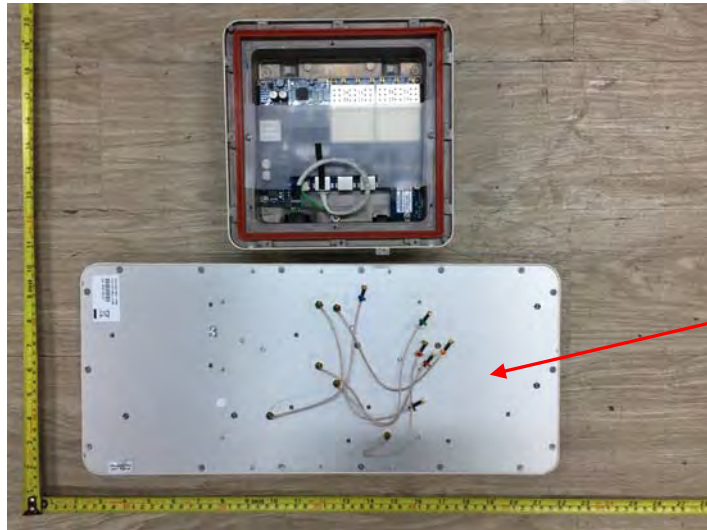

Antenna

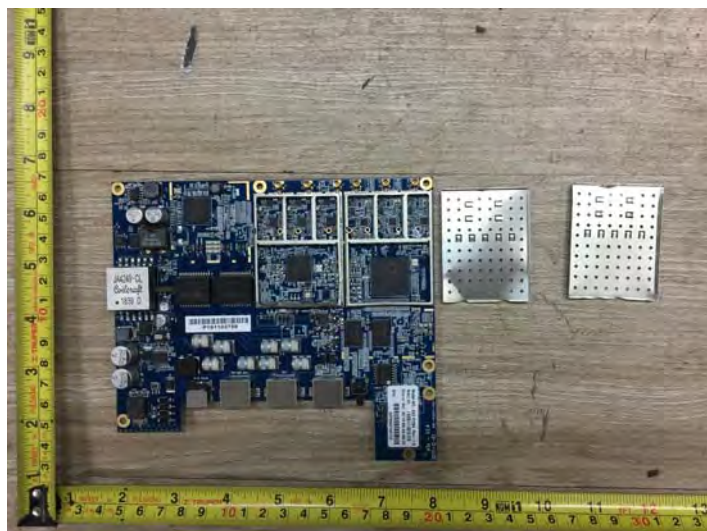
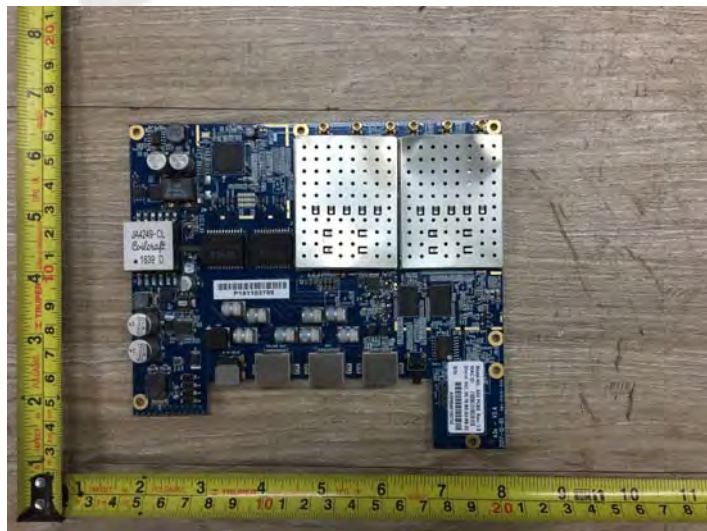



\*\*\*\*\* End of Report \*\*\*\*\*