

Antenna matching and measurement report

Project : WNAL-US

XXI-Lab		Customer	
Name	Jean-Michel Monteix	Name	Frederic Esnault
Date :	28/04/2021	Company	NETATMO
Date	Version	Référence	Version History
28/04/2021	1.0	Exp-NETATMO_Match_WNAL-US_28-04-2021	Creation

Sommaire

1	Introduction.....	3
1.1	Type of service :.....	3
1.2	Purpose of the study	3
1.3	Tools used.....	3
1.4	Input data	3
1.5	Delivery.....	3
2	The products WNAL23, WNAL 33, WNAL43 & WNLA63.....	4
3	Antenna Matching.....	4
4	Radiated measurements	10
5	Conclusion	12
6	Appendix	13

1 Introduction

1.1 Type of service :

Tuning of antenna matching circuit at 2.4GHz (Ref XXI-Lab: Ant_dev)

1.2 Purpose of the study

Search for the optimal matching networks for the WNAL-US product antennas at 2.4GHz (Zigbee).

1.3 Tools used

- Network analyser
- Anechoic chamber

1.4 Input data

One WNAL23 product in permanent transmission mode (Zigbee), and one product WNAL23 without firmware for conducted tests only.

One WNAL33 product in permanent transmission mode (Zigbee), and one product WNAL33 without firmware for conducted tests only.

One WNAL43 product in permanent transmission mode (Zigbee), and one product WNAL43 without firmware for conducted tests only.

One WNAL63 product in permanent transmission mode (Zigbee), and one product WNAL63 without firmware for conducted tests only.

1.5 Delivery

This study report

	Document reference	Date	Version	Page
	Exp-NETATMO_Match_WNAL-US_28-04-2021	28/04/2021	1.0	3

2 The products WNAL23, WNAL 33, WNAL43 & WNLA63

The products referred to in this report are those in the following figure :

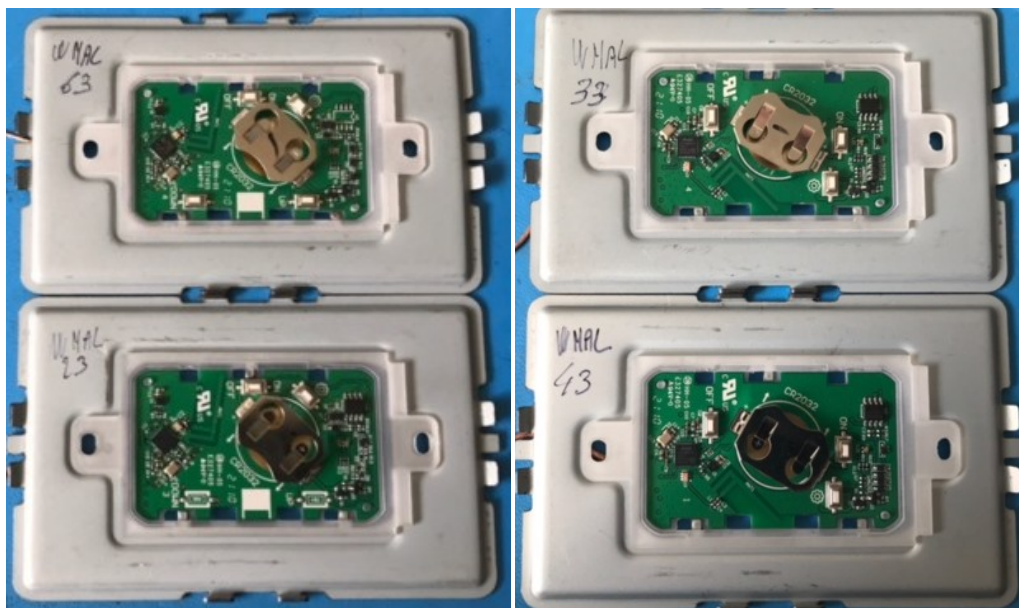

figure 1. From top to bottom and left to right, WNAL 63, WNAL23, WNAL33 & WNAL43

Products WNAL 23 & 63 have the same PCB but not the same partlist. Products WNAL 33 and WNAL 43 have the same PCB but not the same SW.

3 Antenna Matching

By default, the matching network which is used for all products is as follows.

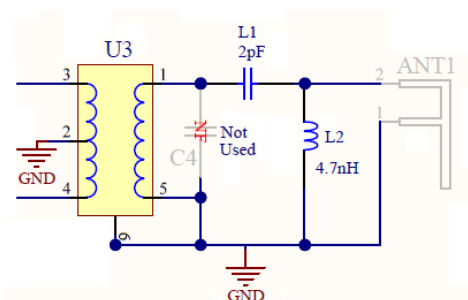

figure 2. Matching Network used by default for all products

The antenna matching with this matching network is the following for the WNAL23 product:



figure 3. WNAL23 antenna matching with the default matching Network

The antenna matching can be considered as acceptable but can be improved.

The WNAL63 antenna matching with the default matching network is very similar than the WNAL23 one. It is the following:

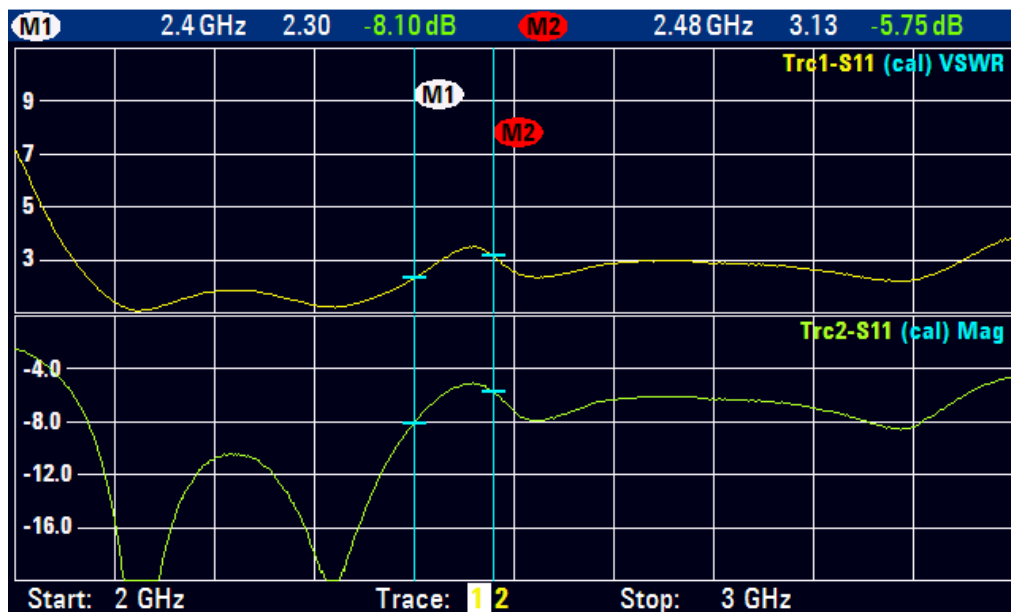

figure 4. WNAL63 antenna matching with the default matching Network

As well, the antenna matching can be considered as acceptable but can be improved.

The WNAL33 antenna matching with the default matching network is the following:

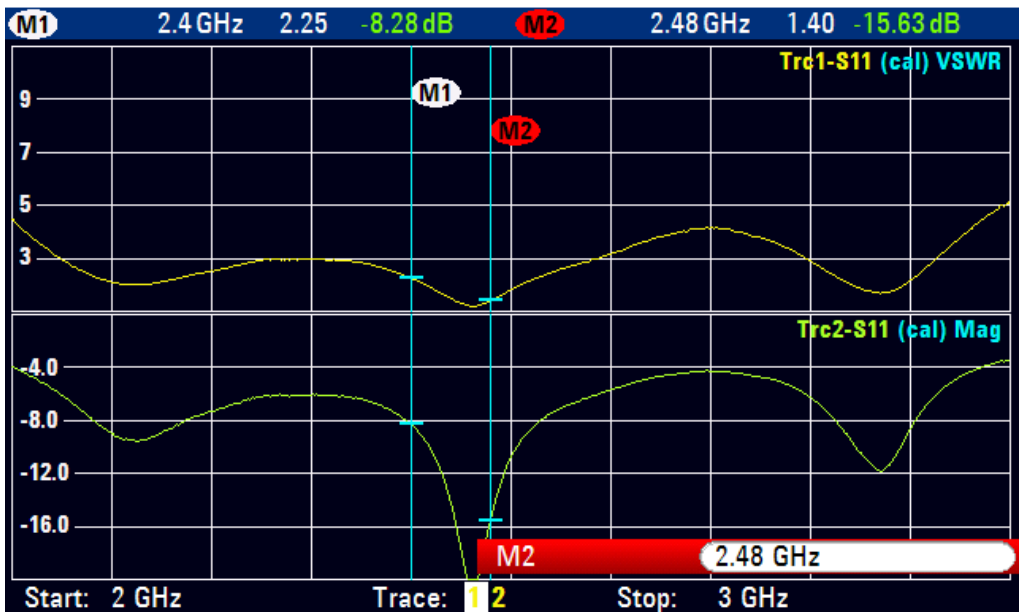

figure 5. WNAL33 antenna matching with the default matching Network

Matching performance is good nevertheless other matching network have been studied to try improving the bandwidth ripple.

The WNAL43 antenna matching with the default matching network is the following:

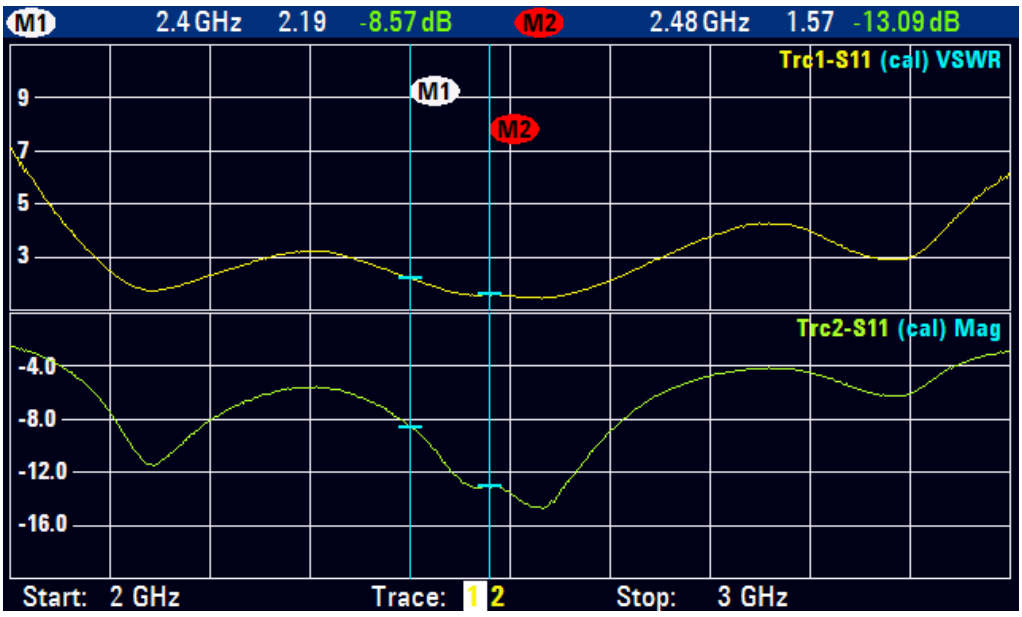

figure 6. WNAL43 antenna matching with the default matching Network

WNAL33 & WNAL43 frequency response are very similar except for the measurement uncertainty .As for the WNAL33, the WNAL43 matching performance is good nevertheless other matching network have been studied to try improving the bandwidth ripple.

For product WNAL 23 & 63, among all matching network studied, the one which give the best radiated performances is the following:

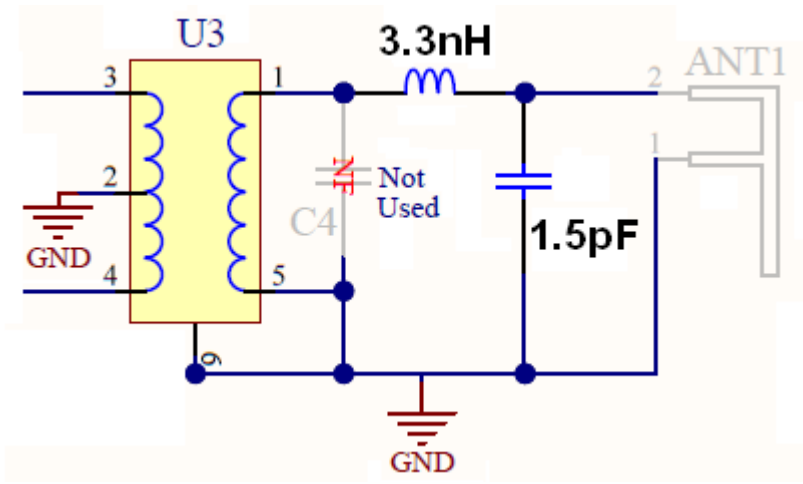

figure 7. antenna matching circuit proposed for WNAL23 & WNAL63 product: "Ant-1.5pf shunt – 3.3nH serie"

With this matching network proposed, the WNAL23 frequency response is the one displayed below:

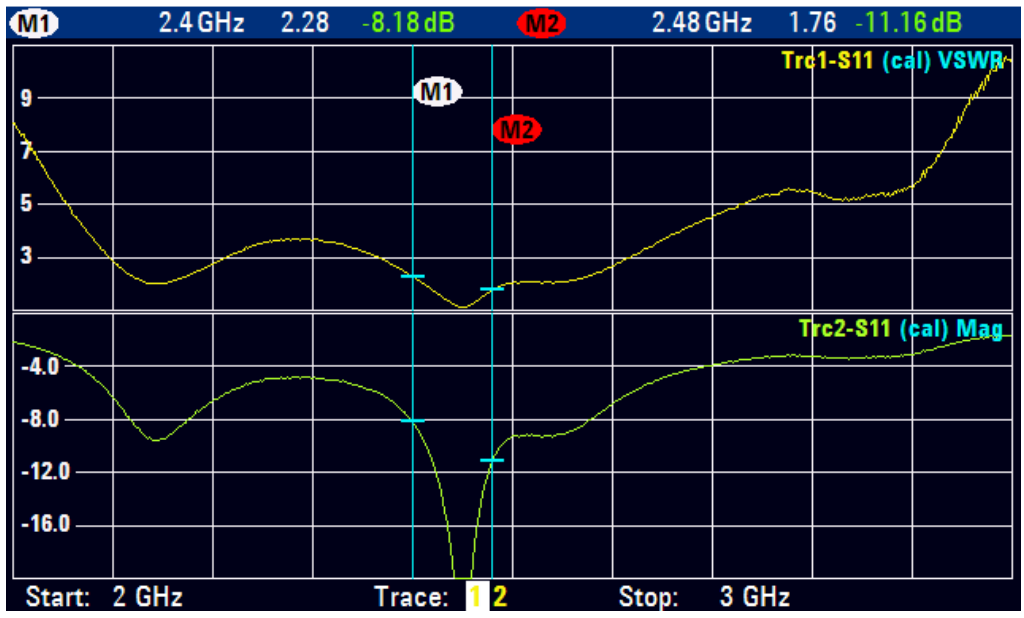

figure 8. Frequency response of the WNAL23 antenna with the matching network proposed : "Ant-1.5pf shunt – 3.3nH serie"

With the proposed matching network, the performance is good.

With this matching network proposed, the WNAL63 frequency response is the one displayed below:

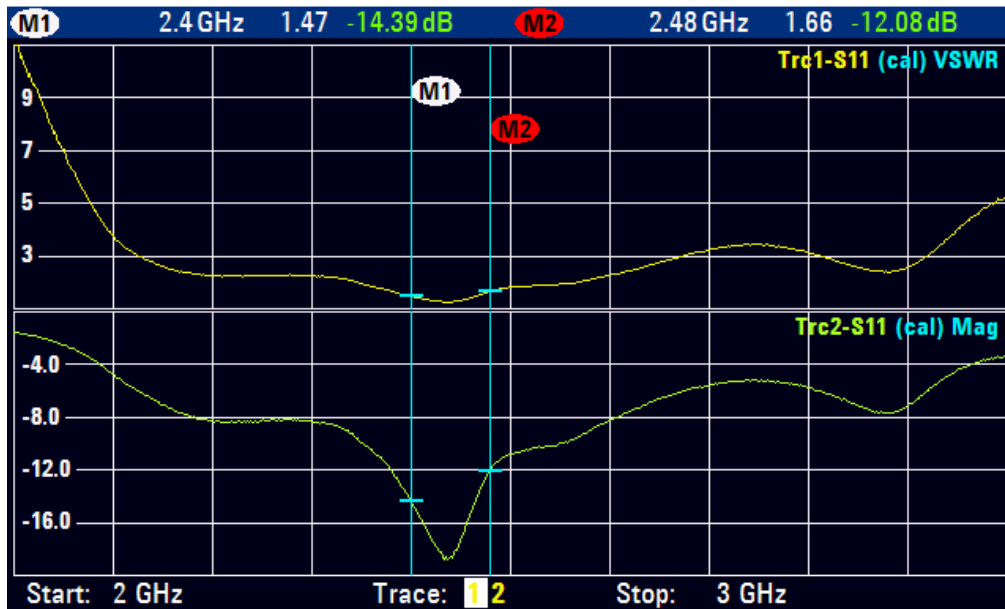

figure 9. Frequency response of the WNAL63 antenna with the matching network proposed :
 “Ant-1.5pf shunt – 3.3nH seriee”

With the proposed matching network, the performance is good.

For product WNAL 33 & 43, among all matching network studied, the one which give the best radiated performances is the following:

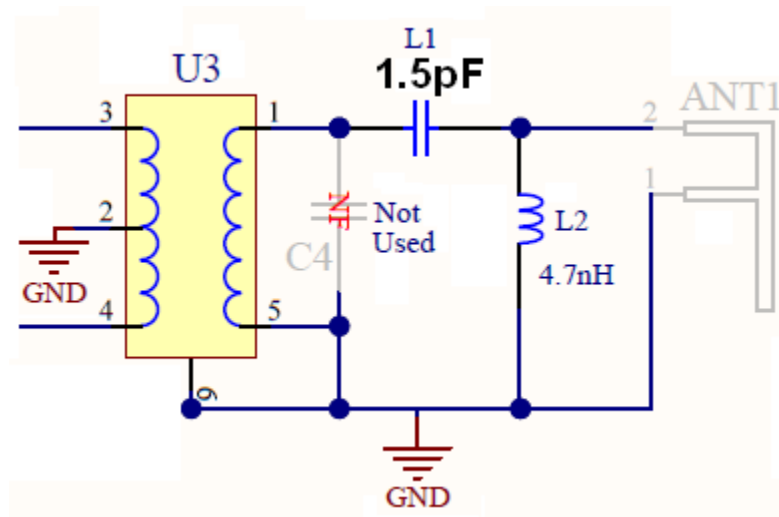

figure 10. antenna matching circuit proposed for WNAL33 & WNAL43 product: “Ant-4.7nH
 shunt – 1.5pF serie”

With this matching network proposed, the WNAL33 frequency response is the one displayed below:

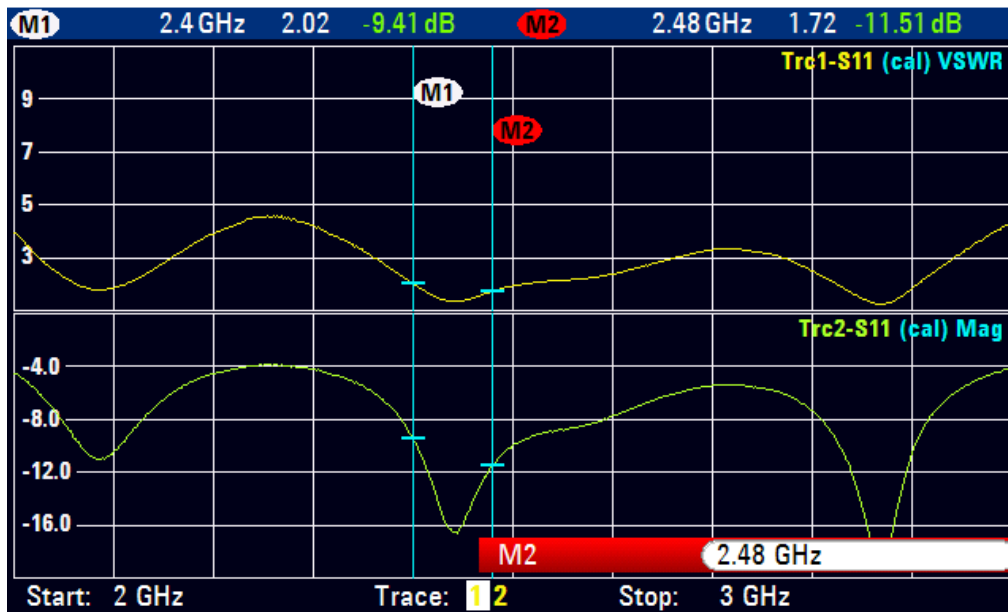

figure 11. Frequency response of the WNAL23 antenna with the matching network proposed :
 “Ant-4.7nH shunt – 1.5pF serie”

With the proposed matching network, the performance is good.

With this matching network proposed, the WNAL43 frequency response is the one displayed below:

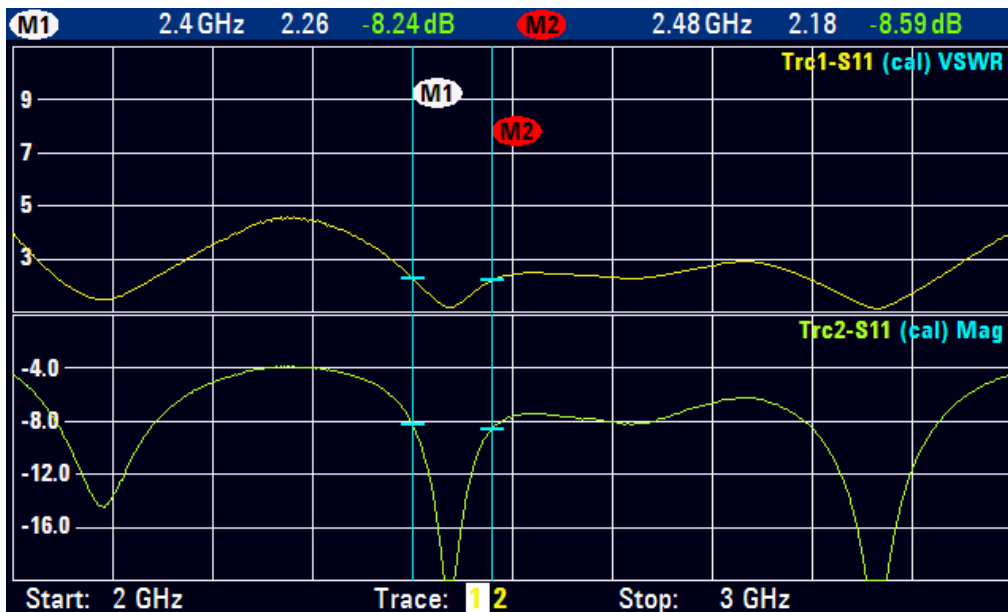

figure 12. Frequency response of the WNAL43 antenna with the matching network proposed :
 “Ant-4.7nH shunt – 1.5pF serie”

With the proposed matching network, the performance is good.

4 Radiated measurements

The measurements were carried out for the H and E planes at the 2405, 2440 & 2480MHz frequencies in vertical and horizontal polarization with a step of 1°. From these results the total polarization was calculated.

Measurements have been done using the modem of each product for the antenna matching circuit used by default and for the antenna matching proposed for each product.

The H, and E plane are displayed below :

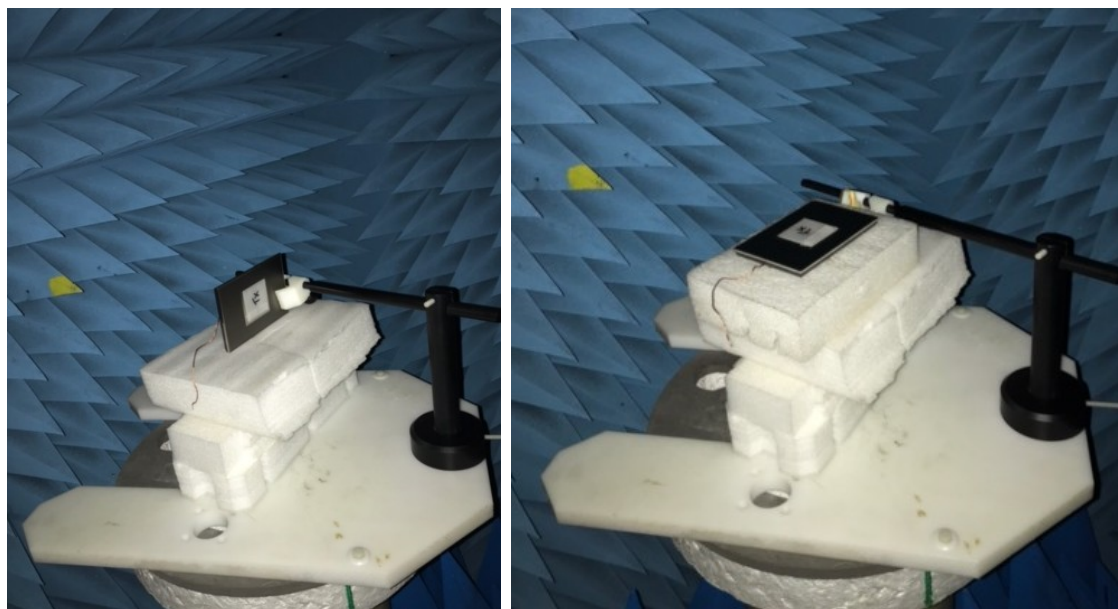



figure 13. Photo of the H and E plane

Because all products were not set-up at maximum power, we have normalized the power at the maximum power given by the measurement carried out at the modem output for each of the products. This will allow comparing radiated performances among products tested.

It means that,

- For product WNAL23 with and output power measure at the antenna port at -12.3dBm at 2405, 2440 & 2480MHz, an offset have been applied to reach the maximum power output delivered at the antenna port for the WNAL33 product.
- For product WNAL63 with and output power measure at the antenna port at -12dBm at 2405MHz, -12.8dBm at 2440MHz & -13.7dBm at 2480MHz, an offset have been applied for each frequency to reach the maximum power output delivered at the antenna port for the WNAL33 product.
- For product WNAL33 with and output power measure at the antenna port at 5.5dBm for 2405, 2440 & 2480MHz, no offset have been applied since it was the maximum power measure among all product.
- For product WNAL43 with and output power measure at the antenna port at 5.5dBm for 2405, 2440 & 2480MHz, no offset have been applied since it was the maximum power measure among all product.

	Document reference	Date	Version	Page
	Exp-NETATMO_Match_WNAL-US_28-04-2021	28/04/2021	1.0	10

Results normalized are compiled in the table below:

Radiated power (dBm)/Frequency/Plane	2405MHz		2440MHz		2480MHz	
	H	E	H	E	H	E
WNAL63 – matching default	1.15	-0.46	1.85	-0.77	4.45	2.58
WNAL63 – matching “Ant-1.5pF shunt-3.3nH serie”	5.14	3.60	5.92	3.50	4.78	4.90
WNAL23 – matching default	3.60	4.14	3.30	3.93	4.10	1.85
WNAL23 – matching “Ant-1.5pF shunt-3.3nH serie”	6.65	5.14	7.23	4.63	7.81	3.18
WNAL43 – matching default	2.69	3.34	4.47	3.12	6.61	3.44
WNAL43 – matching “Ant-4.7nH shunt-1.5pF serie”	4.65	0.72	5.58	2.03	6.46	2.15
WNAL33 – matching default	3.33	1.49	5.76	2.72	7.08	3.72
WNAL33 – matching “Ant-4.7nH shunt-1.5pF serie”	4.75	5.43	6.30	2.13	7.28	2.88

tableau 1. Maximum radiated power for the default and proposed matching network

For the WNAL63, the proposed matching network allow to gain between 2.3 & 4.3dB depending on frequency. With this new matching proposed the antenna gain varyies between -0.6 & 0.4dBi.

For the WNAL23, the proposed matching network allow to gain between 3 & 4dB depending on frequency. With this new matching proposed the antenna gain varyies between 1.1 & 2.3dBi.

For the WNAL43, the proposed matching network allow to gain between 0 & 2dB depending on frequency. With this new matching proposed the antenna gain varyies between -0.9 & 0.9dBi.

For the WNAL33, the proposed matching network allow to gain between 0 & 1.5dB depending on frequency. With this new matching proposed the antenna gain varyies between 0 & 1.8dBi.

Radiation pattern are provided in appendix

5 Conclusion

Different matching network have been designed and measured. Among those different circuits, the best has been proposed for each antenna and each product.

Proposed matching network are the same for the product couple WNAL63/WNAL23 & WNAL43/WNAL33: product with same PCB.

With those matching network radiated power has been improved:

- between 2.3 & 4.3dB depending on frequency for the WNAL63 product
- between 3 & 4dB depending on frequency for the WNAL23 product
- between 0 & 2dB depending on frequency for the WNAL43 product
- between 0 & 1.5dB depending on frequency for the WNAL33 product

Based on measurement done, we noticed that gain variation between two product with the same PCB is depending on the way to mount product, especially metallic hubcap.

	Document reference	Date	Version	Page
	Exp-NETATMO_Match_WNAL-US_28-04-2021	28/04/2021	1.0	12

6 Appendix

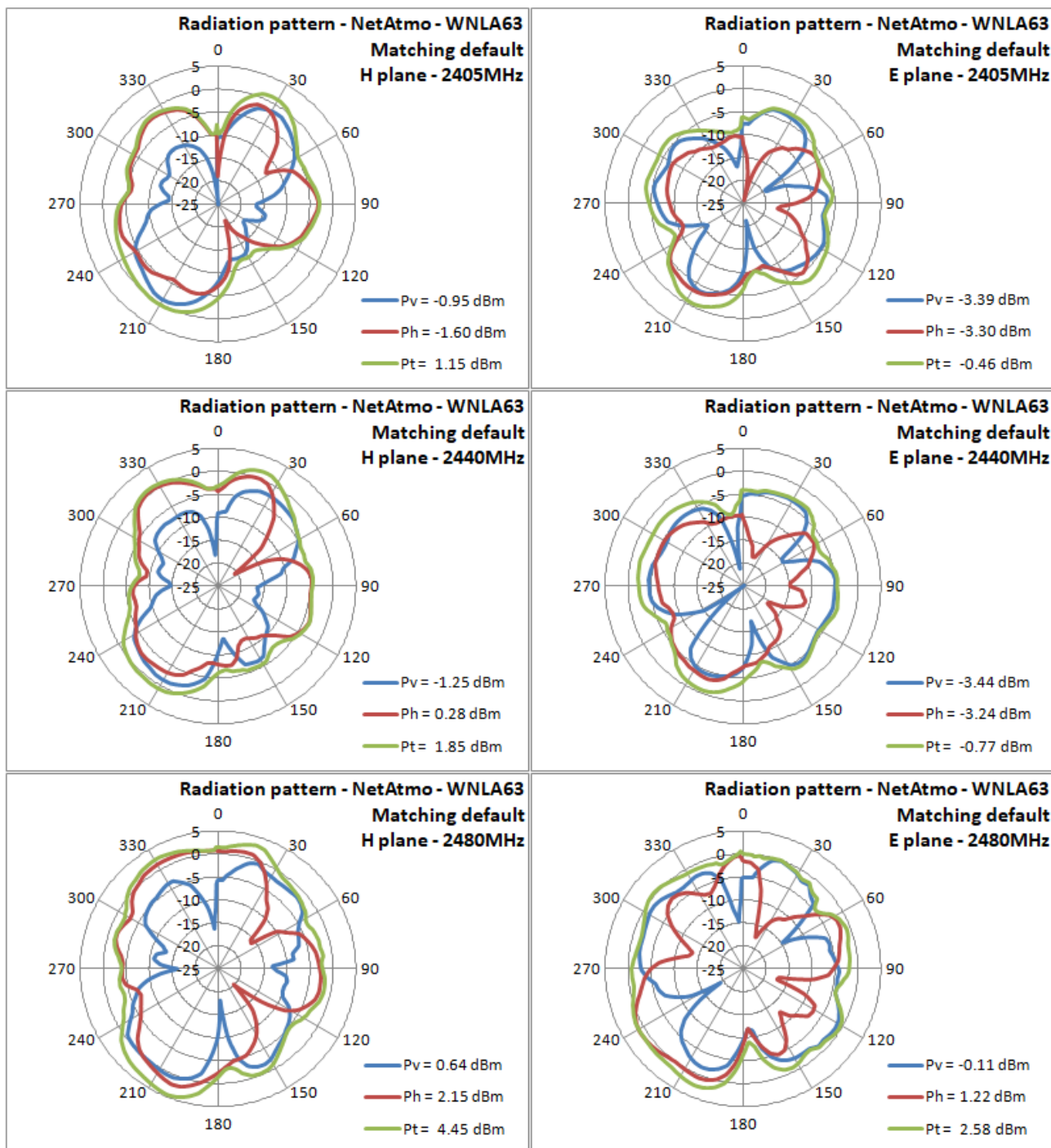

figure 14. From left to right, from top to bottom, Radiation pattern for H & E planes for the 2405, 2440 & 2480MHz frequencies for WNLA63 with default matching network



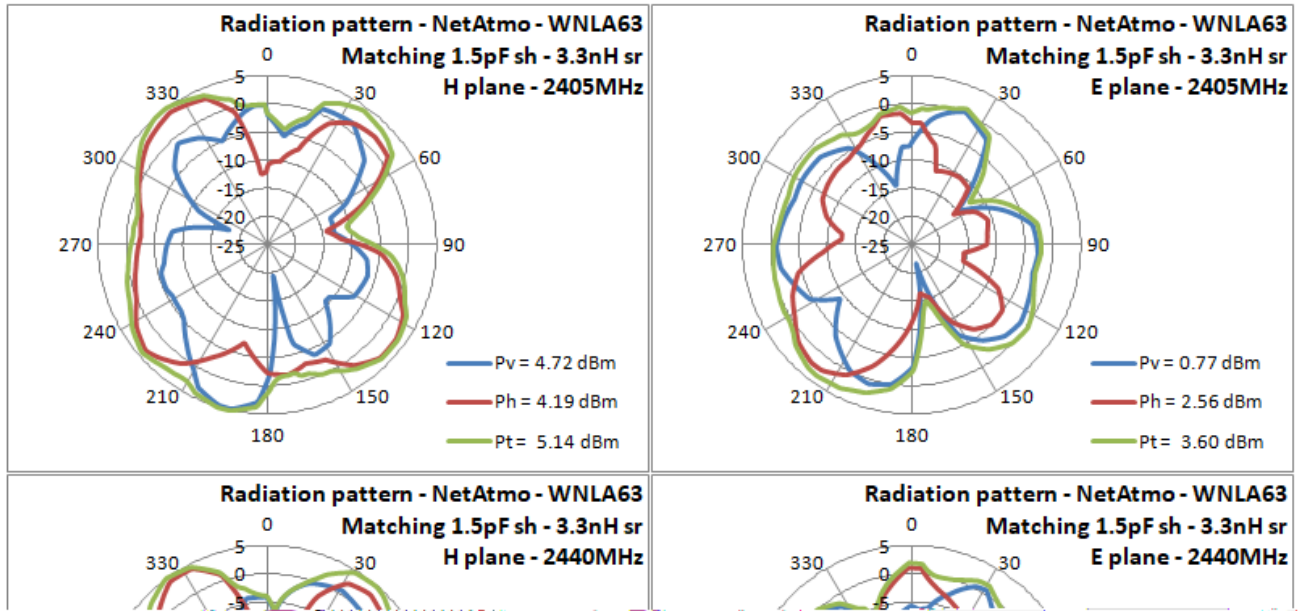

figure 15. From left to right, from top to bottom, Radiation pattern for H & E planes for the 2405, 2440 & 2480MHz frequencies for WNLA63 with proposed matching network

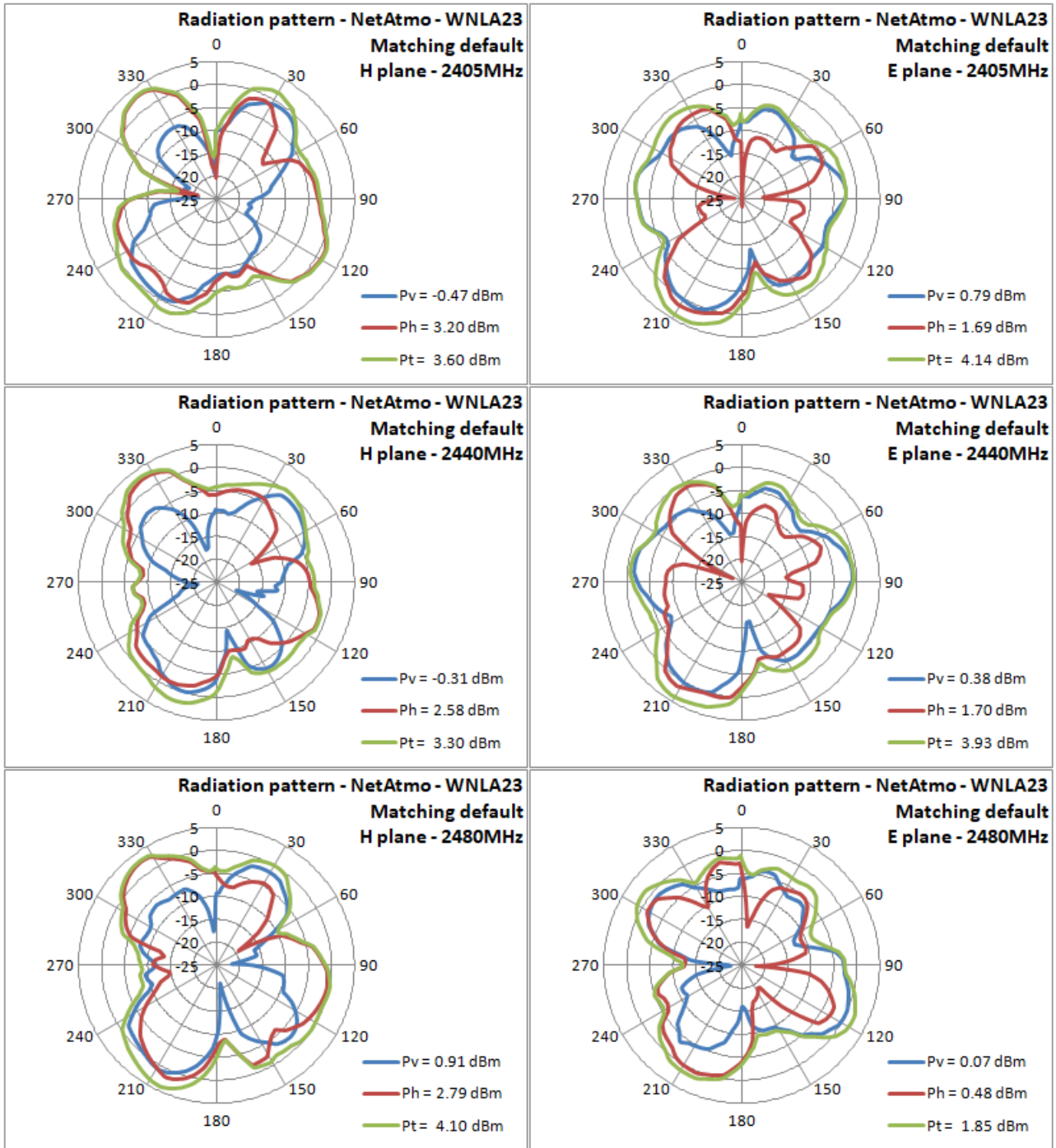

figure 16. From left to right, from top to bottom, Radiation pattern for H & E planes for the 2405, 2440 & 2480MHz frequencies for WNAL23 with default matching network



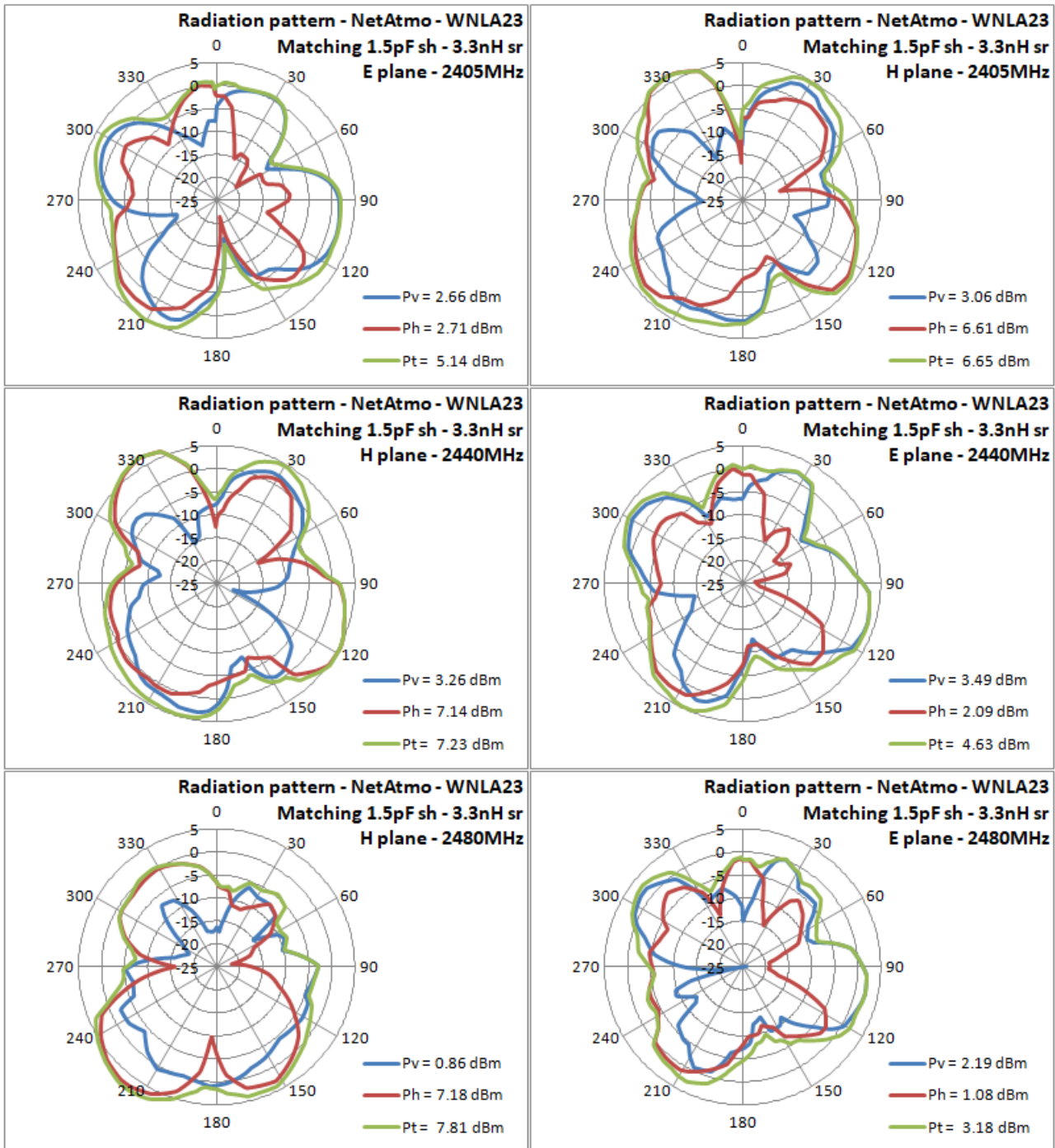

figure 17. From left to right, from top to bottom, Radiation pattern for H & E planes for the 2405, 2440 & 2480MHz frequencies for WNLA23 with proposed matching network



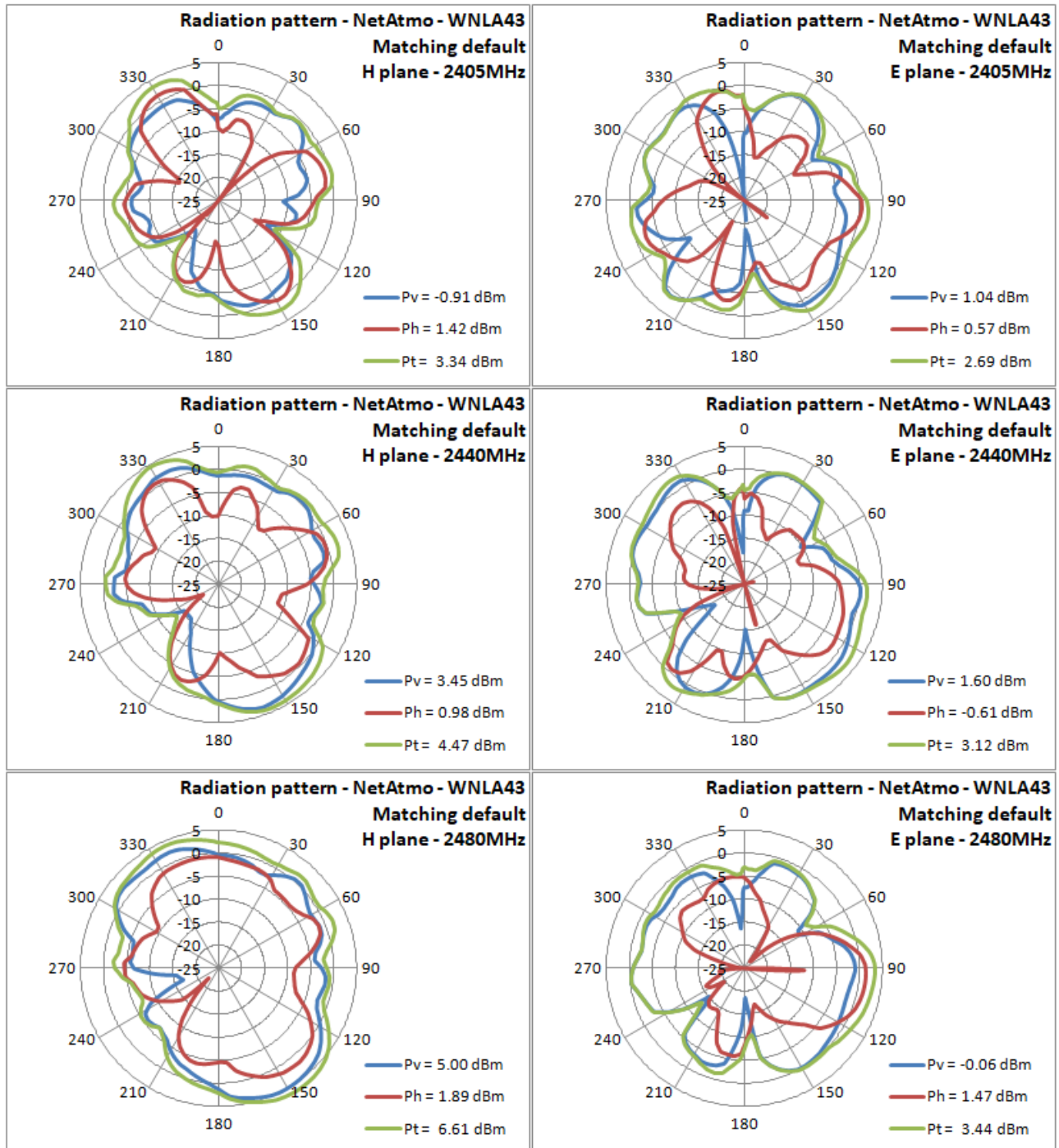

figure 18. From left to right, from top to bottom, Radiation pattern for H & E planes for the 2405, 2440 & 2480MHz frequencies for WNLA43 with default matching network

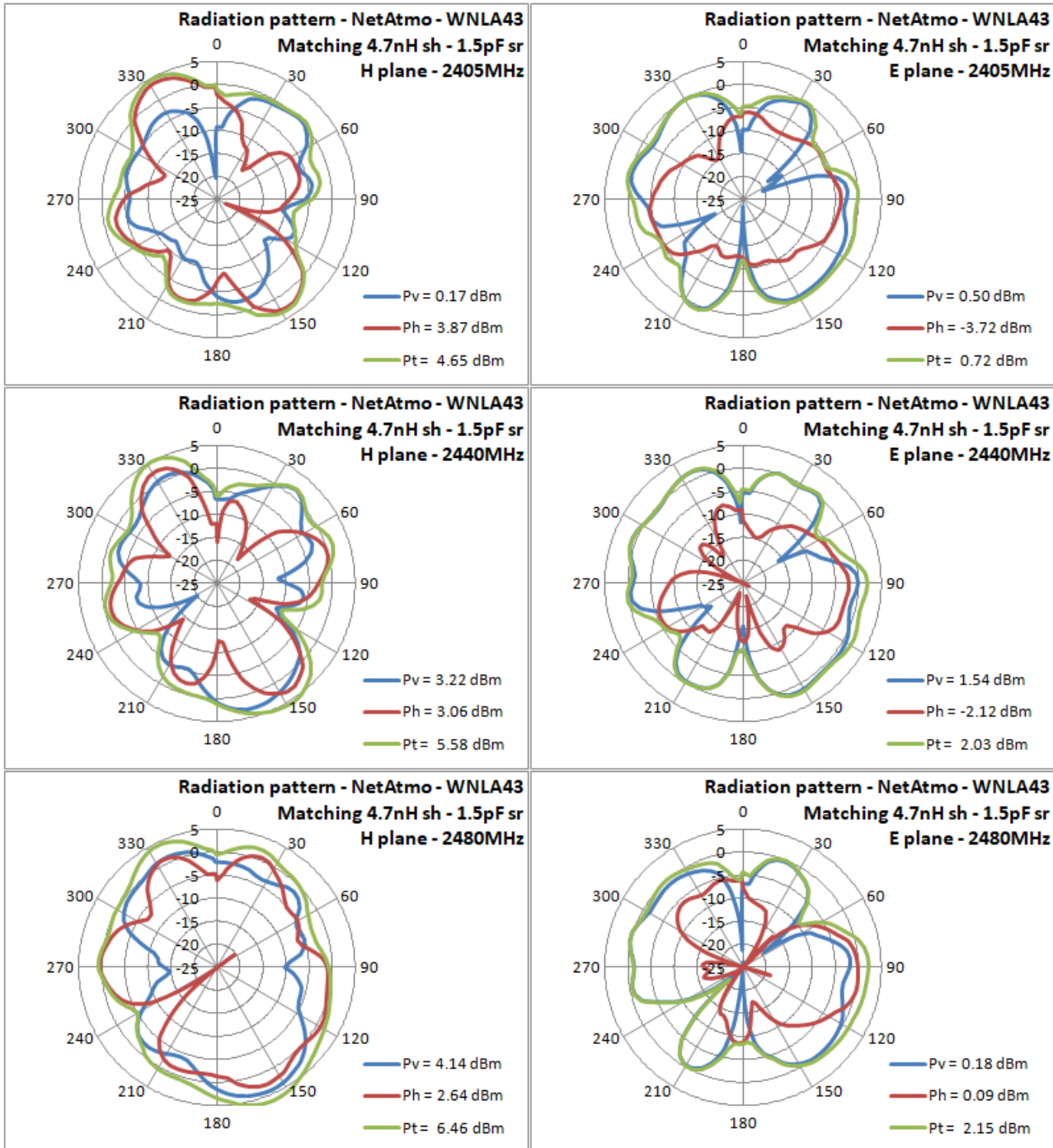

figure 19. From left to right, from top to bottom, Radiation pattern for H & E planes for the 2405, 2440 & 2480MHz frequencies for WNLA43 with proposed matching network



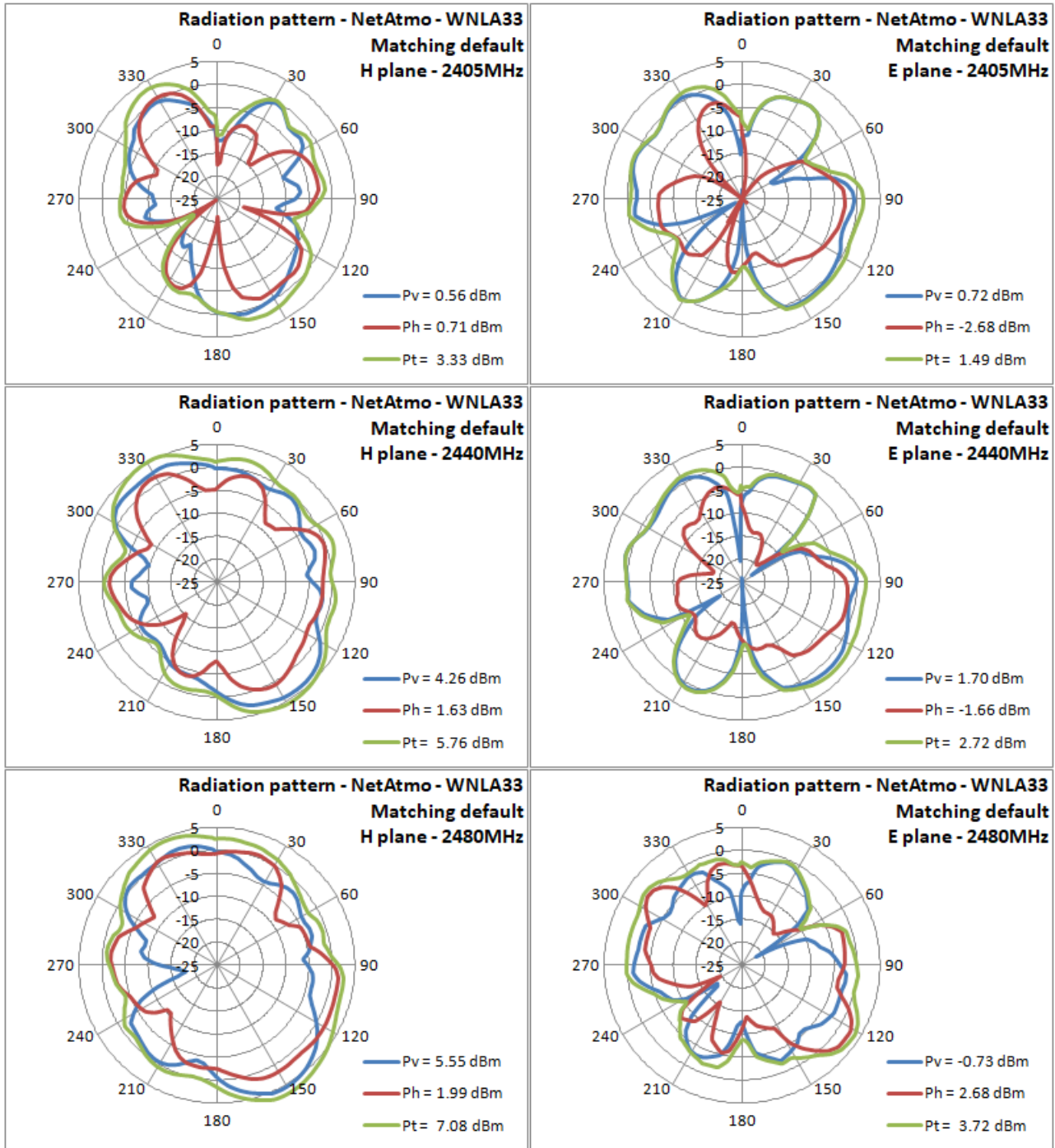

figure 20. From left to right, from top to bottom, Radiation pattern for H & E planes for the 2405, 2440 & 2480MHz frequencies for WNLA33 with default matching network



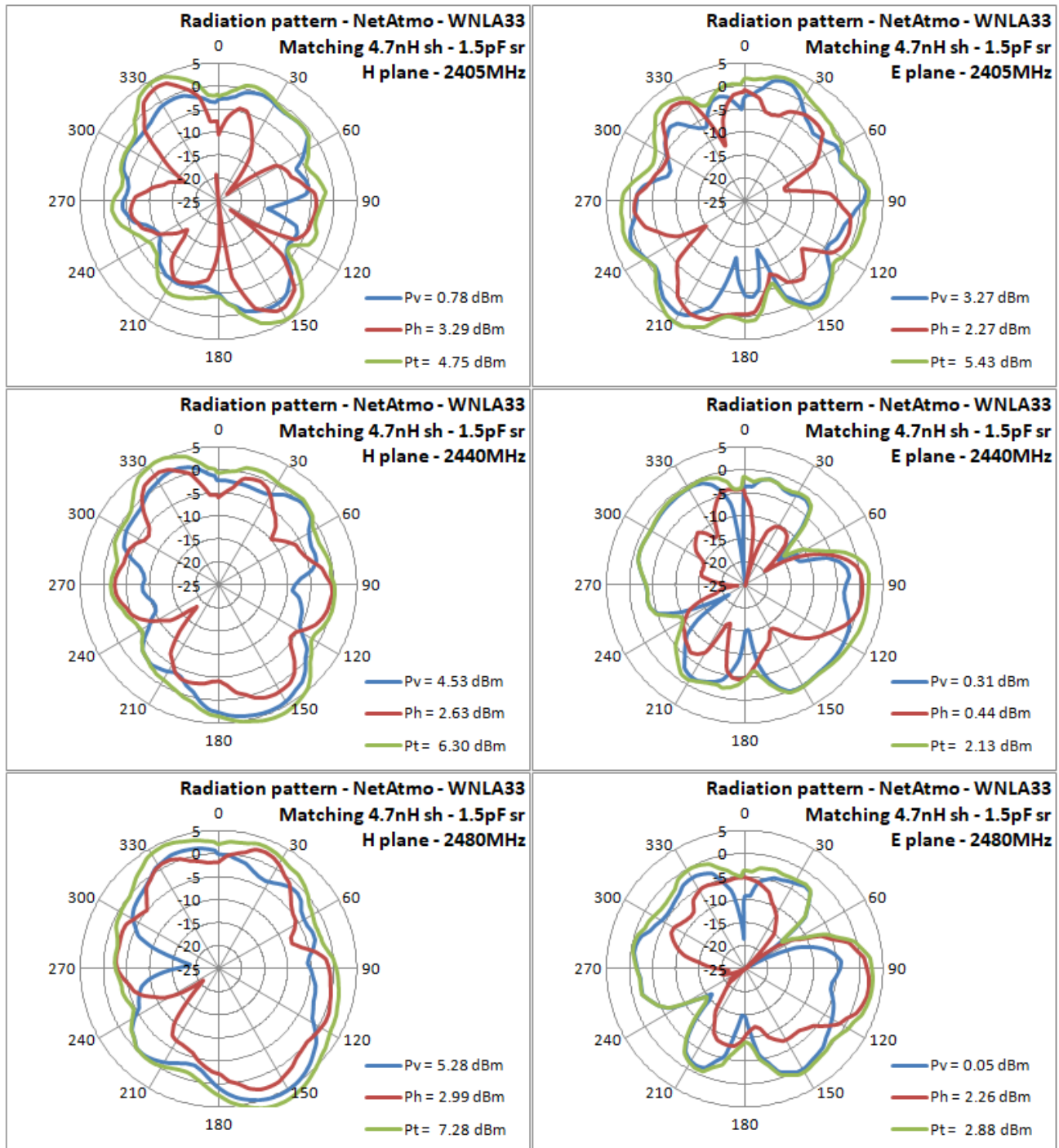

figure 21. From left to right, from top to bottom, Radiation pattern for H & E planes for the 2405, 2440 & 2480MHz frequencies for WNLA33 with proposed matching network