

This product is a connected accessory which **requires** you to buy and install one of these first:

- ... with Netatmo™ connected starter pack and "... with Netatmo " connected power outlets, switches (with dimmer option).
- Connected lighting micromodules.
- Radiant with Netatmo Gateway and radiant with Netatmo Switch, Dimmer or Receptacle.
- Adorne with Netatmo Gateway and adorne with Netatmo Switch Dimmer or Receptacle.

Pack contents

Wireless motion sensor

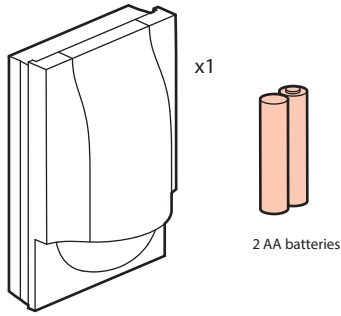

Specifications

This product can control up to 20 connected switches (with dimmer option), micromodules, cable outlets and power outlets «... with Netatmo»

	2 x AA - 1,5 V
	+5° C / +45° C
	PIR
	2 - 8 m
	5 - 1000 LUX
	de 15 s - 15 min
IP	44

Frequency bands: 2.4 - 2.4835 GHz
Power level : < 10 mW

LE11418AB

1 Open the front cover

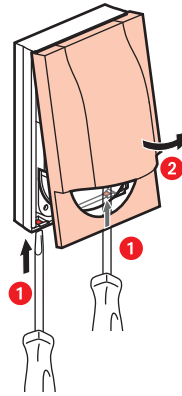

Do not insert the batteries now

Do not fix the motion sensor to the wall now. The installation will be finalized on step 6.

2 Start the wireless motion sensor configuration

Press the middle of the wireless master switch **until its light briefly turns green, and then stop pressing**. The indicator lights on the products which you have wired will turn green.

Press the Gateway EZ button for 5 seconds and let go. The LED will turn solid green or follow the app to add device.

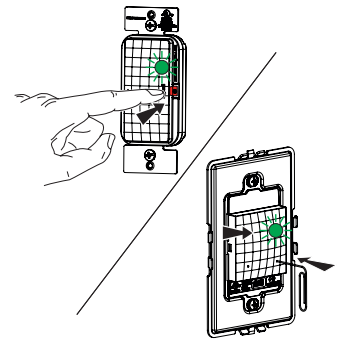
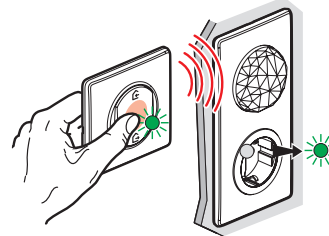

2

3 Insert the batteries in the wireless motion sensor

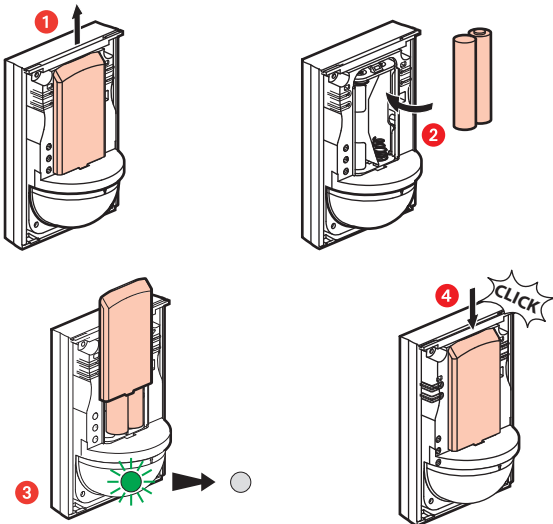

The motion sensor light will flash green and then switch off.

Note : if the motion sensor flashes green green red, then remove the batteries and restart on Step 2

4 Pair the wireless motion sensor to a wired connected product

Make sure that the indicator lights on the wired products are green and not flashing. If not, go back to step 2 and then come back to step 4.

To pair a wireless motion sensor with a connected light switch, go to step **4.1.1**
To pair a wireless motion sensor with a connected micromodule, go to step **4.2.1**
To pair a wireless motion sensor with a connected power outlet, go to step **4.3.1**

3

4.1.1 Pair a wireless motion sensor with a connected light switch

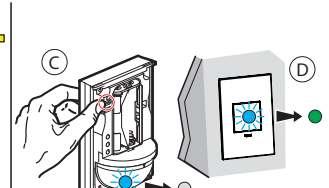
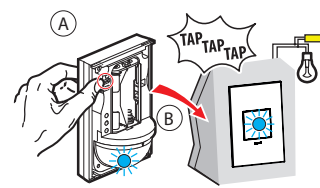
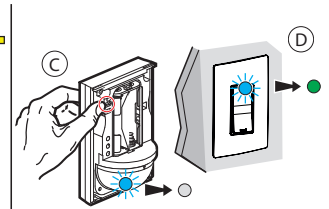
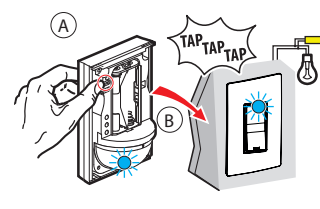
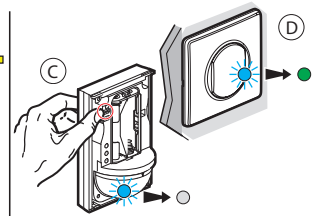
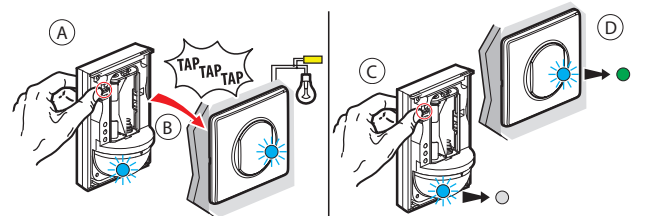

Step A : Press the ON button on the wireless motion sensor you wish to pair, while tapping it three times onto the light switch you wish to control.
Step B : The indicator lights on the two products will flash blue rapidly.
Step C : The indicator lights on the two products will briefly turn blue and stop flashing.
Step D : the light on the wired product will turn green again and the light on the wireless motion sensor will switch off. The pairing was successful.

4

4.1.2 Check the correct pairing

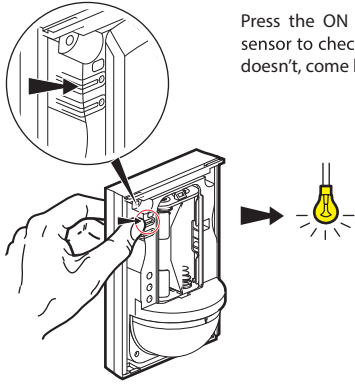

Press the ON and OFF buttons of the wireless motion sensor to check if the light turns on and off correctly. If it doesn't, come back to step 4.1.1.

4.2.1 Pair a wireless motion sensor with a connected micromodule

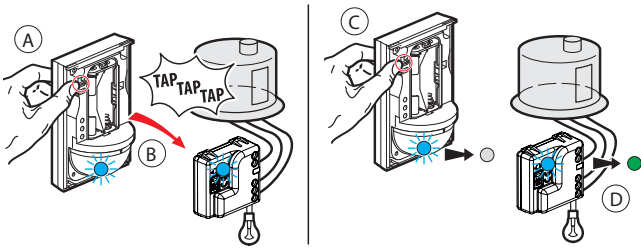

Phase A : Press the ON button on the wireless switch you wish to pair, while tapping it three times onto the micromodule you wish to control.

Phase B : The indicator lights on the two products will flash blue rapidly.

Phase C : The indicator lights on the two products will briefly turn blue and stop flashing

Phase D : the light on the wired product will turn green again and the light on the wireless motion sensor will switch off.

5

4.1.2 Check the correct pairing

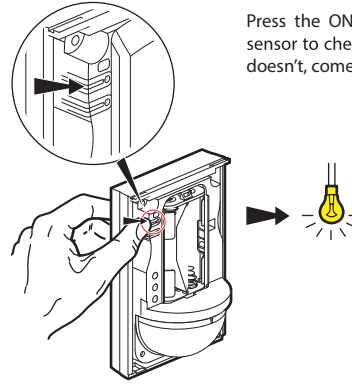

Press the ON and OFF buttons of the wireless motion sensor to check if the light turns on and off correctly. If it doesn't, come back to step 4.1.1

4.3.1 Pair a wireless motion sensor with a connected power outlet

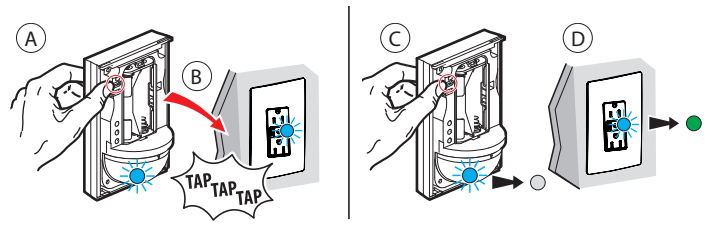
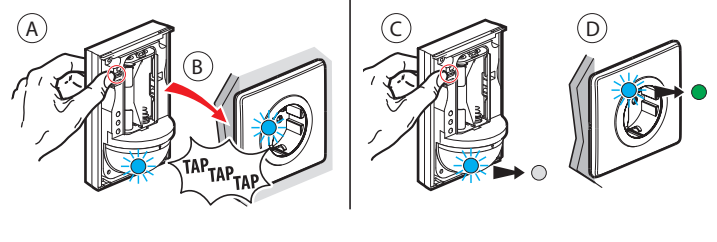

6

4.3.1 Pair a wireless motion sensor with a connected power outlet (continued)

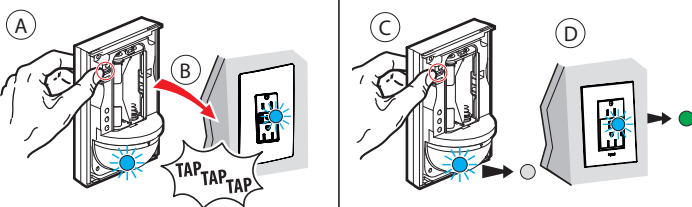

Step A : Press the ON button on the motion sensor you wish to pair, while tapping it three times onto the power outlet you wish to control.

Step B : The indicator lights on the two products will flash blue rapidly.

Step C : The indicator lights on the two products will briefly turn blue and stop flashing

Step D : the light on the wired product will turn green again and the light on the wireless motion sensor will switch off.

Multiple pairing

You can control several connected switches, micromodules and power outlets by repeating the step 4 on each product you wish to control.

OR you can add control of more devices in the Home+Control application.

5 Complete the configuration

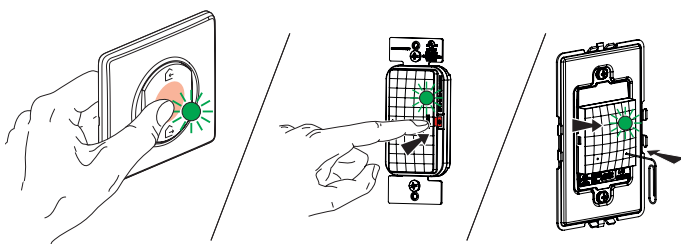

To complete your installation, briefly press the gateway EZ button.

All the LEDs on the products will switch off.

7

5 Complete the configuration (continued)



To complete your installation, briefly press the middle of the wireless master switch.
All the indicator lights on the products will switch off.

6 Location concerns

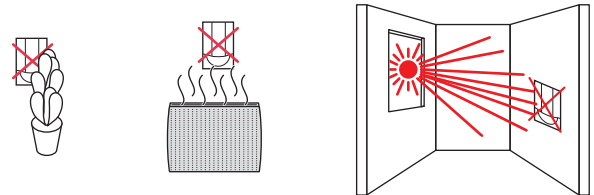

7 Fix the motion sensor

For optimal use, the motion detector should be placed at a height of approximately 2.50 m [8 feet] from the ground.

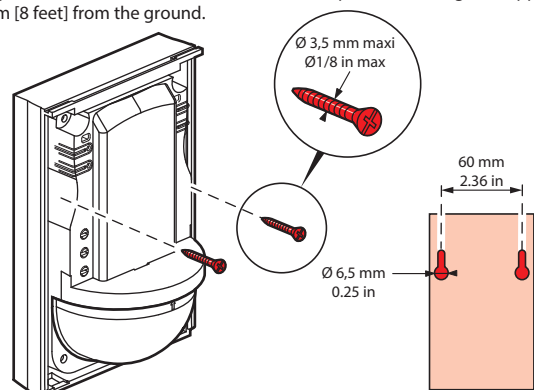

8

8 Set up the motion sensor

By default, the motion detector is set to a minimum delay (15 seconds), a maximum light sensitivity (1000 lux) and a maximum sensor sensitivity (8 meters). If you want to change these settings, follow the steps below.

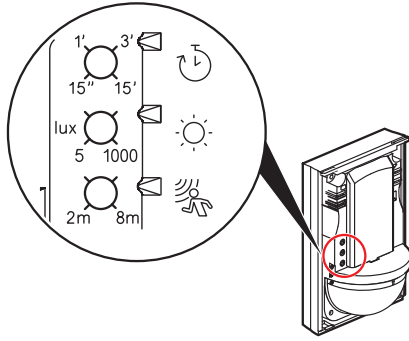

- Time delay
- Ambient light sensitivity
- Movement sensitivity

8.1 Adjust the time delay

To increase the time that the associated product remains ON (eg, light), turn the screw (potentiometer) clockwise.

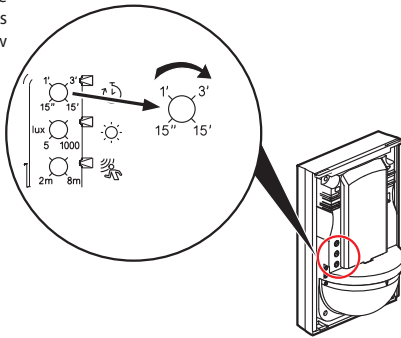

9

8.2 Adjust the ambient light sensitivity

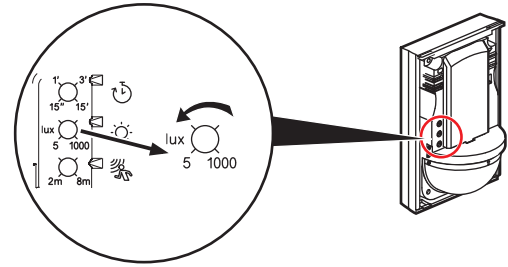

In order for the sensor to detect only when it is dark, turn the screw (potentiometer) counterclockwise.

8.3 Adjust the motion sensor sensitivity

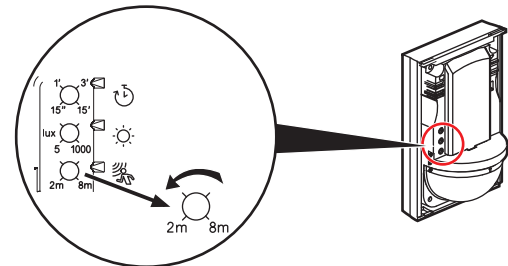

To reduce the sensitivity of the motion sensor, turn the screw (potentiometer) counterclockwise. The detection will then be at a shorter distance.

10

9 Close the front cover

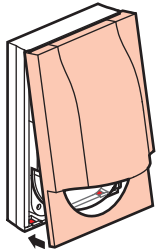

For an outdoor installation (IP44 protection)

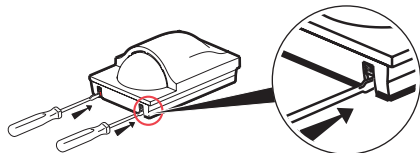

Break the 2 fins located on the bottom of the product

To add a connected product to your connected installation, you should follow the instructions :

- in the **Legrand Home + Control application** (Settings/Add a new product section)
- or consult the user manual on **legrand.com**

Reset To Factory Default:

To manually reset the device to factory defaults, press and hold the EZ Button for 10 seconds until you see the LED blink red, then release. The LED will turn off when the reset is complete.



www.legrand.com

Outside US:
www.legrandoc.com/064875
 Legrand - Pro and Consumer Service
 BP 30076 87002 Limoges CEDEX FRANCE
www.legrand.com

US:
 Question? We're here to help.
 Phone: 1-877-833-3303 8:00 a.m. to 8:00 p.m. EST (M-F)
 Email: smartlighting@legrand.us
 Chat: <https://www.legrand.us/radiant/smart-lighting.aspx>
 (Click on the chat icon to open a dialogue box)

SIMPLIFIED EU DECLARATION OF CONFORMITY

The undersigned,
Legrand

declares that the radio-electric equipment referred to in these instructions complies with directive 2014/53/EU.
 The full text of the EU declaration of conformity is available on the following website :

www.legrandoc.com

11

Batteries replacement

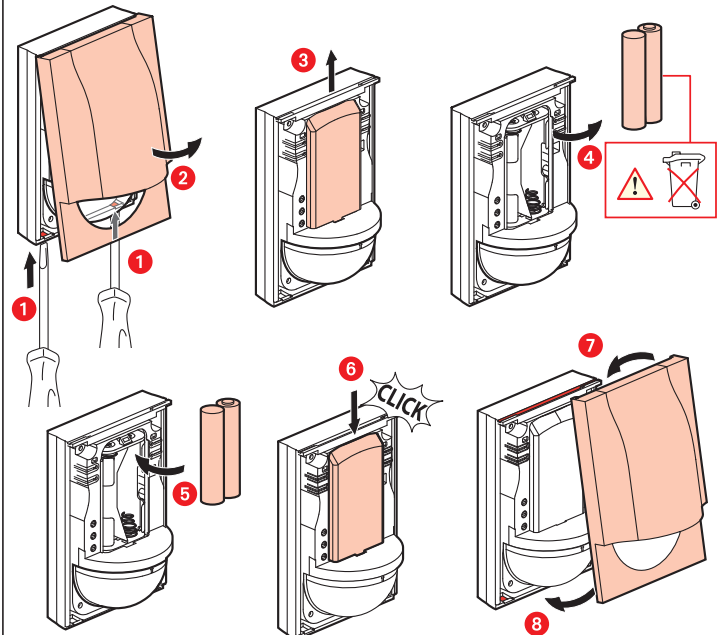

Red led light : low battery (*)

(*) 2 years batteries lifetime for 50 detections per day with a time delay of 3 minutes

12