

User Manual

XORAYA ML-N4000



© 2023 X2E GmbH

This user manual is copyrighted; all customary rights reserved.
Reproduction of this manual, even in part, is only allowed with permission
of X2E GmbH. Offenders shall be liable to pay compensation and may be
subject to prosecution.

All product names and trademarks used in this manual are the property of
their respective owners.

X2E GmbH
Grosse Ahlmuehle 19
76865 Rohrbach
Germany

Phone: +49 6349 99599 200
E-Mail: xoraya@x2e.de
Internet: www.x2e.de
Wiki: wiki.x2e.de

Table of contents

1	Introduction.....	5
1.1	About this user manual	5
1.2	Validity of the user manual	6
1.3	Representation conventions	6
1.4	Pictograms	7
1.5	X2E-Wiki.....	8
2	Safety and warranty.....	9
2.1	Intended use	9
2.2	Safety label on the device.....	10
2.3	General safety instructions	10
2.4	Product liability	13
2.5	Terms of use.....	13
2.6	Warranty	14
2.7	FCC notice	15
3	Product description.....	16
3.1	Identification.....	17
3.2	Scope of delivery.....	18
3.3	Connections and controls.....	19
4	Commissioning.....	26
4.1	Unpacking.....	26
4.2	Selecting an installation location	26
4.3	Installing the ML-N4000	26
4.4	Installing the XORAYASuite	27
4.5	Connecting the ML-N4000 to the measuring environment	28
4.6	Connecting the ML-N4000 to the PC.....	31
4.7	Configuring switches	32
5	XORAYASuite.....	33
5.1	Starting	33
5.2	Menu bar	34
5.3	Status bar	37
5.4	Connecting and disconnecting the ML-N4000.....	38
5.5	Configuration.....	41
5.6	Resetting to factory defaults	114
5.7	Data recording	115
5.8	Hdd-Download	123
5.9	Viewer.....	129
5.10	Statistic.....	148
5.11	Convert	150
5.12	Firmware-Update.....	153
5.13	TK Commandline	155
5.14	Common elements	157
5.15	Output formats	171

6	Maintenance.....	176
6.1	Safety measures	176
6.2	Cleaning	177
6.3	Repair	178
7	Storage, transport and disposal	179
7.1	Storage	179
7.2	Transport.....	179
7.3	Disposal.....	179
8	Appendix.....	181
8.1	Technical data.....	181
8.2	ML-N4000 pin assignments	182
8.3	Cable pin assignments	186

1 Introduction

1.1 About this user manual

- ▶ Read this user manual completely before using the XORAYA ML-N4000 for the first time.
- ▶ Please consider this user manual as part of the product and make sure it is easily accessible.
- ▶ Provide this user manual upon transfer of the ML-N4000 to a third party.
- ▶ Request a replacement user manual upon loss.

This user manual contains important information for safe, proper and efficient operation of the ML-N4000. Following this user manual strictly helps in avoiding dangers, reduces repair costs and downtime, while increasing the reliability and service life of the ML-N4000. It should be read, understood and applied by those using the ML-N4000 according to the user manual.

Pay particular attention to:

- the safety section (→ Safety and warranty)
- the text warnings of each section

Bear in mind that this user manual does not replace your responsibility as a ML-N4000 user.

Subject to change without prior notice. This applies especially to changes relating to technical enhancements.

1.2 Validity of the user manual

This user manual applies to X2E's dataloggers of the XORAYA ML-N4000 series. The exact type specifications can be found on the nameplate. (→ Identification)

The following instructions are key to operate the ML-N4000 and must be strictly observed under all circumstances.

Information in this user manual is subject to change without prior notice due to further technical developments and subsequent modifications. New features may not be described yet or may be described incompletely. Please ensure that you have the most current and complete user manual.

Users can change certain properties and functions via the included software, so that the ML-N4000 behaves differently than described herein. Users may revert to factory defaults at any time by pressing the default button on the front panel or via the supplied software. (→ Resetting to factory defaults)

1.3 Representation conventions

Representation	Meaning
▶ <Instruction>	User-executed action
▶ <Instruction option 1> <i>or</i> ▶ <Instruction option 2>	Instruction options
☑ <Outcome>	Outcome of an action or a series thereof
▪ <Level 1 a> – <Level 2 a> – <Level 2 b> ▪ <Level 1 b>	Maximum two-level enumeration
→ <Cross-reference>	Clickable cross-reference to a section or heading (In most Windows programs, you can return to the previous position by pressing <i>ALT + Left arrow</i>)
<Text>	Housing label, GUI element or other highlighting
#	Placeholder for numbers
(1) or (A)	Reference to numbered markers in graphics

1.4 Pictograms

This manual uses pictograms to highlight and ensure faster recognition of important or especially useful information.

Warning:



These types of symbols indicate warnings that must be observed.

The following subsections contain a description of the basic structure and relevance of different warning levels.

General information:



This symbol indicates general information.

General information includes application tips and particularly useful information excluding warnings or hazards.

License information:



This symbol indicates license information.

License information contains either general information about licenses for the ML-N4000 or indicates whether a license is required for a particular function.

1.4.1 Meaning of warnings

Warnings are systematized according to the severity and probability of their occurrence.



CAUTION

This pictogram in conjunction with the word *Caution* warns of a potentially dangerous situation, or an unsafe procedure.

Ignoring this warning information could result in injury or property and environmental damage.



WARNING

This pictogram used in conjunction with the word *Warning* warns of a potentially imminent danger to the health and lives of people.

Ignoring this warning could cause serious personal injury, including death in the worst case.



DANGER

This pictogram used in conjunction with the word *Danger* warns of an imminent danger to the health and life of people.

Ignoring this warning causes serious personal injury, including death in the worst case.

1.4.2 Structure of warnings

Warnings are separated from the surrounding text by lines set above and below.



SIGNAL
WORD

Danger types and sources

Explanation and consequence of danger

- ▶ Actions to prevent danger

1.5 X2E-Wiki

The X2E-Wiki at <http://wiki.x2e.de> provides the following information:

- Latest software
- Latest firmware
- Latest license file

For access details, please send an email stating your contact data to wiki@x2e.de. We will send you the appropriate access data. You may request your access details at any time if necessary.

2 Safety and warranty

The XORAYA ML-N4000 dataloggers were developed according to the latest state of the art and offer outstanding safety levels. During operation, however, this safety level can only be achieved if the user complies with all relevant safety regulations.

Upon measuring, safety regulations of the professional associations must be observed.

Please contact an expert or the service of X2E GmbH when in doubt about the operation, safety, or connection of the ML-N4000.

2.1 Intended use

The ML-N4000 is used for real-time acquisition of data communication in automotive bus systems. You can perform, store and transfer measurements to a PC, where you can read and analyze them using the GUI of the XORAYASuite.

- The ML-N4000 is intended for use only by trained personnel.
- The ML-N4000 must not be used in residential or living areas. Its use is strictly limited to industrial environments.
- The ML-N4000 must also not be used in outdoor areas or hazardous areas.
- Always operate the ML-N4000 within its technical specifications. (→ Technical data)
- The ML-N4000 may only be used under the conditions and for the purposes for which it was designed.
- Repairs may only be carried out by trained personnel of X2E GmbH.
- Operational safety cannot be guaranteed after modifications or conversions.
- Except for data buses, never perform measurements on live parts.
- The 4-mm plug of the power supply cable delivered must never be introduced in low-voltage sockets.
- The data lines may be extended up to a maximum of 30 m (USB: 3 m, eSATA: 1 m) provided that they are shielded like the supplied cables.
- The voltage supply may be extended up to a maximum of 3 m with sufficient cross-section.

2.2 Safety label on the device

You find the following safety label on the ML-N4000 top side:



Burning hazard due to hot surfaces

Continuous operation can strongly heat up the ML-N4000. As a result, it can burn the skin on the hands when touching it.

- ▶ Wear temperature-resistant ESD gloves when in contact with the ML-N4000.

2.3 General safety instructions



DANGER

Electric shock caused by damage to components

Any damage to the ML-N4000, power source or connection cable may cause an electric shock.

- ▶ Switch on the ML-N4000 only if all components appear undamaged.
- ▶ Only commission the ML-N4000 after a proper installation or repair.
- ▶ Check the connecting cable regularly for defects to prevent damage to the power source.
- ▶ Always install the ML-N4000 in de-energized status.



WARNING

Defects influencing the environment

The incorrect ML-N4000 configuration can lead to the temporary or permanent functional failure of connected vehicles.

Connected vehicles being operated on public roads bear an increased risk of injury and damage.

- ▶ If available, use configuration templates provided by the vehicle manufacturer.
- ▶ Use preferably the passive recording modes of the interfaces.



CAUTION

Device damage due to short circuit

Bent connector pins pose a short circuit risk. This can lead to abnormal behavior or destruction of the ML-N4000.

Likewise, devices connected to the measurement setup may be also compromised.

- ▶ Make sure that connector pins are not bent.
- ▶ Check the ML-N4000 regularly for any deficiencies.



CAUTION

Device damage due to electrostatic discharge

Electronic components can be destroyed by electrostatic discharge.

- ▶ Avoid touching connectors and connector pins.
- ▶ Ground yourself before carrying the ML-N4000 in your hands.
- ▶ Operate the ML-N4000 in an ESD-compliant environment.



CAUTION

Device damage due to overheating

Overheating can lead to abnormal behavior or destruction of the ML-N4000.

- ▶ Do not operate the ML-N4000 outside the specified temperature range.
- ▶ Never operate the ML-N4000 near heat sources.
- ▶ Please ensure adequate air circulation for operation.
- ▶ Do not cover the ML-N4000 with other objects.



CAUTION

Device damage due to shocks

Excessive vibration can lead to abnormal behavior or destruction of the ML-N4000.

- ▶ Avoid exposing the ML-N4000 to excessive vibration.



CAUTION

Device damage due to pollution

Avoid any contamination in plugs and sockets to ensure a reliable contact.

- ▶ Keep the ML-N4000 clean.



CAUTION

Device damage due to device opening

Unauthorized opening of the ML-N4000 can lead to abnormal behavior or destruction of the device.

- ▶ Never open the ML-N4000.
 - ▶ Contact X2E GmbH should maintenance and repairs be required.
-



CAUTION

Device damage due to penetration of dust or liquids

Dust or moisture inside the ML-N4000 may cause abnormal behavior or destruction of the device.

- ▶ Only operate the ML-N4000 with a closed housing.
- ▶ Do not operate the ML-N4000 outdoors.
- ▶ Do not operate the ML-N4000 outside the specified temperature range.
- ▶ Turn off the ML-N4000 and disconnect it from the power supply before you start cleaning.



CAUTION

Damage due to improper device shutdown

Disconnecting the power supply during operation may cause data loss and destruction of the ML-N4000.

- ▶ Never disconnect the ML-N4000 from the power supply while in operation.
- ▶ Ensure proper connector seating and tighten the screws if possible.
- ▶ Only shut down the ML-N4000 through the XORAYASuite or the power button on the front panel.
- ▶ Pull the black plug connected to ground last when disconnecting the ML-N4000 from the power supply.



CAUTION

Safety defects due to incorrect accessories and spare parts

Accessories and spare parts that have not been recommended by X2E GmbH negatively affect the safety, functionality and precision of the ML-N4000.

X2E GmbH shall assume no responsibility whatsoever or honor any warranty for damages arising from non-recommended accessories and spare parts or incorrect use.

- ▶ Use only accessories recommended by X2E GmbH and original spare parts.
-

2.4 Product liability

In the following cases, the intended protection of the ML-N4000 may be adversely affected. The liability is then transferred to the user.

- The ML-N4000 is not used according to the manual.
- The ML-N4000 is used outside the scope described in this manual.
- The user modifies the ML-N4000 without proper authorization.

2.5 Terms of use

If the installation of the ML-N4000 in a vehicle is intended for operation on public roads, the user and the X2E GmbH must jointly perform a risk analysis beforehand. This analysis must consider the specific installation requirements and the valid factory standards at the user's site.

Conditions set forth in framework contracts shall apply.

The ML-N4000 is continuously developed. The development process relies on the cooperation between the user and X2E GmbH.

2.6 Warranty

The warranty period is 12 months. Device batteries, whether internal or external, are excluded from the warranty. The warranty also excludes damages arising from improper handling.

X2E GmbH guarantees that the media on which the software is located are free of material errors under normal operating conditions. Users can return any defective or materially erroneous media to X2E GmbH within a period of 30 days from date of original purchase. Media shall be replaced immediately at no cost.

X2E GmbH guarantees that the software as described herein is basically usable. X2E GmbH, however, shall assume no liability for the correctness and the continued use of the software, given that the current state of the art prevents the production of software suitable for all combinations of hardware and software.

In particular, X2E GmbH cannot guarantee that the software meets any user requirements, or that it is compatible with any programs the latter may have selected. Responsibility for program selection and the consequences of program use lie entirely with the user.

X2E GmbH shall assume no liability for damages arising from faulty recorded data, as well as damage due to incorrect configuration, data entry and data transfer.

After configuring, we recommend to verify the proper operation and plausibility of each sensor using some manual measurement over the entire measuring range.

X2E GmbH shall assume no further liability. This limitation of liability also applies to the personal liability of employees, representatives and organs of X2E GmbH.

2.7 FCC notice

This equipment has been tested and found to comply with the limits for a *Class B* digital device, pursuant to part 15 of the FCC Rules. These limits are designed to provide reasonable protection against harmful interference in a residential installation. This equipment generates, uses and can radiate radio frequency energy and, if not installed and used in accordance with the instructions, may cause harmful interference to radio communications. However, there is no guarantee that interference will not occur in a particular installation. If this equipment does cause harmful interference to radio or television reception, which can be determined by turning the equipment off and on, the user is encouraged to try to correct the interference by one or more of the following measures:

- Reorient or relocate the receiving antenna.
- Increase the separation between the equipment and receiver.
- Connect the equipment into an outlet on a circuit different from that to which the receiver is connected.
- Consult an experienced radio/TV technician for help.

Changes or modifications made to this equipment not expressly approved for compliance may void the FCC authorization to operate this equipment.

3 Product description

The XORAYA dataloggers are high performance automotive dataloggers capable of recording data from multiple different data sources simultaneously. In addition, the modular concept makes it possible to react quickly and flexibly to future requirements.

The XORAYA ML-N4000 datalogger can be equipped with the following interfaces:

- CAN
- FlexRay
- LIN
- RS-232
- Analog
- 1GbE/10GbE
- 100/1000Base-T1
- eSATA

The ML-N4000 is based on the Xilinx Zynq® UltraScale+™ MPSoC. The built-in supercapacitor unit is able to bridge power fluctuations and to shut the ML-N4000 down safely in case of power failures.

The data can be stored with a precise, central time stamp with a resolution of 100 ns both on the internal or external storage medium and on a computer system via Ethernet interface. Both modes can also be operated in parallel.

Operation can be managed via the graphical user interface XORAYASuite, whereby the ML-N4000 can be configured, and data recorded and downloaded from the ML-N4000. Moreover, you can evaluate the recorded data and export them to many popular formats.

3.1 Identification

The top side of the ML-N4000 bears a silver nameplate, which contains the following information:



- **Device type** Product variant
- **Serial number** Unique identification number for this ML-N4000
- **Configuration** First block: Product ID
0200 XORAYA Datalogger
Second block: Product variant
0600 XORAYA ML-N4000
Third block: Hardware revision
- **Input** Maximum current consumption at given standard input voltage
- **DMF / MOD** Date of manufacture (DMF) and possibly of the last modification (MOD)

Upon device-specific issues, always provide the serial number and configuration.

The interface configuration of a ML-N4000 is variable and, therefore, not recorded on the nameplate.

3.2 Scope of delivery

The following components are part of the delivery:

- XORAYA ML-N4000
- Power supply cable
- Software
- User manual
- Cable set, depending on the interface configuration

The following accessories are optionally available:

- Power supply cable with AC adapter (recommended)
- XORAYA External Storage Unit
- Additional cables
- Mounting material
- Device bag

Additionally, we recommend the following third-party accessories:

- USB 3.1 standard cable, screwable, 1 m, from IDS (item number AD00223)
- SFP+ module FTLX8573D3BTL from Finisar

3.3 Connections and controls

The front side of the ML-N4000 contains ports, buttons and LEDs for operation and elementary functions. The back side of the ML-N4000 contains, depending on the hardware configuration, up to five log interfaces.

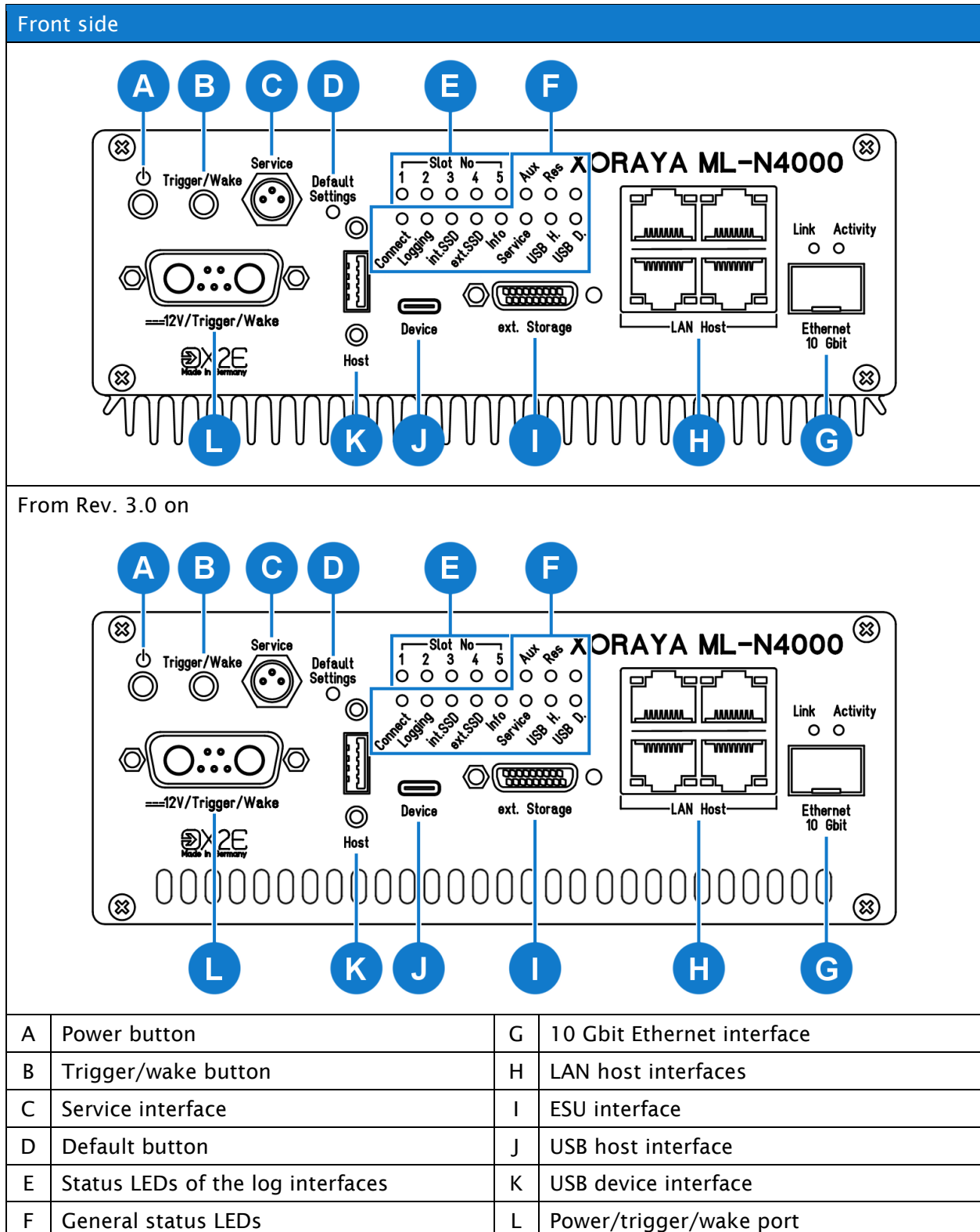

Power button (A):

If you press this button while the ML-N4000 is operational, the device switches to sleep mode.

If the ML-N4000 is operational and this button is pressed together with the trigger/wake button **(B)**, the ML-N4000 turns off completely.

You cannot turn off the ML-N4000 using this button when the device is connected to a PC and the *Connect* LED is lit. In this case, you can turn off the ML-N4000 via the *Logger* menu of the XORAYASuite. Here, you may choose between two options, i.e. *Shutdown* and *Shutdown (no wake up)*. (→ *Logger*)

Trigger/wake button (B):

The function of this button depends on the ML-N4000 state. The following table describes these functions as delivered. Users can configure this behavior via the XORAYASuite in the settings of the button interface. (→ *Button*)

State of the ML-N4000	Function
Sleep mode	ML-N4000 wakes up
Switched on	Start HDD recording
Switched on, recording active	<ul style="list-style-type: none">▪ Short press: Setting a mark (an event) in the recording▪ Long press (3 seconds at least): Stop current recording

Service interface (C):

In case of errors, this interface is used as a debugging interface by the X2E support team.

Default button (D):

Press the default button with a pointed object for at least 3 seconds to reset all ML-N4000 settings to factory defaults.

Status LEDs of the log interfaces (E):

A constantly lit status LED indicates an existing and activated log interface on the corresponding slot. The LED flashes when messages are received.

General status LEDs (F):

These LEDs indicate the operating status of the ML-N4000.

LED	Meaning
Connect	Connection between ML-N4000 and XORAYASuite is established
Logging	Logging in progress LED flashes as the logging stops, because the stopping process may take longer depending on the queue fill level
int. SSD	Flashes when accessing the internal storage medium
ext. SSD	Lights up when cable connection to XORAYA ESU is established <ul style="list-style-type: none"> ▪ Red: connection enabled (locked) ▪ Green: connection disabled via button (unlocked)
Info	ML-N4000 is DHCP server
Service	Lights up constantly when the ML-N4000 is in firmware update or recovery mode Displays different error codes by flashing
USB H.	Flashes when accessing a connected USB flash drive
USB D.	(Currently not used)
Aux	Lights up constantly when one of the additional interfaces without hardware slot (for example GNLog, Button) is activated Flashes when messages are received
Res	(Reserved)

10 Gbit Ethernet interface (G):

This interface can be used for data recording or as a faster alternative to the 1 Gbit host interfaces (H). A plugged-in SFP+ module is required. X2E recommends the module FTLX8573D3BTL from Finisar.



LAN host interfaces (H):

The ML-N4000 features four ports to connect to a switch or directly to a PC. This is necessary to control the ML-N4000 via software and exchange data.

ESU interface (I):

This port is used to connect the additional device XORAYA External Storage Unit (ESU). If the ML-N4000 detects this device, the measurements in HDD mode are saved there instead of to the internal storage medium.
(→ HDD mode)

The LEDs in the following table are both on the front and on the back side of the XORAYA ESU.

LED	Meaning
	Lights up when cable connection to ML-N4000 is established <ul style="list-style-type: none">▪ Red: connection enabled (locked)▪ Green: connection disabled (unlocked)
	Lights up green when XORAYA ESU is voltage-supplied from the ML-N4000
	Flashes red when accessing the XORAYA ESU



Remove XORAYA ESU safely

To avoid data loss, always press this button for at least one second before disconnecting the cable connection. When the corresponding LED is lit green, you can pull the cable.

USB device interface (J):

This port has currently no function for the user.

USB host interface (K):

By using a USB flash drive, the following functions are available:

- Data recording
 - Label the USB flash drive *XORAYALOG* and create the folder *usb_queue* there.
 - Check *Record on USB stick* in the *Hard Disk* category of the system settings. (→ Hard Disk)
 - Start data recording in HDD mode. (→ HDD mode)
- Updating the firmware
 - Create the folder *xoraya_update* on the USB flash drive and copy the firmware archive there.
 - Connect the drive and the firmware is automatically updated.
- Generating the supportfile
 - The supportfile is a set of files that you can send to X2E support to help solve technical issues.
 - Create the folder *xoraya_supportfile* on the USB flash drive.
 - Connect the drive and the supportfile is automatically generated. The *Info* LED flashes during the process.

Additionally, use the trigger input (L) or the trigger button (B) to safely disconnect the USB flash drive after use. Check the corresponding action of the Button interface. (→ Button)

Power/trigger/wake port (L):

By default, the ML-N4000 must be supplied with 12 V DC voltage. Optionally, it can also operate with power supplies in a certain specified range. (→ Technical data)

Trigger input and trigger button offer an analogous operation. A +12 V signal level at the trigger input is equivalent to pressing the trigger button. (→ Trigger/wake button)

The wake input allows waking up the ML-N4000 from sleep. To that end, the wake signal must shift from 0 V to +12 V.

Back side (configuration examples)

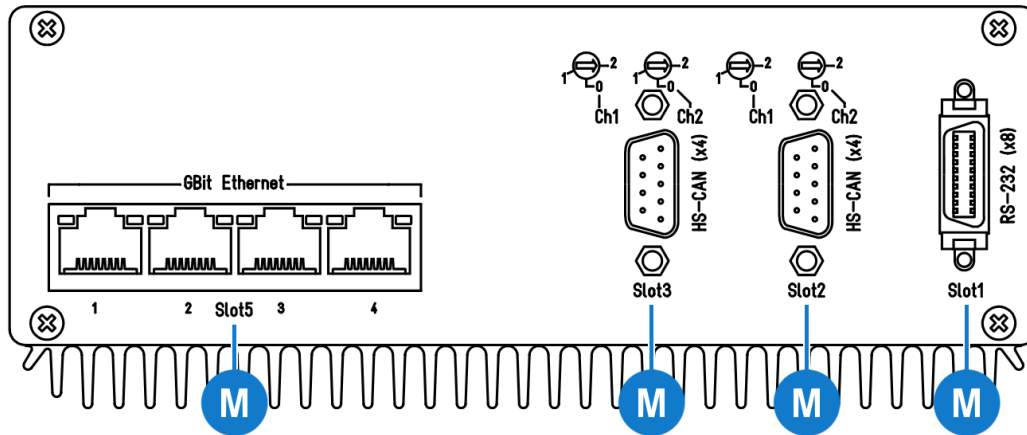

From Rev. 3.0 on

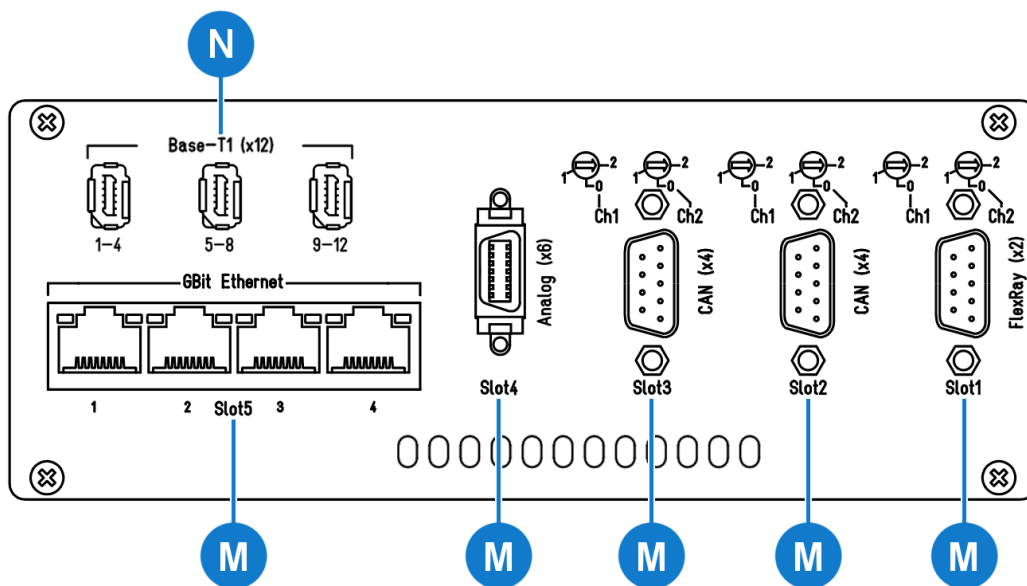

M Log interfaces

N Base-T1 add-on

Log interfaces (M):

The slots can be variably equipped with up to five interfaces.

Slot and channel number of each hardware interface are also displayed in multiple locations of the XORAYASuite tool *Configuration*:

(➔ Interface configuration)

- Main overview for all interfaces
- Main overview for all channels of one interface type
- Settings for the corresponding interface channel

You find the switch assignments in the chapter *Commissioning*
(→ Configuring switches) and the pin assignments in the *Appendix*.
(→ ML-N4000 pin assignments)

Base-T1 add-on (N):

This interface is not part of the log interface slot system **(M)** but implemented as an add-on board.

4 Commissioning

4.1 Unpacking

Upon unpacking, check whether the delivery is complete and all components appear in perfect condition. (→ Scope of delivery)

- ▶ Please contact X2E GmbH immediately should the delivery be incomplete or upon damaged components.
- ▶ Do not put any defective component into operation.

X2E GmbH can only accept your complaint and replace the affected component upon prompt notification.



Keep original packaging

Keep the original packaging and packing materials for later storage or further transport.

4.2 Selecting an installation location

The ML-N4000 installation location must meet the following criteria:

- Location of the DC power supply (12 V)
- Distance of at least 4 cm to other devices
- Solid and stable base
- Adequate airflow
- ML-N4000 front and back sides must not be covered

4.3 Installing the ML-N4000

Install the ML-N4000 in vertical position with the front side up to ensure the best possible heat dissipation.

Furthermore, install the ML-N4000 in the vehicle so as to avoid a damage risk at any time.

4.4 Installing the XORAYASuite

Users must install the GUI XORAYASuite on a PC with the following minimum requirements to be able to configure the ML-N4000 and analyze the recorded data.

Supported operating systems:

- Microsoft® Windows® 7 (32 Bit or 64 Bit)
- Microsoft® Windows® 8 (32 Bit or 64 Bit)
- Microsoft® Windows® 10 (32 Bit or 64 Bit)

Hardware requirements:

- Processor speed at least 1 GHz
- RAM at least 2 GB
- Storage space approx. 120 MB available

Software requirements:

- Microsoft® .NET Framework Version 4.5 or higher

Installation:

- ▶ Close all open programs.
- ▶ Use the XORAYASuite setup wizard from the supplied data medium.
or
- ▶ Download the latest version of the XORAYASuite from the X2E-Wiki.
(→ X2E-Wiki)
- ▶ Start the setup wizard and follow the instructions.

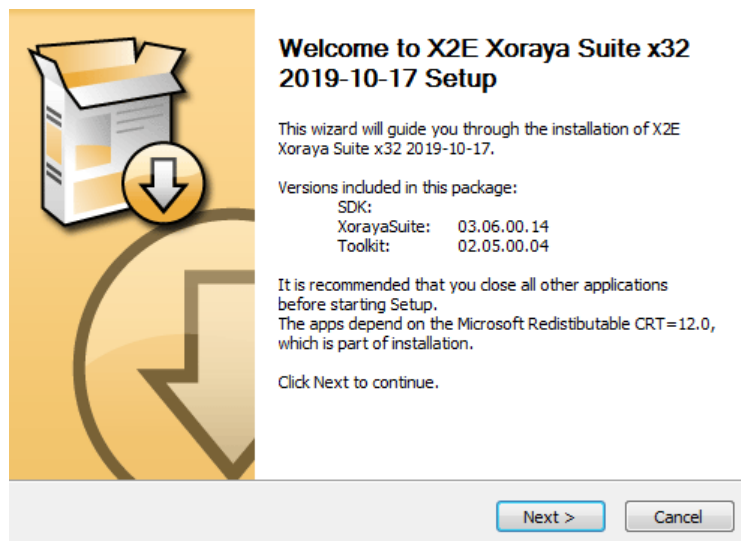

4.5 Connecting the ML-N4000 to the measuring environment

This section describes how to connect the ML-N4000 to the measuring environment.



CAUTION

Device damage due to incorrect connection sequence

The incorrect connection sequence can lead to abnormal behavior or destruction of the ML-N4000.

- ▶ According to the numbering of the subsections, connect the interfaces first and then the power supply.
- ▶ Please note the correct connection sequence from top to bottom within the subsection.

4.5.1 Interfaces



Observe pin assignments

Please note the port pin assignments when connecting the ML-N4000 with the measuring environment. Wrong pin assignments lead to measurement errors.

Please note the following sequence:

- ▶ Connect the data cables of all data buses to be monitored in the measuring environment.
- ▶ Connect the data cables to the appropriate ML-N4000 ports.
- ▶ Wherever possible, tighten the connector screws on the ML-N4000 and in the measuring environment.

The ML-N4000 is connected to all data buses to be monitored.



Loss of data due to port disconnections

To avoid data loss, never disconnect the ML-N4000 during the current recording from connected data buses.

Furthermore, make sure that all connectors are firmly attached and the screws are tightened.

4.5.2 Power supply

This chapter describes the default connection to a DC power supply via the supplied power cable. If you use the optionally available power cable with AC adapter, please note the specifications on the adapter label.



DANGER

Electric shock due to improper connection of the power supply

Introducing the 4-mm plugs of the supplied power cable into low-voltage sockets can be fatal.

- ▶ Never introduce the 4-mm plugs into low-voltage sockets.
- ▶ Connect the supplied power cable only to a power source that meets the prescribed technical conditions.



CAUTION

Damage due to incorrect power supply

Using an incorrect power supply can lead to abnormal behavior or destruction of the ML-N4000.

- ▶ Use only the supplied power cable.
- ▶ Please ensure correct polarity upon connection.
- ▶ Make sure that the power supply used meets the prescribed technical conditions.
- ▶ Make sure that the power supply lies within permissible operating voltage of the ML-N4000.
- ▶ Please note the allowable voltage level when feeding external signals.
- ▶ Please note the technical specifications on the label when using the optionally available power cable with AC adapter.



CAUTION

Damage due to faulty connection

When connecting with live contacts, transient fault currents with entrained mass may arise on interface connections which have been already connected.

- ▶ Please ensure contacts are de-energized when connecting the ML-N4000 to the power supply.



Continuous current of the DC power supply

A 12 V DC power supply must deliver a continuous current of 1 A with 3.3 A peaks. Use a regulated power supply or a car battery and note the required voltage and current levels.

Please note the following sequence:

- ▶ Connect the power cable to port **(L)** on the ML-N4000.
(→ Connections and controls)
- ▶ Tighten the connector screws.
- ▶ Connect the black plug of the cable to 0 V or ground.
- ▶ Connect the red plug to the power supply.

The ML-N4000 is securely connected to the measuring environment.

Once the supply voltage is established, the ML-N4000 turns on and displays its operational status via the power button LED **(A)**.



CAUTION

Damage due to improper device shutdown

Disconnecting the power supply during operation may cause data loss and the destruction of the ML-N4000.

- ▶ Never disconnect the ML-N4000 from the power supply while in operation.
- ▶ Ensure proper connector seating and tighten the screws if possible.
- ▶ Only shut down the ML-N4000 through the XORAYASuite or the power button on the front panel.
- ▶ Pull the black plug connected to ground last when disconnecting the ML-N4000 from the power supply.

The ML-N4000 is equipped with an intelligent energy management system that lowers power consumption to about 1 mA (at 12 V supply voltage) in sleep mode.

The device goes into sleep mode via the following actions or under the following conditions:

- Pressing and holding the power button **(A)** for at least 2 seconds. Current recording stops automatically.
- If no data reach the log interfaces and no connection to the XORAYASuite is established for 10 minutes, the ML-N4000 shuts down automatically. This behavior is configured using the main setting *Automatically Switch Off*. (→ Main Settings)

Users can wake up the ML-N4000 from sleep mode as follows:

- Pressing the power button **(A)**
- Switching the power supply off and on
- Signal change from 0 V to +12 V at the trigger or wake input **(L)**
- Pressing the trigger/wake button **(B)**
- Activity on a wakeable log interface

4.6 Connecting the ML-N4000 to the PC

This section describes how to connect the ML-N4000 to the PC. To do so, you will need a standard network cable.

Proceed as follows to connect:

- ▶ Connect the network cable to a switch.

or

- ▶ Connect the network cable directly to your PC.
- ▶ Connect the network cable to one of the LAN host interfaces **(H)** or the 10 Gbit Ethernet interface **(G)**. (→ Connections and controls)

- The ML-N4000 is fully connected.

4.7 Configuring switches

- ▶ Configure the built-in terminators via the rotary switches on the back of the ML-N4000.
- ▶ For the LIN interface, select between internal or external power supply via the toggle switch.

4.7.1 4x CAN

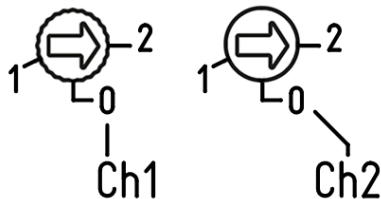

Position	Resistance
0	Open (∞)
1	2.6 k Ω
2	120 Ω

The channels 3 and 4 have the value *Open* and, therefore, are not terminated.

4.7.2 2x FlexRay

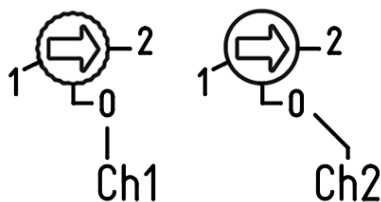

Position	Resistance
0	Open (∞)
1	2,6 k Ω
2	90 Ω

4.7.3 7x LIN



Position	Power supply
Vi	Internal
Ve	External

Use the internal power supply of the LIN measurement card only if the connected LIN device uses the ML-N4000 voltage as a reference voltage. Bear in mind that this is not possible when using the ML-N4000 in a 24-V electrical system, for example. In this case, connect the external power supply port to the corresponding reference voltage.

5 XORAYASuite

This chapter describes the operation of the graphical user interface XORAYASuite.

5.1 Starting

- ▶ Perform all commissioning steps. (→ Commissioning)
- ▶ Start the XORAYASuite by double-clicking the desktop icon.

or

- ▶ Start the XORAYASuite from the Windows Start menu.

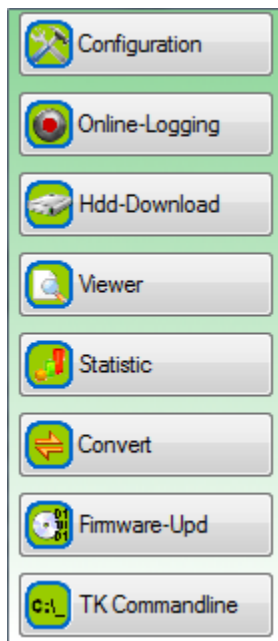

Upon start, XORAYASuite provides access to the various tools.

Tool	Function
Configuration	Customize the ML-N4000 behavior
Online-Logging	Start and stop logging
Hdd-Download	Download measurements from the ML-N4000 storage medium
Viewer	Evaluate measurements
Statistic	Evaluate bus statistics
Convert	Convert log data to other formats
Firmware-Update	Update firmware
TK Commandline	Command line access to the XORAYAToolkit

- The XORAYASuite is started.



Windows notification area

Even after closing the launcher, the XORAYASuite continues to operate in the background. Click the icon in the Windows notification area to access tools or to close the XORAYASuite.

5.2 Menu bar

This section describes the five main menus of the menu bar.

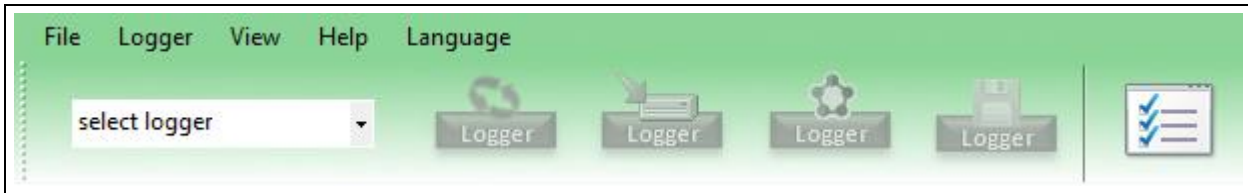

Individual menu commands are not available in every tool.

5.2.1 File

Among other things, you can use the *File* menu to open and save files, or close the tool.

Command	Description
Open configuration	Opens a configuration file (XML)
Save configuration	Saves the current configuration
Save configuration as	Saves the current configuration under a different name
Save interface configuration as	Saves the current interface configuration under a different name The subitem <i>System settings and signals</i> saves everything except the interface configuration
Open	Opens an info file (DLI) and the associated log data Alternatively: ZIP archive containing info file and log data
Close	Closes the open log data
Open SWU/XSWU file	Opens a firmware image
Refresh properties	Reloads the current configuration of a selected interface from the ML-N4000
Recent files	Displays the most recently opened info files (DLI) and opens them when needed
Export preferences	Exports the output format settings in a preference file (XML)
Import preferences	Imports the output format settings from a preference file (XML)
Exit	Closes the tool

5.2.2 Logger

Among other things, you can use the *Logger* menu to connect or disconnect the ML-N4000 with the XORAYASuite.

Command	Description
Connect	Connects the selected ML-N4000
Disconnect	Disconnects the active connection to the ML-N4000
Offline-Logging > Start	Starts the logging process on the ML-N4000 storage medium
Offline-Logging > Stop	Stops the logging process on the ML-N4000 storage medium
Online-Logging > Start	Starts the logging process on the PC
Online-Logging > Stop	Stops the logging process on the PC
Probe-Logging > Start	Starts probe logging (further information in the quick manual XORAYA μ T-Z7/Probe)
Probe-Logging > Stop	Stops probe logging
Save changed configuration permanently	Stores the changed settings permanently on the ML-N4000
Customer default configuration > Create	Stores the current permanent configuration (profile <i>active</i>) in the <i>customer-default</i> profile
Customer default configuration > Load	Loads the <i>customer-default</i> configuration profile into the <i>active</i> profile
Reset configuration to factory settings > Interfaces	Resets the ML-N4000 interface configuration to factory defaults
Reset configuration to factory settings > System	Resets the ML-N4000 system configuration to factory defaults
Format HDD	Formats the ML-N4000 storage medium
Synchronize time with > Local	Sets the system time of the ML-N4000 to the current system time of the PC
Synchronize time with > Vehicle	Sets the system time of the ML-N4000 to the current system time of the connected vehicle
Restart	Restarts the ML-N4000
Restart and reconnect	Restarts the ML-N4000 and reconnects
Shutdown	Puts the ML-N4000 in sleep mode
Shutdown (no wake up)	Shuts down the ML-N4000 completely

This menu does not appear in the *Viewer* and *Convert* tools.

5.2.3 View

Among other things, you can use the *View* menu to switch between normal and detail view.

Command/Setting	Description
Normal	Normal view
Detail	Detail view that displays all categories and properties in the <i>Configuration</i> and <i>Online-Logging</i> tools
Tab selection	Determines which tabs are shown in the <i>Online-Logging</i> tool
Tile windows vertically/horizontally	Determines whether the elements <i>Export settings</i> and <i>Output formats selection</i> in the <i>Hdd-Download</i> tool are displayed next to or below the list of sessions or measurements
Autosize columns	Adjusts the width of the columns in the <i>Hdd-Download</i> tool to ensure all are visible simultaneously.
1 Comment ... 22 Type spread	Determines which tabs are shown in the <i>Hdd-Download</i> tool
Legend	Determines whether the legend is shown in the <i>Hdd-Download</i> tool

This menu does not appear in the tools *Viewer*, *Convert* and *Firmware-Update*.

5.2.4 Help

Among other things, you can use the *Help* menu to access this manual.

Command	Description
Logger manual	Opens the ML-N4000 user manual
About	Displays system information on the software and, if connected, on the ML-N4000
Update software	Opens the X2E-Wiki to download the current XORAYASuite version
Show logfile	Displays a log file for the tool
Supportfile	Generates a set of files that you can send to X2E support to help solve technical issues

5.2.5 Language

Use the *Language* menu to change the language of the XORAYASuite.

Setting	Description
German (Deutsch)	Changes the language of the XORAYASuite to German
English (Englisch)	Changes the language of the XORAYASuite to English



Other menus

The *Edit*, *Download*, *Convert* and *Settings* menus are only available in two tools at the most. Their descriptions can be found in the corresponding sections of this user manual.

5.3 Status bar

The status bar on the bottom of the window provides information about the connected ML-N4000, for example the storage medium usage. In addition, the user interface is also adjustable for smaller displays there. The following buttons do not appear in the tools *Viewer*, *Statistics* and *Convert*.

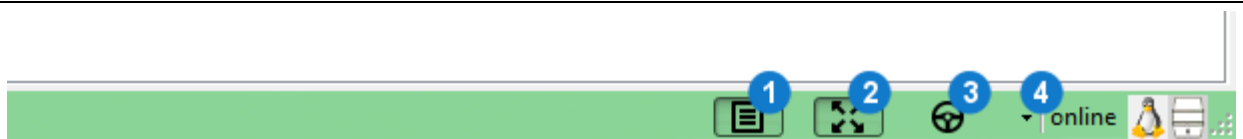

1	Show/hide menu bar	3	Show control dialogue
2	Show/hide toolbar	4	Show message queue

The control dialogue **(3)** allows quick access to the most important commands of the menu or tool bar.

5.4 Connecting and disconnecting the ML-N4000

The ML-N4000 is connected and disconnected in the same way regardless of the XORAYASuite tool. This section shows the process for the *Configuration* tool as an example.



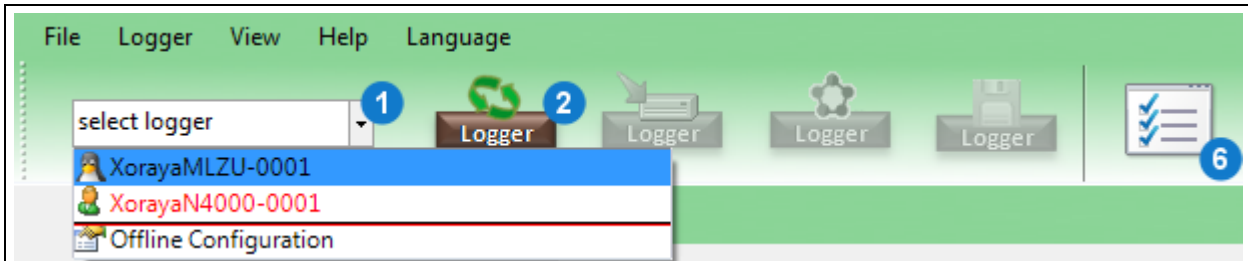



5.4.1 Connecting the ML-N4000



1	Display available loggers	6	Display settings
2	Establish connection to logger		

- ▶ Connect the ML-N4000 to the PC.
(→ Connecting the ML-N4000 to the PC)
 - ▶ Turn on the ML-N4000.
 - ▶ Start the desired XORAYASuite tool. (→ Starting)
 - ▶ Click *Display available loggers* (1) to start scanning for dataloggers.
 - ▶ Select the desired ML-N4000 (alternative name: MLZU) using the assigned name.
 - ▶ Click *Establish connection to logger* (2).
- or*
- ▶ In the *Logger* menu, click *Connect*. (→ Logger)
- The ML-N4000 is connected to the XORAYASuite.

Icons and text colors indicate the status of the ML-N4000:

-  and name **red** Network error, the ML-N4000 is located on a different subnet
-  and name **black** Disconnected ML-N4000
-  and name **red** Another user is connected to the ML-N4000
-  and name **blue** You are connected to the ML-N4000
-  Measurements are currently transferred from the ML-N4000 storage medium to the PC
-  ML-N4000 is in favorites list (→ Favorites)



Edit the configuration file

You can edit a configuration file (XML) previously created without connecting to the ML-N4000. To do so, select *Offline Configuration* in the drop-down list *Display available Loggers (1)* in the *Configuration* tool.

5.4.2 Disconnecting the ML-N4000

2	Release connection to logger	5	Display settings
3	Start Hdd logging		

- ▶ Click *Release connection to logger (2)*.
- or*
- ▶ In the *Logger* menu, click *Disconnect*. (→ *Logger*)
- ML-N4000 and XORAYASuite are disconnected.



HDD mode

Start the recording on the internal or external storage medium of the ML-N4000 via *Start Hdd logging (3)* or autonomously without a PC, as described in the relevant section. (→ *HDD mode*)

5.4.3 Favorites

You access the favorites list via *Display settings* button in the *Configuration*, *Online-Logging* or *Hdd-Download* tools.

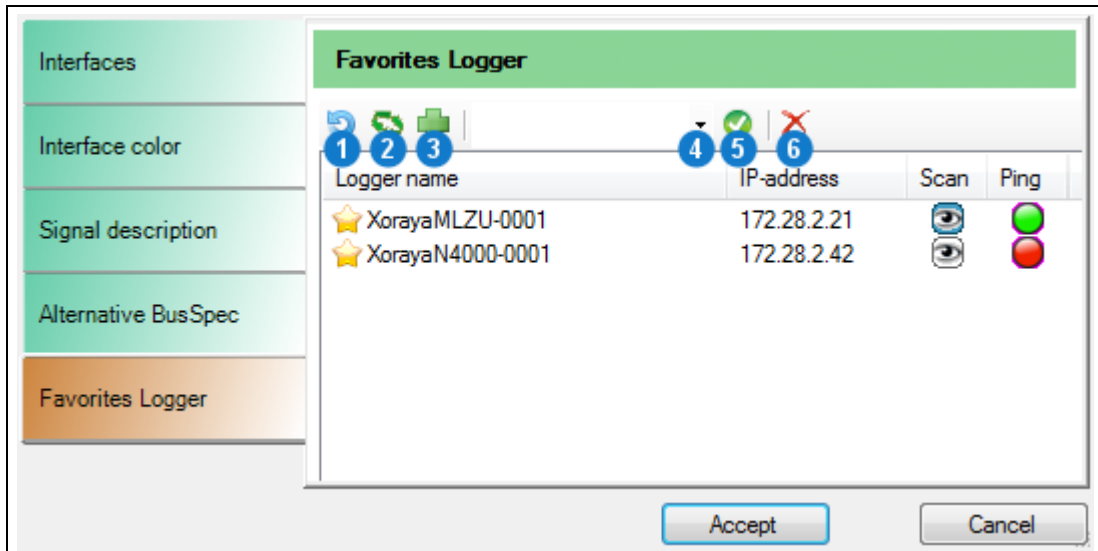

1	Refresh the device list	4	Devices in the network
2	Add currently connected device to favorites	5	Add selected device to favorites
3	Add a device to favorites manually	6	Remove device from favorite list

Save frequently used dataloggers in the favorites list. Favorites are displayed first in the list of available dataloggers and are marked with the star symbol.

Add ML-N4000 manually:

- ▶ Click *Add a device to favorites manually* (3).
- ▶ Specify *Logger name* and *IP-address*.
- ▶ Click *OK*.





Add ML-N4000 automatically:

- ▶ Click *Devices in the network* (4) to start scanning for dataloggers.
- ▶ Select the desired ML-N4000.
- ▶ Click *Add selected device to favorites* (5).

Additionally, you can add the currently connected ML-N4000 directly via button (2).

The symbols in the columns *Scan* and *Ping* display the current reachability of the dataloggers in the list. *Ping* reaches beyond subnet boundaries.

Meaning of the symbols:

-  and  reachable
-  and  not reachable

5.5 Configuration

This tool allows the configuration of the ML-N4000 and its interfaces.

- ▶ Connect the ML-N4000 to the PC. (→ Connecting the ML-N4000 to the PC)
 - ▶ Turn on the ML-N4000.
 - ▶ Start the *Configuration* tool of the XORAYASuite. (→ Starting)
 - ▶ Connect to the desired ML-N4000. (→ Connecting the ML-N4000)
- The configuration can be performed.



WARNING

Defects influencing the environment

The incorrect ML-N4000 configuration can lead to the temporary, delayed or permanent functional failure of connected vehicles.

Connected vehicles being operated on public roads bear an increased risk of injury and damage.

- ▶ If available, use configuration templates provided by the vehicle manufacturer.
- ▶ Use preferably the passive recording modes of the interfaces.

All settings in the *Configuration* tool are stored permanently in the ML-N4000. Therefore, you can configure each ML-N4000 differently to meet the requirements of various application areas.

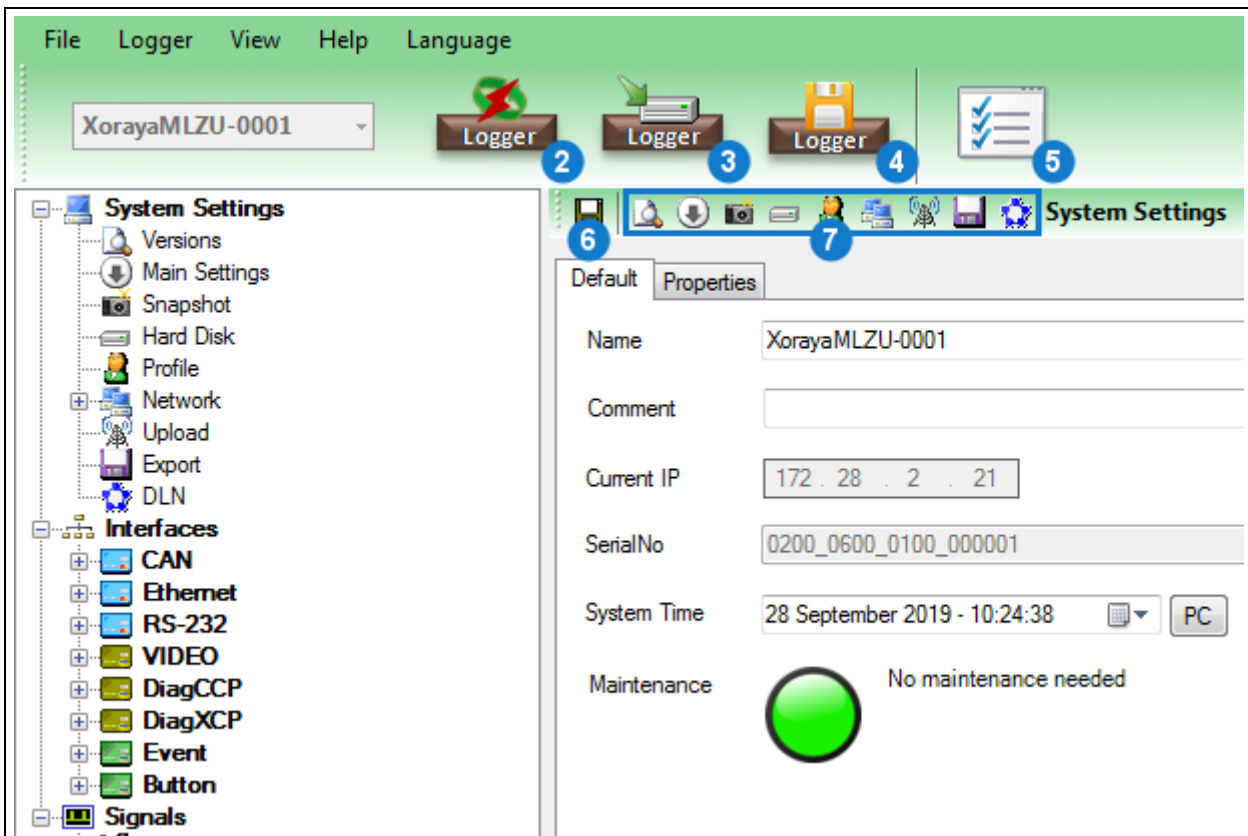

2	Release connection to logger	5	Display settings
3	Start Hdd logging	6	Save configuration file
4	Save changed configuration permanently	7	Categories

The tree structure on the left side of the window displays system settings, available interfaces and signals at the highest level. Expand the tree at the desired position and to the desired depth to access the sub-items.

The current configuration of the selected sub-item is displayed on the right side of the window. This is where you can perform any changes required and optionally save them as a configuration file (XML) on your PC via button (6). The toolbar (7) allows a quick jump to all categories of this level.

Use the *Default* tab to access the screen for the main default settings.

Use the *Properties* tab to access properties and thereby all available settings. This tab is only visible if the detail view is enabled.



Enabling the detail view

In the *View* menu, click *Detail* to enable the detail view.

You can view the properties sorted either alphabetically or by category. Properties that cannot be modified by the user are greyed out.

Configuration changes can be saved temporarily or permanently.

Save temporarily:

- ▶ Change the desired default setting or property.
 - The configuration is saved temporarily.

Changes to default settings or properties are discarded after the ML-N4000 restarts.

Save permanently:

- ▶ Click *Save changed configuration permanently (4)*.
or
- ▶ In the *Logger* menu, click *Save changed configuration permanently*.
 - The configuration is saved permanently.



Delayed change update

For certain settings, such as *Name* and *IP Address*, changes are not applied immediately but only after a ML-N4000 restart.

The *Maintenance* symbol indicates whether there is a ML-N4000 malfunction and, where appropriate, the error source.



HDD mode

Start the recording on the internal or external storage medium of the ML-N4000 via *Start Hdd logging (3)* or autonomously without a PC, as described in the relevant section. (→ HDD mode)

Use *Display settings (5)* to customize the following:

- Color assignments for the interfaces
- Load signal description file (→ Signal description settings)
- Load configuration template (Busspec)
- Manage logger favorites (→ Favorites)

5.5.1 System configuration

System settings are configured via properties stored on the ML-N4000.

These properties fall under various categories:

- Main Settings
- Network
- Hard Disk
- Snapshot
- Versions
- Profile

Select the category:

- ▶ Click the root element of *System Settings* to display the main settings of all categories.

or

- ▶ Click a category to view the main settings of this category.

System Settings > Main Settings:

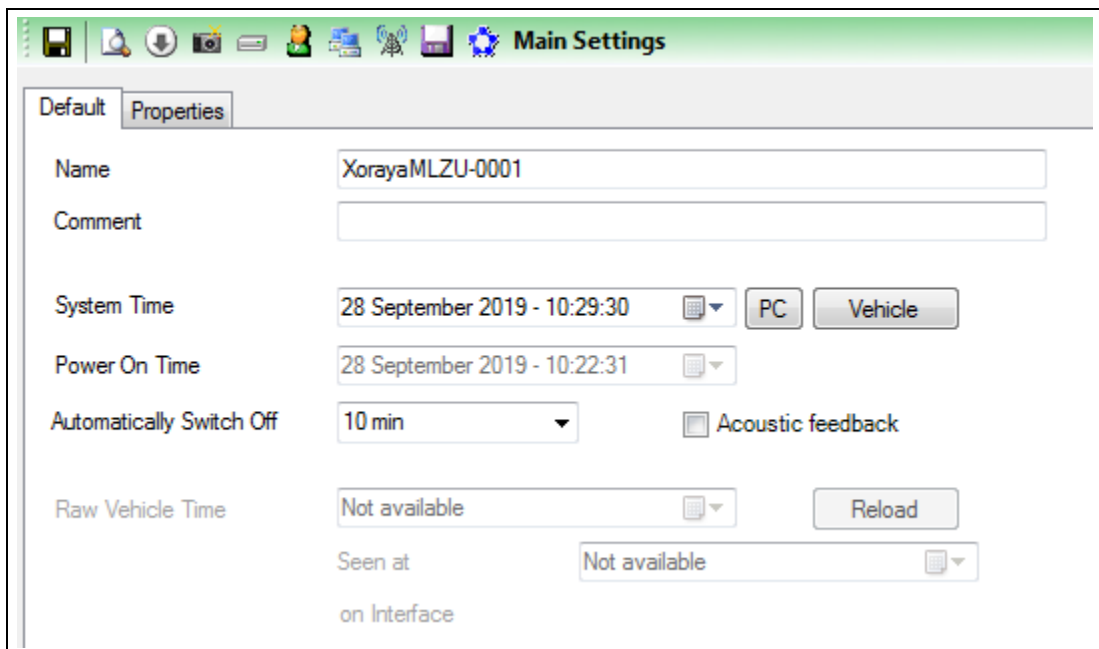

The screenshot shows the 'Main Settings' window with the following fields and controls:

- Name:** XorayaMLZU-0001
- Comment:** (empty text box)
- System Time:** 28 September 2019 - 10:29:30. Includes 'PC' and 'Vehicle' buttons.
- Power On Time:** 28 September 2019 - 10:22:31
- Automatically Switch Off:** 10 min. Includes an 'Acoustic feedback' checkbox.
- Raw Vehicle Time:** Not available. Includes a 'Reload' button.
- Seen at:** Not available on Interface.

Setting	Description	Default
Name	Freely selectable name of the ML-N4000	XorayaMLZU- <Serialnumber>
Comment	Current system time, internally with a precision of 100 ns Also used as a timestamp during logging	
System Time	Internally used property for the system time	
Automatically Switch Off	Time period after which the ML-N4000 shuts down, provided: <ul style="list-style-type: none"> there is no connection to the XORAYASuite there is no activity on any interface for which <i>Prevent Sleep Mode</i> is activated Values: Never, 1 min, 10 min, 20 min, 30 min, 60 min	10 min
Acoustic feedback	Acoustic feedback when: <ul style="list-style-type: none"> data recording is starting ML-N4000 is shutting down/sleeping 	Off



System Time

Click the appropriate button to synchronize with the PC or the vehicle time.

System Settings > Network:

The sub categories are assigned to the following interfaces
(→ Connections and controls):

- LAN Host eth0 LAN host interfaces (**H**)
- LAN Host eth1 10 Gbit Ethernet interface (**G**)

The screenshot shows the configuration for 'LAN Host eth0'. It includes sections for 'dynamic assigned IP-Address' and 'fixed IP-Address', both with fields for IP Address, Gateway Address, and Netmask. Below these are fields for 'Current IP-Address', 'Current Mac Address', 'Current DHCP mode', and 'max transmit unit (mtu)'. A 'Front switch settings' section contains a connection matrix table. A legend at the bottom maps numbers 1-5 to UI elements: 1 (Overall view), 2 (Separate view by ports), 3 (Symmetrical editing), 4 (Connection matrix), and 5 (Open MAC-IP assignments).

Source \ Target	bottom_left	top_left	bottom_right	top_right	host
bottom_left	<input type="checkbox"/>	<input checked="" type="checkbox"/>	<input checked="" type="checkbox"/>	<input checked="" type="checkbox"/>	<input checked="" type="checkbox"/>
top_left	<input checked="" type="checkbox"/>	<input type="checkbox"/>	<input checked="" type="checkbox"/>	<input checked="" type="checkbox"/>	<input checked="" type="checkbox"/>
bottom_right	<input checked="" type="checkbox"/>	<input checked="" type="checkbox"/>	<input type="checkbox"/>	<input checked="" type="checkbox"/>	<input checked="" type="checkbox"/>
top_right	<input checked="" type="checkbox"/>	<input checked="" type="checkbox"/>	<input checked="" type="checkbox"/>	<input type="checkbox"/>	<input checked="" type="checkbox"/>
host	<input checked="" type="checkbox"/>	<input checked="" type="checkbox"/>	<input checked="" type="checkbox"/>	<input checked="" type="checkbox"/>	<input type="checkbox"/>

1	Overall view	4	Connection matrix
2	Separate view by ports	5	Open MAC-IP assignments
3	Symmetrical editing		

Setting	Description	Default
dynamic assigned IP-Address	Activate DHCP	On
<DHCP-Server>	ML-N4000 DHCP mode <i>On</i> : DHCP server <i>Off</i> : DHCP client	On
IP Address	IP address assigned to the ML-N4000 if: <ul style="list-style-type: none"> ▪ <DHCP-Server> = <i>On</i> or ▪ <i>fixed IP-Address</i> = <i>On</i> 	10.104.2.21
Gateway Address	Gateway address assigned to the ML-N4000 if: <ul style="list-style-type: none"> ▪ <DHCP-Server> = <i>On</i> or ▪ <i>fixed IP-Address</i> = <i>On</i> 	0.0.0.0
Netmask	Netmask that divides the IP address into network and host part	255.255.255.0
fixed IP-Address	ML-N4000 with static IP address	Off
max transmit unit (mtu)	maximum packet size on the network layer (in Bytes)	1500

Provided the check box is selected, the ML-N4000 is only DHCP server if it cannot find another DHCP server within the network. Otherwise, the ML-N4000 requests the IP address from this server, acting as DHCP client.

Edit connection matrix **(4)**:

- ▶ Activate or deactivate the connections between the front switch ports.
- ▶ Activate or deactivate the ports as hosts.

If the button *Symmetrical editing* **(3)** is enabled, changing a connection automatically changes the opposite direction.

Change between *Overall view* **(1)** and *Separate view by ports* **(2)** as desired.

Static MAC to IP assignment when DHCP server is active:

MAC	IP
00:00:00:00:00:00	10 . 104 . 2 . 0
00:00:00:00:00:00	10 . 104 . 2 . 0
00:00:00:00:00:00	10 . 104 . 2 . 0
00:00:00:00:00:00	10 . 104 . 2 . 0
00:00:00:00:00:00	10 . 104 . 2 . 0

eth	MAC	IP
! eth0	00:11:22:33:44:55	172.28.1.64
! eth0	66:77:88:99:aa:bb	172.28.1.128

5	Close MAC-IP assignments	7	Refresh table of PCs in the network
6	Delete MAC-IP assignment		

DHCP server mode is intended for direct connections to PCs. You can bind MAC addresses of up to five PCs to IP addresses. Type them in manually or double-click in a row of the table that contains the addresses of the PCs in the network.

Red exclamation marks flag PCs outside the IP range.



Special care in network settings

Exercise extreme caution when changing these settings. Under certain circumstances, incorrect network settings of the ML-N4000 cannot be corrected.

In this case, you should reset the ML-N4000 back to factory defaults by pressing the default button (**D**) for 3 seconds. (→ Connections and controls)

System Settings > Hard Disk:

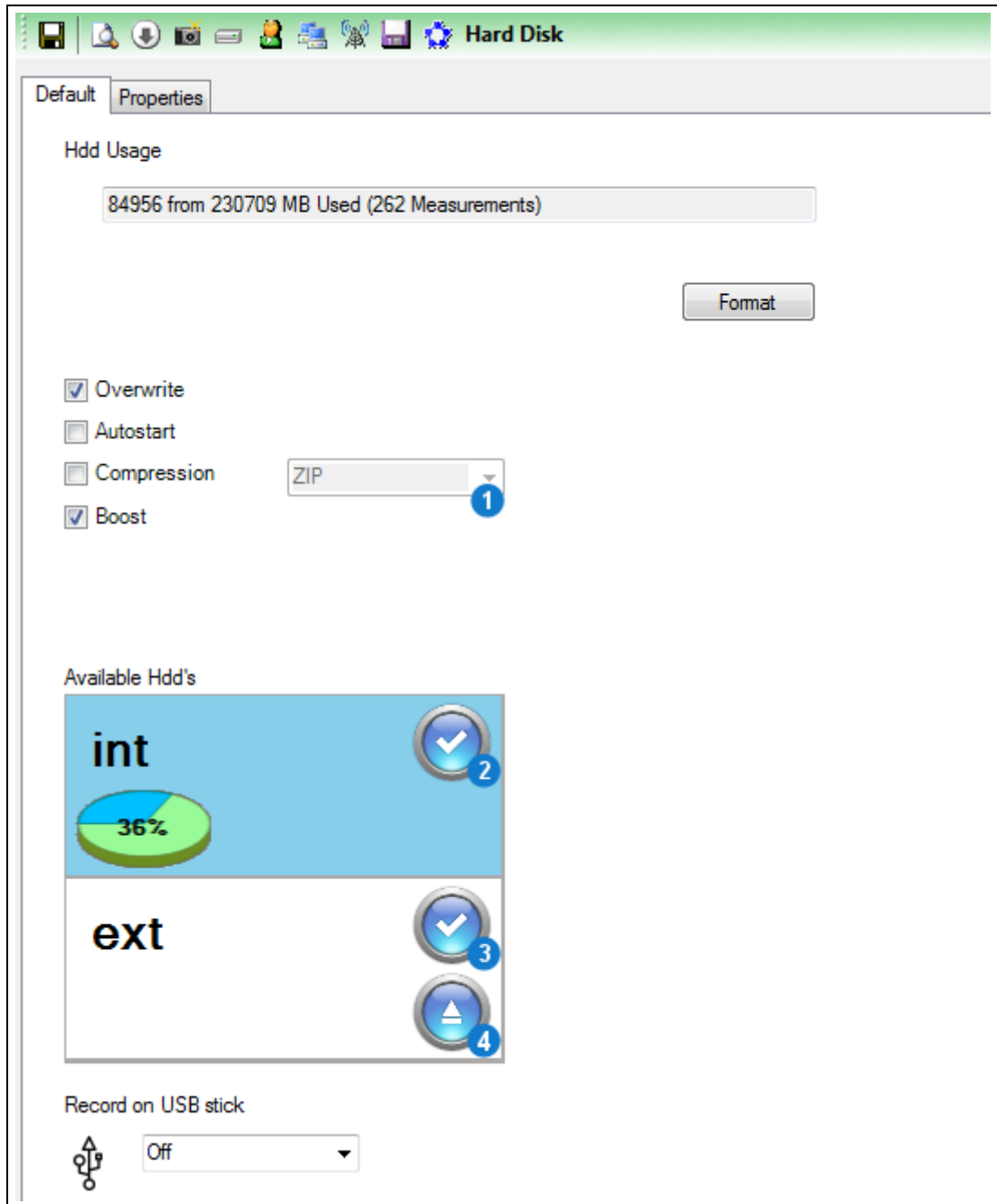

1	Compression method	3	Activate ESU*
2	Activate internal storage medium	4	Remove ESU safely*

* Only with connected XORAYA ESU

These settings and displays refer to the currently active storage medium, represented by the blue background color.

If a XORAYA ESU is connected to interface (I), you change the active storage medium via the buttons (2) and (3). (→ Connections and controls)

Setting	Description	Default
Overwrite	Control the ML-N4000 behavior if the storage medium is full <i>On</i> : Oldest session or measurement is overwritten <i>Off</i> : Recording is terminated	On
Autostart	Immediate recording after switching on the ML-N4000 or after disconnecting with the XORAYASuite	Off
Compression	Compress data before saving	Off
Boost	Increase write speed on the storage medium when processing the default-queue for packet data	On
Record on USB stick	HDD mode recording on a connected USB flash drive instead of on the internal or external storage medium <i>Off</i> : Disabled <i>Loop</i> : Circular buffer, which contains the most recent minutes of the recording <i>Linear</i> : Ongoing	Off



Compression

Compression reduces the data volume and, as a result, the download time, because data are decompressed on the PC.

After selecting the check box *Compression*, choose the compression method via the drop-down list (1):

- ZIP (slower, higher compression rate)
- LZ4 (faster, lower compression rate)

In addition to the settings, this view presents the usage of the storage medium and the number of stored measurements.

Use the *Format* button to delete all existing data from the storage medium.



Record on USB stick

For this mode, it is required that the connected USB flash drive is named *XORAYALOG* and contains the folder *usb_queue*.

System Settings > Snapshot:

Snapshots can be created during the measurement to track particularly interesting time periods. The moment you raise the corresponding trigger, all data received for a user-definable time before and after this moment, are stored in an additional snapshot measurement.

Measurement data are processed as queues on the log interfaces. In addition to the default-queue for packet data, the ML-N4000 is able to use the faster stream-queue where Ethernet data are saved directly without creating statistics. You can set snapshots for both queues separately.

Setting the snapshot:

- ▶ Configure the snapshot of the desired queue.
- ▶ Create one or multiple triggers for the action *logger.snapshot*.
(→ Trigger)
or
- ▶ Activate the property *snapshot_on_log_press* of the button interface.
(→ Button)

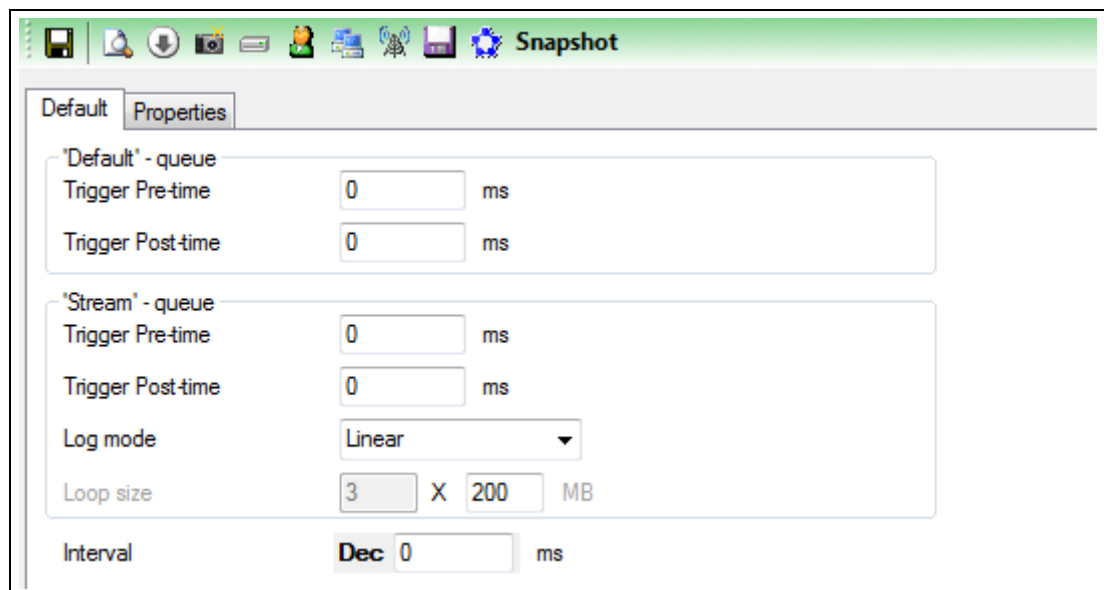

Setting	Description	Default
Trigger Pre-time (Default-queue)	Leading time of the snapshot for the default-queue (in ms)	0
Trigger Post-time (Default-queue)	Trailing time of the snapshot for the default-queue (in ms)	0
Trigger Pre-time (Stream-queue)*	Leading time of the snapshot for the stream-queue (in ms)	0
Trigger Post-time (Stream-queue)*	Trailing time of the snapshot for the stream-queue (in ms)	0
Log mode (Stream-queue)*	Snapshot recording mode for the stream-queue <i>Linear</i> : Ongoing <i>Loop</i> : In a loop that is overwritten as the specified size is reached	Linear
Loop size (Stream-queue)*	Factor determining the size of the loop (in MB, multiplied by a fixed predefined value)	3
Interval	Time range (in ms) during which multiple triggered snapshots are prevented Too many snapshots in very little time may lead to abnormal behavior of the ML-N4000	0

System Settings > Profile:

You can save different ML-N4000 configurations using profiles. The following names are reserved for special profiles:

- active the permanently saved configuration, which is loaded when the ML-N4000 starts
- default the factory default configuration
- customer-default a customer default configuration

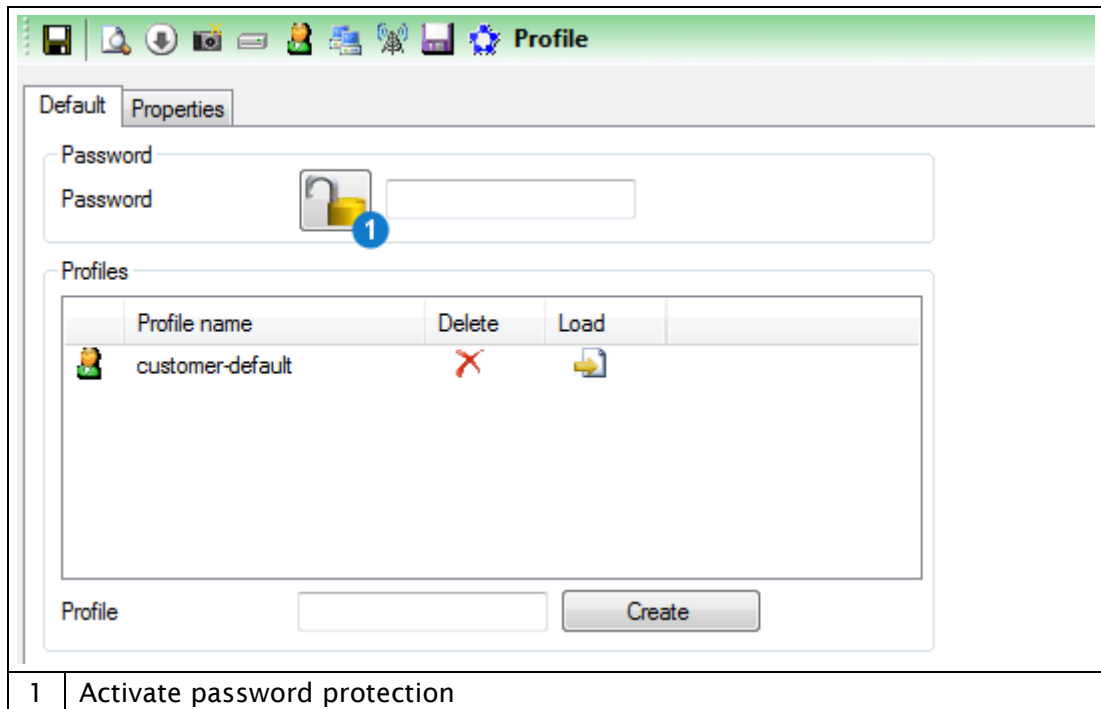

1 | Activate password protection

Create *customer-default* profile:

- ▶ Enter *customer-default* in the text box and click *Create*.
- or*
- ▶ In the *Logger* menu, click *Customer default configuration > Create*.

Load *customer-default* profile:

- ▶ Click *Load* in the row of the *customer-default* profile.
- or*
- ▶ In the *Logger* menu, click *Customer default configuration > Load*.
- or*
- ▶ Press the default button (**D**) for at least 1 second, but no more than 3 seconds. (→ Connections and controls)

Load *default* profile:

- ▶ Press the default button for at least 3 seconds.

Protect *active* profile:

- ▶ Enter a *Password*.
- ▶ Click *Activate password protection (1)*.
- ▶ In the main toolbar, click *Save changed configuration permanently*.
- ▶ Disconnect and reconnect again to the ML-N4000.

The *active* profile is protected:



With enabled password protection, you can still temporarily save settings and create profiles, without needing to enter the password.

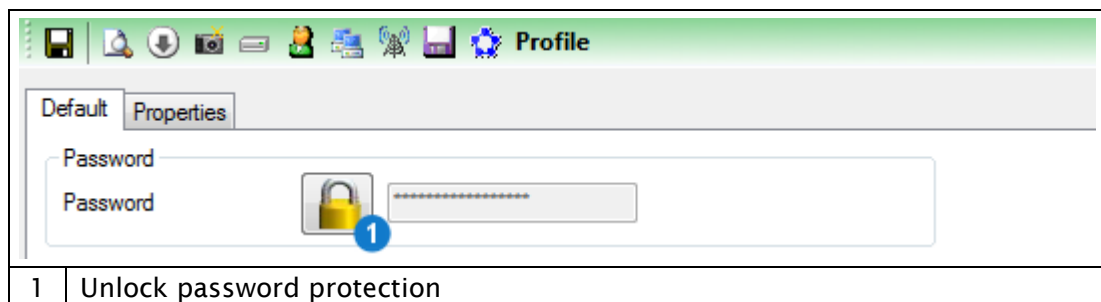

Unlock password protection for *active* profile:

- ▶ Click *Unlock password protection (1)*.
- ▶ In the newly opened window, enter the correct *Password*.
- ▶ Click *OK*.

The password protection is unlocked:



Reset password

If you have forgotten your password, you can reset the ML-N4000. (→ Resetting to factory defaults)

As you do so, the password as any other configuration changes will be reset.

System Settings > Export:

You can save the export settings and output formats for the *Hdd-Download* tool on the ML-N4000 itself. This way, the settings are centrally defined and do not depend on the PC used for downloading later.

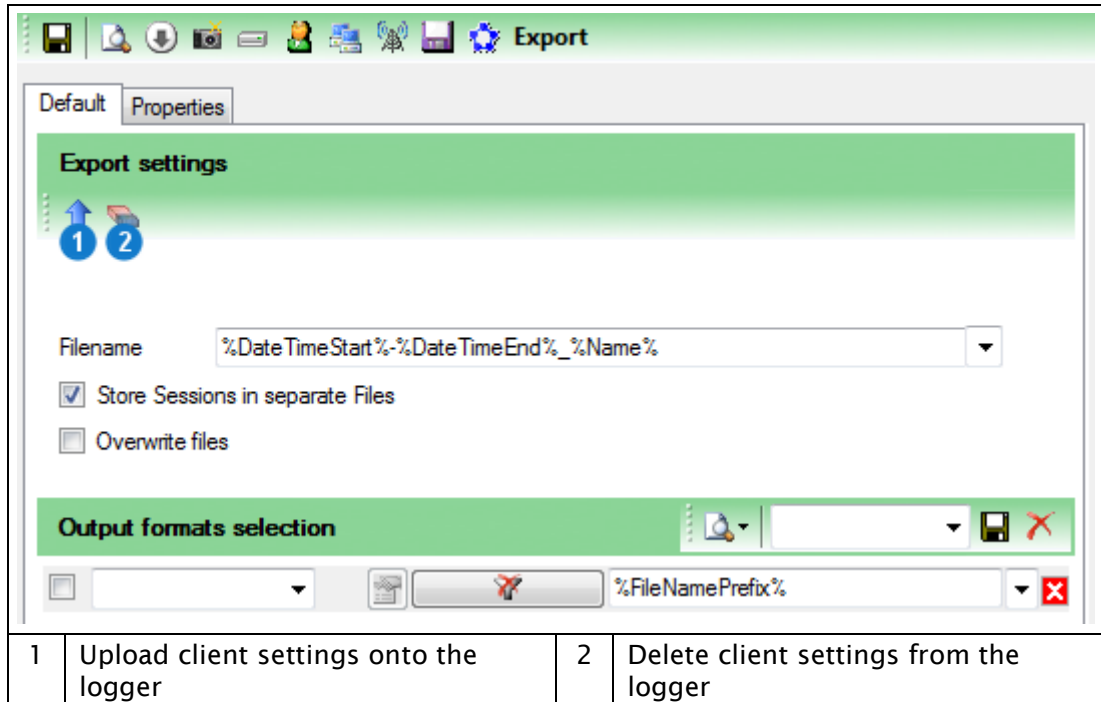

Save settings on the ML-N4000:

- ▶ Specify the export settings. (→ Export settings)
- ▶ Specify the output formats. (→ Output formats selection)
- ▶ Click *Upload client settings onto the logger* (1).
 - The settings are temporarily or permanently saved on the ML-N4000 and can be loaded in the *Hdd-Download* tool.

Reset settings:

- ▶ Click *Delete client settings from the logger* (2).

System Settings > DLN:

Set up a *Distributed Logging Network*, consisting of data sink (master) and one or multiple probes. For further information, see the quick manual for the XORAYA μ T-Z7 probe.

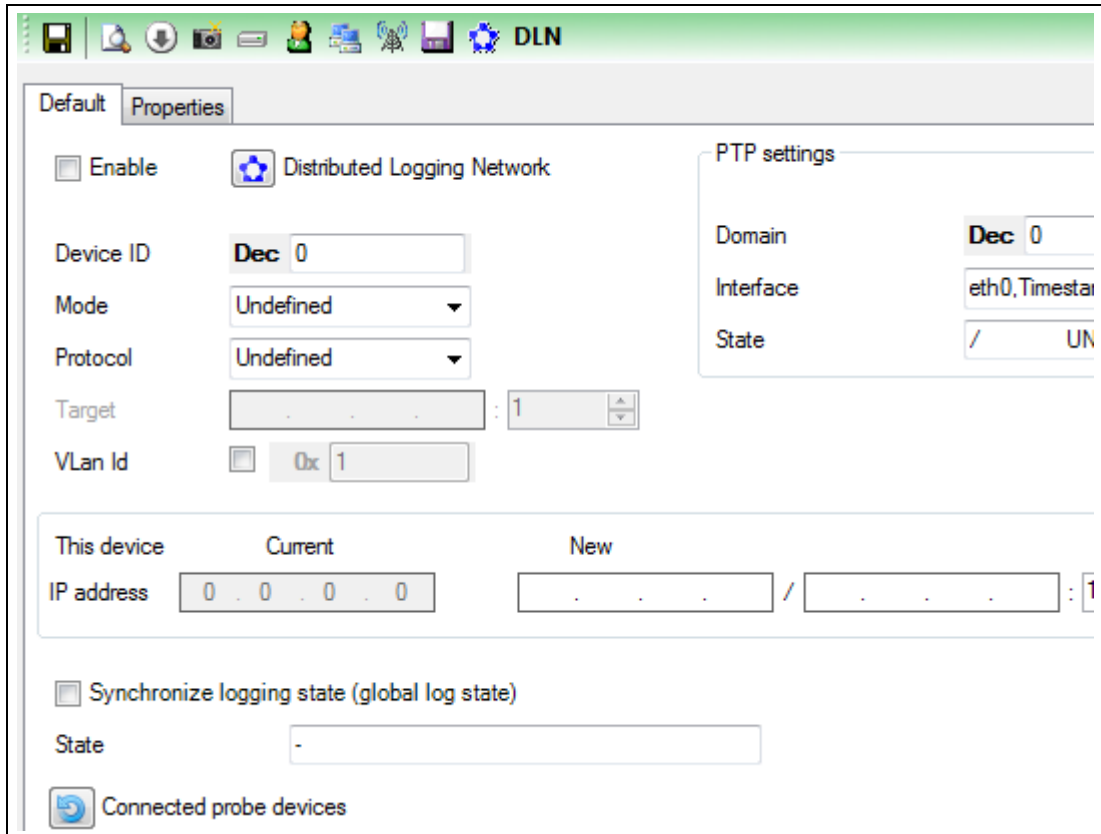

Default Properties

Enable Distributed Logging Network

Device ID

Mode

Protocol

Target :

Vlan Id

PTP settings

Domain

Interface

State

This device Current New / :

Synchronize logging state (global log state)

State

Connected probe devices

System Settings > Versions:

All properties in this category are immutable and purely informative. Among other things, this displays version numbers for various ML-N4000 components, as well as additionally activated licenses.

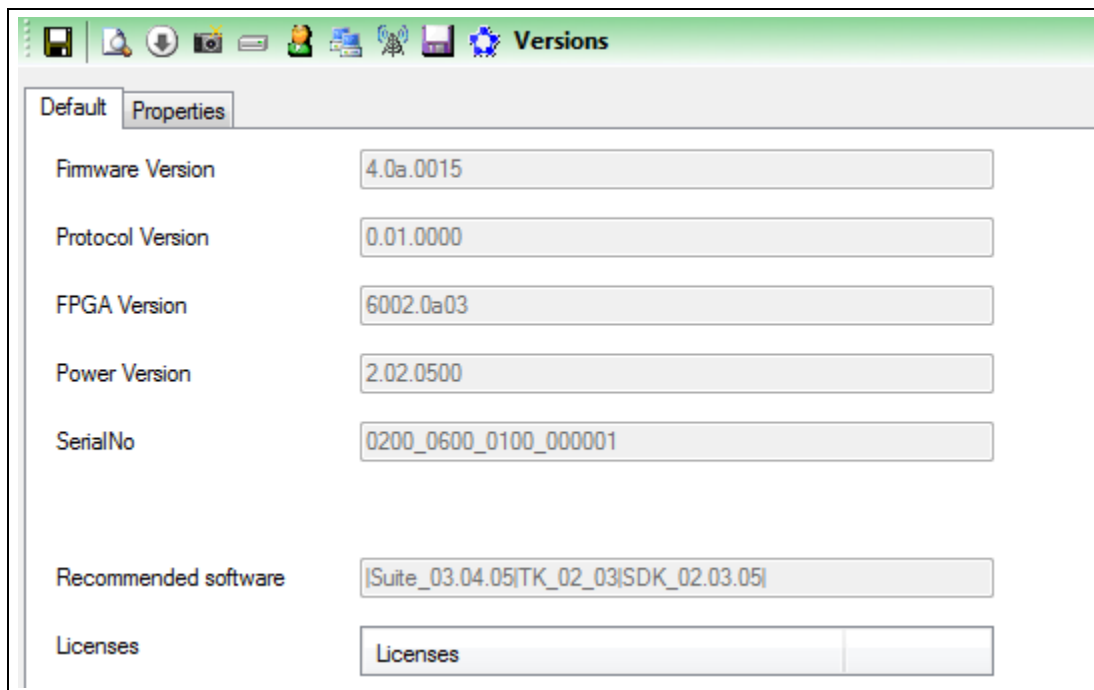

5.5.2 Interface configuration

Interface settings are configured via properties stored on the ML-N4000.

These properties fall under various categories:

- Settings
- Filter
- Trigger
- Routing
- Other
- Advanced

Interface or channel selection:

- ▶ Click the root element *Interfaces* to display the main settings of all interfaces.
or
- ▶ Click an interface to display the main settings for all channels of this interface.
or
- ▶ Click an interface channel to display the main settings for this channel.

Cross-references to the interfaces		
→ CAN	→ Analog	→ DiagXCP
→ FlexRay	→ Ethernet	→ Event
→ LIN	→ VIDEO	→ Button
→ RS-232	→ DiagCCP	

Interfaces:

Enable	Wake	Prevent Sleep	Acknowledge / Send	Channel	Instance	Alias	Bus-
<input type="checkbox"/>	<input type="checkbox"/>	<input type="checkbox"/>					
<input checked="" type="checkbox"/>	<input checked="" type="checkbox"/>	<input checked="" type="checkbox"/>	<input type="checkbox"/>	Can	1	can1	
<input checked="" type="checkbox"/>	<input checked="" type="checkbox"/>	<input checked="" type="checkbox"/>	<input type="checkbox"/>	Can	2	can2	
<input checked="" type="checkbox"/>	<input checked="" type="checkbox"/>	<input checked="" type="checkbox"/>	<input type="checkbox"/>	Can	3	can3	
<input checked="" type="checkbox"/>	<input checked="" type="checkbox"/>	<input checked="" type="checkbox"/>	<input type="checkbox"/>	Can	4	can4	
<input checked="" type="checkbox"/>		<input checked="" type="checkbox"/>		Ethernet	1	ethernet1	
<input checked="" type="checkbox"/>	<input checked="" type="checkbox"/>	<input checked="" type="checkbox"/>		RS232	1	rs232_1	
<input checked="" type="checkbox"/>	<input checked="" type="checkbox"/>	<input checked="" type="checkbox"/>		RS232	2	rs232_2	
<input checked="" type="checkbox"/>	<input checked="" type="checkbox"/>	<input checked="" type="checkbox"/>		RS232	3	rs232_3	
<input checked="" type="checkbox"/>	<input checked="" type="checkbox"/>	<input checked="" type="checkbox"/>		RS232	4	rs232_4	

- ▶ Double-click a row in the table to jump directly to the corresponding interface or to the corresponding channel.



Reducing power consumption of the ML-N4000

To reduce the ML-N4000 power consumption, disable all channels unneeded.

CAN:

The 4 channels of the CAN card with the lowest numbered slot are always FD-capable. By default, the FD-specific settings are missing on CAN channels belonging to other slots.



CANFD_4PLUS_#

For each of these licenses, the number of CAN-FD-capable channels is increased by 4.

Check in category *Versions* of system settings to verify which licenses are activated for your ML-N4000.
(→ Versions)

CAN > Settings:

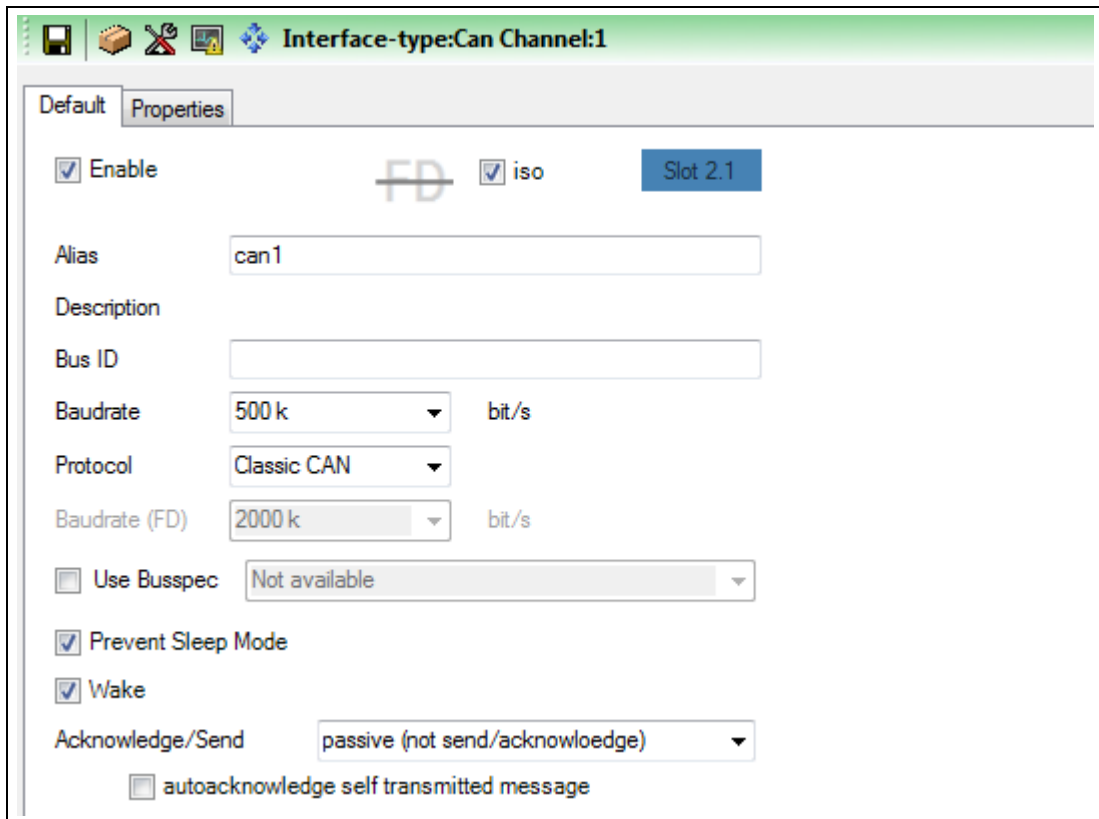

The screenshot shows the 'Interface-type:Can Channel:1' settings window. It has two tabs: 'Default' and 'Properties'. The 'Properties' tab is active. The settings are as follows:

- Enable
- iso
- Slot 2.1
- Alias: can1
- Description: (empty)
- Bus ID: (empty)
- Baudrate: 500 k bit/s
- Protocol: Classic CAN
- Baudrate (FD): 2000 k bit/s
- Use Busspec: Not available
- Prevent Sleep Mode
- Wake
- Acknowledge/Send: passive (not send/acknowledge)
- autoacknowledge self transmitted message

Setting	Description	Default
Enable	Turn on logging for this channel	On
iso	CAN FD standard <i>On:</i> ISO 11898-1 <i>Off:</i> original standard by Bosch	On
Alias	Freely selectable channel name	can#
Bus ID	Additional ID for subsequent evaluation	
Baudrate	Transfer rate (in bit/s) Values: 100 k, 125 k, 200 k, 250 k, 400 k, 500 k, 666 k, 800 k, 1000 k	500 k
Protocol	<i>Classic CAN</i> or <i>CAN-FD</i>	Classic CAN
Baudrate (FD)	Transfer rate for the payload section of a CAN FD message (in bit/s) Values: 500 k, 1000 k, 2000 k	2000 k
Use Busspec	Load configuration template provided by the vehicle manufacturer	Off
Prevent Sleep Mode	ML-N4000 will not go into sleep mode as long as there is activity on this channel	On
Wake	ML-N4000 wakes up from sleep mode as soon as there is activity on this channel	On
Acknowledge/ Send	Acknowledgment and transmission capacity <i>Send and acknowledge:</i> ML-N4000 operates in active mode on the CAN bus (transmission possible, acknowledgment of CAN messages, generation of error frames) <i>passive (not send/acknowledge):</i> ML-N4000 operates in passive mode on the CAN bus (receipt possible, no acknowledgment of CAN messages, no generation of error frames) <i>Send but NOT acknowledge:</i> ML-N4000 operates in semi-passive mode on the CAN bus (transmission possible, no acknowledgment of CAN messages, no generation of error frames)	passive (not send/ acknowledge)
autoacknowledge self transmitted message	Messages sent by the ML-N4000 are automatically acknowledged	Off

CAN > Trigger:

The screenshot shows the 'Properties' tab for 'Interface-type:Can Channel:1'. It contains five sections for enabling triggers from specific CAN messages. Each section includes a checkbox, an ID field (e.g., 0x1d6), and options for 'Extended frame', 'Can FD', and 'Bit Rate Switch'. To the right of each section is a bit field editor with a frame size dropdown (64) and bit positions 1-4. The bit fields are populated with hexadecimal values and their corresponding bit patterns. The last section is for 'Send as response following CAN message', with a 'Transmit' button and a grid of byte values (00).

1	Number of bytes for the trigger	3	Number of bytes for the response
2	8-byte blocks of the trigger	4	Byte values of the response

The following check boxes affect the IDs of the specified CAN messages in this category:

- Extended frame Use 29-bit ID instead of 11-bit ID
- Can FD Activate CAN FD mode
- Bit Rate Switch Transfer payload with CAN FD baudrate
(Requirement: *Can FD* selected)

Configure triggers:

- ▶ Select the check box *Enable Trigger from following CAN message*.
- ▶ Under *Id*, specify the ID of the CAN message that raises a trigger.
(→ Changing the numbering system)
- ▶ Select the check boxes *Extended Frame*, *Can FD* and *Bit Rate Switch* as desired.
- ▶ Specify the *Number of bytes for the trigger (1)*.
- ▶ Select one of the *8-byte blocks of the trigger (2)* for editing.
- ▶ Specify the bytes of this payload block. (→ Set bits)
- ▶ Specify further 8-byte blocks of this trigger.
- ▶ Repeat as necessary for up to a total of five triggers.

The following CAN messages are preconfigured as triggers:

ID	Byte 1	Byte 2 (X = "don't care")
1d6	C8	1X
1d6	C4	1X
1d6	F8	DX
1d6	F4	DX
7b7	00	XX

Configure trigger responses:

- ▶ Select the check box *Send as response following CAN message*.
- ▶ Specify the ID of the CAN message that is sent as response to a trigger.
- ▶ Select the check boxes *Extended Frame*, *Can FD* and *Bit Rate Switch* as desired.
- ▶ Specify the *Number of bytes for the response (3)*.
- ▶ Specify the *Byte values of the response (4)*.
- ▶ Repeat as necessary to configure a second trigger response.



CAN trigger responses

Trigger responses are only sent if the setting *Acknowledge/Send* is not set to *passive*.

To test the transmission of a CAN response, click the corresponding button.

CAN > Routing:

Here, you configure the routing of messages received on other CAN channels via the currently selected channel. The payload is not changed while the IDs of source and target message can differ.

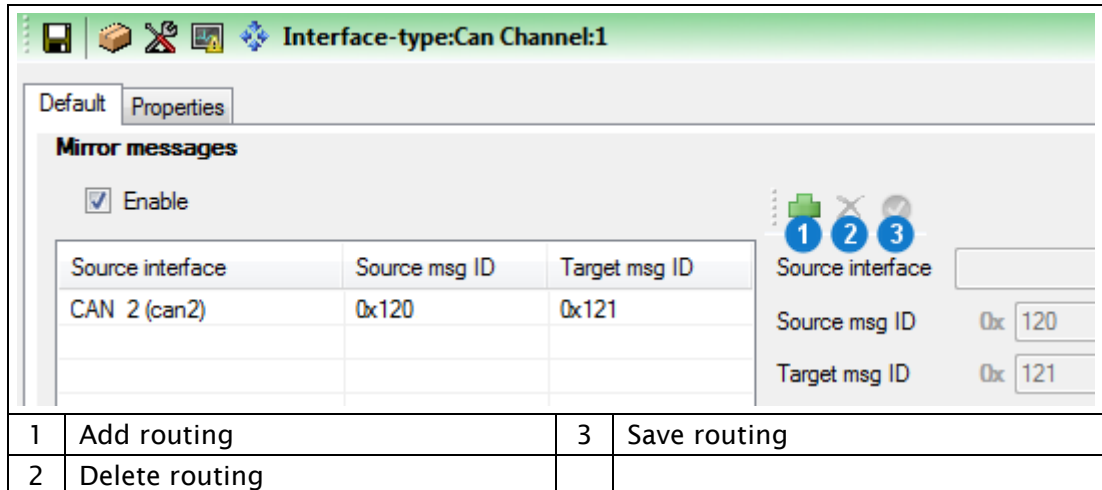

Configure routing:

- ▶ Select the check box *Enable*.
- ▶ Click *Add routing* (1).
- ▶ Under *Source interface*, choose the receiving CAN channel.
- ▶ Under *Source msg ID*, specify the ID of the source message.
(→ Changing the numbering system)
Select the check box *Ext. ID* for a 29-bit ID instead of a 11-bit ID.
- ▶ Optional: Under *Target msg ID*, specify content and length of the target message ID.
If you do not specify a target message ID, the source message ID is applied.
- ▶ Click *Save routing* (3).
- ▶ Repeat as necessary for further routings via this channel.

Meaning of the symbols for the available CAN channels:

- ✓ enabled
- ✗ not enabled

CAN > Other:

Here, you specify if the ML-N4000 sends general system statistics and interface statistics as CAN messages during data recording. These CAN messages contain signals, which hold the specific values.

General system statistics are, for example:

- RAM queue fill level
- CPU load
- Storage medium usage

Interface statistics:

- Transfer speed in kB/s
- Messages per second
- Overflow counter
- Error counter

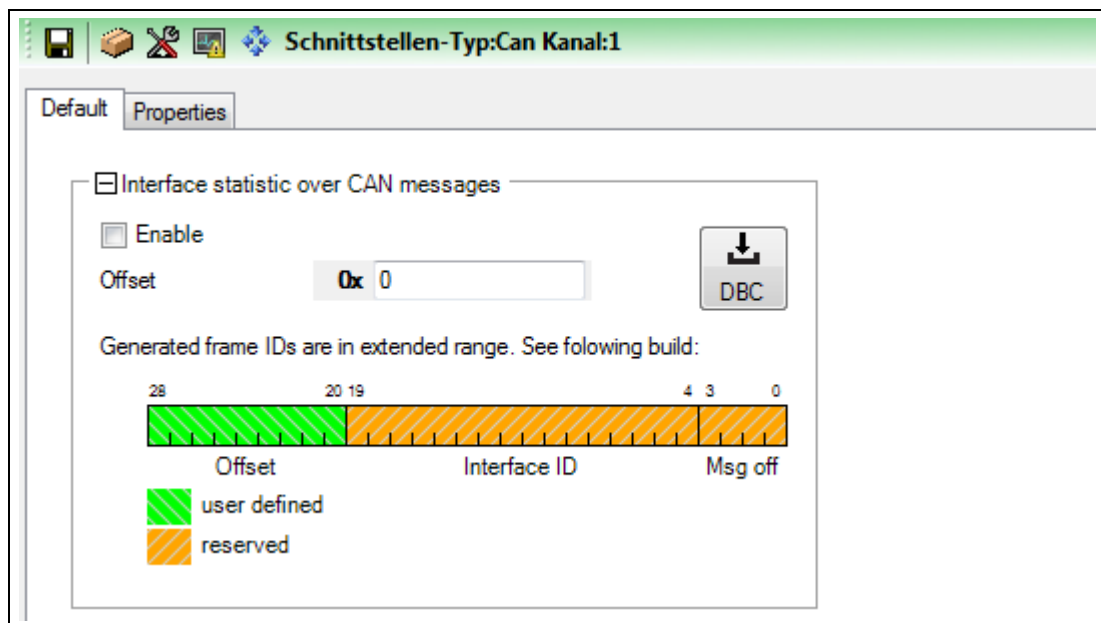

Setting	Description	Default
Enable	Enable interface statistic over CAN messages	Off
Offset	User-defined ID offset of the sent statistic messages	0

The user-defined *Offset* within the 29-bit ID is displayed in green. This offset applies to each generated ID. The rest of the ID in orange is reserved and is automatically adjusted for each interface channel by the software.

Click the *DBC* button to open the generated messages and signals as a DBC file in a text editor and to save them for later analysis.



Restriction of statistic over CAN

Statistic over CAN messages can only be activated on one CAN channel at the same time.

FlexRay:

FlexRay > Settings:

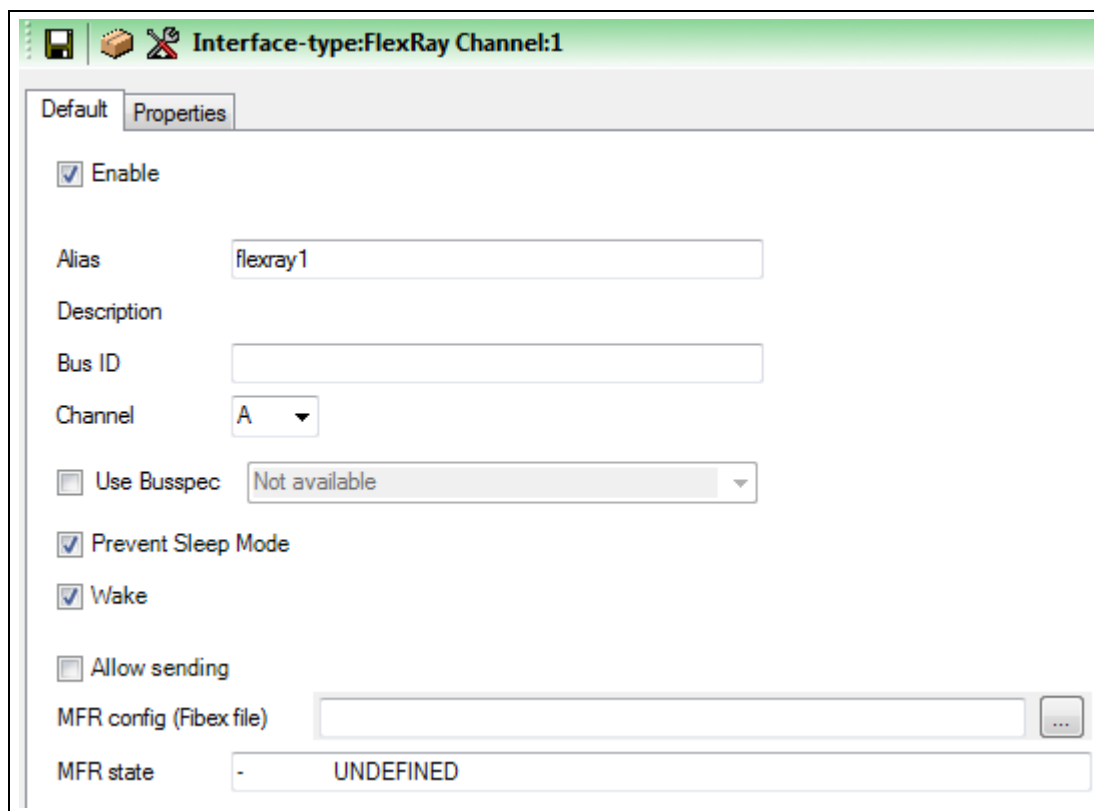

Setting	Description	Default
Enable	Turn on logging for this channel	On
Alias	Freely selectable channel name	flexray#
Bus ID	Additional ID for subsequent evaluation	
Channel	Selection, which one of both bus channels is used Values: A, B	A
Use Busspec	Load configuration template provided by the vehicle manufacturer	Off
Prevent Sleep Mode	ML-N4000 will not go into sleep mode as long as there is activity on this channel	On
Wake	ML-N4000 wakes up from sleep mode as soon as there is activity on this channel	On
Allow sending	Allow sending on this channel (requirement for XCP on FlexRay) Additionally, a FIBEX file is required	Off
MFR config (Fibex file)*	Path and name of the FIBEX file for the configuration of the FlexRay controller (MFR)	

* Only for channel 1

LIN:

LIN > Settings:

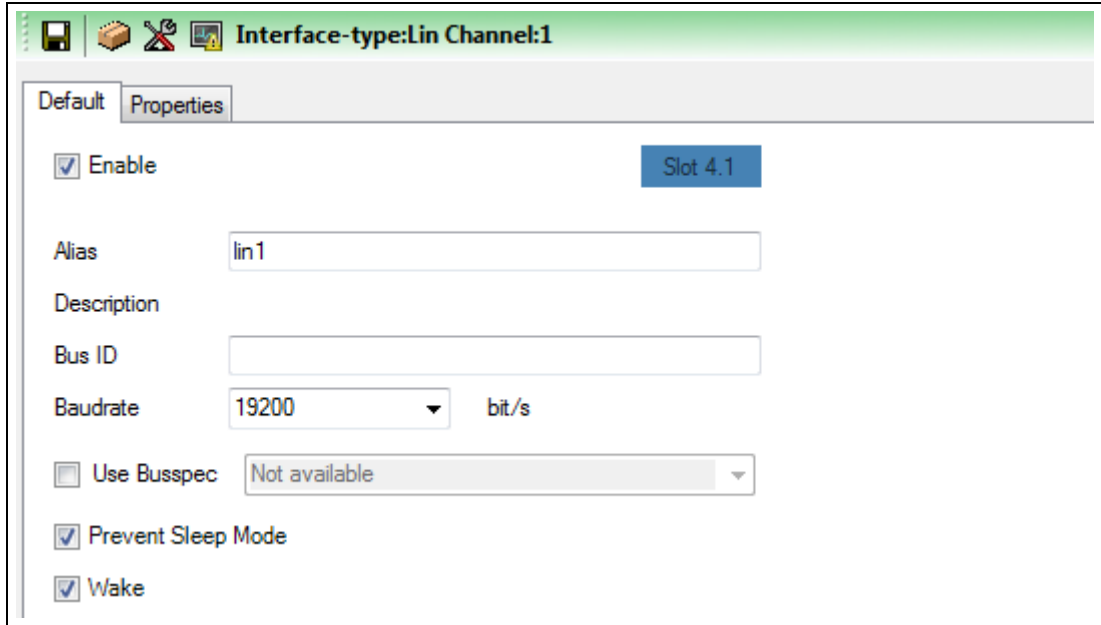

Setting	Description	Default
Enable	Turn on logging for this channel	On
Alias	Freely selectable channel name	lin#
Bus ID	Additional ID for subsequent evaluation	
Baudrate	Transfer rate (in bit/s) Values: 20000, 19200, 9600, 4800, 2400	19200
Use Busspec	Load configuration template provided by the vehicle manufacturer	Off
Prevent Sleep Mode	ML-N4000 will not go into sleep mode as long as there is activity on this channel	On
Wake	ML-N4000 wakes up from sleep mode as soon as there is activity on this channel	On

LIN > Trigger:

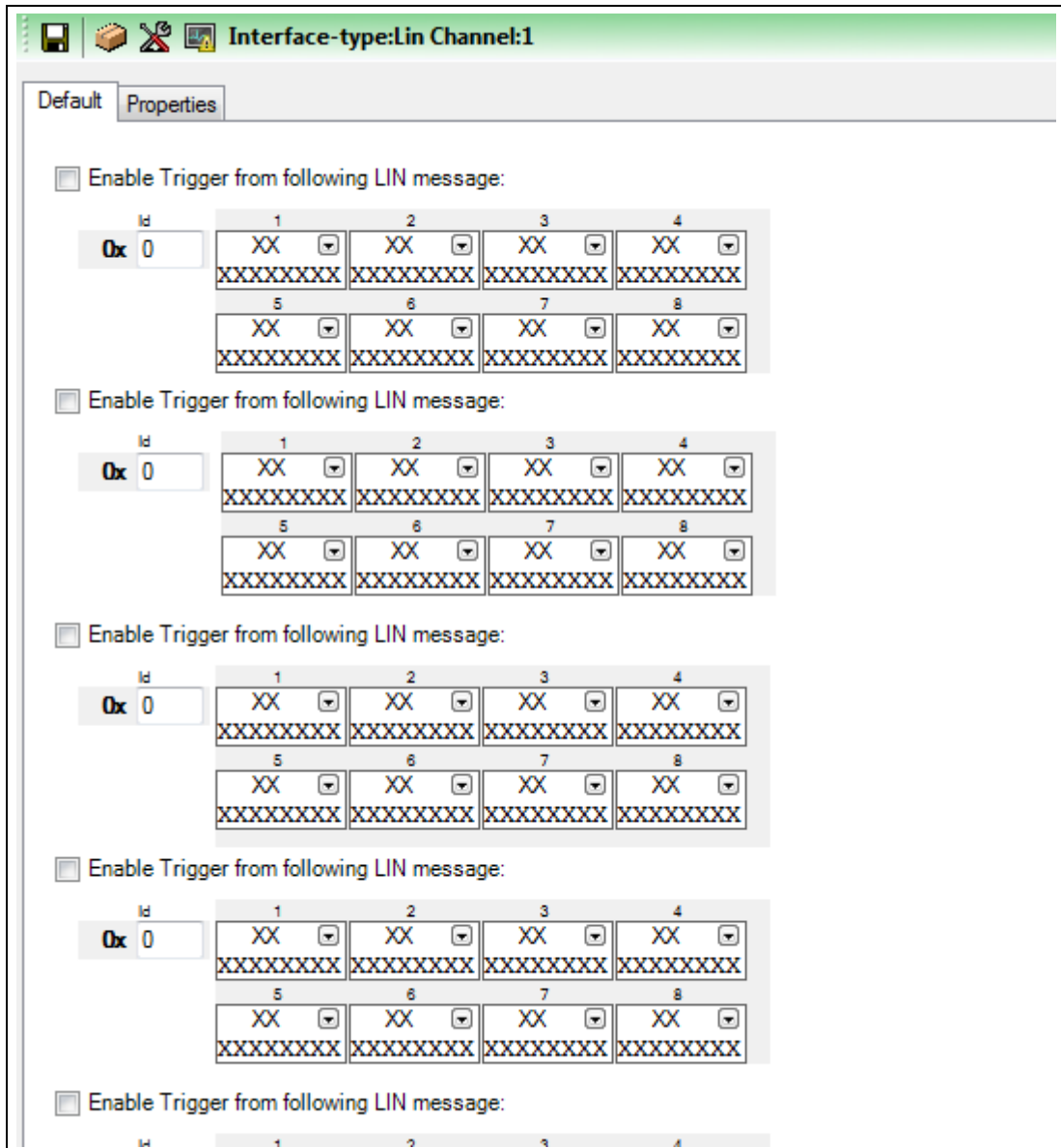

Configure triggers:

- ▶ Select the check box *Enable Trigger from following LIN message*.
- ▶ Under *Id*, specify the ID of the LIN message that raises a trigger. (→ Changing the numbering system)
- ▶ Specify the payload bytes from 1 to 8. (→ Set bits)
- ▶ Repeat as necessary for up to a total of five triggers.



No trigger response

Because of the missing transmission capability, there are no trigger responses available for the LIN interface.

RS-232:

Interface-type:RS232 Channel:1

Default Properties

Protocol

Raw GNLog DLT

Enable Slot 1.1

Alias

Description

Bus ID

Use Busspec

Baudrate

Bits

Parity

Stopbits

Message Delimiter

Max packet size Bytes

RX Timeout ms

Prevent Sleep Mode

Wake

Setting	Description	Default
Protocol	<i>Raw, GNLog or DLT</i>	Raw
Enable	Turn on logging for this channel	On
Alias	Freely selectable channel name	rs232_# or gnlog# or DLT#
Bus ID	Additional ID for subsequent evaluation	
Use Busspec	Load configuration template provided by the vehicle manufacturer	Off
Debug level**	Detail level of the debug information GNLog: 0 to 3 (max) DLT: 0 (None) to 6 (Verbose)	GNLog: 2 DLT: 0 (None)
Trace state***	Send trace messages	Off
Verbose mode***	<i>Off</i> : Send only dynamic data <i>On</i> : Send dynamic and static data	Off
Baudrate	Transfer rate (in bit/s) Values: 4800, 9600, 19200, 38400, 57600, 115200, 230400	115200
Bits	Number of data bits of a data block Values: 5 bit, 6 bit, 7 bit, 8 bit	8 bit
Parity	Parity check for error detection Values: None, Odd, Even	None
Stopbits	Number of stop bits that mark the end of a data block Values: 1 bit, 2 bit	1 bit
keep low level data stream**	Underlying RS-232 data are saved	Off
Message Delimiter*	Delimiter that marks the end of a message Values: LF(10/0x0A) = end of line, None	LF(10/0x0A)
Max packet size*	Maximum packet size (in Bytes)	1000
RX Timeout*	If no new character is received during this period (in ms), then the previously received data are interpreted as completed message <i>0</i> : Function disabled	250
Prevent Sleep Mode	ML-N4000 will not go into sleep mode as long as there is activity on this channel	On
Wake*	ML-N4000 wakes up from sleep mode as soon as there is activity on this channel	On

* Only for Raw **Only for GNLog and DLT ***Only for DLT

Analog:

Analog > Common Settings:

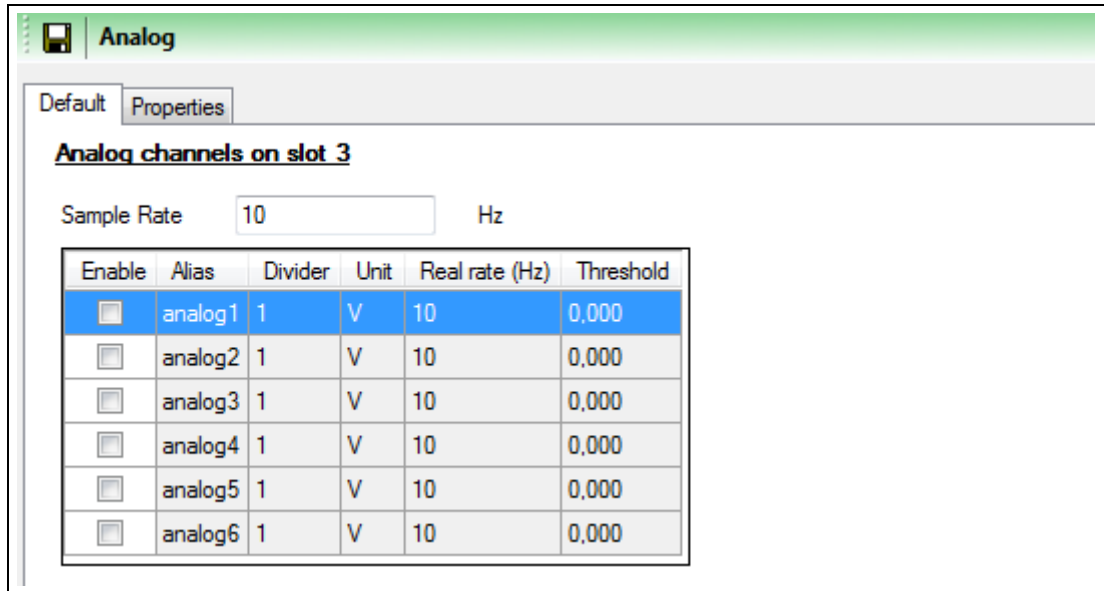

Setting	Description	Default
Sample Rate	Samples per second Applies to all channels of the interface	10
Enable	Turn on logging for this channel	Off

Analog > Settings:

Setting	Description	Default
Enable	Turn on logging for this channel	Off
Alias	Freely selectable channel name	analog#
Bus ID	Additional ID for subsequent evaluation	
Use Busspec	Load configuration template provided by the vehicle manufacturer	Off
for CAN bus	Configuration template for the CAN bus Analog data are converted to CAN for further processing by CARMEN	
Sample Rate	Samples per second Applies to all channels of the interface Button <i>Edit !</i> opens the common settings	10
Divider	Divisor of the sampling rate Applies separately for each channel	1
Threshold	Threshold of voltage change needed to initiate data logging <i>0</i> : Continuous logging at each sampling time	0

Ethernet:

For XORAYA ML-N4000 with BroadR-Reach/Base-T1 switch, there are additional settings available here.

Ethernet > Settings:

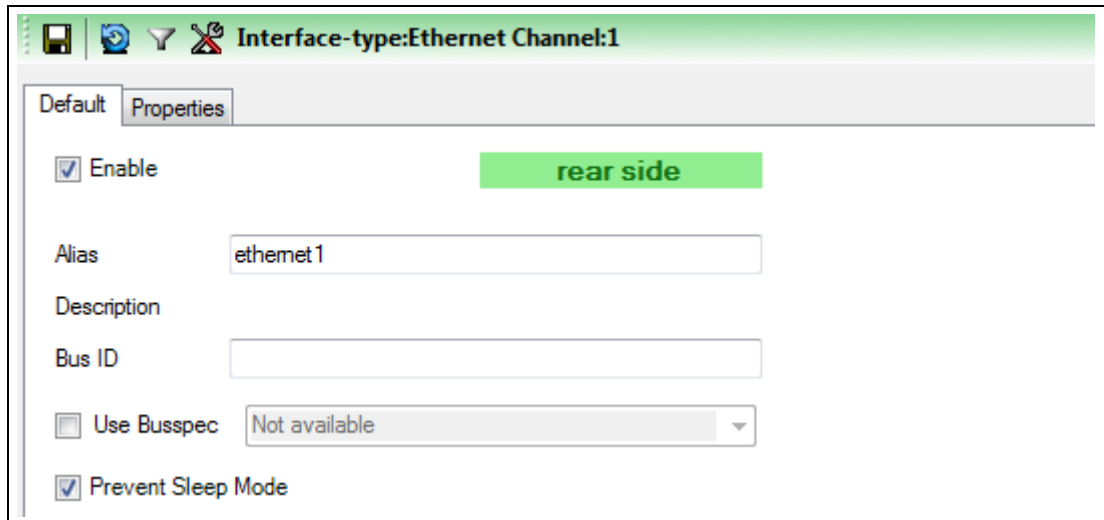

Setting	Description	Default
Enable	Turn on logging for this channel	On
Alias	Freely selectable channel name	ethernet#
Bus ID	Additional ID for subsequent evaluation	
Use Busspec	Load configuration template provided by the vehicle manufacturer	Off
Prevent Sleep Mode	ML-N4000 will not go into sleep mode as long as there is activity on this channel	On

BroadR-Reach/Base-T1 switch:

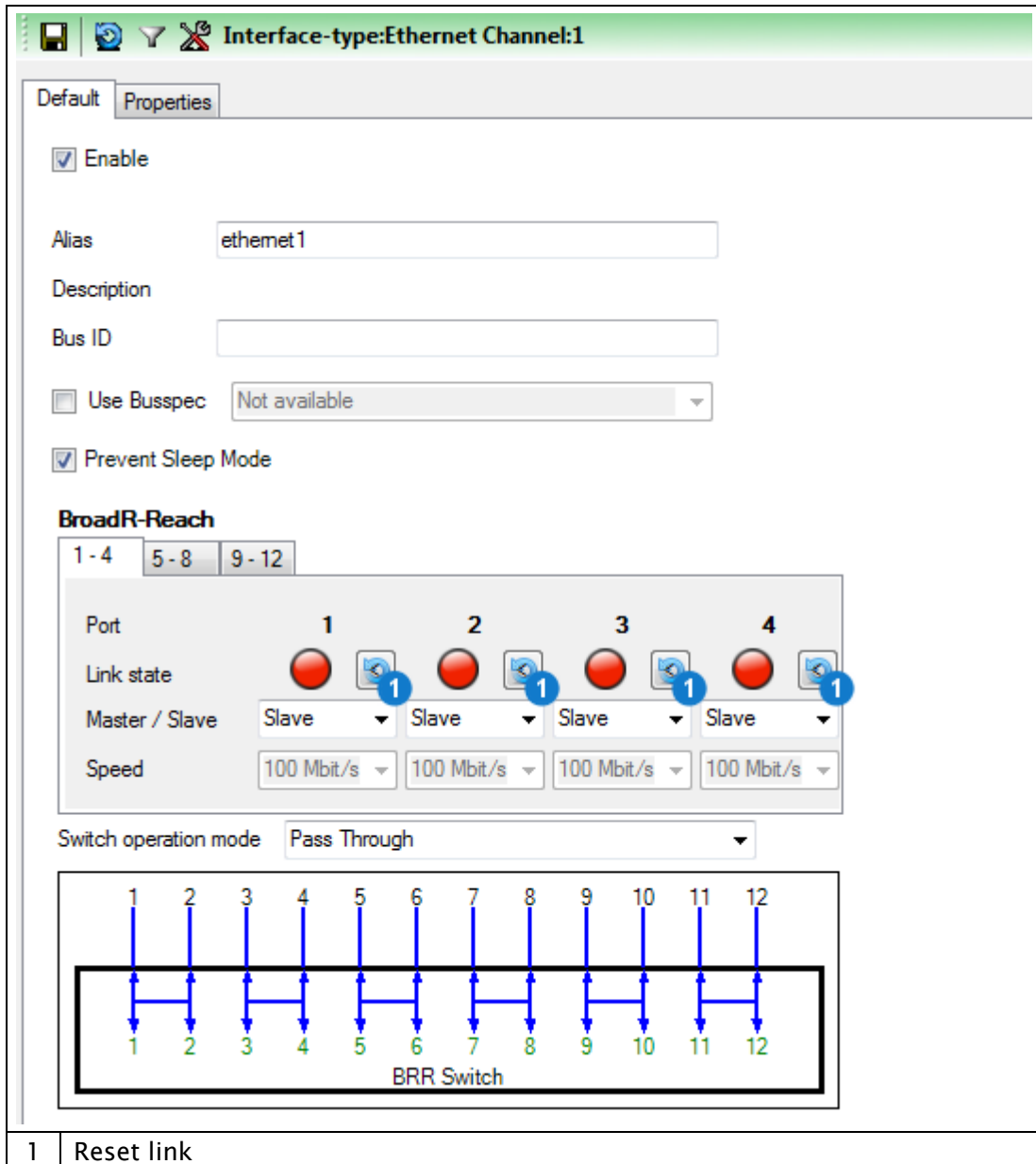

1 | Reset link

The *Link state* of each port is represented as a red or green traffic light. Click (1) to reset the link.

In *Data Sink* switch operation mode, the data are only recorded.

In *Pass Through* mode, the BroadR-Reach ports are combined as pairs to allow a bus connection between ECU and BroadR-Reach component, for example a camera. Configure the paired ports of the BroadR-Reach switch alternately to master and slave so that the data are routed in both directions. The data are also recorded.

A VLAN-ID is assigned to each port. During data recording, this ID is inserted into the Ethernet frame as the outer VLAN tag, so the measurement contains information on which port the data were received. You can change the VLAN-ID for each port separately via the property *brr_vlan_outer_vid#* in the category *other*.

Setting	Description	Default
Master / Slave	Mode of the BroadR-Reach port	Slave
Switch operation mode	Operation modes of the BroadR-Reach switch <i>Pass Through</i> : Data recording and forwarding between port pairs <i>Data Sink</i> : Only data recording <i>Pass Through / Data Sink (Allow single tagged VLAN)</i> : Additional modes to enable DLT tracing via Ethernet	Pass Through

Ethernet > Filter:

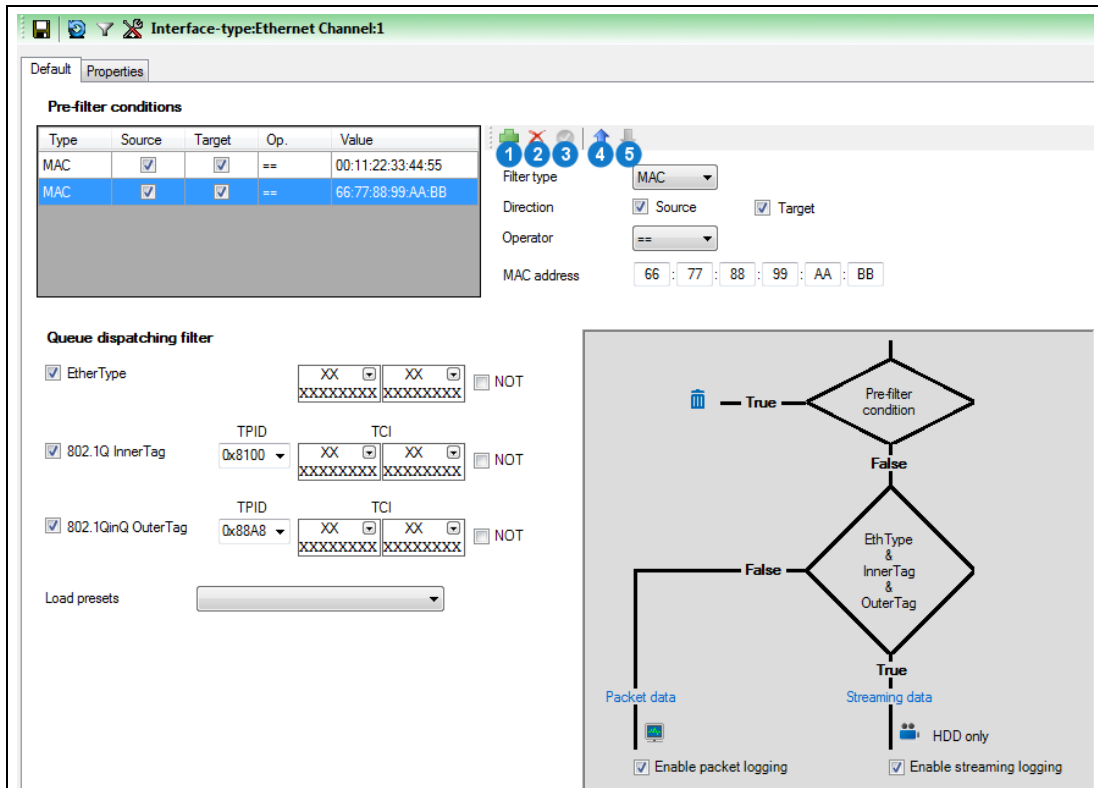

Type	Source	Target	Op.	Value
MAC	<input checked="" type="checkbox"/>	<input checked="" type="checkbox"/>	==	00:11:22:33:44:55
MAC	<input checked="" type="checkbox"/>	<input checked="" type="checkbox"/>	==	66:77:88:99:AA:BB

1	Add pre-filter	4	Increase pre-filter priority
2	Delete pre-filter	5	Decrease pre-filter priority
3	Save pre-filter		

The filter is executed in two successive steps:

- Pre-filter MAC address
- Queue dispatching filter EtherType and VLAN

Configure pre-filters:

- ▶ Click *Add pre-filter* (1).
- ▶ Choose the *Filter type* (only MAC is available at the current development stage).
- ▶ Under *Direction*, choose if the filter applies to a participant who is *Source* and/or *Target*.
- ▶ Under *Operator*, choose if the filter is added to the whitelist (==) or the blacklist (!=).
- ▶ Specify the *MAC address*.
- ▶ Click *Save pre-filter* (3).
- ▶ Repeat as necessary for further pre-filters.



Priorities of pre-filters

Change the priorities of the pre-filters with the buttons (4) and (5).

The XORAYASuite applies the first pre-filter from the top that matches the condition. The other pre-filters are ignored.

The ML-N4000 processes packet data in Online mode and HDD mode via the so-called default-queue. In the stream-queue, only HDD mode recording is possible, and streaming data are directly stored without creating statistics.

The queue dispatching filter compares *EtherType* and both VLAN tags (*InnerTag*, *OuterTag*) of received Ethernet frames with the bytes specified here. (→ Set bits)

If all selected filter conditions are matched, the Ethernet frame is assigned to the streaming data, otherwise to the packet data. If the Ethernet frame contains no or only one VLAN tag, the filter conditions for the non-existing fields are ignored.

Via *Load presets*, you can configure filter conditions in such way that either all frames are assigned to streaming data (*Streaming logging only*) or all frames to packet data (*Packet logging only*).

Setting	Description	Default
EtherType	Expected result of the check on the EtherType field if matching	0x0
TPID (InnerTag)	Tag protocol identifier of the inner VLAN tag for Ethernet frames (always 0x8100)	0x8100
TCI (InnerTag)	Expected result of the check on the inner VLAN tag if matching	0x0
TPID (OuterTag)	Tag protocol identifier of the outer VLAN tag for Ethernet frames Values: 0x88A8, 0x9100, 0x9200, 0x9300	0x88A8
TCI (OuterTag)	Expected result of the check on the outer VLAN tag if matching	0x0
NOT	Invert filter condition	Off
Enable packet logging	Record filtered packet data	On
Enable streaming logging	Record filtered streaming data	On

Ethernet protocols:

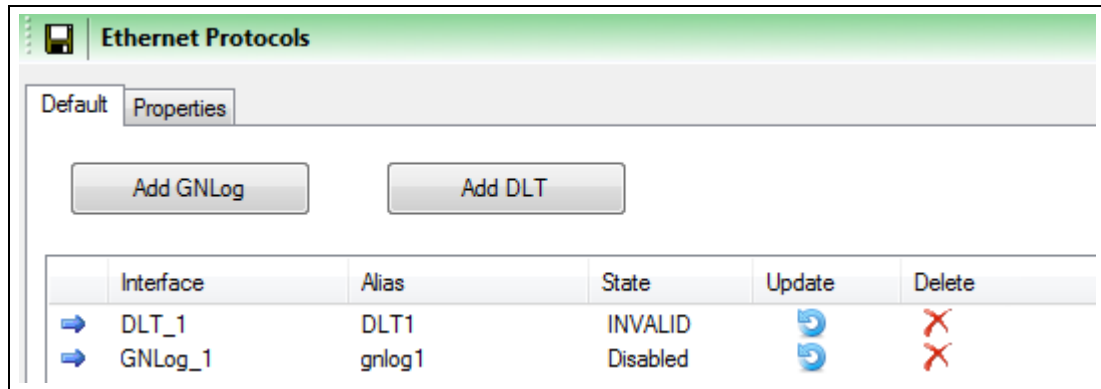

In this configuration section, you can add, update and delete GNLog and DLT channels. Both protocols are recorded via the LAN host ports or the BroadR-Reach interface.

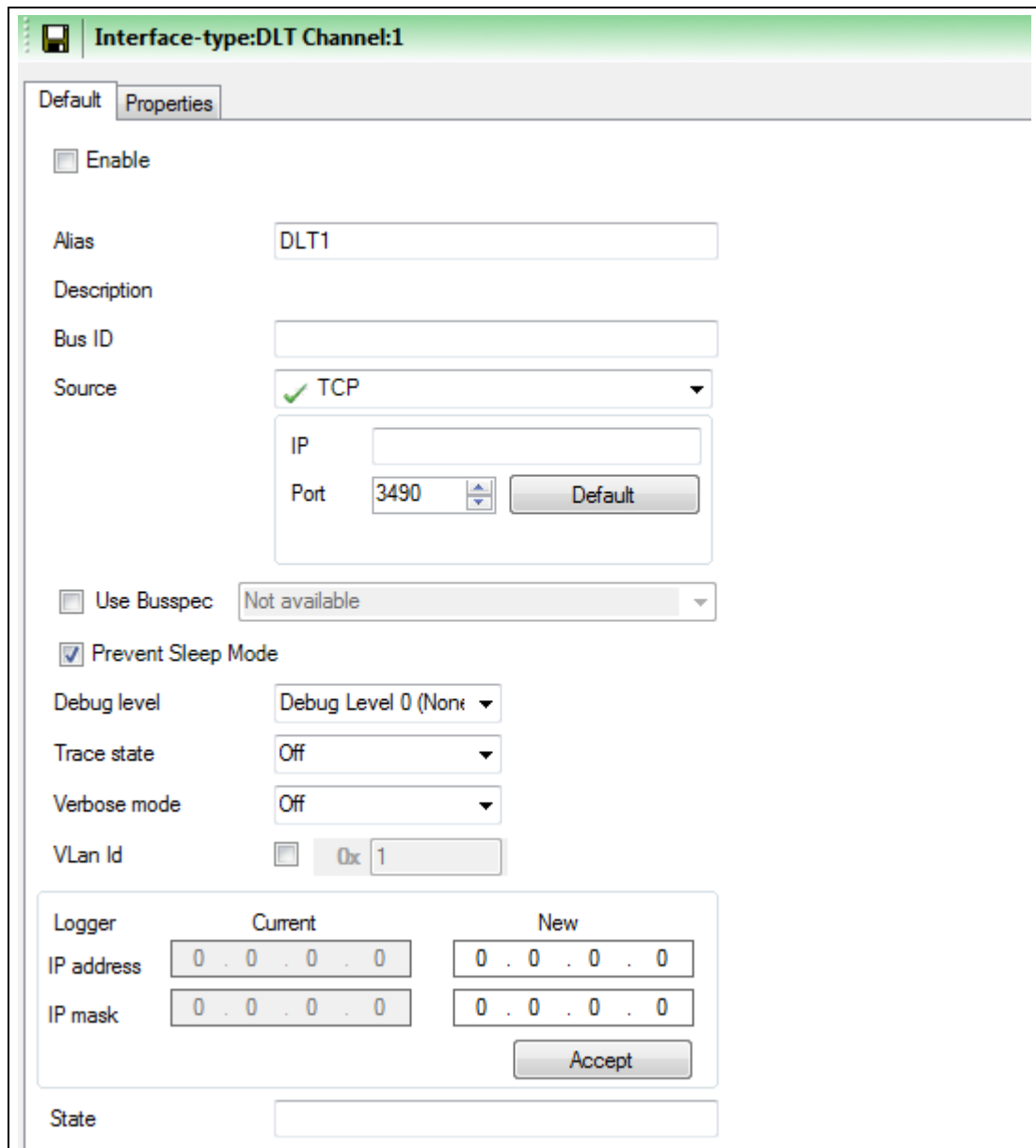

Setting	Description	Default
Enable	Turn on logging for this channel	Off
Alias	Freely selectable channel name	gnlog# or DLT#
Bus ID	Additional ID for subsequent evaluation	
Source	TCP (GNLog, DLT) or UDP (only DLT) IP address and port of the ECU <i>Default</i> sets the port to 851 (GNLog) or 3490 (DLT)	
Use Busspec	Load configuration template provided by the vehicle manufacturer	Off
Prevent Sleep Mode	ML-N4000 will not go into sleep mode as long as there is activity on this channel	On
Debug level	Detail level of the debug information GNLog: 0 to 3 (max) DLT: 0 (None) to 6 (Verbose)	GNLog: 2 DLT: 0 (None)
Trace state*	Send trace messages	Off
Verbose mode*	<i>Off</i> : Send only dynamic data <i>On</i> : Send dynamic and static data	Off
VLAN Id	Check box activates VLAN ID according to IEEE 802.1Q Values: 1 to 4095	1
IP address	IP address which the ML-N4000 uses in the communication with the ECU	0.0.0.0
IP mask	Network mask which the ML-N4000 uses in the communication with the ECU	0.0.0.0

* Only for DLT

VIDEO:

Connect camera:

- ▶ Connect the camera to one of the Ethernet log interfaces **(M)**.
(→ Connections and controls)
- ▶ Connect another Ethernet log interface **(M)** to one of the LAN host ports **(H)**.
- ▶ Connect another LAN host port **(H)** to the PC.

Control video recordings:

- ▶ Create one or multiple signal-based triggers of the VIDEO interface.
or
- ▶ Activate one or multiple trigger actions of the button interface that effect the video recording. (→ Button)



INTERFACE_NET_CAMERA

This license is required for video recordings.

Check in category *Versions* of system settings to verify which licenses are activated for your ML-N4000.
(→ Versions)

VIDEO > Settings:

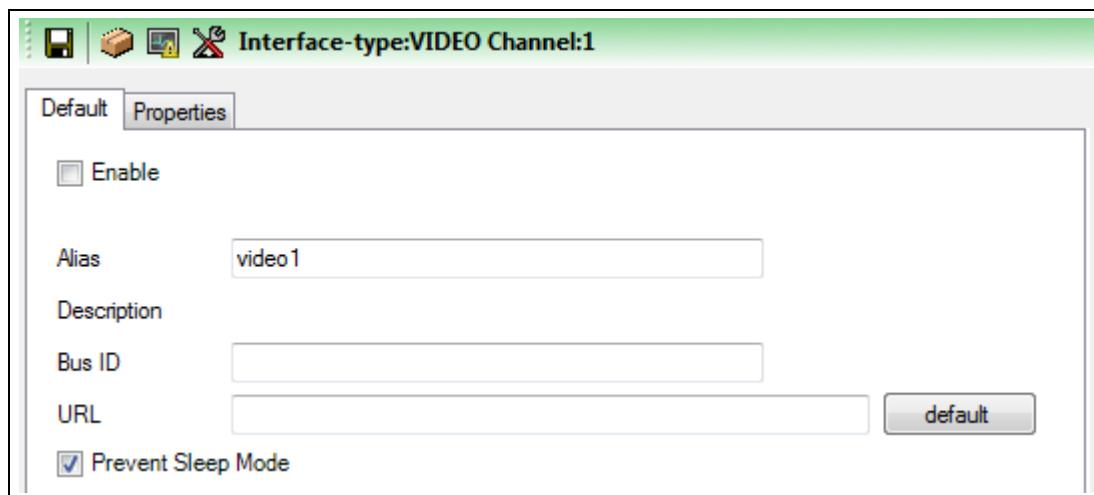

Setting	Description	Default
Enable	Turn on logging for this channel	Off
Alias	Freely selectable channel name	video#
Bus ID	Text box <i>Bus ID</i> Additional ID for subsequent evaluation	
URL	To control an IP camera <i>default</i> enters the sample configuration of a Basler camera	
Prevent Sleep Mode	ML-N4000 will not go into sleep mode as long as there is activity on this channel	On

VIDEO > Trigger:

1	Add trigger	4	Delete trigger
2	Trigger type	5	Move trigger up
3	Edit trigger	6	Move trigger down

Here, you create conditions that trigger the following pre-defined actions:

- Create replay (the video stream currently stored in the circular buffer is saved permanently)
- Take screenshot
- Start Stream
- Stop Stream

Configure triggers:

- ▶ On the header of the desired trigger action, click *Add trigger* **(1)**.
- ▶ Select the desired *Trigger type* **(2)**.
- ▶ Create a single condition or multiple combined conditions for this trigger. (→ Create trigger conditions)
- ▶ If required, repeat the above steps for further triggers.



Number of configurable triggers

You can configure a maximum of ten triggers per VIDEO interface channel.

DiagCCP:

DiagCCP > Settings:

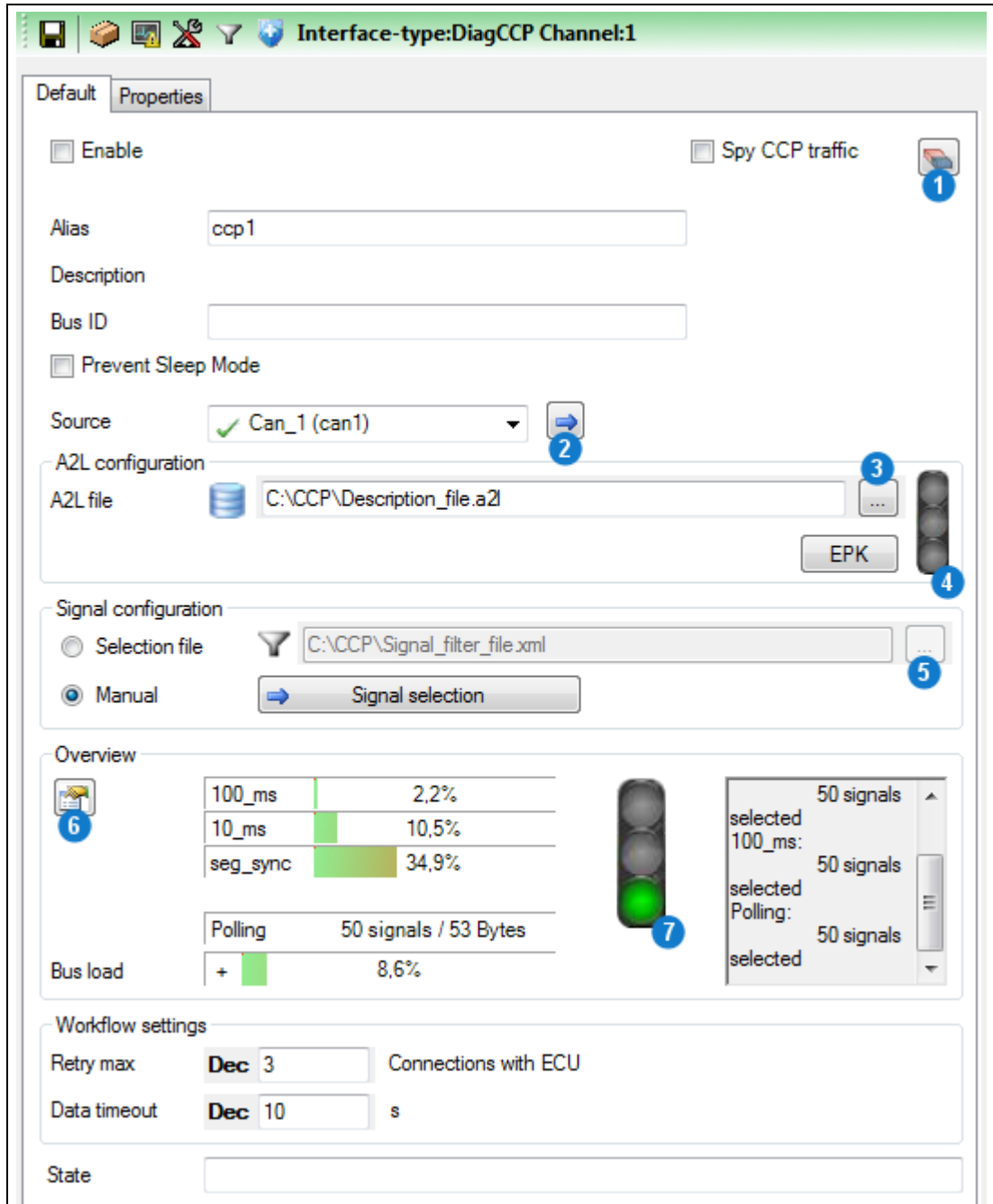

1	Clear all settings	5	Open selection file
2	Edit CAN interface channel	6	Settings
3	Open A2L file	7	Traffic light for the bus load
4	Traffic light for the EPK check		



PROTOCOL_CCP
PROTOCOL_CCP_SPY





The available modes (Master, Spy) depend on the activation of these licenses.

Check in category *Versions* of system settings to verify which licenses are activated for your ML-N4000.

(→ Versions)

Setting	Description	Default
Enable	Turn on logging for this channel	Off
Spy CCP traffic	CCP mode <i>On</i> : Spy (external communication is monitored, no sending) <i>Off</i> : Master	Off
Alias	Freely selectable channel name	ccp#
Bus ID	Additional ID for subsequent evaluation	
Prevent Sleep Mode	ML-N4000 will not go into sleep mode as long as there is activity on this channel	Off
Source	Physical CAN channel to be used	Can_1 (can1)
A2L file	Description file, which is suitable for the ECU and is loaded to configure the CCP connection	
Selection file	Signal filter file (XML, CFG or LAB), which contains a (pre-)selection of the signals to be monitored	
Retry max	Maximum number of retries after unsuccessful connection attempt	3
Data timeout	No data received for this period of time (in s) leads to an error	10

Meaning of the symbols for the physical CAN channels:

-  transmission-capable
-  transmission-capable, but currently set to passive
-  not transmission-capable
-  not enabled

Via *Edit CAN interface channel (2)* button, you can enable it, activate its transmission capability or change its baudrate if necessary.

A2L configuration:

- ▶ Click *Open A2L file (3)* and select the description file that corresponds with the ECU.
 - The XORAYASuite reads the A2L file and configures the CCP connection accordingly.
 - If *Overwrite alias with ECU name* under *Settings (6)* is activated, *Alias* is also changed.
 - If supported by the A2L file, the XORAYASuite automatically runs an EPK version check with the ECU and displays the result via the *Traffic light for the EPK check (4)*.
- You can also execute this check manually via the *EPK* button.

Levels of the *Traffic light for the EPK check (4)*:

- green check successful
- yellow check not possible
- red check not successful

Signal configuration:

- ▶ Click *Open selection file (5)* and select a suitable XML, CFG or LAB file.
or
- ▶ Click *Signal selection* and select the signals manually. (→ Filter)
- The XORAYASuite calculates the expected percentage of the bus load increase.
The result evaluation is displayed via the *Traffic light for the bus load (7)*.

Configure the levels of the *Traffic light for the bus load (7)*:

- ▶ Right-click on the traffic light and then on *Edit traffic light settings for this interface type*.
- ▶ Specify the percentage limit between green and yellow (standard: 50).
- ▶ Specify the percentage limit between yellow and red (standard: 80).
- ▶ Click *OK*.

DiagCCP > Filter:

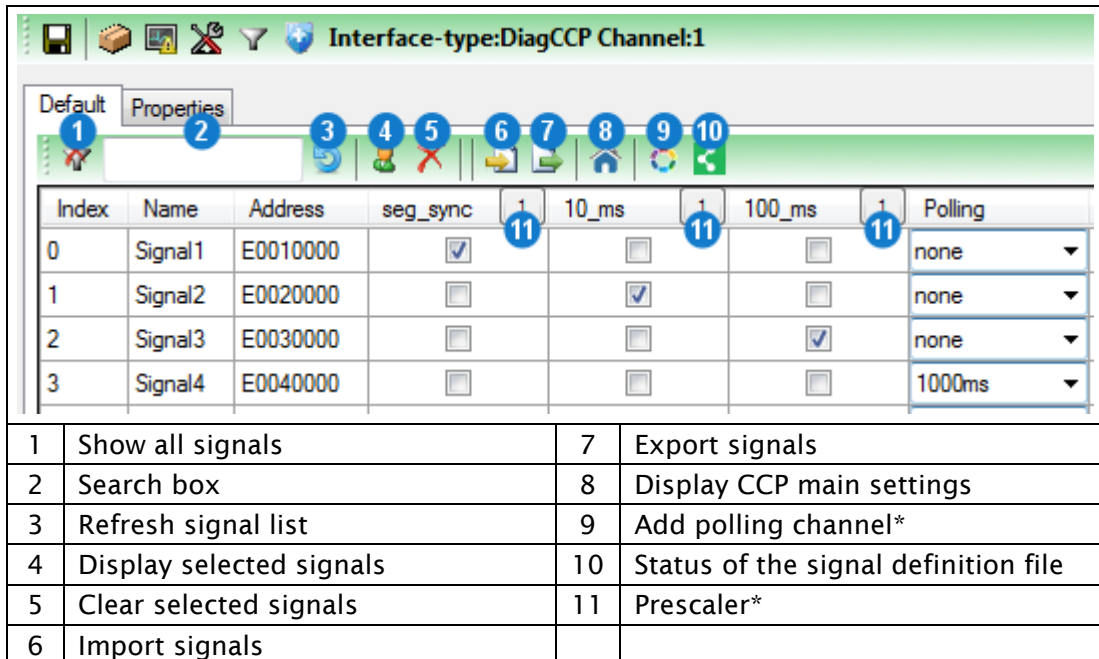

The screenshot shows the 'DiagCCP Channel:1' interface. At the top, there are icons for file operations (1-10) and a search box (2). Below the icons is a table with columns: Index, Name, Address, seg_sync, 10_ms, 100_ms, and Polling. The table contains four rows of signal data. Below the table is a legend with two columns of numbered items (1-11) corresponding to the icons in the interface.

Index	Name	Address	seg_sync	10_ms	100_ms	11	11	11	11	11	11	11	11
0	Signal1	E0010000	<input checked="" type="checkbox"/>	<input type="checkbox"/>	<input type="checkbox"/>	<input type="checkbox"/>	<input type="checkbox"/>	<input type="checkbox"/>	<input type="checkbox"/>	<input type="checkbox"/>	<input type="checkbox"/>	<input type="checkbox"/>	none
1	Signal2	E0020000	<input type="checkbox"/>	<input checked="" type="checkbox"/>	<input type="checkbox"/>	<input type="checkbox"/>	<input type="checkbox"/>	<input type="checkbox"/>	<input type="checkbox"/>	<input type="checkbox"/>	<input type="checkbox"/>	<input type="checkbox"/>	none
2	Signal3	E0030000	<input type="checkbox"/>	<input type="checkbox"/>	<input checked="" type="checkbox"/>	<input type="checkbox"/>	<input type="checkbox"/>	<input type="checkbox"/>	<input type="checkbox"/>	<input type="checkbox"/>	<input type="checkbox"/>	<input type="checkbox"/>	none
3	Signal4	E0040000	<input type="checkbox"/>	<input type="checkbox"/>	<input type="checkbox"/>	<input type="checkbox"/>	<input type="checkbox"/>	<input type="checkbox"/>	<input type="checkbox"/>	<input type="checkbox"/>	<input type="checkbox"/>	<input type="checkbox"/>	1000ms

1	Show all signals	7	Export signals
2	Search box	8	Display CCP main settings
3	Refresh signal list	9	Add polling channel*
4	Display selected signals	10	Status of the signal definition file
5	Clear selected signals	11	Prescaler*
6	Import signals		

* Only if supported by the A2L file

Select signals for the DAQ measurement mode:

- ▶ Select the check box of the signal (row) for the event channel (column).
- or*
- ▶ Highlight one or multiple rows and right-click to activate these signals simultaneously for one event channel.

Select signals for the polling measurement mode:

- ▶ Click *Add polling channel* (9).
The button is inactive if the A2L file does not support polling.
- ▶ In the row of the signal, select the polling cycle from the drop-down list.

Filter signal list:





- ▶ Enter the term or partial term in the search box (2) and click *Refresh signal list* (3).
- or*
- ▶ Click *Display selected signals* (4) to only display signals with selected check boxes or selected polling cycle.

Clear signal list filter:

- ▶ Click *Show all signals* (1).

To allow a later MDF export of the data without A2L file, generate a signal definition file in the *Other* category and save it, optionally encrypted, on the ML-N4000. (→ Other)

Status of the signal definition file (10) displays the current state of the file and changes its state by clicking:

-  not generated
-  saved on ML-N4000
-  saved encrypted on ML-N4000
-  not saved on ML-N4000

If supported by the A2L file, you can reduce the sampling rate of each event channel by increasing the *Prescaler (11)*.

DiagCCP > Trigger:

1	Add trigger	4	Delete trigger
2	Trigger type	5	Move trigger up
3	Edit trigger	6	Move trigger down

Here, you create conditions that trigger the following pre-defined actions:

- Start CCP logging
- Stop CCP logging



Start and stop without trigger conditions

Even when you do not create trigger conditions, the CCP recording, provided it is activated, starts and stops automatically at the beginning or ending of the data recording in online mode or HDD mode.

Configure triggers:

- ▶ On the header of the desired trigger action, click *Add trigger* (1).
- ▶ Select the desired *Trigger type* (2).
- ▶ Create a single condition or multiple combined conditions for this trigger. (→ Create trigger conditions)
- ▶ If required, repeat the above steps for further triggers.



Number of configurable triggers

You can configure a maximum of ten triggers per DiagCCP interface channel.

DiagCCP > Other:

Type	Message	Signal	Can ID	Source	Delete
CAN	Botschaft1	Signal1	0x120	[1] CAN 1 (can1)	X
CAN	Botschaft2	Signal3	0x121	[1] CAN 1 (can1)	X

Name	Tech. name	Botschaft
Signal3	Signal3	Message2 (0x121)
Signal4	Signal4	Message2 (0x121)

1	Show/hide A2L signals	4	Additional signals
2	Delete signal	5	Signal selection
3	Delete signal definition file		

To allow a later MDF export of the data without A2L file, generate a signal definition file as a reduced A2L file and save it, optionally encrypted, on the ML-N4000.

Create and encrypt the signal definition file by selecting the check boxes under *MDF-Export of signals*.

Add additional signals (4) to the signal definition file by selecting the desired signals (5). (→ Signal selection)

By clicking (1), you also display the signals which are imported from the A2L file.

By clicking (2), you delete the selected signals and with (3) the whole signal definition file.

DiagCCP > Advanced:

Interface-type:DiagCCP Channel:1

Default Properties

Event channels overview

Short name	Long name	Number	Rate	Priority	DAQ / STIM
seg_sync	segment synchronous	0	Not Cyclic	3	DAQ
10_ms	10ms time synchronous	1	10 ms	2	DAQ
100_ms	100ms time synchronous	2	100 ms	1	DAQ

Seed and Key

Test environment

Input data:

0

Result:

1	Add basic structure of the function	3	Execute function
2	Input data		

This category displays an overview of the configured event channels and allows the definition of a seed and key function for the encrypted communication with the ECU.

Create and test the seed and key function:

- ▶ Click *Add basic structure of the function* (1).
 - ▶ Insert the algorithm that corresponds with the ECU.
 - ▶ Define the *Input data* (2) to test the function.
 - ▶ Click *Execute function* (3).
- The XORAYASuite calculates the output data (key) from the input data (seed) and compares it with the key calculated by the ECU.

DiagXCP:

DiagXCP > Settings:

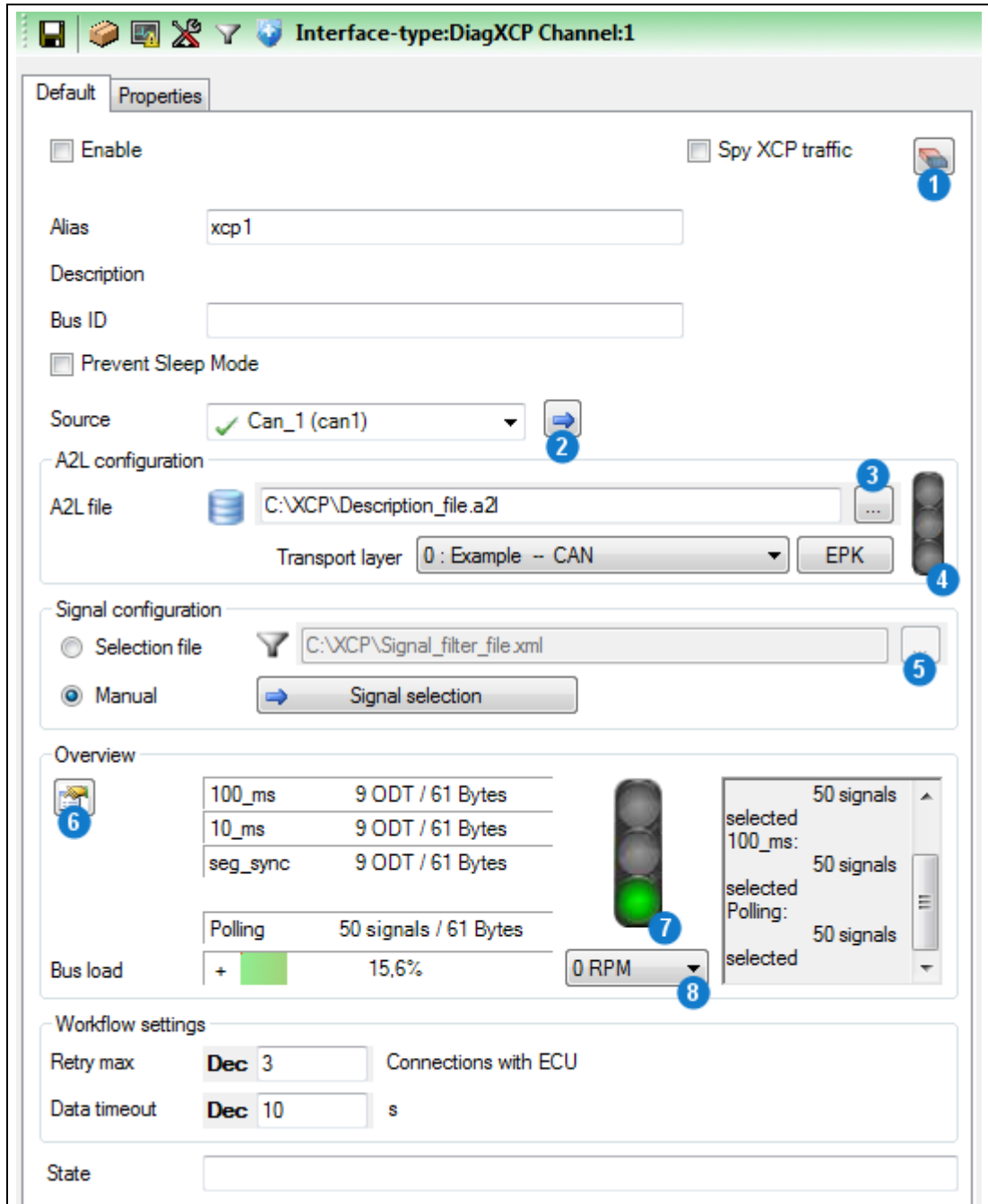

1	Clear all settings	5	Open selection file
2	Edit interface channel	6	Settings
3	Open A2L file	7	Traffic light for the bus load
4	Traffic light for the EPK check	8	Engine RPM*

* Only for angle-synchronous event channels







PROTOCOL_XCP_MASTER
PROTOCOL_XCP_SPY
PROTOCOL_XCP_ON_CAN
PROTOCOL_XCP_ON_FLEXRAY

The available modes (Master, Spy) and physical buses (CAN, FlexRay) depend on the activation of these licenses.

Check in category *Versions* of system settings to verify which licenses are activated for your ML-N4000.
(→ Versions)

Setting	Description	Default
Enable	Turn on logging for this channel	Off
Spy XCP traffic	XCP mode <i>On</i> : Spy (external communication is monitored, no sending) <i>Off</i> : Master	Off
Alias	Freely selectable channel name	xcp#
Bus ID	Additional ID for subsequent evaluation	
Prevent Sleep Mode	ML-N4000 will not go into sleep mode as long as there is activity on this channel	Off
Source	Physical CAN or FlexRay channel to be used	Can_1 (can1)
A2L file	Description file, which is suitable for the ECU and is loaded to configure the XCP connection	
Transport layer	Selection if the A2L contains multiple transport layer descriptions	
Selection file	Signal filter file (XML, CFG or LAB), which contains a (pre-)selection of the signals to be monitored	
Retry max	Maximum number of retries after unsuccessful connection attempt	3
Data timeout	No data received for this period of time (in s) leads to an error	10

Meaning of the symbols for the available CAN or FlexRay channels:

-  transmission-capable
-  transmission-capable, but currently set to passive
-  not transmission-capable (only for CAN)
-  not enabled

Via *Edit interface channel (2)* button, you can enable it, activate its transmission capability or change its baudrate if necessary.

A2L configuration:

- ▶ Click *Open A2L file (3)* and select the description file that corresponds with the ECU.
 - The XORAYASuite reads the A2L file and configures the XCP connection accordingly.
 - If *Overwrite alias with ECU name* under *Settings (6)* is activated, *Alias* is also changed.
- ▶ If the A2L contains multiple transport layer descriptions, select the layer from the appearing window.

You can change this selection afterwards via the drop-down list *Transport layer*.
- ▶ If the time value T7 is equal to 0, increase this value in the appearing window to avoid protocol errors with the ECU.

You can change this value and all the other time values in the category *Advanced*. (→ *Advanced*)
- If supported by the A2L file, the XORAYASuite automatically runs an EPK version check with the ECU and displays the result via the *Traffic light for the EPK check (4)*.

You can also execute this check manually via the *EPK* button.

Levels of the *Traffic light for the EPK check (4)*:

- green check successful
- yellow check not possible
- red check not successful

Signal configuration:

- ▶ Click *Open selection file (5)* and select a suitable XML, CFG or LAB file.
or
- ▶ Click *Signal selection* and select the signals manually. (→ Filter)
- The XORAYASuite calculates the expected percentage of the bus load increase.
The result evaluation is displayed via the *Traffic light for the bus load (7)*.
- ▶ If angle-synchronous (RPM-dependent) event channels are used, select the *Engine RPM (8)*, which influences the bus load calculation.

Configure the levels of the *Traffic light for the bus load (7)*:

- ▶ Right-click on the traffic light and then on *Edit traffic light settings for this interface type*.
- ▶ Specify the percentage limit between green and yellow (standard: 50).
- ▶ Specify the percentage limit between yellow and red (standard: 80).
- ▶ Click *OK*.

DiagXCP > Filter:

Index	Name	Address	seg_sy	10ms	100ms	Polling
0	Signal1	E0010000	<input checked="" type="checkbox"/>	<input type="checkbox"/>	<input type="checkbox"/>	none
1	Signal2	E0020000	<input type="checkbox"/>	<input checked="" type="checkbox"/>	<input type="checkbox"/>	none
2	Signal3	E0030000	<input type="checkbox"/>	<input type="checkbox"/>	<input checked="" type="checkbox"/>	none
3	Signal4	E0040000	<input type="checkbox"/>	<input type="checkbox"/>	<input type="checkbox"/>	1000ms

1	Show all signals	7	Export signals
2	Search box	8	Display XCP main settings
3	Refresh signal list	9	Add polling channel*
4	Display selected signals	10	Status of the signal definition file
5	Clear selected signals	11	Prescaler*
6	Import signals	12	Change column order

* Only if supported by the A2L file

Select signals for the DAQ measurement mode:

- ▶ Select the check box of the signal (row) for the event channel (column).
- or*
- ▶ Highlight one or multiple rows and right-click to activate these signals simultaneously for one event channel.

Select signals for the polling measurement mode:

- ▶ Click *Add polling channel* (9).
The button is inactive if the A2L file does not support polling.
- ▶ In the row of the signal, select the polling cycle from the drop-down list.

Filter signal list:





- ▶ Enter the term or partial term in the search box (2) and click *Refresh signal list* (3).
- or*
- ▶ Click *Display selected signals* (4) to only display signals with selected check boxes or selected polling cycle.

Clear signal list filter:

- ▶ Click *Show all signals* (1).

To allow a later MDF export of the data without A2L file, generate a signal definition file in the *Other* category and save it, optionally encrypted, on the ML-N4000. (→ Other)

Status of the signal definition file (10) displays the current state of the file and changes its state by clicking:

-  not generated
-  saved on ML-N4000
-  saved encrypted on ML-N4000
-  not saved on ML-N4000

If supported by the A2L file, you can reduce the sampling rate of each event channel by increasing the *Prescaler (11)*.

The column order of the event channels is adjustable via the drop-down lists (12).

DiagXCP > Trigger:

1	Add trigger	4	Delete trigger
2	Trigger type	5	Move trigger up
3	Edit trigger	6	Move trigger down

Here, you create conditions that trigger the following pre-defined actions

- Start XCP logging
- Stop XCP logging



Start and stop without trigger conditions

Even when you do not create trigger conditions, the XCP recording, provided it is activated, starts and stops automatically at the beginning or ending of the data recording in online mode or HDD mode.

Configure triggers:

- ▶ On the header of the desired trigger action, click *Add trigger* (1).
- ▶ Select the desired *Trigger type* (2).
- ▶ Create a single condition or multiple combined conditions for this trigger. (→ Create trigger conditions)
- ▶ If required, repeat the above steps for further triggers.



Number of configurable triggers

You can configure a maximum of ten triggers per DiagXCP interface channel.

DiagXCP > Other:

Type	Message	Signal	Can ID	Source	Delete
CAN	Botschaft 1	Signal1	0x120	[1] CAN 1 (can1)	X
CAN	Botschaft 2	Signal3	0x121	[1] CAN 1 (can1)	X

Name	Tech. name	Botschaft
Signal3	Signal3	Message2 (0x121)
Signal4	Signal4	Message2 (0x121)

1	Show/hide A2L signals	4	Additional signals
2	Delete signal	5	Signal selection
3	Delete signal definition file		

To allow a later MDF export of the data without A2L file, generate a signal definition file as a reduced A2L file and save it, optionally encrypted, on the ML-N4000.

Create and encrypt the signal definition file by selecting the check boxes under *MDF-Export of signals*.

Add additional signals (4) to the signal definition file by selecting the desired signals (5). (→ Signal selection)

By clicking (1), you also display the signals which are imported from the A2L file.

By clicking (2), you delete the selected signals and with (3) the whole signal definition file.

DiagXCP > Advanced:

Short name	Long name	Number	Rate	Priority	DAQ / STIM
seg_sync	segment synchronous	0	Not Cyclic	3	DAQ
10_ms	10ms time synchronous	1	10 ms	2	DAQ
100_ms	100ms time synchronous	2	100 ms	1	DAQ

1	Add basic structure of the function	3	Execute function
2	Input data		

This category consists of the following elements:

- Overview of the configured event channels
- Timeout values (changeable)
- FlexRay buffer configuration (partly changeable)
- Mapping of the FlexRay buffers to the event channels (changeable)
- Definition of a seed and key function for the encrypted communication with the ECU

Create and test the seed and key function:

- ▶ Click *Add basic structure of the function* **(1)**.
 - ▶ Insert the algorithm that corresponds with the ECU.
 - ▶ Define the *Input data* **(2)** to test the function.
 - ▶ Click *Execute function* **(3)**.
- The XORAYASuite calculates the output data (key) from the input data (seed) and compares it with the key calculated by the ECU.

Event:

This interface must be activated for proper functioning of:

- Triggers
- Snapshots
- Button interface

Event > Settings:

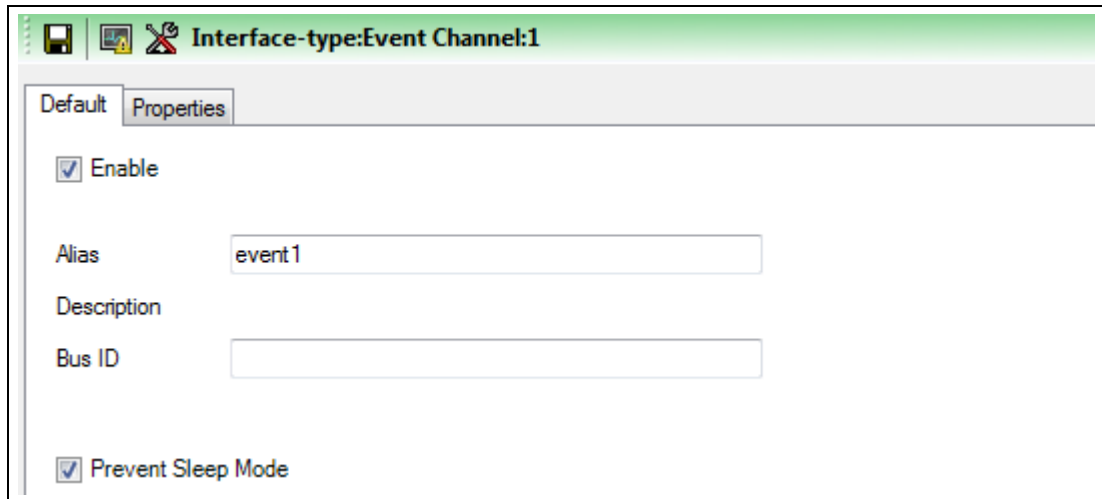

Setting	Description	Default
Enable	Turn on logging for this channel	On
Alias	Freely selectable channel name	event#
Bus ID	Additional ID for subsequent evaluation	
Prevent Sleep Mode	ML-N4000 will not go into sleep mode as long as there is activity on this channel	On

Event > Trigger:

1	Add trigger	4	Delete trigger
2	Trigger type	5	Move trigger up
3	Edit trigger	6	Move trigger down

Here, you create trigger conditions that write custom event messages.

Configure triggers:

- ▶ Click *Add trigger* (1).
- ▶ Select the desired *Trigger type* (2).
- ▶ Create a single condition or multiple combined conditions for this trigger. (→ Create trigger conditions)
- ▶ If required, repeat the above steps for further triggers.



Number of configurable triggers

You can configure a maximum of ten event triggers.

Button:

Use this interface to define which actions are triggered by the following trigger types.

Each trigger type is assigned a channel of the button interface as follows (→ Connections and controls):

- trigger_button Pressing the trigger button (**B**)
- wake_line Signal at the trigger input (**L**)

Actions with a yellow background and a blue outline are enabled.

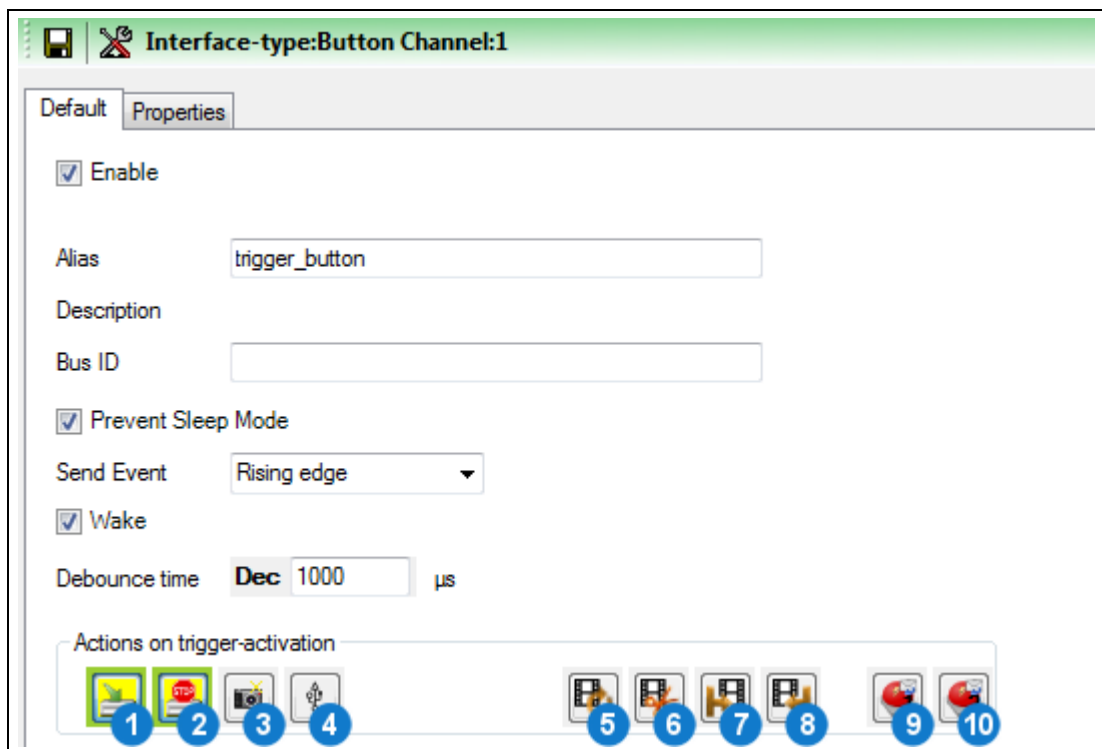

Setting	Description	Default
Enable	Turn on logging for this channel	On
Alias	Freely selectable channel name	trigger_button or wake_line
Bus ID	Additional ID for subsequent evaluation	
Prevent Sleep Mode	ML-N4000 will not go into sleep mode as long as there is activity on this channel	On
Send Event	Generate an additional event message either at the falling or at the rising edge Values: Falling edge, No event, Rising edge	Rising edge
Wake	ML-N4000 wakes up from sleep mode as soon as there is activity on this channel	On
Debounce time	Bridging time (in μ s) to prevent undesired multiple events when a trigger is raised	1000
Action (1)	Start logging	On
Action (2)	Stop logging Long press is required (at least 3 s)	On
Action (3)	Create snapshot	Off
Action (4)	Eject USB device Long press is required (at least 3 s)	Off
Action (5)	The video stream currently stored in the circular buffer is saved permanently	Off
Action (6)	Create screenshot	Off
Action (7)	Start video stream	Off
Action (8)	Stop video stream	Off
Action (9)	Send CAN trigger response 1	Off
Action (10)	Send CAN trigger response 2	Off

5.5.3 Signal configuration

In this section, you configure signals and define signal processing and triggers.



Messages and signals

The payload of a message consists of signals with variable bit length.

Messages and signals are assigned names for easier handling.

Settings:

1	Add signal manually	4	Refresh signals
2	Edit signal	5	Configured signals
3	Delete signal	6	Signal selection

Select the desired signals from (6) to add them to the list of configured signals (5). (→ Signal selection)

This list is stored temporarily or permanently on the ML-N4000.

Click (1) or right-click anywhere in the list (5) to add additional signals manually.

Click (2) or right-click a configured signal in the list (5) to edit this signal.

Signal processing:

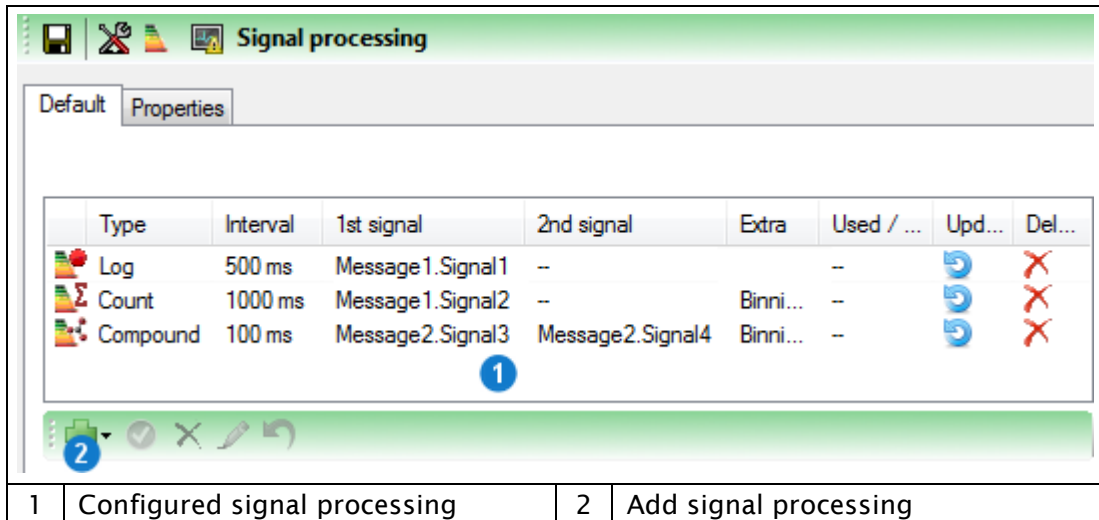

Type	Interval	1st signal	2nd signal	Extra	Used / ...	Upd...	Del...
Log	500 ms	Message1.Signal1	-		-		
Count	1000 ms	Message1.Signal2	-	Binni...	-		
Compound	100 ms	Message2.Signal3	Message2.Signal4	Binni...	-		

1 | Configured signal processing 2 | Add signal processing

Add the desired signal processing to the list (1).

This list is stored temporarily or permanently on the ML-N4000.



DATA_BINNING



This license is required for signal processing.

Check in category *Versions* of system settings to verify which licenses are activated for your ML-N4000.
(→ Versions)

Add signal processing:

- ▶ Click *Add signal processing* (2).
- ▶ Select the desired signal processing type.

The following signal processing types are available:

-  Log Only recording, no binning
-  Count Signal binning
-  Compound Combined binning of two signals



Signal binning

Classes reflect signal value ranges. Classification, or binning, allows a quick overview of how often the value of a signal fits into which class during measurement.

Log:

Signal logging without binning	
Signal	<input type="text"/>
Interval	Dec <input type="text" value="0"/> ms
1	Save signal processing
2	Cancel signal processing

Add signal processing:

- ▶ Select an already configured *Signal*. (→ Settings)
- ▶ Specify the *Interval*.
- ▶ Click *Save signal processing (1)*.

The log signal processing is stored on the ML-N4000.



Interval of the log signal processing

If you specify an interval, the last measured value of the signal is counted in this time range.

If you do not set an interval (corresponding to a 0 in the text box), the value of the signal is stored on each occurrence.

Count:

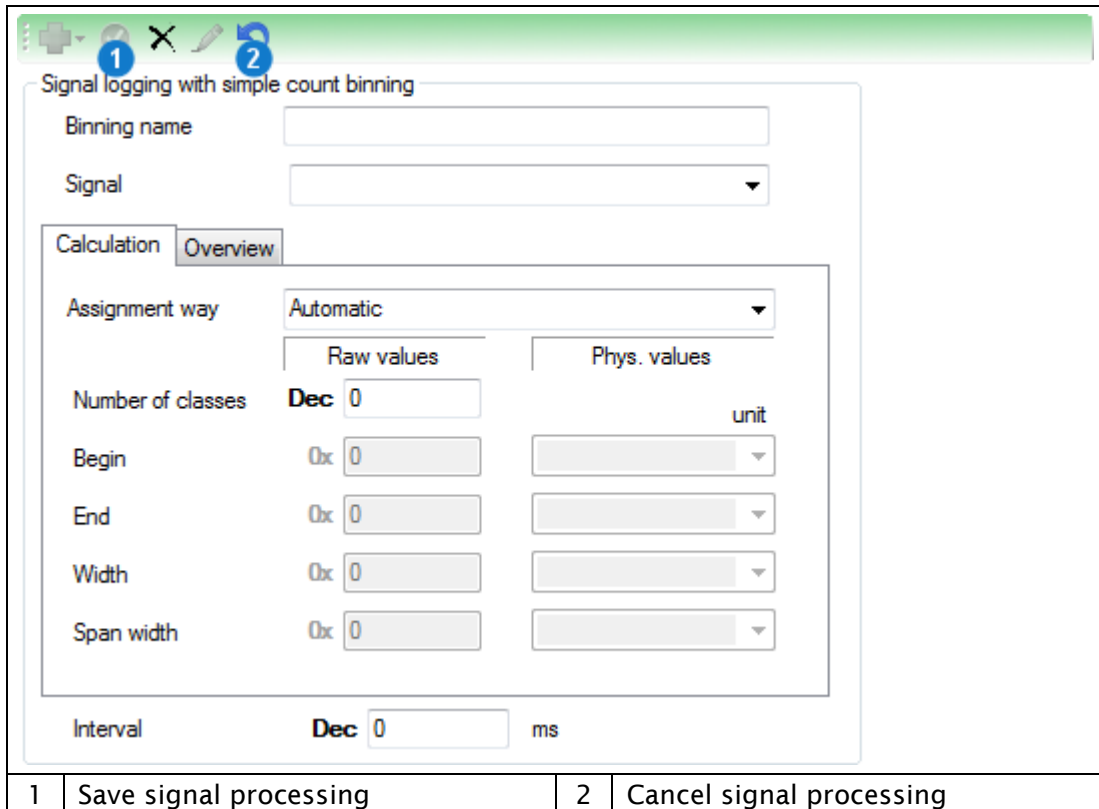

Add signal processing count:

- ▶ Specify a *Binning name*.
- ▶ Select an already configured *Signal*. (→ Settings)
- ▶ Select from *Assignment way* which three out of five text boxes, i.e. *Number of classes*, *Begin*, *End*, *Width* and *Span width* you would like to specify.
- or*
- ▶ Select *Automatic* to create classes of constant width uniformly over the entire value range.
- ▶ Complete all active text boxes in the *Calculation* tab.
 - The XORAYASuite calculates the remaining values and fills the text boxes accordingly.
- ▶ Specify the *Interval*.
- ▶ Click *Save signal processing (1)*.
 - The count signal processing is stored on the ML-N4000.



Interval of count signal processing

If you specify an interval, the first measured value of the signal is counted in this time range.

If you do not set an interval (corresponding to a 0 in the text box), each signal value is counted.

Compound:

1	Save signal processing	3	Signal 1
2	Cancel signal processing	4	Signal 2

The compound signal processing corresponds to a combined count-signal processing for two signals and is processed by the XORAYASuite as a two-dimensional matrix. Therefore, the total class count is a product of the number of classes for both signals.

Add compound signal processing:

- ▶ Configure the binning for the first signal (3).
- ▶ Configure the binning for the second signal (4).
- ▶ Specify the *Interval*.
- ▶ Click *Save signal processing* (1).

The compound signal processing is stored on the ML-N4000.

Edit or delete signal processing:

Type	Interval	1st signal	2nd signal	Extra	Used / ...	Upd...	Del...
Log	500 ms	Message1.Signal1	--	--	--		
Count	1000 ms	Message1.Signal2	--	Binni...	--		
Compound	100 ms	Message2.Signal3	Message2.Signal4	Binni...	--		

Signal logging without binning

Signal:

Interval: Dec ms

1	Configured signal processing	3	Edit signal processing
2	Delete signal processing		

Edit signal processing:

- ▶ Select the signal processing in the list (1).
- ▶ Click *Edit signal processing* (3).
- or*
- ▶ Right-click the signal processing and then click *Edit signal processing*.

Delete signal processing:

- ▶ Select the signal processing in the list (1).
- ▶ Click *Delete signal processing* (2).

Trigger:

1	Add trigger	4	Delete trigger
2	Trigger type	5	Move trigger up
3	Edit trigger	6	Move trigger down

Here, you create conditions that trigger the following actions:

- Start Logging
- Stop Logging
- Shutdown Logger
- Shut down logger without wake up
- Create Snapshot (→ Snapshot)

Add trigger:

- ▶ On the header of the desired trigger action, click *Add trigger* (1).
- ▶ Select the desired *Trigger type* (2).
- ▶ Create a single condition or multiple combined conditions for this trigger. (→ Create trigger conditions)
- ▶ If required, repeat the above steps for further triggers.



Number of configurable triggers

You can configure a maximum of five general signal triggers.

5.6 Resetting to factory defaults

For unwanted or defective system or interface configurations, it is recommended to reset the ML-N4000 back to its factory defaults.

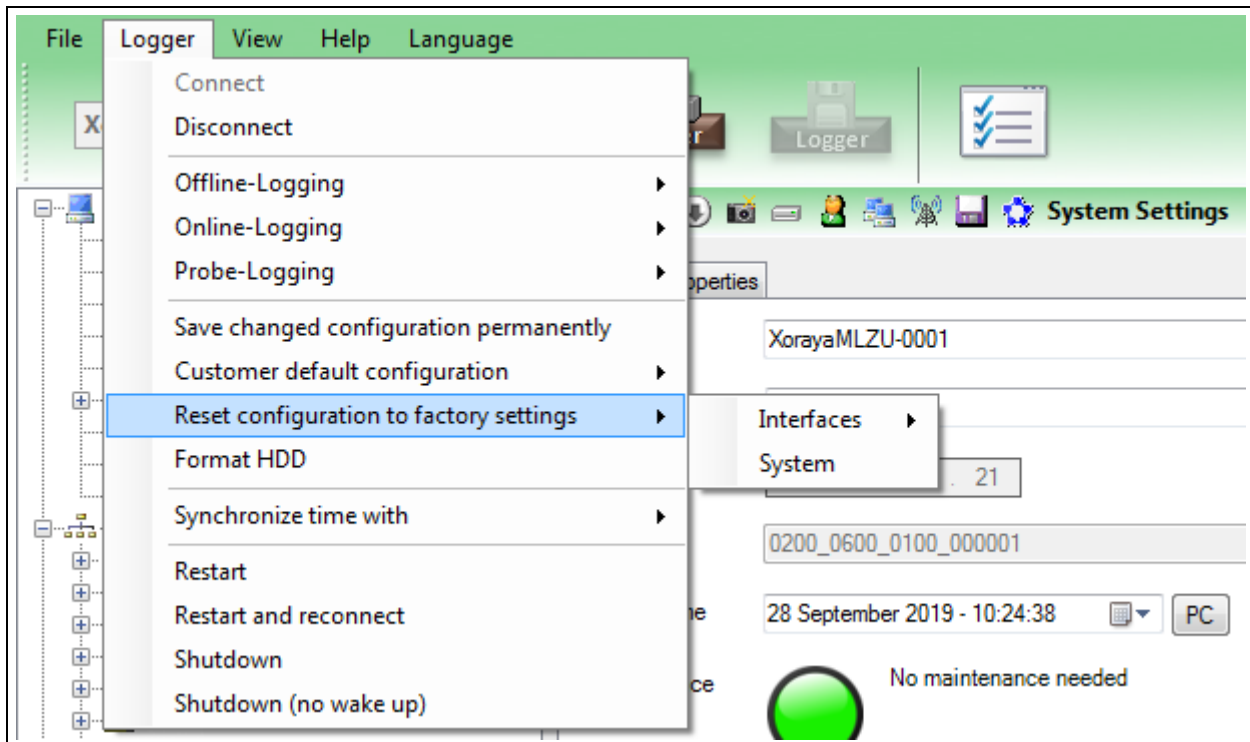

- ▶ In the *Logger* menu, click *Reset configuration to factory settings* to reset the system configuration or one or all interfaces to their factory defaults.

or

- ▶ Press the default button (**D**) for at least 3 seconds to reset all ML-N4000 settings. (→ Connections and controls)

The ML-N4000 goes into idle state by way of confirmation.

- The configuration is reset.



Updating the firmware

Factory setting are automatically restored whenever features are added or eliminated upon a firmware update. (→ Firmware-Update)

Therefore, you should check your configuration status after each firmware update.

5.7 Data recording

Data may be recorded in two ways:

- Online mode

The ML-N4000 transmits received messages directly to a PC, where they are stored in log files. To do so, the ML-N4000 must be connected to the PC.

- HDD mode

Received messages are stored on the internal ML-N4000 storage medium, on a USB flash drive or on the XORAYA ESU. No PC is required in this case, as the ML-N4000 is fully autonomous in this mode. HDD logging may still be started and stopped from the PC.



Simultaneous recording modes

Both modes can be operated in parallel, but separately controlled.

5.7.1 Online mode

The *Online-Logging* tool enables data recording in online mode.

- ▶ Connect the ML-N4000 to the measurement environment. (→ Connecting the ML-N4000 to the measuring environment)
- ▶ Connect the ML-N4000 to the PC. (→ Connecting the ML-N4000 to the PC)
- ▶ Turn on the ML-N4000.
- ▶ Start the *Online-Logging* tool of the XORAYASuite. (→ Starting)
- ▶ Connect to the desired ML-N4000. (→ Connecting the ML-N4000)

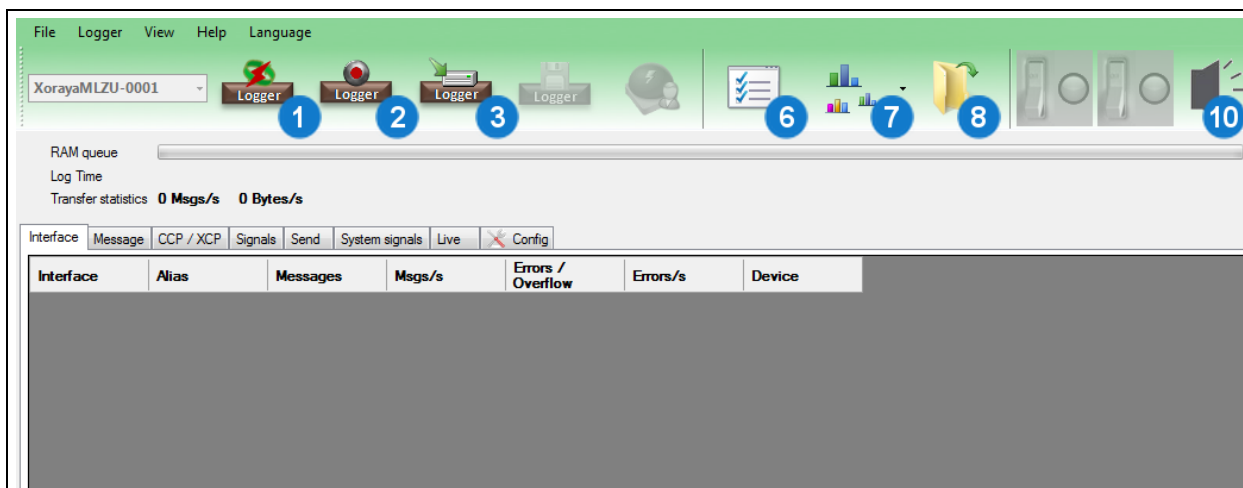

1	Release connection to logger	8	Open the latest created session or measurement in the <i>Viewer</i> tool
2	Start online logging		
3	Start Hdd logging	10	Trigger acoustic signal to identify ML-N4000
6	Display settings		
7	Displays the current bus traffic		

Use *Display settings* (6) to customize the following:

- Path and filename (→ Export settings)
- Output format (→ Output formats)
- Acoustic warning or executing a script if a bus error is detected
- Buses to be recorded
- Color assignments for the interfaces
- Signal description (→ Signal description settings)
- Load configuration template (Busspec)
- Manage logger favorites (→ Favorites)

Store data on the PC:

- ▶ Click *Start online logging* (2).

Data received via interfaces are recorded on the PC.



HDD mode

Start the recording on the internal or external storage medium of the ML-N4000 via *Start Hdd logging* (3) or autonomously without a PC, as described in the relevant section. (→ HDD mode)

Both modes can be operated simultaneously.

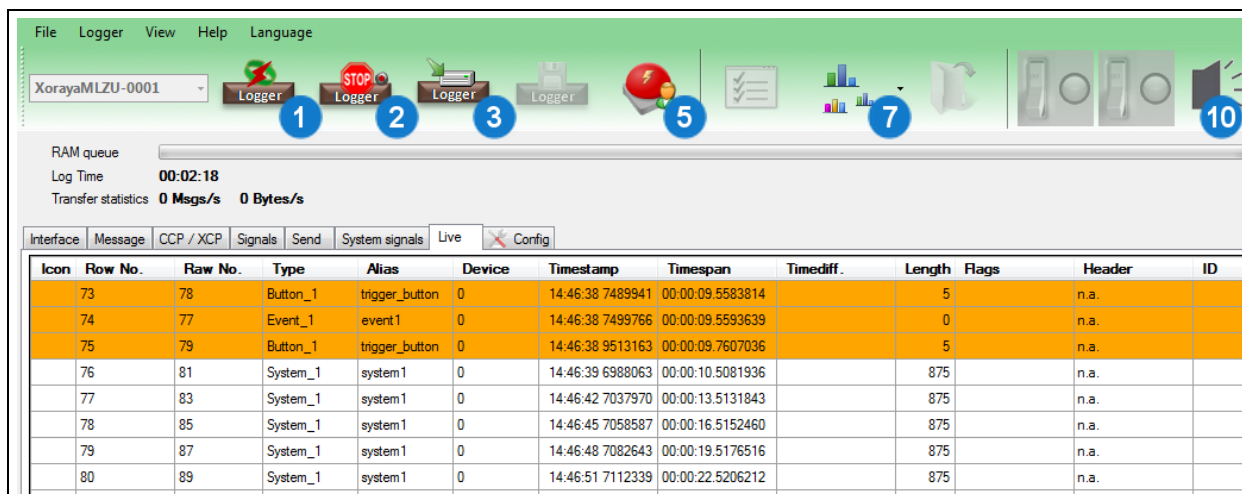

The screenshot shows the software interface with a toolbar at the top containing icons labeled 1 through 10. Below the toolbar, there are status indicators for RAM queue, Log Time (00:02:18), and Transfer statistics (0 Msgs/s, 0 Bytes/s). A tabbed interface is visible with tabs for Interface, Message, CCP / XCP, Signals, Send, System signals, Live, and Config. Below the tabs is a data table with columns: Icon, Row No., Raw No., Type, Alias, Device, Timestamp, Timespan, Timediff., Length, Flags, Header, and ID.

Icon	Row No.	Raw No.	Type	Alias	Device	Timestamp	Timespan	Timediff.	Length	Flags	Header	ID
	73	78	Button_1	trigger_button	0	14:46:38 7489941	00:00:09.5583814		5		n.a.	
	74	77	Event_1	event1	0	14:46:38 7499766	00:00:09.5593639		0		n.a.	
	75	79	Button_1	trigger_button	0	14:46:38 9513163	00:00:09.7607036		5		n.a.	
	76	81	System_1	system1	0	14:46:39 6988063	00:00:10.5081936		875		n.a.	
	77	83	System_1	system1	0	14:46:42 7037970	00:00:13.5131843		875		n.a.	
	78	85	System_1	system1	0	14:46:45 7058587	00:00:16.5152460		875		n.a.	
	79	87	System_1	system1	0	14:46:48 7082643	00:00:19.5176516		875		n.a.	
	80	89	System_1	system1	0	14:46:51 7112339	00:00:22.5206212		875		n.a.	

1	Release connection to logger	7	Displays the current bus traffic
2	Stop online logging	10	Trigger acoustic signal to identify ML-N4000
3	Start Hdd logging		
5	Set Trigger for later evaluation		

Online logging information is distributed over several tabs.

The following table describes the general function of each tab and the options offered in the context menu when right-clicking.

Tab	Function and context menu
Interface	Summary of recorded messages and errors grouped by interfaces and channels Context menu: <ul style="list-style-type: none"> ▪ Show or hide columns ▪ Hide inactive interfaces or channels
Message	Summary of recorded messages and errors grouped by messages Context menu: <ul style="list-style-type: none"> ▪ Fix selected rows ▪ Filter data by interfaces or channels ▪ Legend of the error flags
CCP / XCP	Summary of recorded CCP / XCP signals Context menu: <ul style="list-style-type: none"> ▪ Fix selected rows ▪ Hide selected messages ▪ Accelerate ECU registration of signals ▪ Represent data graphically (→ Graph View) ▪ Display physical properties
Signals	Monitoring of defined signals (→ Signal selection) Context menu: <ul style="list-style-type: none"> ▪ Show or hide columns ▪ Hide selected signals ▪ Save, load and delete signal lists
Send	Send user-defined CAN, RS-232 or Ethernet UDP messages once or cyclically
System signals	Display of system signals (core temperature, for example) as widgets
Live	Live view of the current recording, where a row corresponds to a message Context menu: <ul style="list-style-type: none"> ▪ Show or hide columns ▪ Filter data by interfaces, channels or CAN/FlexRay IDs ▪ Set Timemaster ▪ Freeze display ▪ Free up display area: Delete displayed rows ▪ Set the number of rows displayed (default: 500) ▪ Set details of the selected row: Specify whether the detail view will jump to new incoming messages or remains constant ▪ Represent data graphically (→ Graph View)
Config	Current ML-N4000 configuration



Messages and signals

The payload of a message consists of signals with variable bit length.

Messages and signals are assigned names for easier handling.



Timemaster

An additional column *Timediff.* is displayed when you set the Timemasters on a particular record. This column contains the time difference of each record to the Timemaster.

Represent data in graphical form:

- ▶ Click *Displays the current bus traffic (7)*.
- ▶ Choose among *Bus statistics*, *Message statistics* and *Interface statistics* the desired source data for graphical output. (→ Graph View)

Stop data recording:

- ▶ Click *Stop online logging (2)*.

5.7.2 HDD mode

In this mode, the ML-N4000 saves to one of the following media:

- Internal storage medium (default)
- USB flash drive if *Record on USB stick* in the *Hard Disk* category is checked and the conditions described there are met (→ Hard Disk)
- Additional device XORAYA ESU (automatically if detected by the ML-N4000)

Start data recording:

- ▶ Connect the ML-N4000 to the measurement environment.
(→ Connecting the ML-N4000 to the measuring environment)
- ▶ Optionally:
Connect a USB flash drive to the USB host interface **(K)**.
(→ Connections and controls)
- ▶ Optionally:
Connect a XORAYA ESU to the corresponding interface **(I)**.
- ▶ Turn on the ML-N4000.
- ▶ Start the HDD recording by pressing the trigger button **(B)** on the ML-N4000.

- Data received via the interfaces are recorded.

Stop data recording:

- ▶ Press the trigger button **(B)** for at least 3 seconds.



Configuration of trigger button

The behavior of the trigger button can be configured via the button interface. (→ Button)



HDD mode in the XORAYASuite

You can also start and stop the HDD mode from the *Configuration*, *Online-Logging*, *Hdd-Download* and *Firmware-Update* tools.

Data recorded on the storage medium is stored as sessions. Sessions always contain complete messages and are limited to a maximum size which defaults to 1000 MB.

New sessions are created under the following conditions:

- The HDD recording is started manually by a trigger or via the XORAYASuite.
- The ML-N4000 is turned on or woken up and *Autostart* in the *Hard Disk* category is checked. (→ Hard Disk)
- The session size exceeds the maximum size specified. In this case, the current session is closed, and a new session for the current measurement starts.

Sessions are closed under the following conditions:

- Recording is stopped manually
- The ML-N4000 goes into sleep mode
- The maximum size is exceeded

Existing sessions and measurements on the storage medium can be displayed, downloaded or deleted in the *Hdd-Download* tool of the XORAYASuite. (→ Hdd-Download)

5.7.3 Log data

The storage location for log data to be recorded is specified in the text boxes *Path* and *Filename*. This applies both to the online logging as well as to log data downloaded from the storage medium.

Log data in *X2E-Native* format are stored in various files with the same base name but different file extensions. (→ X2E-Native)

The master file with the file extension DLI serves as link. This file contains information about the included log interfaces and references to the corresponding binary files.

File	Format	Meaning
<name>.dli	ASCII	Master file: <ul style="list-style-type: none"> Contains information about log interfaces and references to the binary files
<name>.dlm	Binary	Meta file: <ul style="list-style-type: none"> Contains index information for faster search within binary data
<name>_0000.dlf <name>_0001.dlf ...	Binary	Binary file: <ul style="list-style-type: none"> Contains recorded data for all log interfaces To limit the file size, data are spread across multiple sequentially numbered files as needed
<name>.dls	ASCII	Statistics file: <ul style="list-style-type: none"> optionally created if the property <i>WriteStatistics</i> is checked

5.8 Hdd-Download

This tool allows downloading log data stored on the datalogger storage medium or a USB flash drive.

- ▶ Connect the ML-N4000 to the PC.
(→ Connecting the ML-N4000 to the PC)
- ▶ Optionally:
Connect a XORAYA ESU to the corresponding interface (I).
(→ Connections and controls)
- ▶ Turn on the ML-N4000.
- ▶ Start the *Hdd-Download* tool of the XORAYASuite. (→ Starting)

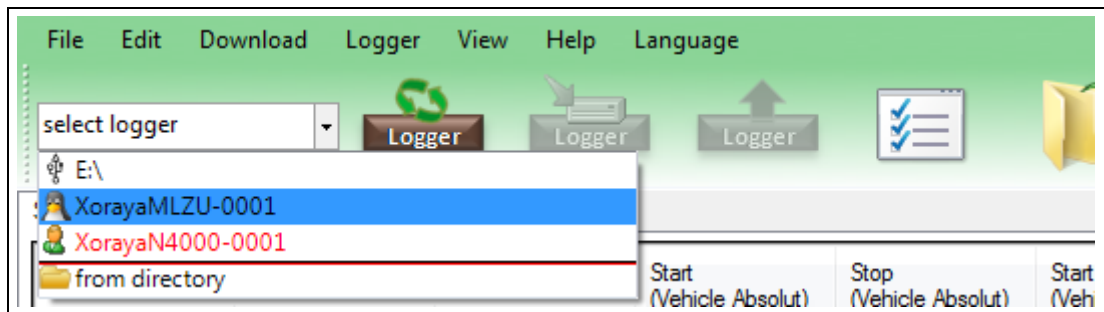

- ▶ Connect to the desired ML-N4000. (→ Connecting the ML-N4000)
or
- ▶ Connect to a USB flash drive that contains recorded measurements.
or
- ▶ Connect to a directory on your PC that contains a measurement recorded via USB.



USB flash drive in list

The connected USB flash drive is only available in the list if it is named *XORAYALOG* and contains the folder *usb_queue*.

The following descriptions refer to the connection with a ML-N4000. Connecting with a USB flash drive or a directory works principally in the same way.

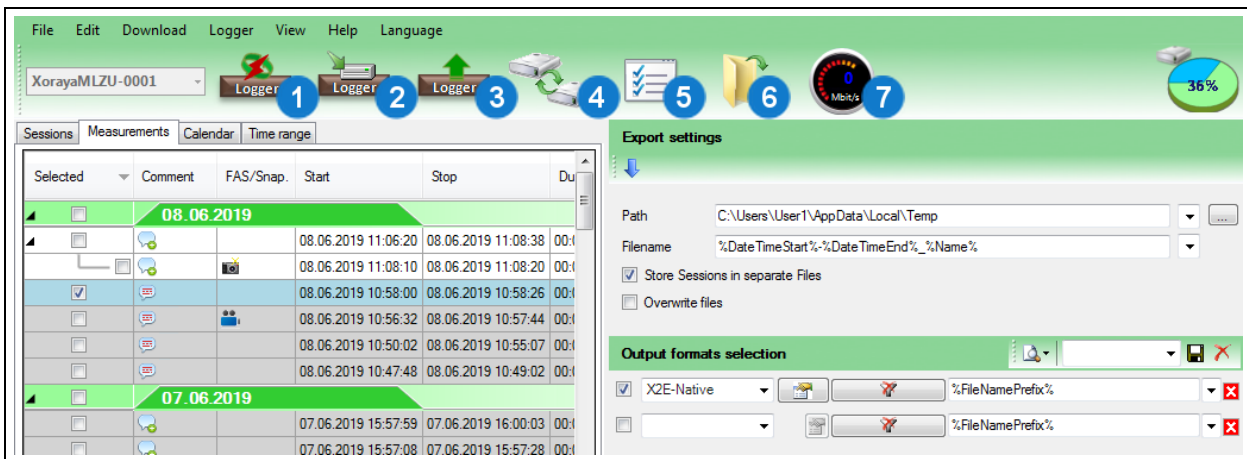

1	Release connection to logger	5	Display settings
2	Start Hdd logging	6	Open last used path in Windows Explorer
3	Start download	7	Show download statistics
4	Change disk*		

* Only with connected XORAYA ESU

Click *Change disk* (4) to change between the internal storage medium and a connected XORAYA ESU.

Use *Display settings* (5) or the *Settings* command in the *Download* menu to customize the following:

- Miscellaneous settings, for example, enable/disable time groups or eject the USB flash drive automatically after disconnecting
- Color assignments for the interfaces
- Manage logger favorites (→ Favorites)



Change temporary download folder

When downloading measurements that include a stream queue part, by default, the XORAYASuite saves data in the Windows temporary folder. If there is not sufficient disk space available on this drive, it is possible to specify an alternative path in the user or system environment variable `X2E_XORAYA_SHADOW_DIR`.

Please note that restarting Windows might be necessary after setting the environment variable. For further questions, contact your system administrator.

There are different ways to select the log data to download:

- *Edit menu: Select all or Select none*
- *Sessions and Measurements tabs*
- *Calendar tab*
- *Time range tab*

Sessions/Measurements:

You can show and hide the *Sessions* tab in the settings.

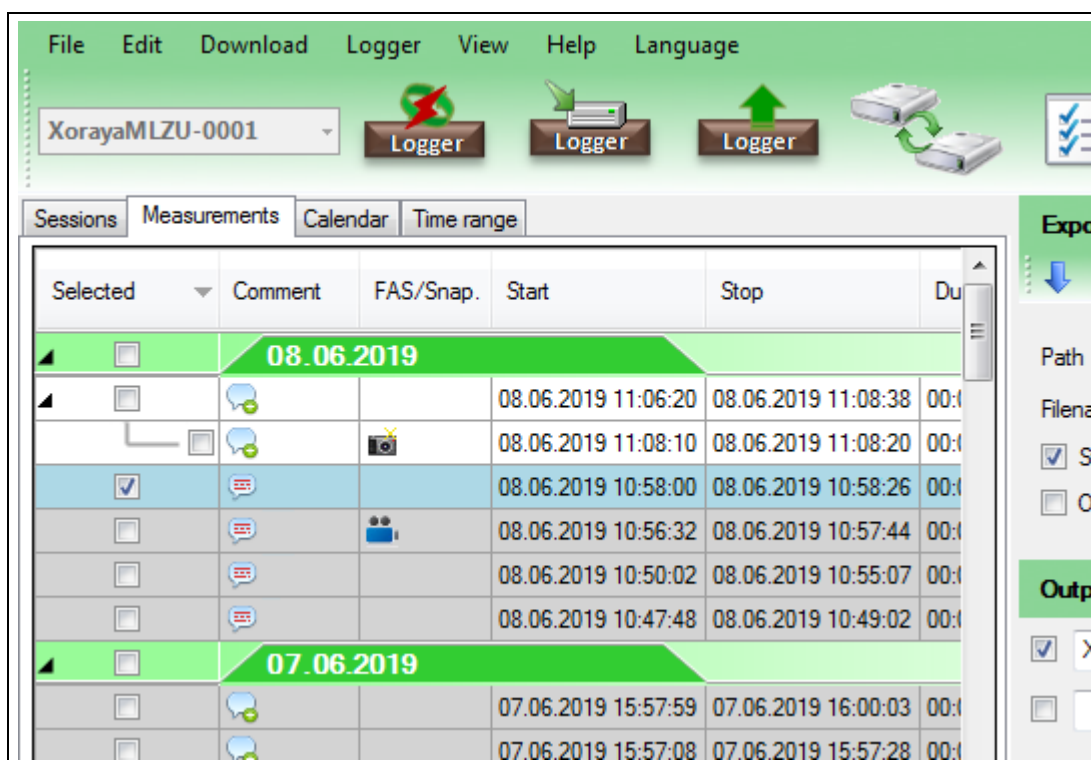

- ▶ Select the check boxes in the *Selected* column.
- or*
- ▶ Right-click to access the advanced selection options in the context menu.

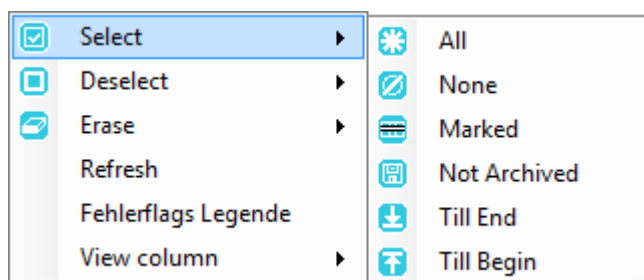

Calendar:

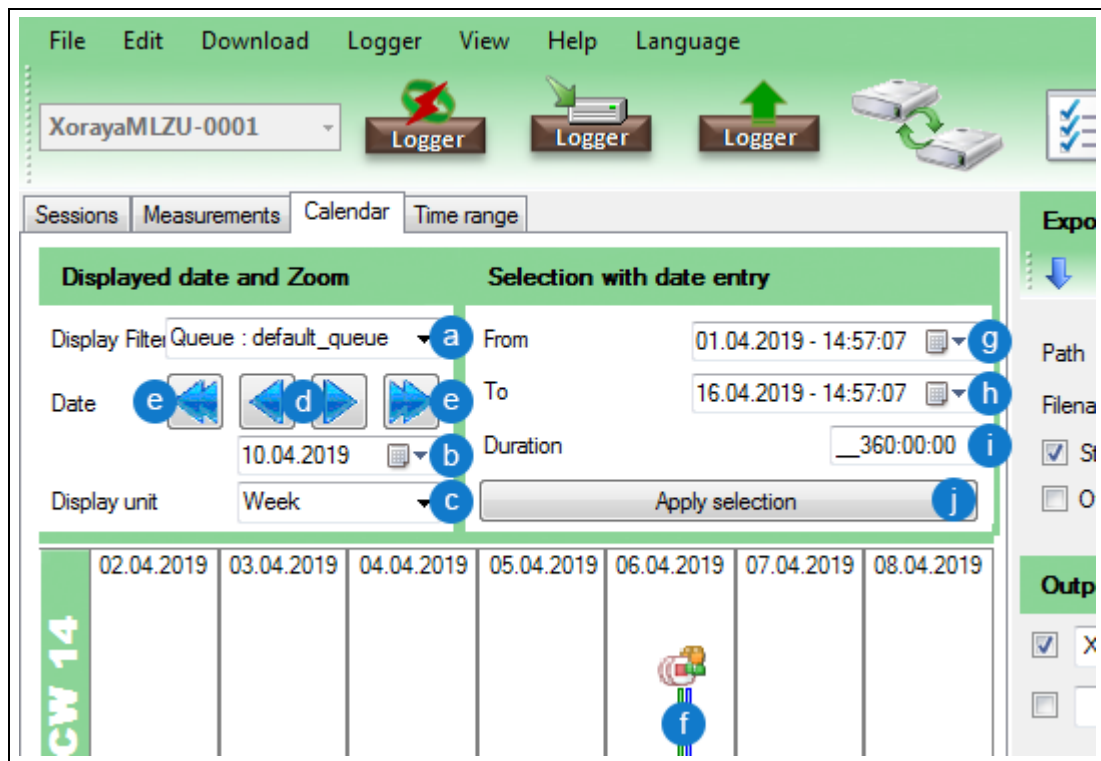

Displayed date and Zoom:

- ▶ Filter the displayed measurements, for example, by default or streaming queue (a).
 - ▶ Specify a start date (b).
 - ▶ Choose between *Week* and *Day* (c) as the displayed time unit.
 - ▶ Click the single arrows (d) to jump one day or one week forward or backward.
 - ▶ Click the double arrows (e) to jump three days or three weeks forward or backward.
 - ▶ Click the graphical representation of a measurement (f) to select it.
- or
- ▶ Click and drag to select all measurements in this time range.

Select with date entry:

- ▶ Specify start date and start time (g).
 - ▶ Specify end date and end time (h).
- or
- ▶ Enter the duration (i).
 - ▶ Click *Apply selection* (j).

Time range:

Selected	FAS/Snap.	Start	Stop	Duration
<input checked="" type="checkbox"/>		07.06.2019 15:57:59	07.06.2019 16:00:03	00:02:04
<input checked="" type="checkbox"/>		07.06.2019 15:57:08	07.06.2019 15:57:28	00:00:20
<input checked="" type="checkbox"/>		07.06.2019 15:56:59	07.06.2019 15:57:04	00:00:04
<input checked="" type="checkbox"/>		07.06.2019 15:56:40	07.06.2019 15:56:54	00:00:13
<input checked="" type="checkbox"/>		07.06.2019 14:12:09	07.06.2019 14:12:34	00:00:25

- ▶ Specify start date **(a)** and start time **(b)** of the desired time range.
- ▶ Specify the end date **(c)**. Use the arrows **(d)** optionally to apply the start date or to jump one day forward or backward.
- ▶ Specify the end time **(e)**.
- ▶ Click *Apply* **(f)**.
- ▶ Limit the time range further by clicking and dragging inside the graphical representation **(g)**.



History

The time ranges defined since starting the tool can be selected again via the *History* button **(h)**.

Settings:

- ▶ Specify the *Export settings*. (→ Export settings)
- ▶ Specify the *Output formats*. (→ Output formats selection)



Load settings from ML-N4000 

If you have previously used the *Export* category to save client settings on the ML-N4000, then you can load these via this button. (→ Export)

Additionally, you are asked if you want to apply the settings when connecting to the ML-N4000.

Download log data:

- ▶ Click *Start download* (3).
- or
- ▶ In the *Download* menu, click *Start*.

- The selected sessions or measurements are transmitted to the PC.

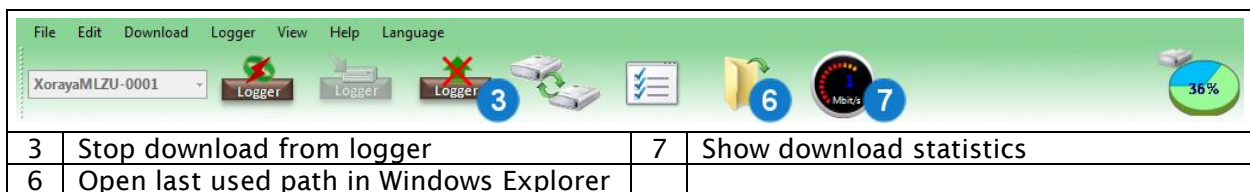

Statistical data

Click the arrow behind *Show download statistics* (7) to switch between different statistics.

The symbol displays the current value during download and the average as the process completes.

Click *Show download statistics* (7) to show statistical data graphically. (→ Graph View)

Cancel download:

- ▶ Click *Stop download from logger* (3).
- or
- ▶ In the *Download* menu, click *Cancel*.

5.9 Viewer

This tool allows display and analysis of records. No ML-N4000 connection is necessary to do this.

- ▶ Start the *Viewer* tool of the XORAYASuite. (→ Starting)

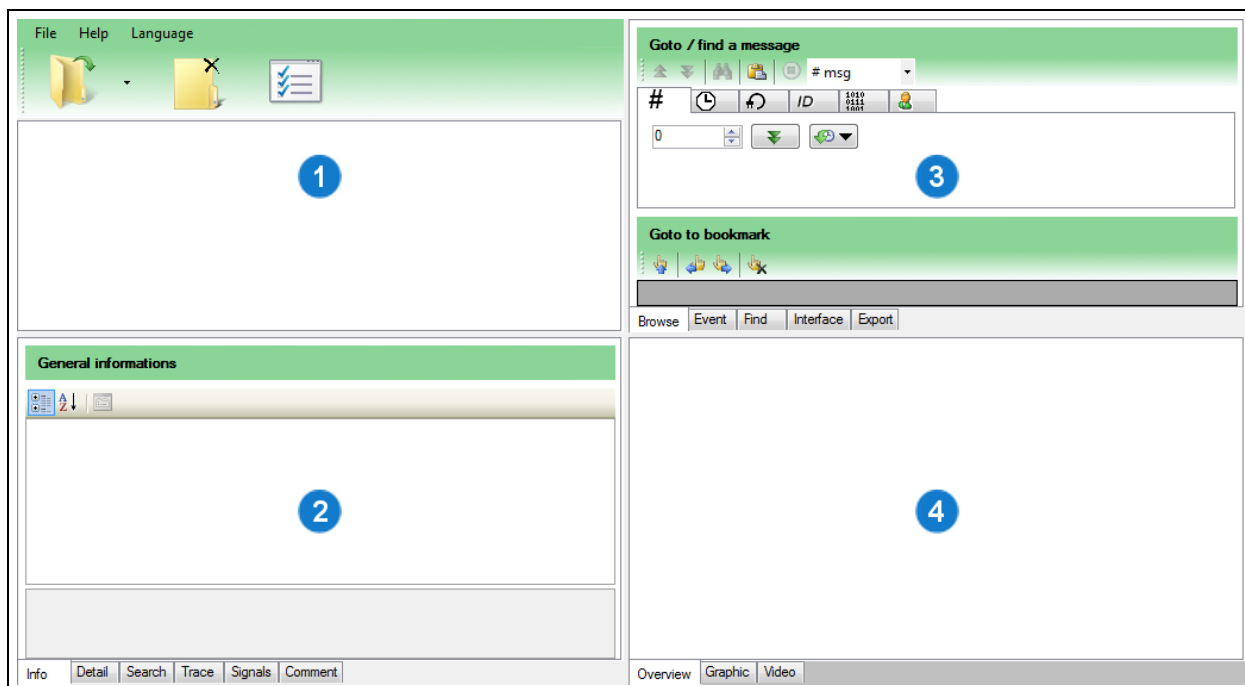

The subsequent view is divided into four panels, which can be resized at will:

- Data (1)
- Information (2)
- Search, filter and export (3)
- Graphical output (4)

5.9.1 Data

This panel displays the record set of the opened measurement.

Icon	Row No.	Raw No.	Type	Alias	Device	Timestamp	Times
	75	75	Button_1	trigger_button	0	14:46:38 7489941	00:00:0
!	76	76	Event_1	event1	0	14:46:38 7499766	00:00:0
	77	77	Button_1	trigger_button	0	14:46:38 9513163	00:00:0
	78	78	System_1	system1	0	14:46:39 6988063	00:00:1
	79	79	System_1	system1	0	14:46:42 7037970	00:00:1
	80	80	System_1	system1	0	14:46:45 7058587	00:00:1
	81	81	System_1	system1	0	14:46:48 7082643	00:00:1
	82	82	System_1	system1	0	14:46:51 7112228	00:00:2

1	Open measurement	3	Display settings
2	Close selected measurement	4	Opened measurements

Open measurement:

- ▶ Click *Open measurement* (1) and select the DLI file.
or
- ▶ In the *File* menu, click *Open* and select the DLI file.
or
- ▶ Drag-and-drop the DLI file from the Windows Explorer into the *Data* panel.

Display recently opened measurements:

- ▶ Click the arrow behind *Open measurement* (1).
or
- ▶ In the *File* menu, click *Recent files*.



Opened measurements and filter

Each open measurement is represented by a tab (4).

A filter icon in the respective tab identifies a configured interface filter. (→ Interface)

To delete the filter, right-click the desired tab and select *Cancel filter*.

Close measurement:

- ▶ Click *Close selected measurement (2)*.
or
- ▶ In the *File* menu, click *Close*.
or
- ▶ Right click the desired measurement tab and then on *Close the file*.

Right-click the desired record to view further options in the context menu:

- Set timemaster
- Set custom region
 - by manually selecting the start and stop row
 - automatically a certain time span before and after the selected row
- Add record to bookmarks
- Set time format (with date, 100 nanoseconds or standard)
- Show or hide columns
- Draw record signal in the *Graphic* tab of the *Graphical output* panel (→ *Graphic*)



Timemaster

An additional column *Timediff.* is displayed when you set the timemaster on a particular record. This column contains the time difference of each record to the Timemaster.



Custom region

Use a custom region to restrict your export scope. To do so, select the appropriate option in the source region selection. (→ *Export*)

In addition, the start and stop rows will be automatically added to the bookmarks.



Bookmarks

Adding records to the bookmarks allows jumping to a favorite record position immediately. (→ *Browse*)



On the right edge of the panel, there are two scroll bars that can be adjusted independently.

Left-click (1) to specify whether scrolling is by row numbers or time.

Right-click (1) to specify how many rows or how much time is scrolled per click on the double-arrow buttons (2).

Left-click the single-arrow buttons (3) to move only one row at a time.



Fine zone

If a Fine zone is specified in the *Overview* tab of the *Graphical output*, the left scroll bar refers to this zone. (→ Overview)

5.9.2 Information

This panel displays information about active measurement and search results.

Tabs:

- Info
- Detail
- Search
- Trace
- Signals
- Comment

Info:

This tab displays general information about all records for the open measurement.

General informations									
<div style="display: flex; align-items: center;"> 1 2 </div>									
<div style="background-color: #f0f0f0; padding: 2px;"> 1 - General </div> <table border="1" style="width: 100%; border-collapse: collapse;"> <tr> <td style="width: 50%;">DLF file 0</td> <td>C:\Users\User1\AppData\Local\Temp\Measurement1_0000.dlf</td> </tr> <tr> <td>DLI file</td> <td>C:\Users\User1\AppData\Local\Temp\Measurement1.dli</td> </tr> <tr> <td>DLM file</td> <td>C:\Users\User1\AppData\Local\Temp\Measurement1.dlm</td> </tr> </table>		DLF file 0	C:\Users\User1\AppData\Local\Temp\Measurement1_0000.dlf	DLI file	C:\Users\User1\AppData\Local\Temp\Measurement1.dli	DLM file	C:\Users\User1\AppData\Local\Temp\Measurement1.dlm		
DLF file 0	C:\Users\User1\AppData\Local\Temp\Measurement1_0000.dlf								
DLI file	C:\Users\User1\AppData\Local\Temp\Measurement1.dli								
DLM file	C:\Users\User1\AppData\Local\Temp\Measurement1.dlm								
<div style="background-color: #f0f0f0; padding: 2px;"> 2 - Messung </div> <table border="1" style="width: 100%; border-collapse: collapse;"> <tr> <td style="width: 50%;">Begin</td> <td>01.10.2019 14:46:29 1906127 GMT +02:00</td> </tr> <tr> <td>End</td> <td>01.10.2019 14:49:36 8895851 GMT +02:00</td> </tr> <tr> <td>Messages</td> <td>138</td> </tr> <tr> <td>Size</td> <td>0,19 MiB</td> </tr> </table>		Begin	01.10.2019 14:46:29 1906127 GMT +02:00	End	01.10.2019 14:49:36 8895851 GMT +02:00	Messages	138	Size	0,19 MiB
Begin	01.10.2019 14:46:29 1906127 GMT +02:00								
End	01.10.2019 14:49:36 8895851 GMT +02:00								
Messages	138								
Size	0,19 MiB								
<div style="background-color: #f0f0f0; padding: 2px;"> 3 - Device </div> <table border="1" style="width: 100%; border-collapse: collapse;"> <tr> <td style="width: 50%;">Comment</td> <td></td> </tr> <tr> <td>Firmware</td> <td>4.0a.0015</td> </tr> <tr> <td>Name</td> <td>XorayaMLZU-0001</td> </tr> <tr> <td>SerialNo</td> <td>0200_0600_0100_000001</td> </tr> </table>		Comment		Firmware	4.0a.0015	Name	XorayaMLZU-0001	SerialNo	0200_0600_0100_000001
Comment									
Firmware	4.0a.0015								
Name	XorayaMLZU-0001								
SerialNo	0200_0600_0100_000001								
<div style="background-color: #f0f0f0; padding: 2px;"> 4 - Interfaces </div> <table border="1" style="width: 100%; border-collapse: collapse;"> <tr> <td style="width: 50%;">Button 1 (trigger button)</td> <td>2</td> </tr> </table>		Button 1 (trigger button)	2						
Button 1 (trigger button)	2								
1	Sort by categories	2	Sort alphabetically across categories						

Detail:

This tab displays detailed information about the currently selected record. The display changes depending on the interface type.

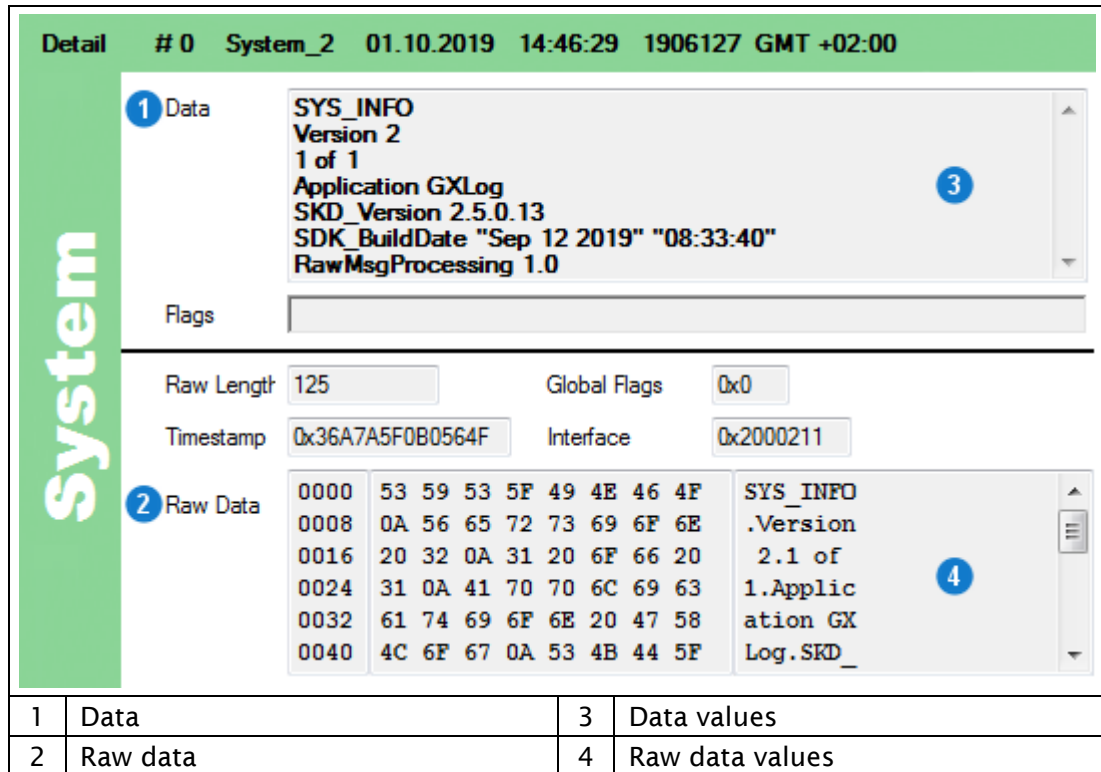

1	Data	3	Data values
2	Raw data	4	Raw data values

Right-click anywhere on the white or green background part of the user interface to select whether the underlying raw data (2) is also displayed alongside the data (1).

Right-click anywhere on the data values (3) or raw data values (4) to change the display between:

- Hexadecimal (base 16)
- Decimal (base 10)
- Octal (base 8)
- Binary (base 2)
- ASCII
- Automatically selected display

Search:

This tab displays records found by search processes using the button *All since cursor*.

The button *All since cursor* can be found in the following panels and tabs:

- *Information panel, Signals tab*
- *Search, filter and export panel, Browse tab*
- *Search, filter and export panel, Find tab*

Search results : (msg.type == Button) 1			
Type	Nr	Timestamp	Title
	75	01.10.2019 14:46:38	72 69 73 65 00
	77	01.10.2019 14:46:38	66 61 6C 6C 00

Found 2 results 6

1	Search condition	4	Go to next search result
2	Go to selected search result	5	Delete selected search result
3	Go to previous search result	6	Number of search results

Trace:

This tab displays status and error messages.

Signals:

Use this tab to search for specific signals in the records of the opened measurement. The right-side view is different depending on whether *Show signal details (13)* or *Manage signal lists (12)* is activated.

Show signal details (13) is activated:

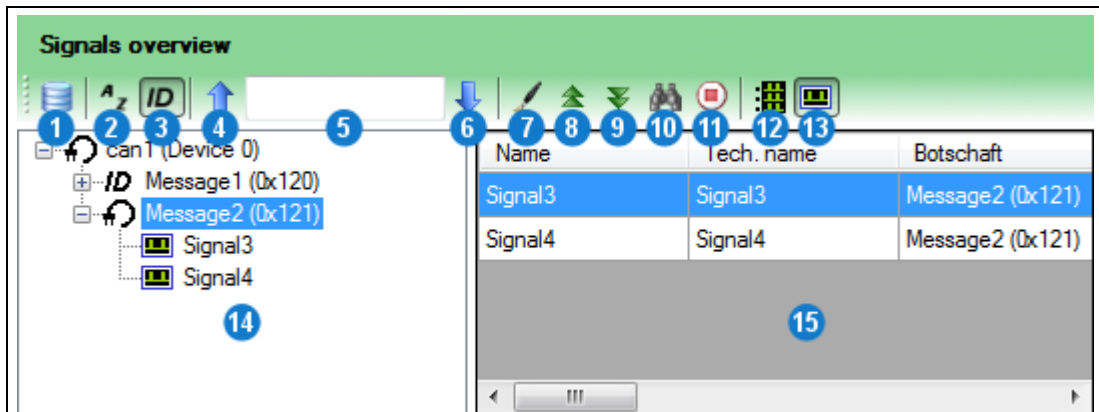

1	Signal description settings	9	Next
2	Sort alphabetically	10	All since cursor
3	Sort by ID	11	Cancel
4	Find previous	12	Manage signal lists
5	Search box	13	Show signal details
6	Find next	14	Signals overview
7	Draw selected signals	15	Signal details
8	Previous		

Add signals to signals overview (14):

- ▶ Click *Signal description settings (1)*.
- ▶ Add one or more description files to the current signal group.
(→ Signal description settings)

Sort the signals overview (14):

- ▶ Click *Sort alphabetically (2)* to sort by message name.
or
- ▶ Click *Sort by ID (3)* to sort by message ID.

Search by message, signal or ID in the signals overview (14):

- ▶ Enter the term or partial term in the search box (5).
- ▶ Click *Find previous (4)*.
or
- ▶ Click *Find next (6)*.

Display signal details (15):

- ▶ Select a message in the signals overview (14) to view details for all signals of this message.

or

- ▶ Select a signal to view details for this signal.

Display signals graphically:

- ▶ Select a signal in the signal details (15).

or

- ▶ Select multiple signals by using the Shift key or the Ctrl key.
- ▶ Click *Draw selected signals* (7) to display the graphical representation in the *Graphic* tab. (→ Graphic)

Search message in open log data:

- ▶ In the signals overview (14), select the message to be searched for.
- ▶ Click *Previous* (8) to move to the previous record of this message.

or

- ▶ Click *Next* (9) to move to the next record of this message.

or

- ▶ Click *All since cursor* (10) to display all records of this message, starting at the current position, in a list. (→ Search)

Cancel search:

- ▶ Click *Cancel* (11).

Manage signal lists (12) is activated:

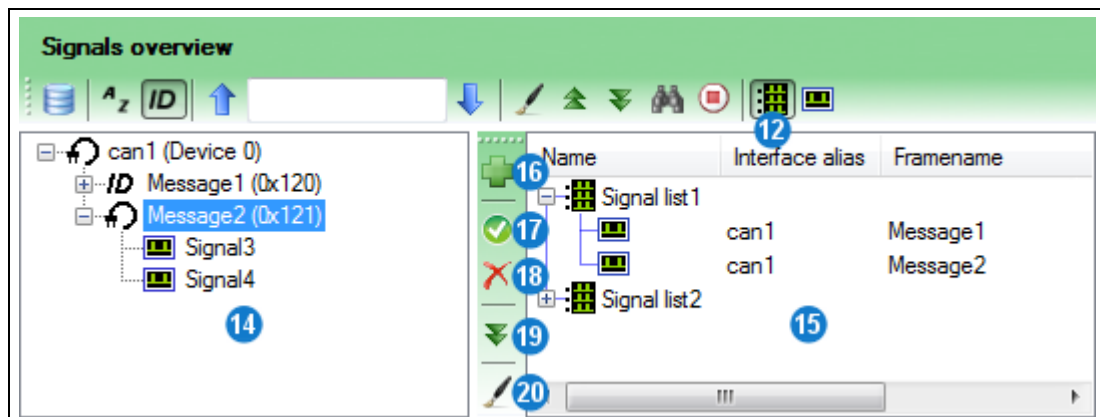

12	Manage signal lists	17	Add signal to list
14	Signals overview	18	Delete signal from list
15	Signal lists	19	Find signal
16	Add new signal list	20	Draw signal

Create new signal list:

- ▶ Click *Add new signal list* (16).

Add signal to signal list:

- ▶ Select the signal list (15).
- ▶ Select the signal in the signals overview (14).
- ▶ Click *Add signal to list* (17).

Delete signal from signal list:

- ▶ Select the signal in the signal list (15).
- ▶ Click *Delete signal from list* (18).

Delete signal list:

- ▶ Select the signal list (15).
- ▶ Click *Delete signal from list* (18).

Display signal from signal list (15) in the signals overview (14):

- ▶ Select the signal in the signal list (15).
- ▶ Click *Find signal* (19).

5.9.3 Search, filter and export

Use this panel to search the open measurement according to different criteria, filter records and export them to other output formats.

Tabs:

- Browse
- Event
- Find
- Interface
- Export

Browse:

Use this tab to specify search criteria to move to the corresponding records in the *Data* panel. In addition, you can manage the bookmarks list.

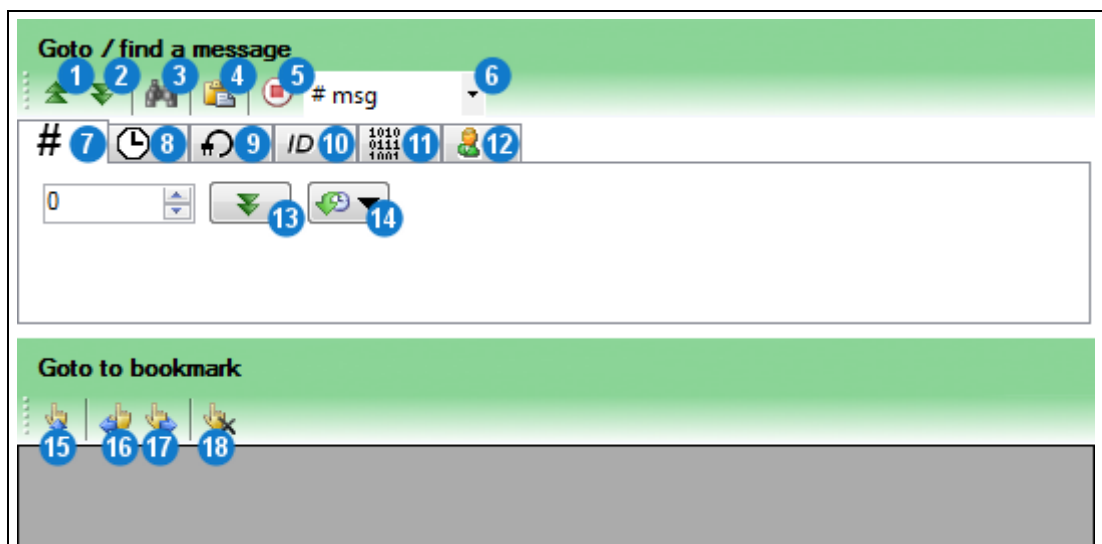

1	Previous	11	Search message by payload
2	Next	12	Search message by Interface, ID and payload
3	All since cursor		
4	Paste current selection value	13	Go to message
5	Cancel	14	History
6	Search criterion	15	Go to selected bookmark
7	Search message by number	16	Go to previous bookmark
8	Search message by date and time	17	Go to next bookmark
9	Search message by interface	18	Delete selected bookmark
10	Search message by ID		

Depending on the search criteria, the search condition is either unique or not.

You will find one record at the most when searching by:

- Message number **(7)**
- Date and time **(8)**

In certain circumstances, you may find multiple records in the search for:

- Messages of certain interfaces **(9)**
- Message IDs **(10)**
- Message payloads **(11)**
- Combination of the previous three **(12)**

To go to the (next) record that meets the desired search condition:

- ▶ Select search criteria from the tabs **(7)** to **(12)**.
or
- ▶ Select the corresponding criterion from the drop-down list **(6)**.
- ▶ Specify the search condition.
or
- ▶ Click *Paste current selection value* **(4)** to apply the value of the currently selected record.
- ▶ Click *Go to message* **(13)**.

Navigate between records:

- ▶ Click *Previous* **(1)** to go to the previous record found.
or
- ▶ Click *Next* **(2)** to go to the next record found.
or
- ▶ Click *All since cursor* **(3)** to display all records of this message, starting at the current position, in a list. (→ Search)

Cancel search:

- ▶ Click *Cancel* **(5)**.



History

Click *History* (14) to access the latest search conditions. This list is reset every time you exit the tool.



Bookmarks

To add a record to the bookmarks, right-click it in the *Data* panel and select the appropriate option.

Use the *Browse* tab to navigate between bookmarks or to delete them.

Event

This tab displays all events generated by the user or by the ML-N4000 itself. For example, events are triggered and stored by pressing the trigger button (B). (→ Connections and controls)

Event overview

Type	Nr	Timestamp	Title
	76	01.10.2019 14:46:38	Trigger (Rise)

1	Go to selected event	3	Go to next event
2	Go to previous event	4	Delete selected event

Search:

User this tab to build complex searches.

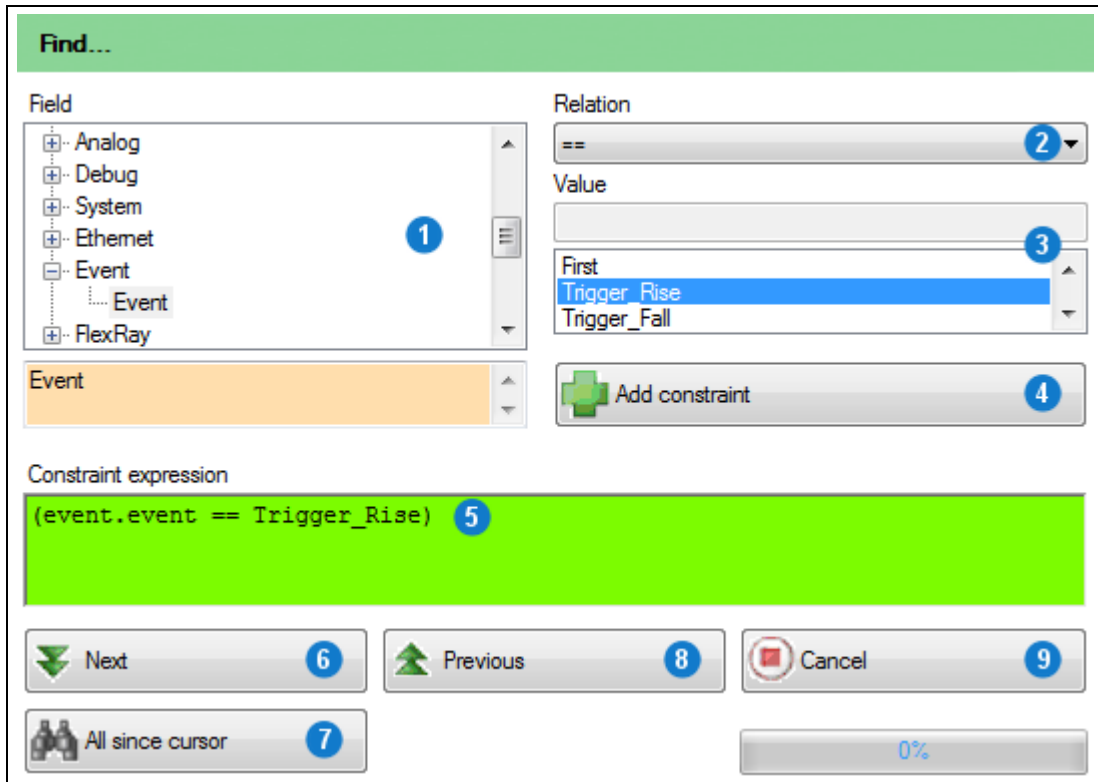

1	Field	6	Next
2	Relation	7	All since cursor
3	Value	8	Previous
4	Add constraint	9	Cancel
5	Constraint expression		

- ▶ Select the *Field* (1) that you would like to add to your search.
- ▶ Select the *Relation* (2) between field and value.
- ▶ Specify the *Value* (3). Depending on the field, this is either presented as a text box or as a drop-down list with all available values.
- ▶ Click *Add constraint* (4).
 - The condition is added to the *Constraint expression* (5).
- ▶ Repeat the above steps to add further constraints to the constraint expression.

Navigate between records:

- ▶ Click *Previous* (8) to go to the previous record found.
or
- ▶ Click *Next* (6) to go to the next record found.
or
- ▶ Click *All since cursor* (7) to display all records of this message, starting at the current position, in a list. (→ Search)

Cancel search:

- ▶ Click *Cancel* (9).

Interface:

Use this tab to filter the displayed records in the *Data* panel.

1	Start	5	Select FlexRay IDs
2	Cancel	6	Interfaces
3	Filter region	7	Interface channels
4	Select CAN IDs		

Filter options:

- Filter region (3)
 - WholeFile All records
 - FineZone Zone specified in the *Overview* tab of the *Graphical output* panel (→ Overview)
 - ScreenWide Records that are currently visible on the screen
- CAN IDs (4) and FlexRay IDs (5)
- Interfaces (6) and interface channels (7)

Apply filter:

- ▶ Add the desired filter.
 - ▶ Click *Start (1)*.
- Records in the *Data* panel are filtered.

Cancel filter:

- ▶ Click *Cancel (2)*.

Export:

Use this tab to export the records to various output formats.

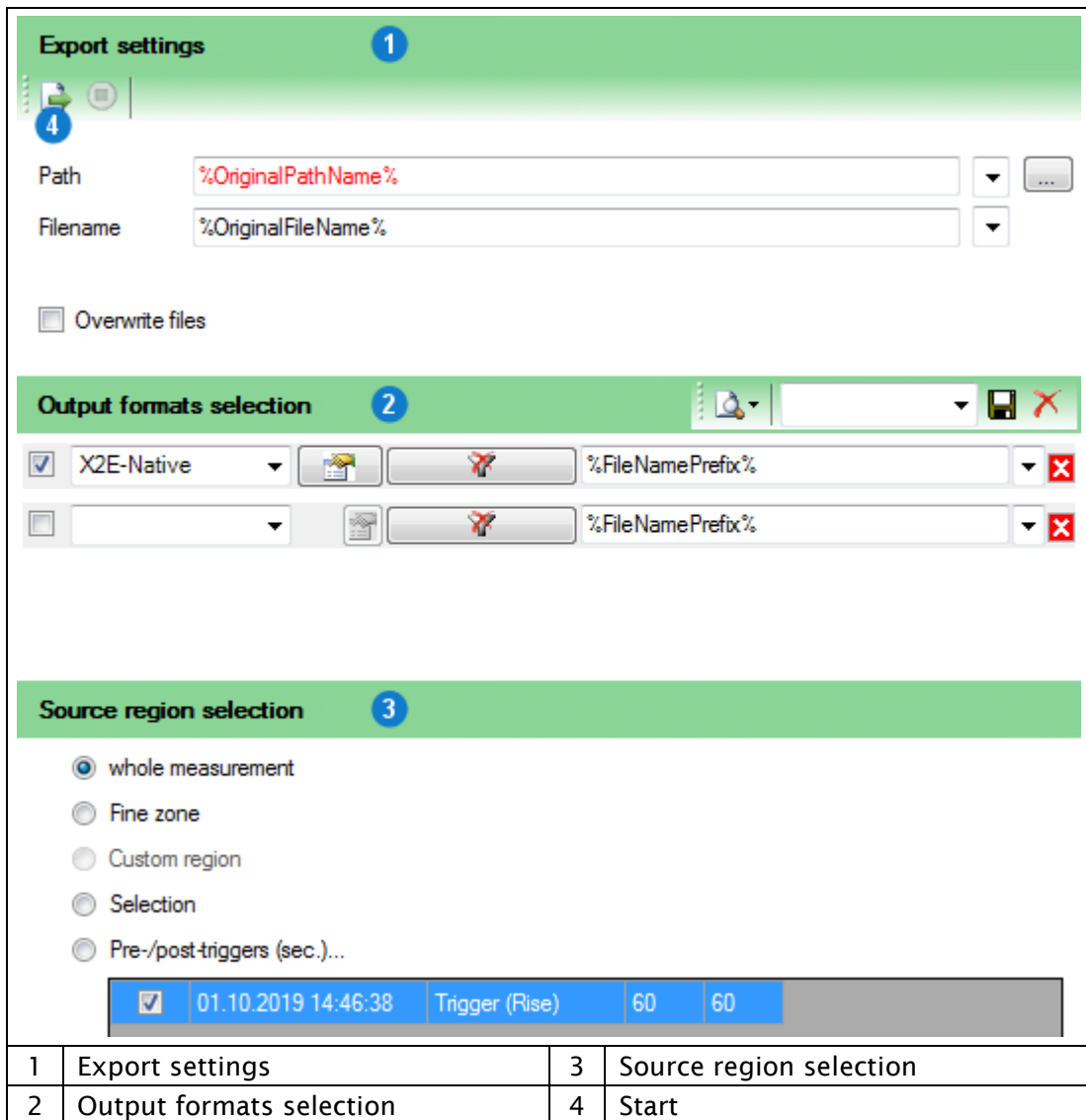

1	Export settings	3	Source region selection
2	Output formats selection	4	Start

Source region selection:

- Whole measurements All records
- Fine zone Zone specified in the *Overview* tab of the *Graphical output* panel (→ *Overview*)
- Custom region Region specified in the *Data* panel (→ *Data*)
- Selection Selected records
- Pre-/post-triggers (sec.) Period before and after raised triggers



Pre-/post-triggers

If this option is selected, you can double-click to change the time period before and after a trigger is raised.

Default values are configured in the *Hdd-Download* tool settings. (→ *Hdd-Download*)

Export records:

- ▶ Specify the export settings (1). (→ *Export settings*)
- ▶ Select the output formats (2). (→ *Output formats selection*)
- ▶ Select the source region (3).
- ▶ Click *Start* (4).

Selected records are exported.



Cancel export:

- ▶ Click *Cancel* (5).

5.9.4 Graphical output

This panel displays the open measurement graphically.

Tabs:

- Overview
- Graphic
- Video

Overview:

This tab displays the timeline of the opened measurement. Icons represent events, bookmarks and search results. You can also specify a Fine zone to filter the records to display and export.

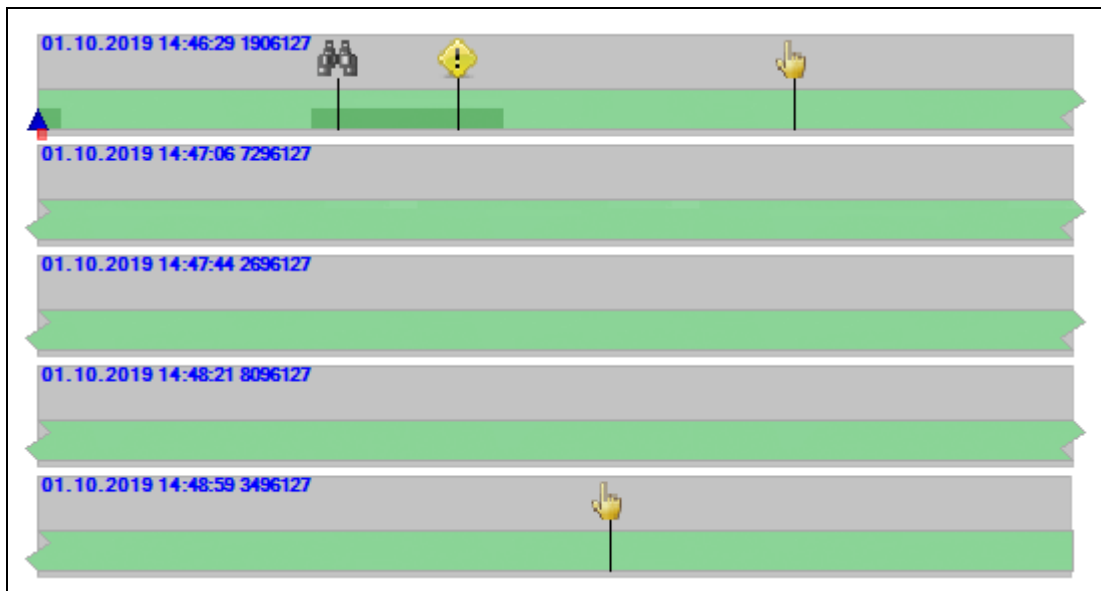

Set Fine zone:

- ▶ Click and drag over the area of the desired Fine zone.
 - ▶ Confirm your choice by clicking *<Set Fine Zone>*.
- The Fine zone is set.

Graphic:

This tab shows selected values of the open measurement as time curves.

Display data graphically:

- ▶ In the *Data* panel, right-click a record of the interface channel that you would like to see in graphical format. (→ Data)
- ▶ Point to *Draw signal*.
- ▶ Select the desired value.
 - The time curve of the value is displayed graphically. (→ Graph View)
- ▶ Repeat the above steps to add further values to the chart.



Draw message signals

Choose individual message signals in the *Signals* tab of the *Information* panel. (→ Signals)

5.10 Statistic

This tool allows the evaluation of statistical data during ML-N4000 operation, also simultaneous to data recording.

- ▶ Connect the ML-N4000 to the PC.
(→ Connecting the ML-N4000 to the PC)
- ▶ Turn on the ML-N4000.
- ▶ Start the *Statistic* tool of the XORAYASuite. (→ Starting)
- ▶ Connect to the desired ML-N4000. (→ Connecting the ML-N4000)

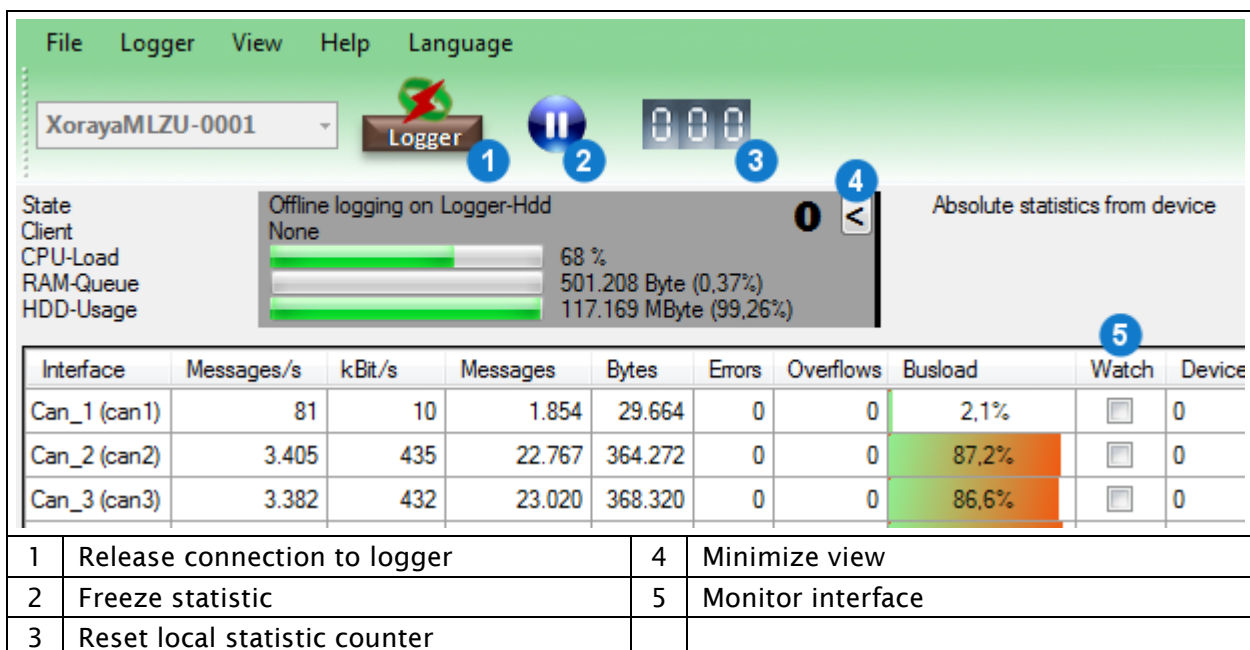

Interface	Messages/s	kBit/s	Messages	Bytes	Errors	Overflows	Busload	Watch	Device
Can_1 (can1)	81	10	1.854	29.664	0	0	2.1%	<input type="checkbox"/>	0
Can_2 (can2)	3.405	435	22.767	364.272	0	0	87.2%	<input type="checkbox"/>	0
Can_3 (can3)	3.382	432	23.020	368.320	0	0	86.6%	<input type="checkbox"/>	0

1	Release connection to logger	4	Minimize view
2	Freeze statistic	5	Monitor interface
3	Reset local statistic counter		

Monitor a specific interface individually:

- ▶ In the corresponding row, click the check box *Watch* (5).
 - The row is highlighted when messages are received.

The buttons in the toolbar change to reflect the current state of the statistic display:



Freeze statistic



Continue statistic



Display remote statistic counter

Statistic since the start of the tool and connection to the ML-N4000



Display local statistic counter

Statistic since last click on *Reset local statistic counter* **(3)**

5.11 Convert

This tool allows converting the log data recorded in the *X2E-Native* output format into various formats. (→ Output formats)

No ML-N4000 connection is necessary to do this.

- ▶ Start the *Convert* tool of the XORAYASuite. (→ Starting)

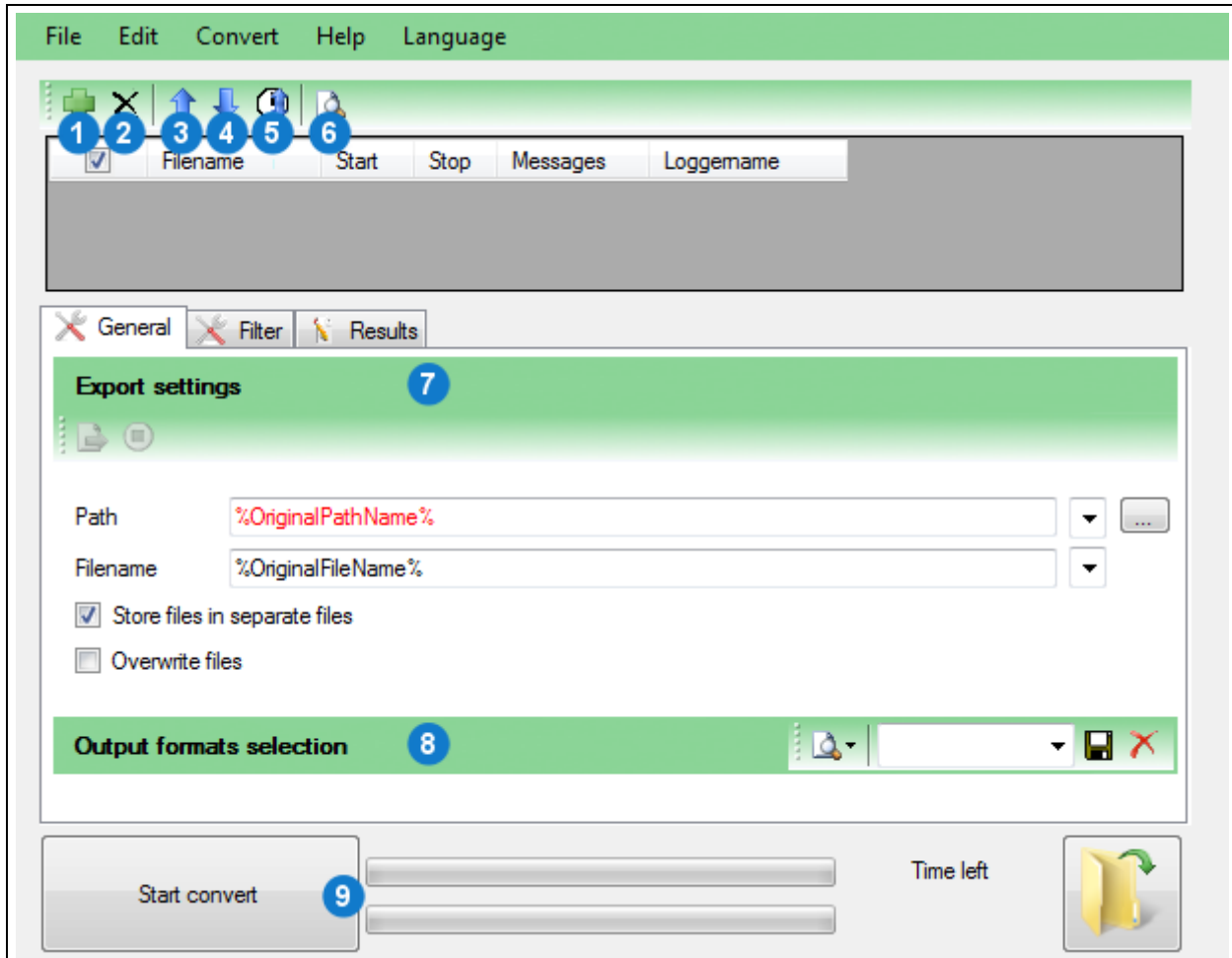

1	Add DLI file to list	6	Open selection in Viewer
2	Remove selected DLI files from list	7	Export settings
3	Move selection up	8	Output formats selection
4	Move selection down	9	Start convert
5	Auto sort by start time		

Add log files to the list:

- ▶ Click *Add DLI file to list* (1).
- ▶ Select the desired DLI file.
- ▶ Repeat as necessary for further log files.

Manually sort log files in the list:

- ▶ Select a row in the list.
- ▶ Click *Move selection up* (3).
- or*
- ▶ Click *Move selection down* (4).



Automatic sorting

Start and stop times of log files are displayed in red color if shown out of chronological order in the list.

Click *Auto sort by start time* (5) to sort the log files in chronological order.

View log files in the *Viewer* tool:

- ▶ Select one or multiple rows in the list by using the Shift and Ctrl key.
- ▶ Click *Open selection in Viewer* (6).

Select or deselect log files in the list:

- ▶ Select the relevant check boxes.
- or*
- ▶ Select or clear the check box in the table header to select all log files or none.
- or*
- ▶ In the *Edit* menu, click *Select all* or *Select none*.

Delete log files from the list:

- ▶ Select the log files to be deleted.
- ▶ Click *Remove selected DLI files from list* (2).



Filter messages

If necessary, you can reduce the number of messages to be converted using the *Filter* tab.

Convert log files:

- ▶ Select the log files to be converted.
- ▶ Specify the export settings (7). (→ Export settings)
- ▶ Select the output formats (8). (→ Output formats selection)
- ▶ Click *Start convert* (9).

or

- ▶ In the *Convert* menu, click *Start*.

Recorded log files are converted.

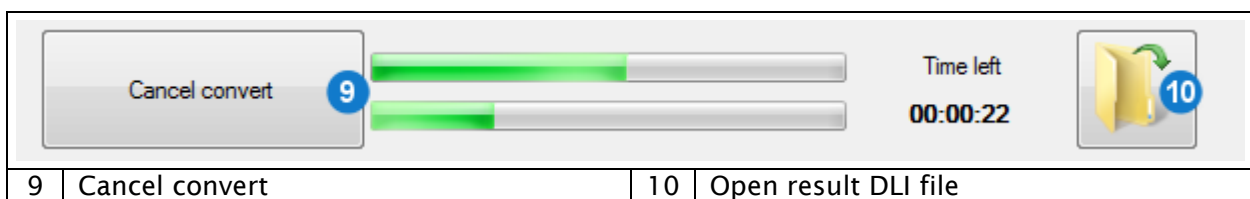

Cancel conversion:

- ▶ Click *Cancel convert* (9).
- or
- ▶ In the *Convert* menu, click *Cancel*.



Open converted files

After the successful conversion, click *Open result DLI file* (10) to open the path of the converted files in the Windows Explorer.

If you select the output format *X2E-Native*, you have the choice between opening the DLI files in the Explorer or directly in the *Viewer* tool for analysis purposes.

5.12 Firmware-Update

Use this tool to update the ML-N4000 firmware. The firmware update expands the ML-N4000 functionality and performs any required bug fixing.

- ▶ Connect the ML-N4000 to the PC. (→ Connecting the ML-N4000 to the PC)
- ▶ Turn on the ML-N4000.
- ▶ Start the *Firmware-Update* tool of the XORAYASuite. (→ Starting)
- ▶ Connect to the desired ML-N4000. (→ Connecting the ML-N4000)

1	Release connection to logger	3	Open SWU/XSWU file
2	Start Hdd logging	4	Launch firmware update

Perform firmware update

- ▶ Download the latest firmware version from the X2E-Wiki. (→ X2E-Wiki)
- ▶ Click *Open SWU/XSWU file (3)*.

or

- ▶ In the *File* menu, click *Open SWU/XSWU file*.
- ▶ Select the firmware file.
- ▶ Make sure that the file corresponds to the ML-N4000.
- ▶ Click *Launch firmware update (4)*.

- The firmware is updated.



CAUTION

Do not interrupt the update process

Power supply interruptions can destroy the ML-N4000.

- ▶ Do not interrupt the ML-N4000 power supply while updating the firmware.

- ▶ Confirm the ML-N4000 restart twice, if *Ask before restart* in the *Option* menu is activated.
- ▶ Confirm the formatting of the ML-N4000 storage medium that may be necessary for compatibility reasons.

- If *Skip restoring the configuration* in the *Option* menu is not activated, the tool tries to restore the last ML-N4000 configuration.



Repeat the firmware update:

- ▶ If the update fails, click button (5) to reset the user interface to the initial state.



Activate licenses

Activating and updating additionally acquired licenses for the ML-N4000 works in the same way. Instead of the firmware file, select the provided license file.



Firmware update via USB flash drive

Alternatively, you can also update the ML-N4000 firmware without the XorayaSuite. Connect a USB flash drive that contains the firmware archive in the *xoraya_update* folder to the USB host interface (K). (→ Connections and controls)

The ML-N4000 automatically updates the firmware and disconnects the USB flash drive afterwards.

5.13 TK Commandline

This tool provides access to the XORAYAToolkit, a collection of commands optimized for script-oriented application.

- ▶ Connect the ML-N4000 to the PC.
(→ Connecting the ML-N4000 to the PC)
- ▶ Turn on the ML-N4000.
- ▶ Start the *TK Commandline* tool of the XORAYASuite. (→ Starting)

You can access the XORAYAToolkit via TK Commandline.

```
Setting environment for using Xoraya-Cmdline tools
-----
XHelp      - Display list of available commands
XScan     - Search for Loggers in network
XLogfile  - Do online logging
XConvFile - Convert/Filter data files
XJoinFile - Join data files
XFileInfo - Display info about log file
XCmpFile  - Compare data between 2 interfaces
XHddDir   - Show contents of Logger hdd (sessions)
XHddGet   - Download Logger hdd (sessions)
XHddErase - Delete Logger hdd (sessions)
XHddLog   - Start/Stop offline logging on Logger hdd
XConfig   - Administrate Logger settings
XSend     - Send message(s) via Logger
XStat     - Show interface statistics of (used) Logger
XShutdown - Shutdown/Restart Logger
XFWUpdate - Update Logger firmware
XDateTime - Convert date/time formats
XHddDirM  - Show contents of Logger hdd (measurement)
XHddGetM  - Download Logger hdd (measurement)
XHddEraseM - Delete Logger hdd (measurement)
XLinuxation - Install Linux OS on Logger
XProfile  - Handle user profiles from Logger
use Option -? on each command to get help

C:\ProgramData\Microsoft\Windows\Start Menu\Programs\X2E\Xoraya_x32\Documenta
```

The following commands are available:

Tool	Function
XHelp	Displays the available commands
XScan	Scans the network for dataloggers
XLogFile	Starts data recording in online mode and writes log data in various output formats
XConvFile	Filters X2E-Native log files and converts them into different output formats
XJoinFile	Joins X2E-Native log files
XFileInfo	Displays information about X2E-Native log files
XCmpFile	Compares two X2E-Native log files
XHddDir	Displays the sessions on the ML-N4000 storage medium
XHddGet	Downloads sessions from ML-N4000 in various output formats
XHddErase	Deletes sessions from ML-N4000 or formats the storage medium
XHddLog	Starts/stops data recording in HDD mode or sets a snapshot
XConfig	Reads/overwrites the ML-N4000 configuration or compares two configurations
XSend	Sends CAN messages via the ML-N4000
XStat	Displays ML-N4000 statistics
XShutdown	Shuts down or restarts the ML-N4000
XFWUpdate	Performs a firmware update
XDateTime	Converts between different date and time formats or compares PC time with ML-N4000 time
XHddDirM	Displays the measurements on the ML-N4000 storage medium
XHddGetM	Downloads measurements from the ML-N4000 in various output formats
XHddEraseM	Deletes measurements from the ML-N4000 or formats the storage medium
XLinuxation	Performs a system recovery of the ML-N4000
XProfile	Manages the user profiles of the ML-N4000

5.14 Common elements

This section describes GUI elements used in different parts of the XORAYASuite albeit in substantially the same way.

This manual refers to subsections of this section as required.

5.14.1 Changing the numbering system

For numerical values in text boxes, you can switch the display between three numbering systems. Already entered values are converted accordingly if possible.



- ▶ Click the symbol of the numbering system (1).

or

- ▶ Right-click in the text box (2) and select the numbering system.

Abbreviations stand for the following numbering systems:

- 0x hexadecimal (base 16)
- Dec decimal (base 10)
- Bin Binary (base 2)

5.14.2 Set bits

In certain interface configuration categories, you specify the bytes of messages:

- CAN Trigger
- LIN Trigger
- Ethernet Filter

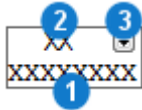

- ▶ Click an *X* in the bottom row of a byte (1) once or twice to set the desired bit to 0 or 1.
- ▶ Highlight an *X* in the top row of a byte (2) and enter one hexadecimal digit to specify the half-byte.
- ▶ Highlight *XX* in the top row of a byte (2) and enter two hexadecimal digits to specify the byte.
- ▶ If a byte is not fully defined, click the arrow (3) to display all possible values remaining for this byte.

5.14.3 Export settings

This control element can be found in the following tools: *Configuration*, *Online-Logging*, *Hdd-Download*, *Viewer* and *Convert*.

1	Download from ML-N4000*	4	Store sessions in separate files**
2	Attributes	5	Overwrite files
3	Browse for folder		

* Only in *Hdd-Download* ** Only in *Hdd-Download* and *Convert*

- ▶ Click *Browse for folder* (3) to select the *Path*.
(Path is not available in the *Configuration* tool, because the settings are saved on the ML-N4000 itself.)
- ▶ Enter the desired *Filename*.



Special attributes

You can automatically name the path and filename using special attributes. Select the desired attribute from the respective drop-down list (2).

Repeat the process to combine multiple attributes.

- ▶ Specify whether all selected sessions or DLI files are stored as separate files (4).
- ▶ Specify whether existing files with the same file name are overwritten (5).

5.14.4 Output formats selection

This control element can be found in the following tools: *Configuration*, *Hdd-Download*, *Viewer* and *Convert*.

1	Activate	6	Delete
2	Output format	7	Show log file of export filter
3	Filter settings	8	Export settings
4	Interface filter	9	Save this export setting
5	Attributes	10	Delete this export setting

Create export filters:

- ▶ Select the desired output format (2). (→ Output formats)
- ▶ Check the settings of the selected output format (3).
- ▶ Filter the exported interface channels (4).



Special attributes

You can also separately change the original filename for each export filter by means of special attributes. Select the desired attribute from the respective drop-down list (5).

Repeat the process to combine multiple attributes.

Create further export filters:

- ▶ Repeat as necessary for further table rows.
- ▶ Select the check boxes (1) for all export filters you want to apply.

Delete export filters:

- ▶ Click *Delete* (6).

In case of failure, open the log file of the export filter:

- ▶ Select the desired log file from *Show log file of export filter* (7).

Save export setting for later reuse:

- ▶ Enter a name in the text box *Export settings* **(8)**.
- ▶ Click *Save this export setting* **(9)**.

Load export setting:

- ▶ Select the desired export setting in *Export settings* **(8)**.

Delete export setting:

- ▶ Select the desired export setting in *Export settings* **(8)**.
- ▶ Click *Delete this export setting* **(10)**.

5.14.5 Signal selection

This control element can be found in the following tools: *Configuration* and *Online-Logging*. The right-side view is different depending on whether *Show signal details* (9) or *Manage signal lists* (8) is activated.

Show signal details (9) is activated:

1	Signal description settings	7	Add this signal
2	Sort alphabetically	8	Manage signal lists
3	Sort by ID	9	Show signal details
4	Find previous	10	Signals overview
5	Search box	11	Signal details
6	Find next		

Add signals to signals overview (10):

- ▶ Click *Signal description settings* (1).
- ▶ Add one or more description files to the current signal group.
(→ Signal description settings)

Sort the signals overview (10):

- ▶ Click *Sort alphabetically* (2) to sort by message name.
or
- ▶ Click *Sort by ID* (3) to sort by message ID.

Search by message, signal or ID in the signals overview (10):

- ▶ Enter the term or partial term in the search box (5).
- ▶ Click *Find previous* (4).
or
- ▶ Click *Find next* (6).

Display signal details (11):

- ▶ Select a message in the signals overview (10) to view details for all signals of this message.

or

- ▶ Select a signal to view details for this signal.

Add signal:

- ▶ Select the signal in the signal overview (10).

or

- ▶ Select the signal in the signal details (11).
- ▶ Click *Add this signal* (7).

Manage signal lists (8) is activated:

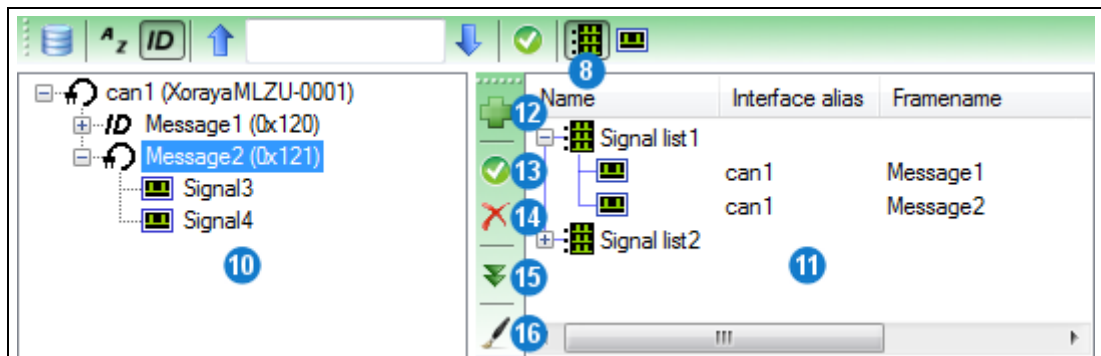

8	Manage signal lists	13	Add signal to list
10	Signals overview	14	Delete signal from list
11	Signal lists	15	Find signal
12	Add new signal list	16	Draw signal

Create new signal list:

- ▶ Click *Add new signal list* (12).

Add signal to signal list:

- ▶ Select the signal list (11).
- ▶ Select the signal in the signals overview (10).
- ▶ Click *Add signal to List* (13).

Delete signal from signal list:

- ▶ Select the signal in the Signal List (11).
- ▶ Click *Delete signal from list* (14).

Delete signal list:

- ▶ Select the signal list (11).
- ▶ Click *Delete signal from list* (14).

Display signal from signal list (11) in the signals overview (10):

- ▶ Select the signal in the signal list (11).
- ▶ Click *Find signal* (15).



Storage location for signals, signals overview and signal lists

Added signals are stored on the connected ML-N4000.

The signals overview and signal lists are stored on your PC, being thus available for the configuration of other dataloggers.

5.14.6 Signal description settings

This control element can be found in the following tools: *Configuration*, *Online-Logging* and *Viewer*.

Here, load description files and assign them to signal groups.

Supported description file types:

- DBC
- LDF
- FIBEX (XML)
- A2L
- AUTOSAR (ARXML)

	Interface Alias	Description file	Add	Del
▶	can1	C:\Users\User1\workspace\dbc	+	X
*			+	X

1	Add new signal group	6	Interface alias
2	Clone selected signal group	7	Description file
3	Delete selected signal group	8	Add
4	Set signal group as default	9	Delete
5	Signal groups		

5.14.7 Create trigger conditions

You use this control element to configure general signal triggers or triggers of the VIDEO, DiagCCP, DiagXCP and Event interfaces.

The following trigger types are available:

- Value compare Raise trigger if a single condition or combined conditions are met
- Signal list Raise trigger if the ML-N4000 detects one of these signals on the data buses

Value compare:

1	Apply trigger	7	Parenthesize selection
2	Cancel trigger configuration	8	Clear selection
3	Add condition	9	Signal
4	Remove condition	10	Relation
5	Move selection to right	11	Relation type
6	Move selection to left	12	Operator

The following *Relation types* (11) are available:

- ⁰¹¹₁₀₁ Signal value
- # Number of occurrences of this signal
- 🕒 Time since the last occurrence of this signal (in ms)

Add condition:

- ▶ Select an already configured *Signal* (9). (→ Settings)
- ▶ Select the *Relation* (10) between signal and value.
- ▶ Select the *Relation type* (11).
- ▶ Depending on the relation type, specify the *Raw value* or the time (in ms). (→ Changing the numbering system)

Combine multiple conditions:

- ▶ Click *Add condition* (3).
- ▶ Configure this condition as described above.
- ▶ Select the *Operator* (12) that combines this and the previous condition.
- ▶ If required, repeat the above steps to combine further conditions.



Operator precedence

According to the rules of Boolean algebra, the AND operator (&&) precedes the OR operator (||). You can influence precedence by parentheses.

Add parentheses:

- ▶ Click the desired conditions and operators to mark them blue.
- ▶ Click *Parenthesize selection* (7).
- or
- ▶ Click *Move selection to right* (5).

Remove parentheses:

- ▶ Click the desired conditions and operators to mark them blue.
- ▶ Click *Move selection to left* (6).



Visualization of parentheses

The GUI displays conditions of the same precedence level, meaning parenthesized conditions, also on the same horizontal level. The corresponding operator is connected to the left border.

Being further to the right is equivalent to a higher precedence. Therefore, *Parenthesize selection* (7) and *Move selection to right* (5) have the same effect.

Apply conditions:

- ▶ Select the *Execution time*.
 - ▶ If necessary, change the automatically generated *Description*.
 - ▶ Only for event triggers:
Under *Arguments*, specify the payload (32 bit) and the ID (8 bit) of the event message to be sent.
 - ▶ Click *Apply trigger (1)*.
- The value compare trigger is stored on the ML-N4000.

Signal list:

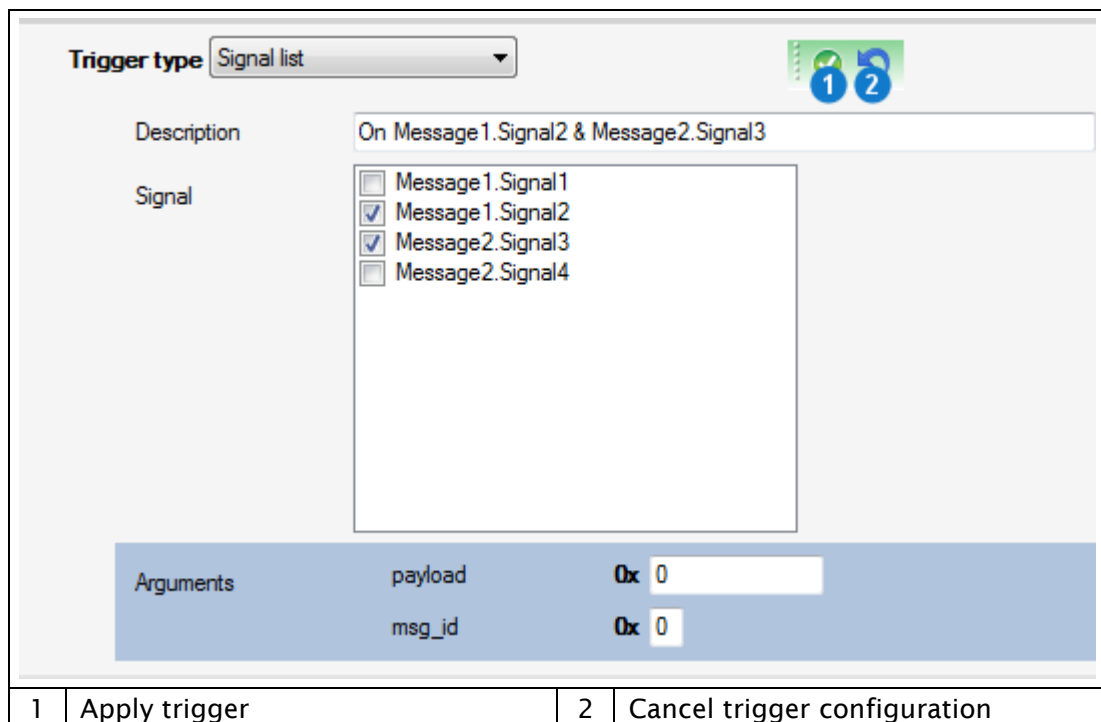

Trigger type: Signal list

Description: On Message 1.Signal2 & Message2.Signal3

Signal list:

- Message 1.Signal1
- Message 1.Signal2
- Message 2.Signal3
- Message 2.Signal4

Arguments:

payload	0x 0
msg_id	0x 0

1 Apply trigger 2 Cancel trigger configuration

Add signal list trigger:

- ▶ Select the check boxes of the desired signals.
 - ▶ If required, change the automatically generated *Description*.
 - ▶ Only for event triggers:
Under *Arguments*, specify the payload (32 bit) and the ID (8 bit) of the event message to be sent.
 - ▶ Click *Apply Trigger (1)*.
- The signal list trigger is stored on the ML-N4000.

5.14.8 Graph View

This control can be found in the following tools: *Online-Logging*, *Hdd-Download* and *Viewer*.

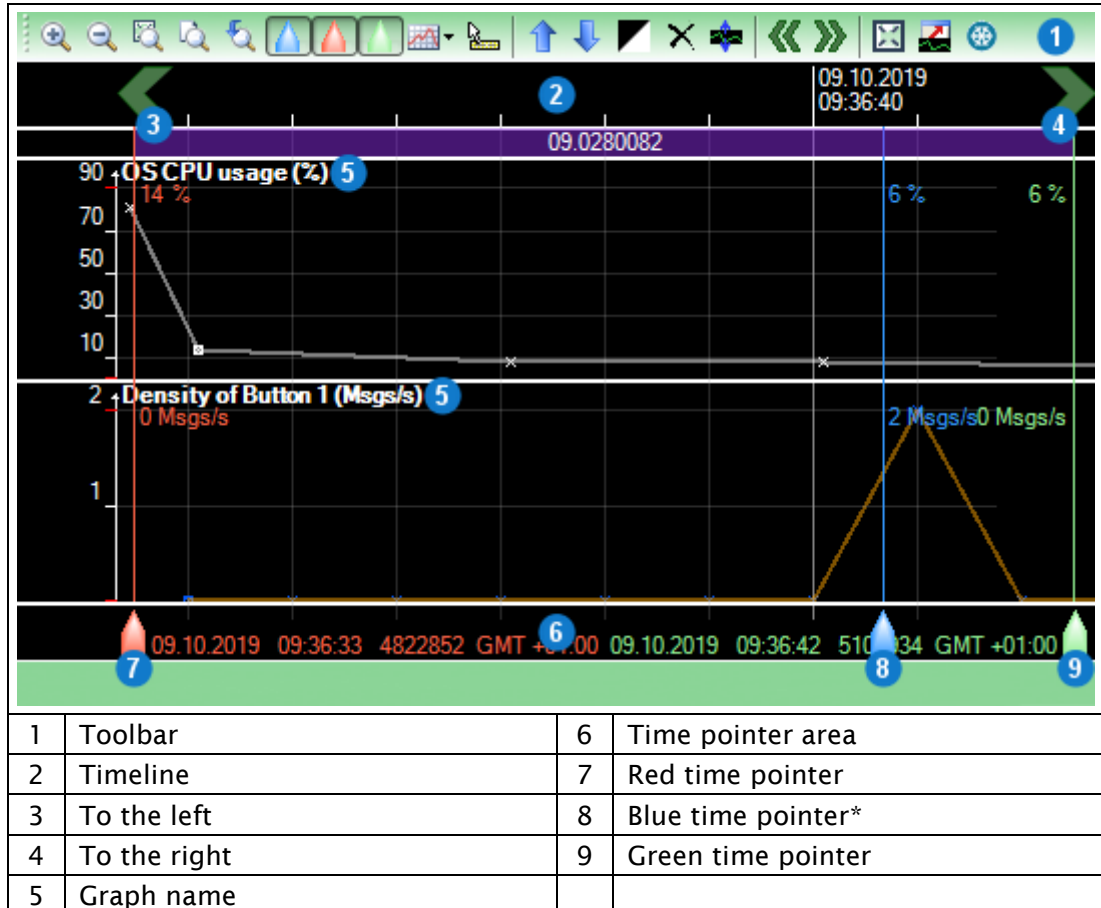





















* Only in *Viewer*

- ▶ Click and drag over an area to zoom in.
- ▶ Double-click to jump to the corresponding period in the *Data* panel of the *Viewer* tool.
- ▶ Click the timeline (2) to display arrows, which allow you to move in small steps to the left (3) and right (4).
- ▶ Click the respective graph title (5) to select that graph.
- ▶ Left-click in the time pointer area (6) to set the red time pointer (7).
- ▶ Right-click in the time pointer area (6) to set the green time pointer (9).

The blue time pointer (8) represents the currently selected record in the *Data* panel of the *Viewer* tool.

The following table describes the control elements on the toolbar (1) from left to right.

Symbol	Function
	Zoom in
	Zoom out
	Adjust the zoom level so that the Fine zone is visible
	Adjust the zoom level so that the entire measurement is visible
	Switch between previous and current zoom level
	Change the visibility of the blue time pointer, which represents the current position in the <i>Data</i> panel*
	Change the visibility of the red time pointer, which represents the left-clicked position.
	Change the visibility of the green time pointer, which represents the right-clicked position.
	Connect the graph points as lines, curves, stairs or do not connect Draw the graph points or not
	Display the time and value of the current mouse position next to the mouse pointer
	Move the selected graphs up
	Move the selected graphs down
	Switch color of background and labelling
	Close the selected graphs
	Display graphs over the full height of the window
	Move to previous time area
	Move to next time area
	Defines the currently visible time area as the Fine zone
	Open Graph View in separate window*
	Freeze graph drawing**

* Only in *Viewer* ** Only in *Online-Logging*

5.15 Output formats

The following table shows an overview of all output formats relevant for the ML-N4000 that you can select when downloading and converting log data.

Output format	File extension	Exported message types
X2E-Native	DLI/DLM/DLF/DLS	All
X2E Ascii	DLASC	All
Carmen-Journal (V3.0)	JRL	All
Wireshark PCAP	PCAP	Ethernet
Vector BLF	BLF/DBC	All
Vector ASC	ASC	All
XAA for GNLog	XAA	GNLog, RS-232, Event, System
DLT-Autosar (V4.0)	DLT	DLT, Event, System
System Events	TXT	Event, System
Raw for RS232/RawSocket	RAW	RS-232, RawSocket, Event
CSV for Analog/CCP/PSI5	CSV	DiagCCP, DiagXCP
CSV for Signals	SCSV/IFF	CAN and FlexRay signals
Video Extractor	JPG/MP4/H264	Video, Ethernet
MDF Export (V4.1)	MF4	DiagCCP and DiagXCP signals, Event



Custom output formats

You can write custom output formats with the XORAYASDK (Software Development Kit) and import them into the XORAYASuite.

For further information and sample code, please contact X2E.

The following sections describe the properties of each output format.

5.15.1 X2E-Native

Setting	Description	Default
NewDLlonMaxFileSizeReached	Create new info file (DLI) for each binary file (DLF)	Off
MaxFileSize_MB (x)	Maximum file size of a binary file (DLF) in MB	100
WriteStatistics	Create statistics file (DLS)	Off
CreateZIP	Store log files as a compressed ZIP archive	Off

5.15.2 X2E Ascii

Setting	Description	Default
ShowTimestamp	Write time stamp for each message	On
ShowCounter	Write counter for each message	On
ShowTimestampDelta	Write difference to the timestamp of the previous message	Off
ShowDebug	Write debug information	Off
ShowSystem	Write messages of the system interface	Off
ShowMediaConfig	Write entire configuration of the interface channels	On
ShowFormatDescription	Show basic message structure for each interface	On
ShowInterfaces	Show list of interfaces channels with internal ID, alias and BUS ID	On

5.15.3 Carmen-Journal

Setting	Description	Default
Generate one Journal including all Sessions	Write all selected sessions in one file	Off

5.15.4 Wireshark PCAP

Setting	Description	Default
FileFormat(TcpDump)	Use time stamp with microsecond resolution	On
FileFormat(NanoSecond)	Use time stamp with nanosecond resolution	Off
NewPCAPonMaxFileSizeReached	Create a new file when max file size is reached	Off
MaxFileSize_MB (x)	Maximum file size in MB	100

5.15.5 Vector BLF

Setting	Description	Default
UseCommonStartTimeStamp	Use common start timestamp	Off
WriteCANmsg4Trigger (x)	Write triggers as virtual CAN messages: <ul style="list-style-type: none"> ▪ User-defined or ▪ Automatically generated (compatible with CANoe) 	

5.15.6 Vector ASC

Setting	Description	Default
NewASConMaxFileSizeReached	Create a new file when max file size is reached	Off
MaxFileSize_MB (x)	Maximum file size in MB	100
WriteCarmenBusMapping	Write number and corresponding alias of the interface channels for further processing by CARMEN	Off
UseEcosCompatMode	Do not write falling edges of button triggers (possibly desired for compatibility reasons)	Off
WriteOneFilePerInterface	Write one file for each interface channel	Off
WriteCANmsg4Trigger (x)	Write triggers as virtual CAN messages: <ul style="list-style-type: none"> ▪ User-defined or ▪ Automatically generated (compatible with CANoe) 	

5.15.7 XAA for GNLog

Setting	Description	Default
NewXAAonMaxFileSizeReached	Create a new file when max file size is reached	Off
MaxFileSize_MB (x)	Maximum file size in MB	100

5.15.8 DLT-Autosar

Setting	Description	Default
ConnectionEvents	Write TCP connection events	Off
NewDLTonMaxFileSizeReached	Create a new file when max file size is reached	Off
MaxFileSize_MB (x)	Maximum file size in MB	100

5.15.9 System Events

Setting	Description	Default
Generate one Journal including all Sessions	Write all selected sessions in one file	Off

5.15.10 Raw for RS232/RawSocket

Setting	Description	Default
NewRAWonMaxFileSizeReached	Create a new file when max file size is reached	Off
MaxFileSize_MB (x)	Maximum file size in MB	100
Extension (x)	File extension	raw
TimestampPrefix	Write timestamp prefix for each message	Off
AllowMarker	Write events as markers Requirements: <ul style="list-style-type: none"> ▪ <i>TimestampPrefix</i> must be <i>On</i> ▪ Event interface must be enabled in the export filter 	Off

5.15.11 CSV for Analog/CCP/PSI5

Setting	Description	Default
WriteTrigger	Write triggers	Off
WriteButtonFallAsTrigger	Write falling edges of button triggers	Off
WriteButtonRiseAsTrigger	Write rising edges of button triggers	Off
WriteOneFile	Write all messages in one file instead of a separate one for each channel	Off

5.15.12 CSV for Signals

Setting	Description	Default
Raster	If multiple signal messages occur within this interval (in ms), the last value is used 0: Disabled	0
AddSignalDefinition (x)	Add custom signal list (→ Signal selection)	
NewSCSVonMaxFileSizeReached	Create a new file when max file size is reached	Off
IFF-Format	Use IFF file format instead of SCSV	Off
ExportRawValue	Write raw data values of the signals	On

5.15.13 Video Extractor

Setting	Description	Default
DoJPEG	Write images in JPEG format	On
DoMPEG	Write videos in MPEG-2 format	On
DoH264	Write videos in MPEG-4/H.264 format	Off

5.15.14 MDF Export

Setting	Description	Default
a2l_file_alternative_path (x)	Alternative path for A2L file	
TimezoneOffsets_min (x)	Time difference to UTC in minutes: <Timezone> <Summertime>	0 0
NewFileOnMaxFileSizeReached	Create a new file when max file size is reached	Off
MaxPartFileSizeMegaBytes (x)	Maximum file size in MB	100
DTBlockSizeMegaBytes (x)	Size of a data block in MB	1
compression	Enable compression	Off
AddSignalDefinition (x)	Add custom signal list (→ Signal selection)	
AddSignalDefinitionToFiles	Write a separate file for each signal of the added signal list	Off

6 Maintenance

6.1 Safety measures



DANGER

Electric shock caused by damage to components

Any damage to the ML-N4000, power source or power supply cable may cause an electric shock.

- ▶ Switch on the ML-N4000 only if all components appear undamaged.
 - ▶ Only commission the ML-N4000 after a proper installation or repair.
 - ▶ Check the power cable regularly for defects to prevent damage to the power source.
 - ▶ Always install the ML-N4000 in de-energized status.
-



CAUTION

Device damage due to short circuit

Bent connector pins pose a short circuit risk. This can lead to abnormal behavior or destruction of the ML-N4000.

Likewise, devices connected to the measurement setup may be also compromised.

- ▶ Make sure that connector pins are not bent.
 - ▶ Check the ML-N4000 regularly for any deficiencies.
-



CAUTION

Safety defects due to incorrect accessories and spare parts

Accessories and spare parts that have not been recommended by X2E GmbH negatively affect the safety, functionality and precision of the ML-N4000.

X2E GmbH shall assume no responsibility whatsoever or honor any warranty for damages arising from non-recommended accessories and spare parts or incorrect use.

- ▶ Use only accessories recommended by X2E GmbH and original spare parts.
-

6.2 Cleaning



CAUTION

Device damage due to pollution

Avoid any contamination in plugs and sockets to ensure a reliable contact.

- ▶ Keep the ML-N4000 clean.



CAUTION

Device damage due to penetration of dust or liquids

Dust or moisture inside the ML-N4000 may cause abnormal behavior or destruction of the device.

- ▶ Only operate the ML-N4000 with a closed housing.
- ▶ Do not operate the ML-N4000 outdoors.
- ▶ Do not operate the ML-N4000 outside the specified temperature range.
- ▶ Turn off the ML-N4000 and disconnect it from the power supply before you start cleaning.

Observe the following instructions to prevent damage to the ML-N4000:

- ▶ If necessary, clean the ML-N4000 with a damp, soft, lint-free cloth.
- ▶ Make sure that no moisture penetrates into the housing.
- ▶ Use only clear water and a mild detergent to moisten the cloth. Avoid sprays, solvents, alcohol or abrasive cleaners.
- ▶ Only reconnect the ML-N4000 to the power supply if the housing appears completely dry.

6.3 Repair



CAUTION

Device damage due to device opening

Unauthorized opening of the ML-N4000 can lead to abnormal behavior or destruction of the device.

- ▶ Never open the ML-N4000.
 - ▶ Contact X2E GmbH should maintenance and repairs be required.
-

Upon malfunction or defect, return the ML-N4000 without any accessories to X2E GmbH. You can find the address on page 2 of this manual.

Before submission, please take the following measures:

- ▶ Clean the ML-N4000. (→ Cleaning)
- ▶ Pack the ML-N4000 safely in its original packaging.
- ▶ Include the completed return form. You can download this form from the X2E Wiki or receive via email upon request to xoraya-return@x2e.de.

7 Storage, transport and disposal

7.1 Storage

If the ML-N4000 will remain unused for an extended time, we recommend storing it in the original packaging.

Adopt the following precautions to avoid damage to the ML-N4000:

- ▶ Protect the ML-N4000 from intense sun, heat, as well as from severe shocks.
- ▶ Do not place heavy objects on the ML-N4000.
- ▶ Store the ML-N4000 in a dry, dust-free and ESD safe area.

7.2 Transport

Transport the ML-N4000 only in the original packaging.

7.3 Disposal

The Electrical and Electronic Equipment Act (ElektroG), which applies in Germany, obliges every manufacturer to create a reasonable option for returning old B2B devices.

X2E cannot take back so-called historical devices that were placed on the market before August 15th, 2018. In this case, the customer is responsible for professional disposal.

Return of old X2E devices

Old devices can be returned at the customer's expense to the following address:

X2E GmbH
Grosse Ahlmuehle 19
76865 Rohrbach
Germany
Phone: +49 6349 99599 211
E-mail: sales@x2e.de

If more than 10 devices are returned at the same time, X2E must be informed in advance by the customer via the above e-mail address.

Old devices to be returned must be clearly marked by the customer with the words "Disposal" or "Entsorgung".

Disposal of batteries

If the products contain batteries or lamps that can be removed from the old device without destroying them, you as the end user are legally obliged to remove them before disposal and dispose of them separately.

Deletion of personal data

X2E expressly points out that the customer is responsible for deleting personal data on the devices to be disposed of.

Meaning of the symbol on the device

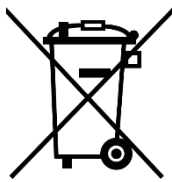

The crossed-out wheeled bin symbol on the device means that it must not be disposed of with household waste.

8 Appendix

8.1 Technical data

The following table provides an overview of technical data and properties of the ML-N4000.

Property	Value/Characteristic
Timestamp resolution	100 ns for all interfaces
Storage capacity	Max. 480 GB
Operating ambient temperature	-40 bis +60 °C (prior to Rev. 4.0) -40 bis +65 °C (since Rev. 4.0)
Air humidity	10 to 95 % (non-condensing)
Supply voltage	12 V DC (temporarily from 6 to 32 V)
Current consumption	(12 V, standard configuration, everything connected) <ul style="list-style-type: none"> ▪ PCAPs are charged: max. 1 A ▪ PCAPs are not charged: max. 3.3 A (until about 10 s after power on)
Standby current consumption	Max. 1 mA (at 12 V)
Dimensions (H x W x D)	65 x 165 x 165 mm
Housing protection type	IP 20, NEMA Type 1
Pollution degree	Pollution degree 3
Altitude	Max. 2000 m
Automatic sleep mode	Wakeable interfaces and signals: <ul style="list-style-type: none"> ▪ CAN ▪ LIN ▪ RS-232 ▪ Wake input ▪ Trigger
Recording modes	<ul style="list-style-type: none"> ▪ Over TCP/IP on the PC ▪ On internal storage medium or externally on XORAYA ESU ▪ Combination of both modes
Allowed voltage on additional ports	<ul style="list-style-type: none"> ▪ USB Host: 0 to +6 V ▪ eSATA: 0 V DC

8.2 ML-N4000 pin assignments

The following tables show the pin assignments of the log interfaces and of the power/trigger/wake port. Figures show the external view of the ML-N4000 contacts.

8.2.1 4x CAN

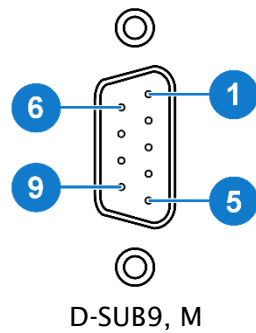

Pin	Function
1	CAN 3 Low
2	CAN 1 Low
3	CAN 4 Low
4	CAN 2 Low
5	CAN 3 High
6	CAN 4 High
7	CAN 1 High
8	CAN 2 High

8.2.2 2x FlexRay

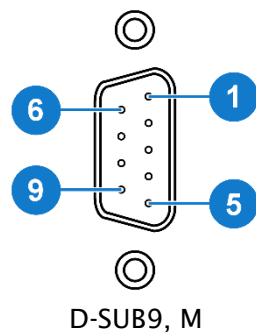

Pin	Function
2	FR BM A
3	GND
4	FR BM B
7	FR BP A
8	FR BP B

8.2.3 7x LIN

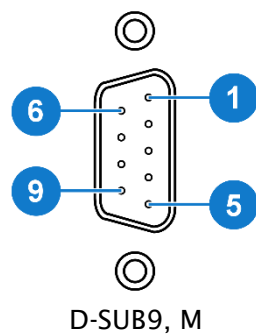

Pin	Function
1	LIN 1
2	LIN 2
3	LIN 3
4	LIN 4
5	GND
6	LIN 5
7	LIN 6
8	LIN 7
9	VBAT

8.2.4 8x RS-232

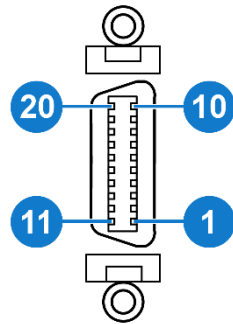

3M, 10220-5212 PL
(+ 2x spacer bolt: 3M, 3341-31)

Pin	Function
1	RX 8
2	TX 8
3	RX 7
4	TX 7
5	RX 6
6	TX 6
7	RX 5
8	TX 5
9	RX 4
10	TX 4
11	GND
12	TX 1
14	RX 1
16	TX 2
18	RX 2
19	RX 3
20	TX 3

8.2.5 6x Analog

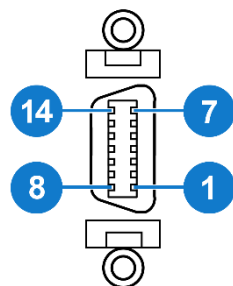

3M, 10214-5212 PL
(+ 2x spacer bolt: 3M, 3341-31)

Pin	Function
1	A 6 N
2	A 5 N
3	A 6 P
4	A 5 P
5	A 4 N
6	-
7	A 4 P
8	A 3 N
9	A 2 N
10	A 3 P
11	A 2 P
12	A 1 N
13	-
14	A 1 P

8.2.6 12x Base-T1

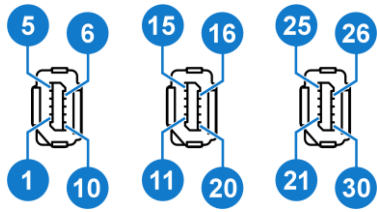

3x HARTING ix Industrial type A

Pin	Function
1	CH 2 P
2	CH 2 N
3	GND
4	CH 4 P
5	CH 4 N
6	CH 1 P
7	CH 1 N
8	GND
9	CH 3 P
10	CH 3 N
11	CH 6 P
12	CH 6 N
13	GND
14	CH 8 P
15	CH 8 N
16	CH 5 P
17	CH 5 N
18	GND
19	CH 7 P
20	CH 7 N
21	CH 10 P
22	CH 10 N
23	GND
24	CH 12 P
25	CH 12 N
26	CH 9 P
27	CH 9 N
28	GND
29	CH 11 P
30	CH 11 N

8.2.7 Power/trigger/wake

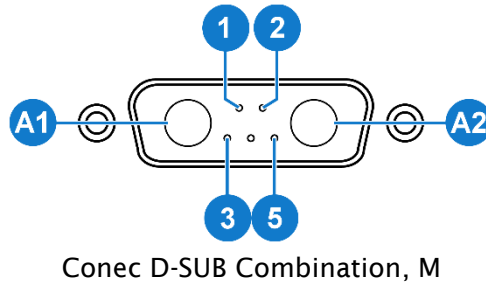

Pin	Function
A1	GND
A2	VIN
1	-
2	Wake
3	Trigger/Wake GND
4	Trigger
5	-

8.3 Cable pin assignments

The following pin assignments refer to the cables manufactured by X2E GmbH: on the left, you see the connection on the ML-N4000 side and on the right, one or more connectors in the measurement environment or to the power supply. Figures always show the external view of the contacts.

The # sign is a placeholder for the number of the respective interface channel or port.

8.3.1 4x CAN

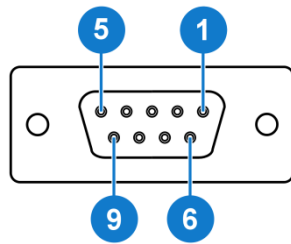

Pin	Function
1	CAN 3 Low
2	CAN 1 Low
3	CAN 4 Low
4	CAN 2 Low
5	CAN 3 High
6	CAN 4 High
7	CAN 1 High
8	CAN 2 High

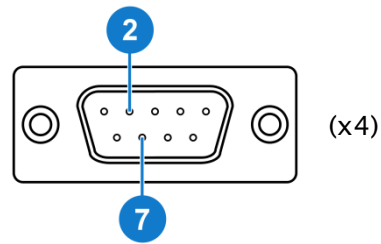

Pin	Function
2	CAN # Low
7	CAN # High

8.3.2 2x FlexRay

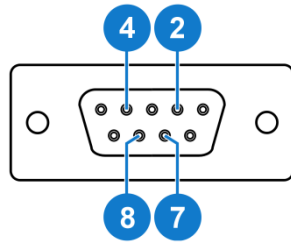

Pin	Function
2	FR BM A
3	GND
4	FR BM B
7	FR BP A
8	FR BP B

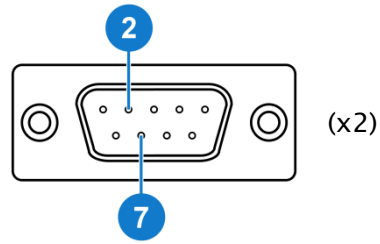

Pin	Function
2	FR BM A/B
7	FR BP A/B

8.3.3 7x LIN

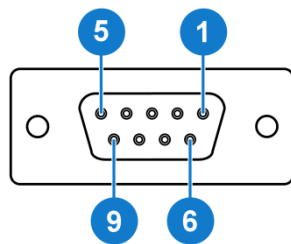

Pin	Function
1	LIN 1
2	LIN 2
3	LIN 3
4	LIN 4
5	GND
6	LIN 5
7	LIN 6
8	LIN 7
9	VBAT



Color	Function
Yellow	LIN #
Red	VBAT
Black	GND

8.3.4 8x RS-232

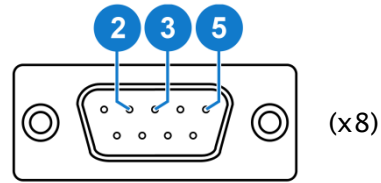
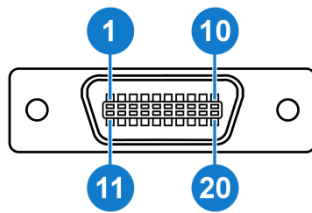

Pin	Function
1	RX 8
2	TX 8
3	RX 7
4	TX 7
5	RX 6
6	TX 6
7	RX 5
8	TX 5
9	RX 4
10	TX 4
11	GND*
12	TX 1
13	GND*
14	RX 1
16	TX 2
18	RX 2
19	RX 3
20	TX 3

Pin	Function
2	RX #
3	TX #
5	GND

* Pin 11 connected to pin 13 within the cable (GND)

8.3.5 Power/trigger/wake

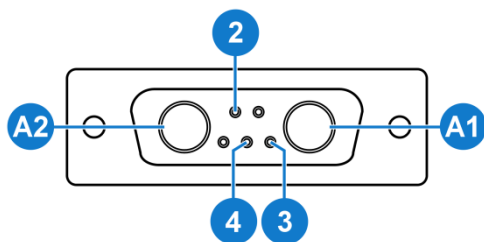

Pin	Function
A1	GND
A2	VIN
2	Wake
3	Trigger/Wake GND
4	Trigger

Color	Function
Black	GND
Red	VIN
Yellow	Wake
Black	Trigger/Wake GND
Green	Trigger

Declaration of conformity



X2E GmbH
Entwicklungszentrum
Jahnstr. 2b
76870 Kandel
Tel. +49 7275 9143 100
Fax +49 7275 9143 109

Declares the conformity for the product

Product name:

DATENLOGGER XORAYA ML-N4000

According to the following requirements:

EMC Directive 2014/30/EU

OF THE EUROPEAN PARLIAMENT AND OF THE COUNCIL
of 26 February 2014 on the harmonisation of the laws of the Member States relating to
electromagnetic compatibility and repealing Directive 2004/108/EC.

The following standards have been applied:

DIN EN 61326-1 :2013

DIN EN 55011 :2016 + A1:2017

DIN EN 61000-4-2 :2009

DIN EN 61000-4-3 :2006 + A1:2008 + A2:2010

DIN EN 61000-4-4 :2012

DIN EN 61000-4-6 :2009

IEC 62368-1 :2012

Signature: / Position in company:

Kandel 09.01.2020
Place and date:

IEC SYSTEM FOR MUTUAL RECOGNITION OF TEST CERTIFICATES FOR ELECTRICAL EQUIPMENT (IECEE) CB SCHEME

CB TEST CERTIFICATE

Product	Data logging Unit
Name and address of the applicant	X2E GmbH Jahnstr. 2 b 76870 Kandel, Deutschland
Name and address of the manufacturer	X2E GmbH Jahnstr. 2 b 76870 Kandel, Deutschland
Name and address of the factory	X2E GmbH Jahnstr. 2 b 76870 Kandel, Deutschland
Ratings and principal characteristics	DC 12V; 3.3A; class III
Trademark (if any)	X2E
Customer's Testing Facility (CTF) Stage used	
Model / Type Ref.	XORAYA ML-N4000
Additional information (if necessary may also be reported on page 2)	This report has also a second report number 1-8402/19-01-06 for CBTL CTC advanced internal use.
A sample of the product was tested and found to be in conformity with	IEC 62368-1:2014 for national deviations see test report
As shown in the Test Report Ref. No. which forms part of this Certificate	60282497 001

This CB Test Certificate is issued by the National Certification Body



TÜV Rheinland LGA Products GmbH
Tillystraße 2 · 90431 Nürnberg, Germany
Phone + 49 221 806-1371
Fax + 49 221 806-3935
Mail: cert-validity@de.tuv.com
Web: www.tuv.com



Date: 16.01.2020

Signature:

Dipl.-Ing. A. [Signature]



Ref. Certif. No.

DE 2-026757-M1

IEC SYSTEM FOR MUTUAL RECOGNITION OF TEST CERTIFICATES FOR ELECTRICAL EQUIPMENT (IECEE) CB SCHEME

CB TEST CERTIFICATE

Product

Data logging Unit

Name and address of the applicant

X2E GmbH
Große Ahlmühle 19
76865 Rohrbach, Deutschland

Name and address of the manufacturer

X2E GmbH
Große Ahlmühle 19
76865 Rohrbach, Deutschland

Name and address of the factory

X2E GmbH
Große Ahlmühle 19
76865 Rohrbach, Deutschland

Ratings and principal characteristics

DC 12V; 3.3A; class III

Trademark (if any)

X2E

Customer's Testing Facility (CTF) Stage used

N/A

Model / Type Ref.

XORAYA ML-N4000 (Configuration 0200_0600_0300)

Additional information (if necessary may also be reported on page 2)

- Change of address of applicant, manufacturer and factory
- Addition of suffix to model number
- Change of Hardware configuration
- See also testreport 60282497 001

A sample of the product was tested and found to be in conformity with

IEC 62368-1:2014
for national differences see test report

As shown in the Test Report Ref. No. which forms part of this Certificate

60282497 002

This CB Test Certificate is issued by the National Certification Body



TÜVRheinland®

TÜV Rheinland LGA Products GmbH
Tillystr. 2, 90431 Nürnberg, Germany
Phone + 49 221 806-1371
Fax + 49 221 806-3935
Mail: cert-validity@de.tuv.com
Web : www.tuv.com

Date: 2021-10-08

Signature:

Bernd Pösl

TCB

**GRANT OF EQUIPMENT
AUTHORIZATION**

TCB

**Certification
Issued Under the Authority of the
Federal Communications Commission
By:**

**CTC advanced GmbH
Untertuerkheimer Strasse 6-10
66117 Saarbruecken,
Germany**

**Date of Grant: 12/03/2021
Application Dated: 12/03/2021**

**X2E GmbH
Grosse Ahlmuehle 19
Rohrbach, 76865
Germany**

Attention: Gerhard Spengler

NOT TRANSFERABLE

EQUIPMENT AUTHORIZATION is hereby issued to the named GRANTEE, and is VALID ONLY for the equipment identified hereon for use under the Commission's Rules and Regulations listed below.

FCC IDENTIFIER: 2AU4HML-N4000
Name of Grantee: X2E GmbH
Equipment Class: Part 15 Class B Digital Device
Notes: Data logger

<u>Grant Notes</u>	<u>FCC Rule Parts</u>	<u>Frequency Range (MHZ)</u>	<u>Output Watts</u>	<u>Frequency Tolerance</u>	<u>Emission Designator</u>
	15B				

Class II Permissive Change due to hardware changes.



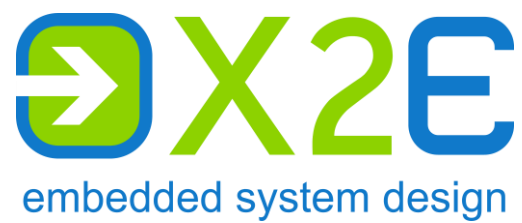

X2E GmbH
Grosse Ahlmuehle 19
76865 Rohrbach
Germany

Phone	+49 6349 99599 200
E-mail	xoraya@x2e.de
Internet	www.x2e.de
Wiki	wiki.x2e.de