

# FCC Radio Test Report

## FCC ID: 2AU49-DA16200MC

This report concerns: Original Grant

**Project No.** : 1910C136  
**Equipment** : WiFi Module  
**Brand Name** : Dialog  
**Test Model** : DA16200MOD-AAC4WA32  
**Series Model** : N/A  
**Applicant** : Dialog Semiconductor Korea Inc.  
**Address** : 7th SiliconPark, 35, Pangyo-ro 255 beon-gil, Bundang-gu, Seongnam-si, Gyeonggi-do (Zip 13486), Korea  
**Manufacturer** : Iton Technology Corp.  
**Address** : 7 Floor East, Building C, Shenzhen International Innovation Center, No. 1006 Shennan Road, Futian District, Shenzhen, China  
**Factory** : Iton Technology Corp.  
**Address** : Building E, Weixinda Industrial Park, Ainan Road 95, Longgang District, Shenzhen, Guangdong Province, China  
**Date of Receipt** : Oct. 31, 2019  
**Date of Test** : Nov. 04, 2019 ~ Nov. 23, 2019  
**Issued Date** : Feb. 19, 2020  
**Report Version** : R01  
**Test Sample** : Engineering Sample No.: DG2019110416  
**Standard(s)** : FCC Part15, Subpart C (15.247)  
ANSI C63.10-2013  
FCC KDB 558074 D01 15.247 Meas Guidance v05r02  
FCC KDB 662911 D01 Multiple Transmitter Output v02r01

The above equipment has been tested and found compliance with the requirement of the relative standards by BTL Inc.

*Vincent Tan*

Prepared by : Vincent Tan

*Ethan Ma*

Approved by : Ethan Ma



Certificate #5123.02

Add: No.3, Jinshagang 1st Road, Shixia, Dalang Town, Dongguan, Guangdong, China.

Tel: +86-769-8318-3000

Web: [www.newbtl.com](http://www.newbtl.com)

**Declaration**

**BTL** represents to the client that testing is done in accordance with standard procedures as applicable and that test instruments used has been calibrated with standards traceable to international standard(s) and/or national standard(s).

**BTL's** reports apply only to the specific samples tested under conditions. It is manufacture's responsibility to ensure that additional production units of this model are manufactured with the identical electrical and mechanical components. **BTL** shall have no liability for any declarations, inferences or generalizations drawn by the client or others from **BTL** issued reports.

The report must not be used by the client to claim product certification, approval, or endorsement by NVLAP, NIST, A2LA, or any agency of the U.S. Government.

This report is the confidential property of the client. As a mutual protection to the clients, the public and ourselves, the test report shall not be reproduced, except in full, without our written approval.

**BTL's** laboratory quality assurance procedures are in compliance with the **ISO/IEC 17025** requirements, and accredited by the conformity assessment authorities listed in this test report.

**BTL** is not responsible for the sampling stage, so the results only apply to the sample as received.

The information, data and test plan are provided by manufacturer which may affect the validity of results, so it is manufacturer's responsibility to ensure that the apparatus meets the essential requirements of applied standards and in all the possible configurations as representative of its intended use.

**Limitation**

For the use of the authority's logo is limited unless the Test Standard(s)/Scope(s)/Item(s) mentioned in this test report is (are) included in the conformity assessment authorities acceptance respective.

Please note that the measurement uncertainty is provided for informational purpose only and are not use in determining the Pass/Fail results.

<b>Table of Contents</b>	<b>Page</b>
<b>REPORT ISSUED HISTORY</b>	<b>6</b>
<b>1 . SUMMARY OF TEST RESULTS</b>	<b>7</b>
1.1 TEST FACILITY	8
1.2 MEASUREMENT UNCERTAINTY	8
1.3 TEST ENVIRONMENT CONDITIONS	8
<b>2 . GENERAL INFORMATION</b>	<b>9</b>
2.1 GENERAL DESCRIPTION OF EUT	9
2.2 DESCRIPTION OF TEST MODES	10
2.3 DUTY CYCLE	11
2.4 BLOCK DIAGRAM SHOWING THE CONFIGURATION OF SYSTEM TESTED	12
2.5 SUPPORT UNITS	12
<b>3 . AC POWER LINE CONDUCTED EMISSIONS TEST</b>	<b>13</b>
3.1 LIMIT	13
3.2 TEST PROCEDURE	13
3.3 DEVIATION FROM TEST STANDARD	13
3.4 TEST SETUP	14
3.5 EUT OPERATION CONDITIONS	14
3.6 TEST RESULTS	14
<b>4 . RADIATED EMISSIONS TEST</b>	<b>15</b>
4.1 LIMIT	15
4.2 TEST PROCEDURE	16
4.3 DEVIATION FROM TEST STANDARD	16
4.4 TEST SETUP	17
4.5 EUT OPERATION CONDITIONS	18
4.6 TEST RESULTS - 9 KHZ TO 30 MHZ	18
4.7 TEST RESULTS - 30 MHZ TO 1000 MHZ	18
4.8 TEST RESULTS - ABOVE 1000 MHZ	18
<b>5 . BANDWIDTH TEST</b>	<b>19</b>
5.1 LIMIT	19
5.2 TEST PROCEDURE	19
5.3 DEVIATION FROM STANDARD	19
5.4 TEST SETUP	19

<b>Table of Contents</b>	<b>Page</b>
5.5 EUT OPERATION CONDITIONS	19
5.6 TEST RESULTS	19
<b>6 . MAXIMUM OUTPUT POWER TEST</b>	<b>20</b>
6.1 LIMIT	20
6.2 TEST PROCEDURE	20
6.3 DEVIATION FROM STANDARD	20
6.4 TEST SETUP	20
6.5 EUT OPERATION CONDITIONS	20
6.6 TEST RESULTS	20
<b>7 . CONDUCTED SPURIOUS EMISSIONS</b>	<b>21</b>
7.1 LIMIT	21
7.2 TEST PROCEDURE	21
7.3 DEVIATION FROM STANDARD	21
7.4 TEST SETUP	21
7.5 EUT OPERATION CONDITIONS	21
7.6 TEST RESULTS	21
<b>8 . POWER SPECTRAL DENSITY TEST</b>	<b>22</b>
8.1 LIMIT	22
8.2 TEST PROCEDURE	22
8.3 DEVIATION FROM STANDARD	22
8.4 TEST SETUP	22
8.5 EUT OPERATION CONDITIONS	22
8.6 TEST RESULTS	22
<b>9 . MEASUREMENT INSTRUMENTS LIST</b>	<b>23</b>
<b>10 . EUT TEST PHOTO</b>	<b>25</b>
<b>APPENDIX A - AC POWER LINE CONDUCTED EMISSIONS</b>	<b>30</b>
<b>APPENDIX B - RADIATED EMISSION - 9 KHZ TO 30 MHZ</b>	<b>33</b>
<b>APPENDIX C - RADIATED EMISSION - 30 MHZ TO 1000 MHZ</b>	<b>38</b>
<b>APPENDIX D - RADIATED EMISSION- ABOVE 1000 MHZ</b>	<b>41</b>
<b>APPENDIX E - BANDWIDTH</b>	<b>78</b>
<b>APPENDIX F - MAXIMUM OUTPUT POWER</b>	<b>82</b>

**Table of Contents**

**Page**

**APPENDIX G - CONDUCTED SPURIOUS EMISSIONS**

**84**

**APPENDIX H - POWER SPECTRAL DENSITY**

**88**

**REPORT ISSUED HISTORY**

Report Version	Description	Issued Date
R00	Original Issue.	Dec. 13, 2019
R01	Removed the parameters of test software which does not affect the test results.	Feb. 19, 2020

## 1. SUMMARY OF TEST RESULTS

Test procedures according to the technical standard(s):

FCC Part15, Subpart C (15.247)				
Standard(s) Section	Test Item	Test Result	Judgment	Remark
15.207	AC Power Line Conducted Emissions	APPENDIX A	PASS	-----
15.247(d) 15.205(a) 15.209(a)	Radiated Emissions	APPENDIX B APPENDIX C APPENDIX D	PASS	-----
15.247(a)(2)	Bandwidth	APPENDIX E	PASS	-----
15.247(b)(3)	Maximum Output Power	APPENDIX F	PASS	-----
15.247(d)	Conducted Spurious Emissions	APPENDIX G	PASS	-----
15.247(e)	Power Spectral Density	APPENDIX H	PASS	-----
15.203	Antenna Requirement	-----	PASS	Note(2)

Note:

- (1) "N/A" denotes test is not applicable in this test report.
- (2) The device what use a permanently attached antenna were considered sufficient to comply with the provisions of 15.203.

### 1.1 TEST FACILITY

The test facilities used to collect the test data in this report is at the location of No.3,Jinshagang 1st Road, Shixia, Dalang Town, Dongguan, Guangdong, China.

BTL's Test Firm Registration Number for FCC: 357015

BTL's Designation Number for FCC: CN1240

### 1.2 MEASUREMENT UNCERTAINTY

ISO/IEC 17025 requires that an estimate of the measurement uncertainties associated with the emissions test results be included in the report. The measurement uncertainties given below are based on a 95% confidence level (based on a coverage factor (k=2))

The BTL measurement uncertainty as below table:

#### A. AC power line conducted emissions test:

Test Site	Method	Measurement Frequency Range	U, (dB)
DG-C02	CISPR	150kHz ~ 30MHz	2.60

#### B. Radiated emissions test:

Test Site	Method	Measurement Frequency Range	Ant. H / V	U, (dB)
DG-CB03	CISPR	9kHz ~ 30MHz	V	3.79
		9kHz ~ 30MHz	H	3.57
		30MHz ~ 200MHz	V	4.88
		30MHz ~ 200MHz	H	4.14
		200MHz ~ 1,000MHz	V	4.62
		200MHz ~ 1,000MHz	H	4.80
		1GHz ~ 6GHz	-	4.58
		6GHz ~ 18GHz	-	5.18
		18GHz ~ 26.5GHz	-	3.62
		26.5GHz ~ 40GHz	-	4.00

Note: Unless specifically mentioned, the uncertainty of measurement has not been taken into account to declare the compliance or non-compliance to the specification.

### 1.3 TEST ENVIRONMENT CONDITIONS

Test Item	Temperature	Humidity	Test Voltage	Tested By
AC Power Line Conducted Emissions	25°C	53%	DC 3.3V	Laughing Zhang
Radiated Emissions-9K-30MHz	25°C	60%	DC 3.3V	Laughing Zhang
Radiated Emissions-30 MHz to 1GHz	24°C	68%	DC 3.3V	Laughing Zhang
Radiated Emissions-Above 1000 MHz	26°C	65%	DC 3.3V	Laughing Zhang
Bandwidth	24°C	66%	DC 3.3V	Jonas Chen
Maximum output power	24°C	66%	DC 3.3V	Laughing Zhang
Conducted Spurious Emissions	24°C	66%	DC 3.3V	Jonas Chen
Power Spectral Density	24°C	66%	DC 3.3V	Jonas Chen



## 2. GENERAL INFORMATION

### 2.1 GENERAL DESCRIPTION OF EUT

Equipment	WiFi Module
Brand Name	Dialog
Test Model	DA16200MOD-AAC4WA32
Series Model	N/A
Model Difference(s)	N/A
Power Source	DC voltage supplied from external power supply.
Power Rating	DC 3.3V
Operation Frequency	2412 MHz ~ 2462 MHz
Modulation Type	IEEE 802.11b: DSSS IEEE 802.11g: OFDM IEEE 802.11n: OFDM
Bit Rate of Transmitter	IEEE 802.11b: 11/5.5/2/1 Mbps IEEE 802.11g: 54/48/36/24/18/12/9/6 Mbps IEEE 802.11n: up to 72.2 Mbps
Maximum Output Power	IEEE 802.11b: 18.09 dBm (0.0644 W) IEEE 802.11g: 16.96 dBm (0.0497 W) IEEE 802.11n (HT20): 16.24 dBm (0.0420 W)

Note:

1. For a more detailed features description, please refer to the manufacturer's specifications or the user's manual.

2. Channel List:

CH01 - CH11 for IEEE 802.11b, IEEE 802.11g, IEEE 802.11n (HT20)							
Channel	Frequency (MHz)	Channel	Frequency (MHz)	Channel	Frequency (MHz)	Channel	Frequency (MHz)
01	2412	04	2427	07	2442	10	2457
02	2417	05	2432	08	2447	11	2462
03	2422	06	2437	09	2452		

3. Antenna Specification:

Ant.	Brand	Model Name	Antenna Type	Connector	Gain (dBi)
1	N/A	N/A	Chip	N/A	2

## 2.2 DESCRIPTION OF TEST MODES

The test system was pre-tested based on the consideration of all possible combinations of EUT operation mode.

Pretest Mode	Description
Mode 1	TX B Mode Channel 01/06/11
Mode 2	TX G Mode Channel 01/06/11
Mode 3	TX N-20 MHz Mode Channel 01/06/11
Mode 4	TX B Mode Channel 06

Following mode(s) was (were) found to be the worst case(s) and selected for the final test.

<b>AC power line conducted emissions test</b>	
Final Test Mode:	Description
Mode 4	TX B Mode Channel 06

<b>Radiated emissions test - Below 1GHz</b>	
Final Test Mode:	Description
Mode 4	TX B Mode Channel 06

<b>Radiated emissions test- Above 1GHz</b>	
Final Test Mode:	Description
Mode 1	TX B Mode Channel 01/06/11
Mode 2	TX G Mode Channel 01/06/11
Mode 3	TX N-20 MHz Mode Channel 01/06/11

<b>Conducted test</b>	
Final Test Mode:	Description
Mode 1	TX B Mode Channel 01/06/11
Mode 2	TX G Mode Channel 01/06/11
Mode 3	TX N-20 MHz Mode Channel 01/06/11

### NOTE:

- (1) The measurements are performed at the high, middle, low available channels.
- (2) For radiated emission below 1 GHz test, the IEEE 802.11b Channel 06 is found to be the worst case and recorded.
- (3) For radiated emission above 1 GHz test, 1GHz~26.5GHz have been pre-tested and in this report only recorded the worst case. The remaining spurious points are all below the limit value of 20dB.
- (4) For AC power line conducted emissions test, the test voltage of AC 120V/60Hz & DC 3.3V had been pre-tested and in this report only recorded the worst case.

## 2.3 DUTY CYCLE

If duty cycle is  $\geq 98\%$ , duty factor is not required.  
 If duty cycle is  $< 98\%$ , duty factor shall be considered.  
 The output power = measured power + duty factor.

**IEEE 802.11b**

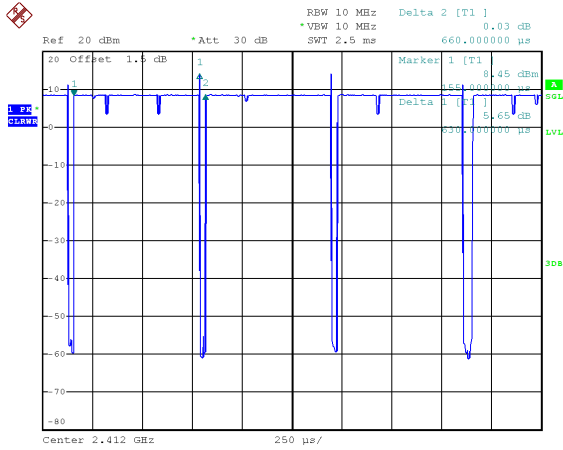

Date: 7.NOV.2019 20:06:59

Duty cycle = 0.630 ms / 0.660 ms = 95.45%  
 Duty Factor =  $10 \log(1/\text{Duty cycle}) = 0.20$

**IEEE 802.11g**

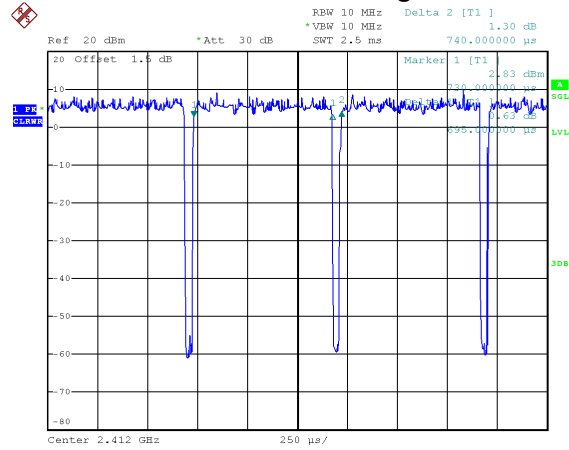

Date: 7.NOV.2019 20:07:20

Duty cycle = 0.695 ms / 0.740 ms = 93.92%  
 Duty Factor =  $10 \log(1/\text{Duty cycle}) = 0.27$

**IEEE 802.11n (HT20)**

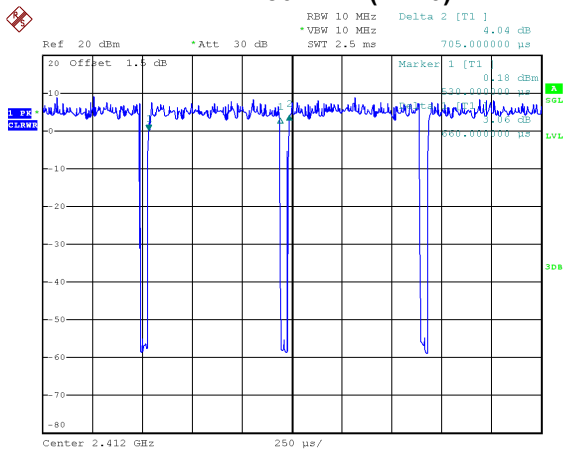

Date: 7.NOV.2019 20:07:34

Duty cycle = 0.660 ms / 0.705 ms = 93.62%  
 Duty Factor =  $10 \log(1/\text{Duty cycle}) = 0.29$

**NOTE:**

For IEEE 802.11g and IEEE 802.11n (HT20):  
 For radiated emissions frequency above 1 GHz, the resolution bandwidth of test receiver/spectrum analyzer is 1 MHz and the video bandwidth is 1 kHz (Duty cycle  $< 98\%$ ).

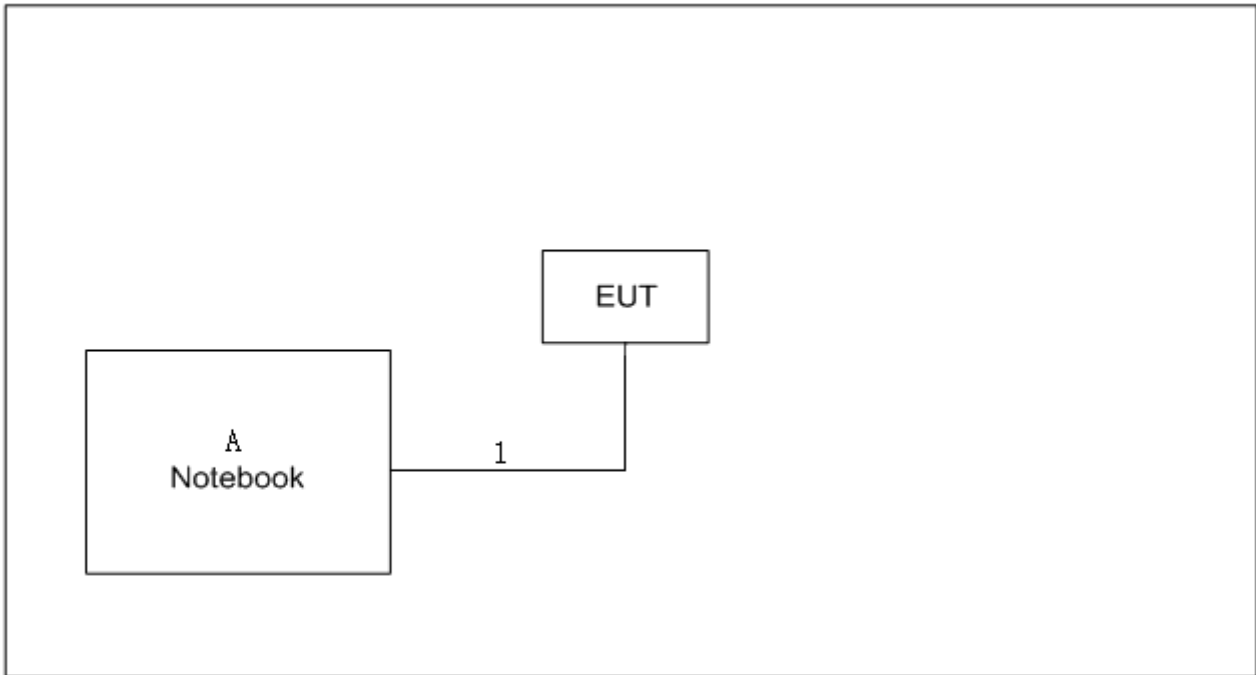
**2.4 BLOCK DIAGRAM SHOWING THE CONFIGURATION OF SYSTEM TESTED****2.5 SUPPORT UNITS**

Item	Equipment	Brand	Model No.	Series No.
A	Notebook	Dell	Inspiron 15-7559	N/A

Item	Cable Type	Shielded Type	Ferrite Core	Length
1	USB Cable	NO	NO	0.8m

### 3. AC POWER LINE CONDUCTED EMISSIONS TEST

#### 3.1 LIMIT

Frequency of Emission (MHz)	Limit (dB $\mu$ V)	
	Quasi-peak	Average
0.15 - 0.50	66 - 56*	56 - 46*
0.50 - 5.0	56	46
5.0 - 30.0	60	50

**NOTE:**

- (1) The tighter limit applies at the band edges.
- (2) The limit of "\*" marked band means the limitation decreases linearly with the logarithm of the frequency in the range.

The following table is the setting of the receiver

Receiver Parameters	Setting
Attenuation	10 dB
Start Frequency	0.15 MHz
Stop Frequency	30 MHz
IF Bandwidth	9 kHz

#### 3.2 TEST PROCEDURE

- a. The EUT was placed 0.8 meters from the horizontal ground plane with EUT being connected to the power mains through a line impedance stabilization network (LISN). All other support equipment powered from additional LISN(s). The LISN provide 50 Ohm/ 50uH of coupling impedance for the measuring instrument.
- b. Interconnecting cables that hang closer than 40 cm to the ground plane shall be folded back and forth in the center forming a bundle 30 to 40 cm long.
- c. I/O cables that are not connected to a peripheral shall be bundled in the center. The end of the cable may be terminated, if required, using the correct terminating impedance. The overall length shall not exceed 1 m.
- d. LISN at least 80 cm from nearest part of EUT chassis.
- e. For the actual test configuration, please refer to the related Item -EUT Test Photos.

#### 3.3 DEVIATION FROM TEST STANDARD

No deviation

### 3.4 TEST SETUP

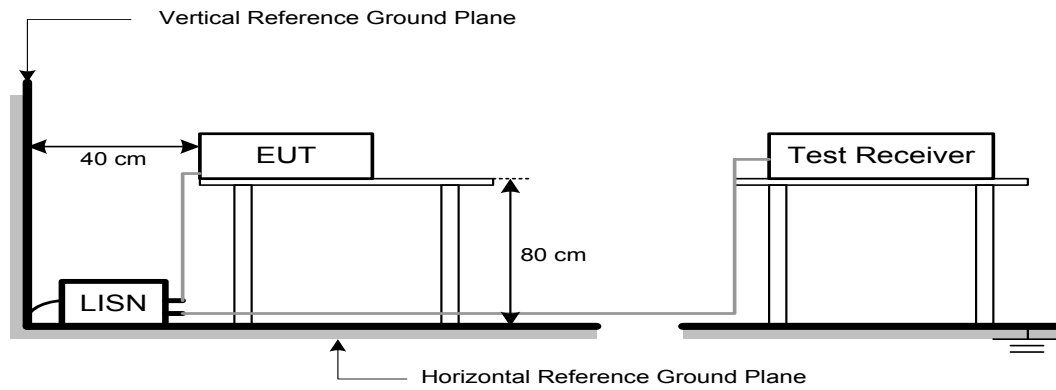

### 3.5 EUT OPERATION CONDITIONS

EUT was programmed to be in continuously transmitting mode.

### 3.6 TEST RESULTS

Please refer to the APPENDIX A.

## 4. RADIATED EMISSIONS TEST

### 4.1 LIMIT

In case the emission fall within the restricted band specified on 15.205(a), then the 15.209(a) limit in the table below has to be followed.

#### LIMITS OF RADIATED EMISSION MEASUREMENT (9 kHz-1000 MHz)

Frequency (MHz)	Field Strength (microvolts/meter)	Measurement Distance (meters)
0.009-0.490	2400/F(kHz)	300
0.490-1.705	24000/F(kHz)	30
1.705-30.0	30	30
30-88	100	3
88-216	150	3
216-960	200	3
Above 960	500	3

#### LIMITS OF RADIATED EMISSION MEASUREMENT (Above 1000 MHz)

Frequency (MHz)	(dBuV/m at 3 m)	
	Peak	Average
Above 1000	74	54

#### NOTE:

- (1) The limit for radiated test was performed according to FCC PART 15C.
- (2) The tighter limit applies at the band edges.
- (3) Emission level (dBuV/m)=20log Emission level (uV/m).

Spectrum Parameter	Setting
Attenuation	Auto
Start Frequency	1000 MHz
Stop Frequency	10th carrier harmonic
RBW / VBW (Emission in restricted band)	1 MHz / 3 MHz for Peak, 1 MHz / 1/T for Average

Receiver Parameter	Setting
Attenuation	Auto
Start ~ Stop Frequency	9 kHz~90 kHz for PK/AVG detector
Start ~ Stop Frequency	90 kHz~110 kHz for QP detector
Start ~ Stop Frequency	110 kHz~490 kHz for PK/AVG detector
Start ~ Stop Frequency	490 kHz~30 MHz for QP detector
Start ~ Stop Frequency	30 MHz~1000 MHz for QP detector

## 4.2 TEST PROCEDURE

- a. The measuring distance of 3 m shall be used for measurements. The EUT was placed on the top of a rotating table 0.8 meter above the ground at a 3 meter semi-anechoic chamber. The table was rotated 360 degrees to determine the position of the highest radiation.(below 1 GHz)
- b. The measuring distance of 3 m shall be used for measurements. The EUT was placed on the top of a rotating table 1.5 meter above the ground at a 3 meter semi-anechoic chamber. The table was rotated 360 degrees to determine the position of the highest radiation.(above 1 GHz)
- c. The height of the equipment or of the substitution antenna shall be 0.8m or 1.5m; the height of the test antenna shall vary between 1 m to 4 m. Both horizontal and vertical polarizations of the antenna are set to make the measurement.
- d. For each suspected emission, the EUT was arranged to its worst case and then the antenna was tuned to heights find the maximum reading (used Bore sight function).
- e. The receiver system was set to peak and average detect function and specified bandwidth with maximum hold mode when the test frequency is above 1 GHz.
- f. The initial step in collecting radiated emission data is a receiver peak detector mode pre-scanning the measurement frequency range. Significant peaks are then marked and then Quasi Peak detector mode re-measured.
- g. All readings are Peak unless otherwise stated QP in column of Note. Peak denotes that the Peak reading compliance with the QP Limits and then QP Mode measurement didn't perform. (below 1 GHz)
- h. All readings are Peak Mode value unless otherwise stated AVG in column of Note. If the Peak Mode Measured value compliance with the Peak Limits and lower than AVG Limits, the EUT shall be deemed to meet both Peak & AVG Limits and then only Peak Mode was measured, but AVG Mode didn't perform. (above 1 GHz)
- i. For the actual test configuration, please refer to the related Item -EUT Test Photos.

## 4.3 DEVIATION FROM TEST STANDARD

No deviation



**4.4 TEST SETUP**

**9 kHz-30 MHz**

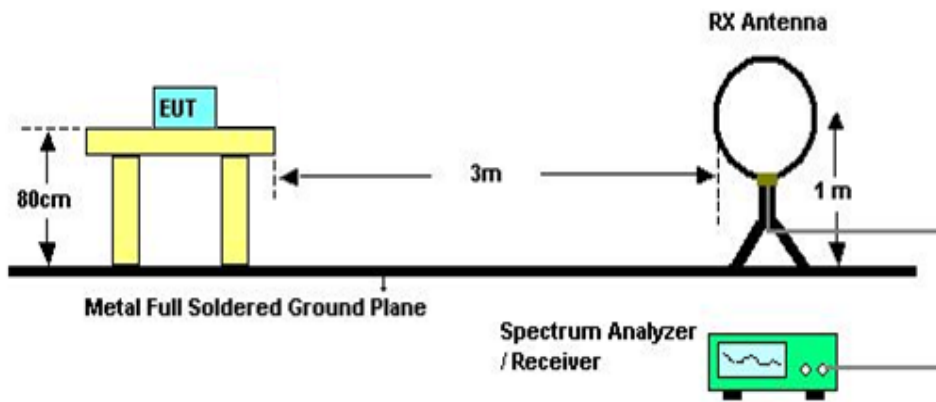

**30 MHz to 1 GHz**

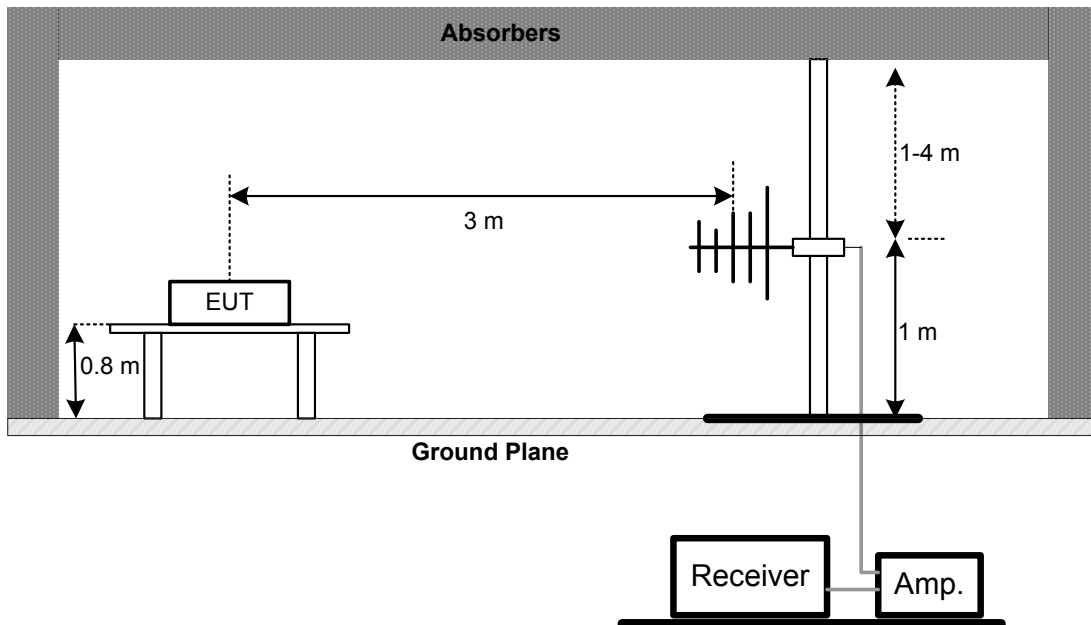

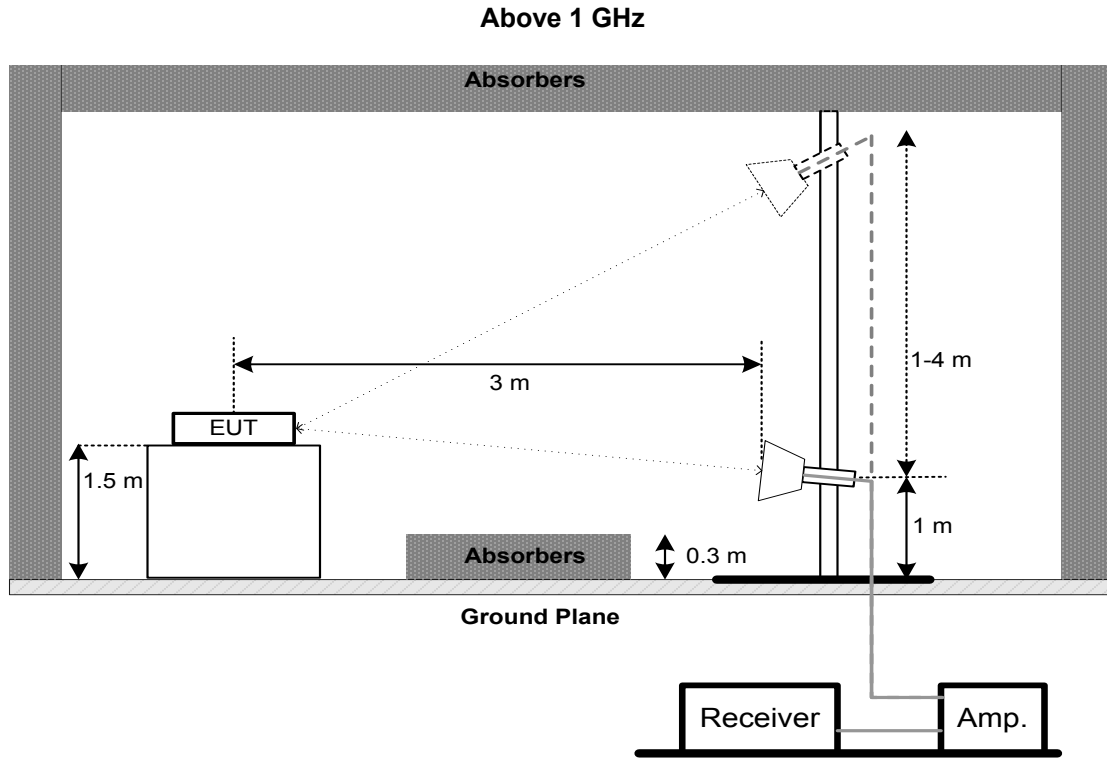

#### 4.5 EUT OPERATION CONDITIONS

The EUT was programmed to be in continuously transmitting mode.

#### 4.6 TEST RESULTS - 9 KHZ TO 30 MHZ

Please refer to the APPENDIX B

Remark:

- (1) Distance extrapolation factor =  $40 \log (\text{specific distance} / \text{test distance})$  (dB).
- (2) Limit line = specific limits (dBuV) + distance extrapolation factor.

#### 4.7 TEST RESULTS - 30 MHZ TO 1000 MHZ

Please refer to the APPENDIX C.

#### 4.8 TEST RESULTS - ABOVE 1000 MHZ

Please refer to the APPENDIX D.

Remark:

- (1) No limit: This is fundamental signal, the judgment is not applicable.  
For fundamental signal judgment was referred to Peak output test.

## 5. BANDWIDTH TEST

### 5.1 LIMIT

FCC Part15, Subpart C (15.247)		
Section	Test Item	Limit
15.247(a)(2)	6 dB Bandwidth	Minimum 500 kHz
	99% Emission Bandwidth	-

### 5.2 TEST PROCEDURE

- The EUT was directly connected to the spectrum analyzer and antenna output port as show in the block diagram below.
- Spectrum Setting:  
For 6 dB Bandwidth : RBW= 100 kHz, VBW=300 kHz, Sweep time = 2.5 ms.  
For 99% Emission Bandwidth B/G/N-20 Mode: RBW= 300 KHz, VBW=1 MHz, Sweep time = 2.5 ms.
- The bandwidth was performed in accordance with method 11.8.1 of ANSI C63.10-2013.

### 5.3 DEVIATION FROM STANDARD

No deviation.

### 5.4 TEST SETUP

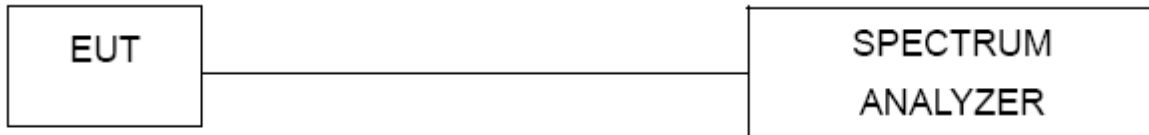

### 5.5 EUT OPERATION CONDITIONS

The EUT was programmed to be in continuously transmitting mode.

### 5.6 TEST RESULTS

Please refer to the APPENDIX E.

## 6. MAXIMUM OUTPUT POWER TEST

### 6.1 LIMIT

FCC Part15, Subpart C (15.247)		
Section	Test Item	Limit
15.247(b)(3)	Maximum Output Power	1 Watt or 30dBm

### 6.2 TEST PROCEDURE

- The EUT was directly connected to the power meter and antenna output port as show in the block diagram below.
- The maximum conducted output power was performed in accordance with method 11.9.2.3.1 of ANSI C63.10-2013.

### 6.3 DEVIATION FROM STANDARD

No deviation.

### 6.4 TEST SETUP



### 6.5 EUT OPERATION CONDITIONS

The EUT was programmed to be in continuously transmitting mode.

### 6.6 TEST RESULTS

Please refer to the APPENDIX F.

## 7. CONDUCTED SPURIOUS EMISSIONS

### 7.1 LIMIT

In any 100 kHz bandwidth outside the frequency band in which the spread spectrum or digitally modulated intentional radiator is operating, the radio frequency power that is produced by the intentional radiator shall be at least 20 dB below that in the 100 kHz bandwidth within the band that contains the highest level of the desired power, based on either an RF conducted or a radiated measurement, provided the transmitter demonstrates compliance with the peak Output Power limits. If the transmitter complies with the Output Power limits based on the use of RMS averaging over a time interval, as permitted under paragraph (b)(3) of this section, the attenuation required under this paragraph shall be 30 dB instead of 20 dB. Attenuation below the general limits specified in Section 15.209(a) is not required.

### 7.2 TEST PROCEDURE

- a. The EUT was directly connected to the spectrum analyzer and antenna output port as show in the block diagram below.
- b. Spectrum Setting: RBW= 100 kHz, VBW=300 kHz, Sweep time = Auto.

### 7.3 DEVIATION FROM STANDARD

No deviation.

### 7.4 TEST SETUP



### 7.5 EUT OPERATION CONDITIONS

The EUT was programmed to be in continuously transmitting mode.

### 7.6 TEST RESULTS

Please refer to the APPENDIX G.

## 8. POWER SPECTRAL DENSITY TEST

### 8.1 LIMIT

FCC Part15, Subpart C (15.247)		
Section	Test Item	Limit
15.247(e)	Power Spectral Density	8 dBm (in any 3 kHz)

### 8.2 TEST PROCEDURE

- The EUT was directly connected to the spectrum analyzer and antenna output port as show in the block diagram below.
- Spectrum Setting: RBW=3 kHz, VBW=10 kHz, Sweep time = Auto.
- The Power Spectral Density was performed in accordance with method 11.10.2 of ANSI C63.10-2013.

### 8.3 DEVIATION FROM STANDARD

No deviation.

### 8.4 TEST SETUP



### 8.5 EUT OPERATION CONDITIONS

The EUT was programmed to be in continuously transmitting mode.

### 8.6 TEST RESULTS

Please refer to the APPENDIX H.

## 9. MEASUREMENT INSTRUMENTS LIST

AC Power Line Conducted Emissions					
Item	Kind of Equipment	Manufacturer	Type No.	Serial No.	Calibrated until
1	EMI Test Receiver	R&S	ESCI	100382	Mar. 10, 2020
2	LISN	EMCO	3816/2	52765	Mar. 10, 2020
3	TWO-LINE V-NETWORK	R&S	ENV216	101447	May. 19, 2020
4	50Ω Terminator	SHX	TF5-3	15041305	Mar. 10, 2020
5	Measurement Software	Farad	EZ-EMC Ver.NB-03A1-01	N/A	N/A
6	Cable	N/A	RG223	12m	Mar. 12, 2020

Radiated Emissions - 9 kHz to 30 MHz					
Item	Kind of Equipment	Manufacturer	Type No.	Serial No.	Calibrated until
1	Loop Antenna	EM	EM-6876-1	230	Jan. 15, 2020
2	Cable	N/A	RG 213/U	C-102	May 31, 2020
3	EMI Test Receiver	R&S	ESCI	100895	Mar. 10, 2020
4	Measurement Software	Farad	EZ-EMC Ver.NB-03A1-01	N/A	N/A

Radiated Emissions - 30 MHz to 1 GHz					
Item	Kind of Equipment	Manufacturer	Type No.	Serial No.	Calibrated until
1	Antenna	Schwarzbeck	VULB9160	9160-3232	Mar. 09, 2020
2*	Amplifier	HP	8447D	2944A09673	Aug. 11, 2021
3	Receiver	Agilent	N9038A	MY52130039	Aug. 03, 2020
4	Cable	emci	LMR-400(30MHz-1 GHz)(8m+5m)	N/A	May 24, 2020
5	Controller	CT	SC100	N/A	N/A
6	Controller	MF	MF-7802	MF780208416	N/A
7	Measurement Software	Farad	EZ-EMC Ver.NB-03A1-01	N/A	N/A

Radiated Emissions - Above 1 GHz					
Item	Kind of Equipment	Manufacturer	Type No.	Serial No.	Calibrated until
1	Double Ridged Guide Antenna	ETS	3115	75789	Mar. 09, 2020
2	Broad-Band Horn Antenna	Schwarzbeck	BBHA 9170	9170319	Jun. 23, 2020
3	Amplifier	Agilent	8449B	3008A02333	Mar. 10, 2020
4	Microwave Pre-amplifier With Adaptor	EMC INSTRUMENT	EMC2654045	980039 & HA01	Mar. 10, 2020
5	Receiver	Agilent	N9038A	MY52130039	Aug. 03, 2020
6	Controller	CT	SC100	N/A	N/A
7	Controller	MF	MF-7802	MF780208416	N/A
8	Cable	mitron	B10-01-01-12M	18072744	Jun. 29, 2020
9	Measurement Software	Farad	EZ-EMC Ver.NB-03A1-01	N/A	N/A

Bandwidth & Antenna Conducted Spurious Emissions & Power Spectral Density					
Item	Kind of Equipment	Manufacturer	Type No.	Serial No.	Calibrated until
1	Spectrum Analyzer	R&S	FSP40	100185	Aug. 03, 2020

Maximum Output Power					
Item	Kind of Equipment	Manufacturer	Type No.	Serial No.	Calibrated until
1	Peak Power Analyzer	Keysight	8990B	MY51000506	Aug. 03, 2020
2	Wideband power sensor	Keysight	N1923A	MY58310004	Aug. 03, 2020

Remark: "N/A" denotes no model name, serial no. or calibration specified.

"\*" calibration period of equipment list is three year.

Except \* item, all calibration period of equipment list is one year.

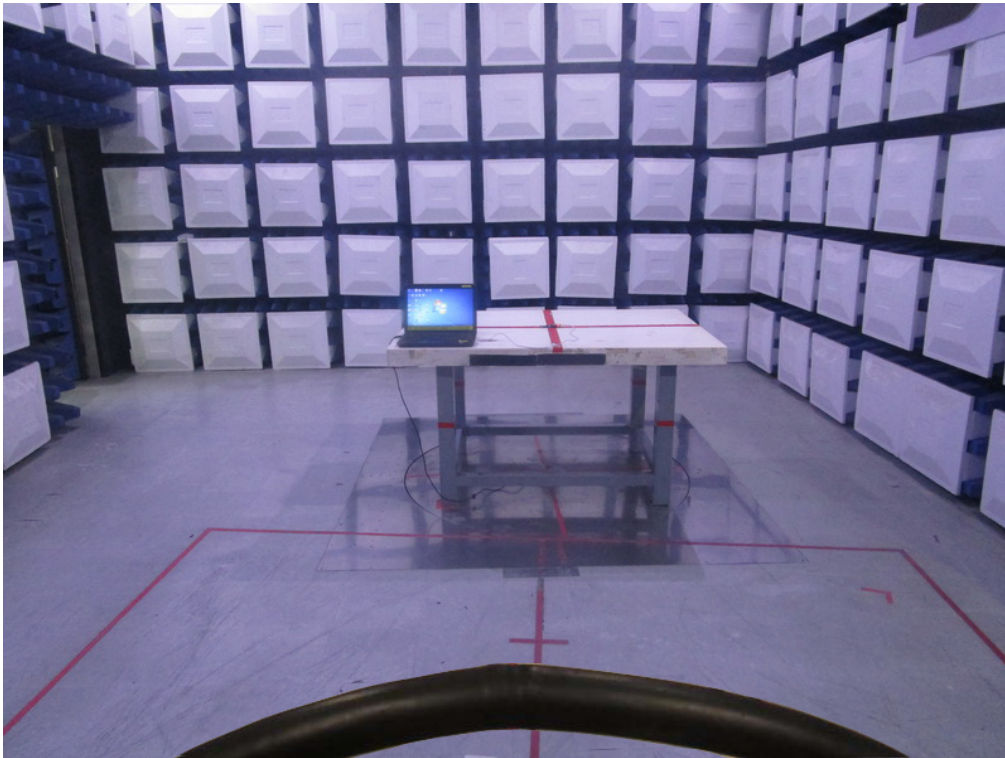

**10. EUT TEST PHOTO****AC Power Line Conducted Emissions**

**Radiated Emissions Test Photos****9 kHz to 30 MHz**

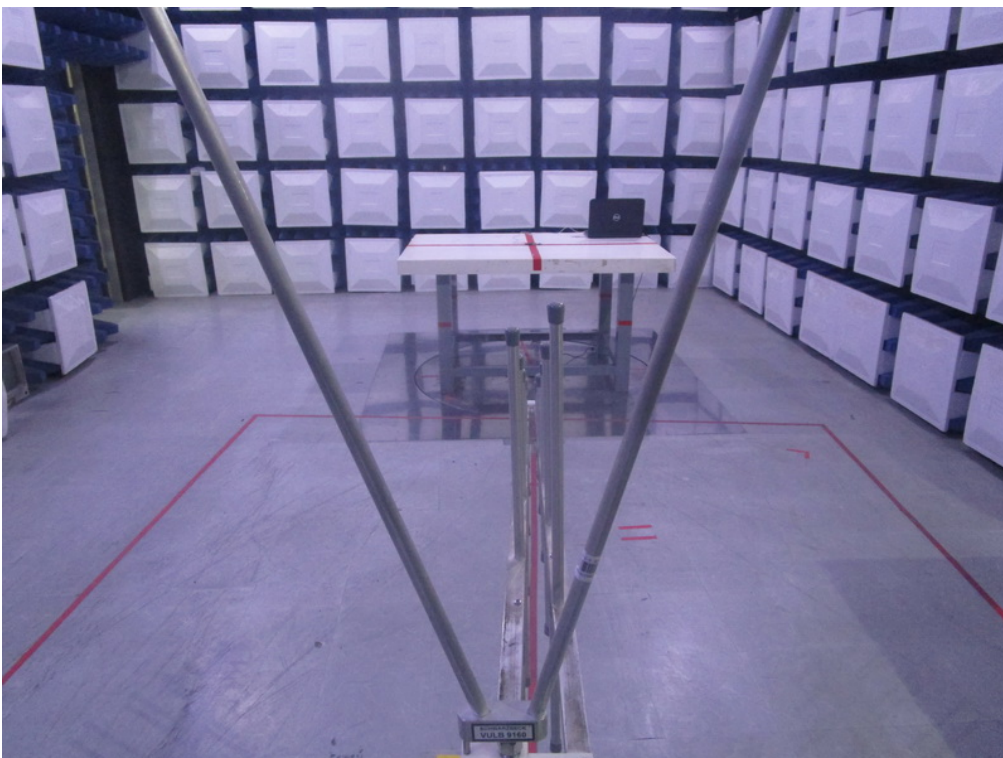
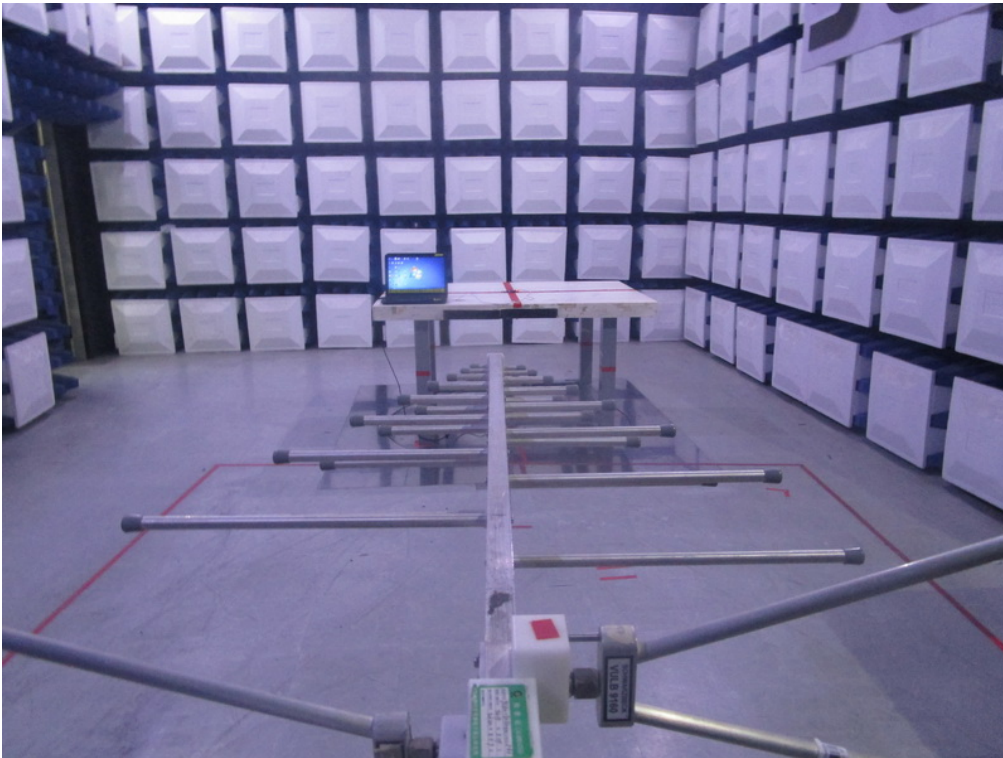

**Radiated Emissions Test Photos****30 MHz to 1 GHz**

**Radiated Emissions Test Photos**

**Above 1 GHz**

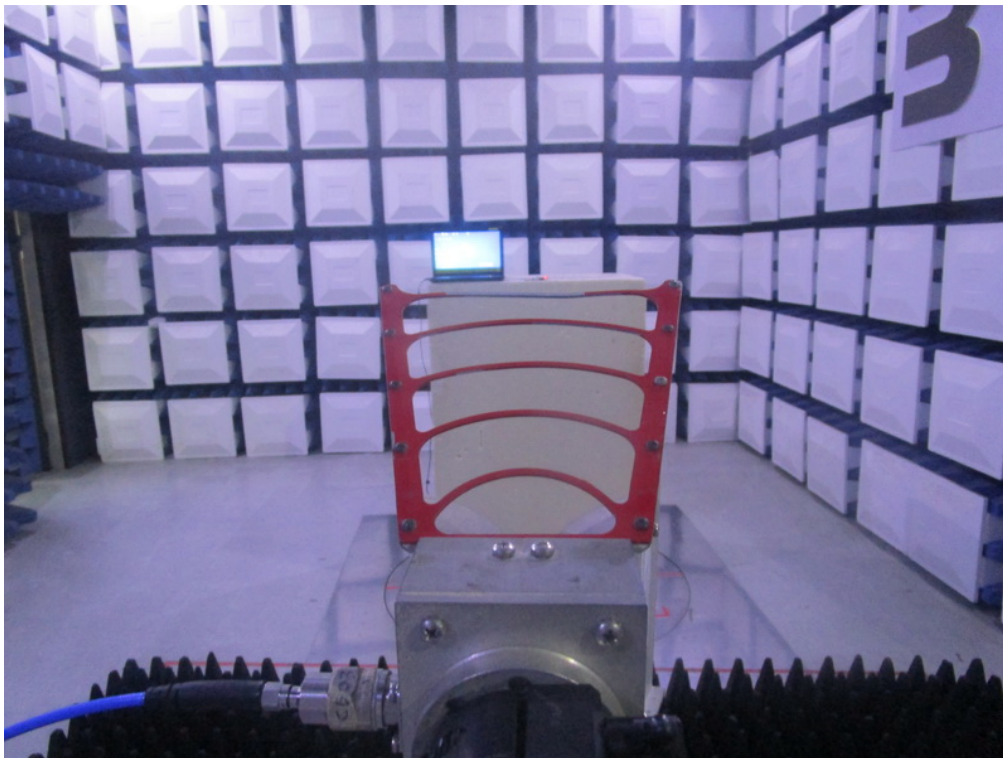

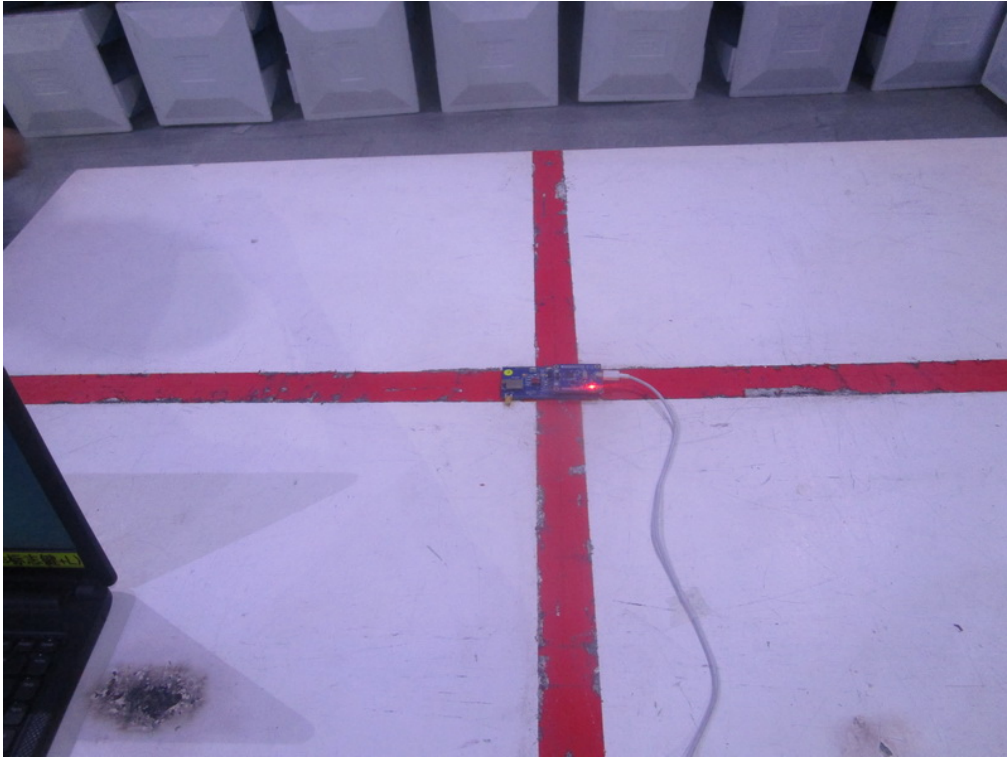

## **APPENDIX A - AC POWER LINE CONDUCTED EMISSIONS**



Test Mode: TX B Mode Channel 06

### Line

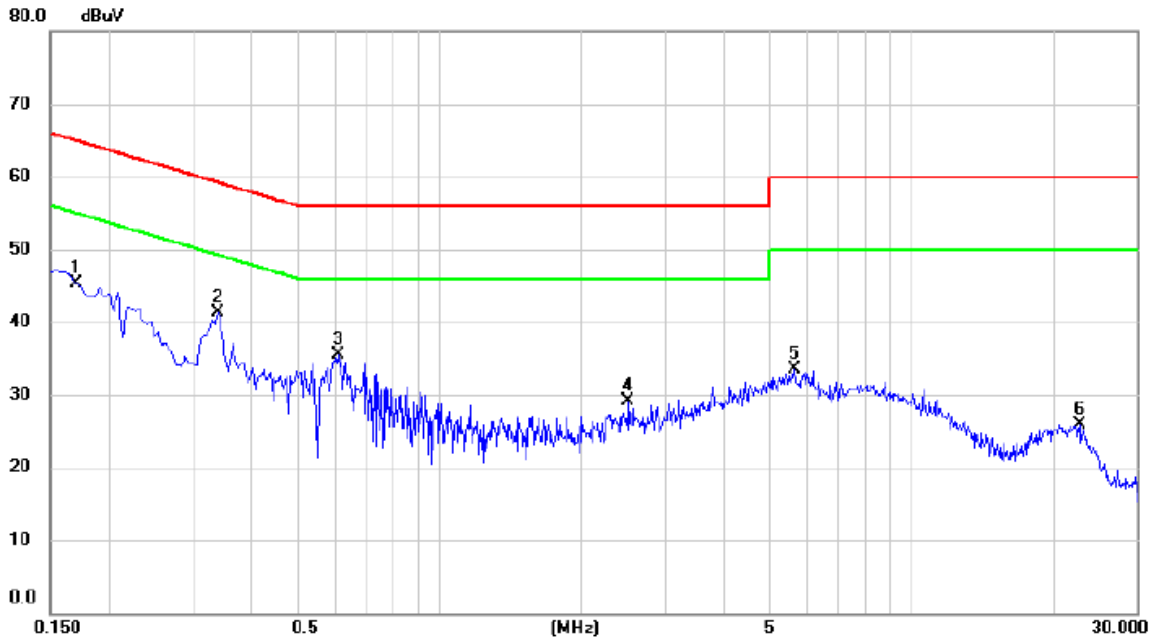

No.	Mk.	Freq. MHz	Reading Level dBuV	Correct Factor dB	Measure- ment dBuV	Limit dBuV	Margin dB	Detector	Comment
1		0.1703	35.47	9.82	45.29	64.95	-19.66	peak	
2	*	0.3390	31.38	9.85	41.23	59.23	-18.00	peak	
3		0.6090	25.66	9.89	35.55	56.00	-20.45	peak	
4		2.5125	19.05	10.03	29.08	56.00	-26.92	peak	
5		5.6310	23.18	10.23	33.41	60.00	-26.59	peak	
6		22.6275	14.72	11.16	25.88	60.00	-34.12	peak	

**REMARKS:**

- (1) Measurement Value = Reading Level + Correct Factor.
- (2) Margin Level = Measurement Value - Limit Value.

Test Mode: TX B Mode Channel 06

### Neutral

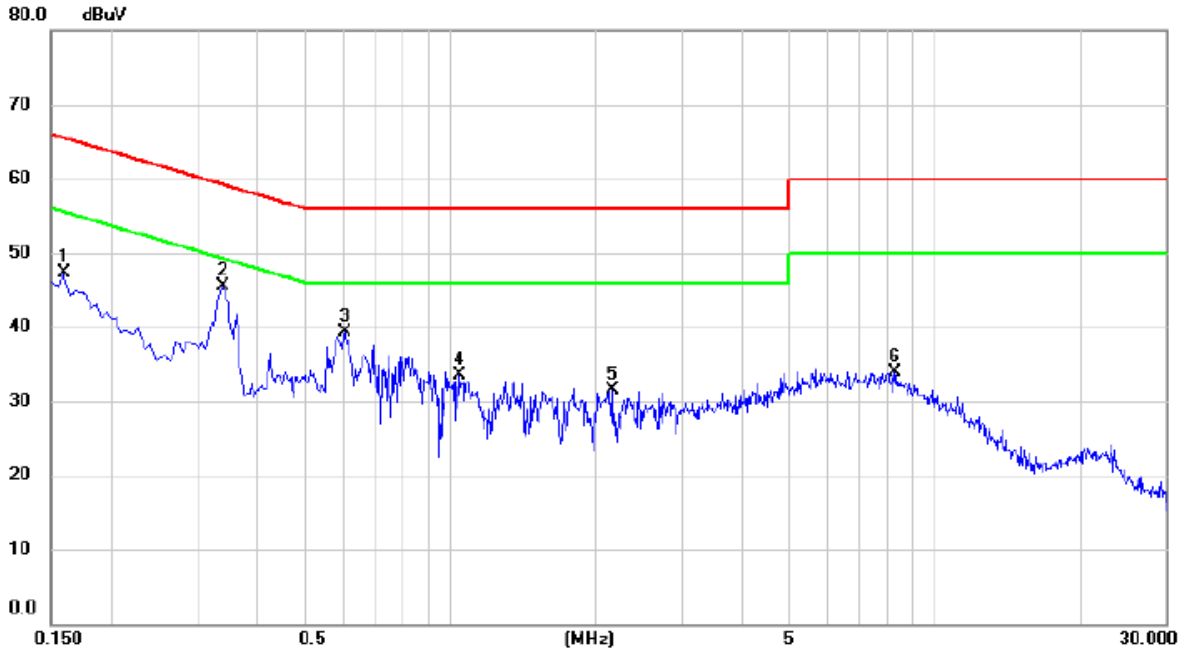

No.	Mk.	Freq. MHz	Reading Level dBuV	Correct Factor dB	Measure- ment dBuV	Limit dBuV	Margin dB	Detector	Comment
1		0.1590	37.38	9.91	47.29	65.52	-18.23	peak	
2	*	0.3390	35.43	9.98	45.41	59.23	-13.82	peak	
3		0.6045	29.34	10.04	39.38	56.00	-16.62	peak	
4		1.0455	23.30	10.12	33.42	56.00	-22.58	peak	
5		2.1525	21.39	10.20	31.59	56.00	-24.41	peak	
6		8.2410	23.29	10.66	33.95	60.00	-26.05	peak	

**REMARKS:**

- (1) Measurement Value = Reading Level + Correct Factor.
- (2) Margin Level = Measurement Value - Limit Value.



**APPENDIX B - RADIATED EMISSION - 9 KHZ TO 30 MHZ**

Test Mode: TX B Mode Channel 06

Ant 0°

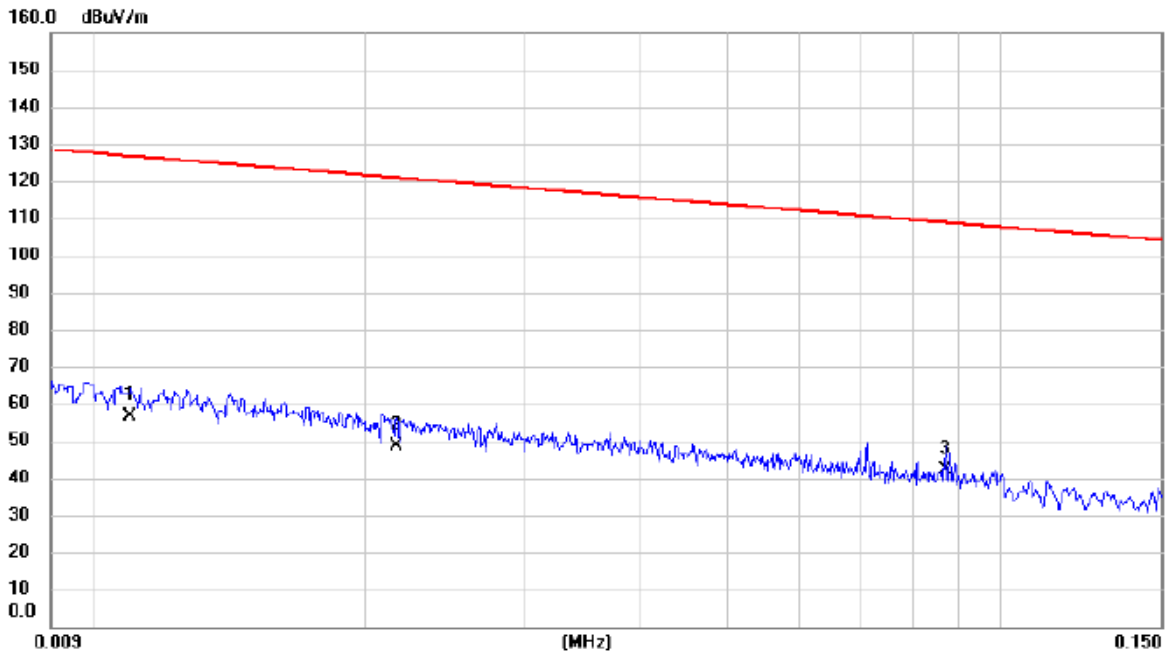

No.	Mk.	Freq.	Reading Level	Correct Factor	Measurement	Limit	Margin	Detector	Comment
		MHz	dBuV	dB	dBuV/m	dBuV/m	dB		
1		0.0110	40.25	16.52	56.77	126.78	-70.01	AVG	
2		0.0216	34.86	13.83	48.69	120.92	-72.23	AVG	
3	*	0.0868	28.71	13.54	42.25	108.83	-66.58	AVG	

REMARKS:

- (1) Measurement Value = Reading Level + Correct Factor.
- (2) Margin Level = Measurement Value - Limit Value.

Test Mode: TX B Mode Channel 06

Ant 0°

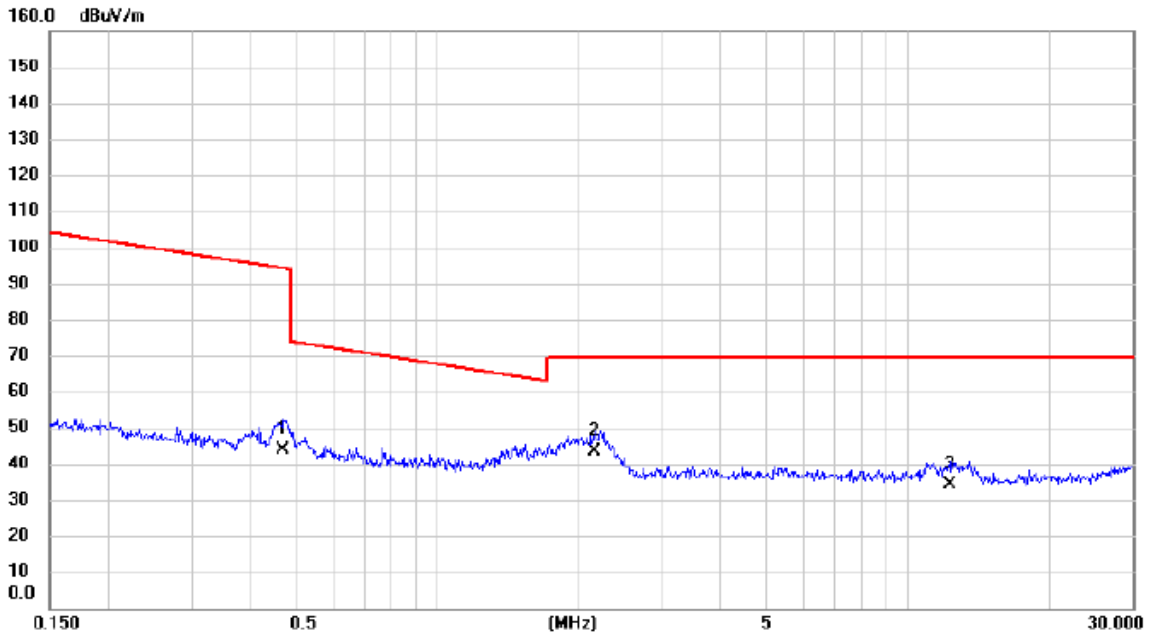

No.	Mk.	Freq. MHz	Reading Level dBuV	Correct Factor dB	Measure- ment dBuV/m	Limit dBuV/m	Margin dB	Detector	Comment
1		0.4711	30.52	13.13	43.65	94.14	-50.49	AVG	
2	*	2.1552	31.48	11.73	43.21	69.54	-26.33	QP	
3		12.2531	22.64	11.60	34.24	69.54	-35.30	QP	

REMARKS:

- (1) Measurement Value = Reading Level + Correct Factor.
- (2) Margin Level = Measurement Value - Limit Value.

Test Mode: TX B Mode Channel 06

**Ant 90°**

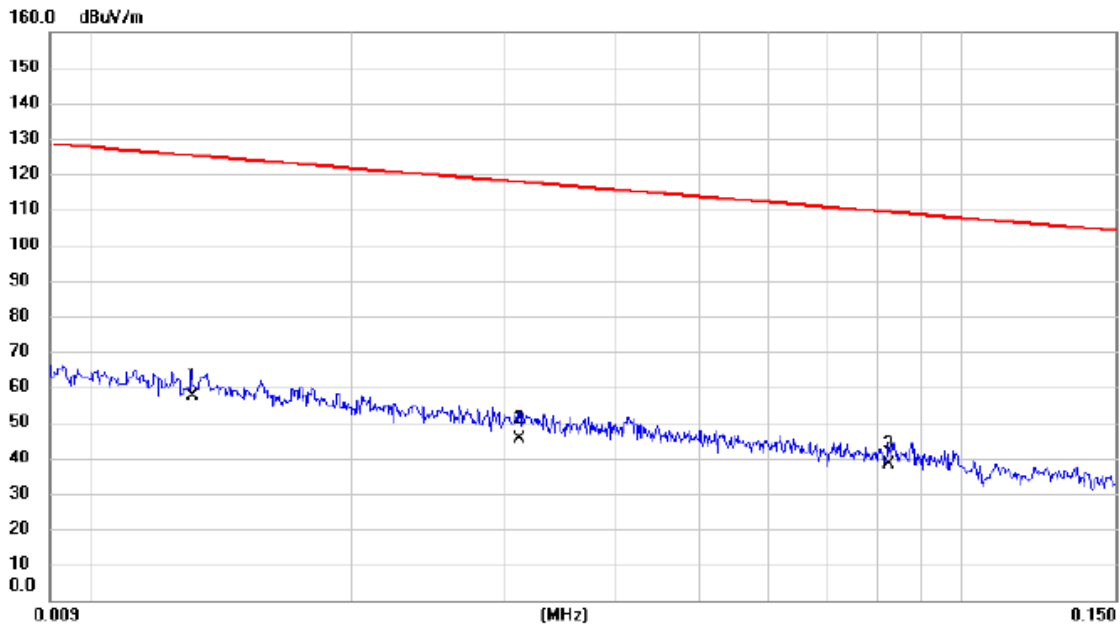

No.	Mk.	Freq.	Reading Level	Correct Factor	Measurement	Limit	Margin	Detector	Comment
		MHz	dBuV	dB	dBuV/m	dBuV/m	dB		
1	*	0.0131	41.52	15.89	57.41	125.26	-67.85	AVG	
2		0.0311	31.64	13.86	45.50	117.75	-72.25	AVG	
3		0.0824	24.83	13.54	38.37	109.29	-70.92	AVG	

**REMARKS:**

- (1) Measurement Value = Reading Level + Correct Factor.
- (2) Margin Level = Measurement Value - Limit Value.

Test Mode: TX B Mode Channel 06

**Ant 90°**

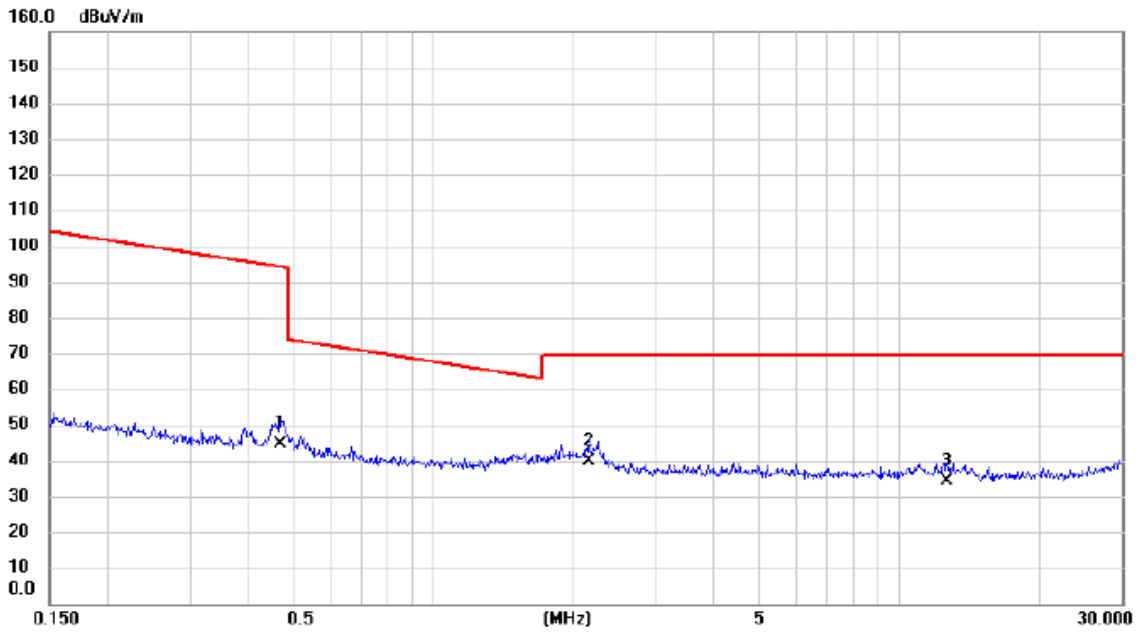

No.	Mk.	Freq. MHz	Reading Level dBuV	Correct Factor dB	Measure- ment dBuV/m	Limit dBuV/m	Margin dB	Detector	Comment
1		0.4686	31.28	13.14	44.42	94.19	-49.77	AVG	
2	*	2.1552	27.90	11.73	39.63	69.54	-29.91	QP	
3		12.6490	22.57	11.60	34.17	69.54	-35.37	QP	

**REMARKS:**

- (1) Measurement Value = Reading Level + Correct Factor.
- (2) Margin Level = Measurement Value - Limit Value.

## **APPENDIX C - RADIATED EMISSION - 30 MHZ TO 1000 MHZ**

Test Mode: TX B Mode Channel 06

### Vertical

80 dBuV/m

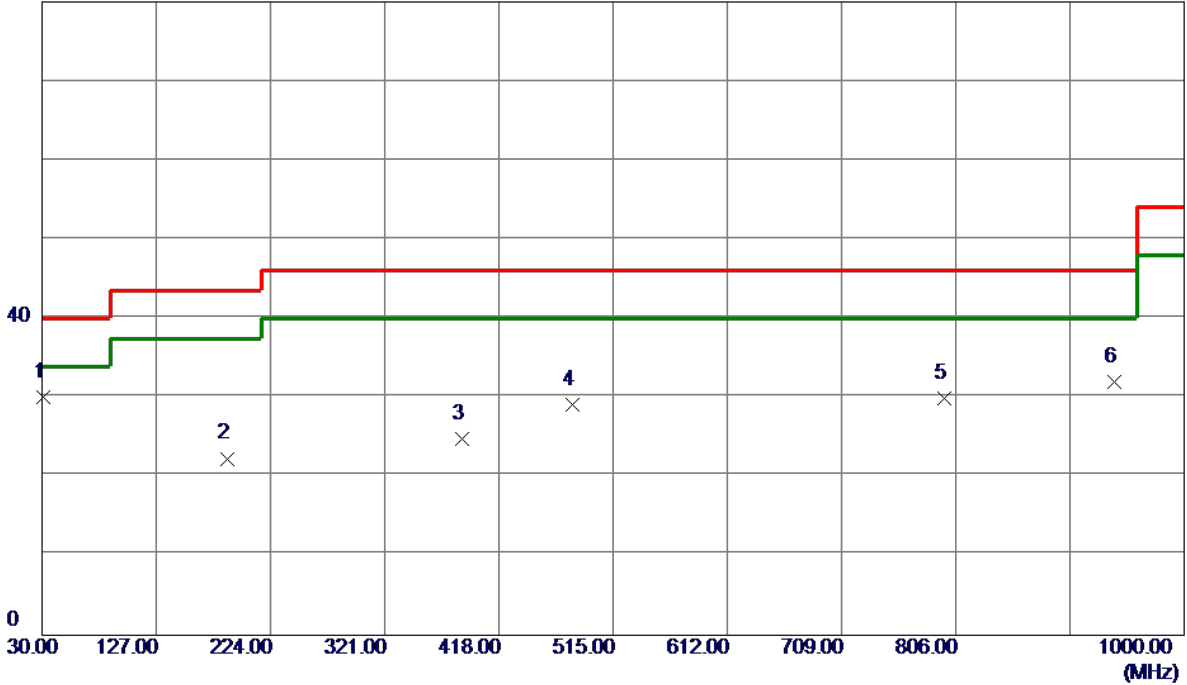

No.	Freq. MHz	Reading Level dBuV/m	Correct Factor dB	Measure ment dBuV/m	Limit dBuV/m	Margin dB	Detector	Comment
1 *	30.9700	44.98	-14.91	30.07	40.00	-9.93	Peak	
2	187.1400	36.47	-14.15	22.32	43.50	-21.18	Peak	
3	386.9600	34.64	-9.85	24.79	46.00	-21.21	Peak	
4	480.0800	37.03	-7.91	29.12	46.00	-16.88	Peak	
5	796.3000	32.94	-3.06	29.88	46.00	-16.12	Peak	
6	940.8300	32.98	-0.92	32.06	46.00	-13.94	Peak	

**REMARKS:**

- (1) Measurement Value = Reading Level + Correct Factor.
- (2) Margin Level = Measurement Value - Limit Value.

Test Mode: TX B Mode Channel 06

### Horizontal

80 dBuV/m

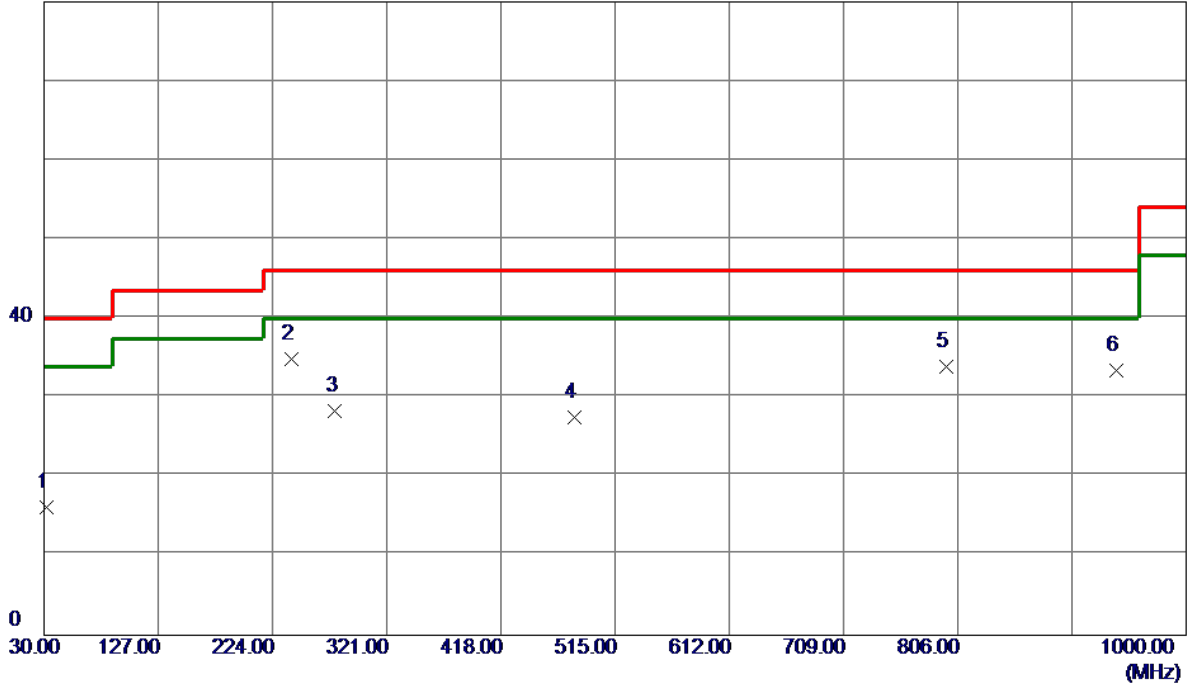

No.	Freq. MHz	Reading Level dBuV/m	Correct Factor dB	Measure ment dBuV/m	Limit dBuV/m	Margin dB	Detector	Comment
1	31.9400	30.96	-14.80	16.16	40.00	-23.84	Peak	
2 *	240.4900	48.99	-14.05	34.94	46.00	-11.06	Peak	
3	277.3500	41.15	-12.81	28.34	46.00	-17.66	Peak	
4	480.0800	35.50	-7.91	27.59	46.00	-18.41	Peak	
5	796.3000	36.99	-3.06	33.93	46.00	-12.07	Peak	
6	940.8300	34.39	-0.92	33.47	46.00	-12.53	Peak	

REMARKS:

- (1) Measurement Value = Reading Level + Correct Factor.
- (2) Margin Level = Measurement Value - Limit Value.



**APPENDIX D - RADIATED EMISSION- ABOVE 1000 MHZ**

Test Mode: TX B Mode 2412 MHz

### Vertical

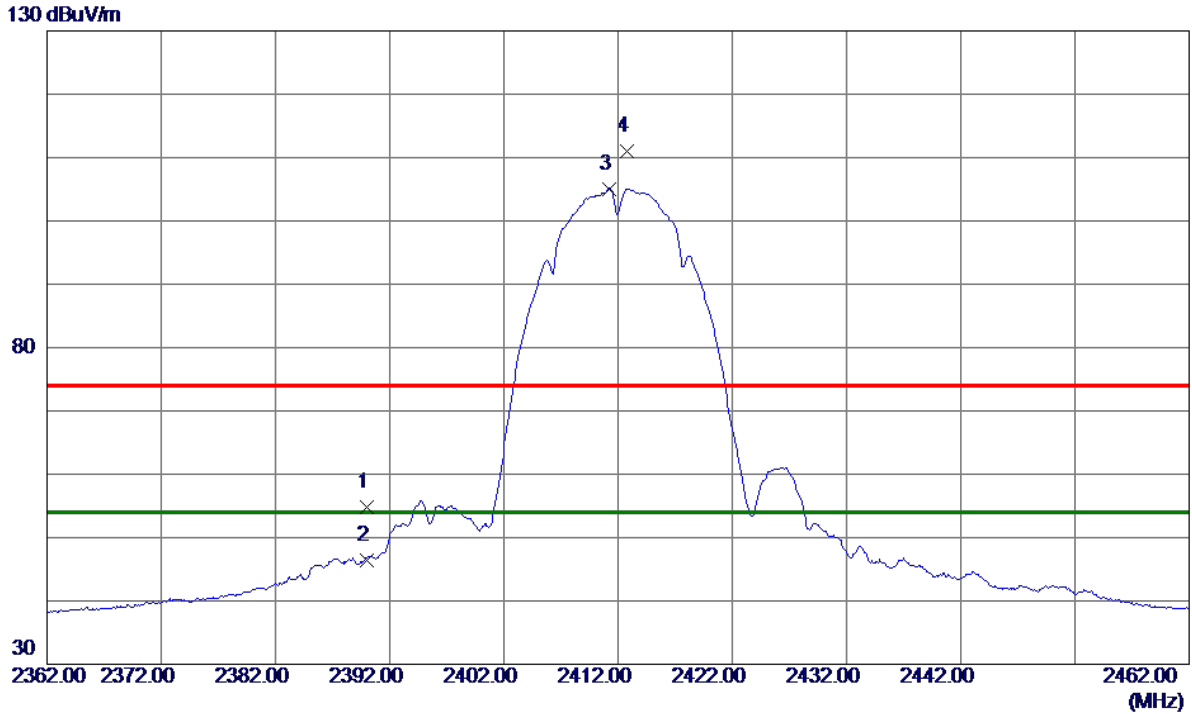

No.	Freq. MHz	Reading Level dBuV/m	Correct Factor dB	Measure ment dBuV/m	Limit dBuV/m	Margin dB	Detector	Comment
1	2390.0000	47.29	7.56	54.85	74.00	-19.15	Peak	
2	2390.0000	38.84	7.56	46.40	54.00	-7.60	AVG	
3 *	2411.2000	97.46	7.64	105.10	54.00	51.10	AVG	No Limit
4	2412.8000	103.45	7.64	111.09	74.00	37.09	Peak	

**REMARKS:**

- (1) Measurement Value = Reading Level + Correct Factor.
- (2) Margin Level = Measurement Value - Limit Value.

Test Mode: TX B Mode 2412 MHz

### Vertical

80 dBuV/m

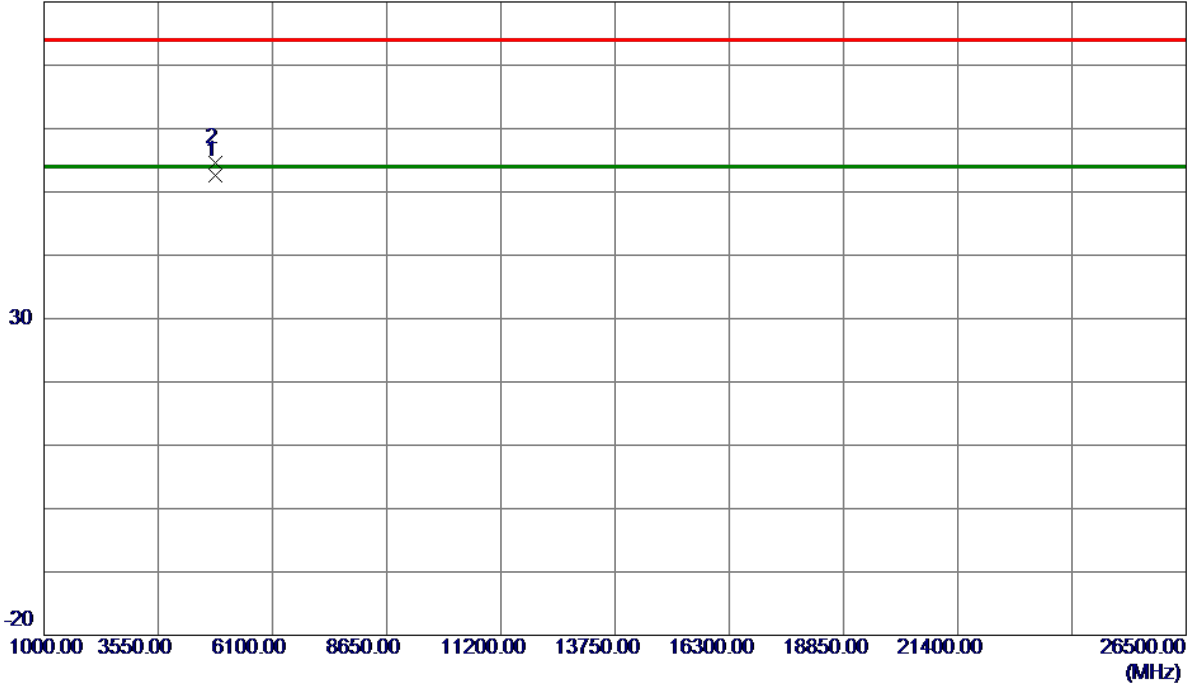

No.	Freq. MHz	Reading Level dBuV/m	Correct Factor dB	Measure ment dBuV/m	Limit dBuV/m	Margin dB	Detector	Comment
1 *	4824.0299	48.33	4.26	52.59	54.00	-1.41	AVG	
2	4824.0400	50.39	4.26	54.65	74.00	-19.35	Peak	

**REMARKS:**

- (1) Measurement Value = Reading Level + Correct Factor.
- (2) Margin Level = Measurement Value - Limit Value.

Test Mode: TX B Mode 2412 MHz

### Horizontal

130 dBuV/m

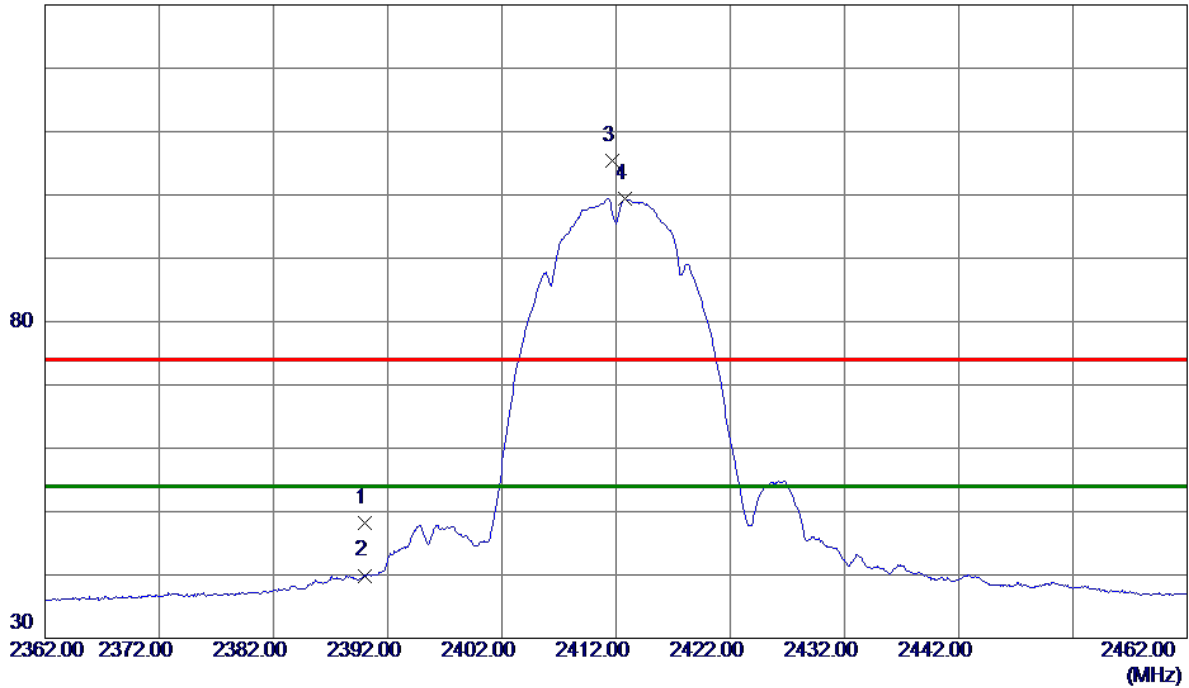

No.	Freq. MHz	Reading Level dBuV/m	Correct Factor dB	Measure ment dBuV/m	Limit dBuV/m	Margin dB	Detector	Comment
1	2390.0000	40.67	7.56	48.23	74.00	-25.77	Peak	
2	2390.0000	32.34	7.56	39.90	54.00	-14.10	AVG	
3	2411.7000	97.76	7.64	105.40	74.00	31.40	Peak	No Limit
4 *	2412.7500	91.75	7.64	99.39	54.00	45.39	AVG	No Limit

**REMARKS:**

- (1) Measurement Value = Reading Level + Correct Factor.
- (2) Margin Level = Measurement Value - Limit Value.

Test Mode: TX B Mode 2412 MHz

### Horizontal

80 dBuV/m

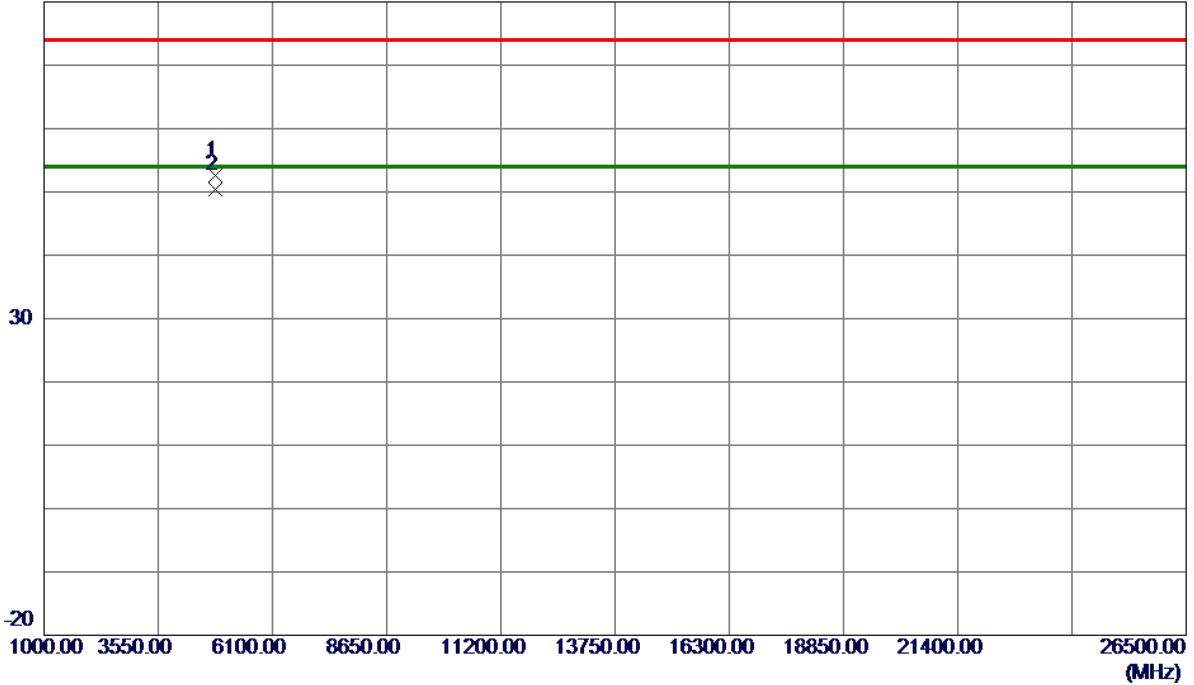

No.	Freq. MHz	Reading Level dBuV/m	Correct Factor dB	Measure ment dBuV/m	Limit dBuV/m	Margin dB	Detector	Comment
1	4823.9550	48.34	4.26	52.60	74.00	-21.40	Peak	
2 *	4824.0250	46.18	4.26	50.44	54.00	-3.56	AVG	

REMARKS:

(1) Measurement Value = Reading Level + Correct Factor.

(2) Margin Level = Measurement Value - Limit Value.

Test Mode: TX B Mode 2437 MHz

**Vertical**

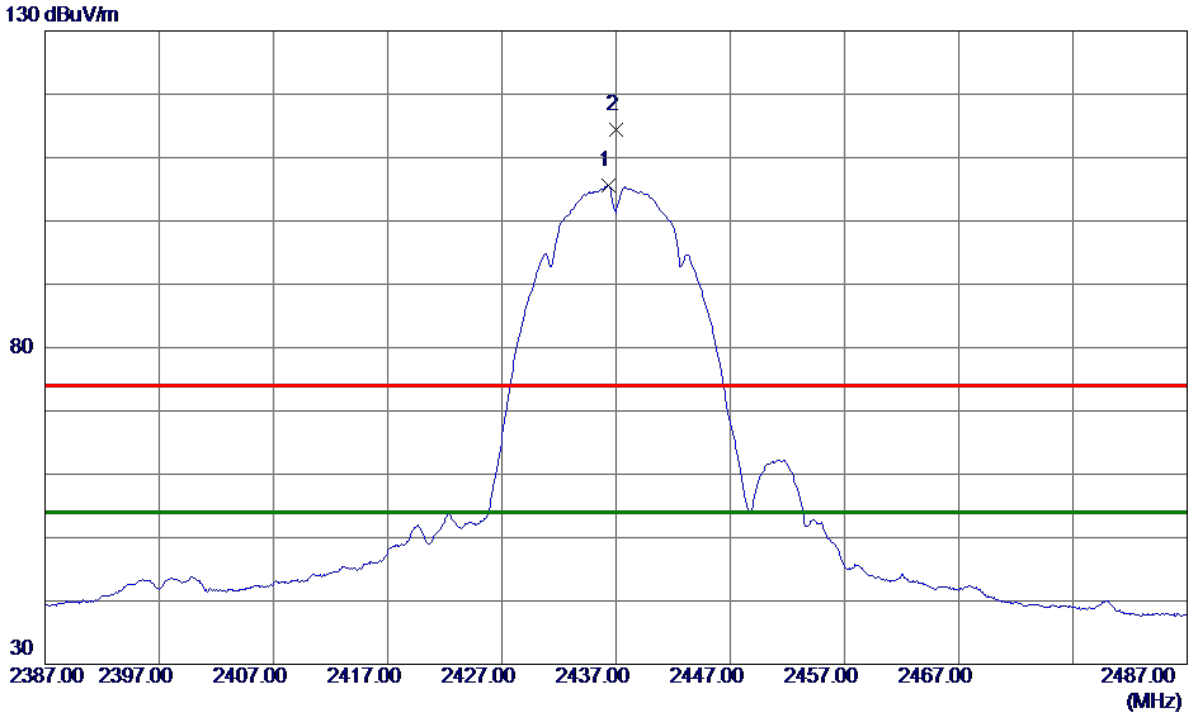

No.	Freq. MHz	Reading Level dBuV/m	Correct Factor dB	Measure ment dBuV/m	Limit dBuV/m	Margin dB	Detector	Comment
1 *	2436.3000	97.80	7.72	105.52	54.00	51.52	AVG	No Limit
2	2437.0000	106.69	7.72	114.41	74.00	40.41	Peak	No Limit

**REMARKS:**

- (1) Measurement Value = Reading Level + Correct Factor.
- (2) Margin Level = Measurement Value - Limit Value.

Test Mode: TX B Mode 2437 MHz

### Vertical

80 dBuV/m

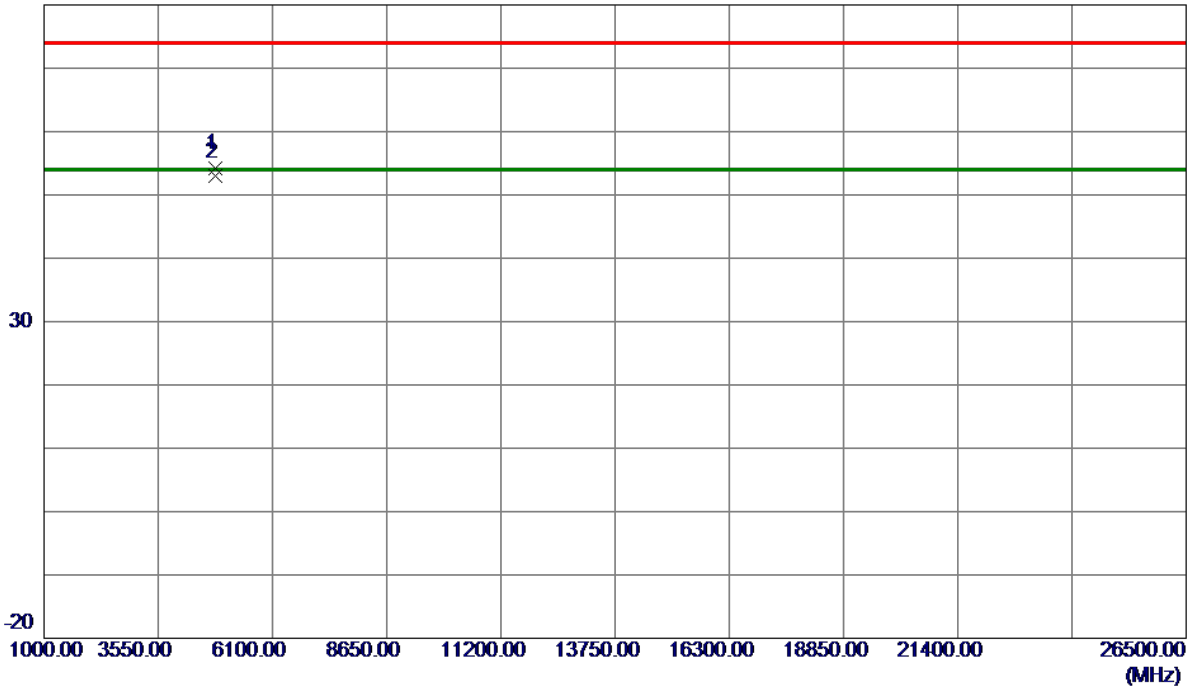

No.	Freq. MHz	Reading Level dBuV/m	Correct Factor dB	Measure ment dBuV/m	Limit dBuV/m	Margin dB	Detector	Comment
1	4833.9200	49.98	4.29	54.27	74.00	-19.73	Peak	
2 *	4834.0400	48.61	4.29	52.90	54.00	-1.10	AVG	

**REMARKS:**

- (1) Measurement Value = Reading Level + Correct Factor.
- (2) Margin Level = Measurement Value - Limit Value.

Test Mode: TX B Mode 2437 MHz

### Horizontal

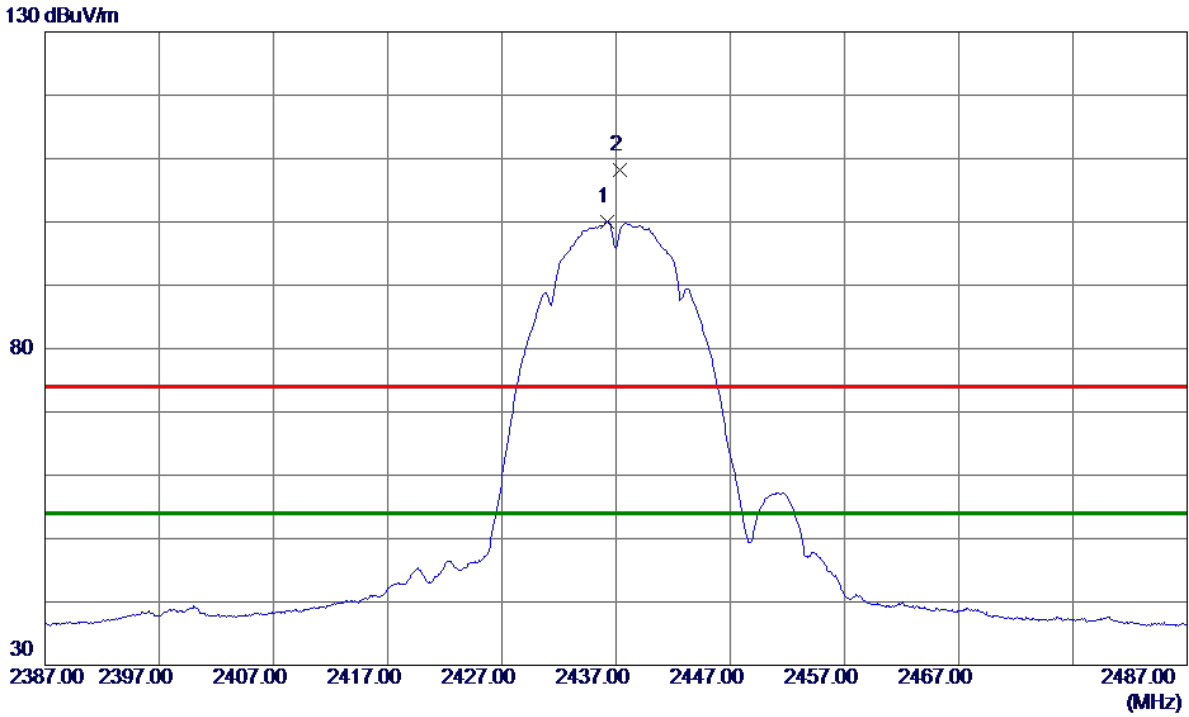

No.	Freq. MHz	Reading Level dBuV/m	Correct Factor dB	Measure ment dBuV/m	Limit dBuV/m	Margin dB	Detector	Comment
1 *	2436.2500	92.35	7.72	100.07	54.00	46.07	AVG	No Limit
2	2437.3500	100.50	7.72	108.22	74.00	34.22	Peak	No Limit

**REMARKS:**

- (1) Measurement Value = Reading Level + Correct Factor.
- (2) Margin Level = Measurement Value - Limit Value.



Test Mode: TX B Mode 2437 MHz

### Horizontal

80 dBuV/m

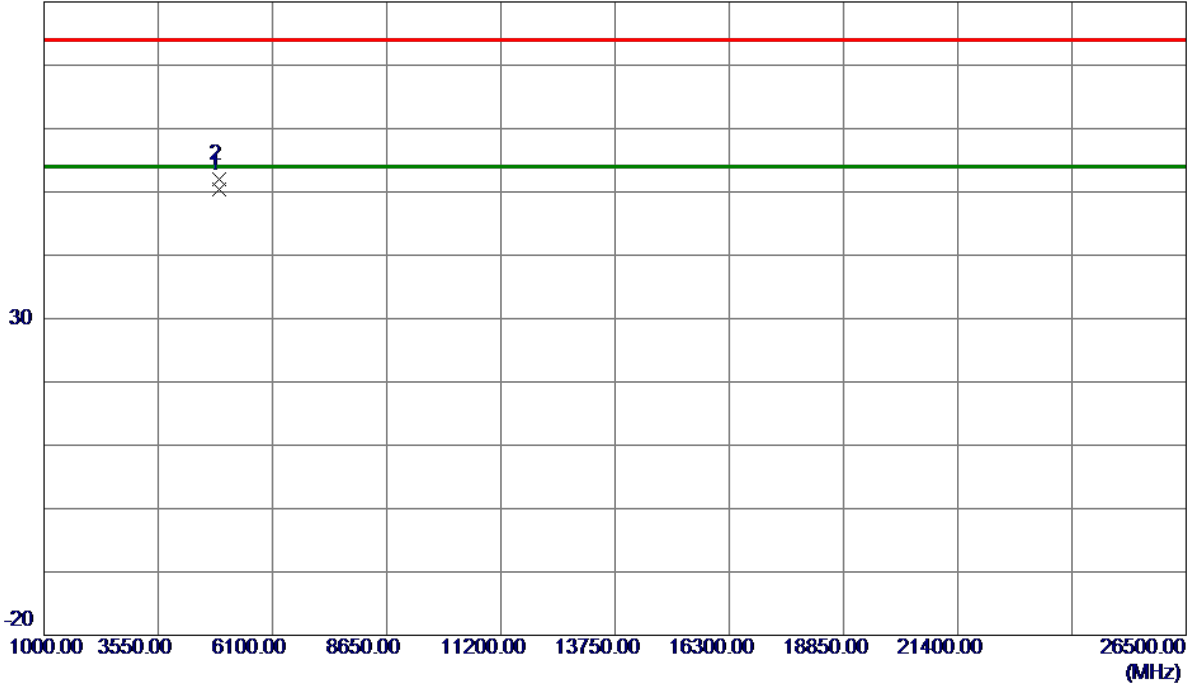

No.	Freq. MHz	Reading Level dBuV/m	Correct Factor dB	Measure ment dBuV/m	Limit dBuV/m	Margin dB	Detector	Comment
1 *	4914.0150	45.88	4.59	50.47	54.00	-3.53	AVG	
2	4914.0450	47.42	4.59	52.01	74.00	-21.99	Peak	

**REMARKS:**

(1) Measurement Value = Reading Level + Correct Factor.

(2) Margin Level = Measurement Value - Limit Value.

Test Mode: TX B Mode 2462 MHz

### Vertical

130 dBuV/m

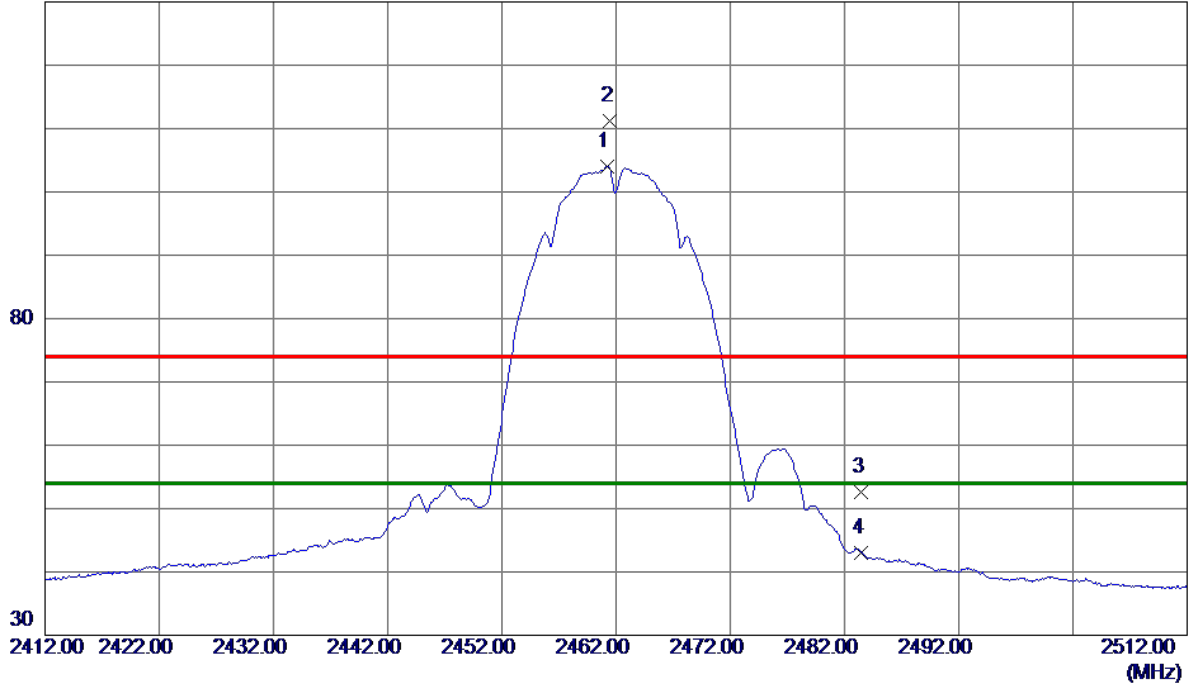

No.	Freq. MHz	Reading Level dBuV/m	Correct Factor dB	Measure ment dBuV/m	Limit dBuV/m	Margin dB	Detector	Comment
1 *	2461.2500	96.20	7.80	104.00	54.00	50.00	AVG	No Limit
2	2461.5000	103.43	7.80	111.23	74.00	37.23	Peak	No Limit
3	2483.5000	44.79	7.88	52.67	74.00	-21.33	Peak	
4	2483.5000	35.12	7.88	43.00	54.00	-11.00	AVG	

**REMARKS:**

- (1) Measurement Value = Reading Level + Correct Factor.
- (2) Margin Level = Measurement Value - Limit Value.

Test Mode: TX B Mode 2462 MHz

### Vertical

80 dBuV/m

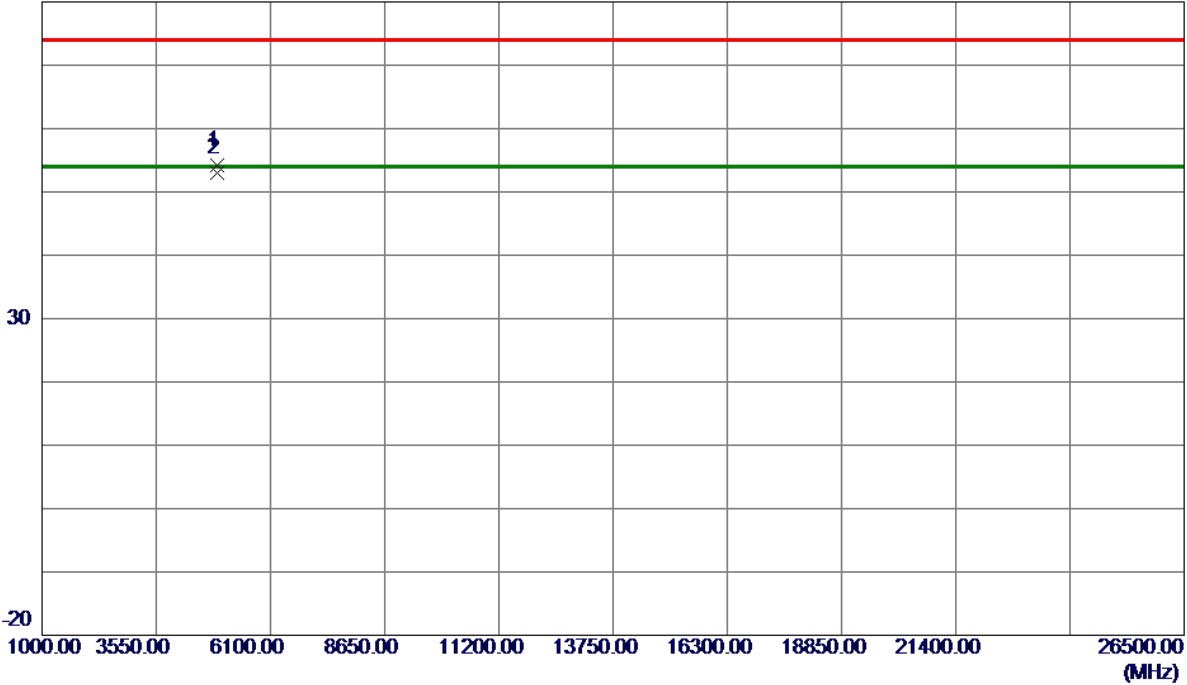

No.	Freq. MHz	Reading Level dBuV/m	Correct Factor dB	Measure ment dBuV/m	Limit dBuV/m	Margin dB	Detector	Comment
1	4923.9750	49.48	4.63	54.11	74.00	-19.89	Peak	
2 *	4924.0150	48.35	4.63	52.98	54.00	-1.02	AVG	

**REMARKS:**

- (1) Measurement Value = Reading Level + Correct Factor.
- (2) Margin Level = Measurement Value - Limit Value.

Test Mode: TX B Mode 2462 MHz

### Horizontal

130 dBuV/m

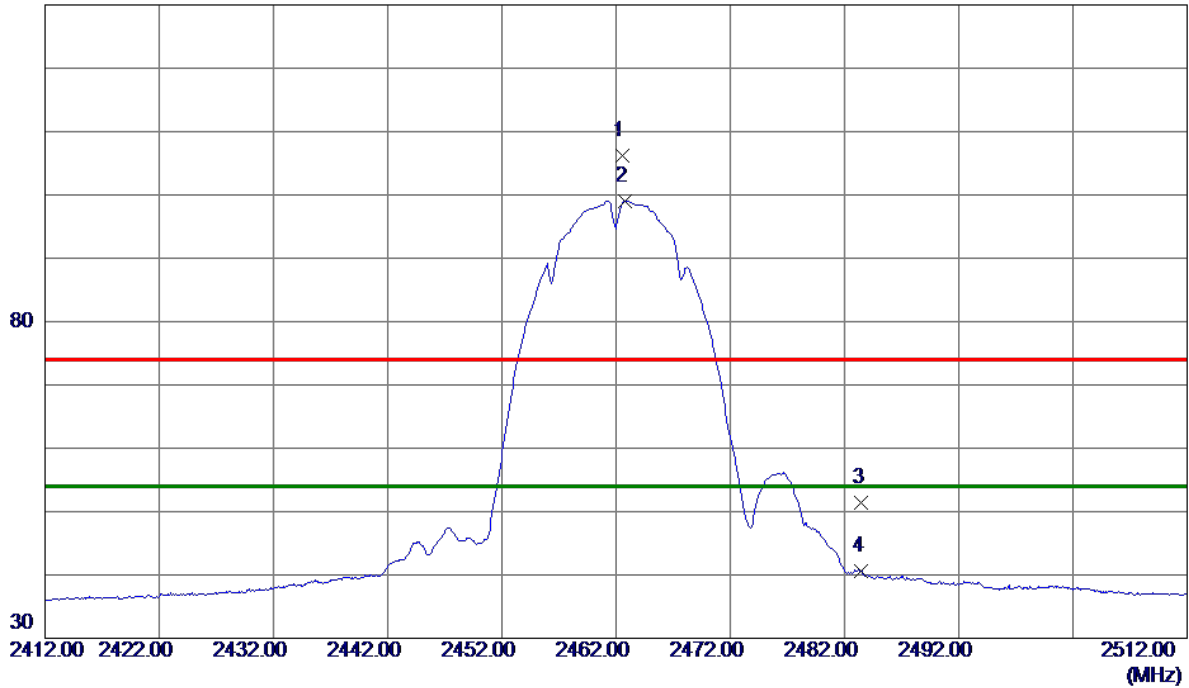

No.	Freq. MHz	Reading Level dBuV/m	Correct Factor dB	Measure ment dBuV/m	Limit dBuV/m	Margin dB	Detector	Comment
1	2462.6000	98.38	7.81	106.19	74.00	32.19	Peak	No Limit
2 *	2462.7500	91.26	7.81	99.07	54.00	45.07	AVG	No Limit
3	2483.5000	43.58	7.88	51.46	74.00	-22.54	Peak	
4	2483.5000	32.71	7.88	40.59	54.00	-13.41	AVG	

**REMARKS:**

- (1) Measurement Value = Reading Level + Correct Factor.
- (2) Margin Level = Measurement Value - Limit Value.

Test Mode: TX B Mode 2462 MHz

### Horizontal

80 dBuV/m

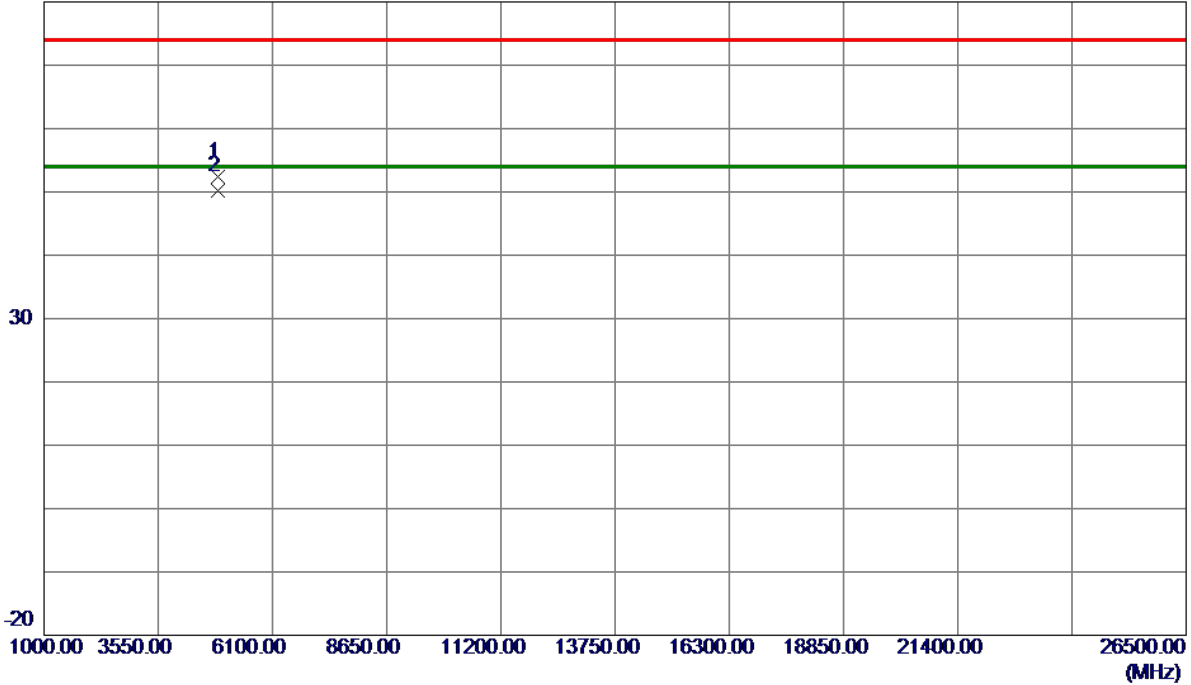

No.	Freq. MHz	Reading Level dBuV/m	Correct Factor dB	Measure ment dBuV/m	Limit dBuV/m	Margin dB	Detector	Comment
1	4873.9800	48.03	4.44	52.47	74.00	-21.53	Peak	
2 *	4873.9850	45.80	4.44	50.24	54.00	-3.76	AVG	

**REMARKS:**

(1) Measurement Value = Reading Level + Correct Factor.

(2) Margin Level = Measurement Value - Limit Value.

Test Mode: TX G Mode 2412 MHz

### Vertical

130 dBuV/m

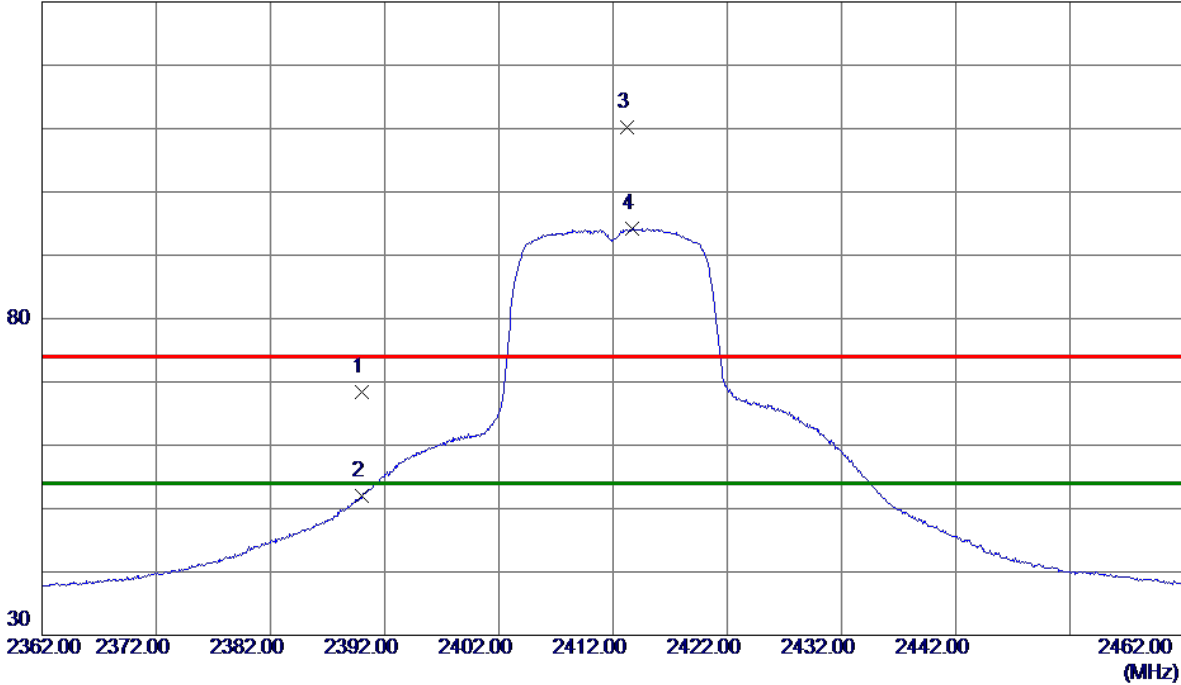

No.	Freq. MHz	Reading Level dBuV/m	Correct Factor dB	Measure ment dBuV/m	Limit dBuV/m	Margin dB	Detector	Comment
1	2390.0000	60.82	7.56	68.38	74.00	-5.62	Peak	
2	2390.0000	44.36	7.56	51.92	54.00	-2.08	AVG	
3	2413.2000	102.55	7.64	110.19	74.00	36.19	Peak	No Limit
4 *	2413.7000	86.55	7.64	94.19	54.00	40.19	AVG	No Limit

**REMARKS:**

- (1) Measurement Value = Reading Level + Correct Factor.
- (2) Margin Level = Measurement Value - Limit Value.

Test Mode: TX G Mode 2412 MHz

### Vertical

80 dBuV/m

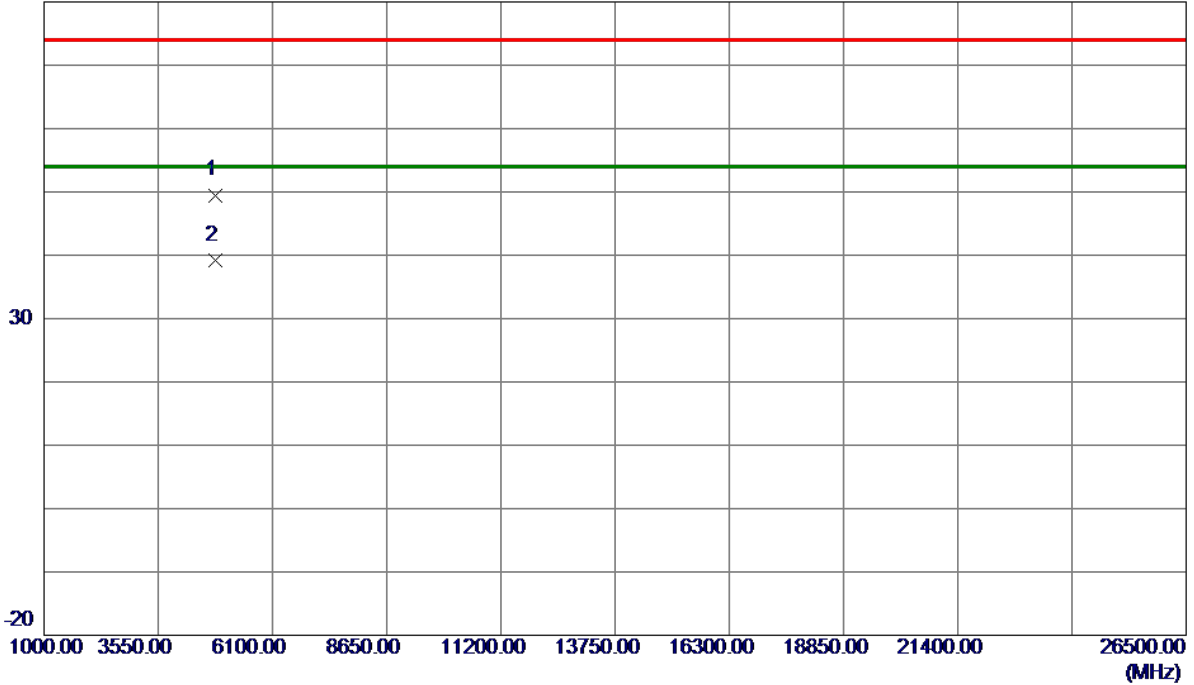

No.	Freq. MHz	Reading Level dBuV/m	Correct Factor dB	Measure ment dBuV/m	Limit dBuV/m	Margin dB	Detector	Comment
1	4822.0900	45.25	4.25	49.50	74.00	-24.50	Peak	
2 *	4823.2250	34.93	4.25	39.18	54.00	-14.82	AVG	

**REMARKS:**

- (1) Measurement Value = Reading Level + Correct Factor.
- (2) Margin Level = Measurement Value - Limit Value.

Test Mode: TX G Mode 2412 MHz

### Horizontal

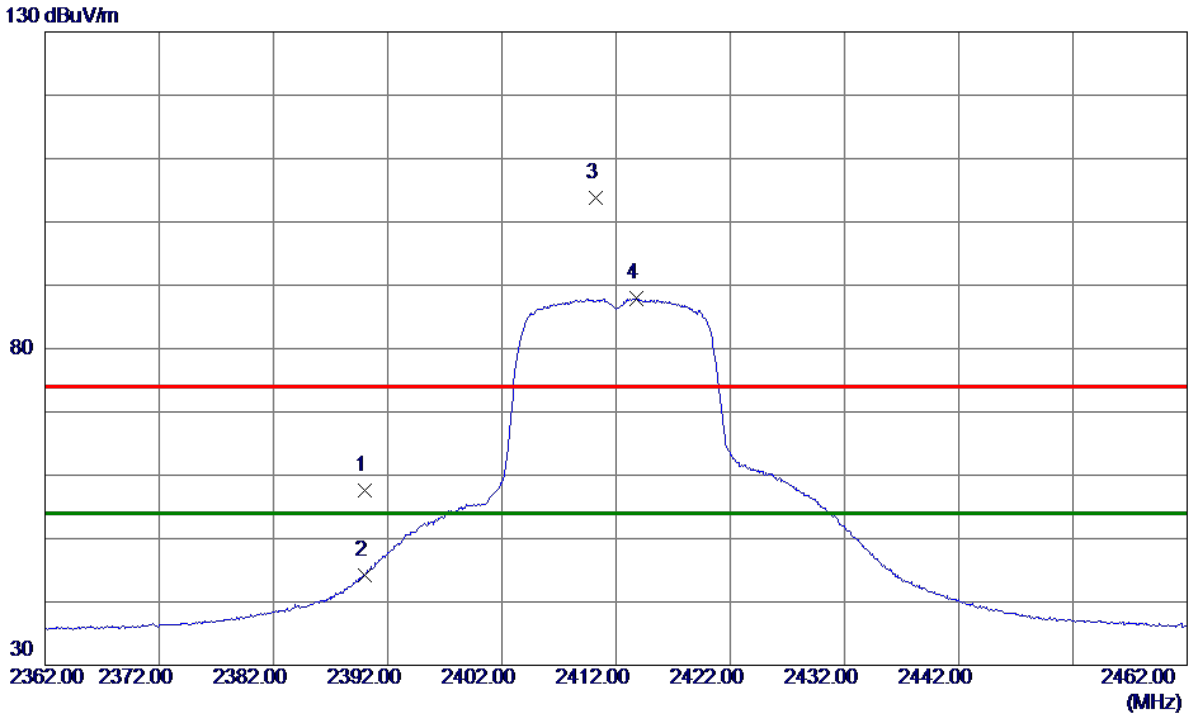

No.	Freq. MHz	Reading Level dBuV/m	Correct Factor dB	Measure ment dBuV/m	Limit dBuV/m	Margin dB	Detector	Comment
1	2390.0000	49.96	7.56	57.52	74.00	-16.48	Peak	
2	2390.0000	36.71	7.56	44.27	54.00	-9.73	AVG	
3	2410.2000	96.12	7.63	103.75	74.00	29.75	Peak	No Limit
4 *	2413.8000	80.26	7.64	87.90	54.00	33.90	AVG	No Limit

**REMARKS:**

- (1) Measurement Value = Reading Level + Correct Factor.
- (2) Margin Level = Measurement Value - Limit Value.



Test Mode: TX G Mode 2412 MHz

### Horizontal

80 dBuV/m

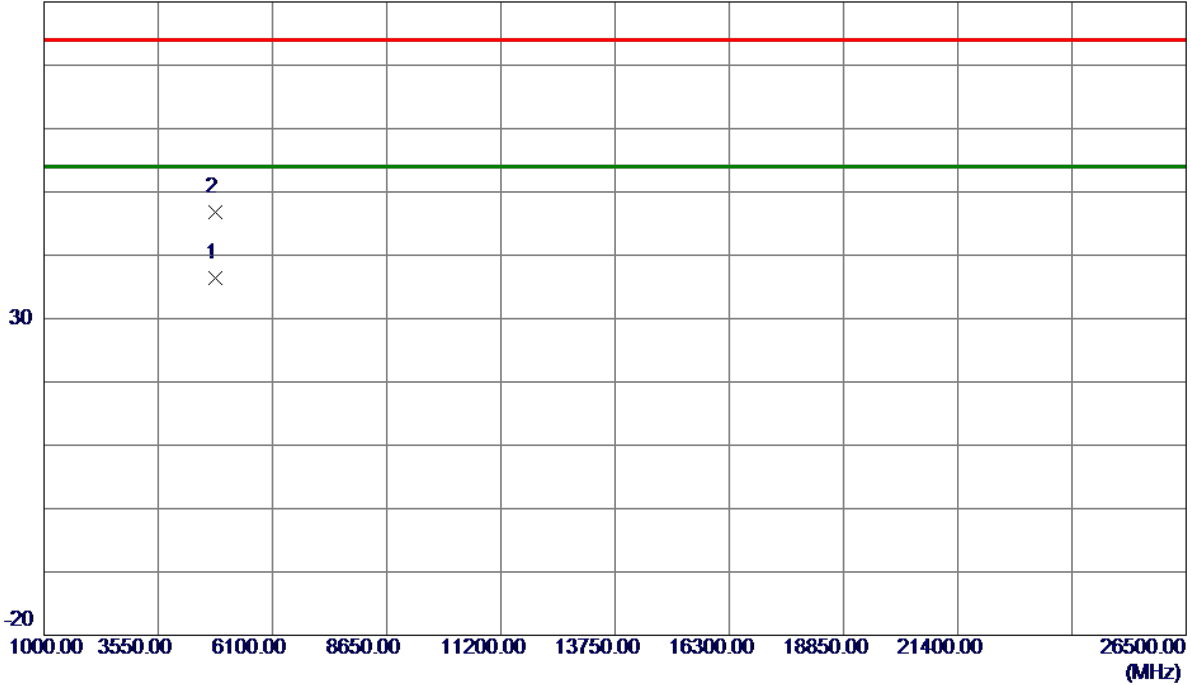

No.	Freq. MHz	Reading Level dBuV/m	Correct Factor dB	Measure ment dBuV/m	Limit dBuV/m	Margin dB	Detector	Comment
1 *	4833.0250	32.16	4.29	36.45	54.00	-17.55	AVG	
2	4835.0750	42.44	4.30	46.74	74.00	-27.26	Peak	

**REMARKS:**

(1) Measurement Value = Reading Level + Correct Factor.

(2) Margin Level = Measurement Value - Limit Value.

Test Mode: TX G Mode 2437 MHz

### Vertical

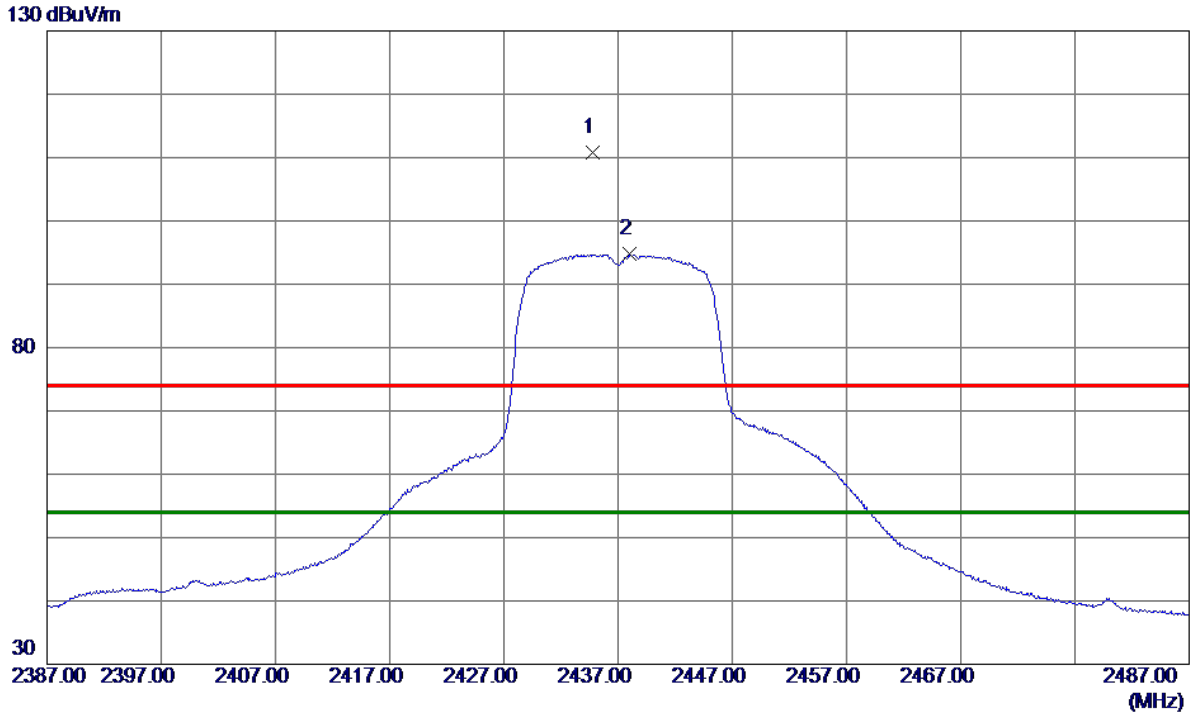

No.	Freq. MHz	Reading Level dBuV/m	Correct Factor dB	Measure ment dBuV/m	Limit dBuV/m	Margin dB	Detector	Comment
1	2434.8000	103.04	7.71	110.75	74.00	36.75	Peak	No Limit
2 *	2438.0500	86.99	7.72	94.71	54.00	40.71	AVG	No Limit

**REMARKS:**

- (1) Measurement Value = Reading Level + Correct Factor.
- (2) Margin Level = Measurement Value - Limit Value.

Test Mode: TX G Mode 2437 MHz

### Vertical

80 dBuV/m

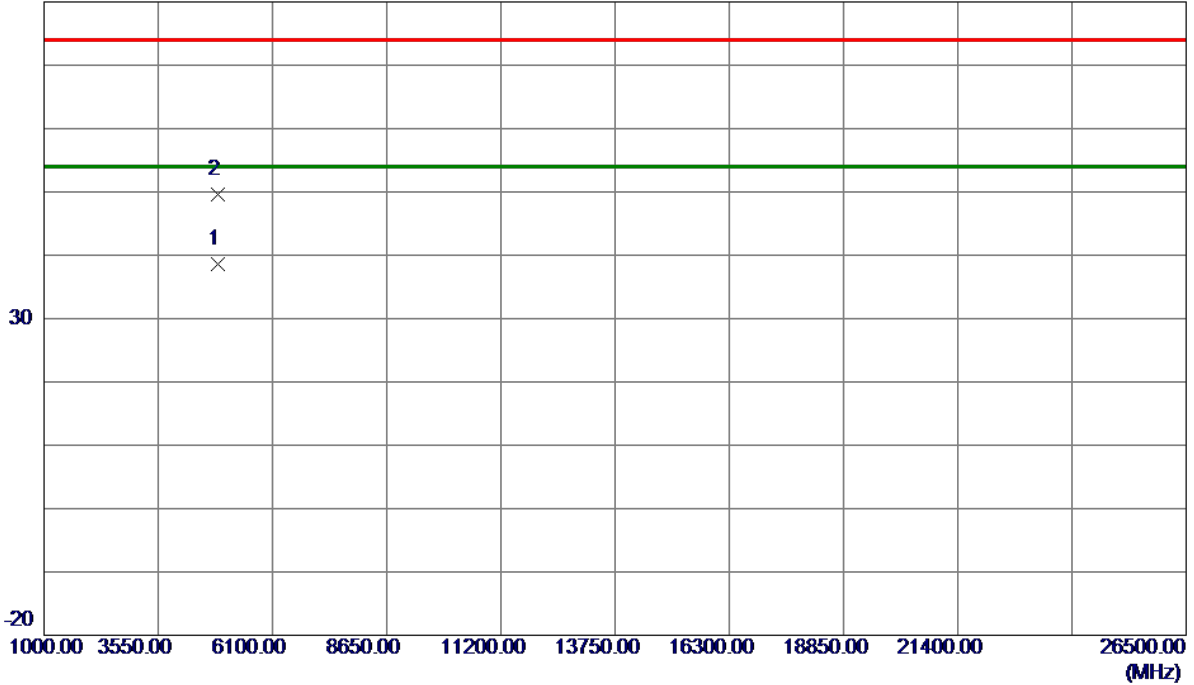

No.	Freq. MHz	Reading Level dBuV/m	Correct Factor dB	Measure ment dBuV/m	Limit dBuV/m	Margin dB	Detector	Comment
1 *	4873.1050	34.16	4.44	38.60	54.00	-15.40	AVG	
2	4877.5950	45.10	4.45	49.55	74.00	-24.45	Peak	

**REMARKS:**

- (1) Measurement Value = Reading Level + Correct Factor.
- (2) Margin Level = Measurement Value - Limit Value.

Test Mode: TX G Mode 2437 MHz

### Horizontal

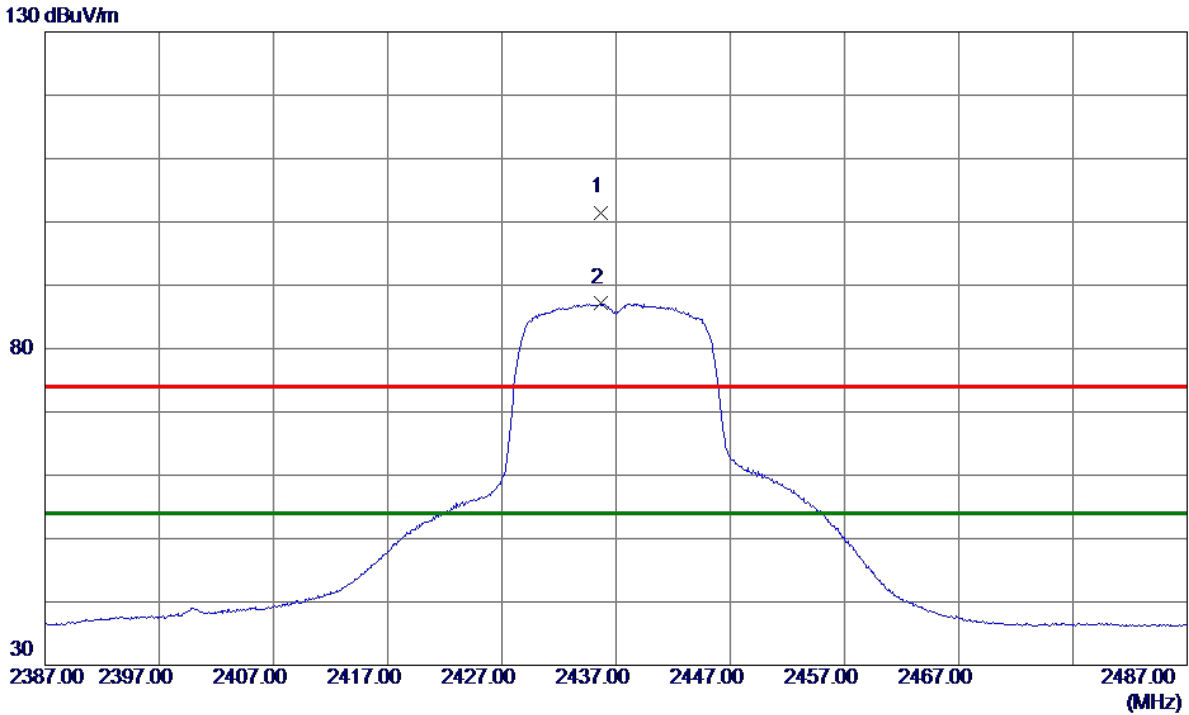

No.	Freq. MHz	Reading Level dBuV/m	Correct Factor dB	Measure ment dBuV/m	Limit dBuV/m	Margin dB	Detector	Comment
1	2435.6500	93.78	7.72	101.50	74.00	27.50	Peak	No Limit
2 *	2435.6500	79.49	7.72	87.21	54.00	33.21	AVG	No Limit

**REMARKS:**

- (1) Measurement Value = Reading Level + Correct Factor.
- (2) Margin Level = Measurement Value - Limit Value.

Test Mode: TX G Mode 2437 MHz

### Horizontal

80 dBuV/m

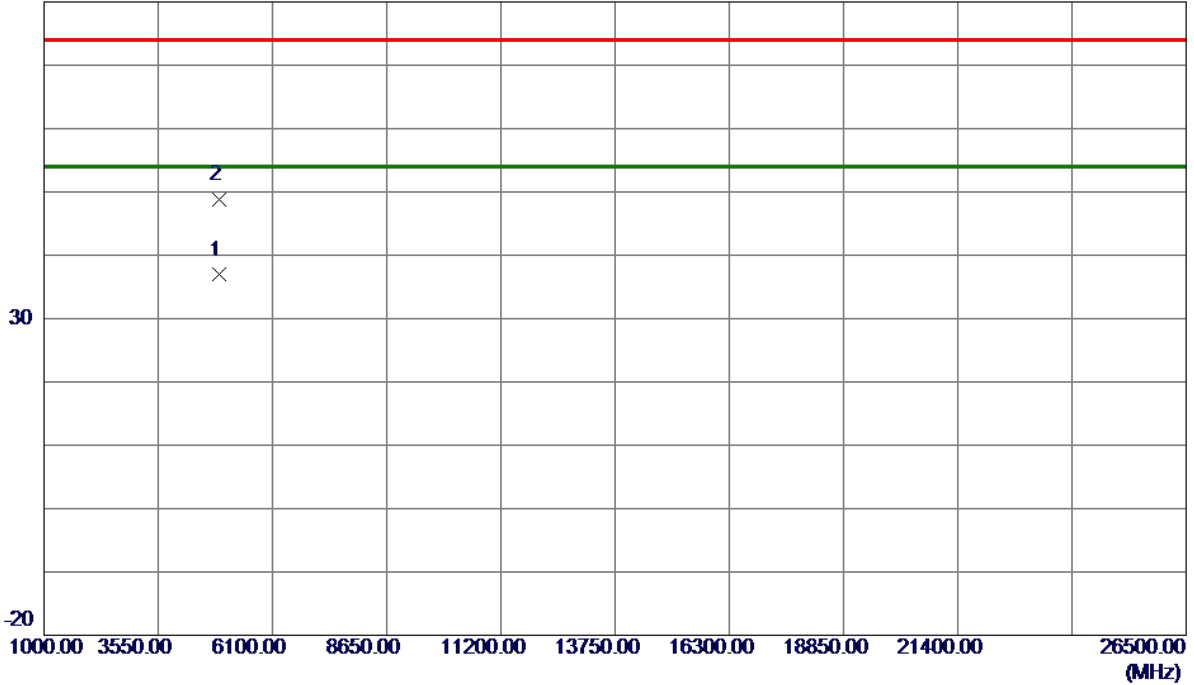

No.	Freq. MHz	Reading Level dBuV/m	Correct Factor dB	Measure ment dBuV/m	Limit dBuV/m	Margin dB	Detector	Comment
1 *	4912.9100	32.31	4.59	36.90	54.00	-17.10	AVG	
2	4915.7650	44.20	4.60	48.80	74.00	-25.20	Peak	

REMARKS:

- (1) Measurement Value = Reading Level + Correct Factor.
- (2) Margin Level = Measurement Value - Limit Value.

Test Mode: TX G Mode 2462 MHz

### Vertical

130 dBuV/m

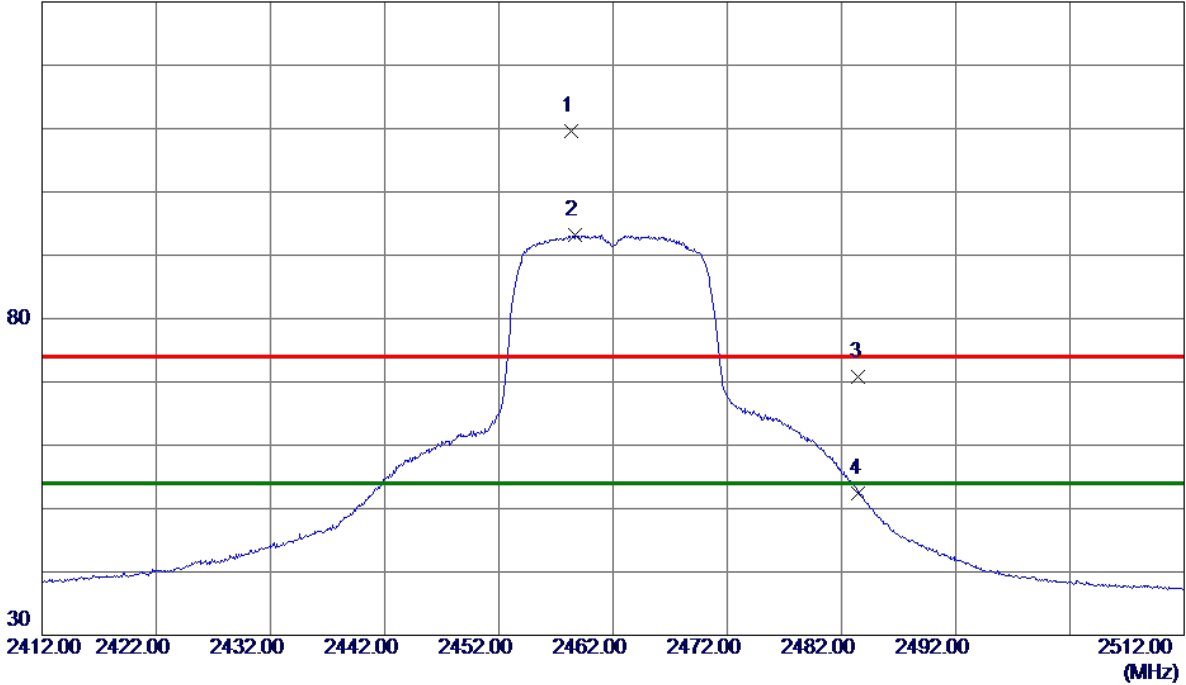

No.	Freq. MHz	Reading Level dBuV/m	Correct Factor dB	Measure ment dBuV/m	Limit dBuV/m	Margin dB	Detector	Comment
1	2458.3500	101.78	7.79	109.57	74.00	35.57	Peak	No Limit
2 *	2458.7000	85.49	7.79	93.28	54.00	39.28	AVG	No Limit
3	2483.5000	62.90	7.88	70.78	74.00	-3.22	Peak	
4	2483.5000	44.51	7.88	52.39	54.00	-1.61	AVG	

**REMARKS:**

- (1) Measurement Value = Reading Level + Correct Factor.
- (2) Margin Level = Measurement Value - Limit Value.

Test Mode: TX G Mode 2462 MHz

### Vertical

80 dBuV/m

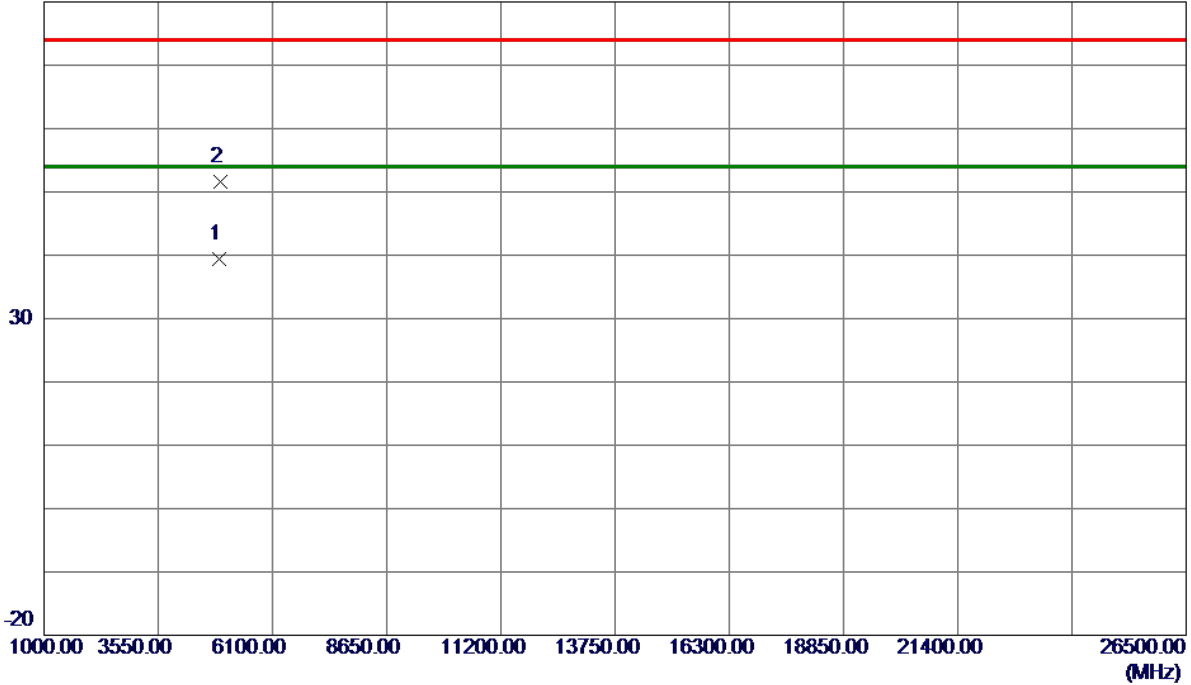

No.	Freq. MHz	Reading Level dBuV/m	Correct Factor dB	Measure ment dBuV/m	Limit dBuV/m	Margin dB	Detector	Comment
1 *	4923.0850	34.87	4.62	39.49	54.00	-14.51	AVG	
2	4925.6450	47.01	4.63	51.64	74.00	-22.36	Peak	

**REMARKS:**

- (1) Measurement Value = Reading Level + Correct Factor.
- (2) Margin Level = Measurement Value - Limit Value.

Test Mode: TX G Mode 2462 MHz

### Horizontal

130 dBuV/m

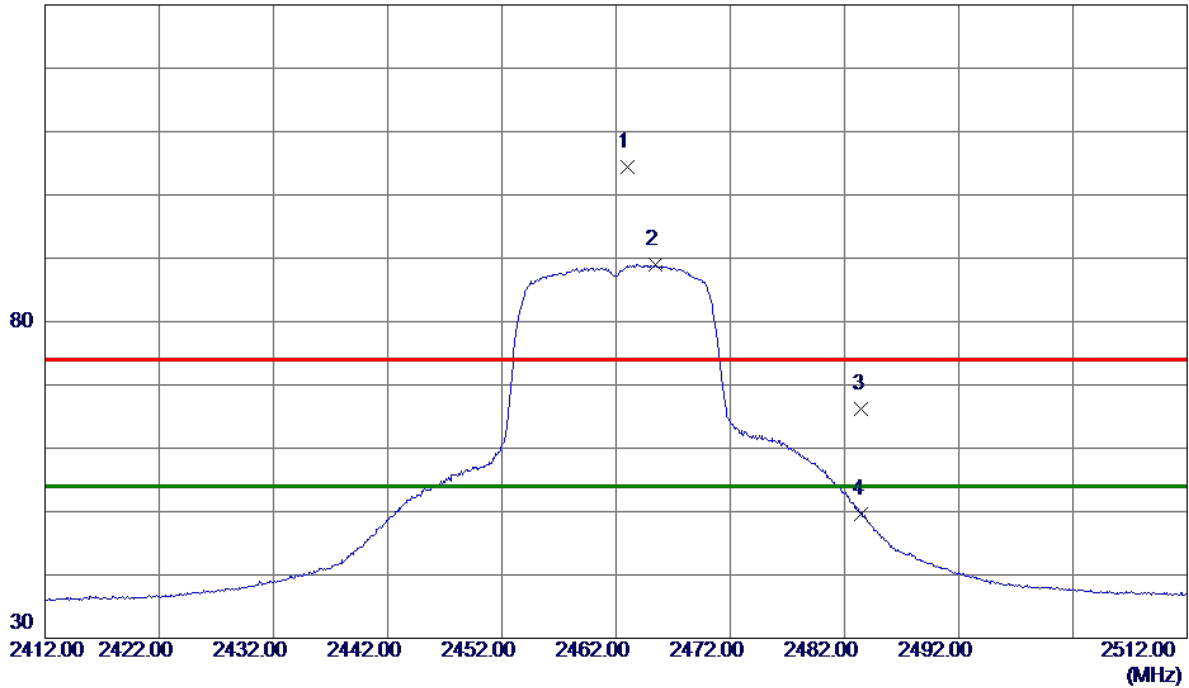

No.	Freq. MHz	Reading Level dBuV/m	Correct Factor dB	Measure ment dBuV/m	Limit dBuV/m	Margin dB	Detector	Comment
1	2463.0000	96.62	7.81	104.43	74.00	30.43	Peak	No Limit
2 *	2465.4500	81.12	7.82	88.94	54.00	34.94	AVG	No Limit
3	2483.5000	58.34	7.88	66.22	74.00	-7.78	Peak	
4	2483.5000	41.71	7.88	49.59	54.00	-4.41	AVG	

**REMARKS:**

- (1) Measurement Value = Reading Level + Correct Factor.
- (2) Margin Level = Measurement Value - Limit Value.



Test Mode: TX G Mode 2462 MHz

### Horizontal

80 dBuV/m

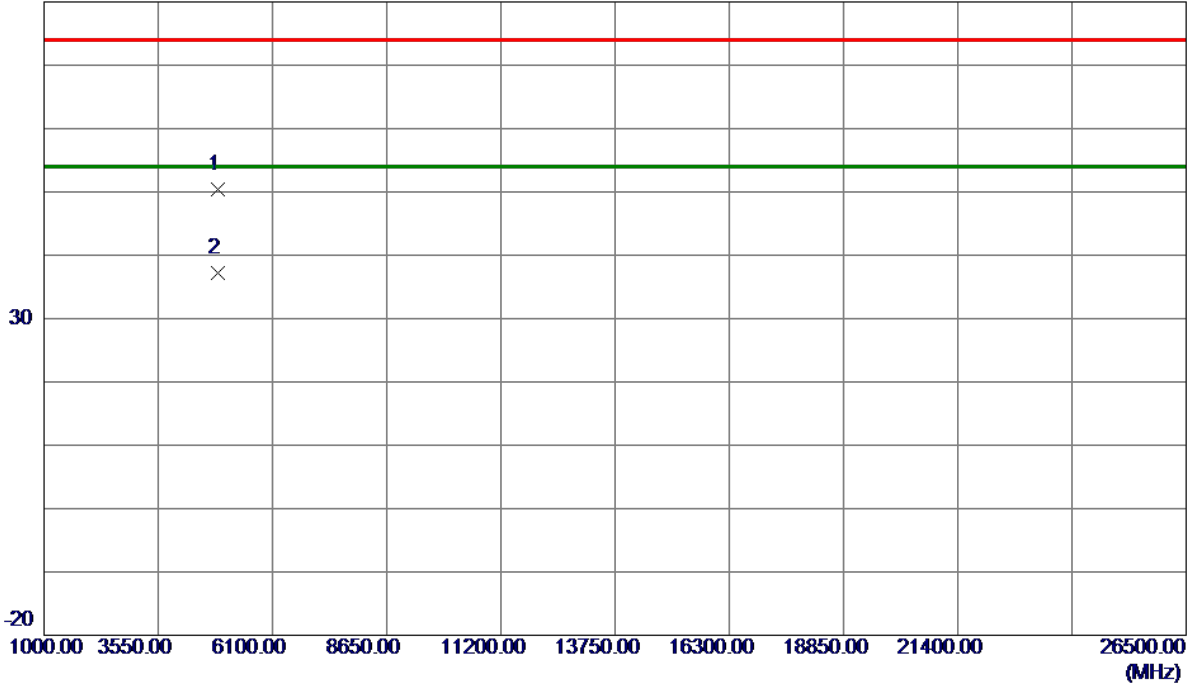

No.	Freq. MHz	Reading Level dBuV/m	Correct Factor dB	Measure ment dBuV/m	Limit dBuV/m	Margin dB	Detector	Comment
1	4873.9800	46.03	4.44	50.47	74.00	-23.53	Peak	
2 *	4873.9850	32.80	4.44	37.24	54.00	-16.76	AVG	

**REMARKS:**

- (1) Measurement Value = Reading Level + Correct Factor.
- (2) Margin Level = Measurement Value - Limit Value.

Test Mode: TX N-20M Mode 2412 MHz

### Vertical

130 dBuV/m

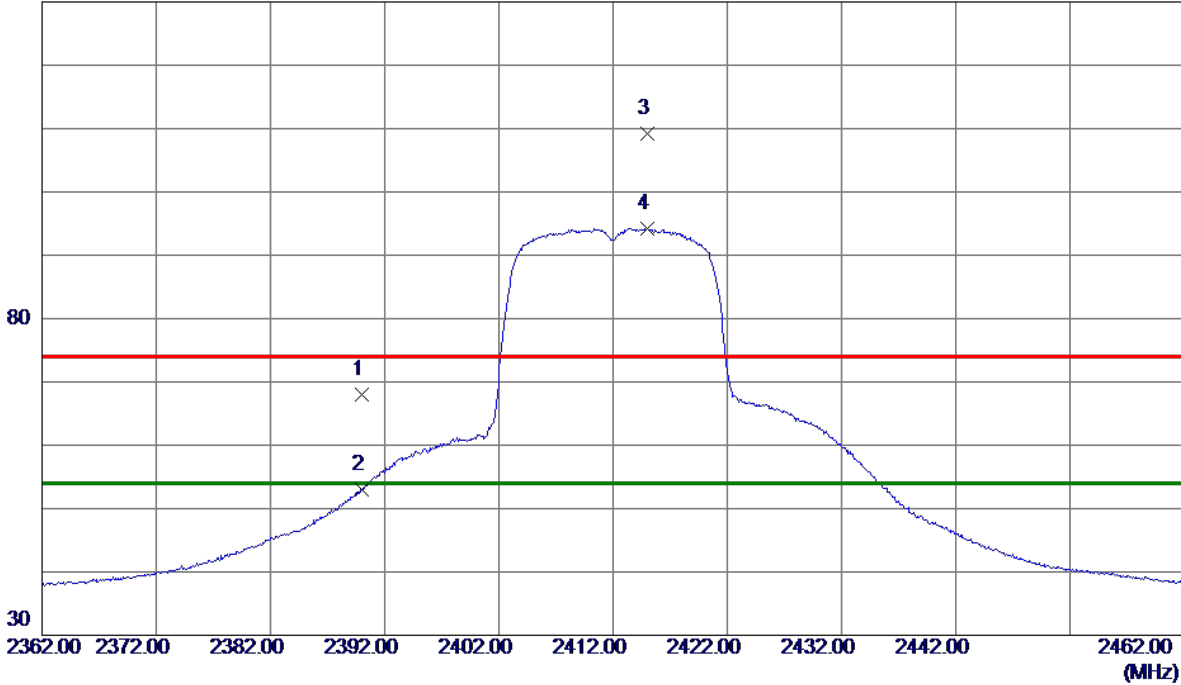

No.	Freq. MHz	Reading Level dBuV/m	Correct Factor dB	Measure ment dBuV/m	Limit dBuV/m	Margin dB	Detector	Comment
1	2390.0000	60.50	7.56	68.06	74.00	-5.94	Peak	
2	2390.0000	45.50	7.56	53.06	54.00	-0.94	AVG	
3	2415.0000	101.54	7.65	109.19	74.00	35.19	Peak	No Limit
4 *	2415.0500	86.54	7.65	94.19	54.00	40.19	AVG	No Limit

**REMARKS:**

- (1) Measurement Value = Reading Level + Correct Factor.
- (2) Margin Level = Measurement Value - Limit Value.

Test Mode: TX N-20M Mode 2412 MHz

### Vertical

80 dBuV/m

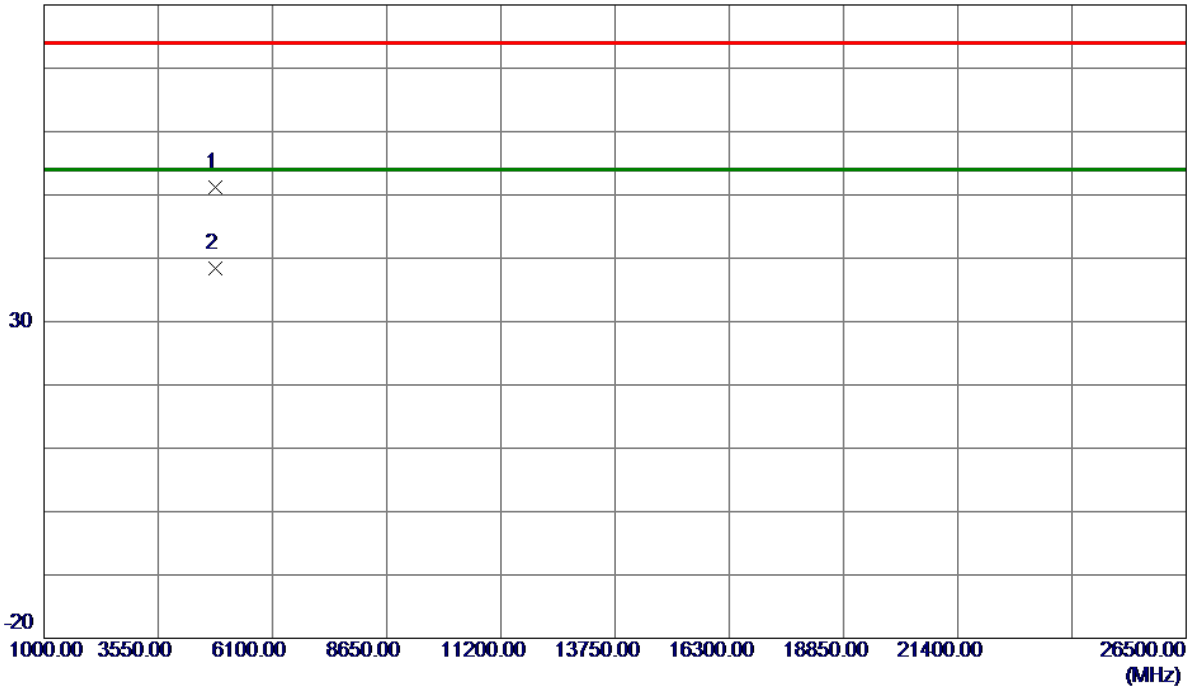

No.	Freq. MHz	Reading Level dBuV/m	Correct Factor dB	Measure ment dBuV/m	Limit dBuV/m	Margin dB	Detector	Comment
1	4822.0050	46.87	4.25	51.12	74.00	-22.88	Peak	
2 *	4822.7150	34.23	4.25	38.48	54.00	-15.52	AVG	

**REMARKS:**

- (1) Measurement Value = Reading Level + Correct Factor.
- (2) Margin Level = Measurement Value - Limit Value.

Test Mode: TX N-20M Mode 2412 MHz

### Horizontal

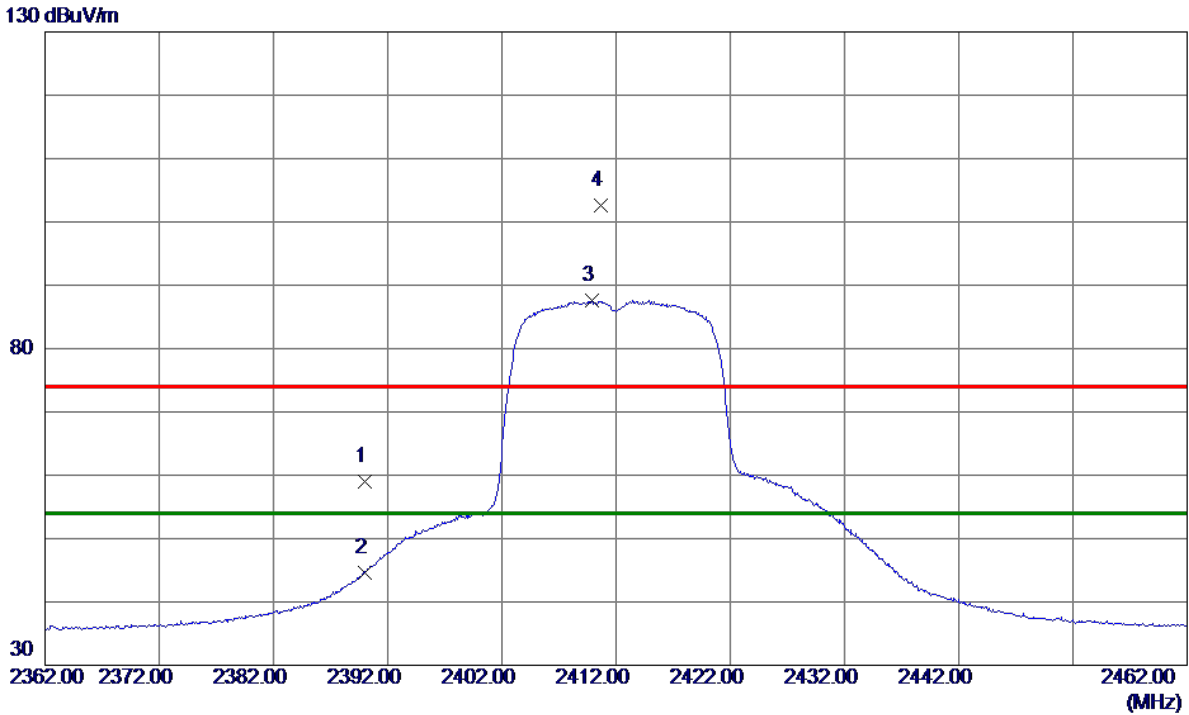

No.	Freq. MHz	Reading Level dBuV/m	Correct Factor dB	Measure ment dBuV/m	Limit dBuV/m	Margin dB	Detector	Comment
1	2390.0000	51.48	7.56	59.04	74.00	-14.96	Peak	
2	2390.0000	37.12	7.56	44.68	54.00	-9.32	AVG	
3 *	2409.9000	79.92	7.63	87.55	54.00	33.55	AVG	No Limit
4	2410.6500	94.89	7.63	102.52	74.00	28.52	Peak	No Limit

**REMARKS:**

- (1) Measurement Value = Reading Level + Correct Factor.
- (2) Margin Level = Measurement Value - Limit Value.

Test Mode: TX N-20M Mode 2412 MHz

### Horizontal

80 dBuV/m

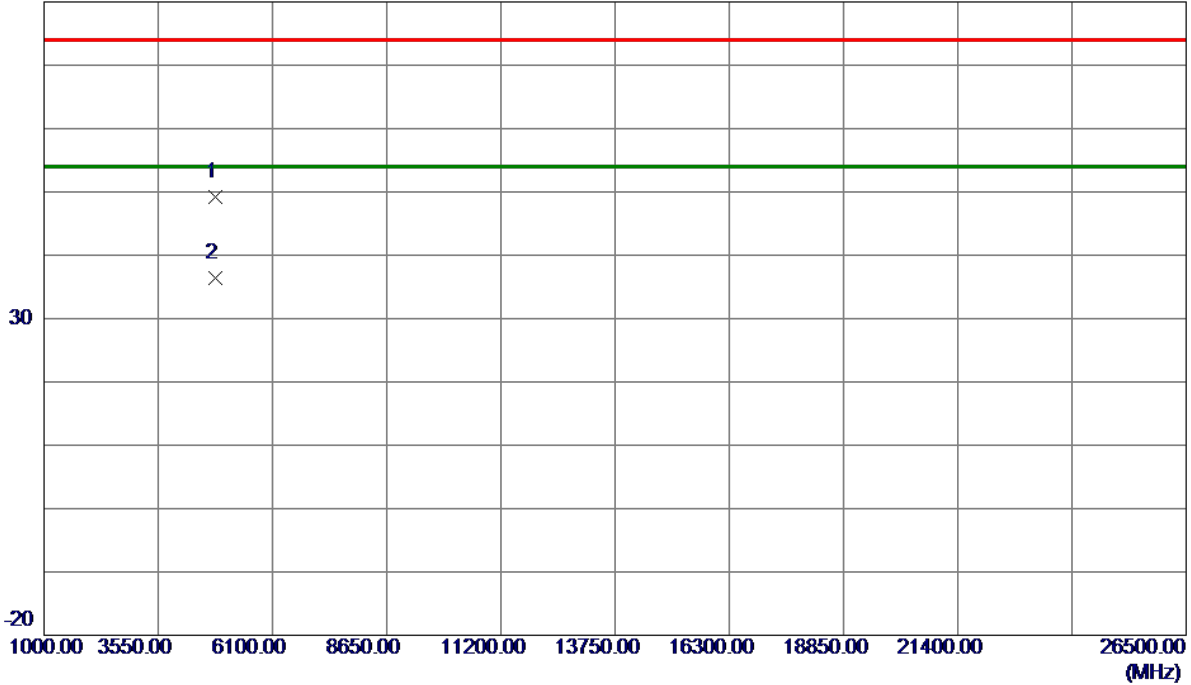

No.	Freq. MHz	Reading Level dBuV/m	Correct Factor dB	Measure ment dBuV/m	Limit dBuV/m	Margin dB	Detector	Comment
1	4830.4450	44.88	4.28	49.16	74.00	-24.84	Peak	
2 *	4833.2400	32.08	4.29	36.37	54.00	-17.63	AVG	

REMARKS:

- (1) Measurement Value = Reading Level + Correct Factor.
- (2) Margin Level = Measurement Value - Limit Value.

Test Mode: TX N-20M Mode 2437 MHz

### Vertical

130 dBuV/m

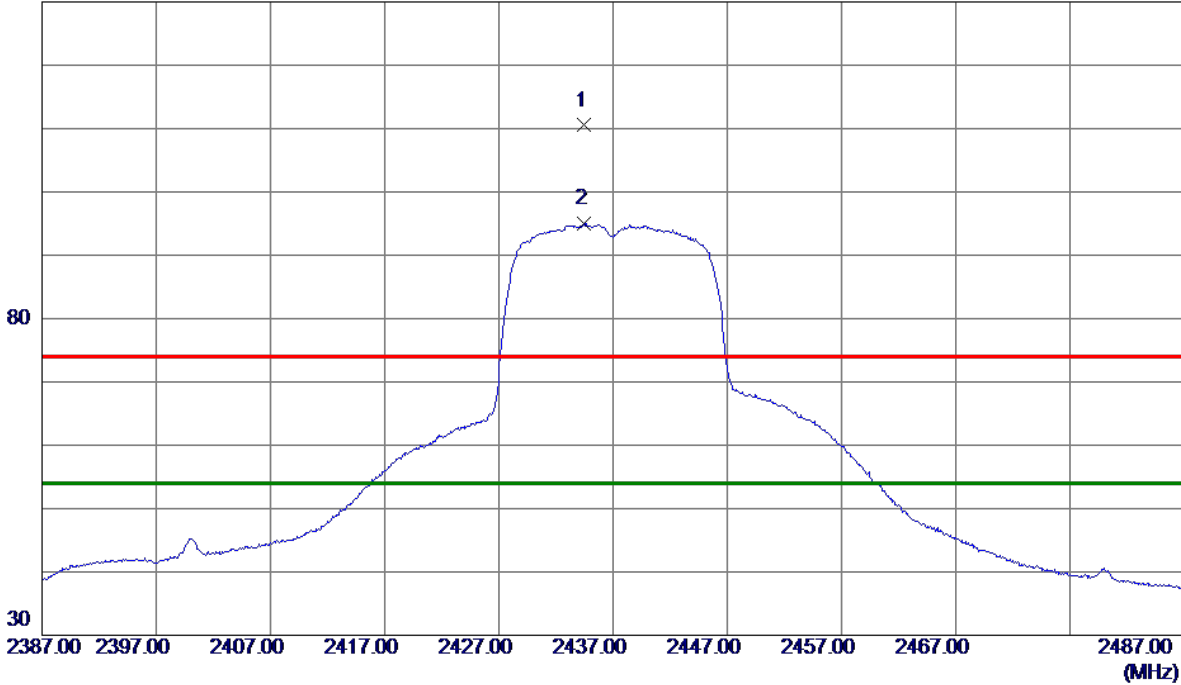

No.	Freq. MHz	Reading Level dBuV/m	Correct Factor dB	Measure ment dBuV/m	Limit dBuV/m	Margin dB	Detector	Comment
1	2434.5000	102.79	7.71	110.50	74.00	36.50	Peak	No Limit
2 *	2434.5000	87.20	7.71	94.91	54.00	40.91	AVG	No Limit

**REMARKS:**

- (1) Measurement Value = Reading Level + Correct Factor.
- (2) Margin Level = Measurement Value - Limit Value.

Test Mode: TX N-20M Mode 2437 MHz

### Vertical

80 dBuV/m

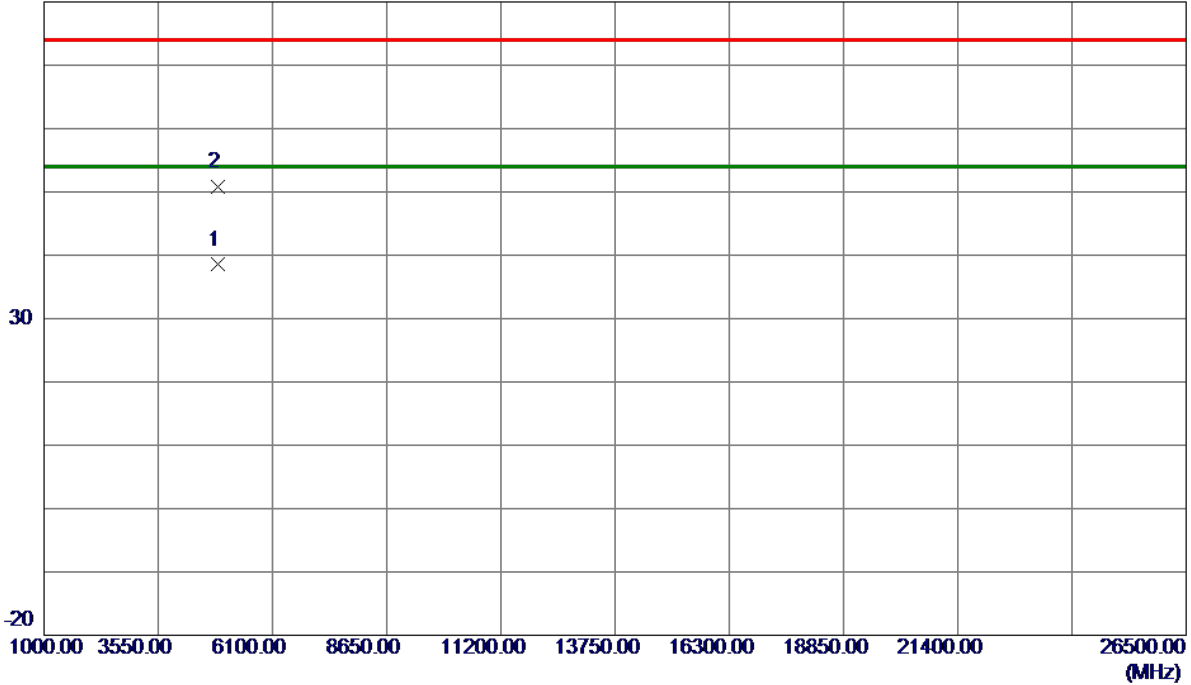

No.	Freq. MHz	Reading Level dBuV/m	Correct Factor dB	Measure ment dBuV/m	Limit dBuV/m	Margin dB	Detector	Comment
1 *	4872.5950	34.06	4.44	38.50	54.00	-15.50	AVG	
2	4878.4000	46.38	4.46	50.84	74.00	-23.16	Peak	

**REMARKS:**

- (1) Measurement Value = Reading Level + Correct Factor.
- (2) Margin Level = Measurement Value - Limit Value.

Test Mode: TX N-20M Mode 2437 MHz

### Horizontal

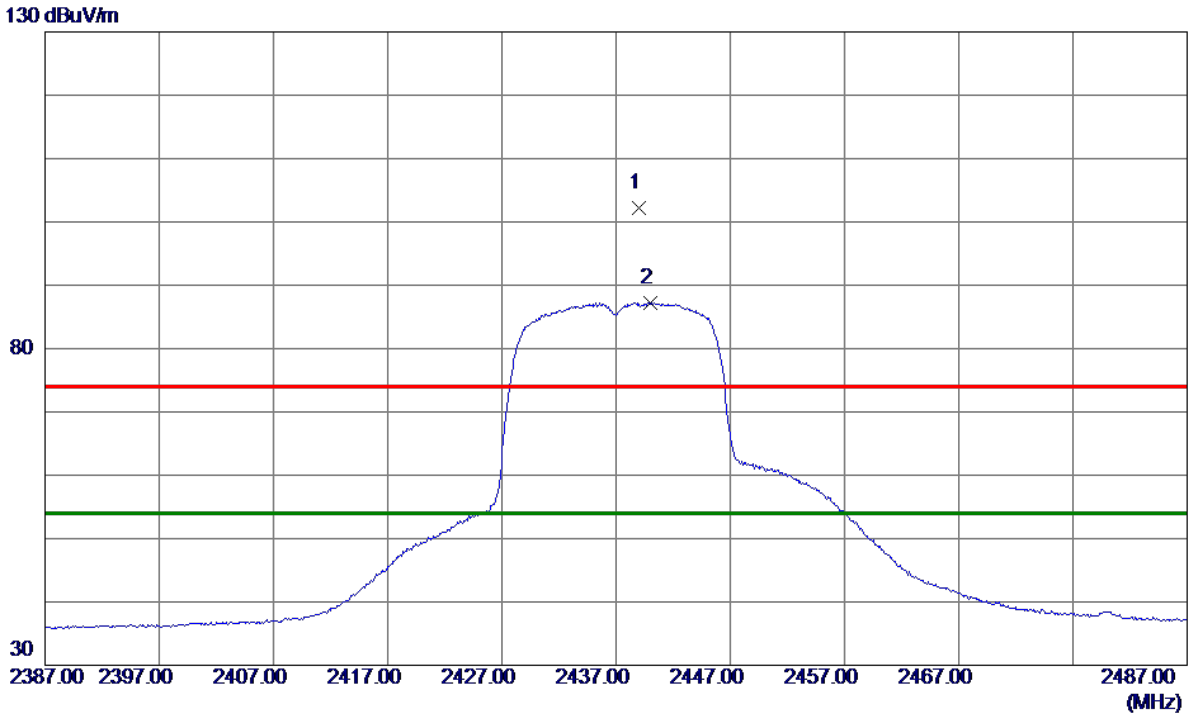

No.	Freq. MHz	Reading Level dBuV/m	Correct Factor dB	Measure ment dBuV/m	Limit dBuV/m	Margin dB	Detector	Comment
1	2438.9500	94.49	7.73	102.22	74.00	28.22	Peak	No Limit
2 *	2440.0000	79.54	7.73	87.27	54.00	33.27	AVG	No Limit

**REMARKS:**

- (1) Measurement Value = Reading Level + Correct Factor.
- (2) Margin Level = Measurement Value - Limit Value.



Test Mode: TX N-20M Mode 2437 MHz

### Horizontal

80 dBuV/m

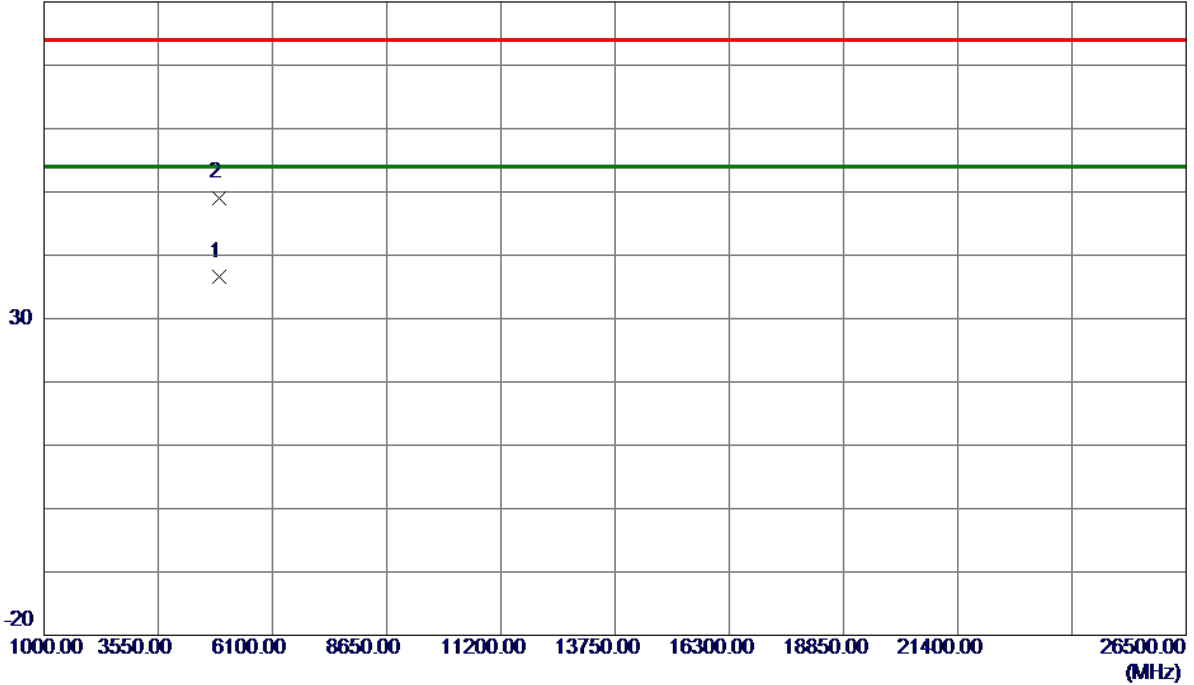

No.	Freq. MHz	Reading Level dBuV/m	Correct Factor dB	Measure ment dBuV/m	Limit dBuV/m	Margin dB	Detector	Comment
1 *	4915.4049	32.04	4.60	36.64	54.00	-17.36	AVG	
2	4916.4500	44.50	4.60	49.10	74.00	-24.90	Peak	

REMARKS:

- (1) Measurement Value = Reading Level + Correct Factor.
- (2) Margin Level = Measurement Value - Limit Value.

Test Mode: TX N-20M Mode 2462 MHz

**Vertical**

130 dBuV/m

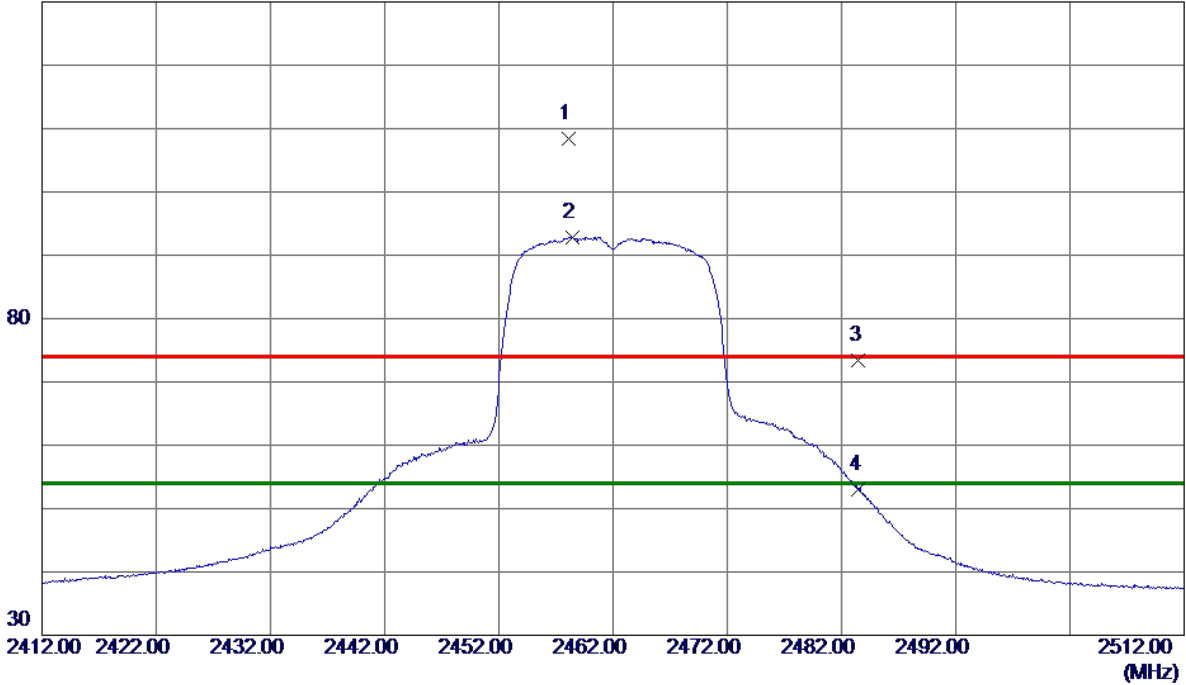

No.	Freq. MHz	Reading Level dBuV/m	Correct Factor dB	Measure ment dBuV/m	Limit dBuV/m	Margin dB	Detector	Comment
1	2458.1000	100.64	7.79	108.43	74.00	34.43	Peak	No Limit
2 *	2458.4500	85.08	7.79	92.87	54.00	38.87	AVG	No Limit
3	2483.5000	65.59	7.88	73.47	74.00	-0.53	Peak	
4	2483.5000	45.19	7.88	53.07	54.00	-0.93	AVG	

**REMARKS:**

- (1) Measurement Value = Reading Level + Correct Factor.
- (2) Margin Level = Measurement Value - Limit Value.

Test Mode: TX N-20M Mode 2462 MHz

### Vertical

80 dBuV/m

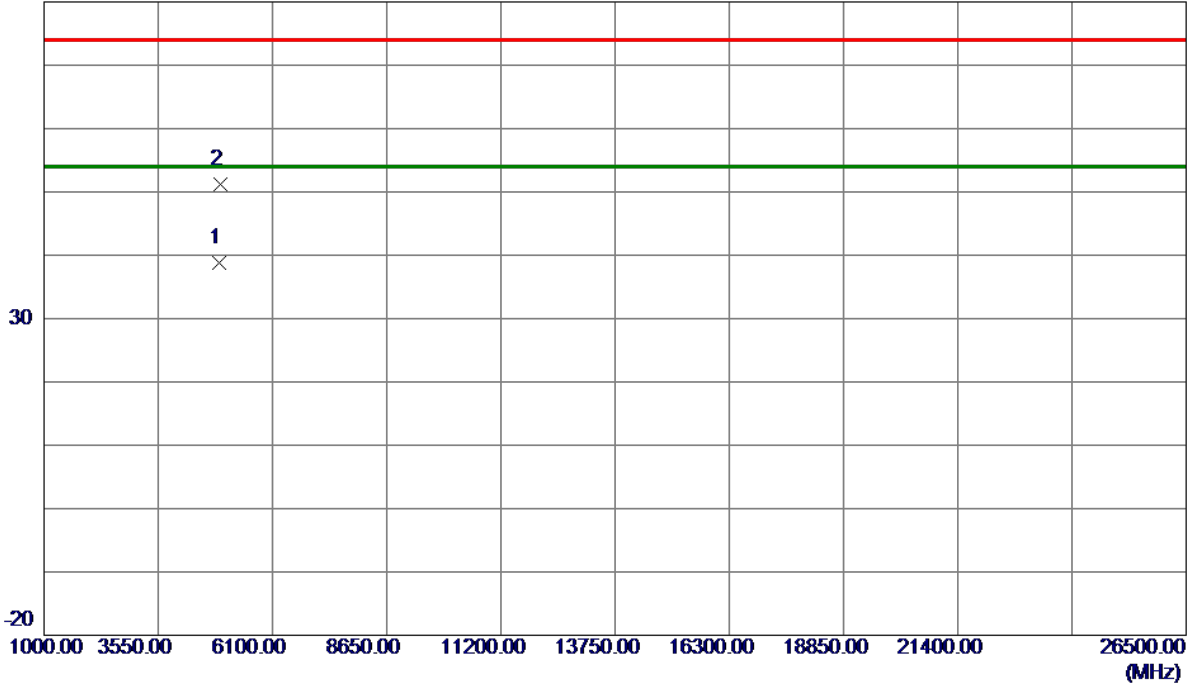

No.	Freq. MHz	Reading Level dBuV/m	Correct Factor dB	Measure ment dBuV/m	Limit dBuV/m	Margin dB	Detector	Comment
1 *	4922.4800	34.24	4.62	38.86	54.00	-15.14	AVG	
2	4924.4450	46.66	4.63	51.29	74.00	-22.71	Peak	

**REMARKS:**

- (1) Measurement Value = Reading Level + Correct Factor.
- (2) Margin Level = Measurement Value - Limit Value.

Test Mode: TX N-20M Mode 2462 MHz

### Horizontal

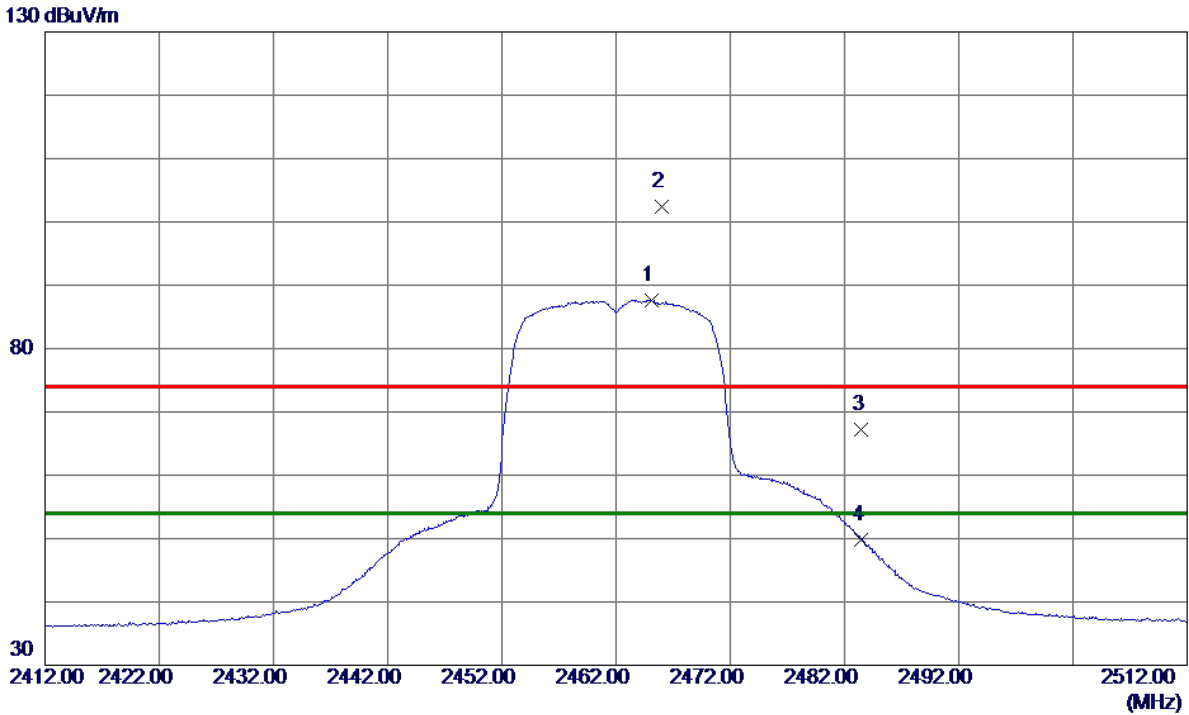

No.	Freq. MHz	Reading Level dBuV/m	Correct Factor dB	Measure ment dBuV/m	Limit dBuV/m	Margin dB	Detector	Comment
1 *	2465.1500	79.87	7.81	87.68	54.00	33.68	AVG	No Limit
2	2466.0000	94.49	7.82	102.31	74.00	28.31	Peak	No Limit
3	2483.5000	59.28	7.88	67.16	74.00	-6.84	Peak	
4	2483.5000	41.98	7.88	49.86	54.00	-4.14	AVG	

**REMARKS:**

- (1) Measurement Value = Reading Level + Correct Factor.
- (2) Margin Level = Measurement Value - Limit Value.

Test Mode: TX N-20M Mode 2462 MHz

### Horizontal

80 dBuV/m

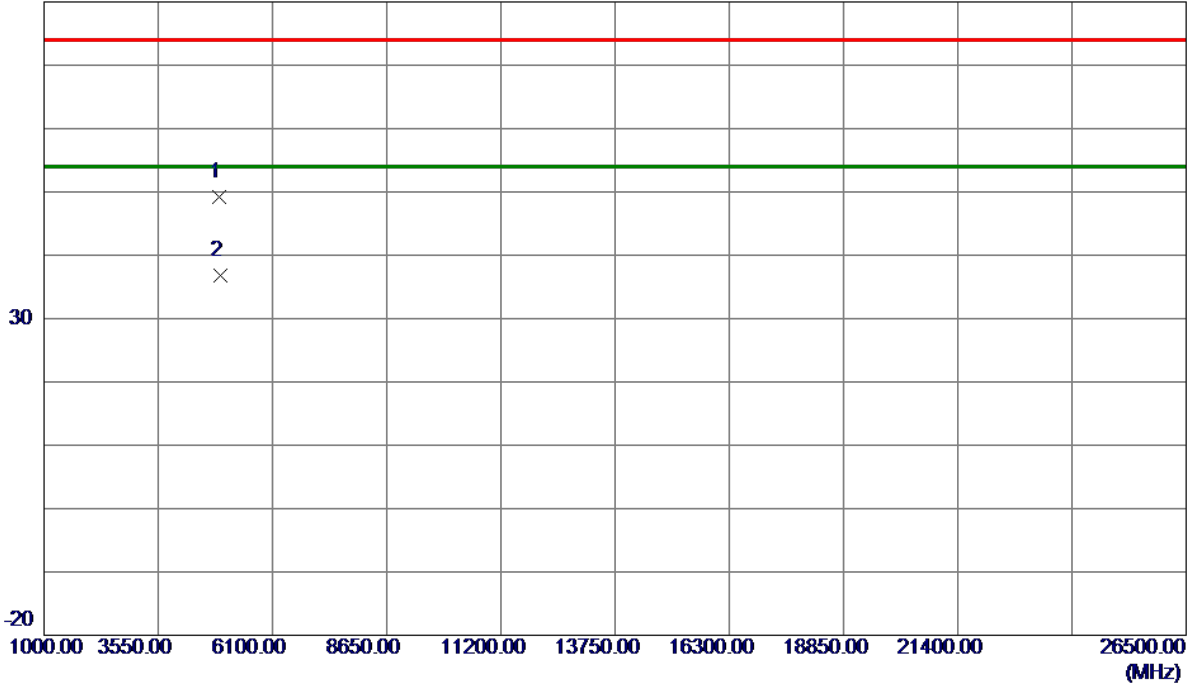

No.	Freq. MHz	Reading Level dBuV/m	Correct Factor dB	Measure ment dBuV/m	Limit dBuV/m	Margin dB	Detector	Comment
1	4923.6950	44.66	4.63	49.29	74.00	-24.71	Peak	
2 *	4924.3280	32.23	4.63	36.86	54.00	-17.14	AVG	

REMARKS:

- (1) Measurement Value = Reading Level + Correct Factor.
- (2) Margin Level = Measurement Value - Limit Value.

## APPENDIX E - BANDWIDTH

Test Mode	TX B Mode
-----------	-----------

Channel	Frequency (MHz)	6 dB Bandwidth (MHz)	6 dB Bandwidth Min. Limit (kHz)	Result
01	2412	9.11	500	Complies
06	2437	9.03	500	Complies
11	2462	8.64	500	Complies

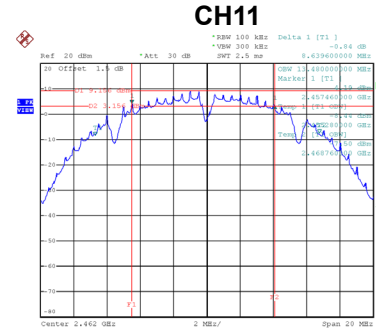
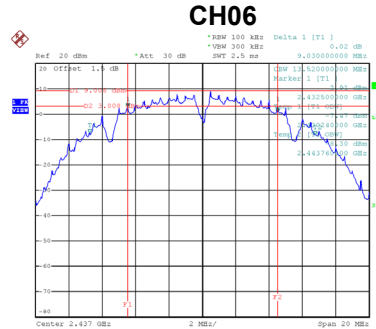
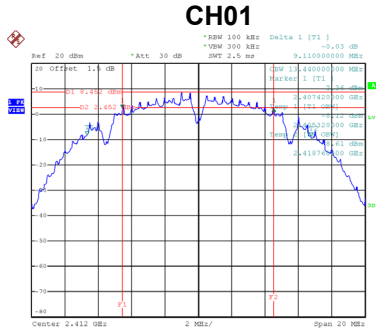

Channel	Frequency (MHz)	99 % Emission Bandwidth (MHz)	Result
01	2412	13.30	Complies
06	2437	13.50	Complies
11	2462	13.50	Complies

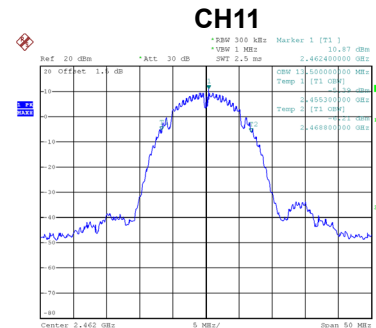
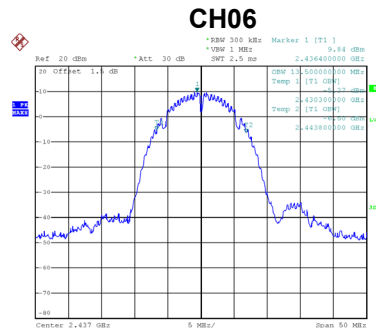
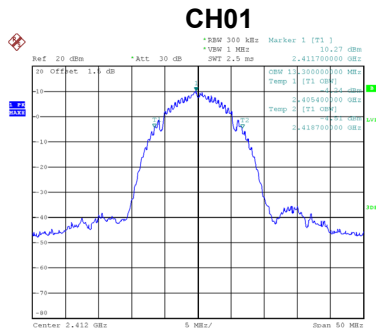

Test Mode	TX G Mode
-----------	-----------

Channel	Frequency (MHz)	6 dB Bandwidth (MHz)	6 dB Bandwidth Min. Limit (kHz)	Result
01	2412	15.18	500	Complies
06	2437	15.21	500	Complies
11	2462	15.42	500	Complies

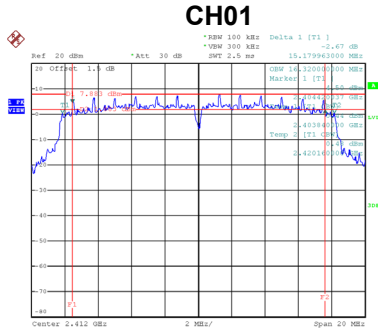

Date: 9.NOV.2019 16:04:50

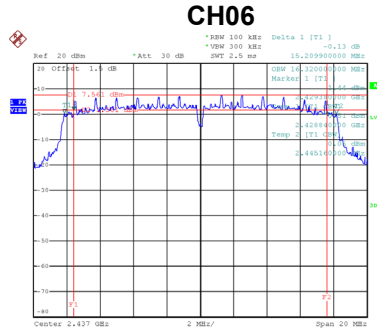

Date: 9.NOV.2019 16:06:39

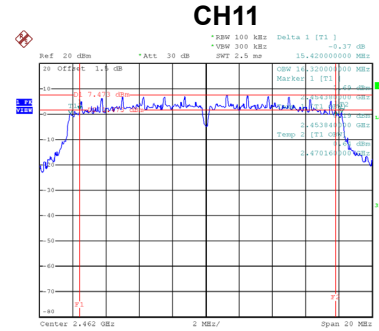

Date: 9.NOV.2019 16:08:17

Channel	Frequency (MHz)	99 % Emission Bandwidth (MHz)	Result
01	2412	16.80	Complies
06	2437	17.00	Complies
11	2462	16.80	Complies

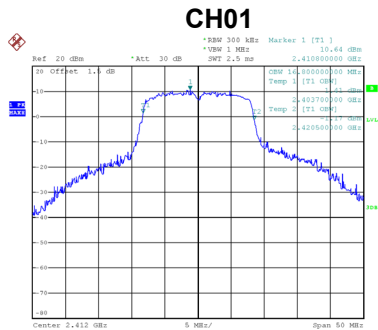

Date: 9.NOV.2019 16:09:43

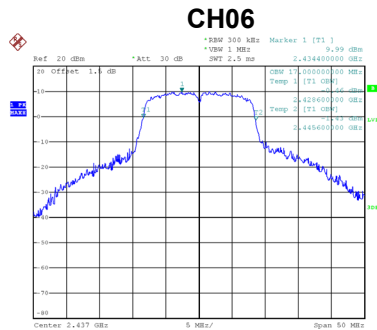

Date: 9.NOV.2019 16:09:59

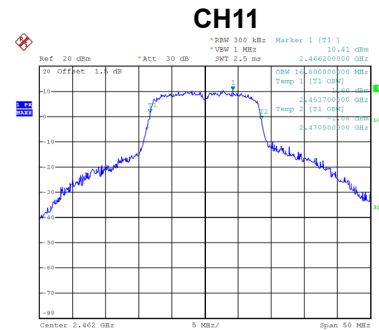

Date: 9.NOV.2019 16:10:21



Test Mode TX N-20M Mode

Channel	Frequency (MHz)	6 dB Bandwidth (MHz)	6 dB Bandwidth Min. Limit (kHz)	Result
01	2412	15.19	500	Complies
06	2437	15.17	500	Complies
11	2462	15.56	500	Complies

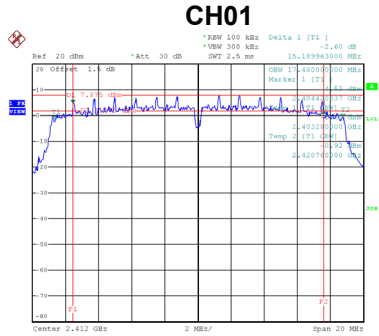

Date: 9.NOV.2019 16:11:31

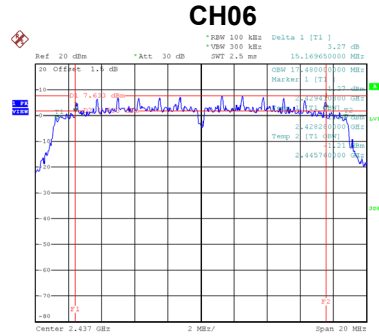

Date: 9.NOV.2019 16:13:00

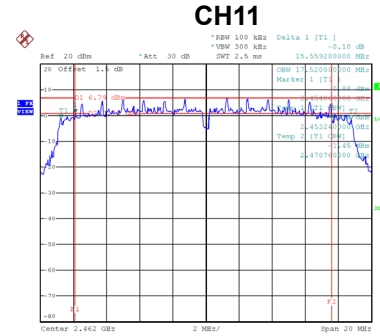

Date: 9.NOV.2019 16:15:54

Channel	Frequency (MHz)	99 % Emission Bandwidth (MHz)	Result
01	2412	17.80	Complies
06	2437	17.90	Complies
11	2462	17.90	Complies

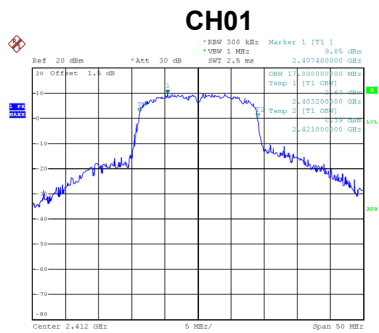

Date: 9.NOV.2019 16:11:01

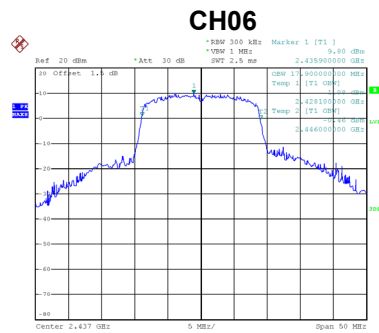

Date: 9.NOV.2019 16:13:52

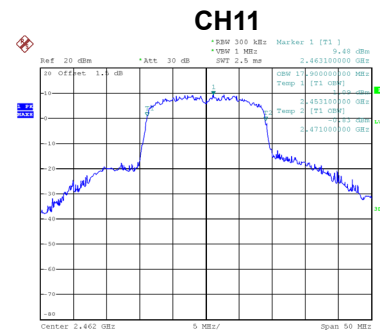

Date: 9.NOV.2019 16:14:53

## **APPENDIX F - MAXIMUM OUTPUT POWER**

Test Mode	TX B Mode
-----------	-----------

Channel	Frequency (MHz)	Output Power (dBm)	Duty Factor	Output Power + Duty Factor (dBm)	Max. Limit (dBm)	Max. Limit (W)	Result
01	2412	16.99	0.20	17.19	30.00	1.0000	Complies
06	2437	17.89	0.20	18.09	30.00	1.0000	Complies
11	2462	17.29	0.20	17.49	30.00	1.0000	Complies

Test Mode	TX G Mode
-----------	-----------

Channel	Frequency (MHz)	Output Power (dBm)	Duty Factor	Output Power + Duty Factor (dBm)	Max. Limit (dBm)	Max. Limit (W)	Result
01	2412	16.69	0.27	16.96	30.00	1.0000	Complies
06	2437	16.60	0.27	16.87	30.00	1.0000	Complies
11	2462	16.54	0.27	16.81	30.00	1.0000	Complies

Test Mode	TX N-20M Mode
-----------	---------------

Channel	Frequency (MHz)	Output Power (dBm)	Duty Factor	Output Power + Duty Factor (dBm)	Max. Limit (dBm)	Max. Limit (W)	Result
01	2412	15.78	0.29	16.07	30.00	1.0000	Complies
06	2437	15.95	0.29	16.24	30.00	1.0000	Complies
11	2462	15.89	0.29	16.18	30.00	1.0000	Complies

## **APPENDIX G - CONDUCTED SPURIOUS EMISSIONS**

Test Mode TX B Mode

### Bandedge-CH01

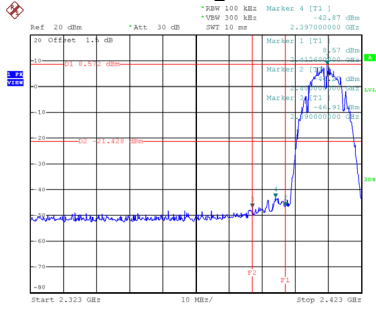

Date: 9.NOV.2019 15:55:08

### Bandedge-CH11

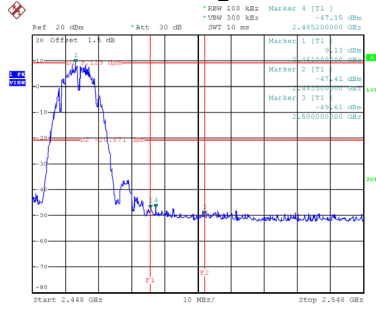

Date: 9.NOV.2019 16:01:53

### CH01 – 10th Harmonic of the fundamental frequency

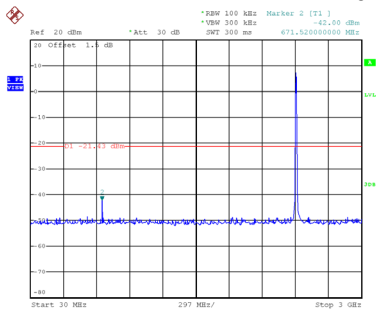

Date: 9.NOV.2019 15:55:21

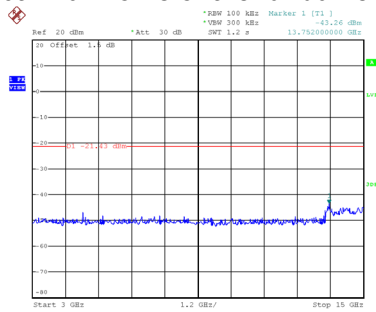

Date: 9.NOV.2019 15:55:28

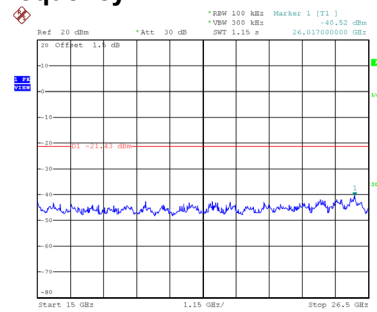

Date: 9.NOV.2019 15:55:35

### CH06 – 10th Harmonic of the fundamental frequency

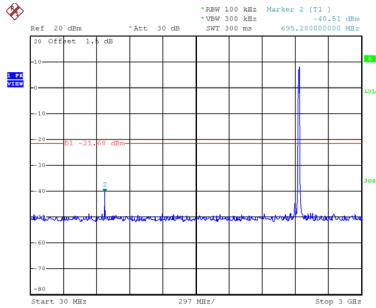

Date: 9.NOV.2019 15:57:48

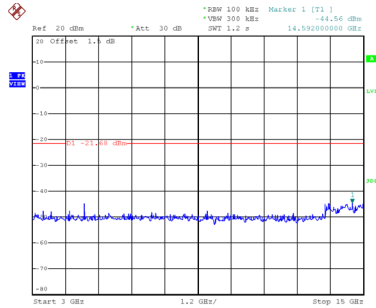

Date: 9.NOV.2019 15:57:55

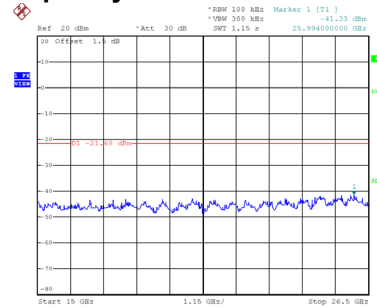

Date: 9.NOV.2019 15:58:02

### CH11 – 10th Harmonic of the fundamental frequency

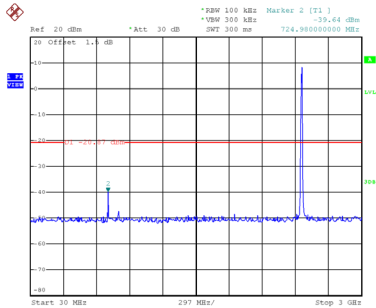

Date: 9.NOV.2019 16:02:07

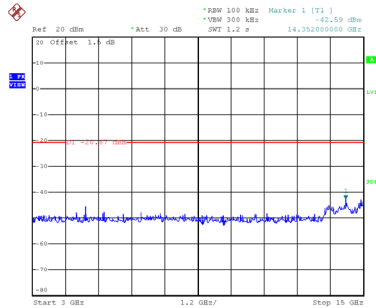

Date: 9.NOV.2019 16:02:15

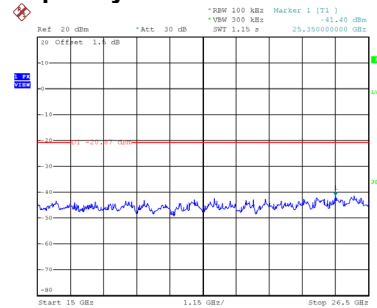

Date: 9.NOV.2019 16:02:23

Test Mode TX G Mode

### Bandedge-CH01

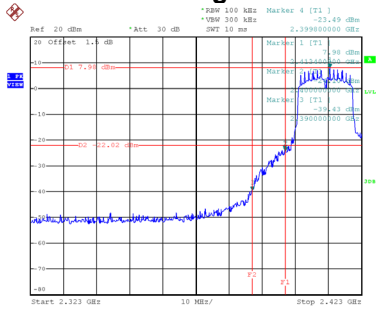

Date: 9.NOV.2019 16:04:58

### Bandedge-CH11

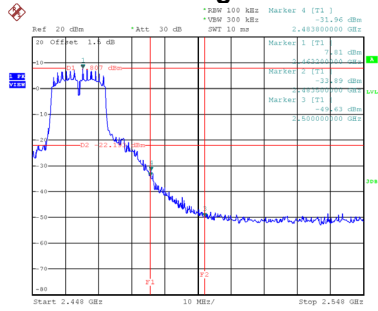

Date: 9.NOV.2019 16:08:26

### CH01 – 10th Harmonic of the fundamental frequency

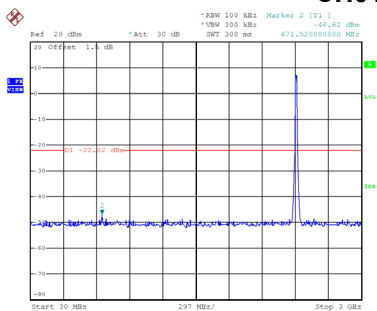

Date: 9.NOV.2019 16:05:12

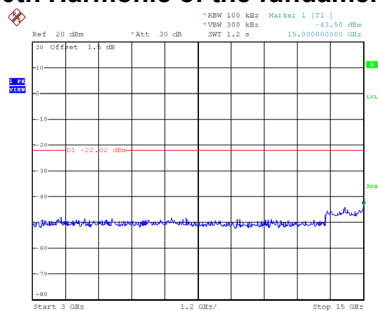

Date: 9.NOV.2019 16:05:20

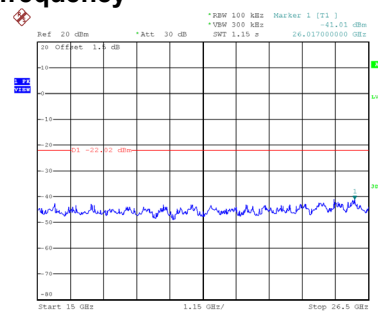

Date: 9.NOV.2019 16:05:28

### CH06 – 10th Harmonic of the fundamental frequency

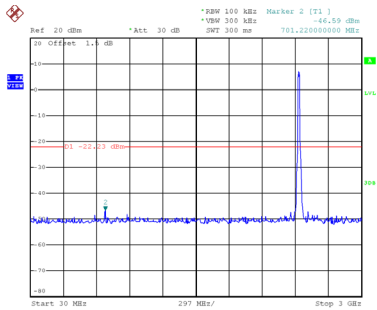

Date: 9.NOV.2019 16:07:01

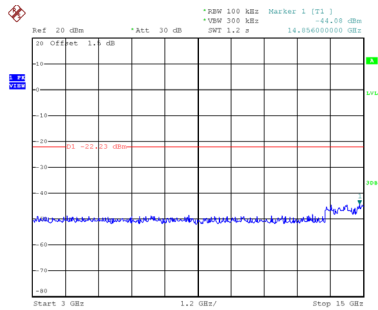

Date: 9.NOV.2019 16:07:09

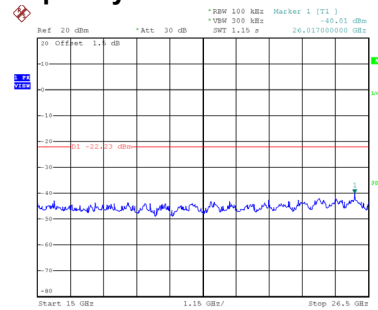

Date: 9.NOV.2019 16:07:17

### CH11 – 10th Harmonic of the fundamental frequency

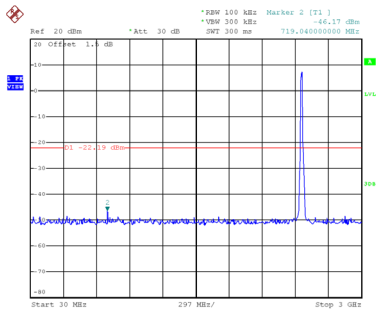

Date: 9.NOV.2019 16:08:40

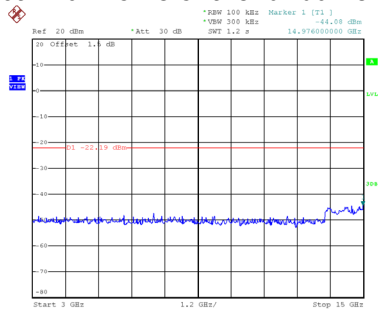

Date: 9.NOV.2019 16:08:48

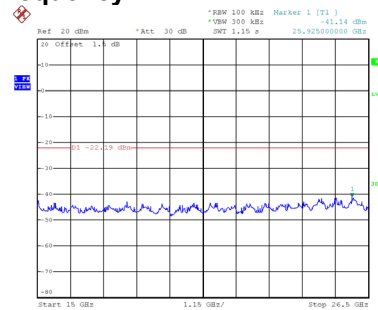

Date: 9.NOV.2019 16:08:56

Test Mode TX N-20M Mode

### Bandedge-CH01

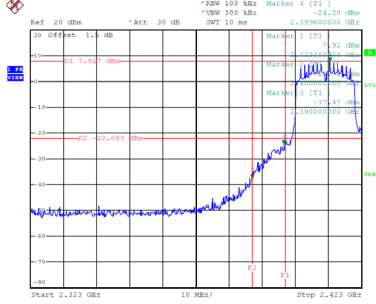

Date: 9.NOV.2019 16:11:39

### Bandedge-CH11

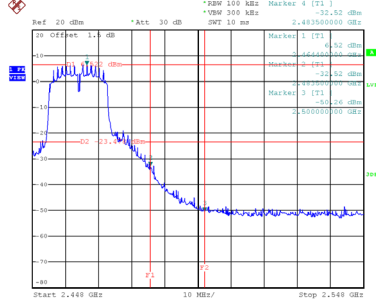

Date: 9.NOV.2019 16:16:02

### CH01 – 10th Harmonic of the fundamental frequency

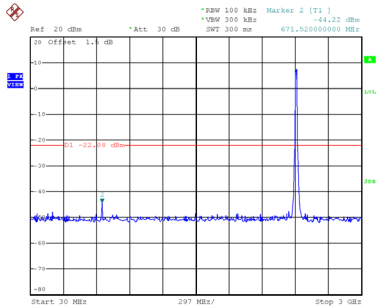

Date: 9.NOV.2019 16:11:53

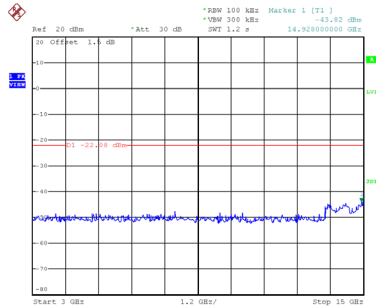

Date: 9.NOV.2019 16:12:01

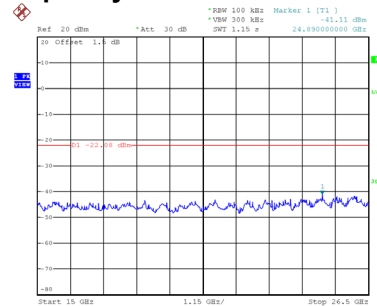

Date: 9.NOV.2019 16:12:09

### CH06 – 10th Harmonic of the fundamental frequency

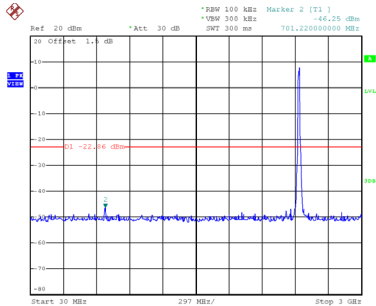

Date: 9.NOV.2019 16:13:22

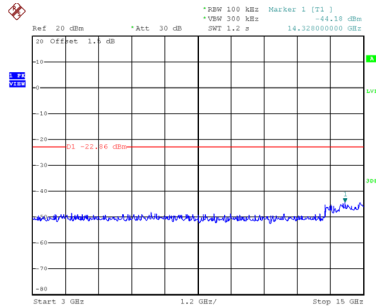

Date: 9.NOV.2019 16:13:30

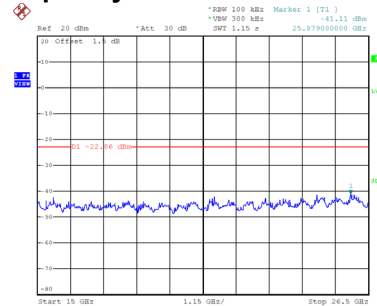

Date: 9.NOV.2019 16:13:38

### CH11 – 10th Harmonic of the fundamental frequency

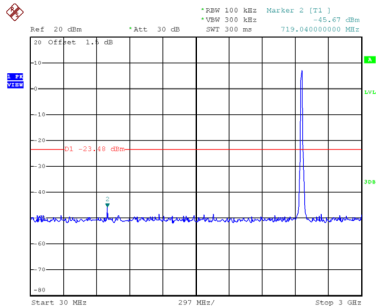

Date: 9.NOV.2019 16:16:16

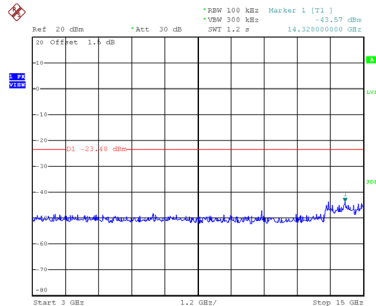

Date: 9.NOV.2019 16:16:24

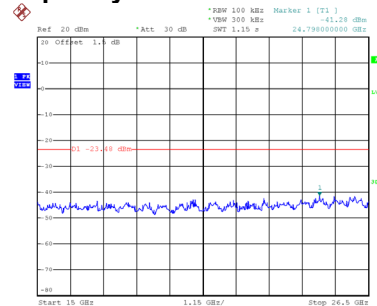

Date: 9.NOV.2019 16:16:32

## **APPENDIX H - POWER SPECTRAL DENSITY**



Test Mode	TX B Mode
-----------	-----------

Channel	Frequency (MHz)	Power Spectral Density (dBm/3kHz)	Max. Limit (dBm/3kHz)	Result
01	2412	-5.26	8	Complies
06	2437	-6.18	8	Complies
11	2462	-6.68	8	Complies

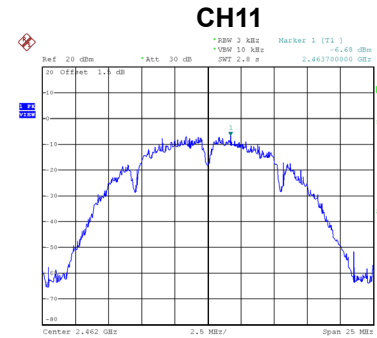
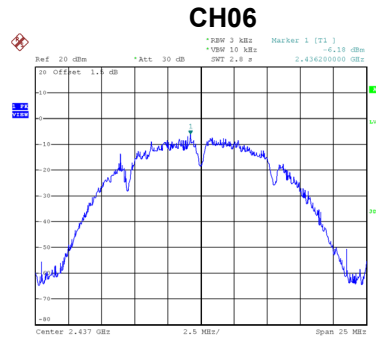
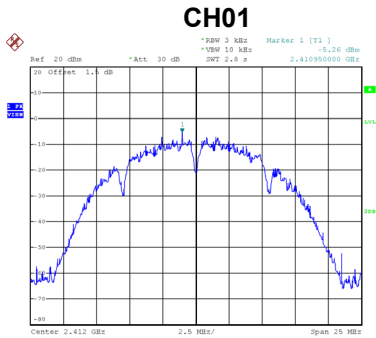

Test Mode	TX G Mode
-----------	-----------

Channel	Frequency (MHz)	Power Spectral Density (dBm/3kHz)	Max. Limit (dBm/3kHz)	Result
01	2412	-6.55	8	Complies
06	2437	-7.64	8	Complies
11	2462	-8.53	8	Complies

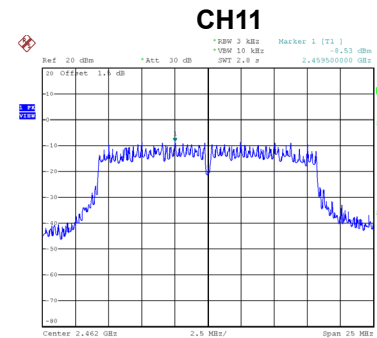
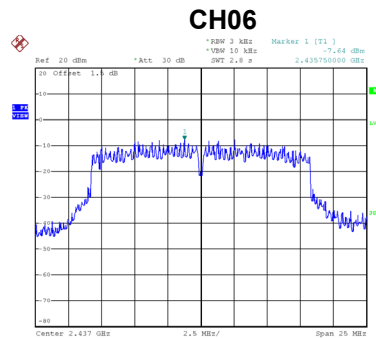
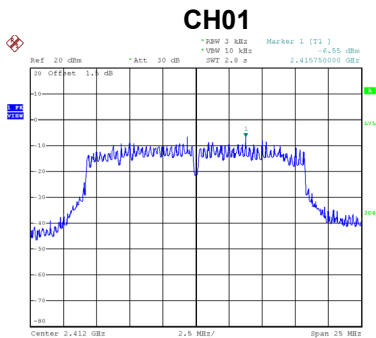

Test Mode	TX N-20M Mode
-----------	---------------

Channel	Frequency (MHz)	Power Spectral Density (dBm/3kHz)	Max. Limit (dBm/3kHz)	Result
01	2412	-6.84	8	Complies
06	2437	-7.16	8	Complies
11	2462	-8.69	8	Complies

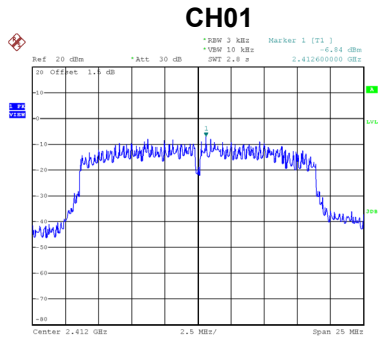

Date: 9.NOV.2019 16:11:14

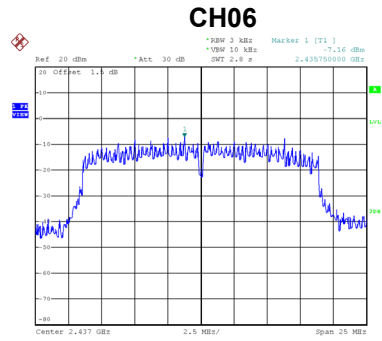

Date: 9.NOV.2019 16:12:42

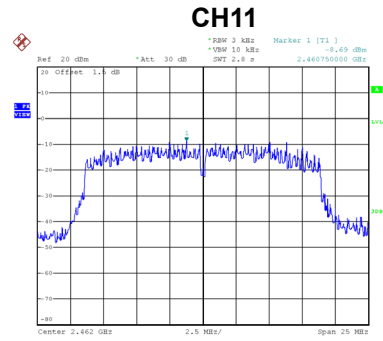

Date: 9.NOV.2019 16:15:37

**End of Test Report**