

---

# FCC Test Report

---

Report No.: AGC00677191101FE08

**FCC ID** : 2AU3DGRAVITY6P  
**APPLICATION PURPOSE** : Original Equipment  
**PRODUCT DESIGNATION** : Smartphone  
**BRAND NAME** : MAXWEST, MTT, Vantec  
**MODEL NAME** : Gravity 6P, Gravity\_6P\_Plus, L604, L604a, L604b, L604c,  
L607, L607a, L607b, L607c, L661, G6, G8  
**APPLICANT** : United Creation Technology Corp., Ltd  
**DATE OF ISSUE** : Dec. 24, 2019  
**STANDARD(S)** : FCC Part 15.247  
**REPORT VERSION** : V1.0

**Attestation of Global Compliance (Shenzhen) Co., Ltd**

**CAUTION:**

This report shall not be reproduced except in full without the written permission of the test laboratory and shall not be quoted out of context.



**REPORT REVISE RECORD**

<b>Report Version</b>	<b>Revise Time</b>	<b>Issued Date</b>	<b>Valid Version</b>	<b>Notes</b>
V1.0	/	Dec. 24, 2019	Valid	Initial Release

## TABLE OF CONTENTS

<b>1. VERIFICATION OF COMPLIANCE .....</b>	<b>5</b>
<b>2. GENERAL INFORMATION .....</b>	<b>6</b>
2.1 PRODUCT DESCRIPTION.....	6
2.2. TABLE OF CARRIER FREQUENCIES .....	6
2.3 RELATED SUBMITTAL(S)/GRANT(S) .....	7
2.4 TEST METHODOLOGY .....	7
2.5 SPECIAL ACCESSORIES.....	7
2.6 EQUIPMENT MODIFICATIONS.....	7
<b>3. MEASUREMENT UNCERTAINTY .....</b>	<b>8</b>
<b>4. DESCRIPTION OF TEST MODES.....</b>	<b>9</b>
<b>5. SYSTEM TEST CONFIGURATION .....</b>	<b>10</b>
5.1 CONFIGURATION OF TESTED SYSTEM.....	10
5.2 EQUIPMENT USED IN TESTED SYSTEM .....	10
5.3. SUMMARY OF TEST RESULTS.....	10
<b>6. TEST FACILITY .....</b>	<b>11</b>
<b>7. PEAK OUTPUT POWER .....</b>	<b>12</b>
7.1. MEASUREMENT PROCEDURE .....	12
7.2. TEST SET-UP (BLOCK DIAGRAM OF CONFIGURATION) .....	12
7.3. LIMITS AND MEASUREMENT RESULT .....	13
<b>8. 6 DB BANDWIDTH.....</b>	<b>15</b>
8.1. MEASUREMENT PROCEDURE .....	15
8.2. TEST SET-UP (BLOCK DIAGRAM OF CONFIGURATION) .....	15
8.3. LIMITS AND MEASUREMENT RESULTS .....	15
<b>9. CONDUCTED SPURIOUS EMISSION .....</b>	<b>17</b>
9.1. MEASUREMENT PROCEDURE .....	17
9.2. TEST SET-UP (BLOCK DIAGRAM OF CONFIGURATION) .....	17
9.3. MEASUREMENT EQUIPMENT USED.....	17
9.4. LIMITS AND MEASUREMENT RESULT .....	17
<b>10. MAXIMUM CONDUCTED OUTPUT POWER SPECTRAL DENSITY .....</b>	<b>22</b>
10.1 MEASUREMENT PROCEDURE .....	22
10.2 TEST SET-UP (BLOCK DIAGRAM OF CONFIGURATION) .....	22
10.3 MEASUREMENT EQUIPMENT USED.....	22
10.4 LIMITS AND MEASUREMENT RESULT .....	22
<b>11. RADIATED EMISSION.....</b>	<b>24</b>

- 11.1. MEASUREMENT PROCEDURE ..... 24
- 11.2. TEST SETUP..... 25
- 11.3. LIMITS AND MEASUREMENT RESULT ..... 26
- 11.4. TEST RESULT ..... 26
- 12. FCC LINE CONDUCTED EMISSION TEST ..... 36**
- 12.1. LIMITS OF LINE CONDUCTED EMISSION TEST ..... 36
- 12.2. BLOCK DIAGRAM OF LINE CONDUCTED EMISSION TEST..... 36
- 12.3. PRELIMINARY PROCEDURE OF LINE CONDUCTED EMISSION TEST ..... 37
- 12.4. FINAL PROCEDURE OF LINE CONDUCTED EMISSION TEST ..... 37
- 12.5. TEST RESULT OF LINE CONDUCTED EMISSION TEST ..... 38
- APPENDIX A: PHOTOGRAPHS OF TEST SETUP ..... 40**

**1. VERIFICATION OF COMPLIANCE**

<b>Applicant</b>	United Creation Technology Corp., Ltd
<b>Address</b>	Room 201, Block A, Science and Technology Buliding Phase-2, Nanhai Road 1057, Shekou, Nanshan District, Shenzhen
<b>Manufacturer</b>	United Creation Technology Corp., Ltd
<b>Address</b>	Room 201, Block A, Science and Technology Buliding Phase-2, Nanhai Road 1057, Shekou, Nanshan District, Shenzhen
<b>Factory</b>	United Creation Technology Corp., Ltd
<b>Address</b>	Room 201, Block A, Science and Technology Buliding Phase-2, Nanhai Road 1057, Shekou, Nanshan District, Shenzhen
<b>Product Designation</b>	Smartphone
<b>Brand Name</b>	CUBOT
<b>Test Model</b>	Gravity 6P
<b>Series Model</b>	Gravity_6P_Plus, L604, L604a, L604b, L604c, L607, L607a, L607b, L607c, L661, G6, G8
<b>Model Description</b>	All the same except for brand name and model name, the corresponding relationship are as follow: <b>MAXWEST</b> is corresponding <b>Gravity 6P, Gravity_6P_Plus;</b> <b>MTT</b> is corresponding <b>L604, L604a, L604b, L604c, L607, L607a, L607b, L607c, L661;</b> <b>Vantec</b> is corresponding <b>G6, G8;</b>
<b>Date of test</b>	Nov. 07, 2019 to Dec. 24, 2019
<b>Deviation</b>	None
<b>Condition of Test Sample</b>	Normal
<b>Test Result</b>	Pass
<b>Report Template</b>	AGCRT-US-BLE/RF

We hereby certify that:

The above equipment was tested by Attestation of Global Compliance (Shenzhen) Co., Ltd. The test data, data evaluation, test procedures, and equipment configurations shown in this report were made in accordance with the procedures given in ANSI C63.10 (2013) and the energy emitted by the sample EUT tested as described in this report is in compliance with radiated emission limits of FCC part 15.247.

Prepared By

*Jeast zhan*

Jeast Zhan  
(Project Engineer)

Dec. 24, 2019

Reviewed By

*Max Zhang*

Max Zhang  
(Reviewer)

Dec. 24, 2019

Approved By

*Forrest Lei*

Forrest Lei  
(Authorized Officer)

Dec. 24, 2019

## 2.GENERAL INFORMATION

### 2.1PRODUCT DESCRIPTION

The EUT is designed as a “Smartphone ”. It is designed by way of utilizing the GFSK technology to achieve the system operation.

A major technical description of EUT is described as following

<b>Operation Frequency</b>	2.402 GHz to 2.480GHz
<b>RF Output Power</b>	3.916dBm(Max)
<b>Bluetooth Version</b>	V4.0
<b>Modulation</b>	BR <input type="checkbox"/> GFSK, EDR <input type="checkbox"/> $\pi$ /4-DQPSK, <input type="checkbox"/> 8DPSK BLE <input checked="" type="checkbox"/> GFSK 1Mbps <input type="checkbox"/> GFSK 2Mbps
<b>Number of channels</b>	40 Channel
<b>Antenna Designation</b>	PIFA Antenna(Comply with requirements of the FCC part 15.203)
<b>Antenna Gain</b>	0dBi
<b>Hardware Version</b>	E64B_V2.0G
<b>Software Version</b>	Maxwest_Gravity_6P_GEN
<b>Power Supply</b>	DC 3.8V by Built-in Li-ion Battery

### 2.2. TABLE OF CARRIER FREQUENCYS

Frequency Band	Channel Number	Frequency
2400~2483.5MHZ	0	2402MHZ
	1	2404MHZ
	:	:
	38	2478 MHZ
	39	2480 MHZ

### **2.3 RELATED SUBMITTAL(S)/GRANT(S)**

This submittal(s) (test report) is intended for **FCC ID: 2AU3DGRAVITY6P** filing to comply with the FCC Part 15.247 requirements.

### **2.4 TEST METHODOLOGY**

Both conducted and radiated testing was performed according to the procedures in ANSI C63.10 (2013). Radiated testing was performed at an antenna to EUT distance 3 meters.

### **2.5 SPECIAL ACCESSORIES**

Refer to section 2.2.

### **2.6 EQUIPMENT MODIFICATIONS**

Not available for this EUT intended for grant.

### 3. MEASUREMENT UNCERTAINTY

The reported uncertainty of measurement  $y \pm U$ , where expanded uncertainty  $U$  is based on a standard uncertainty multiplied by a coverage factor of  $k=2$ , providing a level of confidence of approximately 95%.

- Uncertainty of Conducted Emission,  $U_c = \pm 3.2$  dB
- Uncertainty of Radiated Emission below 1GHz,  $U_c = \pm 3.9$  dB
- Uncertainty of Radiated Emission above 1GHz,  $U_c = \pm 4.8$  dB
- Uncertainty of total RF power, conducted,  $U_c = \pm 0.8$  dB
- Uncertainty of RF power density, conducted,  $U_c = \pm 2.6$  dB
- Uncertainty of spurious emissions, conducted,  $U_c = \pm 2.7$  dB
- Uncertainty of Occupied Channel Bandwidth:  $U_c = \pm 2$  %



#### 4. DESCRIPTION OF TEST MODES

NO.	TEST MODE DESCRIPTION
1	Low channel TX
2	Middle channel TX
3	High channel TX

Note:

1. Only the result of the worst case was recorded in the report, if no other cases.
2. For Radiated Emission, 3axis were chosen for testing for each applicable mode.
3. For Conducted Test method, a temporary antenna connector is provided by the manufacture.

## 5. SYSTEM TEST CONFIGURATION

### 5.1 CONFIGURATION OF TESTED SYSTEM

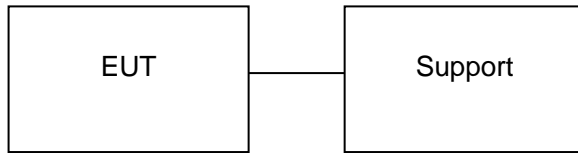

### 5.2 EQUIPMENT USED IN TESTED SYSTEM

Item	Equipment	Model No.	ID or Specification	Remark
1	Smartphone	Gravity 6P	FCC ID: 2AU3DGRAVITY6P	EUT
2	Adapter-1	LM601U-05120U01	DC 5.0V 1.2A	AE
3	Adapter-2	UT-236A-5150ZY	DC 5.0V 1.5A	AE
4	Battery	BP-60AT	DC 3.8V 3300mAh	AE
5	USB Cable	N/A	N/A	AE

### 5.3. SUMMARY OF TEST RESULTS

FCC RULES	DESCRIPTION OF TEST	RESULT
15.247 (b)(3)	Peak Output Power	Compliant
15.247 (a)(2)	6 dB Bandwidth	Compliant
15.247 (d)	Conducted Spurious Emission	Compliant
15.247 (e)	Maximum Conducted Output Power Density	Compliant
15.209	Radiated Emission	Compliant
15.207	Conducted Emission	Compliant

**6. TEST FACILITY**

<b>Test Site</b>	Attestation of Global Compliance (Shenzhen) Co., Ltd
<b>Location</b>	1-2/F, Building 19, Junfeng Industrial Park, Chongqing Road, Heping Community, Fuhai Street, Bao'an District, Shenzhen, Guangdong, China
<b>Designation Number</b>	CN1259
<b>FCC Test Firm Registration Number</b>	975832
<b>A2LA Cert. No.</b>	5054.02
<b>Description</b>	Attestation of Global Compliance(Shenzhen) Co., Ltd is accredited by A2LA

**TEST EQUIPMENT OF CONDUCTED EMISSION TEST**

<b>Equipment</b>	<b>Manufacturer</b>	<b>Model</b>	<b>S/N</b>	<b>Cal. Date</b>	<b>Cal. Due</b>
TEST RECEIVER	R&S	ESPI	101206	Jun. 12, 2019	Jun. 11, 2020
LISN	R&S	ESH2-Z5	100086	Aug. 26, 2019	Aug. 25, 2020

**TEST EQUIPMENT OF RADIATED EMISSION TEST**

<b>Equipment</b>	<b>Manufacturer</b>	<b>Model</b>	<b>S/N</b>	<b>Cal. Date</b>	<b>Cal. Due</b>
TEST RECEIVER	R&S	ESCI	10096	Jun. 12, 2019	Jun. 11, 2020
EXA Signal Analyzer	Aglient	N9010A	MY53470504	Dec. 12, 2019	Dec. 11, 2020
2.4GHz Fliter	Micro-tronics	087	N/A	Jun. 12, 2019	Jun. 11, 2020
Attenuator	Weinachel Corp	58-30-33	N/A	Jun. 12, 2019	Jun. 11, 2020
Horn antenna	SCHWARZBECK	BBHA 9170	#768	Sep. 21, 2017	Sep. 20, 2020
Active loop antenna (9K-30MHz)	ZHINAN	ZN30900C	18051	Jun. 14, 2018	Jun. 13, 2020
Double-Ridged Waveguide Horn	ETS LINDGREN	3117	00034609	May. 17, 2019	May. 16, 2021
Broadband Preamplifier	ETS LINDGREN	3117PA	00225134	Oct. 15, 2019	Oct. 14, 2020
ANTENNA	SCHWARZBECK	VULB9168	D69250	Sep. 20, 2019	Sep. 19, 2020

## 7. PEAK OUTPUT POWER

### 7.1. MEASUREMENT PROCEDURE

For peak power test:

1. Connect EUT RF output port to the Spectrum Analyzer through an RF attenuator
2.  $RBW \geq DTS$  bandwidth
3.  $VBW \geq 3 * RBW$ .
4.  $SPAN \geq VBW$ .
5. Sweep: Auto.
6. Detector function: Peak.
7. Trace: Max hold.

Allow trace to stabilize. Use the marker-to-peak function to set the marker to the peak of the emission. The indicated level is the peak output power, after any corrections for external attenuators and cables.

### 7.2. TEST SET-UP (BLOCK DIAGRAM OF CONFIGURATION) PEAK POWER TEST SETUP

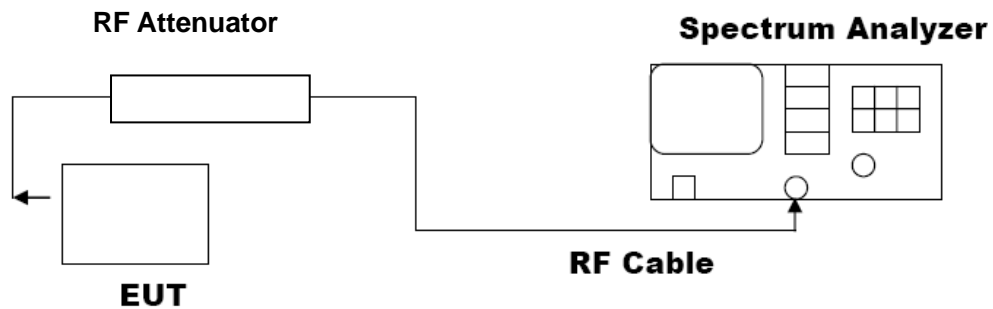

7.3. LIMITS AND MEASUREMENT RESULT

PEAK OUTPUT POWER MEASUREMENT RESULT FOR GFSK MOUDULATION			
Frequency (GHz)	Peak Power (dBm)	Applicable Limits (dBm)	Pass or Fail
2.402	1.234	30	Pass
2.440	3.916	30	Pass
2.480	2.979	30	Pass

CH0

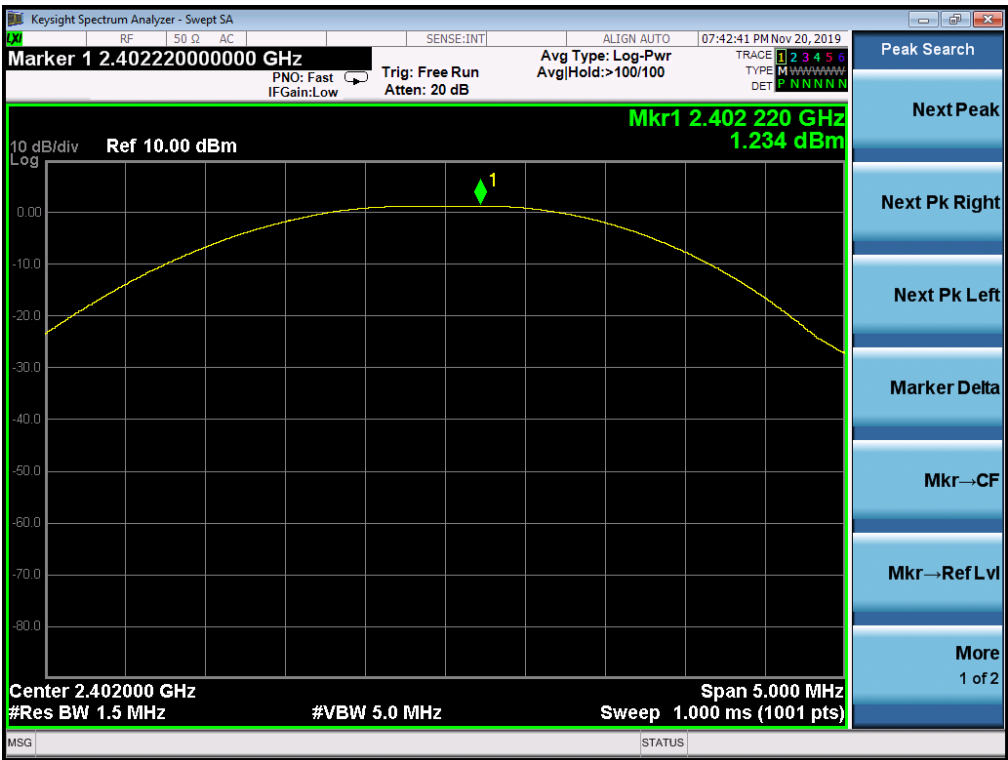

CH19

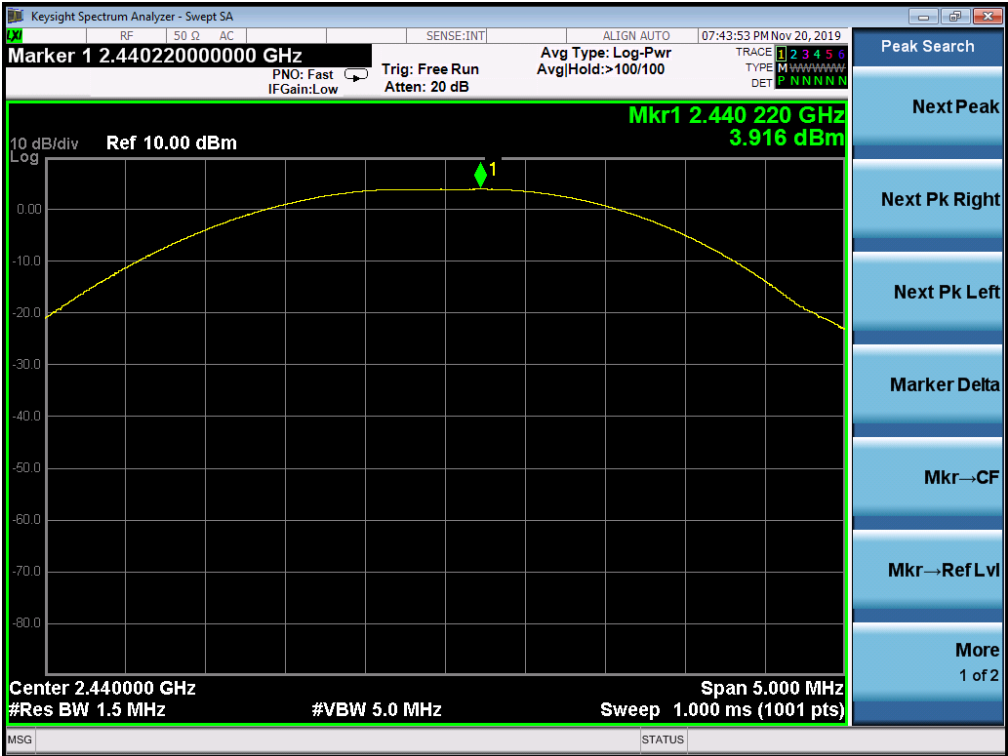

CH39

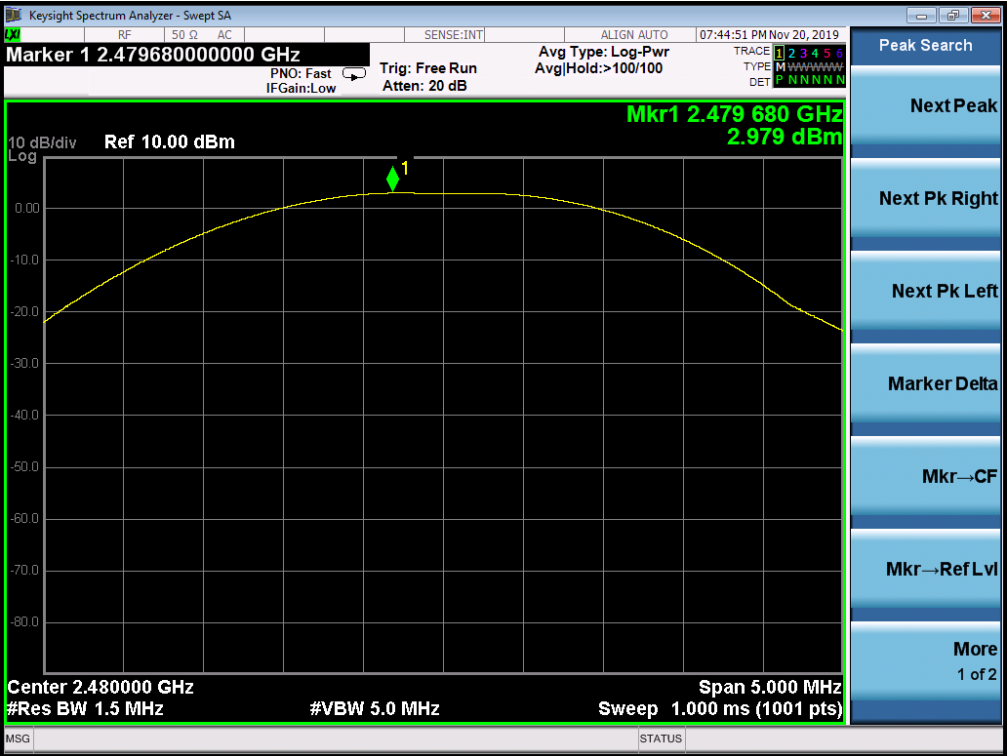

**8. 6 DB BANDWIDTH**

**8.1. MEASUREMENT PROCEDURE**

1. Connect EUT RF output port to the Spectrum Analyzer through an RF attenuator
2. Set the EUT Work on the top, the middle and the bottom operation frequency individually.
3. Set SPA Centre Frequency = Operation Frequency, RBW= 100 KHz, VBW $\geq$ 3 $\times$ RBW.
4. Set SPA Trace 1 Max hold, then View.

**Note:** The EUT was tested according to ANSI C63.10 for compliance to FCC PART 15.247 requirements.

**8.2. TEST SET-UP (BLOCK DIAGRAM OF CONFIGURATION)**

The same as described in section 7.2.

**8.3. LIMITS AND MEASUREMENT RESULTS**

LIMITS AND MEASUREMENT RESULT			
Applicable Limits	Applicable Limits		
	Test Data (kHz)		Criteria
>500KHZ	Low Channel	507.2	PASS
	Middle Channel	506.6	PASS
	High Channel	504.4	PASS

TEST PLOT OF BANDWIDTH FOR LOW CHANNEL

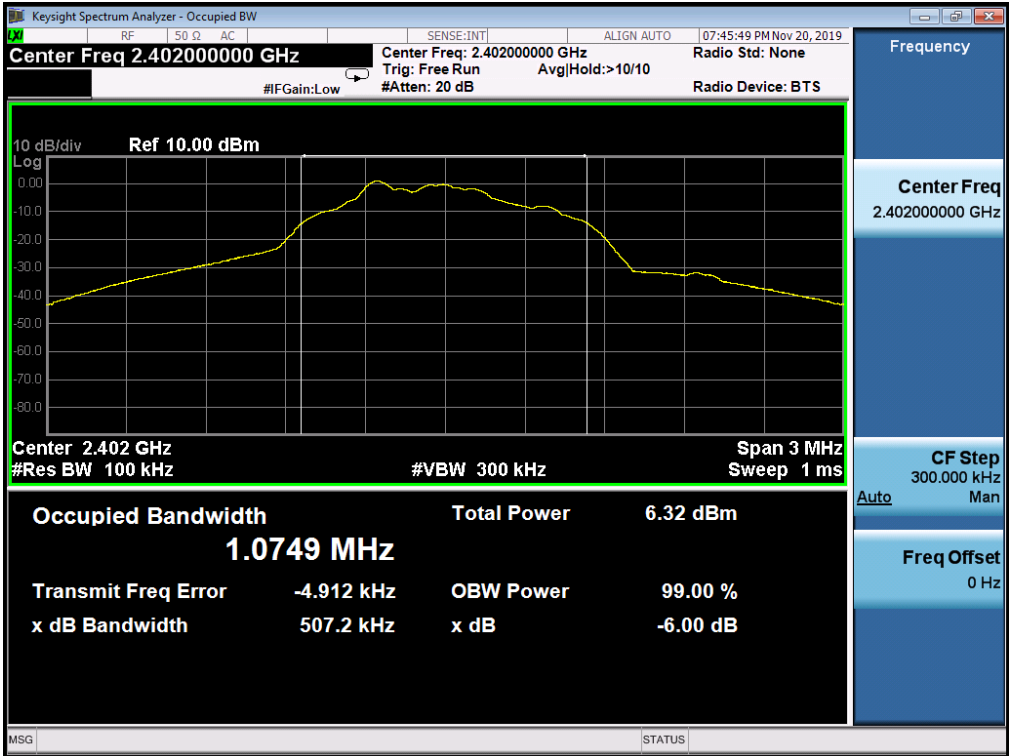

TEST PLOT OF BANDWIDTH FOR MIDDLE CHANNEL

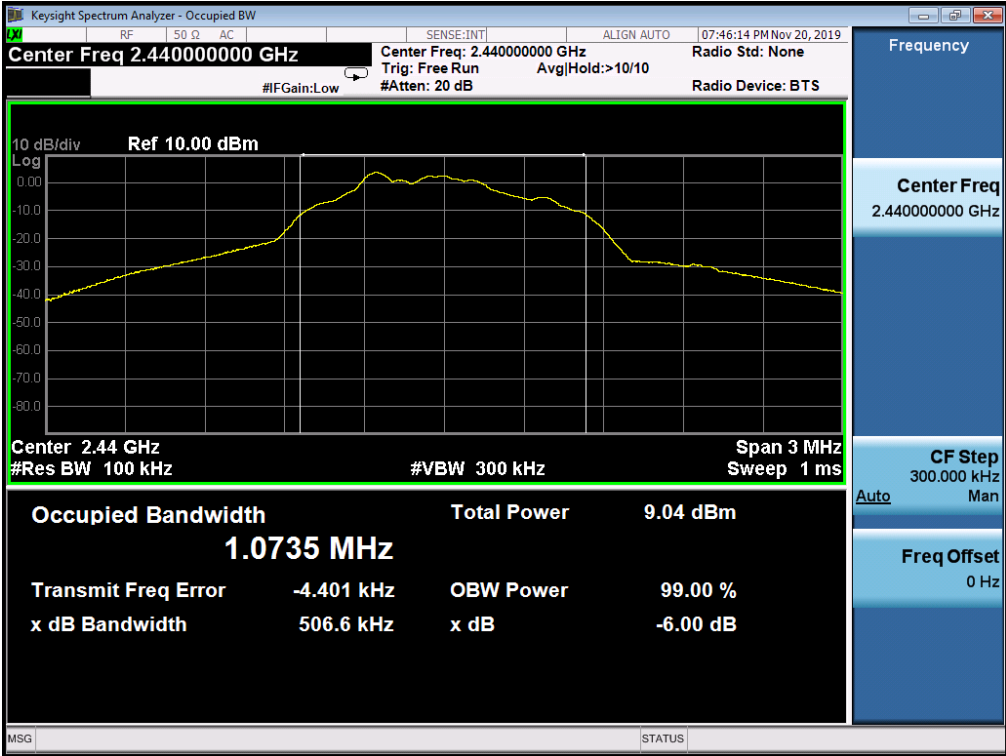

TEST PLOT OF BANDWIDTH FOR HIGH CHANNEL

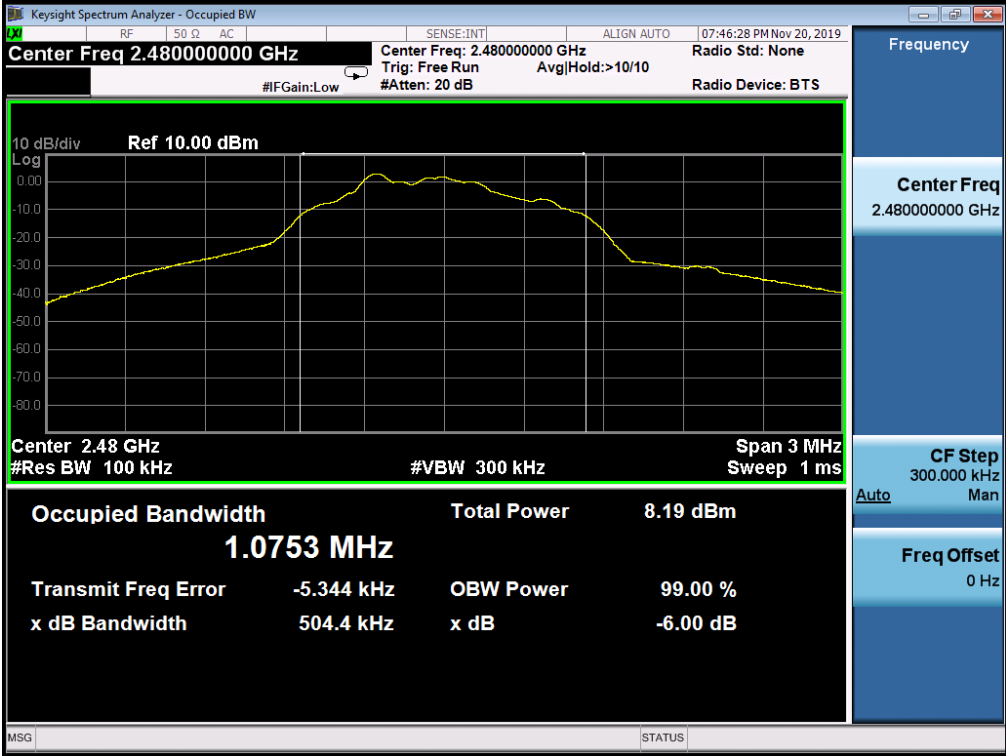



## 9. CONDUCTED SPURIOUS EMISSION

### 9.1. MEASUREMENT PROCEDURE

1. Connect EUT RF output port to the Spectrum Analyzer through an RF attenuator
2. Set the EUT Work on the top, the middle and the bottom operation frequency individually.
3. Set SPA Trace 1 Max hold, then View.

**Note:** The EUT was tested according to ANSI C63.10 for compliance to FCC PART 15.247 requirements.

### 9.2. TEST SET-UP (BLOCK DIAGRAM OF CONFIGURATION)

The same as described in section 7.2.

### 9.3. MEASUREMENT EQUIPMENT USED

The same as described in section 6.

### 9.4. LIMITS AND MEASUREMENT RESULT

LIMITS AND MEASUREMENT RESULT		
Applicable Limits	Measurement Result	
	Test Data	Criteria
In any 100 KHz Bandwidth Outside the frequency band in which the spread spectrum intentional radiator is operating, the radio frequency power that is produce by the intentional radiator shall be at least 20 dB below that in 100KHz bandwidth within the band that contains the highest level of the desired power.	At least -20dBc than the reference level	PASS PASS





GFSK MODULATION IN HIGH CHANNEL

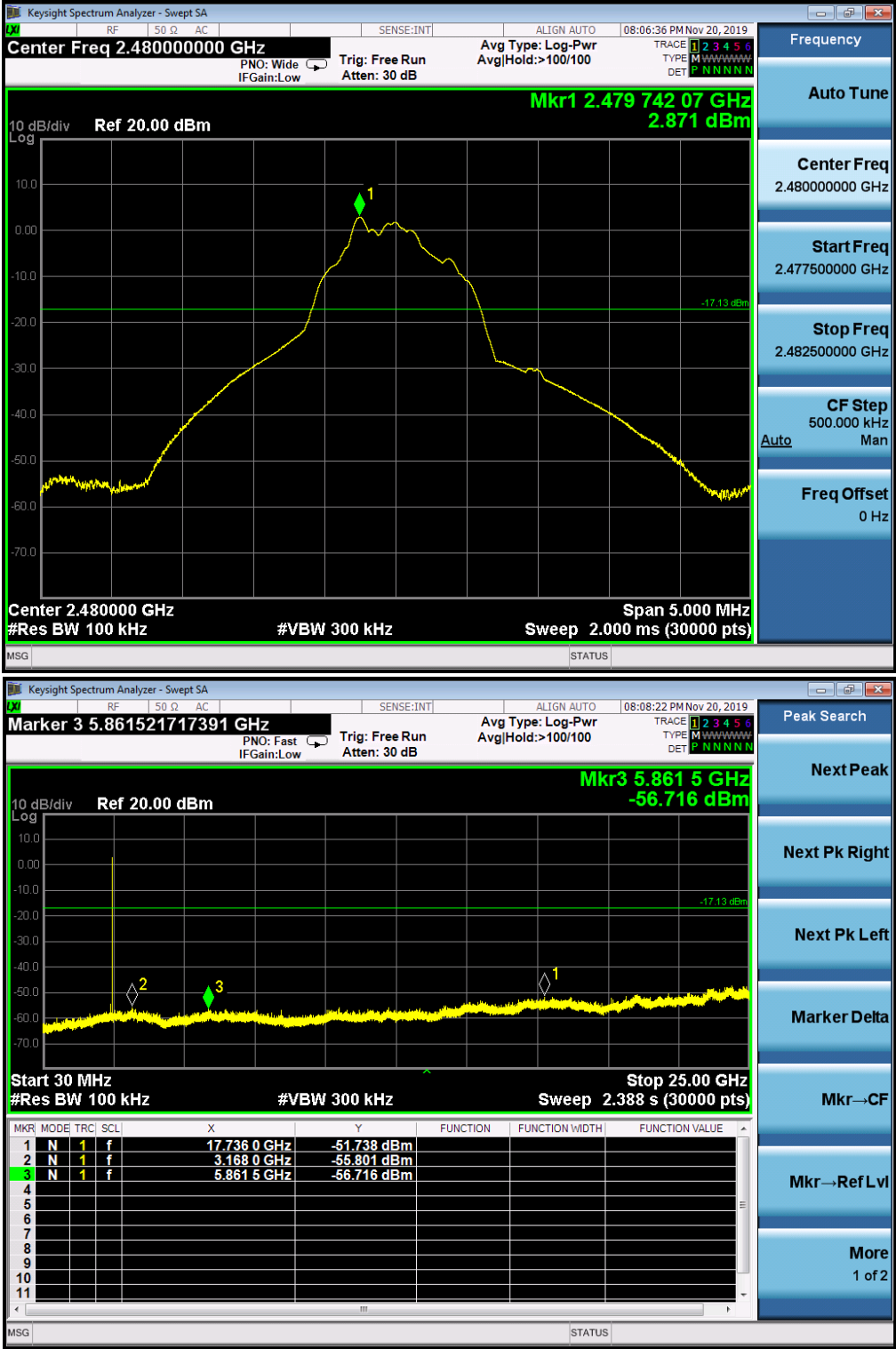

Note: The peak emissions without marker on the above plots are fundamental wave and need not to compare with the limit.



**10. MAXIMUM CONDUCTED OUTPUT POWER SPECTRAL DENSITY**

**10.1 MEASUREMENT PROCEDURE**

- (1). Connect EUT RF output port to the Spectrum Analyzer through an RF attenuator
- (2). Set the EUT Work on the top, the middle and the bottom operation frequency individually.
- (3). Set SPA Trace 1 Max hold, then View.

Note: The method of PKPSD in the KDB 558074 item 10.2 was used in this testing.

**10.2 TEST SET-UP (BLOCK DIAGRAM OF CONFIGURATION)**

Refer To Section 7.2.

**10.3 MEASUREMENT EQUIPMENT USED**

Refer To Section 6.

**10.4 LIMITS AND MEASUREMENT RESULT**

Channel No.	PSD (dBm/3kHz)	Limit (dBm/3kHz)	Result
Low Channel	-15.796	8	Pass
Middle Channel	-12.948	8	Pass
High Channel	-13.801	8	Pass

TEST PLOT OF SPECTRAL DENSITY FOR LOW CHANNEL

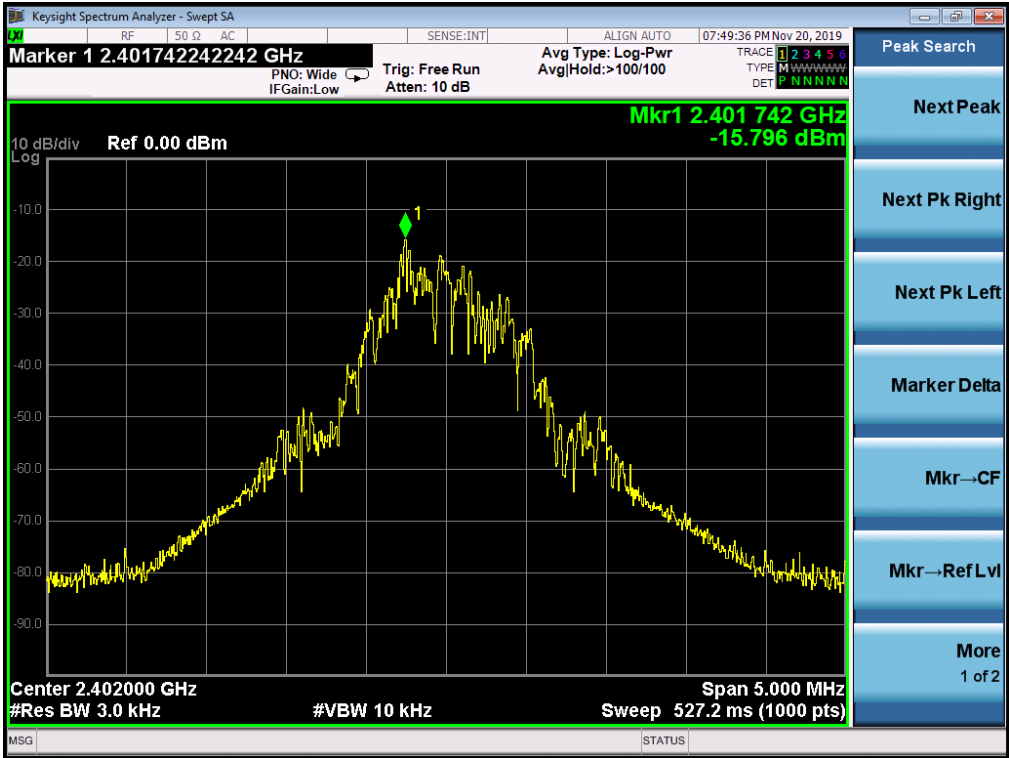

TEST PLOT OF SPECTRAL DENSITY FOR MIDDLE CHANNEL



TEST PLOT OF SPECTRAL DENSITY FOR HIGH CHANNEL

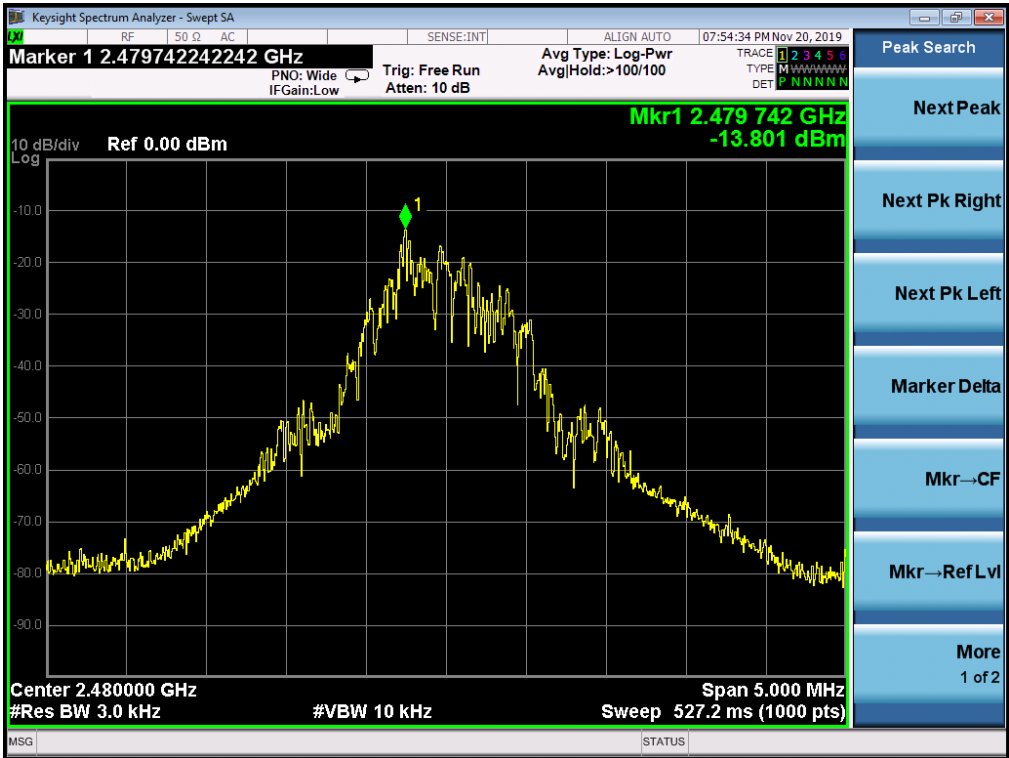

## 11. RADIATED EMISSION

### 11.1. MEASUREMENT PROCEDURE

1. The EUT was placed on the top of the turntable 0.8 or 1.5 meter above ground. The phase center of the receiving antenna mounted on the top of a height-variable antenna tower was placed 3 meters far away from the turntable.
2. Power on the EUT and all the supporting units. The turntable was rotated by 360 degrees to determine the position of the highest radiation.
3. The height of the broadband receiving antenna was varied between one meter and four meters above ground to find the maximum emissions field strength of both horizontal and vertical polarization.
4. For each suspected emissions, the antenna tower was scan (from 1 M to 4 M) and then the turntable was rotated (from 0 degree to 360 degrees) to find the maximum reading.
5. Set the test-receiver system to Peak or CISPR quasi-peak Detect Function with specified bandwidth under Maximum Hold Mode.
6. For emissions above 1GHz, use 1MHz RBW and 3MHz VBW for peak reading. Place the measurement antenna away from each area of the EUT determined to be a source of emissions at the specified measurement distance, while keeping the measurement antenna aimed at the source of emissions at each frequency of significant emissions, with polarization oriented for maximum response. The measurement antenna may have to be higher or lower than the EUT, depending on the radiation pattern of the emission and staying aimed at the emission source for receiving the maximum signal. The final measurement antenna elevation shall be that which maximizes the emissions. The measurement antenna elevation for maximum emissions shall be restricted to a range of heights of from 1 m to 4 m above the ground or reference ground plane.
7. When the radiated emissions limits are expressed in terms of the average value of the emissions, and pulsed operation is employed, the measurement field strength shall be determined by averaging over one complete pulse train, including blanking intervals, as long as the pulse train does not exceed 0.1 seconds. As an alternative (provided the transmitter operates for longer than 0.1 seconds) or in cases where the pulse train exceeds 0.1 seconds, the measured field strength shall be determined from the average absolute voltage during a 0.1 second interval during which the field strength is at its maximum values.
8. If the emissions level of the EUT in peak mode was 3 dB lower than the average limit specified, then testing will be stopped and peak values of EUT will be reported, otherwise, the emissions which do not have 3 dB margin will be repeated one by one using the quasi-peak method for below 1GHz.
9. For testing above 1GHz, the emissions level of the EUT in peak mode was lower than average limit (that means the emissions level in peak mode also complies with the limit in average mode), then testing will be stopped and peak values of EUT will be reported, otherwise, the emissions will be measured in average mode again and reported.
10. In case the emission is lower than 30MHz, loop antenna has to be used for measurement and the recorded data should be QP measured by receiver. High - Low scan is not required in this case.



11.2. TEST SETUP

Radiated Emission Test-Setup Frequency Below 30MHz

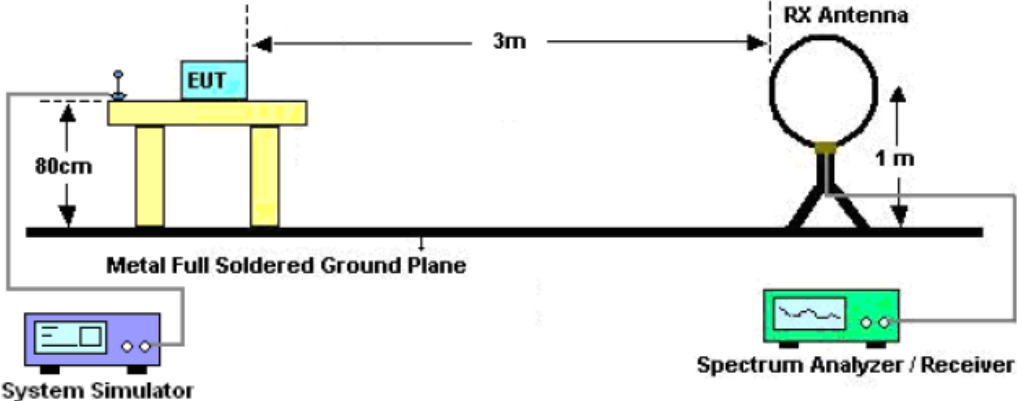

RADIATED EMISSION TEST SETUP 30MHz-1000MHz

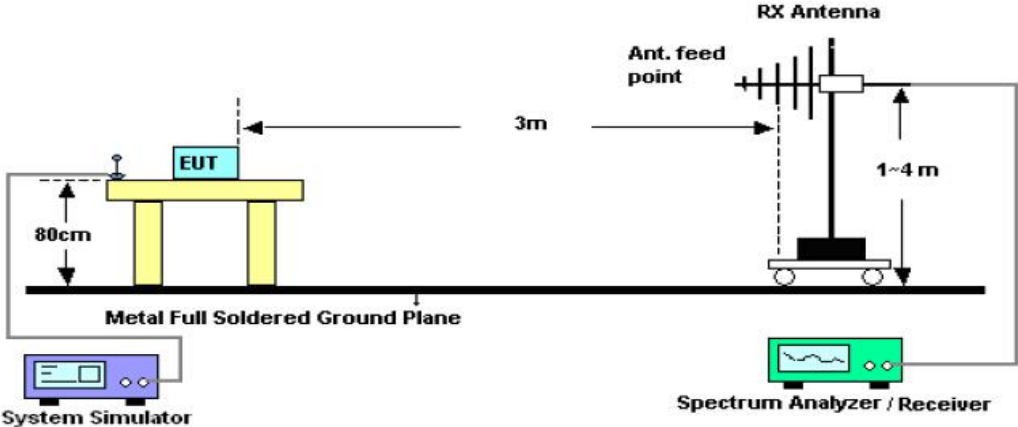

RADIATED EMISSION TEST SETUP ABOVE 1000MHz

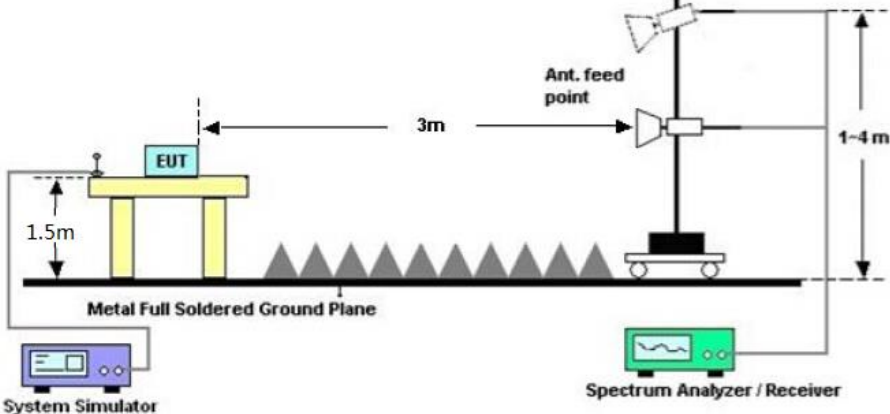

### 11.3. LIMITS AND MEASUREMENT RESULT

15.209 Limit in the below table has to be followed

<b>Frequencies (MHz)</b>	<b>Field Strength (micorvolts/meter)</b>	<b>Measurement Distance (meters)</b>
0.009~0.490	2400/F(KHz)	300
0.490~1.705	24000/F(KHz)	30
1.705~30.0	30	30
30~88	100	3
88~216	150	3
216~960	200	3
Above 960	500	3

Note: All modes were tested For restricted band radiated emission,  
the test records reported below are the worst result compared to other modes.

### 11.4. TEST RESULT

#### **RADIATED EMISSION BELOW 30MHZ**

No emission found between lowest internal used/generated frequencies to 30MHz.

**RADIATED EMISSION BELOW 1GHZ**

<b>EUT</b>	Smartphone	<b>Model Name</b>	Gravity 6P
<b>Temperature</b>	25° C	<b>Relative Humidity</b>	55.4%
<b>Pressure</b>	960hPa	<b>Test Voltage</b>	Normal Voltage
<b>Test Mode</b>	Mode 1	<b>Antenna</b>	Horizontal

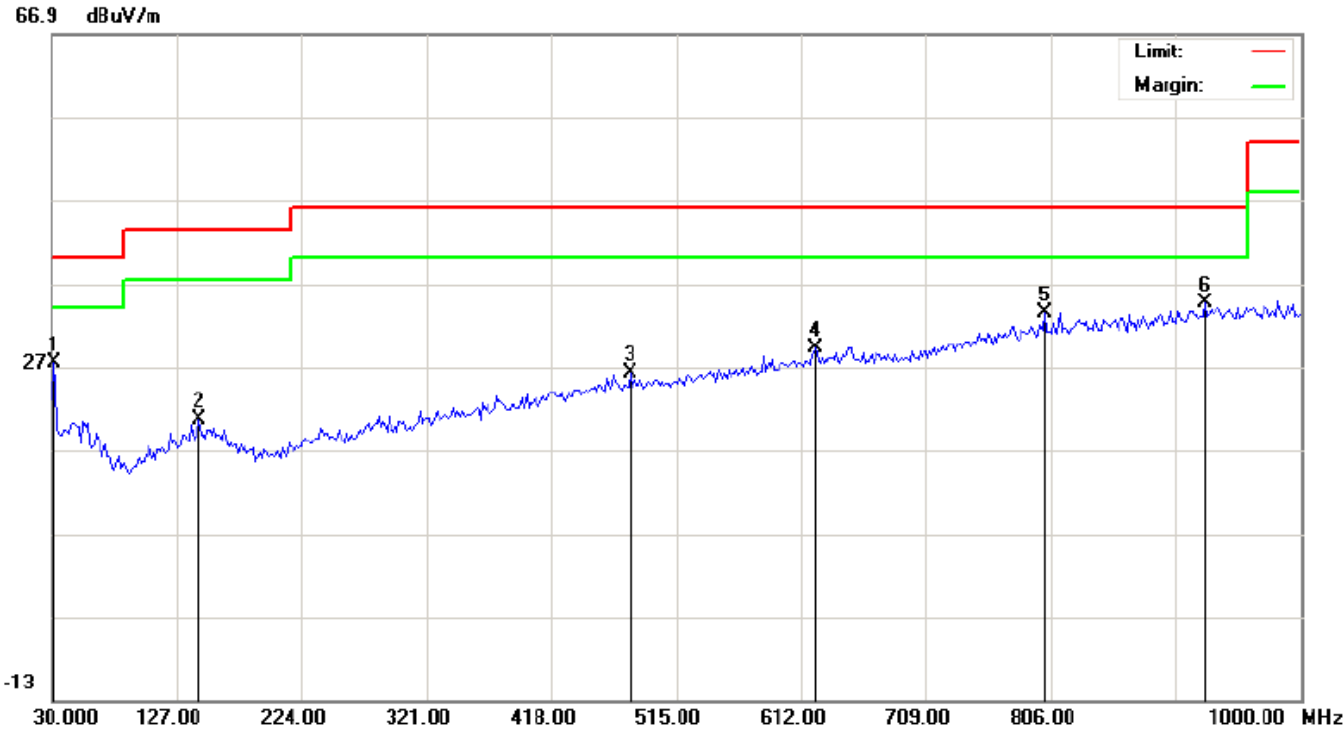

No.	Mk	Freq.	Reading	Factor	Measurement	Limit	Over	Detector	Antenna Height	Table Degree	Comment
		MHz	dBuV	dB/m	dBuV/m	dBuV/m	dB		cm	degree	
1		31.6167	9.09	18.22	27.31	40.00	-12.69	peak			
2		144.7833	1.39	19.22	20.61	43.50	-22.89	peak			
3		479.4333	1.60	24.58	26.18	46.00	-19.82	peak			
4		623.3167	2.06	27.23	29.29	46.00	-16.71	peak			
5		801.1500	3.01	30.42	33.43	46.00	-12.57	peak			
6	*	925.6333	2.69	31.92	34.61	46.00	-11.39	peak			

**RESULT: PASS**

<b>EUT</b>	Smartphone	<b>Model Name</b>	Gravity 6P
<b>Temperature</b>	25° C	<b>Relative Humidity</b>	55.4%
<b>Pressure</b>	960hPa	<b>Test Voltage</b>	Normal Voltage
<b>Test Mode</b>	Mode 1	<b>Antenna</b>	Vertical

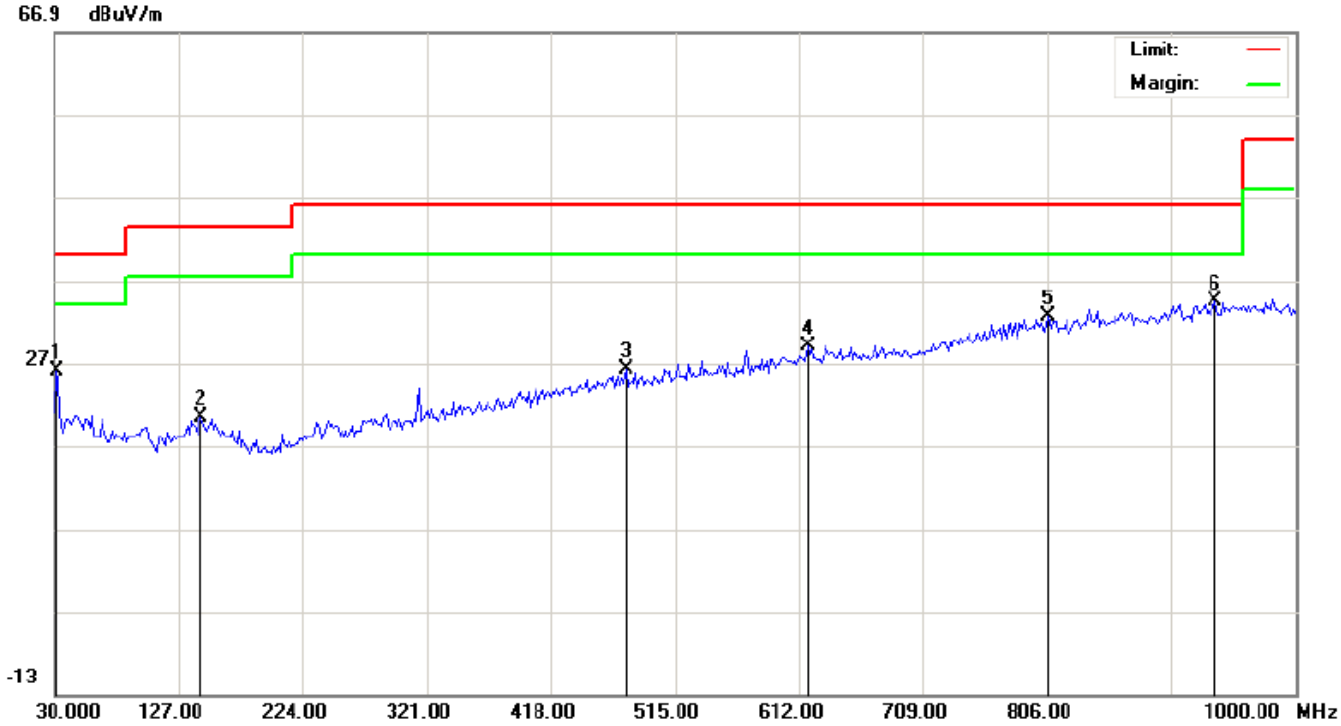

No.	Mk	Freq.	Reading	Factor	Measurement	Limit	Over	Detector	Antenna Height	Table Degree	Comment
		MHz	dBuV	dB/m	dBuV/m	dBuV/m	dB		cm	degree	
1		31.6167	7.88	18.22	26.10	40.00	-13.90	peak			
2		144.7833	1.25	19.22	20.47	43.50	-23.03	peak			
3		476.2000	1.75	24.51	26.26	46.00	-19.74	peak			
4		618.4667	1.86	27.17	29.03	46.00	-16.97	peak			
5		806.0000	2.06	30.49	32.55	46.00	-13.45	peak			
6	*	936.9500	2.38	32.02	34.40	46.00	-11.60	peak			

**RESULT: PASS**

**Note:**

1. Factor=Antenna Factor + Cable loss, Margin=Measurement-Limit.
2. All test modes had been tested. The mode 1 is the worst case and recorded in the report.
3. The adapter-1 is the worst case and recorded in the report.

**RADIATED EMISSION ABOVE 1GHZ**

<b>EUT</b>	Smartphone	<b>Model Name</b>	Gravity 6P
<b>Temperature</b>	25° C	<b>Relative Humidity</b>	55.4%
<b>Pressure</b>	960hPa	<b>Test Voltage</b>	Normal Voltage
<b>Test Mode</b>	Mode 1	<b>Antenna</b>	Horizontal

Frequency (MHz)	Meter Reading (dB $\mu$ V)	Factor (dB)	Emission Level (dB $\mu$ V/m)	Limits (dB $\mu$ V/m)	Margin (dB)	Value Type
4804.011	47.58	0.08	47.66	74.00	-26.34	peak
4804.011	45.63	0.08	45.71	54.00	-8.29	AVG
7206.022	43.25	2.21	45.46	74.00	-28.54	peak
7206.022	41.08	2.21	43.29	54.00	-10.71	AVG

Remark:

Factor = Antenna Factor + Cable Loss – Pre-amplifier.

<b>EUT</b>	Smartphone	<b>Model Name</b>	Gravity 6P
<b>Temperature</b>	25° C	<b>Relative Humidity</b>	55.4%
<b>Pressure</b>	960hPa	<b>Test Voltage</b>	Normal Voltage
<b>Test Mode</b>	Mode 1	<b>Antenna</b>	Vertical

Frequency (MHz)	Meter Reading (dB $\mu$ V)	Factor (dB)	Emission Level (dB $\mu$ V/m)	Limits (dB $\mu$ V/m)	Margin (dB)	Value Type
4804.011	46.86	0.08	46.94	74.00	-27.06	peak
4804.011	44.27	0.08	44.35	54.00	-9.65	AVG
7206.022	41.85	2.21	44.06	74.00	-29.94	peak
7206.022	39.01	2.21	41.22	54.00	-12.78	AVG

Remark:

Factor = Antenna Factor + Cable Loss – Pre-amplifier.

<b>EUT</b>	Smartphone	<b>Model Name</b>	Gravity 6P
<b>Temperature</b>	25° C	<b>Relative Humidity</b>	55.4%
<b>Pressure</b>	960hPa	<b>Test Voltage</b>	Normal Voltage
<b>Test Mode</b>	Mode 2	<b>Antenna</b>	Horizontal

Frequency (MHz)	Meter Reading (dB $\mu$ V)	Factor (dB)	Emission Level (dB $\mu$ V/m)	Limits (dB $\mu$ V/m)	Margin (dB)	Value Type
4880.005	47.52	0.14	47.66	74.00	-26.34	peak
4880.005	45.13	0.14	45.27	54.00	-8.73	AVG
7320.140	42.59	2.36	44.95	74.00	-29.05	peak
7320.140	40.03	2.36	42.39	54.00	-11.61	AVG
Remark:						
Factor = Antenna Factor + Cable Loss – Pre-amplifier.						

<b>EUT</b>	Smartphone	<b>Model Name</b>	Gravity 6P
<b>Temperature</b>	25° C	<b>Relative Humidity</b>	55.4%
<b>Pressure</b>	960hPa	<b>Test Voltage</b>	Normal Voltage
<b>Test Mode</b>	Mode 2	<b>Antenna</b>	Vertical

Frequency (MHz)	Meter Reading (dB $\mu$ V)	Factor (dB)	Emission Level (dB $\mu$ V/m)	Limits (dB $\mu$ V/m)	Margin (dB)	Value Type
4880.050	48.69	0.14	48.83	74.00	-25.17	peak
4880.050	46.38	0.14	46.52	54.00	-7.48	AVG
7320.080	41.52	2.36	43.88	74.00	-30.12	peak
7320.080	39.04	2.36	41.40	54.00	-12.60	AVG
Remark:						
Factor = Antenna Factor + Cable Loss – Pre-amplifier.						

<b>EUT</b>	Smartphone	<b>Model Name</b>	Gravity 6P
<b>Temperature</b>	25° C	<b>Relative Humidity</b>	55.4%
<b>Pressure</b>	960hPa	<b>Test Voltage</b>	Normal Voltage
<b>Test Mode</b>	Mode 3	<b>Antenna</b>	Horizontal

Frequency (MHz)	Meter Reading (dBμV)	Factor (dB)	Emission Level (dBμV/m)	Limits (dBμV/m)	Margin (dB)	Value Type
4960.012	50.16	0.22	50.38	74.00	-23.62	peak
4960.012	48.21	0.22	48.43	54.00	-5.57	AVG
7440.027	46.02	2.64	48.66	74.00	-25.34	peak
7440.027	43.69	2.64	46.33	54.00	-7.67	AVG
Remark:						
Factor = Antenna Factor + Cable Loss – Pre-amplifier.						

<b>EUT</b>	Smartphone	<b>Model Name</b>	Gravity 6P
<b>Temperature</b>	25° C	<b>Relative Humidity</b>	55.4%
<b>Pressure</b>	960hPa	<b>Test Voltage</b>	Normal Voltage
<b>Test Mode</b>	Mode 3	<b>Antenna</b>	Vertical

Frequency (MHz)	Meter Reading (dBμV)	Factor (dB)	Emission Level (dBμV/m)	Limits (dBμV/m)	Margin (dB)	Value Type
4960.013	47.13	0.22	47.35	74	-26.65	peak
4960.013	45.07	0.22	45.29	54	-8.71	AVG
7440.027	43.19	2.64	45.83	74	-28.17	peak
7440.027	40.99	2.64	43.63	54	-10.37	AVG
Remark:						
Factor = Antenna Factor + Cable Loss – Pre-amplifier.						

**RESULT: PASS****Note:**

1. Other emissions from 1G to 25 GHz are considered as ambient noise. No recording in the test report.

Factor = Antenna Factor + Cable loss - Amplifier gain, Over=Measure-Limit.

The "Factor" value can be calculated automatically by software of measurement system.

2. The adapter-1 is the worst case and recorded in the report.

**TEST RESULT FOR RESTRICTED BANDS REQUIREMENTS**

EUT	Smartphone	Model Name	Gravity 6P
Temperature	25° C	Relative Humidity	55.4%
Pressure	960hPa	Test Voltage	Normal Voltage
Test Mode	Mode 1	Antenna	Horizontal

PK

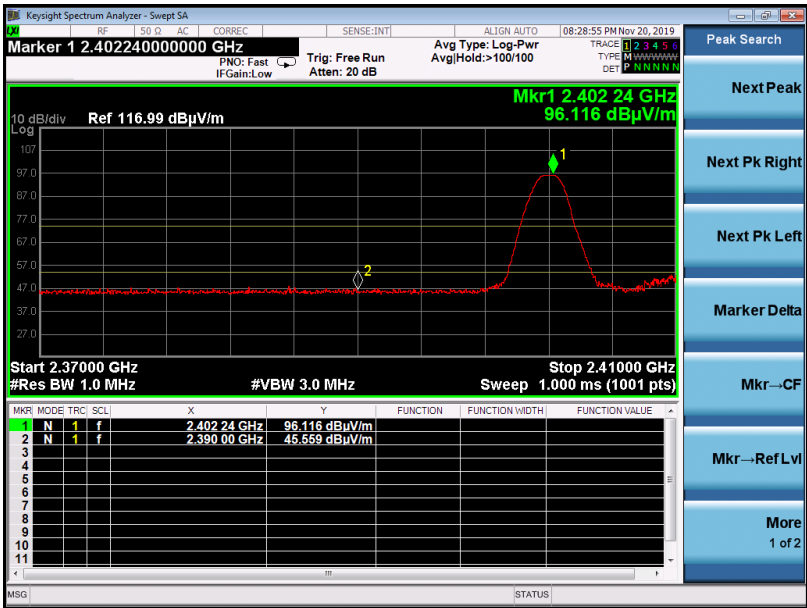

AV

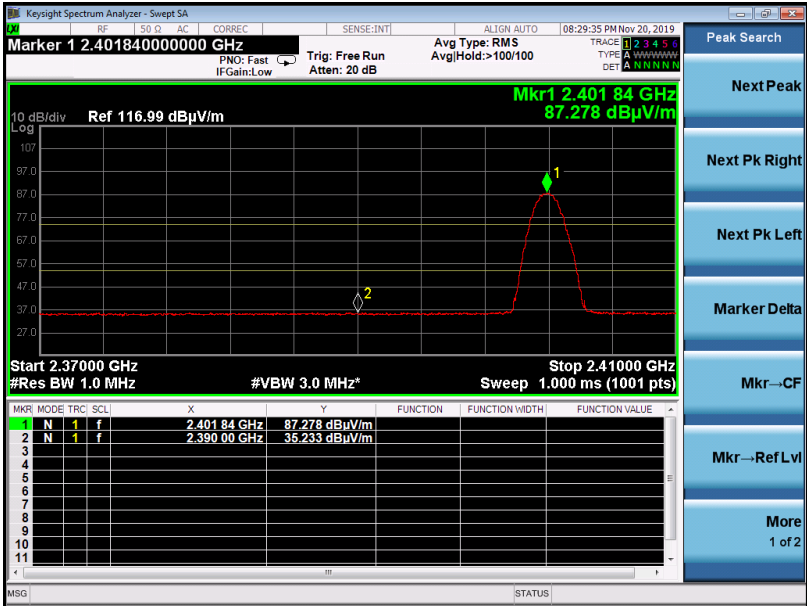

RESULT: PASS



EUT	Smartphone	Model Name	Gravity 6P
Temperature	25° C	Relative Humidity	55.4%
Pressure	960hPa	Test Voltage	Normal Voltage
Test Mode	Mode 1	Antenna	Vertical

PK

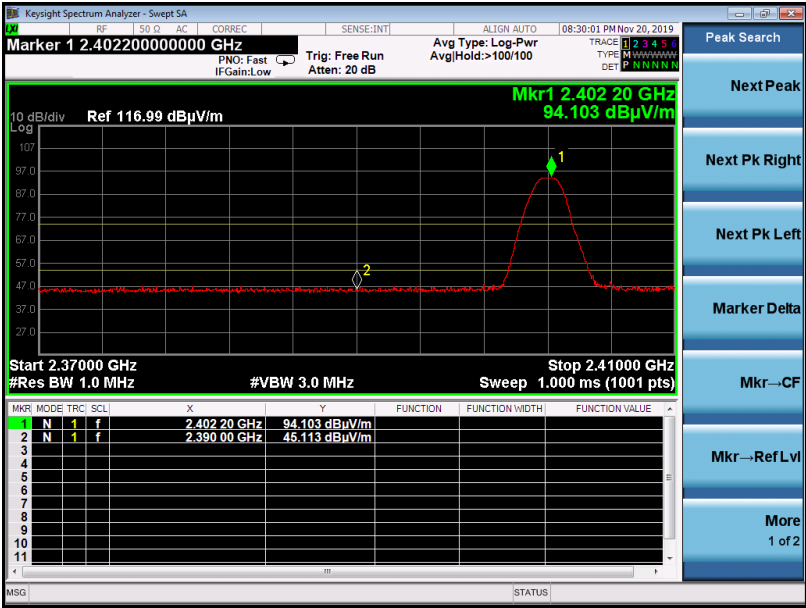

AV

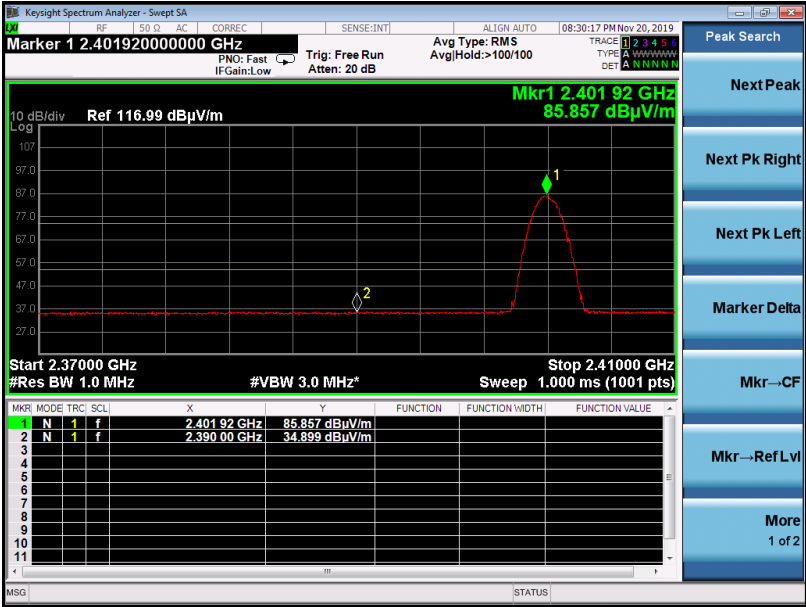

RESULT: PASS

EUT	Smartphone	Model Name	Gravity 6P
Temperature	25° C	Relative Humidity	55.4%
Pressure	960hPa	Test Voltage	Normal Voltage
Test Mode	Mode 3	Antenna	Horizontal

PK

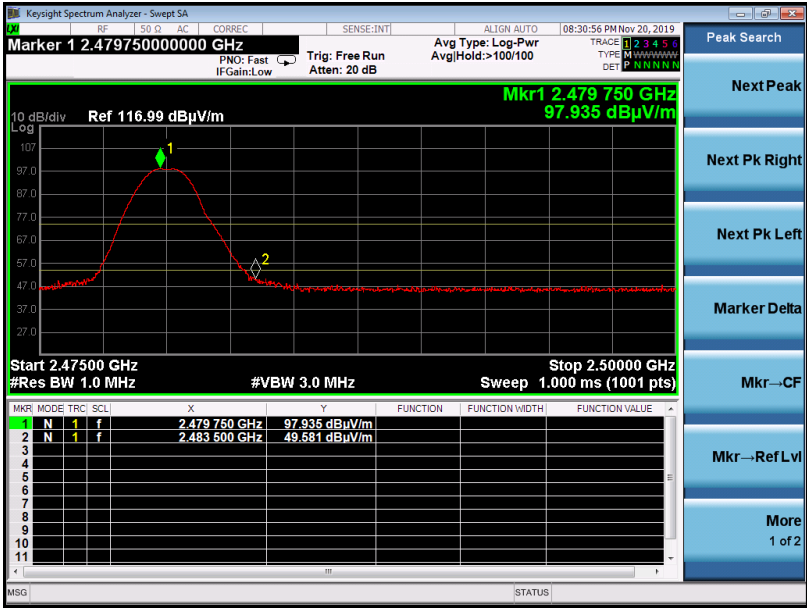

AV

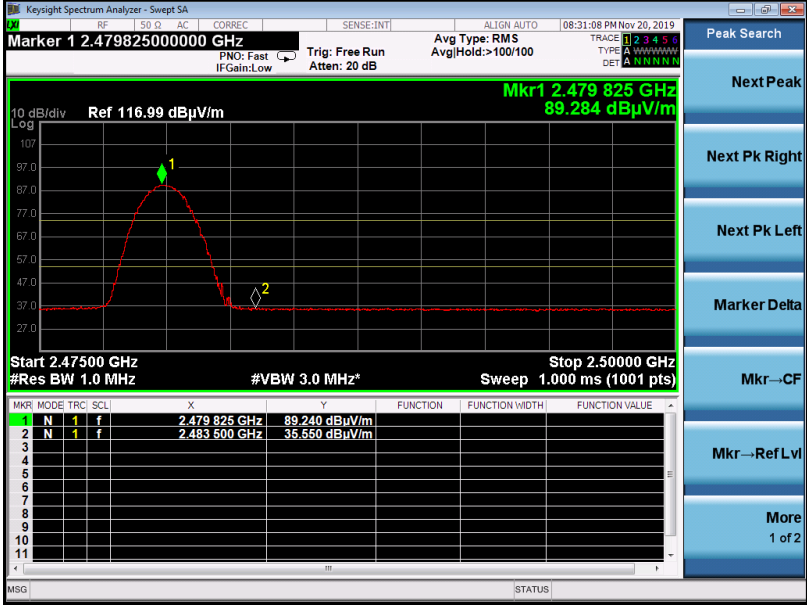

RESULT: PASS

EUT	Smartphone	Model Name	Gravity 6P
Temperature	25° C	Relative Humidity	55.4%
Pressure	960hPa	Test Voltage	Normal Voltage
Test Mode	Mode 3	Antenna	Vertical

PK

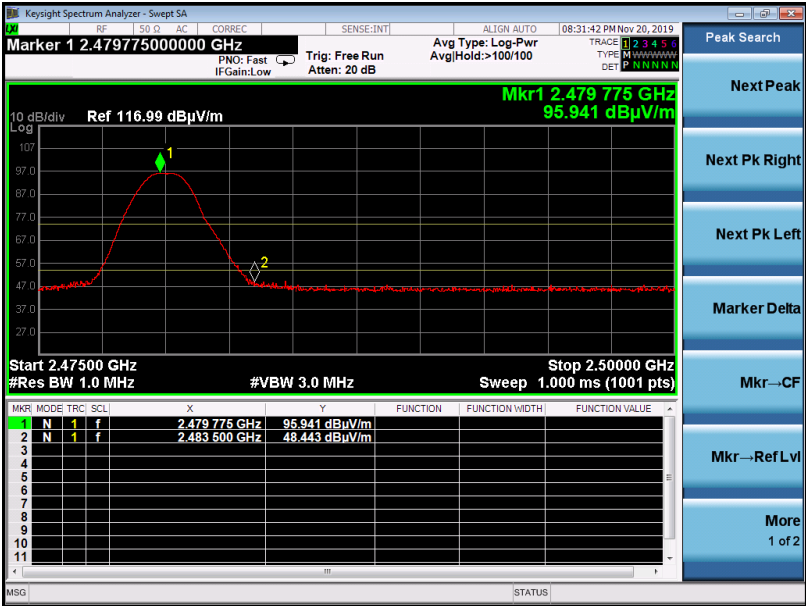

AV



**RESULT: PASS**

**Note:** The factor had been edited in the “Input Correction” of the Spectrum Analyzer. So the Amplitude of test plots is equal to Reading level plus the Factor in dB. Use the A dB(µV) to represent the Amplitude. Use the F dB(µV/m) to represent the Field Strength. So A=F.

**12. FCC LINE CONDUCTED EMISSION TEST**

**12.1. LIMITS OF LINE CONDUCTED EMISSION TEST**

Frequency	Maximum RF Line Voltage	
	Q.P.( dBuV)	Average( dBuV)
150kHz~500kHz	66-56	56-46
500kHz~5MHz	56	46
5MHz~30MHz	60	50

Note:

1. The lower limit shall apply at the transition frequency.
2. The limit decreases linearly with the logarithm of the frequency in the range 0.15 MHz to 0.50 MHz.

**12.2. BLOCK DIAGRAM OF LINE CONDUCTED EMISSION TEST**

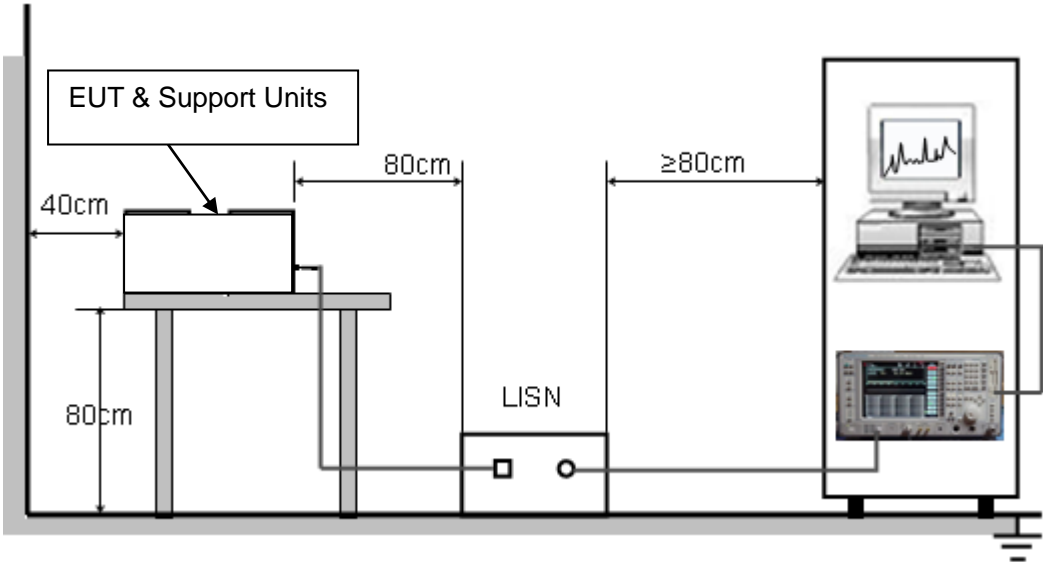

### 12.3. PRELIMINARY PROCEDURE OF LINE CONDUCTED EMISSION TEST

1. The equipment was set up as per the test configuration to simulate typical actual usage per the user's manual. When the EUT is a Smart Phoneop system, a wooden table with a height of 0.8 meters is used and is placed on the ground plane as per ANSI C63.10 (see Test Facility for the dimensions of the ground plane used). When the EUT is a floor-standing equipment, it is placed on the ground plane which has a 3-12 mm non-conductive covering to insulate the EUT from the ground plane.
2. Support equipment, if needed, was placed as per ANSI C63.10.
3. All I/O cables were positioned to simulate typical actual usage as per ANSI C63.10.
4. All support equipments received AC120V/60Hz power from a LISN, if any.
5. The EUT received DC charging voltage by PC which received AC120V/60Hz power by a LISN..
6. The test program was started. Emissions were measured on each current carrying line of the EUT using a spectrum Analyzer / Receiver connected to the LISN powering the EUT. The LISN has two monitoring points: Line 1 (Hot Side) and Line 2 (Neutral Side). Two scans were taken: one with Line 1 connected to Analyzer / Receiver and Line 2 connected to a 50 ohm load; the second scan had Line 1 connected to a 50 ohm load and Line 2 connected to the Analyzer / Receiver.
7. Analyzer / Receiver scanned from 150 kHz to 30MHz for emissions in each of the test modes.
8. During the above scans, the emissions were maximized by cable manipulation.
9. The test mode(s) were scanned during the preliminary test.

Then, the EUT configuration and cable configuration of the above highest emission level were recorded for reference of final testing.

### 12.4. FINAL PROCEDURE OF LINE CONDUCTED EMISSION TEST

1. EUT and support equipment was set up on the test bench as per step 2 of the preliminary test.
2. A scan was taken on both power lines, Line 1 and Line 2, recording at least the six highest emissions. Emission frequency and amplitude were recorded into a computer in which correction factors were used to calculate the emission level and compare reading to the applicable limit. If EUT emission level was less -2dB to the A.V. limit in Peak mode, then the emission signal was re-checked using Q.P and Average detector.
3. The test data of the worst case condition(s) was reported on the Summary Data page.

**12.5. TEST RESULT OF LINE CONDUCTED EMISSION TEST**

Line Conducted Emission Test Line 1-L

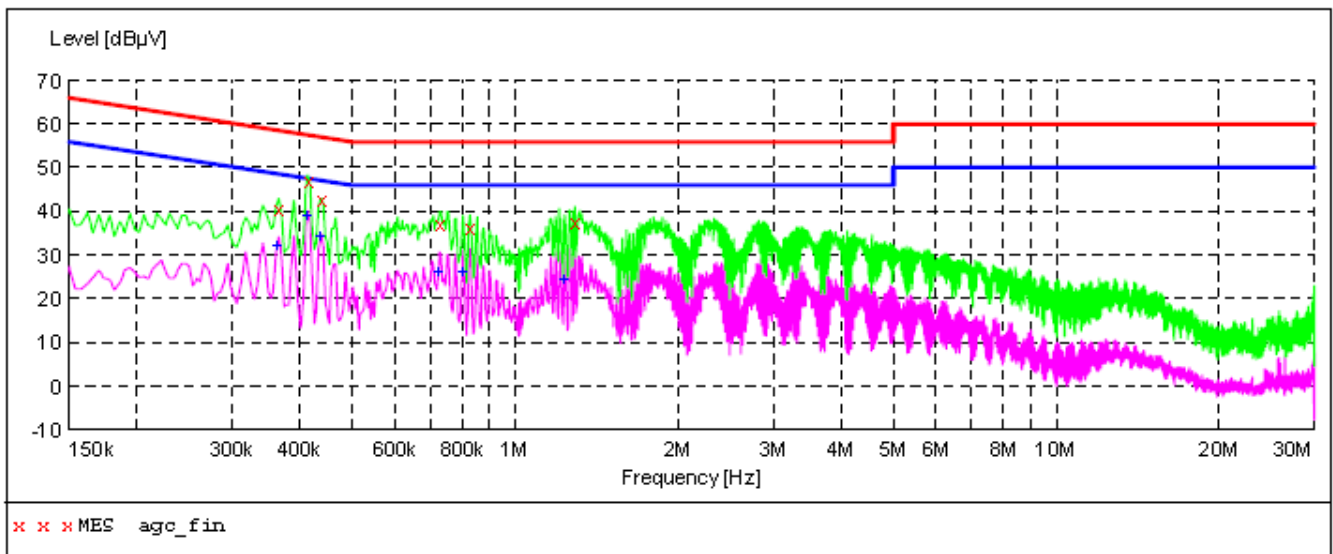

**MEASUREMENT RESULT: "agc\_fin"**

2019/11/8 22:59

Frequency MHz	Level dBµV	Transd dB	Limit dBµV	Margin dB	Detector	Line	PE
0.366000	40.60	10.4	59	18.0	QP	L1	FLO
0.414000	47.00	10.3	58	10.6	QP	L1	FLO
0.438000	42.70	10.5	57	14.4	QP	L1	FLO
0.726000	37.00	10.3	56	19.0	QP	L1	FLO
0.826000	36.20	10.7	56	19.8	QP	L1	FLO
1.294000	37.60	11.3	56	18.4	QP	L1	FLO

**MEASUREMENT RESULT: "agc\_fin2"**

2019/11/8 22:58

Frequency MHz	Level dBµV	Transd dB	Limit dBµV	Margin dB	Detector	Line	PE
0.366000	32.70	10.4	49	15.9	AV	L1	FLO
0.414000	39.60	10.3	48	8.0	AV	L1	FLO
0.438000	34.90	10.5	47	12.2	AV	L1	FLO
0.726000	26.80	10.3	46	19.2	AV	L1	FLO
0.802000	26.70	10.6	46	19.3	AV	L1	FLO
1.238000	24.90	11.3	46	21.1	AV	L1	FLO

Line Conducted Emission Test Line 2-N

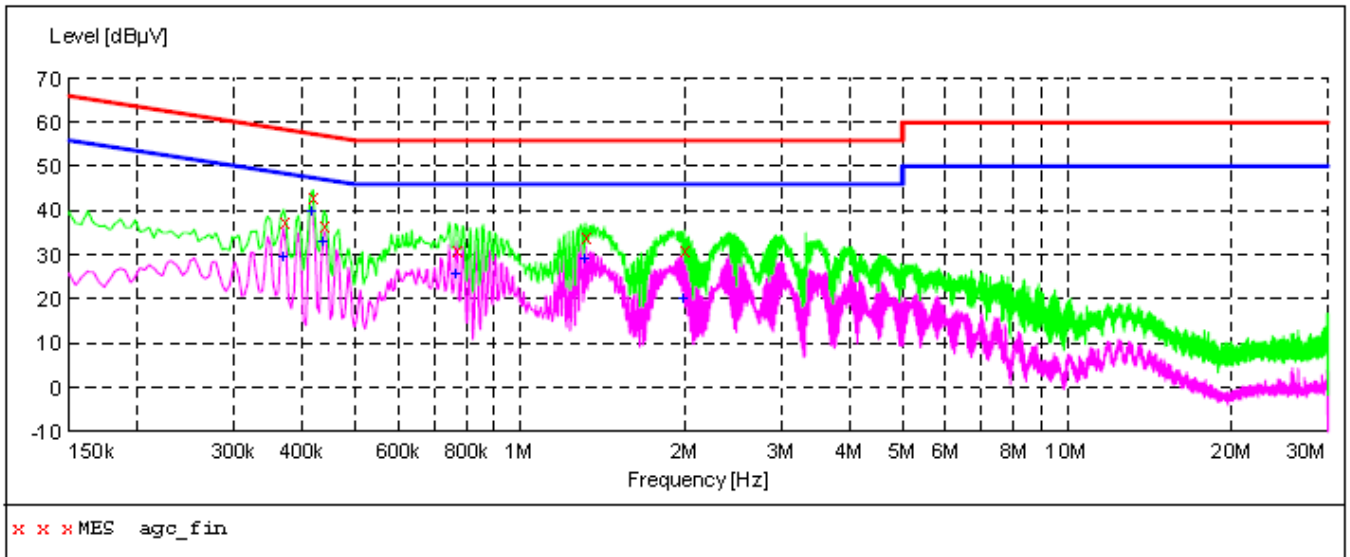

**MEASUREMENT RESULT: "agc\_fin"**

2019/11/8 23:03

Frequency MHz	Level dBuV	Transd dB	Limit dBuV	Margin dB	Detector	Line	PE
0.370000	37.60	10.4	59	20.9	QP	N	FLO
0.418000	43.20	10.3	58	14.3	QP	N	FLO
0.438000	36.70	10.5	57	20.4	QP	N	FLO
0.766000	31.30	10.4	56	24.7	QP	N	FLO
1.318000	34.40	11.3	56	21.6	QP	N	FLO
1.994000	31.10	11.3	56	24.9	QP	N	FLO

**MEASUREMENT RESULT: "agc\_fin2"**

2019/11/8 23:03

Frequency MHz	Level dBuV	Transd dB	Limit dBuV	Margin dB	Detector	Line	PE
0.370000	30.10	10.4	49	18.4	AV	N	FLO
0.418000	40.20	10.3	48	7.3	AV	N	FLO
0.438000	33.50	10.5	47	13.6	AV	N	FLO
0.766000	25.90	10.4	46	20.1	AV	N	FLO
1.318000	29.70	11.3	46	16.3	AV	N	FLO
1.994000	20.80	11.3	46	25.2	AV	N	FLO

**RESULT: PASS**

- Note: All the test modes had been tested, the mode 1 was the worst case. Only the data of the worst case would be record in this test report.
- The adapter-1 is the worst case and recorded in the report.



**APPENDIX A: PHOTOGRAPHS OF TEST SETUP**  
**RADIATED EMISSION TEST SETUP BELOW 1GHZ**

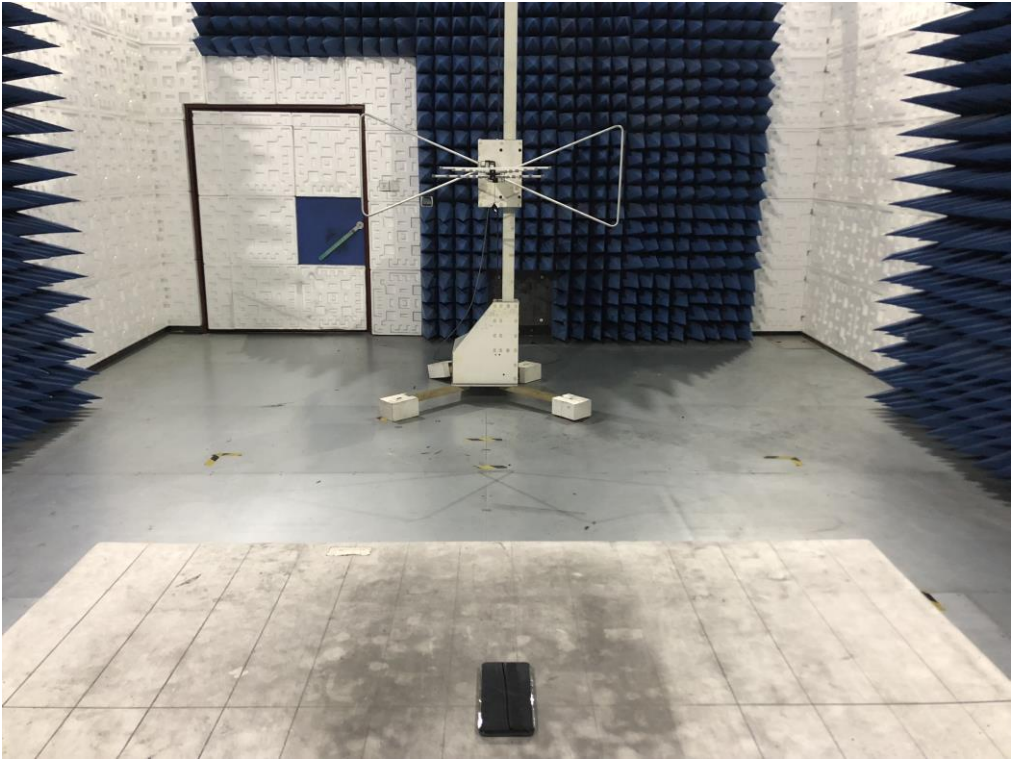

**RADIATED EMISSION TEST SETUP ABOVE 1GHZ**





CONDUCTED EMISSION TEST SETUP



----END OF REPORT----