



东莞市一佳电子通讯科技有限公司

Dongguan YiJia Electronics Communication Technology Co.,Ltd.

规格承认书

SPECIFICATION FOR APPROVAL

日期 Date 2023/06/09

编号 File No 23060901

版本 Revision 1.0

客户
CUSTOMER:

恩威视 Envisiontech

客户料号
CUSTOMER NO:

智能绿头鸭

品名
PART NAME:

WIFI Antenna L=110.0mm MHF

供方料号
SUPPLIER NO:

YJT01.182.021.301A

送样日期Date:

送样数量Q “TY:

客户确认CUSTOMER APPROVED BY

APPROVAL	CHIEF	SUPERVISOR

供方确认 SUPPLIER SIGNATURE

APPROVAL	CHECK	DESIGN
 ChenGuoqiang	XieLi	ChenXingyi

YJ-RD-F04-A

add: 东莞市长安镇沙头社区木鱼路59号元富工业区 Tel:0769-82586086 Fax:0769-82586086

Yuanfu Industrial Zone, 59 Muyu Road, Shatou Community, Changan Town, Dongguan City

RoHS
Compatible

CUSTOMER	
PART NO	

REV.	DESCRIPTION	DATE
△	首次发行	2023-03-15

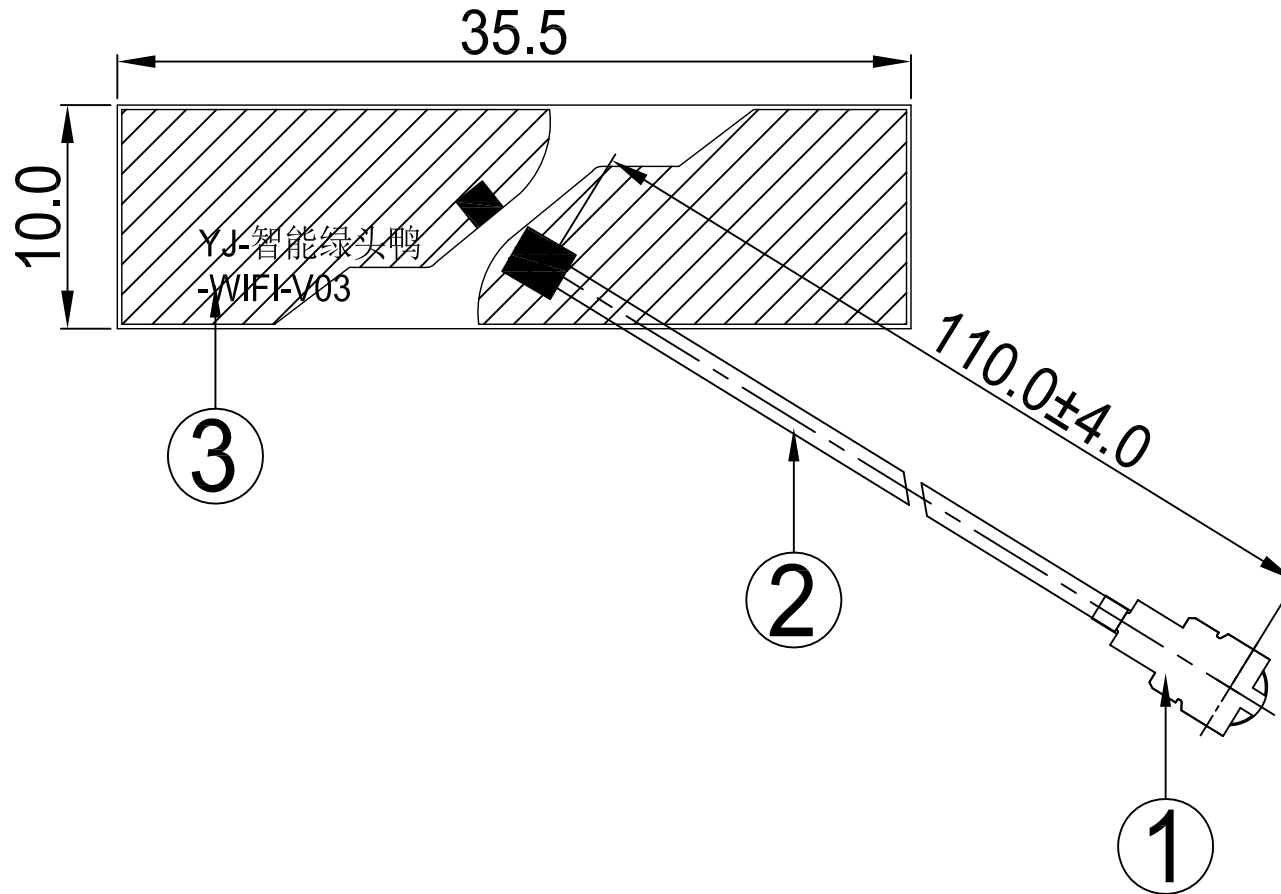

 东莞市一佳电子通讯科技有限公司
Dongguan YiJia Electronics Communication Technology Co.,Ltd. Tel :0769-82586086 Fax:0769-82586086

PART NAME: WIFI Antenna L=110.0mm MHF			
PART NO.: YJT01.182.021.301A			DATE: 2023-03-15
APPROVED BY	CHECKED BY	DESIGNED BY	 Tolerance X.X ±0.50 X.XX±0.15 X° ±3°
陆明兰	林斌	陈俊	
UNITS: mm SCALE: 1/1 REVISION: A			

3	FPC	35.5*10.0mm	FPC	FPC11XXXA.P01	1
2	Coaxial Cable	O.D.1.13 Black	O.D.1.13	COA100XXA.P01	1
1	Mini Connector	Au Plated 1代	Cu	TER100XXA.P01	1
NO	PART NAME	DESCRIPTION	Material	Part Number	Q.TY



天线规格

Antenna Specification

Electrical Properties	
Frequency	2.4-2.5GHz
Impedance	50 Ohm Nominal
V.S.W.R	2.0 Max
Gain	4.2 dBi
Radiation	Omni-directional
Polarization	Linear
Physical Properties	
Connector	1代IPEX
Cable Type	O.D.1.13mm
Cable Length	110mm
Cable Color	Black
Operating Temp.	-40 ~ +85 °C
Storage Temp / Humidity	25±5°C / <70%



Antenna Performance Test

**Agilent
E5071B**

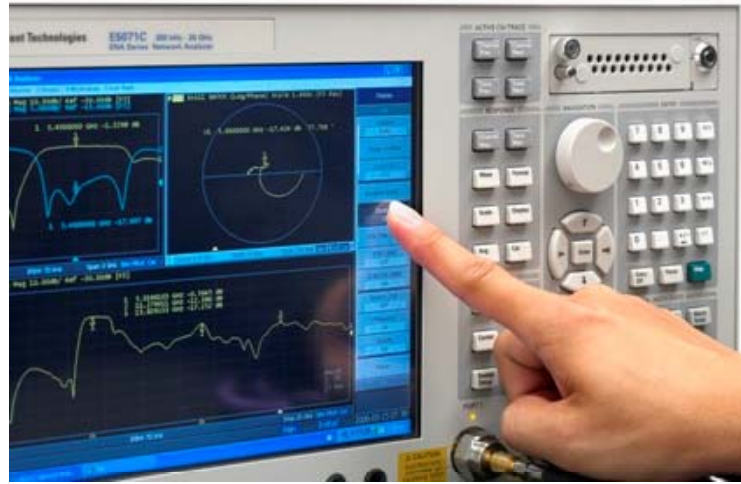

**S
Parameter
Test //
WIFI
Antenna**

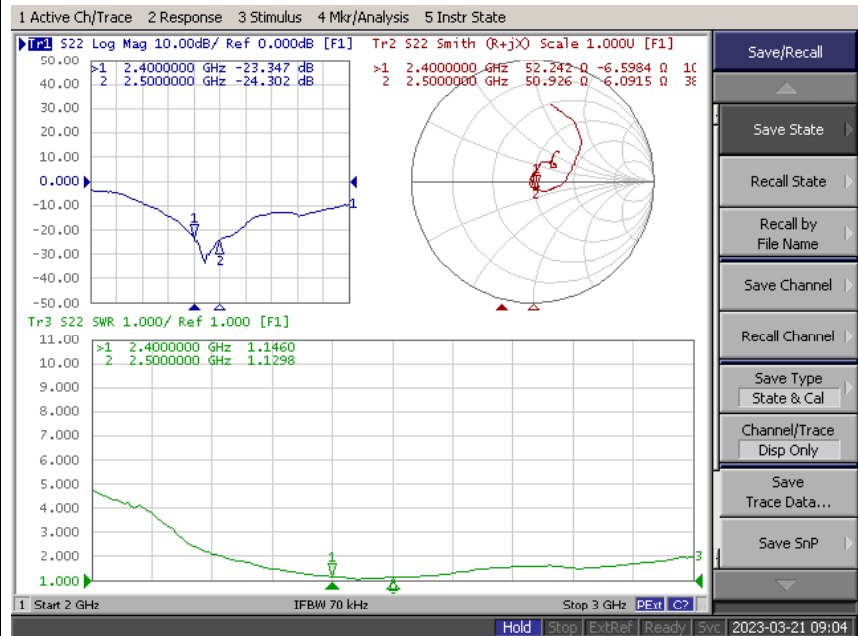



Antenna Passive Test

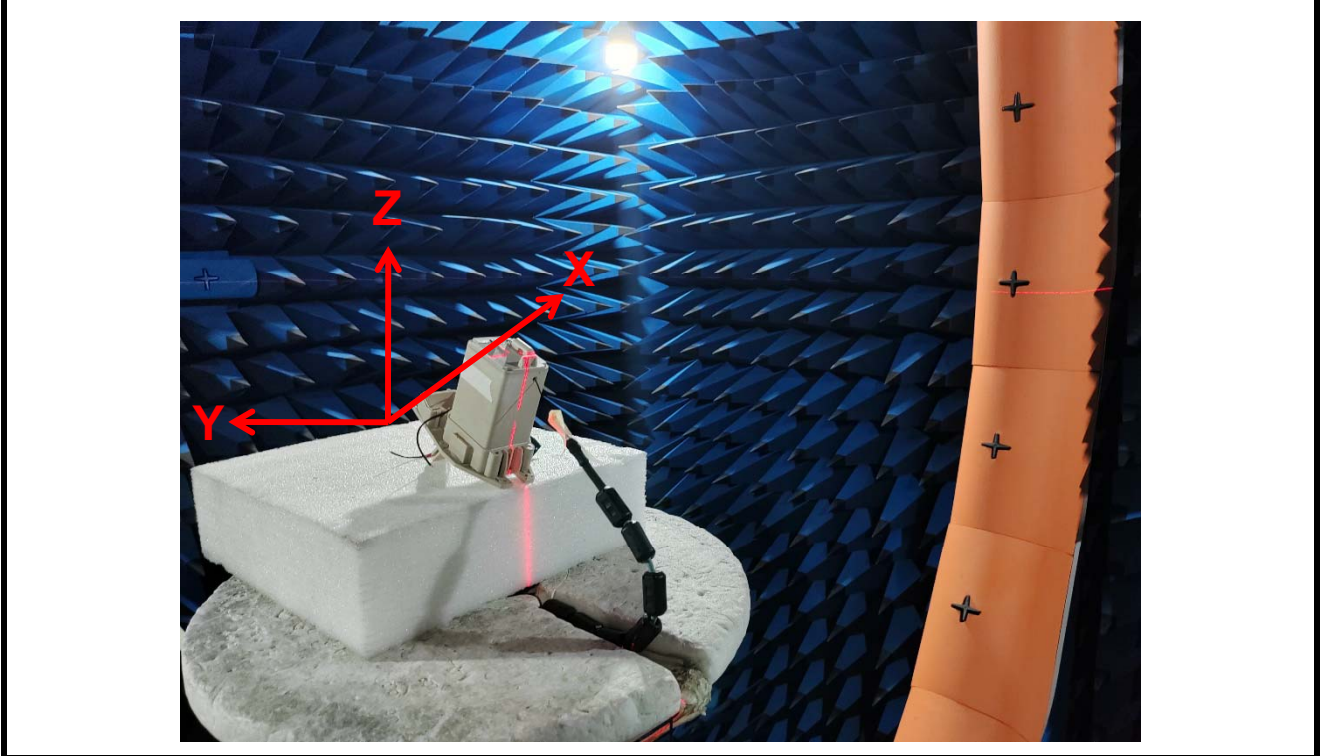
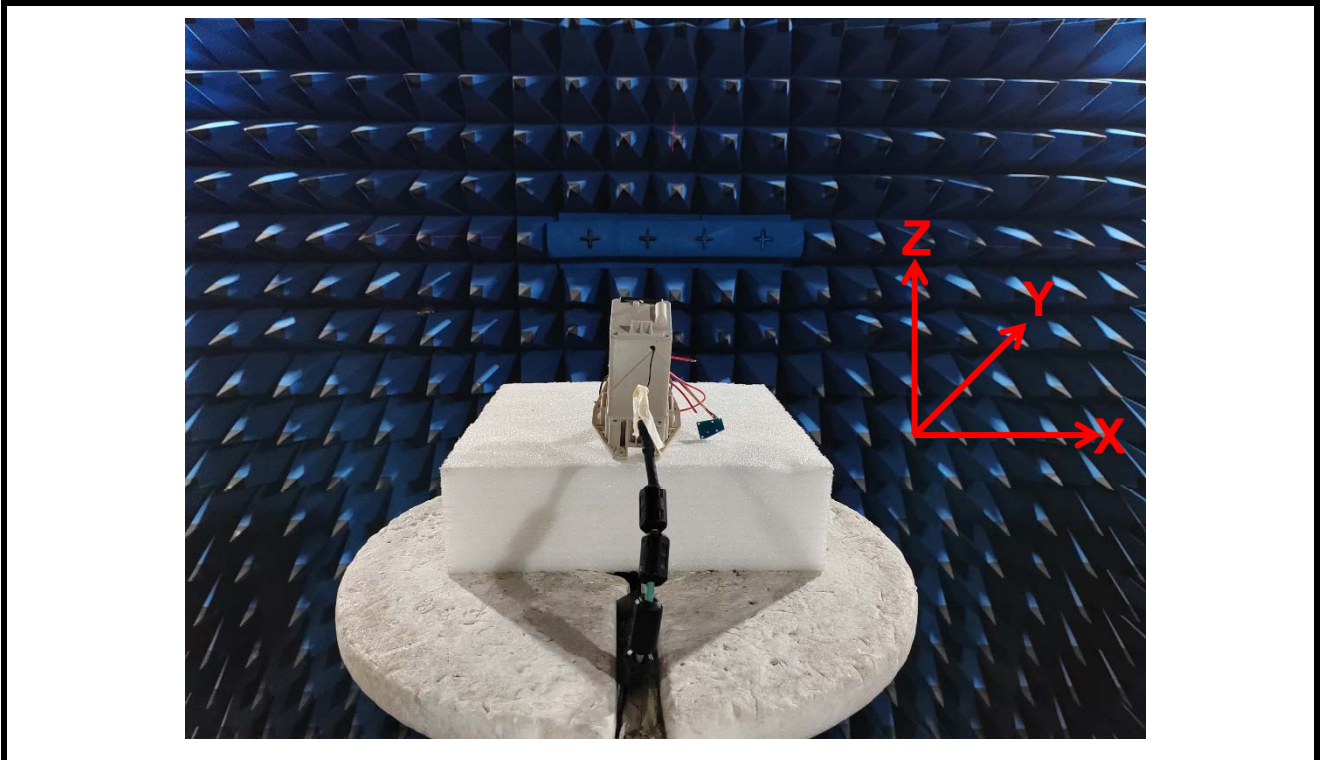



Passive Test For WIFI Antenna(2.4G)

Freq (MHz)	Effi (%)	Effi (dB)	Gain (dBi)
2400	59.2	-2.3	3.7
2410	59.8	-2.2	3.8
2420	59.8	-2.2	3.9
2430	60.0	-2.2	4.2
2440	59.6	-2.3	4.2
2450	60.8	-2.2	4.1
2460	58.5	-2.3	3.9
2470	59.3	-2.3	3.8
2480	57.3	-2.4	3.7
2490	57.7	-2.4	3.7
2500	55.6	-2.6	3.6



Radiation Pattern For WIFI Antenna(2450MHz)

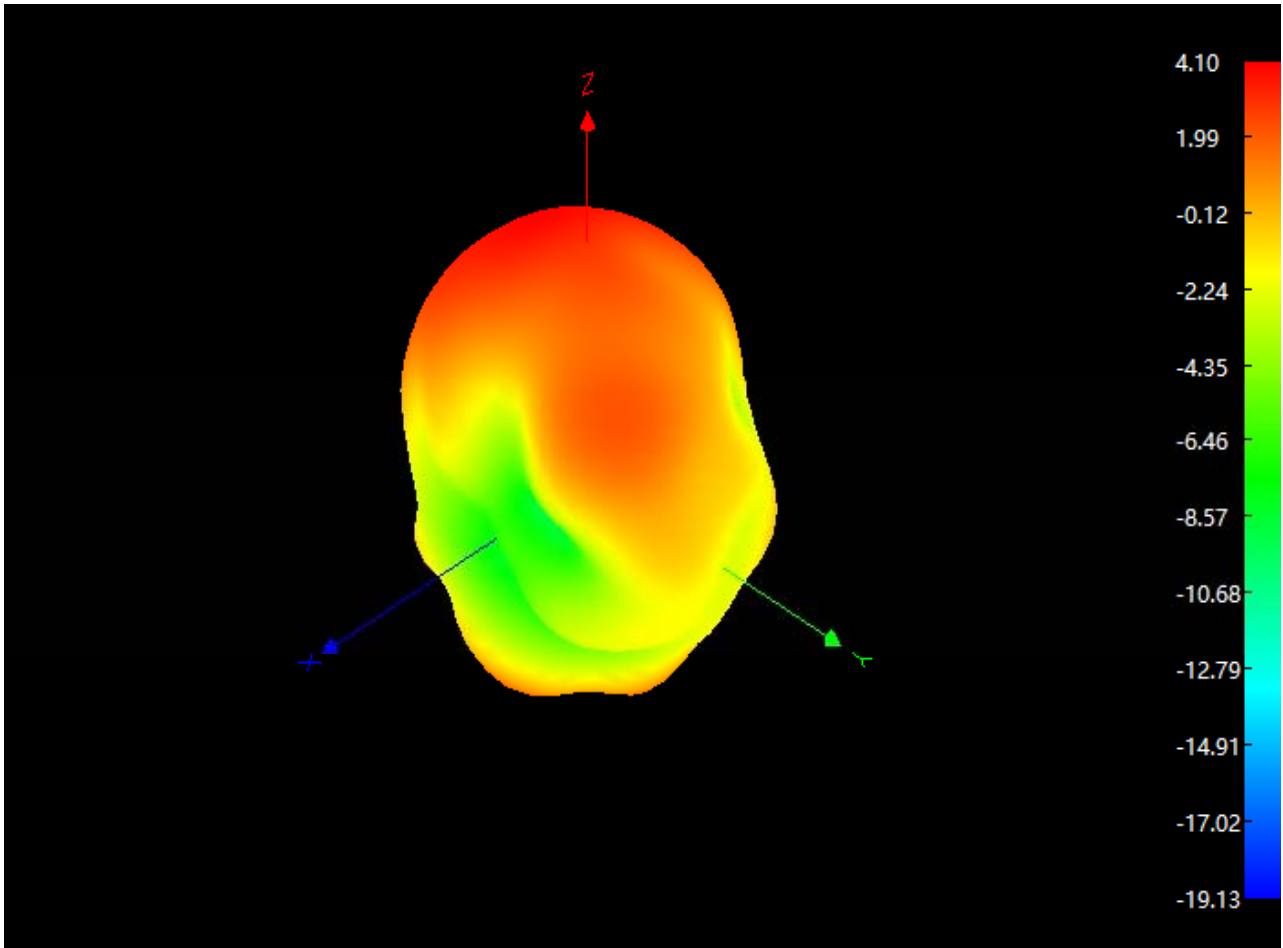



Device

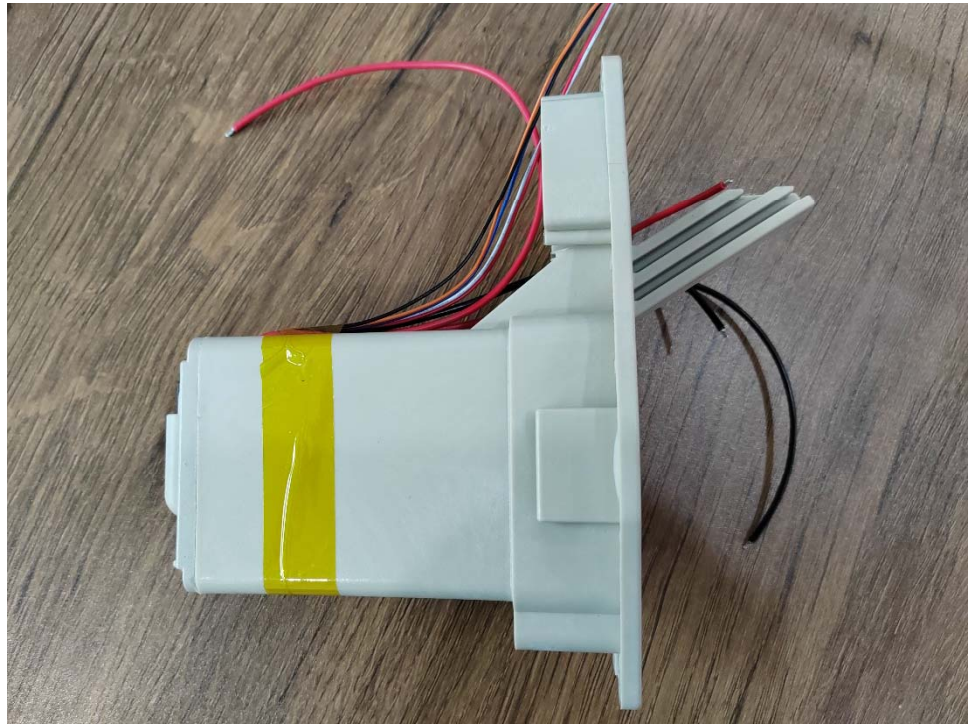

*WIFI
Antenna*



