



TESTING LABORATORY
CERTIFICATE#4323.01



FCC SAR EVALUATION REPORT

For

Turnils North America

1750 Satellite Blvd, Suite 100, Buford, Georgia, 30518 United States

FCC ID: 2AU29AMPRFWIFIUSB

Report Type: Original Report	Product Type: AMP Bridge	
Test Engineer:	Sam Ye	<i>Sam Ye</i>
Report Number:	RSHA200302003-20A	
Report Date:	2020-04-20	
Reviewed By:	Oscar Ye EMC Manager	<i>Oscar Ye</i>
Test Laboratory:	Bay Area Compliance Laboratories Corp. (Kunshan) No.248 Chenghu Road,Kunshan,Jiangsu province,China Tel: +86-0512-86175000 Fax: +86-0512-88934268 www.baclcorp.com.cn	

Note: This test report is prepared for the customer shown above and for the device described herein. It may not be duplicated or used in part without prior written consent from Bay Area Compliance Laboratories Corp. This report is valid only with a valid digital signature. The digital signature may be available only under the Adobe software above version 7.0.

Attestation of Test Results			
EUT Information	EUT Description:	AMP Bridge	
	Tested Model:	AMP USB Bridge Wifi and RF	
	FCC ID:	2AU29AMPRFWIFIUSB	
	Serial Number:	RSHA200302003	
	Test Date:	2020-4-17	
MODE		Max. SAR Level(s) Reported(W/kg)	Limit (W/kg)
WLAN 2.4G	1g Body SAR	0.38	1.6
Applicable Standards	FCC 47 CFR part 2.1093 Radiofrequency radiation exposure evaluation: portable devices		
	RF Exposure Procedures: TCB Workshop April 2019		
	IEEE1528:2013 IEEE Recommended Practice for Determining the Peak Spatial-Average Specific Absorption Rate (SAR) in the Human Head from Wireless Communications Devices: Measurement Techniques		
	IEC 62209-2:2010 Human exposure to radio frequency fields from hand-held and body-mounted wireless communication devices-Human models, instrumentation, and procedures-Part 2: Procedure to determine the specific absorption rate (SAR) for wireless communication devices used in close proximity to the human body (frequency range of 30 MHz to 6 GHz)		
	KDB procedures KDB 447498 D01 General RF Exposure Guidance v06 KDB 865664 D01 SAR Measurement 100 MHz to 6 GHz v01r04 KDB 865664 D02 RF Exposure Reporting v01r02 KDB 447498 D02 SAR Procedures for Dongle Xmtr v02r01 KDB 248227 D01 802 11 Wi-Fi SAR v02r02		
<p>Note: This wireless device has been shown to be capable of compliance for localized specific absorption rate (SAR) for General Population/Uncontrolled Exposure limits specified in FCC 47 CFR part 2.1093 and has been tested in accordance with the measurement procedures specified in IEEE 1528-2013 and RF exposure KDB procedures.</p> <p>The results and statements contained in this report pertain only to the device(s) evaluated.</p>			

TABLE OF CONTENTS

DOCUMENT REVISION HISTORY4

EUT DESCRIPTION5

TECHNICAL SPECIFICATION 5

REFERENCE, STANDARDS, AND GUIDELINES.....6

SAR LIMITS6

FACILITIES.....7

DESCRIPTION OF TEST SYSTEM8

EQUIPMENT LIST AND CALIBRATION16

EQUIPMENTS LIST & CALIBRATION INFORMATION 16

SAR MEASUREMENT SYSTEM VERIFICATION17

LIQUID VERIFICATION 17

SYSTEM ACCURACY VERIFICATION 18

SAR SYSTEM VALIDATION DATA 19

EUT TEST STRATEGY AND METHODOLOGY20

DONGLES WITH SWIVEL OR ROTATING CONNECTORS 20

TEST DISTANCE FOR SAR EVALUATION 20

SAR EVALUATION PROCEDURE 21

CONDUCTED OUTPUT POWER MEASUREMENT22

PROVISION APPLICABLE 22

TEST PROCEDURE 22

MAXIMUM TARGET OUTPUT POWER 22

TEST RESULTS: 23

STANDALONE SAR TEST EXCLUSION CONSIDERATIONS24

ANTENNA DISTANCE TO EDGE 25

STANDALONE SAR TEST EXCLUSION CONSIDERATIONS 25

STANDALONE SAR ESTIMATION: 25

SAR TEST EXCLUSION FOR THE EUT EDGE CONSIDERATIONS RESULT 26

SAR MEASUREMENT RESULTS27

SAR TEST DATA 27

SAR MEASUREMENT VARIABILITY28

SAR SIMULTANEOUS TRANSMISSION DESCRIPTION29

SAR PLOTS.....30

APPENDIX A MEASUREMENT UNCERTAINTY31

APPENDIX B EUT TEST POSITION PHOTOS33

APPENDIX C CALIBRATION CERTIFICATES34

DOCUMENT REVISION HISTORY

Revision Number	Report Number	Description of Revision	Date of Revision
1.0	RSHA200302003-20A	Original Report	2020-04-20

EUT DESCRIPTION

This report has been prepared on behalf of *Turnils North America* and their product *AMP Bridge*, Model: *AMP USB Bridge Wifi and RF*, FCC ID: *2AU29AMPRFWIFIUSB* or the EUT (Equipment under Test) as referred to in the rest of this report.

**All measurement and test data in this report was gathered from production sample serial number: RSHA200302003 (Assigned by BACL).The EUT supplied by the applicant was received on 2020-03-02.*

Technical Specification

Device Type:	Portable
Exposure Category:	Population / Uncontrolled
Antenna Type(s):	PCB Antenna
Body-Worn Accessories:	None
Operation Mode :	WLAN; SRD
Frequency Band:	WLAN 2.4G: 2412-2462 MHz; SRD: 433.92MHz
Conducted RF Power:	WLAN 2.4G: 14.74 dBm; SRD: -18.09 dBm
Power Source:	5 VDC From USB Port
Normal Operation:	Close to Body

Duty cycle Form

Band	Mode	Duty cycle(100%)
2.4G Wi-Fi	802.11b	90
	802.11g	100
	802.11n 20MHz	100

REFERENCE, STANDARDS, AND GUIDELINES

FCC:

The Report and Order requires routine SAR evaluation prior to equipment authorization of portable transmitter devices, including portable telephones. For consumer products, the applicable limit is 1.6 mW/g as recommended by the ANSI/IEEE standard C95.1-1992 [6] for an uncontrolled environment (Paragraph 65). According to the Supplement C of OET Bulletin 65 "Evaluating Compliance with FCC Guide-lines for Human Exposure to Radio frequency Electromagnetic Fields", released on Jun 29, 2001 by the FCC, the device should be evaluated at maximum output power (radiated from the antenna) under "worst-case" conditions for normal or intended use, incorporating normal antenna operating positions, device peak performance frequencies and positions for maximum RF energy coupling.

This report describes the methodology and results of experiments performed on wireless data terminal. The objective was to determine if there is RF radiation and if radiation is found, what is the extent of radiation with respect to safety limits. SAR (Specific Absorption Rate) is the measure of RF exposure determined by the amount of RF energy absorbed by human body (or its parts) – to determine how the RF energy couples to the body or head which is a primary health concern for body worn devices. The limit below which the exposure to RF is considered safe by regulatory bodies in North America is 1.6 mW/g average over 1 gram of tissue mass.

SAR Limits

FCC Limit

EXPOSURE LIMITS	SAR (W/kg)	
	(General Population / Uncontrolled Exposure Environment)	(Occupational / Controlled Exposure Environment)
Spatial Average (averaged over the whole body)	0.08	0.4
Spatial Peak (averaged over any 1 g of tissue)	1.60	8.0
Spatial Peak (hands/wrists/feet/ankles averaged over 10 g)	4.0	20.0

Population/Uncontrolled Environments are defined as locations where there is the exposure of individual who have no knowledge or control of their exposure.

Occupational/Controlled Environments are defined as locations where there is exposure that may be incurred by people who are aware of the potential for exposure (i.e. as a result of employment or occupation).

General Population/Uncontrolled environments Spatial Peak limit 1.6W/kg (FCC) applied to the EUT.

FACILITIES

The test site used by Bay Area Compliance Laboratories Corp. (Kunshan) to collect test data is located on the No.248 Chenghu Road, Kunshan, Jiangsu province, China.

Bay Area Compliance Laboratories Corp. (Kunshan) Lab is accredited to ISO/IEC 17025 by A2LA (Lab code: 4323.01) and the FCC designation No. CN1185 under the FCC KDB 974614 D01 and CAB identifier CN0004 under the ISED requirement. The facility also complies with the radiated and AC line conducted test site criteria set forth in ANSI C63.4-2014.

DESCRIPTION OF TEST SYSTEM

These measurements were performed with the automated near-field scanning system DASY6 from Schmid & Partner Engineering AG (SPEAG) which is the Fifth generation of the system shown in the figure hereinafter:

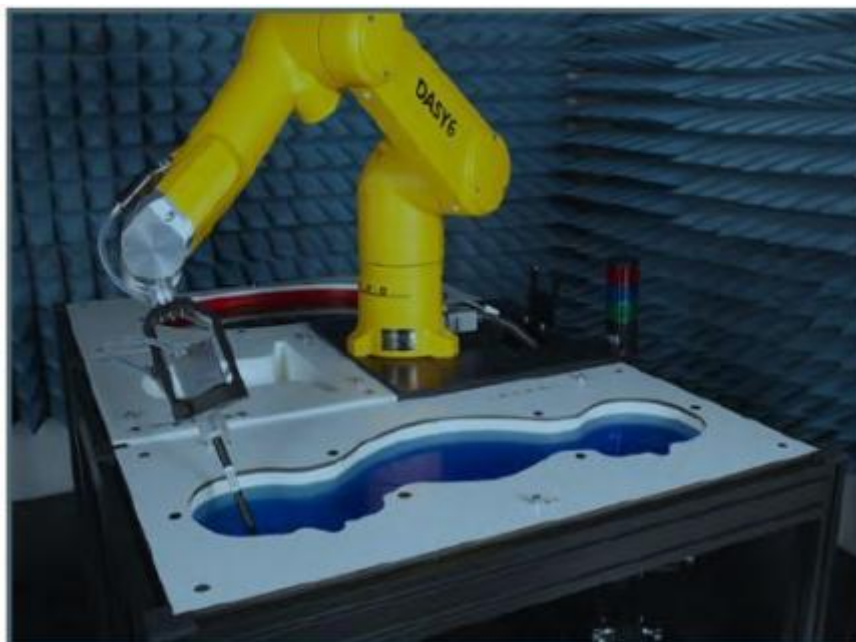

DASY6 System Description

The DASY6 system for performing compliance tests consists of the following items:

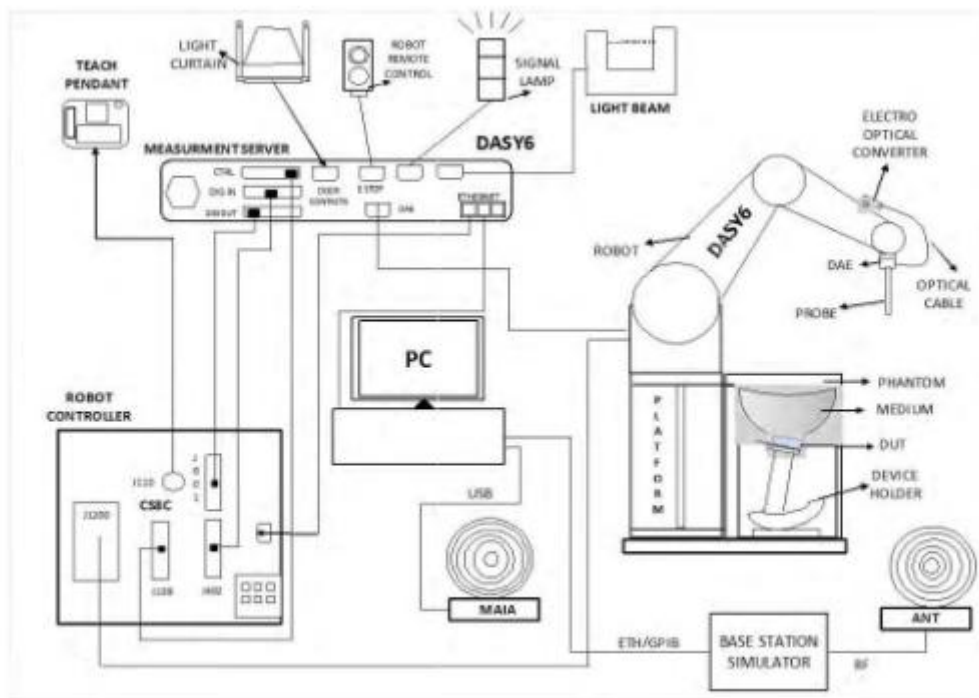

- A standard high precision 6-axis robot (Staubli TX=RX family) with controller, teach pendant and software. An arm extension for accommodating the data acquisition electronics (DAE).
- An isotropic field probe optimized and calibrated for the targeted measurement.
- A data acquisition electronics (DAE) which performs the signal application, signal multiplexing, AD-conversion, offset measurements, mechanical surface detection, collision detection, etc. The unit is battery powered with standard or rechargeable batteries. The signal is optically transmitted to the EOC.
- The Electro-optical converter (EOC) performs the conversion from optical to electrical signals for the digital communication to the DAE. To use optical surface detection, a special version of the EOC is required. The EOC signal is transmitted to the measurement server.
- The function of the measurement server is to perform the time critical tasks such as signal filtering, control of the robot operation and fast movement interrupts.
- The Light Beam used is for probe alignment. This improves the (absolute) accuracy of the probe positioning.
- A computer running Win7 professional operating system and the DASY52 software.
- Remote control and teach pendant as well as additional circuitry for robot safety such as warning lamps, etc.
- The phantom, the device holder and other accessories according to the targeted measurement.

DASY6 Measurement Server

The DASY6 measurement server is based on a PC/104 CPU board with a 400 MHz Intel ULV Celeron, 128 MB chip-disk and 128 MB RAM. The necessary circuits for communication with the DAE4 (or DAE3) electronics box, as well as the 16-bit AD converter system for optical detection and digital I/O interface are contained on the DASY6 I/O board, which is directly connected to the PC/104 bus of the CPU board.



The measurement server performs all real-time data evaluations of field measurements and surface detection, controls robot movements, and handles safety operations. The PC operating system cannot interfere with these time-critical processes. All connections are supervised by a watchdog, and disconnection of any of the cables to the measurement server will automatically disarm the robot and disable all program- controlled robot movements. Furthermore, the measurement server is equipped with an expansion port, which is reserved for future applications. Please note that this expansion port does not have a standardized pinout, and therefore only devices provided by SPEAG can be connected. Connection of devices from any other supplier could seriously damage the measurement server.

Data Acquisition Electronics

The data acquisition electronics (DAE4) consist of a highly sensitive electrometer-grade preamplifier with auto-zeroing, a channel and gain-switching multiplexer, a fast 16 bit AD-converter and a command decoder with a control logic unit. Transmission to the measurement server is accomplished through an optical downlink for data and status information, as well as an optical uplink for commands and the clock.

The mechanical probe mounting device includes two different sensor systems for frontal and sideways probe contacts. They are used for mechanical surface detection and probe collision detection.

The input impedance of both the DAE4 as well as of the DAE3 box is 200M Ω ; the inputs are symmetrical and floating. Common mode rejection is above 80 dB.

EX3DV4 E-Field Probes

Frequency	10 MHz to > 6 GHz Linearity: ± 0.2 dB (30 MHz to 6 GHz)
Directivity	± 0.3 dB in TSL (rotation around probe axis) ± 0.5 dB in TSL (rotation normal to probe axis)
Dynamic Range	10 µW/g to > 100 mW/g Linearity: ± 0.2 dB (noise: typically < 1 µW/g)
Dimensions	Overall length: 337 mm (Tip: 20 mm) Tip diameter: 2.5 mm (Body: 12 mm) Typical distance from probe tip to dipole centers: 1 mm
Application	High precision dosimetric measurements in any exposure scenario (e.g., very strong gradient fields); the only probe that enables compliance testing for frequencies up to 6 GHz with precision of better 30%.
Compatibility	DASY3, DASY4, DASY52 SAR and higher, EASY4/MRI

SAM Twin Phantom

The SAM Twin Phantom (shown in front of DASY6) is a fiberglass shell phantom with shell thickness 2 mm, except in the ear region where the thickness is increased to 6 mm. The phantom has three measurement areas: 1) Left Head, 2) Right Head, and 3) Flat Section. For larger devices, the use of the ELI-Phantom (shown behind DASY6) is required. For devices such as glasses with a wireless link, the Face Down Phantom is the most suitable (between the SAM Twin and ELI phantoms).

When the phantom is mounted inside allocated slot of the DASY6 platform, phantom reference points can be taught directly in the DASY5 V5.2 software. When the DASY6 platform is used to mount the Phantom, some of the phantom teaching points cannot be reached by the robot in DASY5 V5.2. A special tool called P1a-P2aX-Former is provided to transform two of the three points, P1 and P2, to reachable locations. To use these new teaching points, a revised phantom configuration file is required.

In addition to our standard broadband liquids, the phantom can be used with the following tissue simulating liquids:

Sugar-water-based liquids can be left permanently in the phantom. Always cover the liquid when the system is not in use to prevent changes in liquid parameters due to water evaporation.

DGBE-based liquids should be used with care. As DGBE is a softener for most plastics, the liquid should be taken out of the phantom, and the phantom should be dried when the system is not in use (desirable at least once a week).

Do not use other organic solvents without previously testing the solvent resistivity of the phantom.

Approximately 25 liters of liquid is required to fill the SAM Twin phantom.

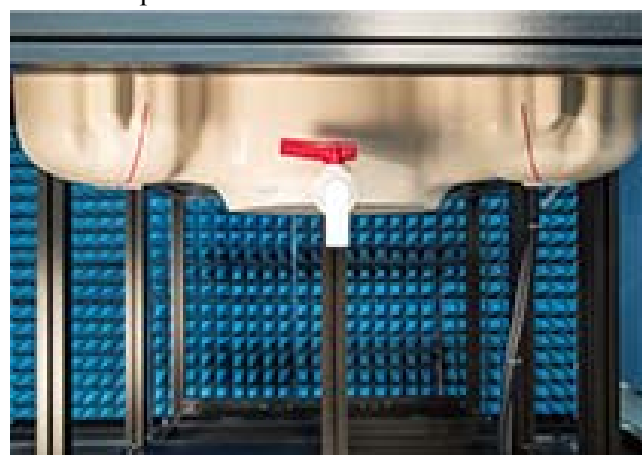

ELI Phantom

The ELI phantom is intended for compliance testing of handheld and body-mounted wireless devices in the frequency range of 30MHz to 6 GHz. ELI is fully compatible with the latest draft of the standard IEC 62209-2 and the use of all known tissue simulating liquids. ELI has been optimized for performance and can be integrated into a SPEAG standard phantom table. A cover is provided to prevent evaporation of water and changes in liquid parameters. Reference markings on the phantom allow installation of the complete setup, including all predefined phantom positions and measurement grids, by teaching three points.

The phantom can be used with the following tissue simulating liquids:

- Sugar-water-based liquids can be left permanently in the phantom. Always cover the liquid when the system is not in use to prevent changes in liquid parameters due to water evaporation.
- DGBE-based liquids should be used with care. As DGBE is a softener for most plastics, the liquid should be taken out of the phantom, and the phantom should be dried when the system is not in use (desirable at least once a week).
- Do not use other organic solvents without previously testing the solvent resistivity of the phantom.

Approximately 25 liters of liquid is required to fill the ELI phantom.

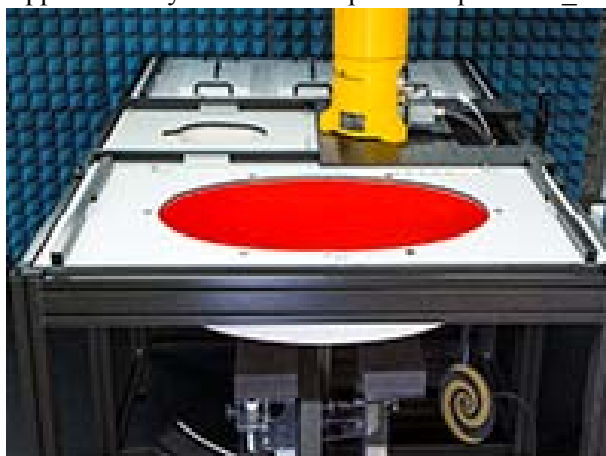

Robots

The DASY6 system uses the high-precision industrial robots TX60L, TX90XL, and RX160L from Staubli SA (France). The TX robot family - the successor of the well-known RX robot family - continues to offer the features important for DASY6 applications:

- High precision (repeatability 0.02mm)
- High reliability (industrial design)
- Low maintenance costs (virtually maintenance free due to direct drive gears; no belt drives)
- Jerk-free straight movements (brushless synchrony motors; no stepper motors)
- Low ELF interference (motor control fields shielded via the closed metallic construction shields)

The robots are controlled by the Staubli CS8c robot controllers. All information regarding the use and maintenance of the robot arm and the robot controller is provided

Area Scans

Area scans are defined prior to the measurement process being executed with a user defined variable spacing between each measurement point (integral) allowing low uncertainty measurements to be conducted. Scans defined for FCC applications utilize a 15mm 2 step integral, with 1.5mm interpolation used to locate the peak SAR area used for zoom scan assessments.

Where the system identifies multiple SAR peaks (which are within 25% of peak value) the system will provide the user with the option of assessing each peak location individually for zoom scan averaging.

Zoom Scan (Cube Scan Averaging)

The averaging zoom scan volume utilized in the DASY5 software is in the shape of a cube and the side dimension of a 1 g or 10 g mass is dependent on the density of the liquid representing the simulated tissue. A density of 1000 kg/m^3 is used to represent the head and body tissue density and not the phantom liquid density, in order to be consistent with the definition of the liquid dielectric properties, i.e. the side length of the 1g cube is 10mm, with the side length of the 10g cube is 21.5mm.

When the cube intersects with the surface of the phantom, it is oriented so that 3 vertices touch the surface of the shell or the center of a face is tangent to the surface. The face of the cube closest to the surface is modified in order to conform to the tangent surface.

The zoom scan integer steps can be user defined so as to reduce uncertainty, but normal practice for typical test applications (including FCC) utilize a physical step of $7 \times 7 \times 7$ (5mmx5mmx5mm) providing a volume of 30 mm in the X & Y & Z axis.

Tissue Dielectric Parameters for Head and Body Phantoms

The head tissue dielectric parameters recommended by the IEC 62209-1:2016

Recommended Tissue Dielectric Parameters for Head liquid

Table A.3 – Dielectric properties of the head tissue-equivalent liquid

Frequency MHz	Relative permittivity ϵ_r	Conductivity (σ) S/m
300	45,3	0,87
450	43,5	0,87
<i>750</i>	<i>41,9</i>	<i>0,89</i>
835	41,5	0,90
900	41,5	0,97
1 450	40,5	1,20
<i>1 500</i>	<i>40,4</i>	<i>1,23</i>
<i>1 640</i>	<i>40,2</i>	<i>1,31</i>
<i>1 750</i>	<i>40,1</i>	<i>1,37</i>
1 800	40,0	1,40
1 900	40,0	1,40
2 000	40,0	1,40
<i>2 100</i>	<i>39,8</i>	<i>1,49</i>
<i>2 300</i>	<i>39,5</i>	<i>1,67</i>
2 450	39,2	1,80
<i>2 600</i>	<i>39,0</i>	<i>1,96</i>
3 000	38,5	2,40
<i>3 500</i>	<i>37,9</i>	<i>2,91</i>
<i>4 000</i>	<i>37,4</i>	<i>3,43</i>
<i>4 500</i>	<i>36,8</i>	<i>3,94</i>
<i>5 000</i>	<i>36,2</i>	<i>4,45</i>
<i>5 200</i>	<i>36,0</i>	<i>4,66</i>
<i>5 400</i>	<i>35,8</i>	<i>4,86</i>
<i>5 600</i>	<i>35,5</i>	<i>5,07</i>
<i>5 800</i>	<i>35,3</i>	<i>5,27</i>
<i>6 000</i>	<i>35,1</i>	<i>5,48</i>

NOTE For convenience, permittivity and conductivity values at those frequencies which are not part of the original data provided by Drossos et al. [33] or the extension to 5 800 MHz are provided (i.e. the values shown *in italics*). These values were linearly interpolated between the values in this table that are immediately above and below these values, except the values at 6 000 MHz that were linearly extrapolated from the values at 3 000 MHz and 5 800 MHz.

Note:

- 1, Effective February 19, 2019, FCC has permitted the use of single head-tissue simulating liquid specified in IEC 62209-1 for all SAR tests.
- 2, Mix and Match of traditional FCC SAR TSLs and IEC 62209-1 TSL in a single application is not permitted TSL can be changed in a Permissive Change.
- 3, If SAR increases and original SAR > 1.2 W/kg, additional SAR measurements will be required IEC 62209-1 TSL is an alternative, not mandatory at this time.
- 4, If FCC parameters are used, $\pm 5\%$ tolerance. If IEC parameters, $\pm 10\%$.
- 5, In this case, IEC parameters applied.

Calibration Frequency Points for EX3DV4 E-Field Probes SN: 7557 Calibrated: 2019/10/04

Calibration Frequency Point(MHz)	Frequency Range(MHz)		Conversion Factor		
	From	To	X	Y	Z
750 Head	650	810	10.41	10.41	10.41
835 Head	810	935	10.10	10.10	10.10
1750 Head	1650	1810	8.67	8.67	8.67
1900 Head	1810	2000	8.36	8.36	8.36
2300 Head	2200	2399	7.79	7.79	7.79
2450 Head	2399	2500	7.41	7.41	7.41
2600 Head	2500	2700	7.21	7.21	7.21
5250 Head	5140	5360	5.38	5.38	5.38
5600 Head	5490	5700	4.75	4.75	4.75
5800 Head	5700	5910	4.70	4.70	4.70

EQUIPMENT LIST AND CALIBRATION

Equipments List & Calibration Information

Equipment	Model	S/N	Calibration Date	Calibration Due Date
DASY5 Test Software	DASY52 52.10.2	N/A	NCR	NCR
DASY6 Measurement Server	DASY6 6.0.31	N/A	NCR	NCR
Data Acquisition Electronics	DAE4	527	2019/06/13	2020/06/13
E-Field Probe	EX3DV4	7557	2019/10/04	2020/10/04
Mounting Device	MD4HHTV5	SD 000 H01 KA	NCR	NCR
Twin-SAM Phantom	QD 000 P41 AX	1963	NCR	NCR
Dipole, 2450MHz	D2450V2	970	2018/06/26	2021/06/26
Simulated Tissue Liquid Head	HBBL600-6000V6	180611-3	Each Time	
Network Analyzer	8753B	3625A00809	2019/12/14	2020/12/14
Dielectric Assessment Kit	DAK-3.5	SM DAK 300AB	NCR	NCR
Signal Generator	N5182B	MY53051592	2019/12/14	2020/12/14
Power Meter	E4419B	GB43312421	2019/08/05	2020/08/05
Power Amplifier	5S1G4	71377	NCR	NCR
Directional Coupler	4242-10	3307	NCR	NCR
Attenuator	3dB	5402	NCR	NCR
Attenuator	10dB	AU 3842	NCR	NCR
Signal Analyzer	FSV40	101116	2019-07-23	2020-07-22
EMI Test receiver	ESR	1316.3003K03-101746-zn	2019-07-11	2020-07-10

SAR MEASUREMENT SYSTEM VERIFICATION

Liquid Verification

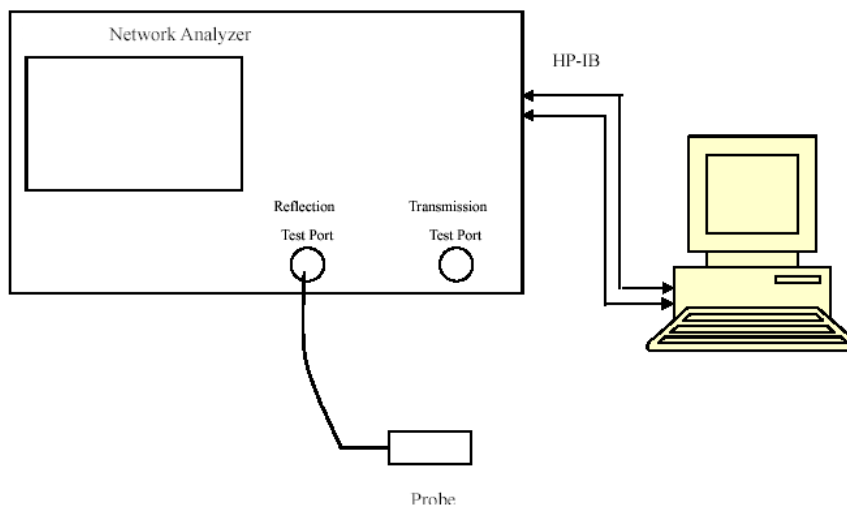

Liquid Verification Setup Block Diagram

Liquid Verification Results

Frequency (MHz)	Liquid Type	Liquid Parameter		Target Value		Delta (%)		Tolerance (%)
		ϵ_r	σ (S/m)	ϵ_r	σ (S/m)	$\Delta \epsilon_r$	$\Delta \sigma$	
2450	Head	39.892	1.845	39.200	1.800	1.77	2.50	± 5
2412	Head	39.925	1.826	39.256	1.765	1.70	3.46	± 5
2437	Head	39.901	1.838	39.219	1.788	1.74	2.80	± 5
2462	Head	39.881	1.851	39.183	1.812	1.78	2.15	± 5

*Liquid Verification was performed on 2020/04/17.

System Accuracy Verification

Prior to the assessment, the system validation kit was used to test whether the system was operating within its specifications of $\pm 10\%$. The validation results are tabulated below. And also the corresponding SAR plot is attached as well in the SAR plots files.

The spacing distances in the **System Verification Setup Block Diagram** is given by the following:

- a) $s = 15 \text{ mm} \pm 0,2 \text{ mm}$ for $300 \text{ MHz} \leq f \leq 1 \text{ 000 MHz}$;
- b) $s = 10 \text{ mm} \pm 0,2 \text{ mm}$ for $1 \text{ 000 MHz} < f \leq 3 \text{ 000 MHz}$;
- c) $s = 10 \text{ mm} \pm 0,2 \text{ mm}$ for $3 \text{ 000 MHz} < f \leq 6 \text{ 000 MHz}$.

System Verification Setup Block Diagram

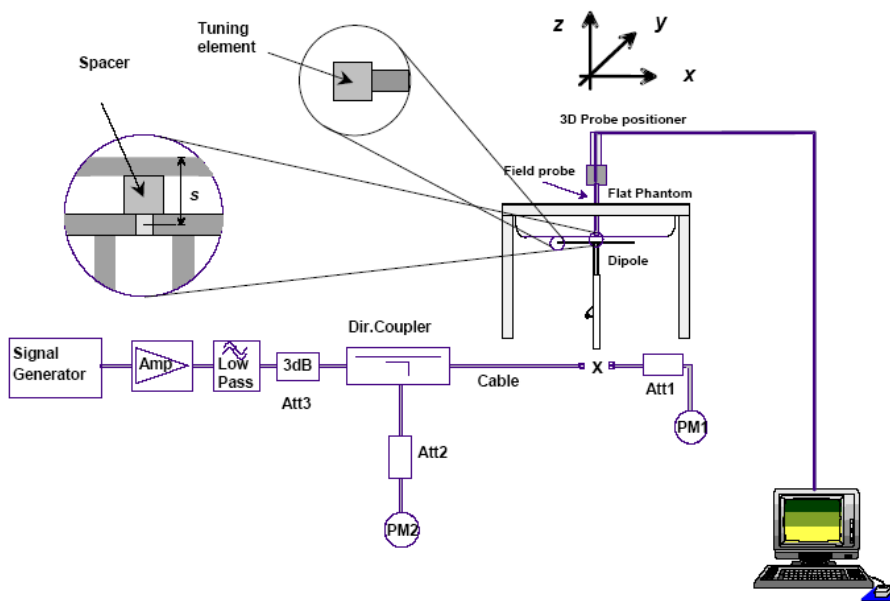

System Accuracy Check Results

Date	Frequency Band (MHz)	Liquid Type	Input Power (mW)	Measured SAR (W/kg)		Normalized to 1W (W/kg)	Target Value (W/Kg)	Delta (%)	Tolerance (%)
2020/04/17	2450	Head	250	1g	13.5	54.0	53.3	1.31	± 10

*The SAR values above are normalized to 1 Watt forward power.

SAR SYSTEM VALIDATION DATA

System Performance Check 2450MHz

DUT: Dipole 2450 MHz; Type:D2450V2; Serial:970 (2020-04-17)

Communication System: UID 0; Frequency: 2450 MHz;Duty Cycle: 1:1
 Medium parameters used: f = 2450 MHz; $\sigma = 1.845 \text{ S/m}$; $\epsilon_r = 39.892$; $\rho = 1000 \text{ kg/m}^3$

DASY5 Configuration:

- Probe: EX3DV4 - SN7557; ConvF(7.41, 7.41, 7.41); Calibrated: 10/4/2019
- Sensor-Surface: 4mm (Mechanical Surface Detection)
- Electronics: DAE4 Sn527; Calibrated: 6/13/2019
- Phantom: Twin-SAM; Type: QD 000 P41 Ax; Serial: 1963
- Measurement SW: DASY52, Version 52.10 (1); SEMCAD X Version 14.6.11 (7437)

System Performance Check 2450MHz/Area Scan (11x13x1): Measurement grid: dx=10mm, dy=10mm
 Maximum value of SAR (measured) = 17.1 W/kg

System Performance Check 2450MHz/Zoom Scan (7x7x7)/Cube 0: Measurement grid: dx=5mm, dy=5mm, dz=5mm
 Reference Value = 96.15 V/m; Power Drift = 0.12 dB
 Peak SAR (extrapolated) = 28.7 W/kg
SAR(1 g) = 13.5 W/kg; SAR(10 g) = 6.34 W/kg
 Maximum value of SAR (measured) = 18.4W/kg

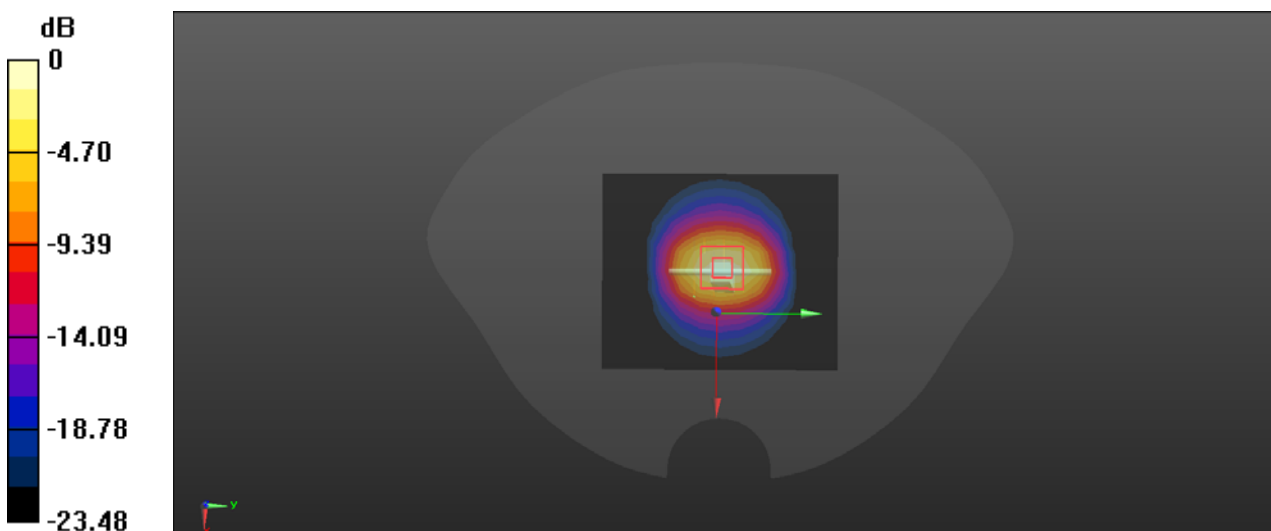

0 dB = 18.4 W/kg = 12.65 dBW/kg

EUT TEST STRATEGY AND METHODOLOGY

DONGLES WITH SWIVEL OR ROTATING CONNECTORS

A swivel or rotating USB connector may enable the dongle to connect in different orientations to host computers. When the antenna is built-in within the housing of a dongle, a swivel or rotating connector may allow the antenna to assume different positions. The combination of these possible configurations must be considered to determine the SAR test requirements. When the antenna is located near the tip of a dongle, it may operate at closer proximity to users in certain connector orientations where dongle tip testing may be required.

The 5 mm test separation distance used for testing simple dongles has been established based on the overall host platform (laptop/notebook/netbook) and device variations, and varying user operating configurations and exposure conditions expected for a peripheral device. The same test distance should generally apply to dongles with swivel or rotating connectors. The procedures described for simple dongles should be used to position the four surfaces of the dongle at 5 mm from the phantom to evaluate SAR. At least one of the horizontal and one of the vertical positions should be tested using an applicable host computer. If the antenna is within 1 cm from the tip of the dongle (the end without the USB connector), the tip of the dongle.

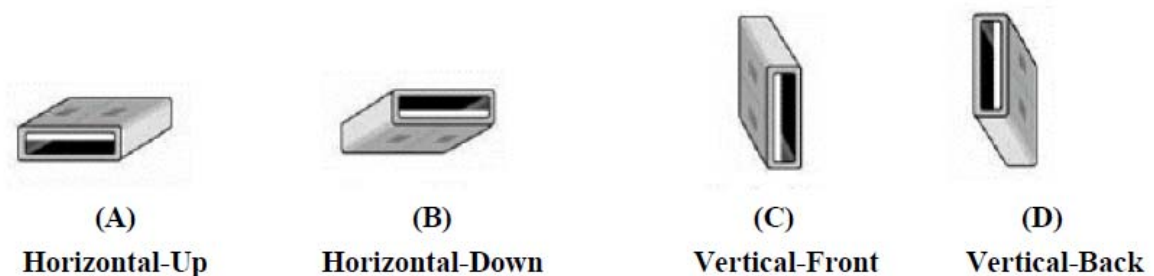

Figure 1 – USB Connector Orientations Implemented on Laptop Computers

Test Distance for SAR Evaluation

In this case the EUT(Equipment Under Test) is set 5mm away from the phantom, the test distance is 5mm.

SAR Evaluation Procedure

The evaluation was performed with the following procedure:

Step 1: Measurement of the SAR value at a fixed location above the ear point or central position was used as a reference value for assessing the power drop. The SAR at this point is measured at the start of the test and then again at the end of the testing.

Step 2: The SAR distribution at the exposed side of the head was measured at a distance of 4 mm from the inner surface of the shell. The area covered the entire dimension of the head or radiating structures of the EUT, the horizontal grid spacing was 15 mm x 15 mm, and the SAR distribution was determined by integrated grid of 1.5mm x 1.5mm. Based on these data, the area of the maximum absorption was determined by spline interpolation. The first Area Scan covers the entire dimension of the EUT to ensure that the hotspot was correctly identified.

Step 3: Around this point, a volume of 30 mm x 30 mm x 30 mm was assessed by measuring 7x 7 x 7 points. On the basis of this data set, the spatial peak SAR value was evaluated under the following procedure:

- 1) The data at the surface were extrapolated, since the center of the dipoles is 1.2 mm away from the tip of the probe and the distance between the surface and the lowest measuring point is 1.3 mm. The extrapolation was based on a least square algorithm. A polynomial of the fourth order was calculated through the points in z-axes. This polynomial was then used to evaluate the points between the surface and the probe tip.

- 2) The maximum interpolated value was searched with a straightforward algorithm. Around this maximum the SAR values averaged over the spatial volumes (1 g or 10 g) were computed by the 3D-Spline interpolation algorithm. The 3D-Spline is composed of three one dimensional splines with the "Not a knot"-condition (in x, y and z-directions). The volume was integrated with the trapezoidal-algorithm. One thousand points (10 x 10 x 10) were interpolated to calculate the averages.

All neighboring volumes were evaluated until no neighboring volume with a higher average value was found.

Step 4: Re-measurement of the SAR value at the same location as in Step 1. If the value changed by more than 5%, the evaluation was repeated.

CONDUCTED OUTPUT POWER MEASUREMENT

Provision Applicable

The measured peak output power should be greater and within 5% than EMI measurement.

Test Procedure

The RF output of the transmitter was connected to the input of the Power Meter through Connector.

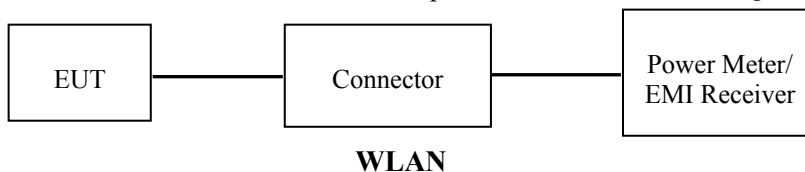

Maximum Target Output Power

Max Target Power(dBm)			
Mode/Band	Channel		
	Low	Middle	High
WLAN 2.4G(802.11b)	15.0	15.0	15.0
WLAN 2.4G(802.11g)	15.0	15.0	15.0
WLAN 2.4G(802.11n HT20)	15.0	15.0	15.0

Max Target Power(dBm)	
Mode/Band	Frequency(MHz)
	433.92
SRD	-18.0

Test Results:

WLAN 2.4G:

Mode	Channel frequency (MHz)	Data Rate	Average Output Power(dBm)
802.11b	2412	1Mbps	13.96
	2437		14.74
	2462		14.61
802.11g	2412	6Mbps	14.12
	2437		14.36
	2462		14.44
802.11n HT20	2412	MCS0	14.03
	2437		14.65
	2462		14.57

SRD:

Mode	Channel frequency (MHz)	RF Output Power(dBm)
SRD	433.92	-18.09

Note:

- (1) $ERP = 75.75\text{dB}\mu\text{V/m} - 95.2 = -19.45 \text{ dBm}$
- (2) $RF \text{ Output Power} = -19.45 \text{ dBm} - 0.79 \text{ dBi} + 2.15 = -18.09 \text{ dBm}$

Standalone SAR test exclusion considerations

Antenna Location:

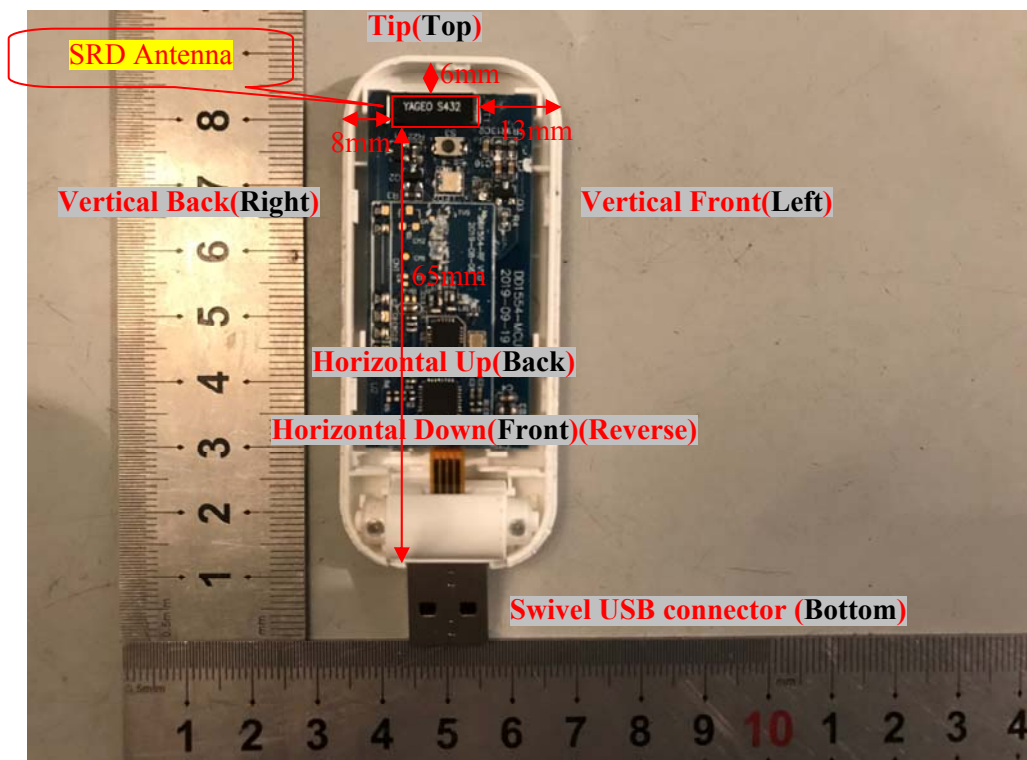
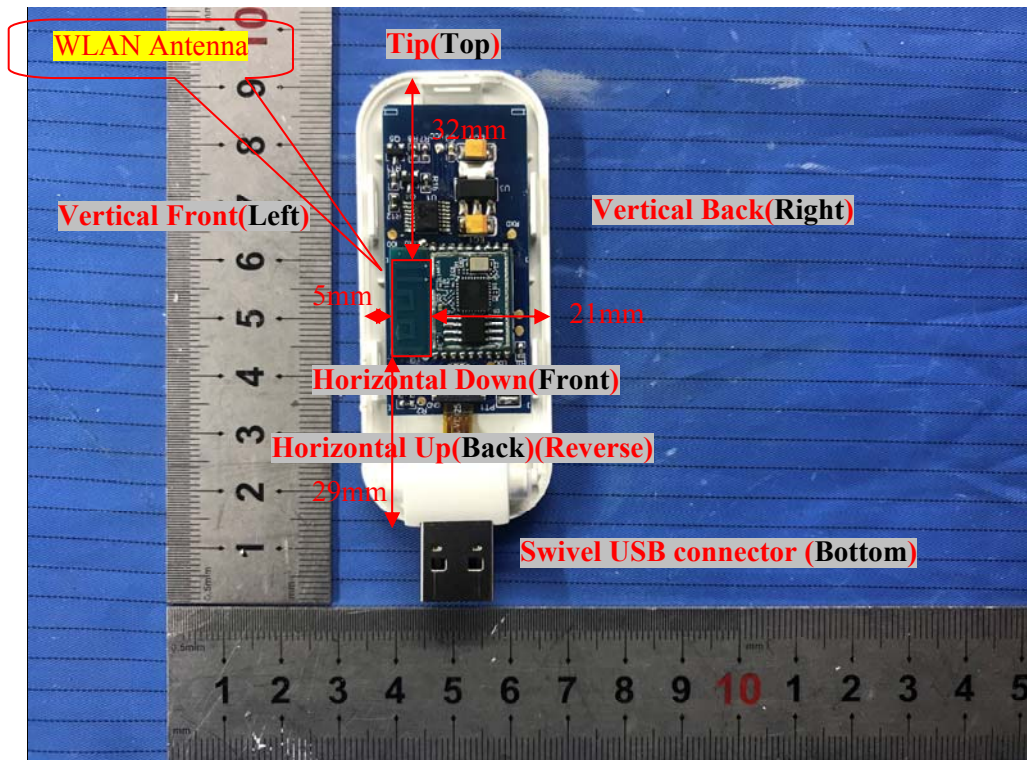

Antenna Distance To Edge

Antenna Distance To Edge(mm)						
Mode	Back	Left	Right	Front	Top	Bottom
WLAN Antenna	6	5	21	<5	32	29
SRD Antenna	<5	13	8	<5	6	65

Standalone SAR test exclusion considerations

Mode	Frequency (MHz)	Pavg (dBm)	Pavg (mW)	Distance (mm)	Calculated value	Threshold (1-g)	SAR Test Exclusion
WLAN 2.4G	2462	15.0	31.62	0	10.24	3	NO
SRD	433.92	-18.0	0.02	0	0.002	3	YES

Mode	Frequency (MHz)	Pavg (dBm)	Pavg (mW)	Test Exclusion Distance(mm)
WLAN 2.4G	2462	15.0	31.62	17

NOTE:

The 1-g and 10-g SAR test exclusion thresholds for 100 MHz to 6 GHz at test separation distances ≤ 50 mm are determined by:

$$[(\text{max. power of channel, including tune-up tolerance, mW}) / (\text{min. test separation distance, mm})] \cdot [\sqrt{f(\text{GHz})}] \leq 3.0 \text{ for 1-g SAR and } \leq 7.5 \text{ for 10-g extremity SAR, where}$$

1. f(GHz) is the RF channel transmit frequency in GHz.
2. Power and distance are rounded to the nearest mW and mm before calculation.
3. The result is rounded to one decimal place for comparison.
4. When the minimum test separation distance is < 5 mm, a distance of 5 mm is applied to determine SAR test Exclusion.

Standalone SAR estimation:

Mode	Frequency (MHz)	Pavg (dBm)	Pavg (mW)	Distance (mm)	Estimated 1-g (W/kg)
SRD Body	433.92	-18.0	0.02	0	0

Note: The SRD based Peak power for calculation.

When standalone SAR test exclusion applies to an antenna that transmits simultaneously with other antennas, the standalone SAR must be estimated according to following to determine simultaneous transmission SAR test exclusion:

$$[(\text{max. power of channel, including tune-up tolerance, mW}) / (\text{min. test separation distance, mm})] \cdot [\sqrt{f(\text{GHz})/x}]$$

W/kg for test separation distances ≤ 50 mm;

where x = 7.5 for 1-g SAR.

When the minimum test separation distance is < 5 mm, a distance of 5 mm is applied to determine SAR test Exclusion

SAR test exclusion for the EUT edge considerations Result

Antenna Distance To Edge(mm)						
Mode	Back	Left	Right	Front	Top	Bottom
WLAN Antenna	Required	Required	Exclusion	Required	Exclusion	Exclusion
SRD Antenna	Exclusion*	Exclusion*	Exclusion*	Exclusion*	Exclusion*	Exclusion*

Note:

Required: The distance is less than **Test Exclusion Distance**, the SAR test is required.

Exclusion*: SAR test exclusion evaluation has been done above.

Exclusion: The distance is larger than **Test Exclusion Distance**, the SAR test is not required.

SAR MEASUREMENT RESULTS

This page summarizes the results of the performed dosimetric evaluation.

SAR Test Data

Environmental Conditions

Temperature:	22.1-23.7 °C
Relative Humidity:	49 %
ATM Pressure:	101.4 kPa
Test Date:	2020/04/17

Testing was performed by Sam Ye.

WLAN 2.4G:

EUT Position	Frequency (MHz)	Test Mode	Max. Meas. Power (dBm)	Max. Rated Power (dBm)	1g SAR (W/kg)				
					Scaled Factor	Meas. SAR	Duty Cycle(%)	Scaled SAR	Plot
Horizontal-Up (5mm)	2412	802.11b	/	/	/	/	/	/	/
	2437	802.11b	14.74	15.0	1.062	0.137	90	0.16	#1
	2462	802.11b	/	/	/	/	/	/	/
Horizontal-Down (5mm) Adding USB extension cable	2412	802.11b	13.96	15.0	1.271	0.268	90	0.38	#2
	2437	802.11b	14.74	15.0	1.062	0.252	90	0.30	#3
	2462	802.11b	14.61	15.0	1.094	0.256	90	0.31	#4
Vertical-Front (5mm) Adding USB extension cable	2412	802.11b	/	/	/	/	/	/	/
	2437	802.11b	14.74	15.0	1.062	0.107	90	0.13	#5
	2462	802.11b	/	/	/	/	/	/	/

Note:

1. When the 1-g SAR is ≤ 0.8 W/kg, testing for other channels are optional.
2. The EUT transmit and receive through the same antenna while testing SAR.
3. When SAR or MPE is not measured at the maximum power level allowed for production units, the results must be scaled to the maximum tune-up tolerance limit according to the power applied to the individual channels tested to determine compliance.
4. KDB 248227 D01-SAR measurement is not required for 2.4 GHz OFDM(801.11g/n) when the highest reported SAR for DSSS(802.11b) is ≤ 1.2 W/kg, and the output power for DSSS is not less than that for OFDM.
5. The length of the USB extension cable is 25 cm and does not influence the radiating characteristics and output power of the transmitter.

SAR Measurement Variability

In accordance with published RF Exposure KDB procedure 865664 D01 SAR measurement 100 MHz to 6 GHz v01. These additional measurements are repeated after the completion of all measurements requiring the same head or body tissue-equivalent medium in a frequency band. The test device should be returned to ambient conditions (normal room temperature) with the battery fully charged before it is re-mounted on the device holder for the repeated measurement(s) to minimize any unexpected variations in the repeated results

- 1) Repeated measurement is not required when the original highest measured SAR is < 0.80 W/kg; steps 2) through 4) do not apply.
- 2) When the original highest measured SAR is ≥ 0.80 W/kg, repeat that measurement once.
- 3) Perform a second repeated measurement only if the ratio of largest to smallest SAR for the original and first repeated measurements is > 1.20 or when the original or repeated measurement is ≥ 1.45 W/kg (~ 10% from the 1-g SAR limit).
- 4) Perform a third repeated measurement only if the original, first or second repeated measurement is ≥ 1.5 W/kg and the ratio of largest to smallest SAR for the original, first and second repeated measurements is > 1.20.

Note: The same procedures should be adapted for measurements according to extremity and occupational exposure limits by applying a factor of 2.5 for extremity exposure and a factor of 5 for occupational exposure to the corresponding SAR thresholds.

The Highest Measured SAR Configuration in Each Frequency Band

SAR probe calibration point	Frequency Band	Freq.(MHz)	EUT Position	Meas. SAR (W/kg)		Largest to Smallest SAR Ratio
				Original	Repeated	
/	/	/	/	/	/	/

Note:

1. Repeated measurement is not required since the original highest measured SAR is < 0.80 W/kg.
2. The measured SAR results **do not** have to be scaled to the maximum tune-up tolerance to determine if repeated measurements are required.
3. SAR measurement variability must be assessed for each frequency band, which is determined by the **SAR probe calibration point and tissue-equivalent medium** used for the device measurements.

SAR SIMULTANEOUS TRANSMISSION DESCRIPTION

Simultaneous Transmission:

Description of Simultaneous Transmit Capabilities	
Transmitter Combination	Simultaneous?
WLAN 2.4G Antenna + SRD Antenna	√

Note:

Mode(SAR1+SAR2)	Position	Reported SAR(W/kg)		ΣSAR < 1.6W/kg
		SAR1	SAR2	
WLAN 2.4GHz+SRD	Horizontal-Up	0.16	0	0.16
	Horizontal-Down	0.38	0	0.38
	Vertical-Front	0.13	0	0.13

Conclusion:

Sum of SAR: $\Sigma\text{SAR} \leq 1.6 \text{ W/kg}$ therefore simultaneous transmission SAR with Volume Scans is **not required**.

SAR Plots

Please Refer to the Attachment.

APPENDIX A MEASUREMENT UNCERTAINTY

The uncertainty budget has been determined for the measurement system and is given in the following Table.

Measurement uncertainty evaluation for IEEE1528-2013 SAR test

Source of uncertainty	Tolerance/uncertainty ± %	Probability distribution	Divisor	ci (1 g)	ci (10 g)	Standard uncertainty ± %, (1 g)	Standard uncertainty ± %, (10 g)
Measurement system							
Probe calibration	6.0	N	1	1	1	6.0	6.0
Axial Isotropy	4.7	R	√3	1	1	1.9	1.9
Hemispherical Isotropy	9.6	R	√3	0	0	3.9	3.9
Boundary effect	1.0	R	√3	1	1	0.6	0.6
Linearity	4.7	R	√3	1	1	2.7	2.7
Detection limits	1.0	R	√3	1	1	0.6	0.6
Readout electronics	0.3	N	1	1	1	0.3	0.3
Response time	0.8	R	√3	1	1	0.5	0.5
Integration time	2.6	R	√3	1	1	1.5	1.5
RF ambient conditions – noise	3.0	R	√3	1	1	1.7	1.7
RF ambient conditions–reflections	3.0	R	√3	1	1	1.7	1.7
Probe positioner mech. Restrictions	0.02	R	√3	1	1	0.0	0.0
Probe positioning with respect to phantom shell	0.4	R	√3	1	1	0.2	0.2
Post-processing	2.0	R	√3	1	1	1.2	1.2
Test sample related							
Test sample positioning	2.9	N	1	1	1	2.9	2.9
Device holder uncertainty	3.6	N	1	1	1	3.6	3.6
Drift of output power	5.0	R	√3	1	1	2.9	2.9
Phantom and set-up							
Phantom uncertainty (shape and thickness tolerances)	6.1	R	√3	1	1	2.3	2.3
Liquid conductivity target)	5.0	R	√3	0.78	0.71	2.0	1.8
Liquid conductivity meas.)	2.5	N	1	0.78	0.71	2.0	1.8
Liquid permittivity target)	5.0	R	√3	0.23	0.26	0.6	0.7
Liquid permittivity meas.)	2.5	N	1	0.23	0.26	0.6	0.7
Combined standard uncertainty		RSS				11.3	11.2
Expanded uncertainty 95 % confidence interval)						22.6	22.4

Measurement uncertainty evaluation for IEC62209-2 SAR test

Source of uncertainty	Tolerance/uncertainty ± %	Probability distribution	Divisor	ci (1 g)	ci (10 g)	Standard uncertainty ± %, (1 g)	Standard uncertainty ± %, (10 g)
Measurement system							
Probe calibration	6.55	N	1	1	1	6.55	6.55
Axial Isotropy	4.7	R	√3	1	1	1.9	1.9
Hemispherical Isotropy	9.6	R	√3	0	0	3.9	3.9
Linearity	4.7	R	√3	1	1	2.7	2.7
Modulation Response	2.4	R	√3	1	1	1.4	1.4
Detection limits	1.0	R	√3	1	1	0.6	0.6
Boundary effect	2.0	R	√3	1	1	1.2	1.2
Readout electronics	0.3	N	1	1	1	0.3	0.3
Response time	0.8	R	√3	1	1	0.5	0.5
Integration time	2.6	R	√3	1	1	1.5	1.5
RF ambient conditions – noise	3.0	R	√3	1	1	1.7	1.7
RF ambient conditions–reflections	3.0	R	√3	1	1	1.7	1.7
Probe positioner mech. Restrictions	0.04	R	√3	1	1	0.0	0.0
Probe positioning with respect to phantom shell	0.8	R	√3	1	1	0.5	0.5
Post-processing	4.0	R	√3	1	1	2.3	2.3
Test sample related							
Device holder Uncertainty	3.6	N	1	1	1	3.6	3.6
Test sample positioning	2.9	N	1	1	1	2.9	2.9
Power scaling	0	R	√3	1	1	0	0
Drift of output power	5.0	R	√3	1	1	2.9	2.9
Phantom and set-up							
Phantom uncertainty (shape and thickness tolerances)	7.6	R	√3	1	1	4.4	4.4
Algorithm for correcting SAR for deviations in permittivity and conductivity	1.9	N	1	1	0.84	1.9	1.9
Liquid conductivity (meas.)	2.5	N	1	0.78	0.71	2.0	1.8
Liquid permittivity (meas.)	2.5	N	1	0.23	0.26	0.6	0.7
Temp. unc. - Conductivity	3.4	R	√3	0.78	0.71	1.5	1.4
Temp. unc. - Permittivity	0.4	R	√3	0.23	0.26	0.1	0.1
Combined standard uncertainty		RSS				12.1	12.0
Expanded uncertainty 95 % confidence interval)						24.1	24.0

APPENDIX B EUT TEST POSITION PHOTOS

Please Refer to the Attachment.

APPENDIX C CALIBRATION CERTIFICATES

Please Refer to the Attachment.

******* END OF REPORT *******