

**INSTALLATION MANUAL**

# SMART HUB-150

12 V

**Attention**

This product may only be used within the in-lite system. If components are used in the system that do not originate from in-lite, the warranty no longer applies.

Install the in-lite system components (fixtures, transformers, mini-connectors, Easy-Locks and cable connectors) so that they can easily be replaced

Never use the in-lite low-voltage cable directly connected to 100-230V. This cable is only meant for use with the components of the in-lite 12 Volt (low-voltage) system.

## Contents

1x SMART HUB-150  
INPUT : 230 V~, 50 Hz  
OUTPUT HUB-150: 12 V~, 12.5 A max., 150 VA

*Or,*

1x SMART HUB-150  
INPUT : 120 V~, 60 Hz  
OUTPUT HUB-150: 12 V~, 12.5 A max., 150 VA

Dimensions 228 x 143 x 82 mm / 9.0 x 5.6 x 3.2 inches

2x screws  
Optional SMART MOVE (motion sensor)

**Please read the following instructions before installing. You are advised to keep these installation instructions in a safe place. Although a 12 V system is safe, we advise you to have a qualified electrician check the installation.**

## Use

The SMART HUB-150 transformer is controlled by the in-lite app, suitable for Android and iOS phones or tablets produced, for example, by Samsung and Apple. The transformer is fitted with an integrated timer and an astronomical clock. You can make use of various options whereby the lamps are activated during the hours of darkness or for a certain time period you can set yourself. You can also manually switch the lamps ON and OFF at any time.

### *Bluetooth Low Energy*

The transformer connects to the phone or tablet using Bluetooth Low Energy. BLE is a new low-energy form of Bluetooth and is more user-friendly and more secure than, for instance Wi-Fi.

### *Three power lines*

A total of 150 VA in fixtures can be connected to the SMART HUB-150. Three power cables can easily be connected to the transformer using the Easy-Connect click connectors. With one transformer you're able to create three lighting zones in your outdoor space. It's not necessary to evenly divide the maximum of 150 VA among the three lines. It's also possible to use only 1 or 2 of the 3 power lines.

## Safety

The external flexible cord of this product cannot be replaced; if the cord is damaged, the product shall be scrapped.

When the transformer is connected in a wrong way (short circuit) or it encounters an overload, the "Off-led" will blink to signal the installer. Above a certain level of overload the transformer will shut down and reset itself when the touch pad is activated manually. This procedure will loop until the connection has been done right or the load is reduced to an acceptable level.

This product has triple protection. It's based on 3 mechanisms:

1. Current monitoring by software,
2. Voltage monitoring after PTC's (3x 9A PTC),
3. Transformer temperature monitoring (thermal resettable fuse inside toroid transformer).

The software protection is based on one true-RMS current measurement and two voltage measurements. If the external load is increased, the following levels are reached for SMART HUB-150:

- Detection levels calibrated for each product at 100% of nominal load (150 VA).
- If the current exceeds 120% for a few seconds (>180VA), the "off-Led" (around the on/off-button) starts blinking slowly until the load is decreased below 120%.
- If the current exceeds 140% for a few seconds (>210VA), the relay is switched off and the "off-Led" starts blinking fast until the on/off-button is activated (reset after overload).
- If the current exceeds 200% (>300VA), the relay is switched-off immediately until the on/off-button is activated (reset after short-circuit).
- If the customer resets too many times during overload/short-circuit the 3 PTCs on the connection PCB become hot and the output voltage will become too low, which is measured by the software. The output will be disabled for 1 minute to allow cooling down.
- Finally, if all of the above protections fail the temperature sensing switch inside the transformer will break the input current if its temperature rise is too high. This mechanism resets automatically after cooling down.

The control of the relay is synchronized with the mains input, it switches on and off during the zero crossing of the current to prevent induction voltages (spikes).

If the supply voltage for the control part becomes too low (long power dips) the output will be disabled. After restoring of the mains supply the product will start again in the last known mode.

**Installation**

The SMART HUB-150 is easy to install. After mounting the transformer and downloading and installing the in-lite application (app), the system is ready for connection.

All lights can be controlled with the in-lite app on a smart phone or tablet. The app, which is suitable for an Android and iOS device, can be downloaded from the app store and installed on your device.

The in-lite app makes it possible to communicate with the transformer by a Bluetooth connection. The app automatically recognizes which lines are in use. In the app you can turn light sections (total 3) "ON" and "OFF". You can also set different scenarios based on sunset and sunrise, time of the day and/or movement detection (with accessory SMART MOVE).

It's possible to share the in-lite app with other people like family members. The Share function makes it possible to quickly link an extra device. The settings are duplicated so there's no need to set again for the linked device.

**Installation step by step**

Although the transformer is designed to withstand inclement weather, you are recommended not to place it close to a sprayer system. Place the transformer at least 50 cm above the ground and in the immediate vicinity of a 110V/230V electric socket.

**Installing the transformer (Fig. 5)****Step 1**

Open the package of the transformer. Here you will find the screws for fixing the transformer in place and the terminal lugs for the cable. Fix the transformer to a wall, panel or post using the screws supplied (Fig. 1).

**Step 2**

Split about 5-10 cm of the low-voltage cable end into 2 wires. Remove about 8 mm of insulation from both wire ends (Fig. 2).

**Step 3**

Remove the lid from the transformer so you get access to the 3 cable terminals. Each terminal represents a separate light section in your garden.

**Step 4**

Insert the copper wires into the terminal lug (Fig. 3) and fix them firmly in place by pressing the click mechanism down (Fig. 4).

**Step 5**

Put the lid back in place on the transformer to cover the cable terminals.(Fig. 5).

**Step 6**

Put the plug of the 110V/230V power cable into the electric socket. The transformer will be switched on automatically. The on-off button on the side of the transformer will light up continuously. (At any time it is possible to switch the transformer on and off by a push on the on/off button)

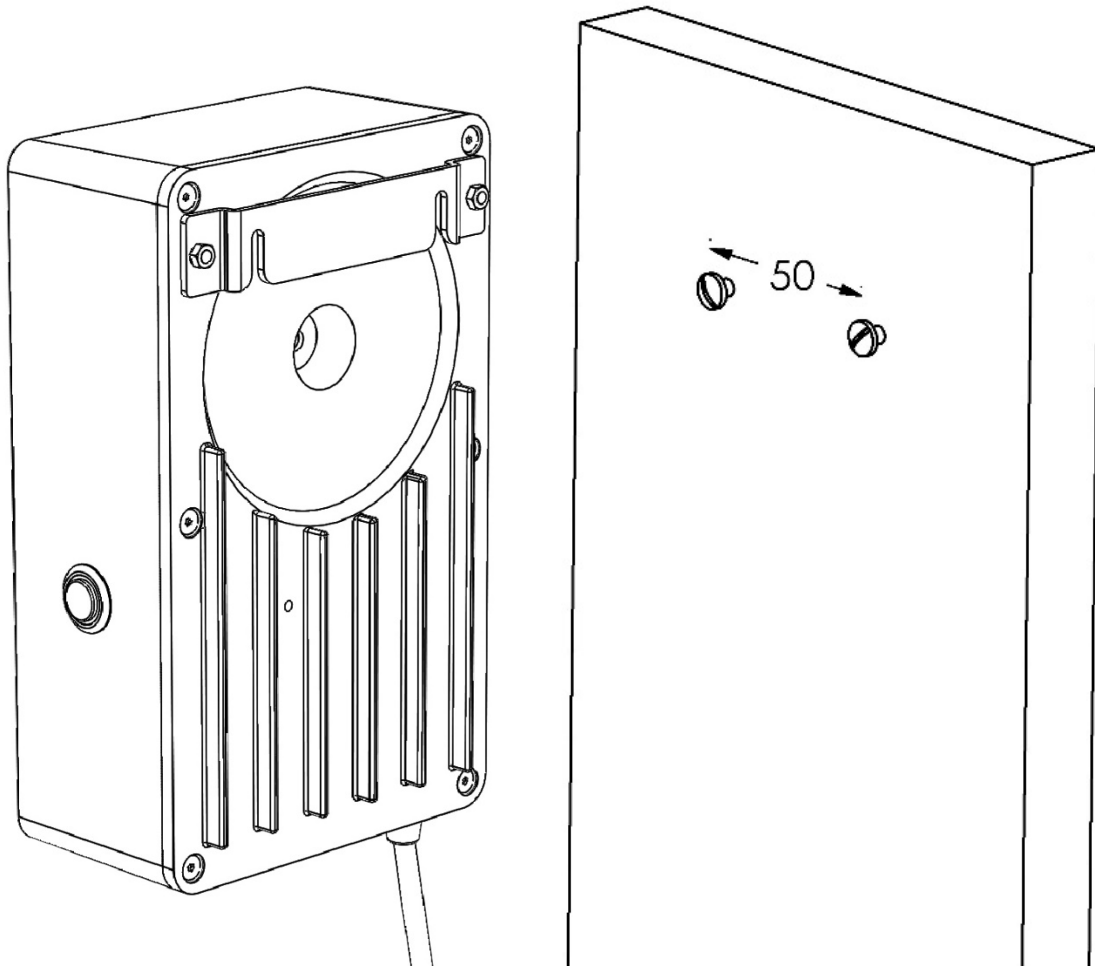

**FIG. 1**

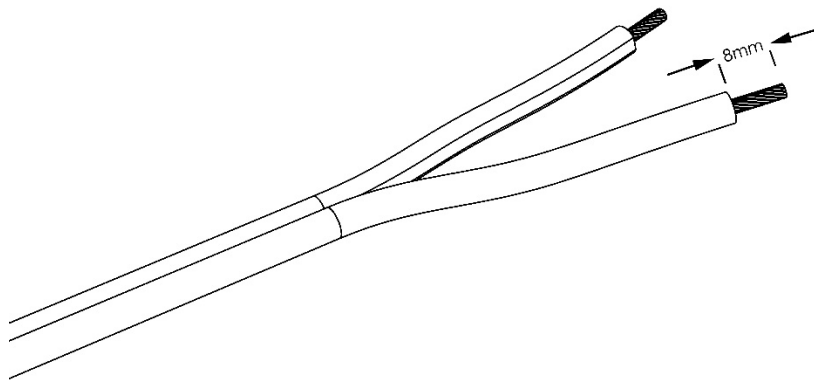

**FIG. 2**

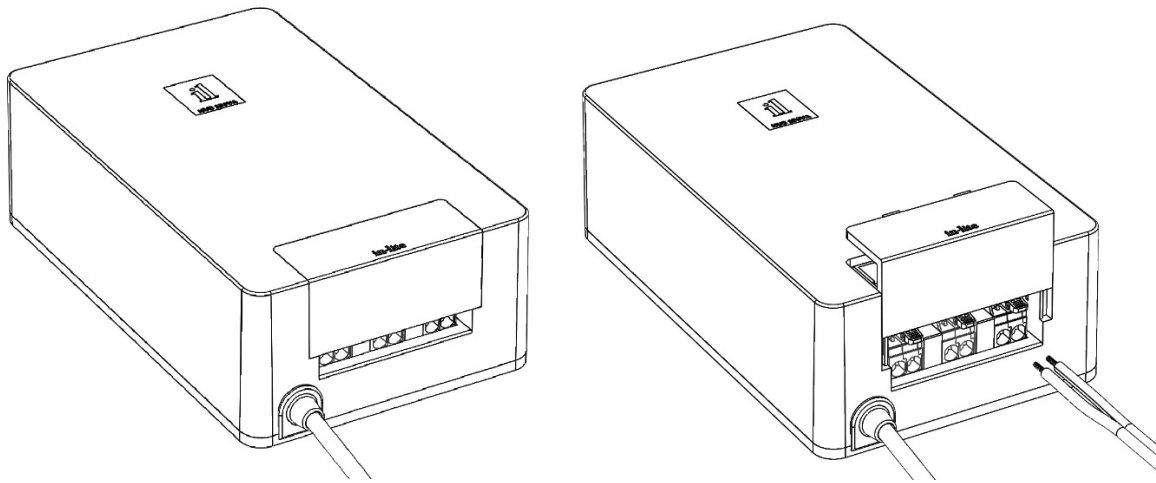

**FIG. 3**

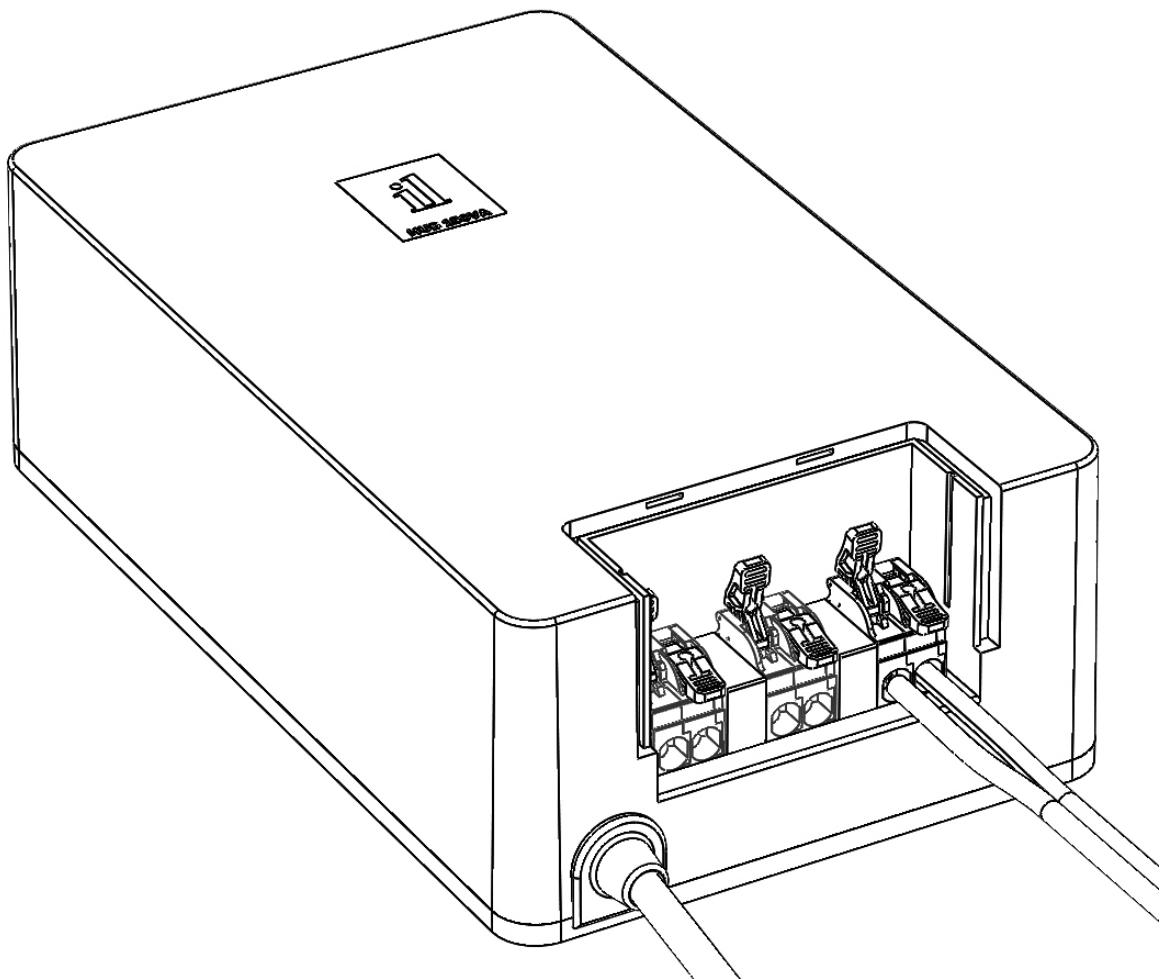

**FIG. 4**

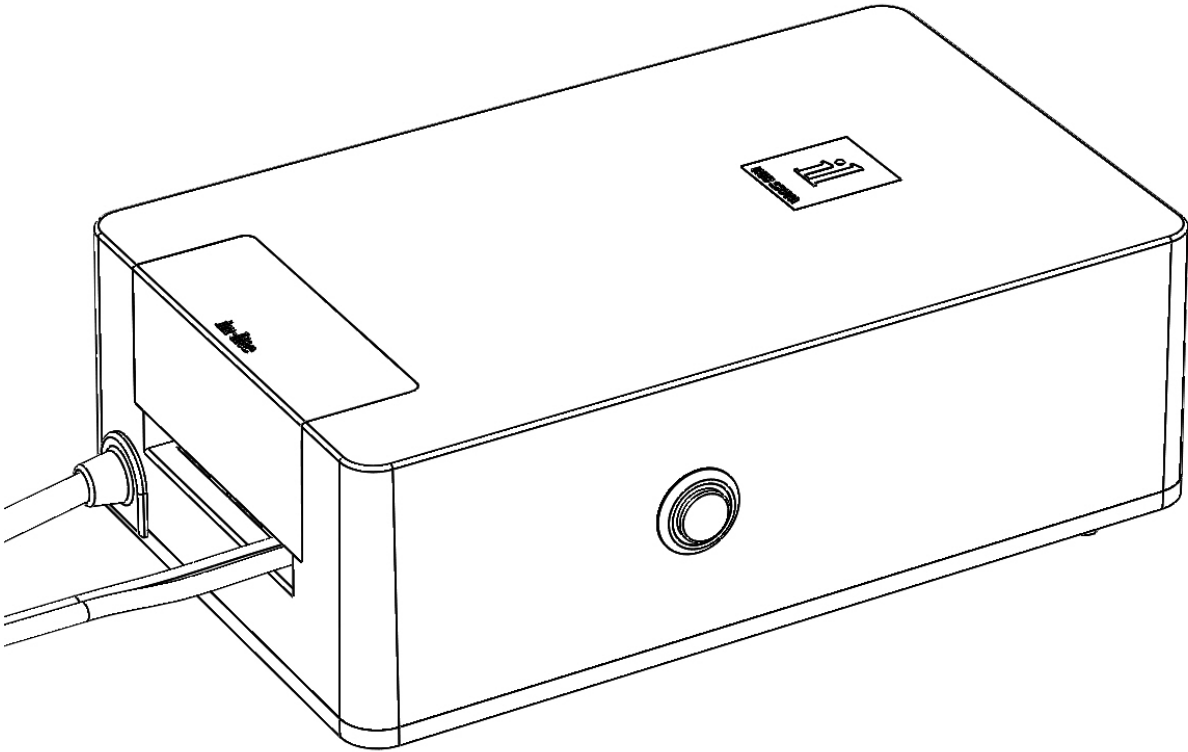

**FIG. 5**



## Installing the in-lite app

### Step 1

Open the app store on your Android or iOS device (smart phone or tablet). Search for in-lite and download the app.

### Step 2

Open the app on your device. You have two options to select; you're a new user or you already have an account. (Fig. 6)

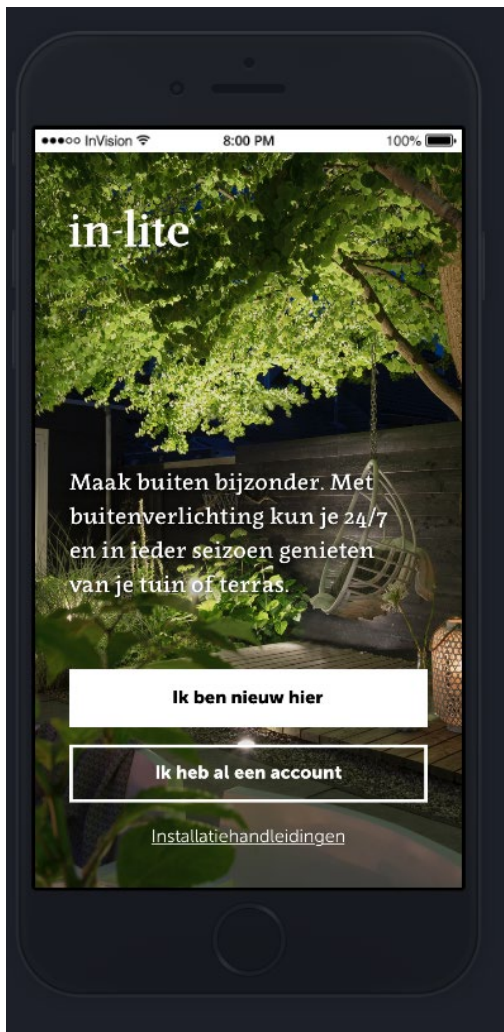

**FIG. 6**

### Step 3

Follow the instructions in the app. You'll be guided through the process of logging in or creating your account.

While creating your account you will configure the Bluetooth connection with the transformer, the set up of your outdoor space and the names of the light sections. (Fig. 7-14)

If you'd like to have more support you can select the option "installation manual" at the bottom of the screen. (Fig. 6). You'll get more information about the most important features of the app. (Fig. 15-16)

When you've created an account before you can log in with the code you've got by email. (Fig. 17)

It's also possible to skip the set-up when it has already been done by someone else and you've got a share code. You use that code to log in. (Fig. 18)

#### **Step 4**

After logging in or creating your account you can connect accessories; at this time the SMART MOVE is available. Select the option in the pull-down menu in the upper right corner of the screen. You'll be guided through the process of connecting the accessory. (Fig. 19)

#### **Step 5**

Now you can set the different light scenarios you prefer by selecting the tab/menu "routines". You're able to set up by selecting light sections and sliding the time scheduler. (Fig. 20-22)

#### **Step 6**

Via the drop-down menu in the upper right corner you can choose for several other options: changes names of garden and light sections, add gardens (transformers), add light sections, add accessories, add routines, etc.. (Fig. 23)

#### **Step 7**

Via the drop-down menu in the upper right corner you can choose to get troubleshooting information and support. (Fig. 24)

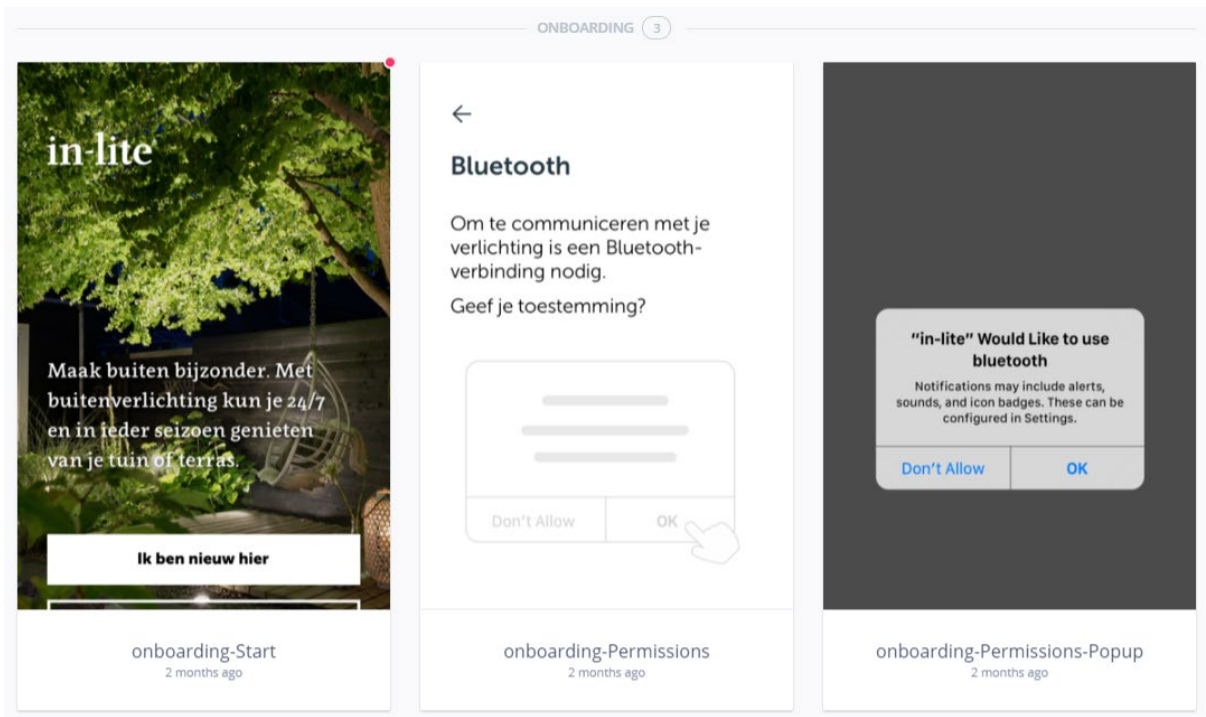

FIG. 7

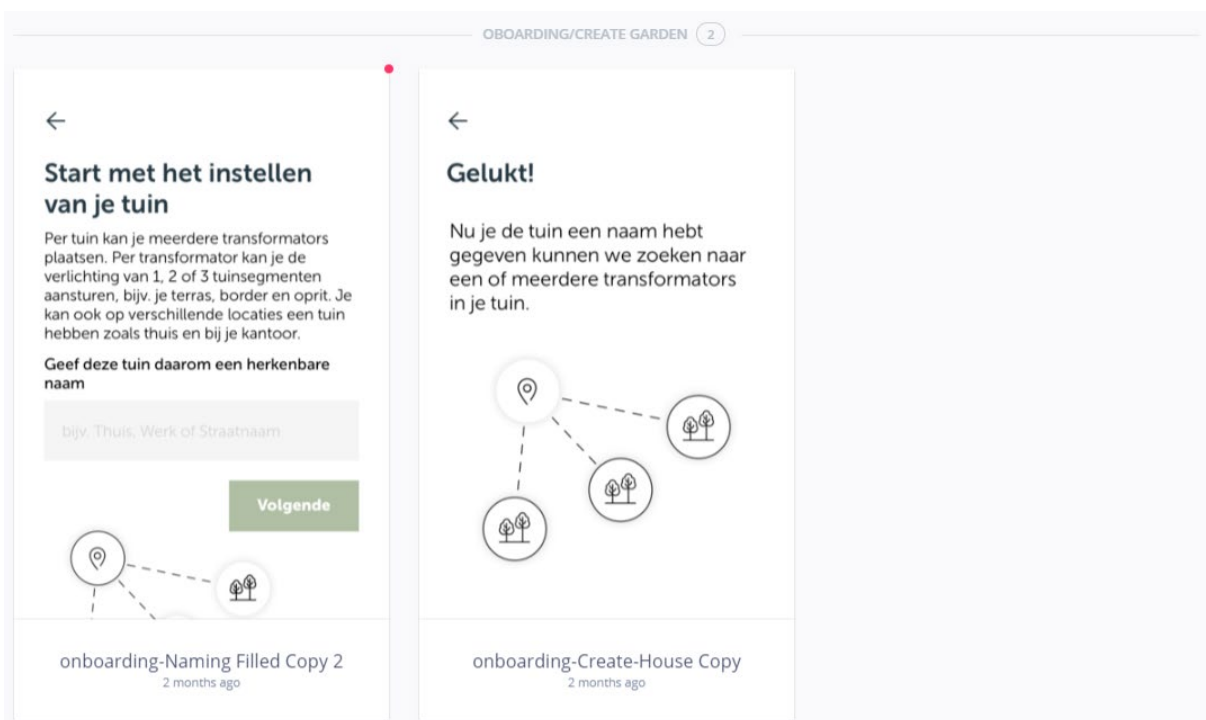

FIG. 8

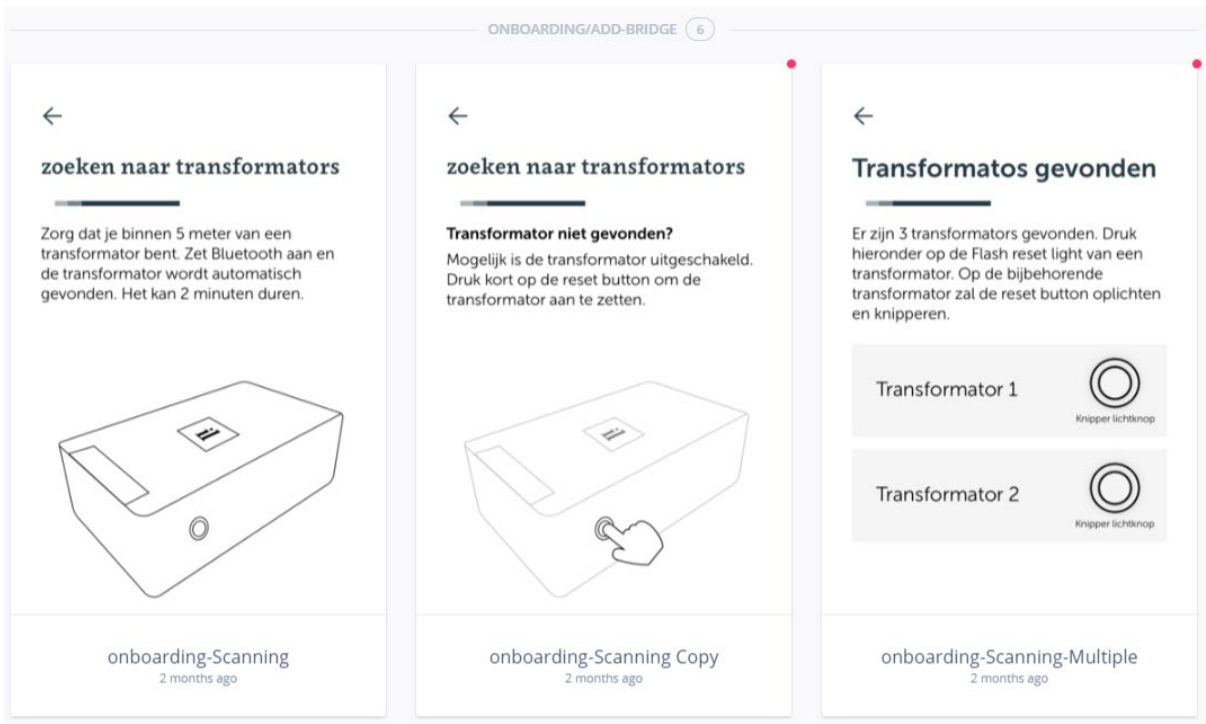

FIG. 9

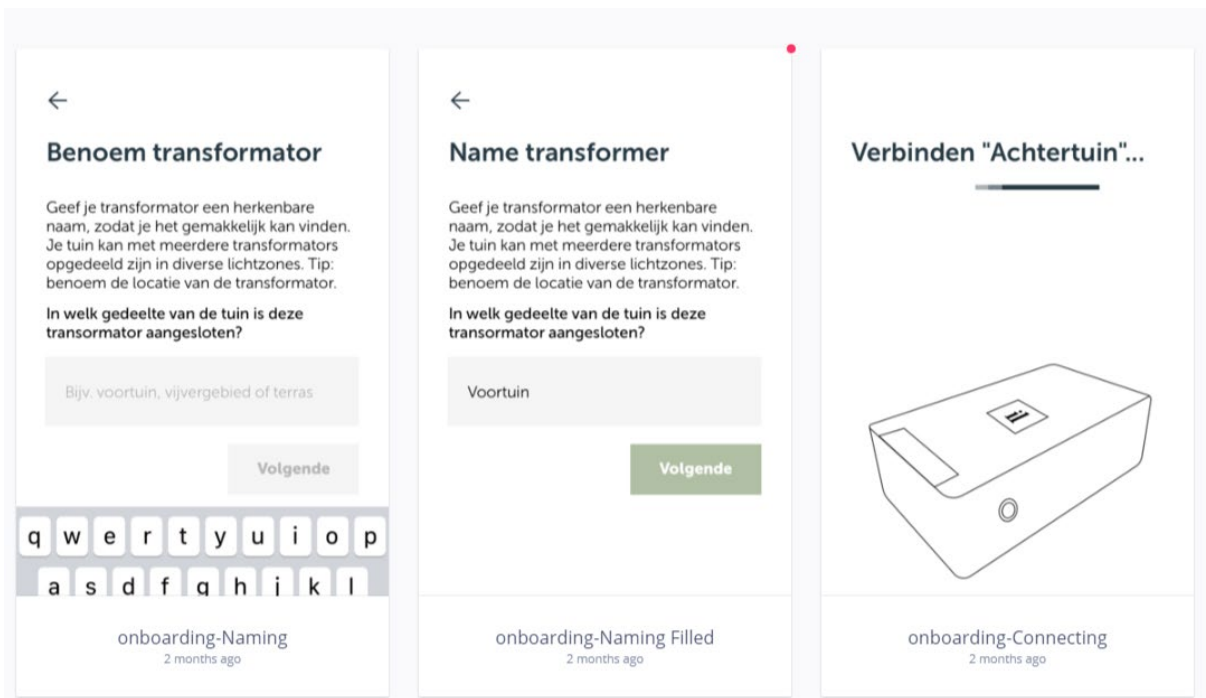

FIG. 10

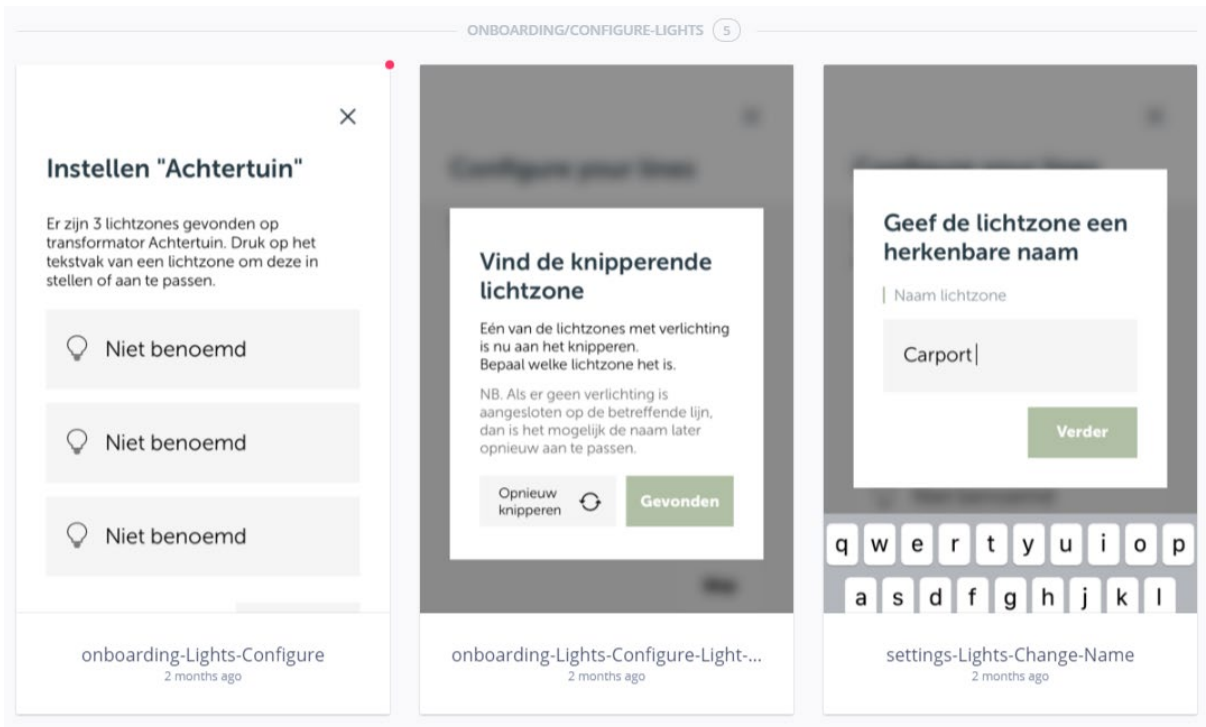

FIG. 11

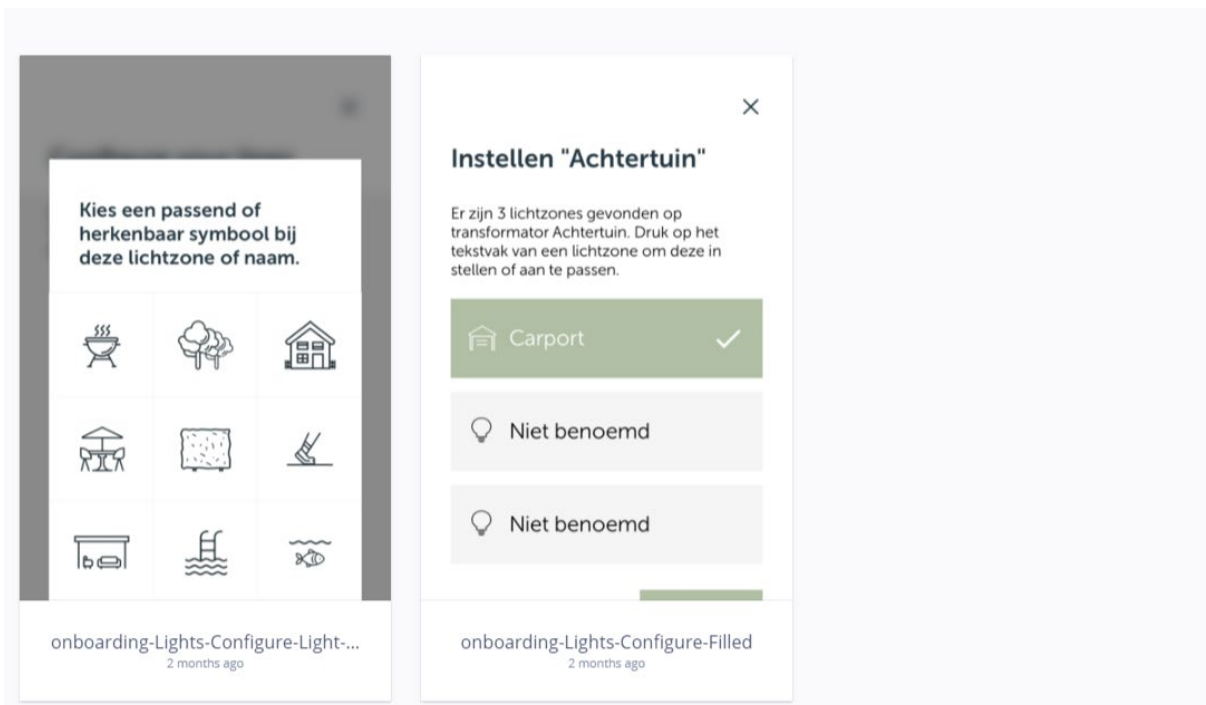

FIG. 12

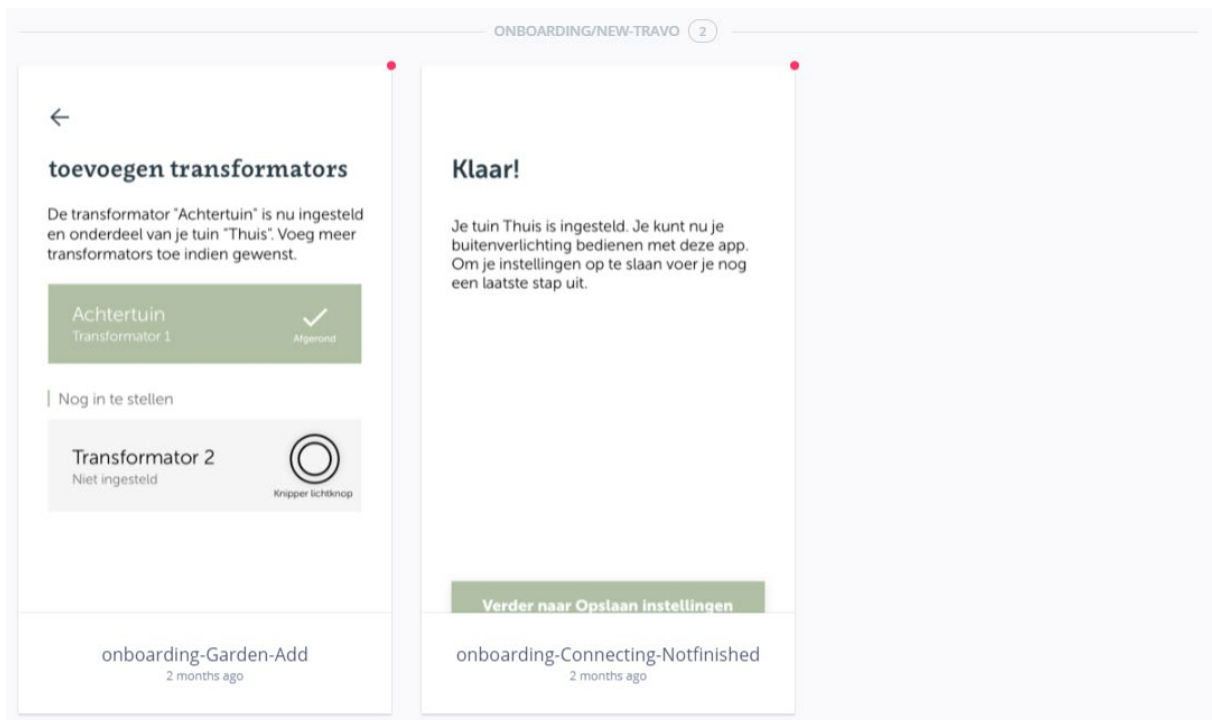

FIG. 13

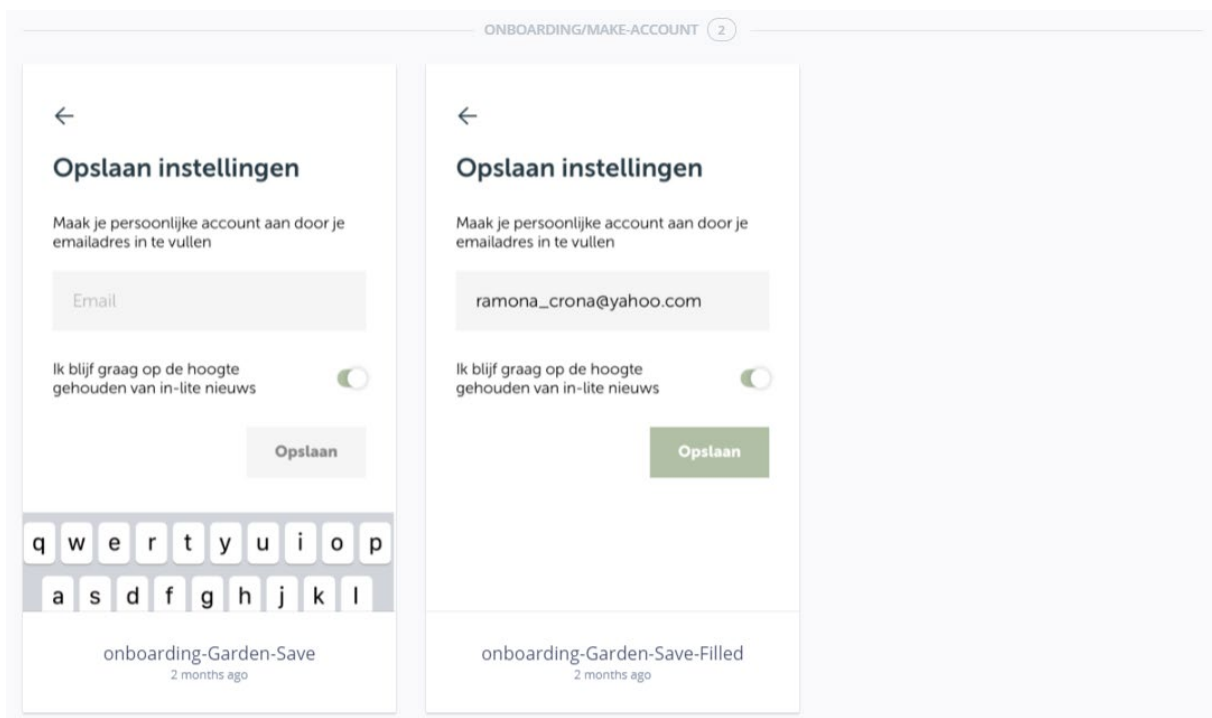

FIG. 14

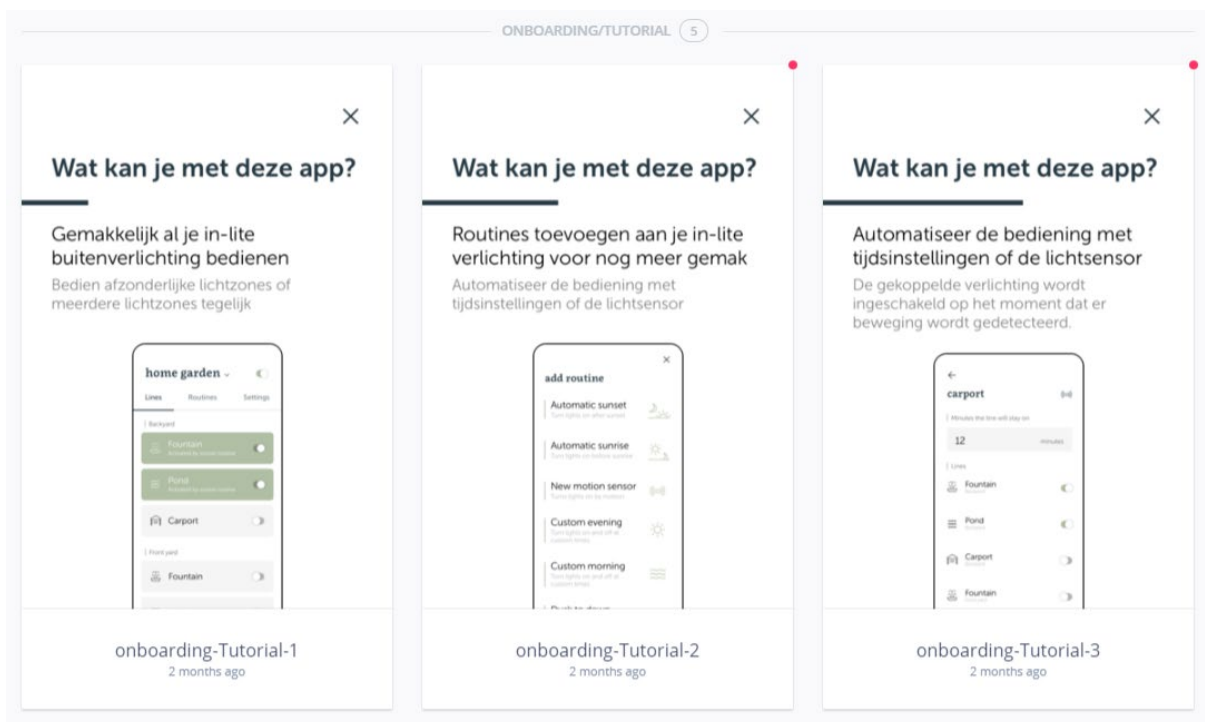

FIG. 15

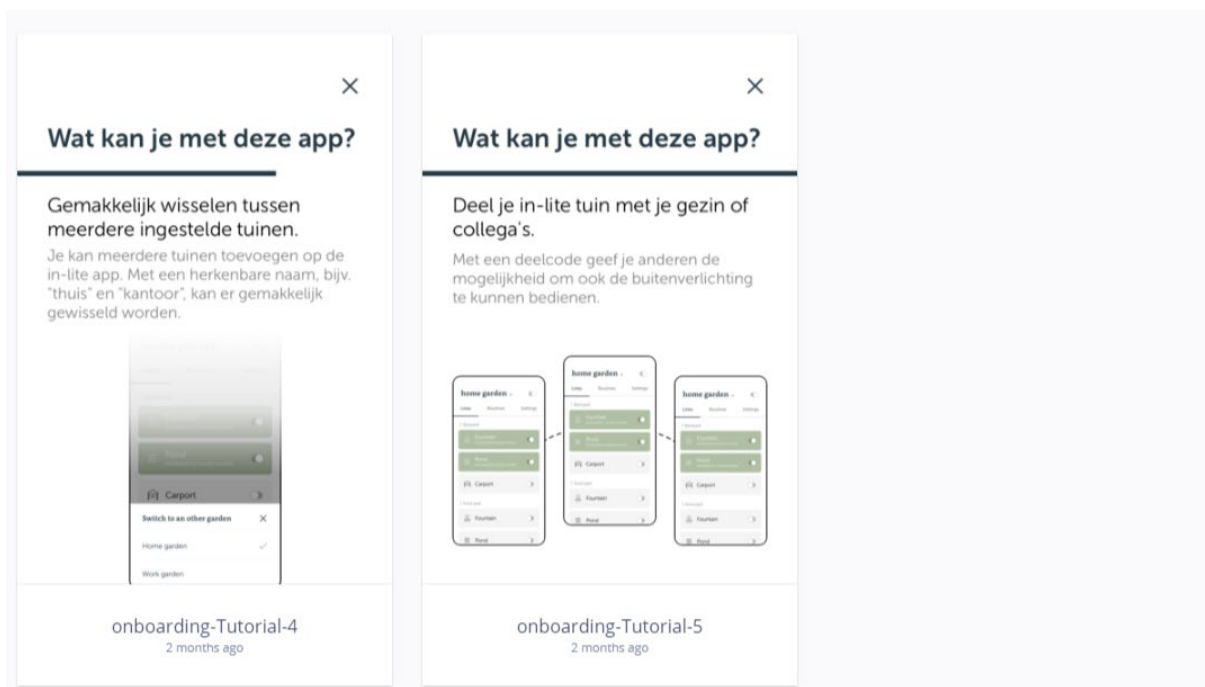

FIG. 16



FIG. 17

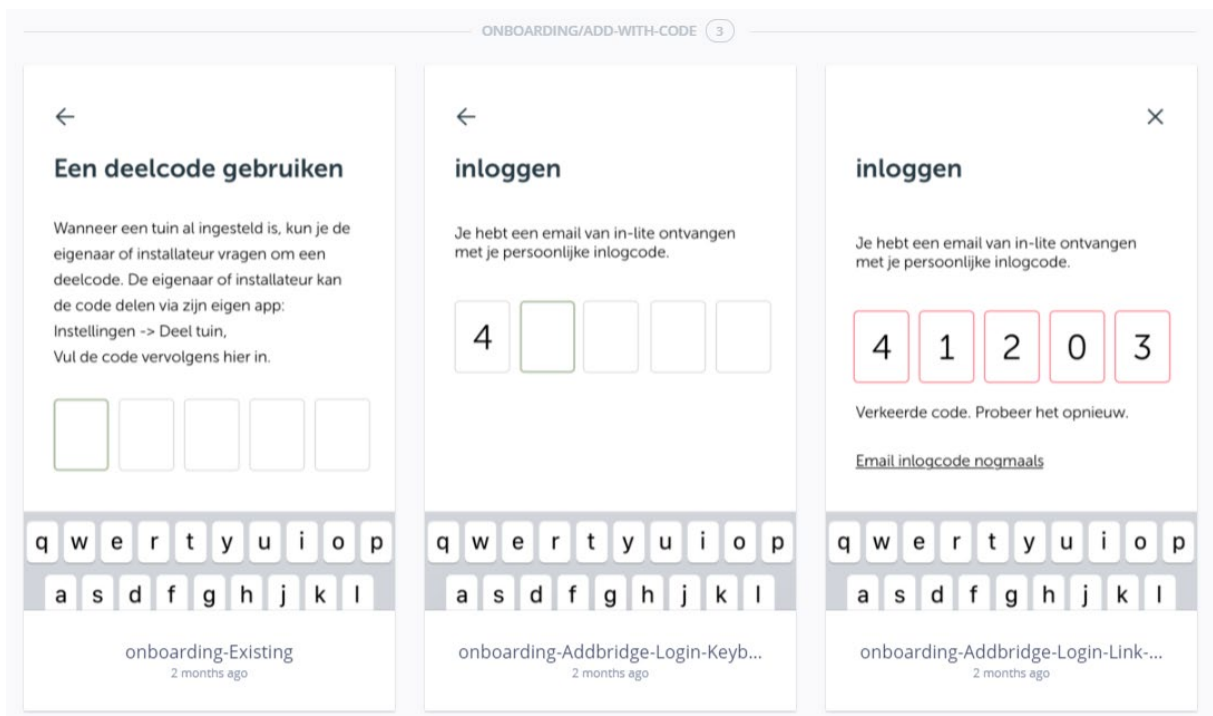

FIG. 18



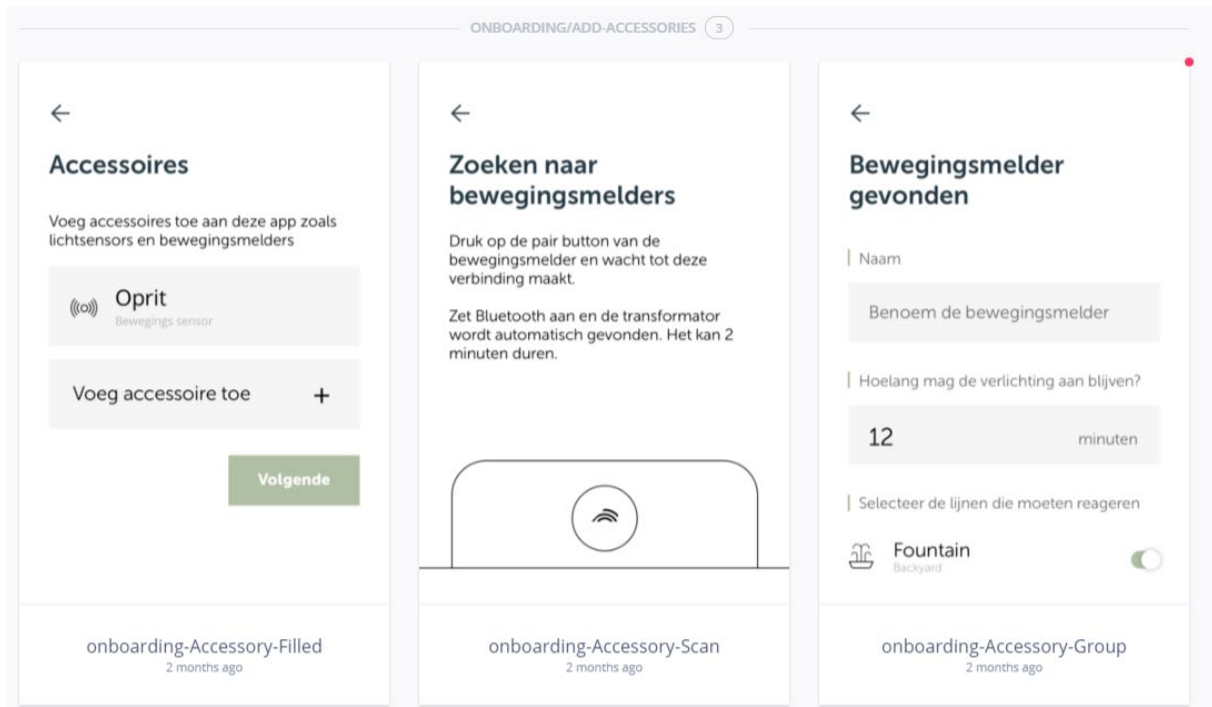

FIG. 19

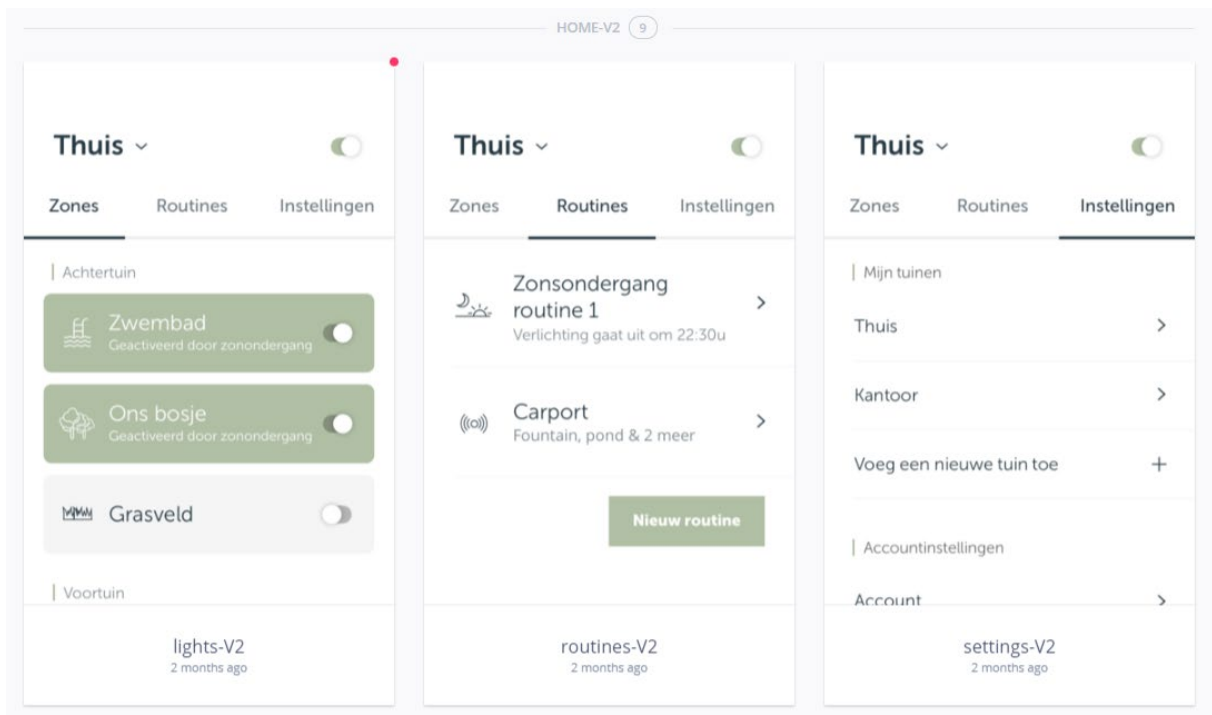

FIG. 20

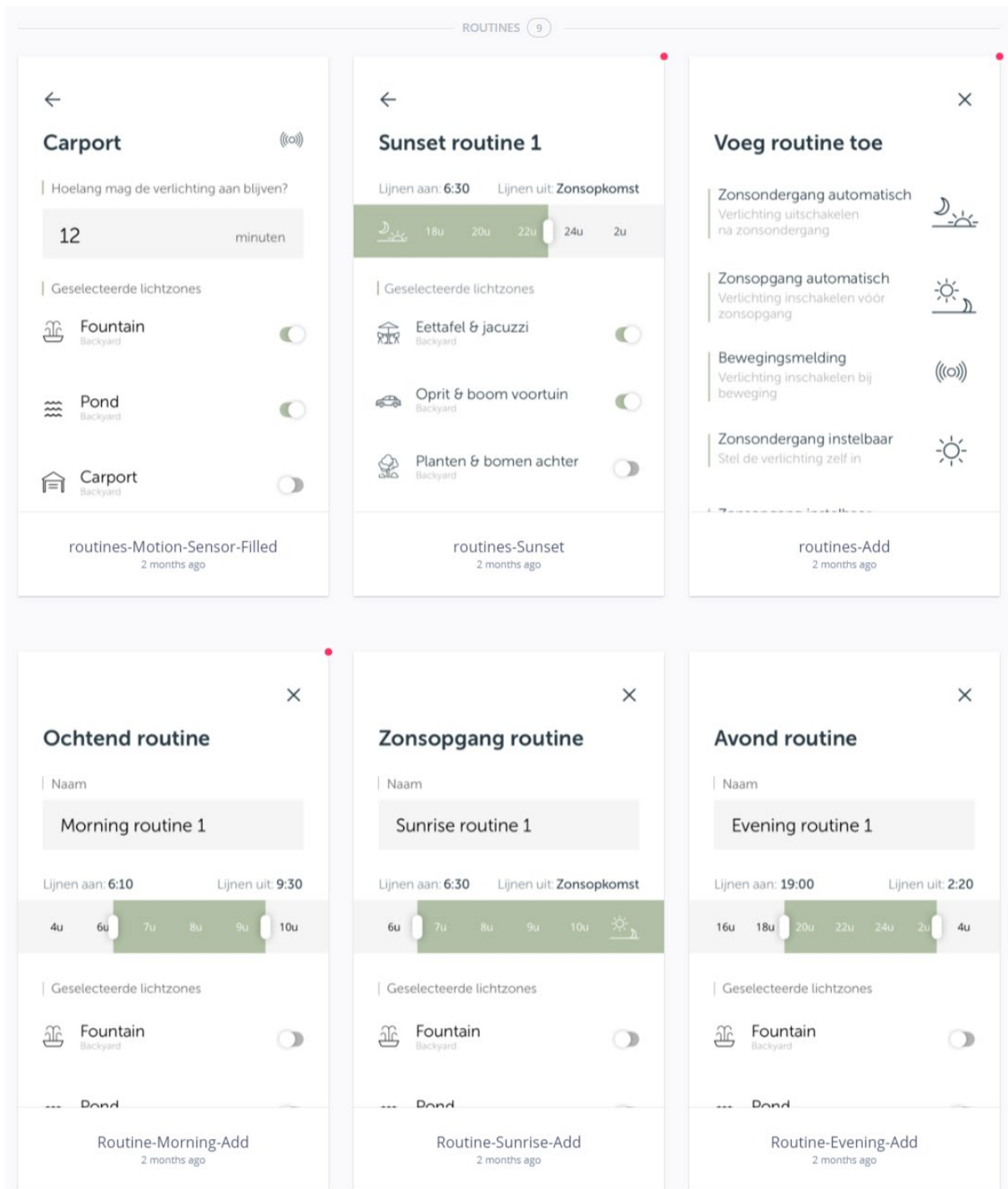
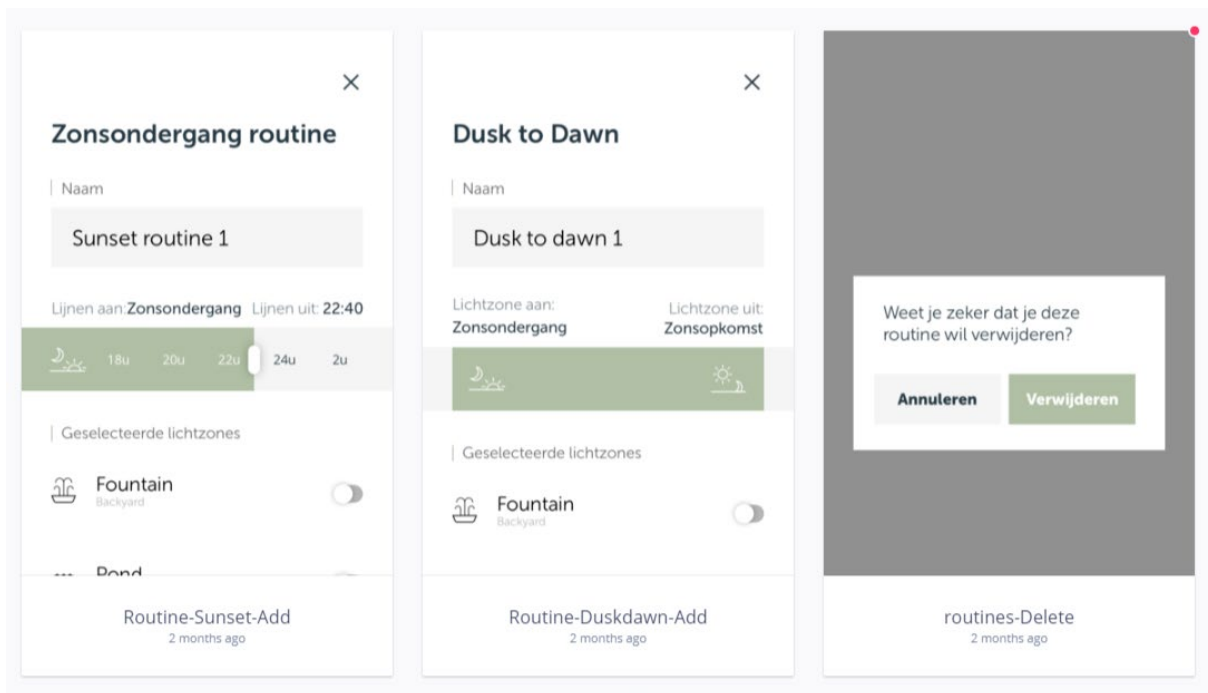

FIG. 21



**FIG. 22**

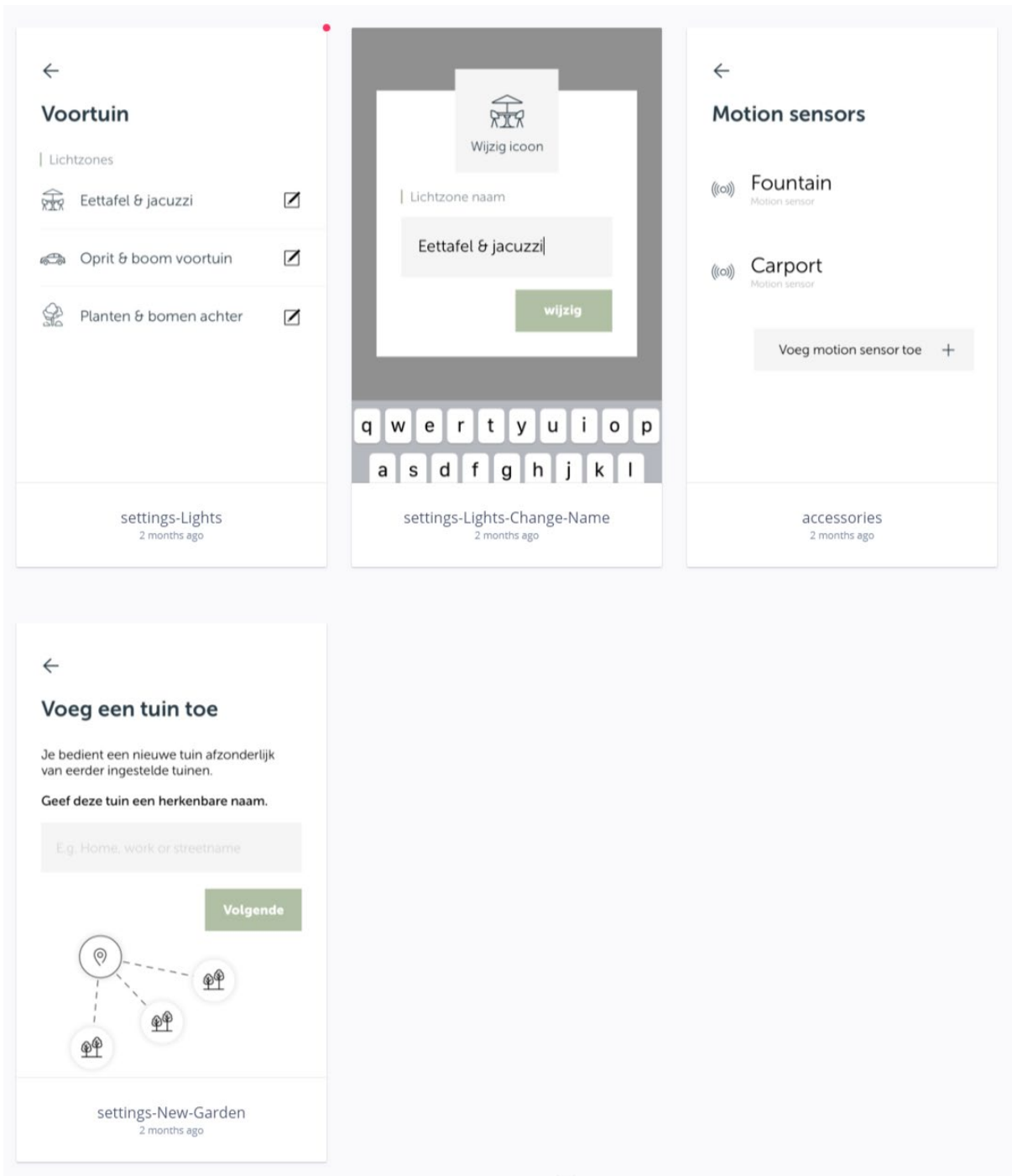

FIG. 23

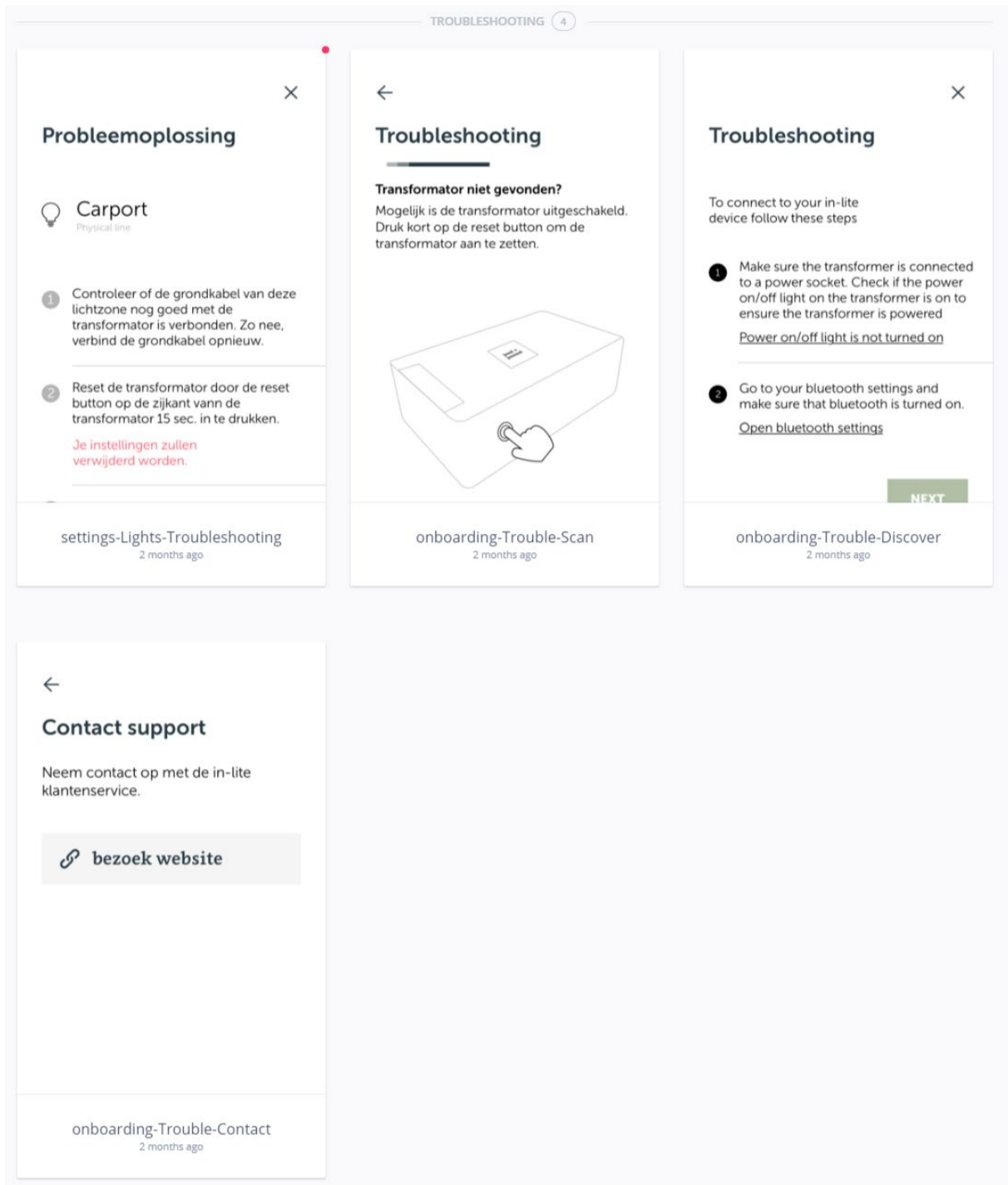

FIG. 24

## Use

### Manual use

Press the on/off button on the side of the transformer to switch between "ON" and "OFF".

When the transformer is switched to "ON", the light settings in the device application (in-lite app) are activated. If one or more light sections (total 3) are set to "ON" they will be activated; the lights switch on. The light sections that are set to "OFF" stay deactivated. The first time while installing, all light sections will be set to "ON".

When the transformer is switched to "OFF", all light sections are deactivated; all lights switch off.

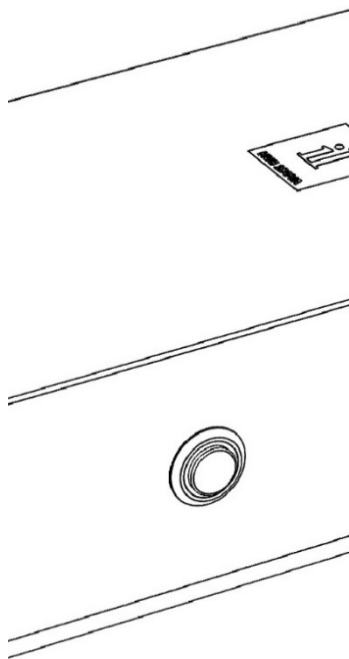

**FIG. 6**

### Use with smart device

All lights can be controlled with the in-lite application (app) on a smart phone or tablet. The app, which is suitable for an Android and iOS device, can be downloaded from the app store and installed on your device.

The in-lite app makes it possible to communicate with the transformer by a Bluetooth connection. In the app you can turn light sections (total 3) "ON" and "OFF". You can also set different scenarios based on sunset and sunrise, time of the day and/or movement detection (with accessory SMART MOVE).

## Troubleshooting tips

### **The lighting does not switch on with any of the programs.**

Check that the transformer is correctly connected. If so, check the voltage at the electric socket (you can do this using a voltage tester). Check that the low-voltage cable is correctly wired to the transformer.

### **Only a few lamps switch on.**

Check that the contacts of the fixture's Easy-Lock have correctly pierced the insulation of the cable. Check whether the fixture is properly attached and that it is not defective.

### **Options for laying 12 V cable**

There are two types of cable plans or methods of laying cables: linear and split. If you have made a lighting plan then making the wiring diagram is just a question of drawing the cable onto the garden design. Follow an imaginary line between the fixtures. Always test the circuit above ground before you bury the cable underneath paving or soil.

#### **Option 1: linear set-up**

Roll out the cable from the transformer into the garden and lead it to the various armatures. The cable can end anywhere and can have the following maximum length:

14/2 cable up to 40 m

10/2 cable up to 80 m

Does your lighting plan include fixtures with total power greater than 35 VA?  
Always use the 10/2 cable for these situations.

#### **Option 2: split set-up**

Roll out the cable from the transformer into the garden. Using the cable connectors, make one or more branches that you lead to the various fixtures.

The maximum length of the branch or branches depends on the place where you install the cable connectors or fixtures. For each branch first calculate the length of cable from the transformer to the relevant cable connector. Subtract this length from the maximum cable length for the cable you are using. The remaining number of metres is the maximum length of the branch. You can make several branches as long as this total does not exceed the maximum cable length:

14/2 cable up to 40 m (Fig. 8A)

10/2 cable up to 80 m (Fig. 8B)

Does your lighting plan include fixtures with total power greater than 35 VA?  
Always use the 10/2 cable for these situations.

## Installation tips

### Tip 1

Use plenty of cable for the installation. In that case the cable will have enough length if the garden subsides a little.

### Tip 2

Insulate the cable ends with caps. You can do this by pulling the end three centimetres of cable apart and putting a cap on each end. You do not need to remove any insulation from the cable.

### Tip 3

When connecting the fixtures leave plenty of cable from the fixture. There are special extension cables (CBL-EXT CORD) of 1 metre and 3 metres available to increase the distance of the fixture to the main cable. These are easy to install between the mini-connector on the fixture and the mini-connector on the Easy-Lock.

If after reading these instructions you have further question about installing 12 V cable, please contact your dealer.

## Installing fixtures on 12 V

You can easily connect in-lite fixtures to the low-voltage cable using the Easy-Lock connector (supplied with each fixture).

Important: always check the manual for specific instructions for the relevant fixture. See [www.in-lite.com](http://www.in-lite.com).

### Step 1

Join the Easy-Lock connector to the main cable.

- a. Clamp the cable duct on top of the main cable. There should be no space left between the cable and the duct.
- b. Place the cable duct (with the cable at the bottom) in the Easy-Lock connector.
- c. Tighten the threaded cap on the Easy-Lock connector. This will cause the contacts to be pushed through the insulation on the cable. In tightening the cap, a little gel is applied to the contacts in the Easy-Lock connector. This serves to protect the contacts against moisture. A little gel may possibly come out of the Easy-Lock connector: so after installation (and/or before a meal), wash your hands with soap and water, and avoid the gel coming into contact with your eyes.

### Step 2

Connect the Easy-Lock to the fixture by connecting the mini-connector. If the lamp does not work correctly, check that the Easy-Lock connector is properly connected to the main cable. Do the same for the mini-connector. Repeat steps 1 and 2. When the fixture is connected to the main cable also check that the contacts of the Easy-Lock connector are not bent. If you have any problems, contact your dealer.