

FCC REPORT

(BLE)

Applicant: Shenzhen Youmi Intelligent Technology Co., Ltd.

Address of Applicant: 406-407 Jinqi Zhigu Building, 4/F, 1 Tangling Road, Nanshan District, Shenzhen City, China.

Equipment Under Test (EUT)

Product Name: Smart phone

Model No.: A7 Pro, A7, A7S, A3SE, F3, Power 3X

Trade mark: UMIDIGI

FCC ID: 2ATZ4A7PSF3X

Applicable standards: FCC CFR Title 47 Part 15 Subpart C Section 15.247

Date of sample receipt: 16 Apr., 2020

Date of Test: 17 Apr., to 11 May, 2020

Date of report issued: 12 May, 2020

Test Result: PASS *

* In the configuration tested, the EUT complied with the standards specified above.

Authorized Signature:



Bruce Zhang
Laboratory Manager

This report details the results of the testing carried out on one sample. The results contained in this test report do not relate to other samples of the same product and does not permit the use of the CCIS product certification mark. The manufacturer should ensure that all products in series production are in conformity with the product sample detailed in this report.

This report may only be reproduced and distributed in full. If the product in this report is used in any configuration other than that detailed in the report, the manufacturer must ensure the new system complies with all relevant standards.

This document cannot be reproduced except in full, without prior written approval of the Company. Any unauthorized alteration, forgery or falsification of the content or appearance of this document is unlawful and offenders may be prosecuted to the fullest extent of the law. Unless otherwise stated the results shown in this test report refer only to the sample(s) tested and such sample(s) are retained for 90 days only.

2 Version

| Version No. | Date | Description |
|-------------|--------------|-------------|
| 00 | 12 May, 2020 | Original |
| | | |
| | | |
| | | |
| | | |

Tested by: YT Yang **Date:** 12 May, 2020
Test Engineer

Reviewed by: Winner Zhang **Date:** 12 May, 2020
Project Engineer

3 Contents

| | Page |
|--|-----------|
| 1 COVER PAGE..... | 1 |
| 2 VERSION..... | 2 |
| 3 CONTENTS..... | 3 |
| 4 TEST SUMMARY..... | 4 |
| 5 GENERAL INFORMATION..... | 5 |
| 5.1 CLIENT INFORMATION..... | 5 |
| 5.2 GENERAL DESCRIPTION OF E.U.T..... | 5 |
| 5.3 TEST ENVIRONMENT AND TEST MODE..... | 6 |
| 5.4 DESCRIPTION OF SUPPORT UNITS..... | 6 |
| 5.5 MEASUREMENT UNCERTAINTY..... | 6 |
| 5.6 ADDITIONS TO, DEVIATIONS, OR EXCLUSIONS FROM THE METHOD..... | 6 |
| 5.7 LABORATORY FACILITY..... | 6 |
| 5.8 LABORATORY LOCATION..... | 6 |
| 5.9 TEST INSTRUMENTS LIST..... | 7 |
| 6 TEST RESULTS AND MEASUREMENT DATA..... | 8 |
| 6.1 ANTENNA REQUIREMENT:..... | 8 |
| 6.2 CONDUCTED EMISSION..... | 9 |
| 6.3 CONDUCTED OUTPUT POWER..... | 12 |
| 6.4 OCCUPY BANDWIDTH..... | 14 |
| 6.5 POWER SPECTRAL DENSITY..... | 16 |
| 6.6 BAND EDGE..... | 18 |
| 6.6.1 Conducted Emission Method..... | 18 |
| 6.6.2 Radiated Emission Method..... | 20 |
| 6.7 SPURIOUS EMISSION..... | 25 |
| 6.7.1 Conducted Emission Method..... | 25 |
| 6.7.2 Radiated Emission Method..... | 27 |
| 7 TEST SETUP PHOTO..... | 32 |
| 8 EUT CONSTRUCTIONAL DETAILS..... | 33 |

4 Test Summary

| Test Items | Section in CFR 47 | Result |
|--|--|--------|
| Antenna requirement | 15.203 & 15.247 (b) | Pass |
| AC Power Line Conducted Emission | 15.207 | Pass |
| Conducted Peak Output Power | 15.247 (b)(3) | Pass |
| 6dB Emission Bandwidth 99% Occupied Bandwidth | 15.247 (a)(2) | Pass |
| Power Spectral Density | 15.247 (e) | Pass |
| Band Edge | 15.247 (d) | Pass |
| Spurious Emission | 15.205 & 15.209 | Pass |
| <p>Remark:</p> <ol style="list-style-type: none"> 1. Pass: The EUT complies with the essential requirements in the standard. 2. N/A: Not Applicable. 3. The cable insertion loss used by "RF Output Power" and other conduction measurement items is 0.5dB (provided by the customer). | | |
| Test Method: | ANSI C63.10-2013 KDB 558074 D01 15.247 Meas Guidance v05r02 | |

5 General Information

5.1 Client Information

| | |
|---------------|---|
| Applicant: | Shenzhen Youmi Intelligent Technology Co., Ltd. |
| Address: | 406-407 Jinqi Zhigu Building, 4/F, 1 Tangling Road, Nanshan District, Shenzhen City, China. |
| Manufacturer: | Shenzhen Youmi Intelligent Technology Co., Ltd. |
| Address: | 406-407 Jinqi Zhigu Building, 4/F, 1 Tangling Road, Nanshan District, Shenzhen City, China. |

5.2 General Description of E.U.T.

| | |
|------------------------|--|
| Product Name: | Smart phone |
| Model No.: | A7 Pro, A7, A7S, A3SE, F3, Power 3X |
| Operation Frequency: | 2402-2480 MHz |
| Channel numbers: | 40 |
| Channel separation: | 2 MHz |
| Modulation technology: | GFSK |
| Data speed : | 1Mbps |
| Antenna Type: | Internal Antenna |
| Antenna gain: | 0.3 dBi |
| Power supply: | Rechargeable Li-ion Battery DC3.85V, 4150mAh |
| AC adapter: | Model: HJ-0502000W2-US Input: AC100-240V, 50/60Hz, 0.3A Output: DC 5.0V, 2.0A |
| Remark: | The No.: A7 Pro, A7, A7S, A3SE, F3, Power 3X were identical inside, the electrical circuit design, layout, components used and internal wiring, with only difference being model name. |
| Test Sample Condition: | The test samples were provided in good working order with no visible defects. |

| Operation Frequency each of channel | | | | | | | |
|-------------------------------------|-----------|---------|-----------|---------|-----------|---------|-----------|
| Channel | Frequency | Channel | Frequency | Channel | Frequency | Channel | Frequency |
| 0 | 2402MHz | 10 | 2422MHz | 20 | 2442MHz | 30 | 2462MHz |
| 1 | 2404MHz | 11 | 2424MHz | 21 | 2444MHz | 31 | 2464MHz |
| 2 | 2406MHz | 12 | 2426MHz | 22 | 2446MHz | 32 | 2466MHz |
| 3 | 2408MHz | 13 | 2428MHz | 23 | 2448MHz | 33 | 2468MHz |
| 4 | 2410MHz | 14 | 2430MHz | 24 | 2450MHz | 34 | 2470MHz |
| 5 | 2412MHz | 15 | 2432MHz | 25 | 2452MHz | 35 | 2472MHz |
| 6 | 2414MHz | 16 | 2434MHz | 26 | 2454MHz | 36 | 2474MHz |
| 7 | 2416MHz | 17 | 2436MHz | 27 | 2456MHz | 37 | 2476MHz |
| 8 | 2418MHz | 18 | 2438MHz | 28 | 2458MHz | 38 | 2478MHz |
| 9 | 2420MHz | 19 | 2440MHz | 29 | 2460MHz | 39 | 2480MHz |

Note:
In section 15.31(m), regards to the operating frequency range over 10 MHz, the Lowest frequency, the middle frequency, and the highest frequency of channel were selected to perform the test. Channel No. 0, 20 & 39 were selected as Lowest, Middle and Highest channel.

5.3 Test environment and test mode

| Operating Environment: | |
|---|---|
| Temperature: | 24.0 °C |
| Humidity: | 54 % RH |
| Atmospheric Pressure: | 1010 mbar |
| Test mode: | |
| Transmitting mode | Keep the EUT in continuous transmitting with modulation |
| <p>Radiated Emission: The sample was placed 0.8m (below 1GHz)/1.5m (above 1GHz) above the ground plane of 3m chamber. Measurements in both horizontal and vertical polarities were performed. During the test, each emission was maximized by: having the EUT continuously working, investigated all operating modes, rotated about all 3 axis (X, Y & Z) and considered typical configuration to obtain worst position, manipulating interconnecting cables, rotating the turntable, varying antenna height from 1m to 4m in both horizontal and vertical polarizations. The emissions worst-case are shown in Test Results of the following pages. Duty cycle setting during the transmission is 100% with maximum power setting for all modulations.</p> | |

5.4 Description of Support Units

| |
|---|
| The EUT has been tested as an independent unit. |
|---|

5.5 Measurement Uncertainty

| Parameters | Expanded Uncertainty |
|-------------------------------------|----------------------|
| Conducted Emission (9kHz ~ 30MHz) | ±1.60 dB (k=2) |
| Radiated Emission (9kHz ~ 30MHz) | ±3.12 dB (k=2) |
| Radiated Emission (30MHz ~ 1000MHz) | ±4.32 dB (k=2) |
| Radiated Emission (1GHz ~ 18GHz) | ±5.16 dB (k=2) |
| Radiated Emission (18GHz ~ 40GHz) | ±3.20 dB (k=2) |

5.6 Additions to, deviations, or exclusions from the method

| |
|----|
| No |
|----|

5.7 Laboratory Facility

| |
|--|
| <p>The test facility is recognized, certified, or accredited by the following organizations:</p> <ul style="list-style-type: none"> ● FCC - Designation No.: CN1211 Shenzhen Zhongjian Nanfang Testing Co., Ltd. has been accredited as a testing laboratory by FCC(Federal Communications Commission). The test firm Registration No. is 727551. ● ISED – CAB identifier.: CN0021 The 3m Semi-anechoic chamber of Shenzhen Zhongjian Nanfang Testing Co., Ltd. has been Registered by Certification and Engineering Bureau of Industry Canada for radio equipment testing with Registration No.: 10106A-1. ● A2LA - Registration No.: 4346.01 This laboratory is accredited in accordance with the recognized International Standard ISO/IEC 17025:2005 General requirements for the competence of testing and calibration laboratories. The test scope can be found as below link: https://portal.a2la.org/scopepdf/4346-01.pdf |
|--|

5.8 Laboratory Location

| |
|--|
| <p>Shenzhen Zhongjian Nanfang Testing Co., Ltd. Address: No.110~116, Building B, Jinyuan Business Building, Xixiang Road, Bao'an District, Shenzhen, Guangdong, China Tel: +86-755-23118282, Fax: +86-755-23116366 Email: info@ccis-cb.com, Website: http://www.ccis-cb.com</p> |
|--|

5.9 Test Instruments list

| Radiated Emission: | | | | | |
|--------------------|-----------------|---------------|--------------------|----------------------|--------------------------|
| Test Equipment | Manufacturer | Model No. | Serial No. | Cal. Date (mm-dd-yy) | Cal. Due date (mm-dd-yy) |
| 3m SAC | SAEMC | 9m*6m*6m | 966 | 07-22-2017 | 07-21-2020 |
| Loop Antenna | SCHWARZBECK | FMZB1519B | 044 | 03-07-2020 | 03-06-2021 |
| BiConiLog Antenna | SCHWARZBECK | VULB9163 | 497 | 03-07-2020 | 03-06-2021 |
| Horn Antenna | SCHWARZBECK | BBHA9120D | 916 | 03-07-2020 | 03-06-2021 |
| Horn Antenna | SCHWARZBECK | BBHA9120D | 1805 | 06-22-2017 | 06-21-2020 |
| Horn Antenna | SCHWARZBECK | BBHA 9170 | BBHA9170582 | 11-18-2019 | 11-17-2020 |
| EMI Test Software | AUDIX | E3 | Version: 6.110919b | | |
| Pre-amplifier | HP | 8447D | 2944A09358 | 03-07-2020 | 03-06-2021 |
| Pre-amplifier | CD | PAP-1G18 | 11804 | 03-07-2020 | 03-06-2021 |
| Spectrum analyzer | Rohde & Schwarz | FSP30 | 101454 | 03-05-2020 | 03-04-2021 |
| Spectrum analyzer | Rohde & Schwarz | FSP40 | 100363 | 11-18-2019 | 11-17-2020 |
| EMI Test Receiver | Rohde & Schwarz | ESRP7 | 101070 | 03-05-2020 | 03-04-2021 |
| Cable | ZDECL | Z108-NJ-NJ-81 | 1608458 | 03-07-2020 | 03-06-2021 |
| Cable | MICRO-COAX | MFR64639 | K10742-5 | 03-07-2020 | 03-06-2021 |
| Cable | SUHNER | SUCOFLEX100 | 58193/4PE | 03-07-2020 | 03-06-2021 |
| RF Switch Unit | MWRFTTEST | MW200 | N/A | N/A | N/A |
| Test Software | MWRFTTEST | MTS8200 | Version: 2.0.0.0 | | |

| Conducted Emission: | | | | | |
|---------------------|-----------------|------------|--------------------|----------------------|--------------------------|
| Test Equipment | Manufacturer | Model No. | Serial No. | Cal. Date (mm-dd-yy) | Cal. Due date (mm-dd-yy) |
| EMI Test Receiver | Rohde & Schwarz | ESCI | 101189 | 03-05-2020 | 03-04-2021 |
| Pulse Limiter | SCHWARZBECK | OSRAM 2306 | 9731 | 03-05-2020 | 03-04-2021 |
| LISN | CHASE | MN2050D | 1447 | 03-05-2020 | 03-04-2021 |
| LISN | Rohde & Schwarz | ESH3-Z5 | 8438621/010 | 07-21-2017 | 07-20-2020 |
| Cable | HP | 10503A | N/A | 03-05-2020 | 03-04-2021 |
| EMI Test Software | AUDIX | E3 | Version: 6.110919b | | |

6 Test results and Measurement Data

6.1 Antenna requirement:

| | |
|--|--------------------------------------|
| Standard requirement: | FCC Part 15 C Section 15.203 /247(b) |
| <p>15.203 requirement: An intentional radiator shall be designed to ensure that no antenna other than that furnished by the responsible party shall be used with the device. The use of a permanently attached antenna or of an antenna that uses a unique coupling to the intentional radiator, the manufacturer may design the unit so that a broken antenna can be replaced by the user, but the use of a standard antenna jack or electrical connector is prohibited.</p> <p>15.247(b) (4) requirement: (4) The conducted output power limit specified in paragraph (b) of this section is based on the use of antennas with directional gains that do not exceed 6 dBi. Except as shown in paragraph (c) of this section, if transmitting antennas of directional gain greater than 6 dBi are used, the conducted output power from the intentional radiator shall be reduced below the stated values in paragraphs (b)(1), (b)(2), and (b)(3) of this section, as appropriate, by the amount in dB that the directional gain of the antenna exceeds 6 dBi.</p> | |
| E.U.T Antenna: | |
| <p>The BLE antenna is an Internal antenna which cannot replace by end-user, the best-case gain of the antenna is 0.3 dBi.</p> | |
|  | |

6.2 Conducted Emission

| | | | |
|--|---|--------------|-----------|
| Test Requirement: | FCC Part 15 C Section 15.207 | | |
| Test Frequency Range: | 150 kHz to 30 MHz | | |
| Class / Severity: | Class B | | |
| Receiver setup: | RBW=9kHz, VBW=30kHz | | |
| Limit: | Frequency range (MHz) | Limit (dBuV) | |
| | | Quasi-peak | Average |
| | 0.15-0.5 | 66 to 56* | 56 to 46* |
| | 0.5-5 | 56 | 46 |
| | 5-30 | 60 | 50 |
| * Decreases with the logarithm of the frequency. | | | |
| Test procedure: | <ol style="list-style-type: none"> The E.U.T and simulators are connected to the main power through a line impedance stabilization network (L.I.S.N.), which provides a 50ohm/50uH coupling impedance for the measuring equipment. The peripheral devices are also connected to the main power through a LISN that provides a 50ohm/50uH coupling impedance with 50ohm termination. (Please refer to the block diagram of the test setup and photographs). Both sides of A.C. line are checked for maximum conducted interference. In order to find the maximum emission, the relative positions of equipment and all of the interface cables must be changed according to ANSI C63.10(latest version) on conducted measurement. | | |
| Test setup: | <p><i>Remark</i> E.U.T: Equipment Under Test LISN: Line Impedance Stabilization Network Test table height=0.8m</p> | | |
| Test Instruments: | Refer to section 5.9 for details | | |
| Test mode: | Refer to section 5.3 for details | | |
| Test results: | Passed | | |

Measurement Data:

| | | | |
|------------------------|------------------|-----------------------|---------------------------|
| Product name: | Smart phone | Product model: | A7 Pro |
| Test by: | YT | Test mode: | BLE Tx mode |
| Test frequency: | 150 kHz ~ 30 MHz | Phase: | Line |
| Test voltage: | AC 120 V/60 Hz | Environment: | Temp: 22.5°C Humi: 55% |

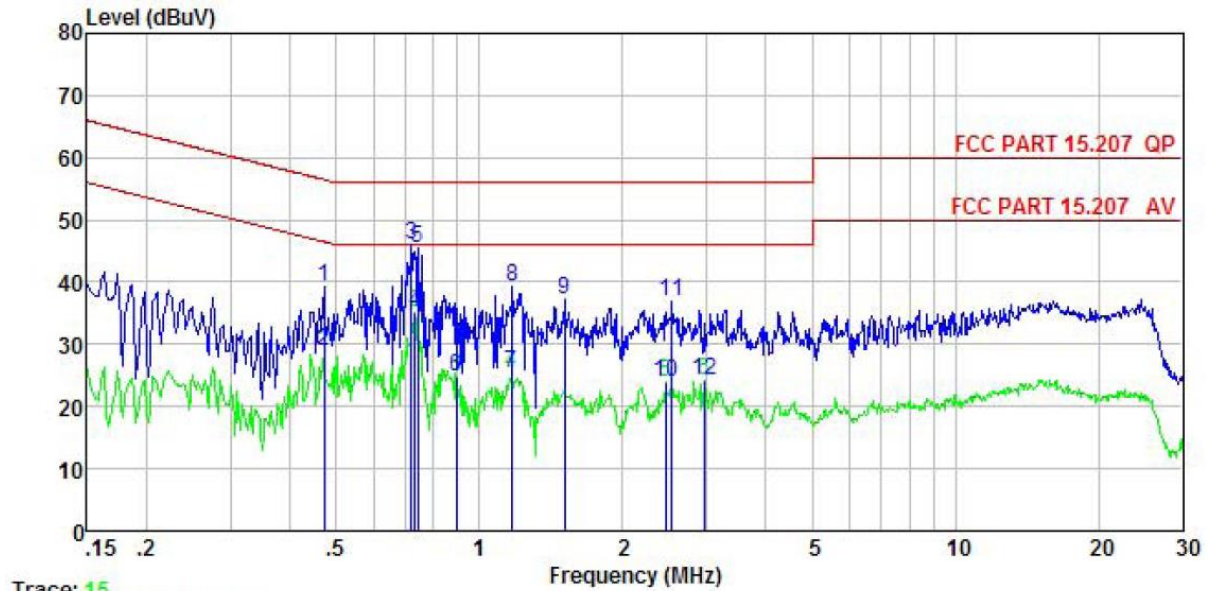

| | Read Freq | Read Level | LISN Factor | Aux Factor | Cable Loss | Level | Limit Line | Over Limit | Remark |
|----|-----------|------------|-------------|------------|------------|-------|------------|------------|---------|
| | MHz | dBuV | dB | dB | dB | dBuV | dBuV | dB | |
| 1 | 0.471 | 29.07 | -0.38 | -0.15 | 10.75 | 39.29 | 56.49 | -17.20 | QP |
| 2 | 0.471 | 18.58 | -0.38 | -0.15 | 10.75 | 28.80 | 46.49 | -17.69 | Average |
| 3 | 0.720 | 36.07 | -0.38 | -0.34 | 10.78 | 46.13 | 56.00 | -9.87 | QP |
| 4 | 0.731 | 25.04 | -0.38 | -0.30 | 10.78 | 35.14 | 46.00 | -10.86 | Average |
| 5 | 0.743 | 35.24 | -0.38 | -0.26 | 10.79 | 45.39 | 56.00 | -10.61 | QP |
| 6 | 0.894 | 14.07 | -0.38 | 0.19 | 10.84 | 24.72 | 46.00 | -21.28 | Average |
| 7 | 1.166 | 14.67 | -0.39 | 0.29 | 10.89 | 25.46 | 46.00 | -20.54 | Average |
| 8 | 1.172 | 28.34 | -0.39 | 0.29 | 10.89 | 39.13 | 56.00 | -16.87 | QP |
| 9 | 1.511 | 26.55 | -0.40 | -0.01 | 10.92 | 37.06 | 56.00 | -18.94 | QP |
| 10 | 2.461 | 13.73 | -0.43 | -0.26 | 10.94 | 23.98 | 46.00 | -22.02 | Average |
| 11 | 2.540 | 26.56 | -0.43 | -0.25 | 10.94 | 36.82 | 56.00 | -19.18 | QP |
| 12 | 2.962 | 14.00 | -0.44 | -0.21 | 10.92 | 24.27 | 46.00 | -21.73 | Average |

Notes:

1. An initial pre-scan was performed on the line and neutral lines with peak detector.
2. Quasi-Peak and Average measurement were performed at the frequencies with maximized peak emission.
3. Final Level = Receiver Read level + LISN Factor + Aux Factor + Cable Loss.

| | | | |
|------------------------|------------------|-----------------------|------------------------|
| Product name: | Smart phone | Product model: | A7 Pro |
| Test by: | YT | Test mode: | BLE Tx mode |
| Test frequency: | 150 kHz ~ 30 MHz | Phase: | Neutral |
| Test voltage: | AC 120 V/60 Hz | Environment: | Temp: 22.5°C Humi: 55% |

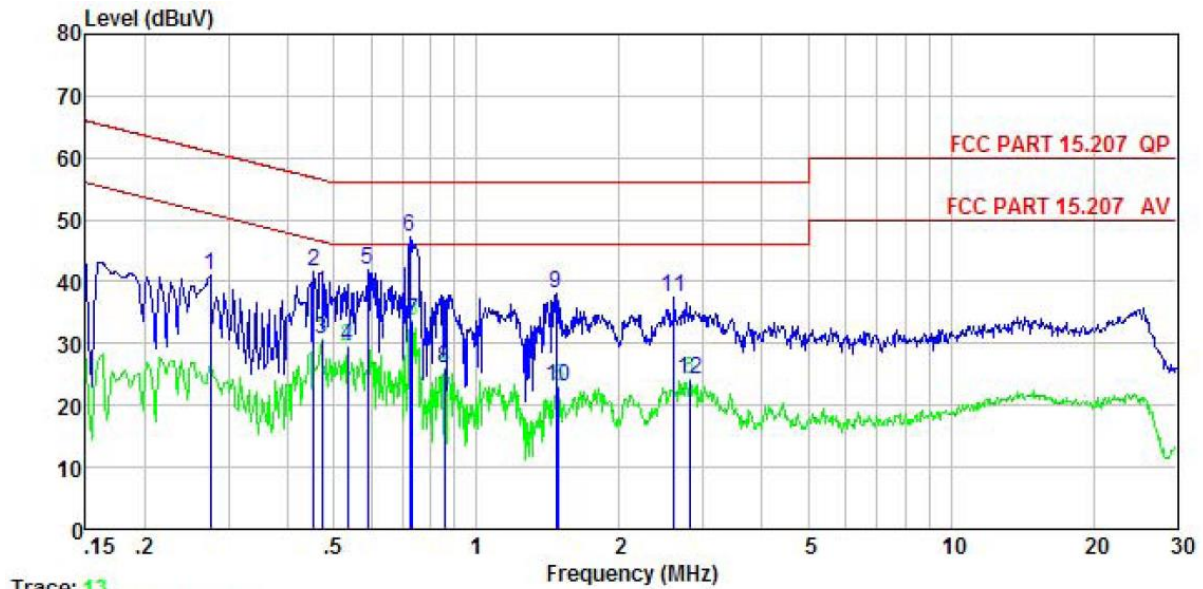

| | Freq | Read Level | LISN Factor | Aux Factor | Cable Loss | Level | Limit Line | Over Limit | Remark |
|----|-------|------------|-------------|------------|------------|-------|------------|------------|---------|
| | MHz | dBuV | dB | dB | dB | dBuV | dBuV | dB | |
| 1 | 0.274 | 30.93 | -0.64 | 0.01 | 10.74 | 41.04 | 60.98 | -19.94 | QP |
| 2 | 0.454 | 31.55 | -0.65 | -0.01 | 10.74 | 41.63 | 56.80 | -15.17 | QP |
| 3 | 0.471 | 20.54 | -0.65 | 0.01 | 10.75 | 30.65 | 46.49 | -15.84 | Average |
| 4 | 0.535 | 19.43 | -0.65 | 0.03 | 10.76 | 29.57 | 46.00 | -16.43 | Average |
| 5 | 0.589 | 31.74 | -0.65 | 0.03 | 10.76 | 41.88 | 56.00 | -14.12 | QP |
| 6 | 0.724 | 36.95 | -0.64 | 0.04 | 10.78 | 47.13 | 56.00 | -8.87 | QP |
| 7 | 0.731 | 23.41 | -0.64 | 0.04 | 10.78 | 33.59 | 46.00 | -12.41 | Average |
| 8 | 0.857 | 15.60 | -0.63 | 0.06 | 10.83 | 25.86 | 46.00 | -20.14 | Average |
| 9 | 1.472 | 27.65 | -0.65 | 0.13 | 10.92 | 38.05 | 56.00 | -17.95 | QP |
| 10 | 1.487 | 12.48 | -0.65 | 0.13 | 10.92 | 22.88 | 46.00 | -23.12 | Average |
| 11 | 2.608 | 26.89 | -0.67 | 0.26 | 10.93 | 37.41 | 56.00 | -18.59 | QP |
| 12 | 2.809 | 13.57 | -0.67 | 0.29 | 10.93 | 24.12 | 46.00 | -21.88 | Average |

Notes:

1. An initial pre-scan was performed on the line and neutral lines with peak detector.
2. Quasi-Peak and Average measurement were performed at the frequencies with maximized peak emission.
3. Final Level = Receiver Read level + LISN Factor + Aux Factor + Cable Loss.

6.3 Conducted Output Power

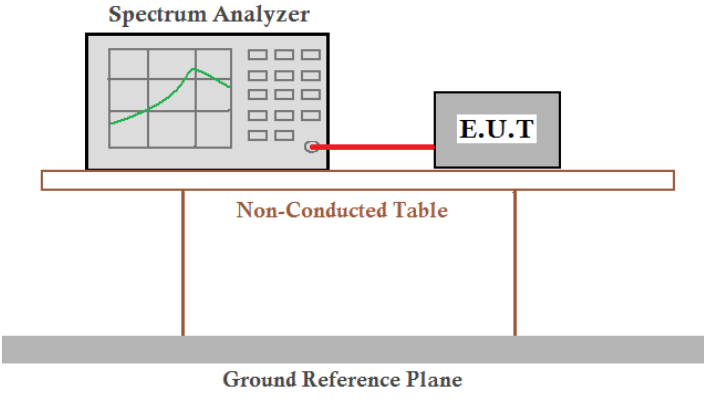
| | |
|-------------------|---|
| Test Requirement: | FCC Part 15 C Section 15.247 (b)(3) |
| Limit: | 30dBm |
| Test setup: |  <p>The diagram illustrates the test setup. A Spectrum Analyzer is connected to an E.U.T. (Equipment Under Test) via a red cable. Both are placed on a Non-Conducted Table, which is supported by a Ground Reference Plane.</p> |
| Test Instruments: | Refer to section 5.9 for details |
| Test mode: | Refer to section 5.3 for details |
| Test results: | Passed |

Measurement Data:

| Test CH | Maximum Conducted Output Power (dBm) | Limit(dBm) | Result |
|---------|--------------------------------------|------------|--------|
| Lowest | 7.28 | 30.00 | Pass |
| Middle | 7.83 | | |
| Highest | 7.89 | | |

Test plot as follows:

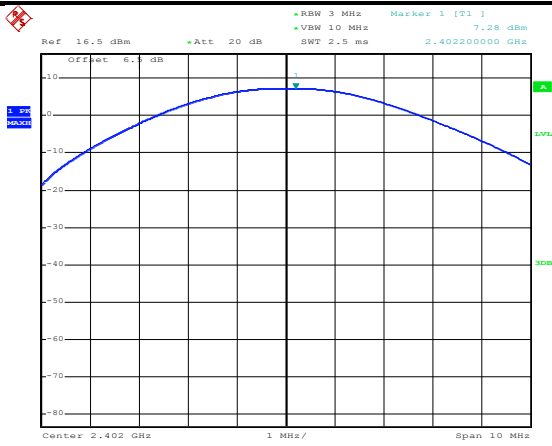

Date: 17.APR.2020 19:08:33

Lowest channel

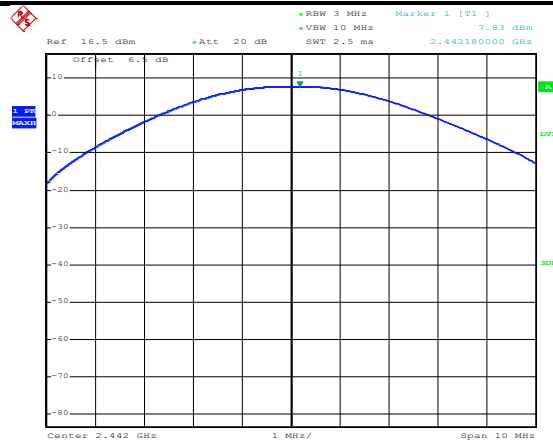

Date: 17.APR.2020 19:08:45

Middle channel

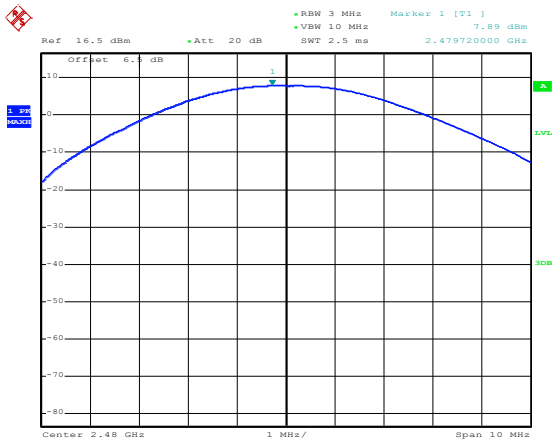

Date: 17.APR.2020 19:08:55

Highest channel

6.4 Occupy Bandwidth

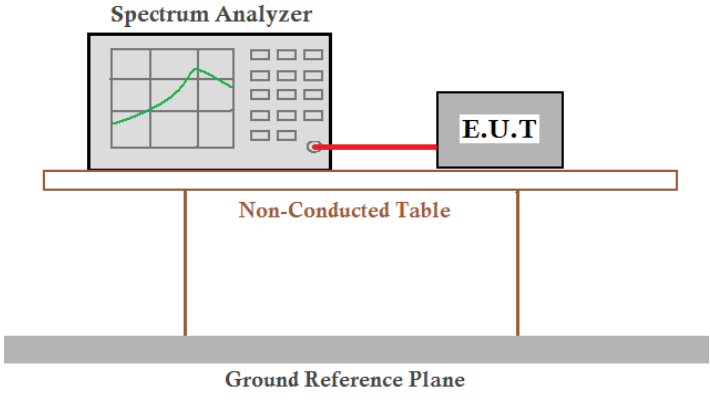
| | |
|-------------------|--|
| Test Requirement: | FCC Part 15 C Section 15.247 (a)(2) |
| Limit: | >500kHz |
| Test setup: |  <p>The diagram shows a Spectrum Analyzer on the left and an E.U.T. on the right, connected by a red cable. They are both on a table labeled 'Non-Conducted Table'. Below the table is a 'Ground Reference Plane'.</p> |
| Test Instruments: | Refer to section 5.9 for details |
| Test mode: | Refer to section 5.3 for details |
| Test results: | Passed |

Measurement Data:

| Test CH | 6dB Emission Bandwidth (MHz) | Limit(kHz) | Result |
|---------|------------------------------|------------|--------|
| Lowest | 0.738 | >500 | Pass |
| Middle | 0.714 | | |
| Highest | 0.726 | | |
| Test CH | 99% Occupy Bandwidth (MHz) | Limit(kHz) | Result |
| Lowest | 1.032 | N/A | N/A |
| Middle | 1.032 | | |
| Highest | 1.032 | | |

Test plot as follows:

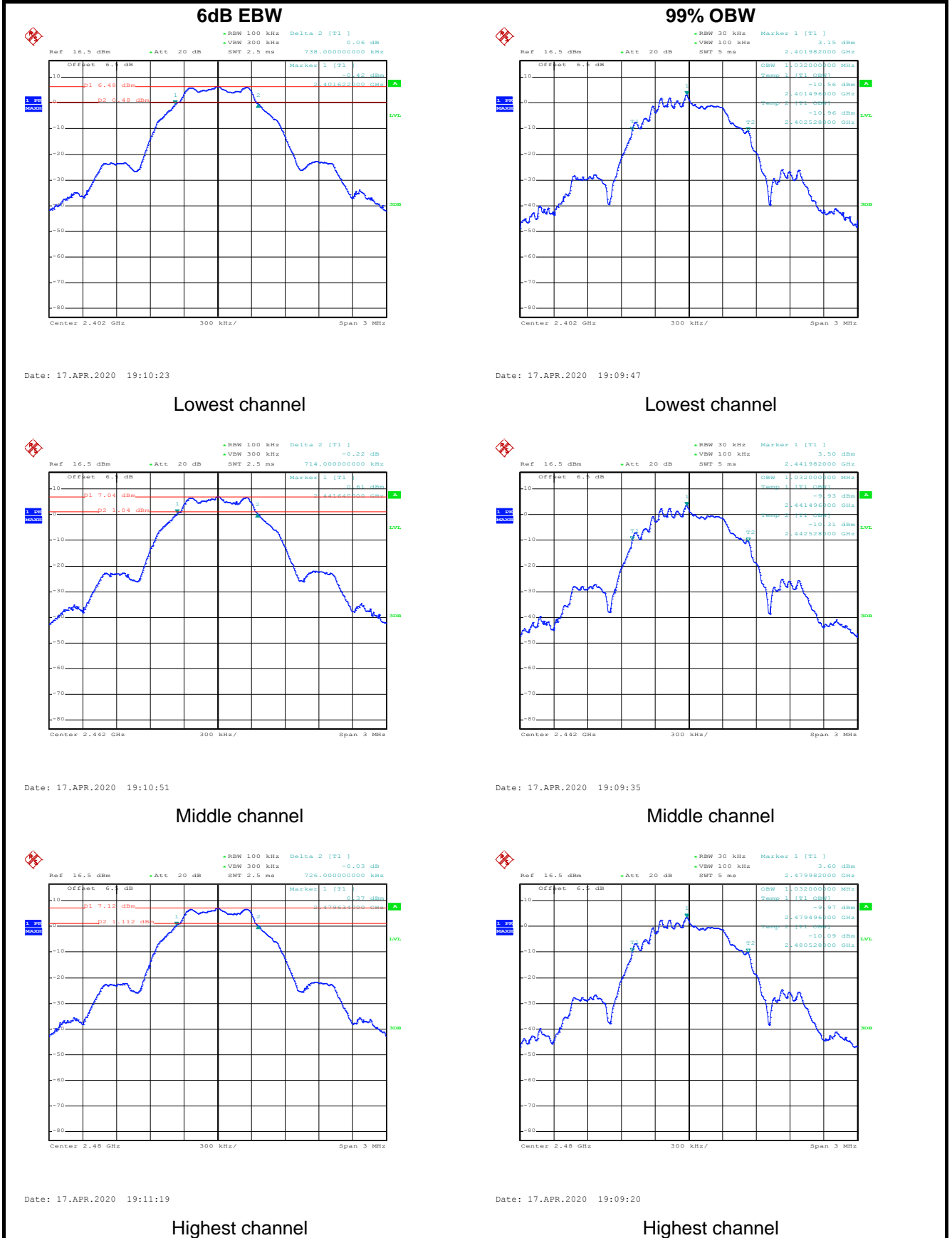

6.5 Power Spectral Density

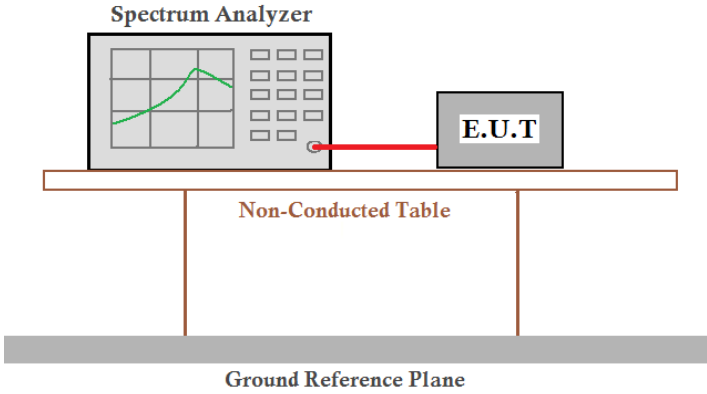
| | |
|-------------------|--|
| Test Requirement: | FCC Part 15 C Section 15.247 (e) |
| Limit: | 8 dBm/3kHz |
| Test setup: |  <p>The diagram illustrates the test setup. A Spectrum Analyzer is connected to an E.U.T. (Equipment Under Test) via a red cable. Both the Spectrum Analyzer and the E.U.T. are placed on a Non-Conducted Table. The table is supported by a Ground Reference Plane.</p> |
| Test Instruments: | Refer to section 5.9 for details |
| Test mode: | Refer to section 5.3 for details |
| Test results: | Passed |

Measurement Data:

| Test CH | Power Spectral Density (dBm/3kHz) | Limit (dBm/3kHz) | Result |
|---------|-----------------------------------|------------------|--------|
| Lowest | -7.97 | 8.00 | Pass |
| Middle | -7.43 | | |
| Highest | -7.54 | | |

Test plots as follow:

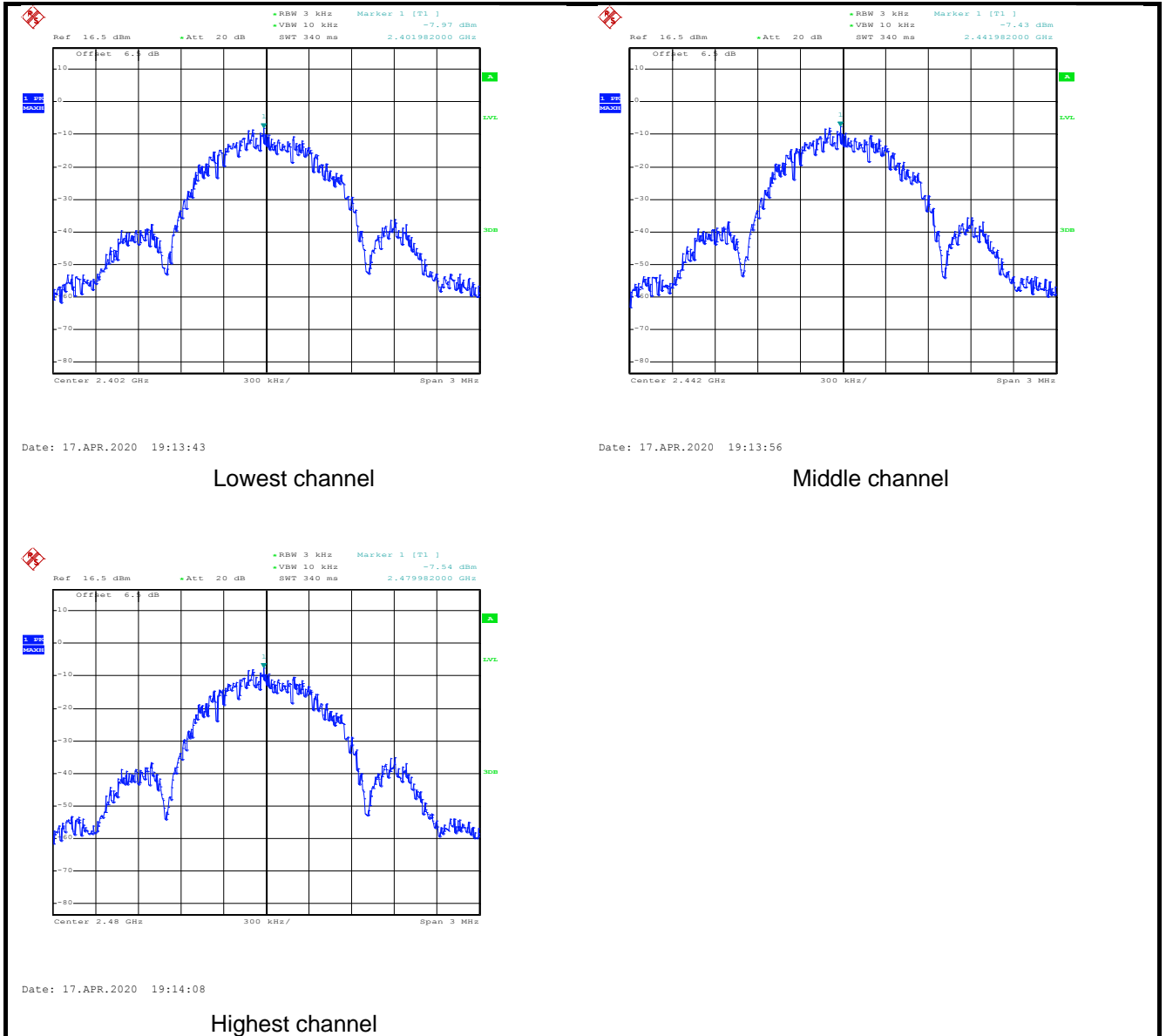

6.6 Band Edge

6.6.1 Conducted Emission Method

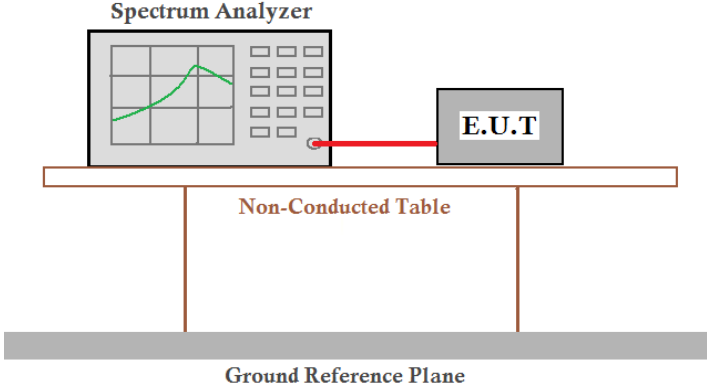
| | |
|-------------------|---|
| Test Requirement: | FCC Part 15 C Section 15.247 (d) |
| Limit: | In any 100 kHz bandwidth outside the frequency band in which the spread spectrum intentional radiator is operating, the radio frequency power that is produced by the intentional radiator shall be at least 20 dB below that in the 100 kHz bandwidth within the band that contains the highest level of the desired power, based on either an RF conducted or a radiated measurement. |
| Test setup: |  <p>The diagram illustrates the test setup. A Spectrum Analyzer is connected to an E.U.T (Equipment Under Test) via a red cable. Both the Spectrum Analyzer and the E.U.T are placed on a Non-Conducted Table. The table is supported by two legs and sits on a Ground Reference Plane.</p> |
| Test Instruments: | Refer to section 5.9 for details |
| Test mode: | Refer to section 5.3 for details |
| Test results: | Passed |

Test plots as follow:

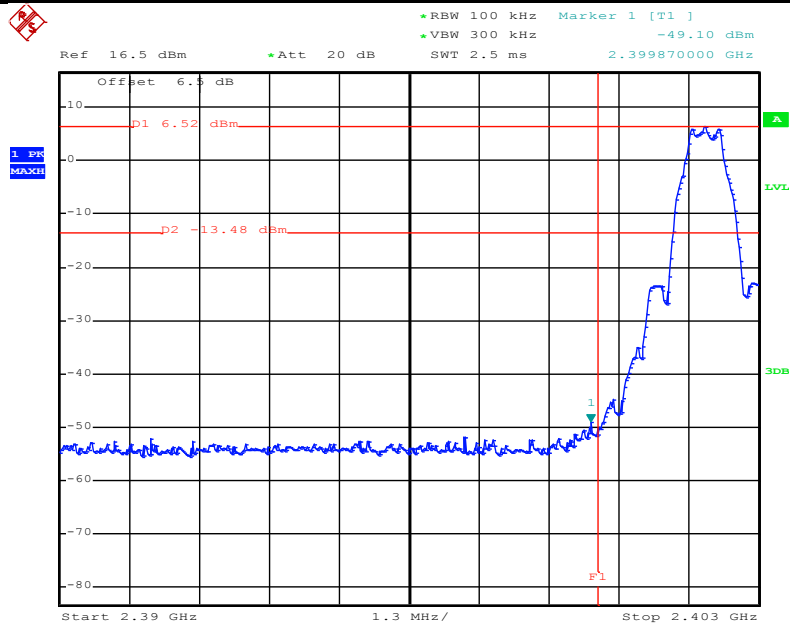

Date: 17.APR.2020 19:13:19

Lowest channel

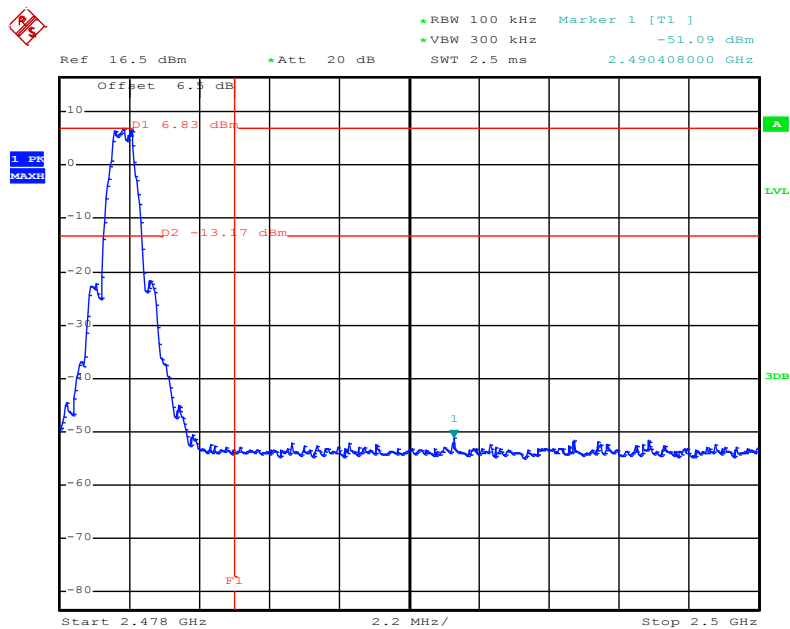

Date: 17.APR.2020 19:12:48

Highest channel

6.6.2 Radiated Emission Method

| | | | | | |
|-----------------------|---|--------------------|--------------|-----------------------------|-----------------------------|
| Test Requirement: | FCC Part 15 C Section 15.205 and 15.209 | | | | |
| Test Frequency Range: | 2310 MHz to 2390 MHz and 2483.5MHz to 2500 MHz | | | | |
| Test Distance: | 3m | | | | |
| Receiver setup: | Frequency | Detector | RBW | VBW | Remark |
| | Above 1GHz | Peak RMS | 1MHz 1MHz | 3MHz 3MHz | Peak Value Average Value |
| Limit: | Frequency | Limit (dBuV/m @3m) | | Remark | |
| | Above 1GHz | 54.00 74.00 | | Average Value Peak Value | |
| Test Procedure: | <ol style="list-style-type: none"> 1. The EUT was placed on the top of a rotating table 1.5 meters above the ground at a 3 meter camber. The table was rotated 360 degrees to determine the position of the highest radiation. 2. The EUT was set 3 meters away from the interference-receiving antenna, which was mounted on the top of a variable-height antenna tower. 3. The antenna height is varied from one meter to four meters above the ground to determine the maximum value of the field strength. Both horizontal and vertical polarizations of the antenna are set to make the measurement. 4. For each suspected emission, the EUT was arranged to its worst case and then the antenna was tuned to heights from 1 meter to 4 meters and the rota table was turned from 0 degrees to 360 degrees to find the maximum reading. 5. The test-receiver system was set to Peak Detect Function and Specified Bandwidth with Maximum Hold Mode. 6. If the emission level of the EUT in peak mode was 10 dB lower than the limit specified, then testing could be stopped and the peak values of the EUT would be reported. Otherwise the emissions that did not have 10 dB margin would be re-tested one by one using peak, quasi-peak or average method as specified and then reported in a data sheet. | | | | |
| Test setup: | | | | | |
| Test Instruments: | Refer to section 5.9 for details | | | | |
| Test mode: | Refer to section 5.3 for details | | | | |
| Test results: | Passed | | | | |

| | | | |
|----------------------|----------------|-----------------------|----------------------|
| Product Name: | Smart phone | Product Model: | A7 Pro |
| Test By: | YT | Test mode: | BLE Tx mode |
| Test Channel: | Lowest channel | Polarization: | Vertical |
| Test Voltage: | AC 120/60Hz | Environment: | Temp: 24°C Humi: 57% |

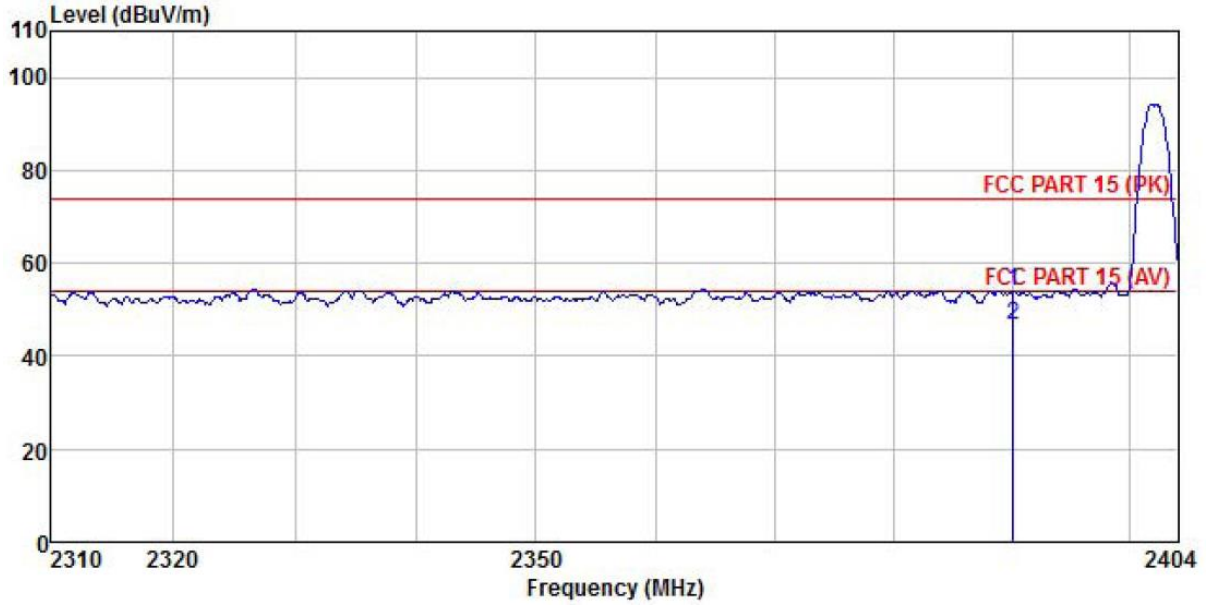

| | Read | Antenna | Cable | Preamp | Level | Limit | Over | |
|---|----------|---------|--------|--------|--------|--------|--------|---------------|
| | Freq | Level | Factor | Loss | Factor | Line | Limit | Remark |
| | MHz | dBuV | dB/m | dB | dB | dBuV/m | dBuV/m | dB |
| 1 | 2390.000 | 20.49 | 27.07 | 4.69 | 0.00 | 53.93 | 74.00 | -20.07 Peak |
| 2 | 2390.000 | 13.04 | 27.07 | 4.69 | 0.00 | 46.48 | 54.00 | -7.52 Average |

Remark:

1. Final Level = Receiver Read level + Antenna Factor + Cable Loss – Preamplifier Factor.
2. The emission levels of other frequencies are lower than the limit 20dB and not show in test report.

| | | | |
|----------------------|----------------|-----------------------|---------------------------|
| Product Name: | Smart phone | Product Model: | A7 Pro |
| Test By: | YT | Test mode: | BLE Tx mode |
| Test Channel: | Lowest channel | Polarization: | Horizontal |
| Test Voltage: | AC 120/60Hz | Environment: | Temp: 24°C Huni: 57% |

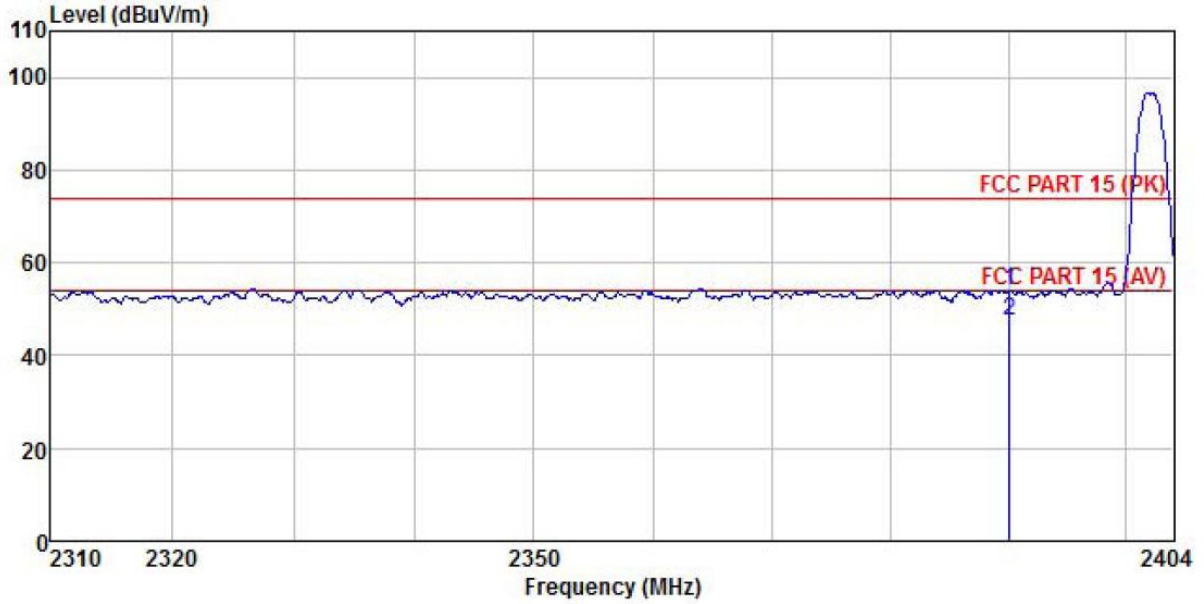

| | Read | Antenna | Cable | Preamp | Limit | Over | | |
|------|----------|---------|-------|--------|--------|--------|--------|---------------|
| Freq | Level | Factor | Loss | Factor | Line | Limit | Remark | |
| MHz | dBuV | dB/m | dB | dB | dBuV/m | dBuV/m | dB | |
| 1 | 2390.000 | 20.47 | 27.08 | 4.69 | 0.00 | 53.92 | 74.00 | -20.08 Peak |
| 2 | 2390.000 | 13.95 | 27.08 | 4.69 | 0.00 | 47.40 | 54.00 | -6.60 Average |

Remark:

- Final Level = Receiver Read level + Antenna Factor + Cable Loss – Preamplifier Factor.
- The emission levels of other frequencies are lower than the limit 20dB and not show in test report.

| | | | |
|----------------------|-----------------|-----------------------|----------------------|
| Product Name: | Smart phone | Product Model: | A7 Pro |
| Test By: | YT | Test mode: | BLE Tx mode |
| Test Channel: | Highest channel | Polarization: | Vertical |
| Test Voltage: | AC 120/60Hz | Environment: | Temp: 24°C Humi: 57% |

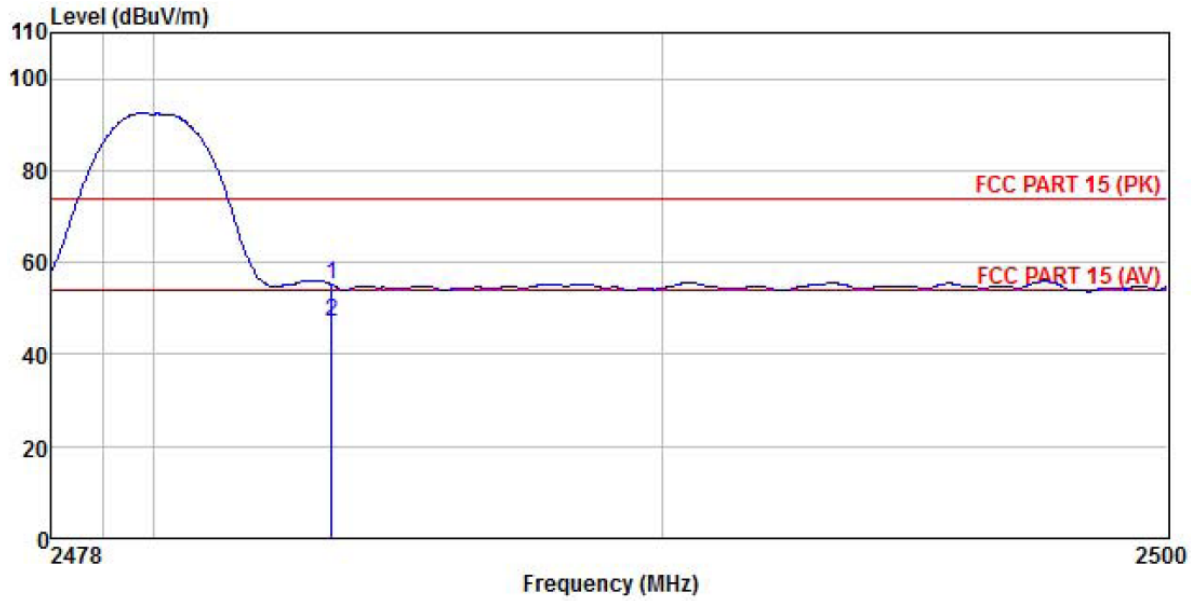

| | Read Freq | Antenna Level | Antenna Factor | Cable Loss | Preamp Factor | Level | Limit Line | Over Limit | Remark |
|---|-----------|---------------|----------------|------------|---------------|--------|------------|------------|---------|
| | MHz | dBuV | dB/m | dB | dB | dBuV/m | dBuV/m | dB | |
| 1 | 2483.500 | 21.27 | 27.36 | 4.81 | 0.00 | 55.14 | 74.00 | -18.86 | Peak |
| 2 | 2483.500 | 13.22 | 27.36 | 4.81 | 0.00 | 47.09 | 54.00 | -6.91 | Average |

Remark:

1. Final Level = Receiver Read level + Antenna Factor + Cable Loss – Pre-amplifier Factor.
2. The emission levels of other frequencies are lower than the limit 20dB and not show in test report.

| | | | |
|----------------------|-----------------|-----------------------|---------------------------|
| Product Name: | Smart phone | Product Model: | A7 Pro |
| Test By: | YT | Test mode: | BLE Tx mode |
| Test Channel: | Highest channel | Polarization: | Horizontal |
| Test Voltage: | AC 120/60Hz | Environment: | Temp: 24°C Huni: 57% |

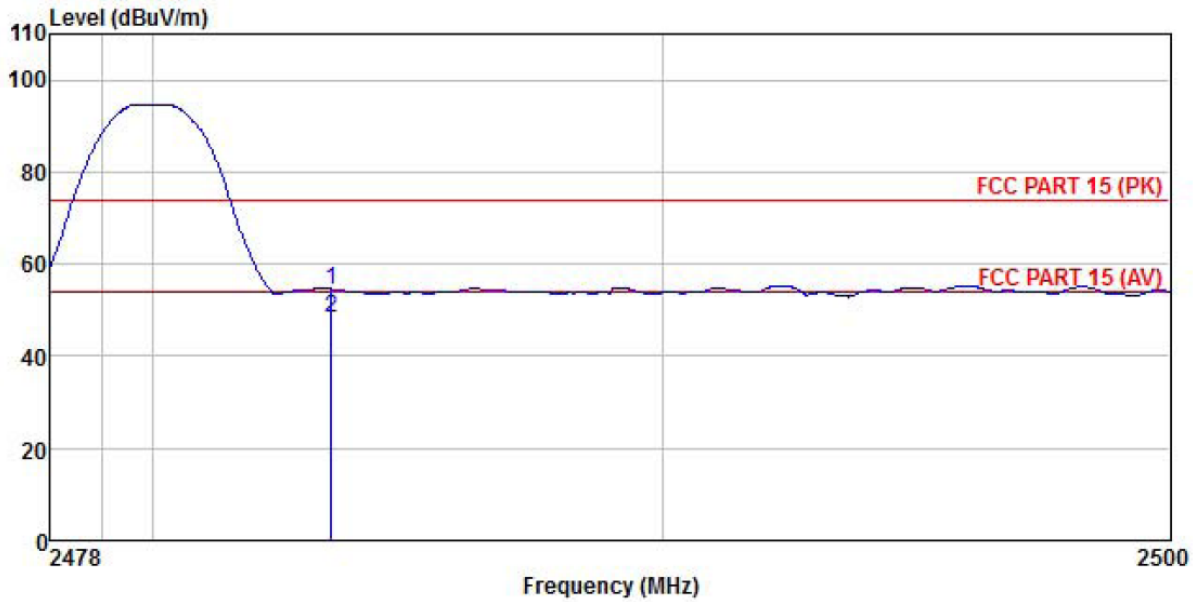

| | Read | Antenna | Cable | Preamp | Limit | Over | |
|------|----------|---------|-------|--------|--------|--------|---------------------|
| Freq | Level | Factor | Loss | Factor | Level | Line | Limit Remark |
| MHz | dBuV | dB/m | dB | dB | dBuV/m | dBuV/m | dB |
| 1 | 2483.500 | 20.72 | 27.35 | 4.81 | 0.00 | 54.58 | 74.00 -19.42 Peak |
| 2 | 2483.500 | 14.45 | 27.35 | 4.81 | 0.00 | 48.31 | 54.00 -5.69 Average |

Remark:

1. Final Level = Receiver Read level + Antenna Factor + Cable Loss – Pre-amplifier Factor.
2. The emission levels of other frequencies are lower than the limit 20dB and not show in test report.

6.7 Spurious Emission

6.7.1 Conducted Emission Method

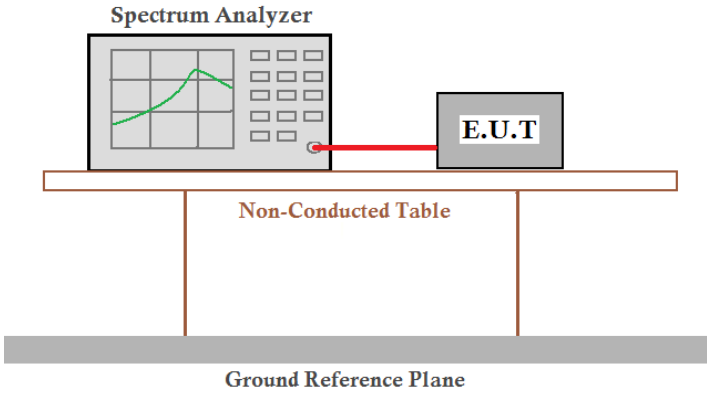
| | |
|-------------------|---|
| Test Requirement: | FCC Part 15 C Section 15.247 (d) |
| Limit: | In any 100 kHz bandwidth outside the frequency band in which the spread spectrum intentional radiator is operating, the radio frequency power that is produced by the intentional radiator shall be at least 20 dB below that in the 100 kHz bandwidth within the band that contains the highest level of the desired power, based on either an RF conducted or a radiated measurement. |
| Test setup: |  <p>The diagram illustrates the test setup. A Spectrum Analyzer is connected to an E.U.T. (Equipment Under Test) via a red cable. Both the Spectrum Analyzer and the E.U.T. are placed on a Non-Conducted Table. The table is supported by two legs and sits on a Ground Reference Plane.</p> |
| Test Instruments: | Refer to section 5.9 for details |
| Test mode: | Refer to section 5.3 for details |
| Test results: | Passed |

Test plot as follows:

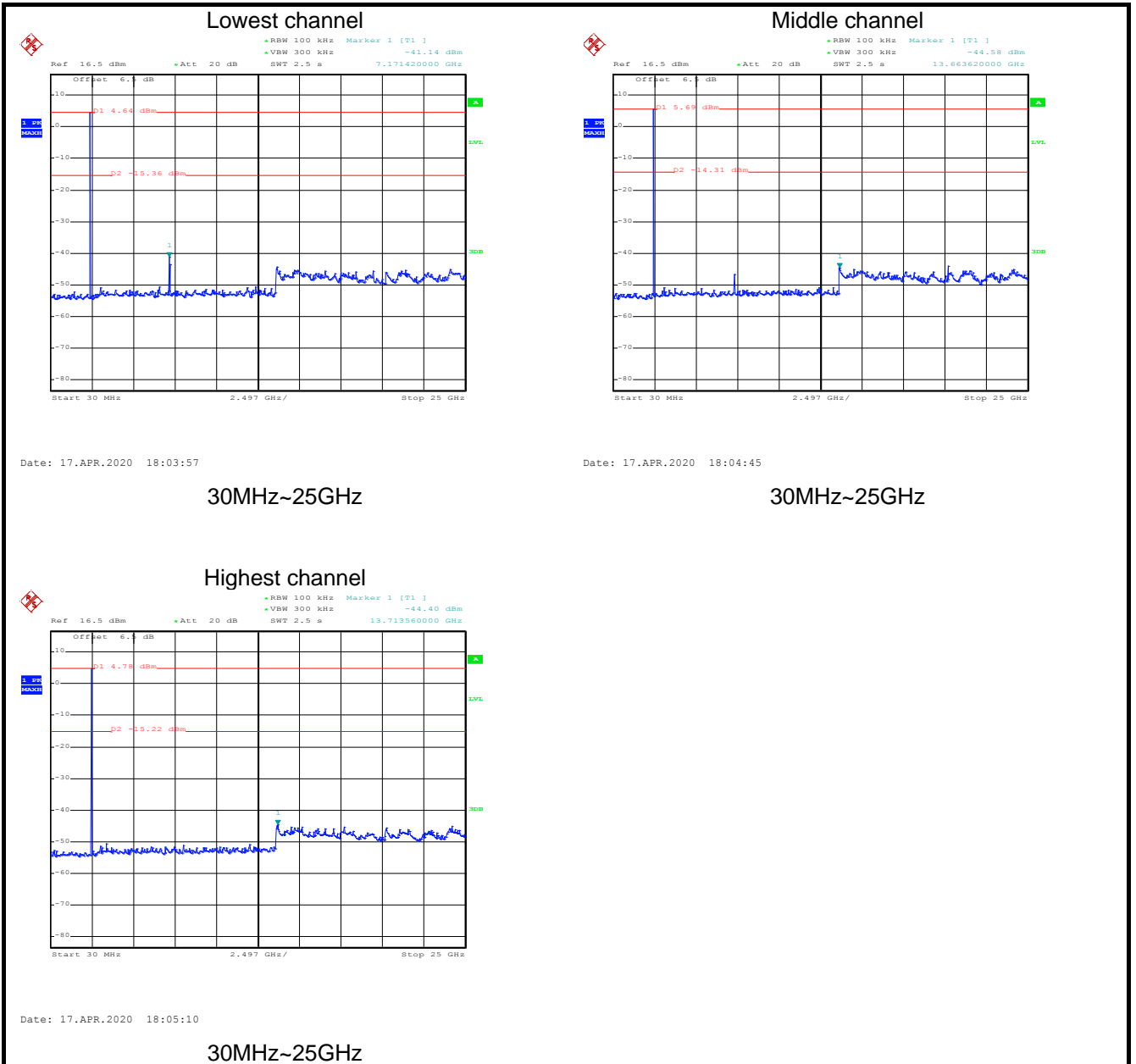

6.7.2 Radiated Emission Method

| | | | | | |
|-----------------------|--|--------------------|--------|------------------|------------------|
| Test Requirement: | FCC Part 15 C Section 15.205 and 15.209 | | | | |
| Test Frequency Range: | 9kHz to 25GHz | | | | |
| Test Distance: | 3m | | | | |
| Receiver setup: | Frequency | Detector | RBW | VBW | Remark |
| | 30MHz-1GHz | Quasi-peak | 120KHz | 300KHz | Quasi-peak Value |
| | Above 1GHz | Peak | 1MHz | 3MHz | Peak Value |
| RMS | | 1MHz | 3MHz | Average Value | |
| Limit: | Frequency | Limit (dBuV/m @3m) | | Remark | |
| | 30MHz-88MHz | 40.0 | | Quasi-peak Value | |
| | 88MHz-216MHz | 43.5 | | Quasi-peak Value | |
| | 216MHz-960MHz | 46.0 | | Quasi-peak Value | |
| | 960MHz-1GHz | 54.0 | | Quasi-peak Value | |
| | Above 1GHz | 54.0 | | Average Value | |
| 74.0 | | Peak Value | | | |
| Test Procedure: | <ol style="list-style-type: none"> 1. The EUT was placed on the top of a rotating table 0.8m(below 1GHz)/1.5m(above 1GHz) above the ground at a 3 meter camber. The table was rotated 360 degrees to determine the position of the highest radiation. 2. The EUT was set 3 meters away from the interference-receiving antenna, which was mounted on the top of a variable-height antenna tower. 3. The antenna height is varied from one meter to four meters above the ground to determine the maximum value of the field strength. Both horizontal and vertical polarizations of the antenna are set to make the measurement. 4. For each suspected emission, the EUT was arranged to its worst case and then the antenna was tuned to heights from 1 meter to 4 meters and the rota table was turned from 0 degrees to 360 degrees to find the maximum reading. 5. The test-receiver system was set to Peak Detect Function and Specified Bandwidth with Maximum Hold Mode. 6. If the emission level of the EUT in peak mode was 10 dB lower than the limit specified, then testing could be stopped and the peak values of the EUT would be reported. Otherwise the emissions that did not have 10 dB margin would be re-tested one by one using peak, quasi-peak or average method as specified and then reported in a data sheet. | | | | |
| Test setup: | <p>Below 1GHz</p> <p>Above 1GHz</p> | | | | |

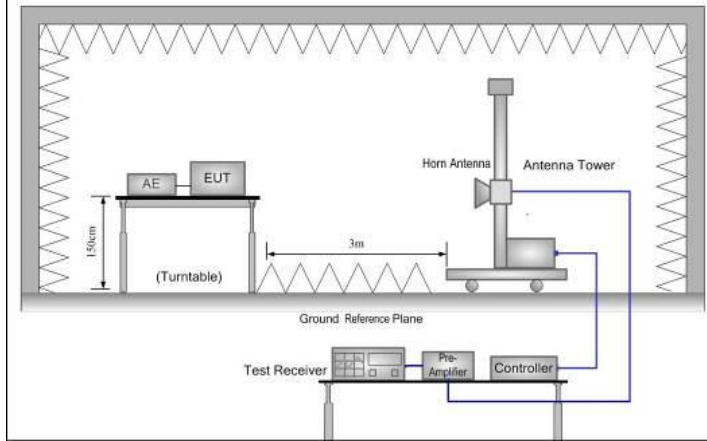

| | |
|-------------------|---|
| Test Instruments: | Refer to section 5.9 for details |
| Test mode: | Refer to section 5.3 for details |
| Test results: | Passed |
| Remark: | <ol style="list-style-type: none"> 1. Pre-scan all kind of the place mode (X-axis, Y-axis, Z-axis), and found the Y-axis is the worst case. 2. 9 kHz to 30MHz is lower than the limit 20dB, so only shows the data of above 30MHz in this report. |

Measurement Data (worst case):

Below 1GHz:

| | | | |
|------------------------|----------------|-----------------------|---------------------------|
| Product Name: | Smart phone | Product Model: | A7 Pro |
| Test By: | YT | Test mode: | BLE Tx mode |
| Test Frequency: | 30 MHz ~ 1 GHz | Polarization: | Vertical |
| Test Voltage: | AC 120/60Hz | Environment: | Temp: 24°C Humi: 57% |

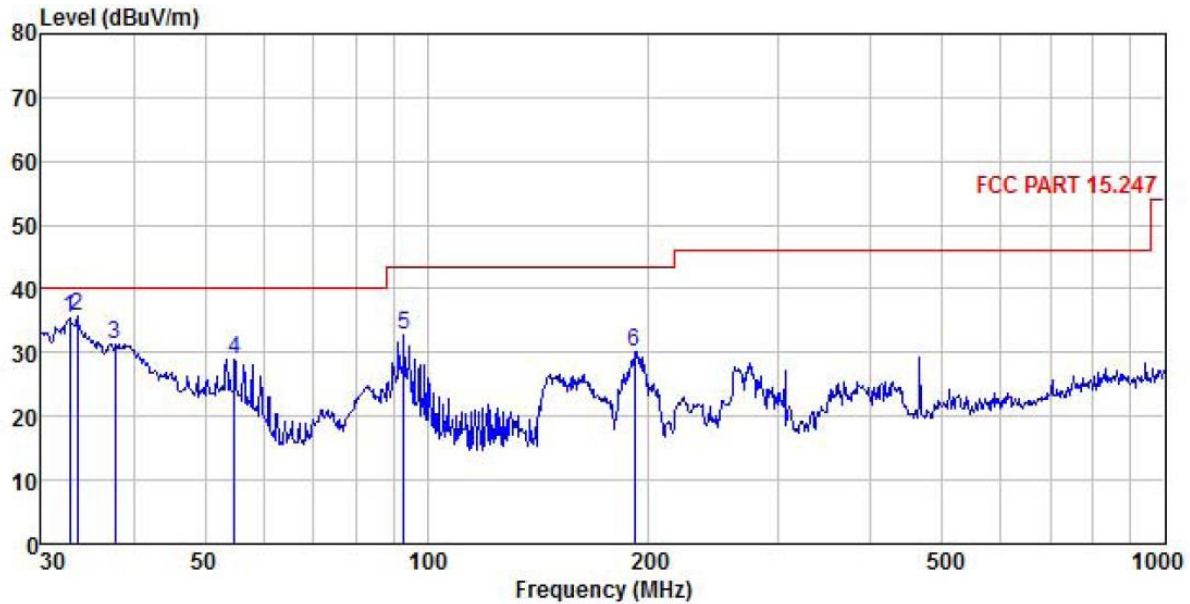

| | Read Freq | Antenna Level | Antenna Factor | Cable Loss | Preamp Factor | Level | Limit Line | Over Limit | Remark |
|---|-----------|---------------|----------------|------------|---------------|--------|------------|------------|--------|
| | MHz | dBuV | dB/m | dB | dB | dBuV/m | dBuV/m | dB | |
| 1 | 32.749 | 53.49 | 10.94 | 0.91 | 29.96 | 35.38 | 40.00 | -4.62 | QP |
| 2 | 33.562 | 53.51 | 11.04 | 0.98 | 29.96 | 35.57 | 40.00 | -4.43 | QP |
| 3 | 37.812 | 48.14 | 11.88 | 1.14 | 29.92 | 31.24 | 40.00 | -8.76 | QP |
| 4 | 54.835 | 45.90 | 11.60 | 1.36 | 29.80 | 29.06 | 40.00 | -10.94 | QP |
| 5 | 93.113 | 49.30 | 10.87 | 2.02 | 29.56 | 32.63 | 43.50 | -10.87 | QP |
| 6 | 191.074 | 45.87 | 10.33 | 2.81 | 28.89 | 30.12 | 43.50 | -13.38 | QP |

Remark:

1. Final Level = Receiver Read level + Antenna Factor + Cable Loss – Pre-amplifier Factor.
2. The emission levels of other frequencies are lower than the limit 20dB and not show in test report.

| | | | |
|------------------------|----------------|-----------------------|----------------------|
| Product Name: | Smart phone | Product Model: | A7 Pro |
| Test By: | YT | Test mode: | BLE Tx mode |
| Test Frequency: | 30 MHz ~ 1 GHz | Polarization: | Horizontal |
| Test Voltage: | AC 120/60Hz | Environment: | Temp: 24°C Humi: 57% |

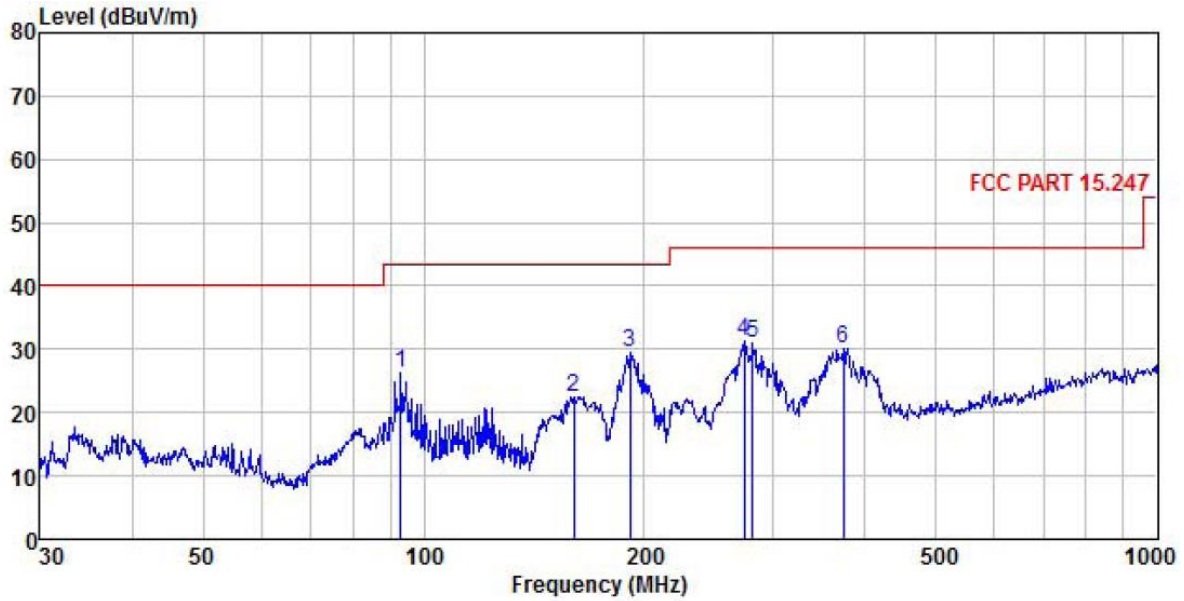

| | ReadAntenna | Cable Preamp | Limit | Over | | | | | |
|------|-------------|--------------|-------|--------|--------|-------|-------|--------|----|
| Freq | Level | Factor | Loss | Factor | Level | | | | |
| MHz | dBuV | dB/m | dB | dB | dBuV/m | | | | |
| 1 | 93.113 | 42.87 | 10.87 | 2.02 | 29.56 | 26.20 | 43.50 | -17.30 | QP |
| 2 | 160.346 | 39.78 | 9.29 | 2.59 | 29.13 | 22.53 | 43.50 | -20.97 | QP |
| 3 | 191.074 | 45.33 | 10.33 | 2.81 | 28.89 | 29.58 | 43.50 | -13.92 | QP |
| 4 | 273.234 | 43.75 | 13.14 | 2.87 | 28.50 | 31.26 | 46.00 | -14.74 | QP |
| 5 | 281.008 | 43.35 | 13.29 | 2.89 | 28.48 | 31.05 | 46.00 | -14.95 | QP |
| 6 | 373.311 | 40.86 | 14.93 | 3.09 | 28.66 | 30.22 | 46.00 | -15.78 | QP |

Remark:

- Final Level = Receiver Read level + Antenna Factor + Cable Loss – Preamplifier Factor.
- The emission levels of other frequencies are lower than the limit 20dB and not show in test report.

Above 1GHz

| Test channel: Lowest channel | | | | | | | | | |
|---|-------------------|-----------------------|-----------------|-----------------|--------------------|----------------|---------------------|-----------------|--------------|
| Detector: Peak Value | | | | | | | | | |
| Frequency (MHz) | Read Level (dBuV) | Antenna Factor (dB/m) | Cable Loss (dB) | Aux Factor (dB) | Preamp Factor (dB) | Level (dBuV/m) | Limit Line (dBuV/m) | Over Limit (dB) | Polarization |
| 4804.00 | 46.05 | 31.02 | 6.80 | 2.44 | 41.81 | 42.06 | 74.00 | -31.94 | Vertical |
| 4804.00 | 47.19 | 31.02 | 6.80 | 2.44 | 41.81 | 43.20 | 74.00 | -30.80 | Horizontal |
| Detector: Average Value | | | | | | | | | |
| Frequency (MHz) | Read Level (dBuV) | Antenna Factor (dB/m) | Cable Loss (dB) | Aux Factor (dB) | Preamp Factor (dB) | Level (dBuV/m) | Limit Line (dBuV/m) | Over Limit (dB) | Polarization |
| 4804.00 | 39.11 | 31.02 | 6.80 | 2.44 | 41.81 | 35.12 | 54.00 | -18.88 | Vertical |
| 4804.00 | 40.29 | 31.02 | 6.80 | 2.44 | 41.81 | 36.30 | 54.00 | -17.70 | Horizontal |
| Test channel: Middle channel | | | | | | | | | |
| Detector: Peak Value | | | | | | | | | |
| Frequency (MHz) | Read Level (dBuV) | Antenna Factor (dB/m) | Cable Loss (dB) | Aux Factor (dB) | Preamp Factor (dB) | Level (dBuV/m) | Limit Line (dBuV/m) | Over Limit (dB) | Polarization |
| 4884.00 | 47.52 | 31.18 | 6.86 | 2.47 | 41.84 | 43.72 | 74.00 | -30.28 | Vertical |
| 4884.00 | 48.59 | 31.18 | 6.86 | 2.47 | 41.84 | 44.79 | 74.00 | -29.21 | Horizontal |
| Detector: Average Value | | | | | | | | | |
| Frequency (MHz) | Read Level (dBuV) | Antenna Factor (dB/m) | Cable Loss (dB) | Aux Factor (dB) | Preamp Factor (dB) | Level (dBuV/m) | Limit Line (dBuV/m) | Over Limit (dB) | Polarization |
| 4884.00 | 40.26 | 31.18 | 6.86 | 2.47 | 41.84 | 36.46 | 54.00 | -17.54 | Vertical |
| 4884.00 | 39.91 | 31.18 | 6.86 | 2.47 | 41.84 | 36.11 | 54.00 | -17.89 | Horizontal |
| Test channel: Highest channel | | | | | | | | | |
| Detector: Peak Value | | | | | | | | | |
| Frequency (MHz) | Read Level (dBuV) | Antenna Factor (dB/m) | Cable Loss (dB) | Aux Factor (dB) | Preamp Factor (dB) | Level (dBuV/m) | Limit Line (dBuV/m) | Over Limit (dB) | Polarization |
| 4960.00 | 48.52 | 31.32 | 6.91 | 2.49 | 41.87 | 44.88 | 74.00 | -29.12 | Vertical |
| 4960.00 | 47.21 | 31.32 | 6.91 | 2.49 | 41.87 | 43.57 | 74.00 | -30.43 | Horizontal |
| Detector: Average Value | | | | | | | | | |
| Frequency (MHz) | Read Level (dBuV) | Antenna Factor (dB/m) | Cable Loss (dB) | Aux Factor (dB) | Preamp Factor (dB) | Level (dBuV/m) | Limit Line (dBuV/m) | Over Limit (dB) | Polarization |
| 4960.00 | 39.60 | 31.32 | 6.91 | 2.49 | 41.87 | 35.96 | 54.00 | -18.04 | Vertical |
| 4960.00 | 40.87 | 31.32 | 6.91 | 2.49 | 41.87 | 37.23 | 54.00 | -16.77 | Horizontal |
| <i>Remark:</i> | | | | | | | | | |
| 1. <i>Final Level = Receiver Read level + Antenna Factor + Cable Loss + Aux Factor – Preamplifier Factor.</i> | | | | | | | | | |
| 2. <i>The emission levels of other frequencies are lower than the limit 20dB and not show in test report.</i> | | | | | | | | | |