



**中认信通**  
CHINA CERTIFICATION ICT CO., LTD (DONGGUAN)



## SAR TEST REPORT

**Applicant:** Shenzhen Youmi Intelligent Technology Co., Ltd

**Address:** 406-407 Jinqi Zhigu Building, 4/F, 1 Tangling Road, Nanshan District, Shenzhen City, China

**FCC ID:** 2ATZ4-G5AC

**Product Name:** Smart phone

**Tested Model:** G5

**Standard(s):** 47 CFR Part 2(2.1093)

The above equipment has been tested and found compliant with the requirement of the relative standards by China Certification ICT Co., Ltd (Dongguan)

**Report Number:** CR230635481-20A

**Date Of Issue:** 2023-07-08

**Reviewed By:** Karl Gong

*Karl Gong*

**Title:** SAR Engineer

**Test Laboratory:** China Certification ICT Co., Ltd (Dongguan)

No. 113, Pingkang Road, Dalang Town, Dongguan,  
Guangdong, China  
Tel: +86-769-82016888

## SAR TEST RESULTS SUMMARY

Operation Frequency Bands	Highest Reported 1g SAR (W/kg)		Limits (W/kg)	
	Head SAR	Body SAR (Gap 10mm)		
<b>GSM 850</b>	0.17	0.22	<b>1.6</b>	
<b>PCS 1900</b>	0.90	0.30		
<b>WCDMA Band 2</b>	1.06	0.37		
<b>WCDMA Band 5</b>	0.19	0.24		
<b>LTE Band 2</b>	<b>1.12</b>	0.60		
<b>LTE Band 5</b>	0.24	0.33		
<b>LTE Band 7</b>	0.39	<b>1.12</b>		
<b>LTE Band 12</b>	0.17	0.25		
<b>LTE Band 41</b>	0.24	0.58		
<b>WLAN 2.4G</b>	0.21	0.06		
<b>WLAN 5.2G</b>	0.92	0.30		
<b>WLAN 5.8G</b>	0.42	0.19		
Maximum Simultaneous Transmission SAR				
Items	Head	Body-Worn (Gap 10mm)	Hotspot (Gap 10mm)	Limits
Sum SAR(W/kg)	<b>1.54</b>	<b>1.32</b>	<b>1.32</b>	<b>1.6</b>
SPLSR	/	/	/	0.04
EUT Received Date:	2023/06/25			
Tested Date:	2023/06/30~2023/07/04			
Tested Result:	Pass			

## Test Facility

The Test site used by China Certification ICT Co., Ltd (Dongguan) to collect test data is located on the No. 113, Pingkang Road, Dalang Town, Dongguan, Guangdong, China.

The lab has been recognized as the FCC accredited lab under the KDB 974614 D01 and is listed in the FCC Public Access Link (PAL) database, FCC Registration No. : 442868, the FCC Designation No. : CN1314.

The lab has been recognized by Innovation, Science and Economic Development Canada to test to Canadian radio equipment requirements, the CAB identifier: CN0123.

## Declarations

China Certification ICT Co., Ltd (Dongguan) is not responsible for the authenticity of any test data provided by the applicant. Data included from the applicant that may affect test results are marked with a triangle symbol “▲”. Customer model name, addresses, names, trademarks etc. are not considered data.

Unless otherwise stated the results shown in this test report refer only to the sample(s) tested.

This report cannot be reproduced except in full, without prior written approval of the Company.

This report is valid only with a valid digital signature. The digital signature may be available only under the Adobe software above version 7.0.

This report may contain data that are not covered by the accreditation scope and shall be marked with an asterisk “★”.

## CONTENTS

<b>SAR TEST RESULTS SUMMARY .....</b>	<b>2</b>
<b>TEST FACILITY .....</b>	<b>3</b>
<b>DECLARATIONS.....</b>	<b>3</b>
<b>DOCUMENT REVISION HISTORY .....</b>	<b>6</b>
<b>1. GENERAL INFORMATION .....</b>	<b>7</b>
<b>1.1 PRODUCT DESCRIPTION FOR EQUIPMENT UNDER TEST (EUT) .....</b>	<b>7</b>
<b>1.2 TEST SPECIFICATION, METHODS AND PROCEDURES .....</b>	<b>8</b>
<b>1.3 SAR LIMITS .....</b>	<b>9</b>
<b>2. SAR MEASUREMENT SYSTEM .....</b>	<b>10</b>
<b>3. EQUIPMENT LIST AND CALIBRATION .....</b>	<b>17</b>
<b>3.1 EQUIPMENTS LIST &amp; CALIBRATION INFORMATION .....</b>	<b>17</b>
<b>4. SAR MEASUREMENT SYSTEM VERIFICATION .....</b>	<b>18</b>
<b>4.1 LIQUID VERIFICATION .....</b>	<b>18</b>
<b>4.2 SYSTEM ACCURACY VERIFICATION .....</b>	<b>23</b>
<b>4.3 SAR SYSTEM VALIDATION DATA.....</b>	<b>24</b>
<b>5. EUT TEST STRATEGY AND METHODOLOGY .....</b>	<b>31</b>
<b>5.1 TEST POSITIONS FOR DEVICE OPERATING NEXT TO A PERSON'S EAR .....</b>	<b>31</b>
<b>5.2 CHEEK/TOUCH POSITION.....</b>	<b>32</b>
<b>5.3 EAR/TILT POSITION.....</b>	<b>32</b>
<b>5.4 TEST POSITIONS FOR BODY-WORN AND OTHER CONFIGURATIONS .....</b>	<b>33</b>
<b>5.5 TEST DISTANCE FOR SAR EVALUATION.....</b>	<b>34</b>
<b>5.6 SAR EVALUATION PROCEDURE .....</b>	<b>35</b>
<b>6. CONDUCTED OUTPUT POWER MEASUREMENT .....</b>	<b>36</b>
<b>6.1 TEST PROCEDURE .....</b>	<b>36</b>
<b>6.2 DESCRIPTION OF TEST CONFIGURATION.....</b>	<b>37</b>
<b>6.3 MAXIMUM TARGET OUTPUT POWER.....</b>	<b>43</b>
<b>6.4 TEST RESULTS: .....</b>	<b>44</b>
<b>7. Standalone SAR test exclusion considerations .....</b>	<b>60</b>
<b>7.1 ANTENNA DISTANCE TO EDGE .....</b>	<b>60</b>
<b>7.2 STANDALONE SAR TEST EXCLUSION CONSIDERATIONS .....</b>	<b>61</b>
<b>7.3 STANDALONE SAR ESTIMATION: .....</b>	<b>61</b>

**7.4 SAR TEST EXCLUSION FOR THE EUT EDGE CONSIDERATIONS RESULT ..... 61**

**8. SAR MEASUREMENT RESULTS ..... 63**

**8.1 SAR TEST DATA ..... 63**

**9. Measurement Variability ..... 79**

**10. SAR SIMULTANEOUS TRANSMISSION DESCRIPTION ..... 80**

**11. SAR Plots ..... 84**

**APPENDIX A MEASUREMENT UNCERTAINTY ..... 85**

**APPENDIX B EUT TEST POSITION PHOTOS ..... 87**

**APPENDIX C CALIBRATION CERTIFICATES ..... 88**

## DOCUMENT REVISION HISTORY

Revision Number	Report Number	Description of Revision	Date of Revision
1.0	CR230635481-20A	Original Report	2023-07-08

## 1. GENERAL INFORMATION

### 1.1 Product Description for Equipment under Test (EUT)

<b>Device Type:</b>	Portable
<b>Exposure Category:</b>	Population / Uncontrolled
<b>Antenna Type(s):</b>	Internal Antenna
<b>Body-Worn Accessories:</b>	None
<b>Operation modes:</b>	GSM Voice, GPRS Data, WCDMA( R99 (Voice+Data), HSDPA/HSUPA/HSPA+), FDD-LTE, TDD-LTE, WLAN, Bluetooth
<b>Frequency Band:</b>	GSM 850: 824-849 MHz(TX); 869-894 MHz(RX) PCS 1900: 1850-1910 MHz(TX); 1930-1990 MHz(RX) WCDMA Band 2: 1850-1910 MHz(TX); 1930-1990 MHz(RX) WCDMA Band 5: 824-849 MHz(TX); 869-894 MHz(RX) LTE Band 2: 1850-1910 MHz(TX); 1930-1990 MHz(RX) LTE Band 5: 824-849 MHz(TX); 869-894 MHz(RX) LTE Band 7: 2500-2570 MHz(TX); 2620-2690 MHz(RX) LTE Band 12: 699-716 MHz(TX); 729-746 MHz(RX) LTE Band 41: 2535-2655 MHz(TX); 2535-2655 MHz(RX) WLAN 2.4G : 2412 MHz-2462 MHz/2422 MHz-2452 MHz WLAN 5.2G : 5150 MHz-5250 MHz WLAN 5.8G : 5725 MHz-5850 MHz Bluetooth : 2402 MHz-2480 MHz
<b>Conducted RF Power:</b>	GSM 850: 33.19 dBm; PCS 1900: 30.3 dBm WCDMA Band 2: 21.37 dBm; WCDMA Band 5: 23.89 dBm LTE Band 2: 20.49 dBm; LTE Band 5: 24.49 dBm LTE Band 7: 23.48 dBm; LTE Band 12: 24.03 dBm LTE Band 41: 23.83 dBm; WLAN 2.4G: 12.81 dBm WLAN 5.2G: 13.46 dBm WLAN 5.8G: 8.98 dBm Bluetooth(BDR/EDR): -1.15 dBm BLE: -0.65 dBm
<b>Dimensions (L*W*H):</b>	162 mm (L) * 75 mm (W) * 9 mm (H)
<b>Rated Input Voltage:</b>	DC 3.85 V from Rechargeable Battery
<b>Serial Number:</b>	2759-1
<b>Normal Operation:</b>	Head and Body Worn

## 1.2 Test Specification, Methods and Procedures

The tests documented in this report were performed in accordance with FCC 47 CFR § 2.1093, IEEE 1528-2013, the following FCC Published RF exposure KDB procedures:

KDB 447498 D01 General RF Exposure Guidance v06  
KDB 648474 D04 Handset SAR v01r03  
KDB 865664 D01 SAR Measurement 100 MHz to 6 GHz v01r04  
KDB 865664 D02 RF Exposure Reporting v01r02  
KDB 941225 D01 3G SAR Procedures v03r01  
KDB 941225 D05 SAR for LTE Devices v02r05  
KDB 941225 D06 Hotspot Mode v02r01  
KDB 248227 D01 802.11 Wi-Fi SAR v02r02

TCB Workshop April 2019: RF Exposure Procedures



**1.3 SAR Limits****FCC Limit**

<b>EXPOSURE LIMITS</b>	<b>SAR (W/kg)</b>	
	(General Population / Uncontrolled Exposure Environment)	(Occupational / Controlled Exposure Environment)
Spatial Average (averaged over the whole body)	0.08	0.4
Spatial Peak (averaged over any 1 g of tissue)	<b>1.60</b>	8.0
Spatial Peak (hands/wrists/feet/ankles averaged over 10 g)	4.0	20.0

Population/Uncontrolled Environments are defined as locations where there is the exposure of individual who have no knowledge or control of their exposure.

Occupational/Controlled Environments are defined as locations where there is exposure that may be incurred by people who are aware of the potential for exposure (i.e. as a result of employment or occupation).

General Population/Uncontrolled environments Spatial Peak limit 1.6W/kg for 1g SAR applied to the EUT.

## 2. SAR MEASUREMENT SYSTEM

These measurements were performed with the automated near-field scanning system DASY5 from Schmid & Partner Engineering AG (SPEAG) which is the Fifth generation of the system shown in the figure hereinafter:



### DASY5 System Description

The DASY5 system for performing compliance tests consists of the following items:

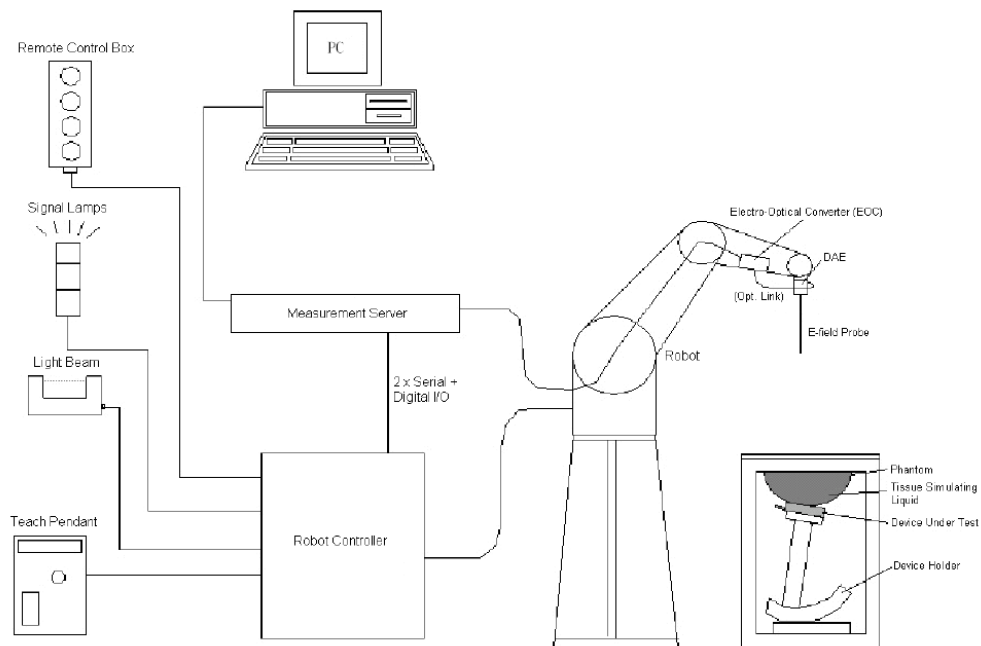

- A standard high precision 6-axis robot with controller, teach pendant and software. An arm extension for accommodating the data acquisition electronics (DAE).
- An isotropic field probe optimized and calibrated for the targeted measurement.
- A data acquisition electronics (DAE) which performs the signal application, signal multiplexing, AD-conversion, offset measurements, mechanical surface detection, collision detection, etc. The unit is battery powered with standard or rechargeable batteries. The signal is optically transmitted to the EOC.
- The Electro-optical converter (EOC) performs the conversion from optical to electrical signals for the digital communication to the DAE. To use optical surface detection, a special version of the EOC is required. The EOC signal is transmitted to the measurement server.
- The function of the measurement server is to perform the time critical tasks such as signal filtering, control of the robot operation and fast movement interrupts.
- The Light Beam used is for probe alignment. This improves the (absolute) accuracy of the probe positioning.
- A computer running Win7 professional operating system and the DASY52 software.
- Remote control and teach pendant as well as additional circuitry for robot safety such as warning lamps, etc.
- The phantom, the device holder and other accessories according to the targeted measurement.

### **DASY5 Measurement Server**

The DASY5 measurement server is based on a PC/104 CPU board with a 400MHz Intel ULV Celeron, 128MB chip-disk and 128MB RAM. The necessary circuits for communication with the DAE4 (or DAE3) electronics box, as well as the 16 bit AD-converter system for optical detection and digital I/O interface are contained on the DASY5 I/O board, which is directly connected to the PC/104 bus of the CPU board.



The measurement server performs all real-time data evaluation of field measurements and surface detection, controls robot movements and handles safety operation. The PC operating system cannot interfere with these time critical processes. All connections are supervised by a watchdog, and disconnection of any of the cables to the measurement server will automatically disarm the robot and disable all program-controlled robot movements. Furthermore, the measurement server is equipped with an expansion port which is reserved for future applications. Please note that this expansion port does not have a standardized point out, and therefore only devices provided by SPEAG can be connected. Devices from any other supplier could seriously damage the measurement server.

### **Data Acquisition Electronics**

The data acquisition electronics (DAE4) consist of a highly sensitive electrometer-grade preamplifier with auto-zeroing, a channel and gain-switching multiplexer, a fast 16 bit AD-converter and a command decoder with a control logic unit. Transmission to the measurement server is accomplished through an optical downlink for data and status information, as well as an optical uplink for commands and the clock.

The mechanical probe mounting device includes two different sensor systems for frontal and sideways probe contacts. They are used for mechanical surface detection and probe collision detection.

The input impedance of both the DAE4 as well as of the DAE3 box is 200M $\Omega$ ; the inputs are symmetrical and floating. Common mode rejection is above 80 dB.

**EX3DV4 E-Field Probes**

<b>Frequency</b>	10 MHz to > 6 GHz Linearity: $\pm 0.2$ dB (30 MHz to 6 GHz)
<b>Directivity</b>	$\pm 0.3$ dB in TSL (rotation around probe axis) $\pm 0.5$ dB in TSL (rotation normal to probe axis)
<b>Dynamic Range</b>	10 $\mu$ W/g to > 100 mW/g Linearity: $\pm 0.2$ dB (noise: typically < 1 $\mu$ W/g)
<b>Dimensions</b>	Overall length: 337 mm (Tip: 20 mm) Tip diameter: 2.5 mm (Body: 12 mm) Typical distance from probe tip to dipole centers: 1 mm
<b>Application</b>	High precision dosimetric measurements in any exposure scenario (e.g., very strong gradient fields); the only probe that enables compliance testing for frequencies up to 6 GHz with precision of better 30%.
<b>Compatibility</b>	DASY3, DASY4, DASY52 SAR and higher, EASY4/MRI

**Calibration Frequency Points for EX3DV4 E-Field Probes SN: 7522 Calibrated: 2023/5/29**

Calibration Frequency Point(MHz)	Frequency Range(MHz)		Conversion Factor		
	From	To	X	Y	Z
750 Head	650	850	9.9	9.9	9.9
900 Head	850	1000	9.37	9.37	9.37
1750 Head	1650	1850	8.15	8.15	8.15
1900 Head	1850	2000	7.94	7.94	7.94
2300 Head	2200	2400	7.67	7.67	7.67
2450 Head	2400	2550	7.42	7.42	7.42
2600 Head	2550	2700	7.23	7.23	7.23
5250 Head	5140	5360	5.36	5.36	5.36
5500 Head	5390	5610	4.85	4.85	4.85
5750 Head	5640	5860	4.9	4.9	4.9

### SAM Twin Phantom

The SAM twin phantom is a fiberglass shell phantom with 2mm shell thickness (except the ear region, where shell thickness increases to 6 mm). The phantom has three measurement areas:

- \_ Left Head
- \_ Right Head
- \_ Flat phantom

The phantom table for the DASY systems based on the robots have the size of 100 x 50 x 85 cm (L x W x H). For easy dislocation these tables have fork lift cut outs at the bottom.

The bottom plate contains three pairs of bolts for locking the device holder. The device holder positions are adjusted to the standard measurement positions in the three sections. Only one device holder is necessary if two phantoms are used (e.g., for different liquids)



A white cover is provided to cover the phantom during off-periods to prevent water evaporation and changes in the liquid parameters. Free space scans of devices on top of this phantom cover are possible. Three reference marks are provided on the phantom counter. These reference marks are used to teach the absolute phantom position relative to the robot.

### Robots

The DASY5 system uses the high precision industrial robot. The robot offers the same features important for our application:

- High precision (repeatability 0.02mm)
- High reliability (industrial design)
- Low maintenance costs (virtually maintenance free due to direct drive gears; no belt drives)
- Jerk-free straight movements (brushless synchrony motors; no stepper motors)
- Low ELF interference (motor control fields shielded via the closed metallic construction shields)

The above mentioned robots are controlled by the Staubli CS8c robot controllers. All information regarding the use and maintenance of the robot arm and the robot controller is contained on the CDs delivered along with the robot. Paper manuals are available upon request direct from Staubli.

## SAR Scan Procedures

### Step 1: Power Reference Measurement

The Power Reference Measurement and Power Drift Measurements are for monitoring the power drift of the device under test in the batch process. The minimum distance of probe sensors to surface determines the closest measurement point to phantom surface. The minimum distance of probe sensors to surface is 1.4 mm. This distance cannot be smaller than the distance of sensor calibration points to probe tip as defined in the probe properties.

### Step 2: Area Scans

Area scans are defined prior to the measurement process being executed with a user defined variable spacing between each measurement point (integral) allowing low uncertainty measurements to be conducted. Scans defined for FCC applications utilize a 15mm 2 step integral, with 1.5mm interpolation used to locate the peak SAR area used for zoom scan assessments.

Where the system identifies multiple SAR peaks (which are within 25% of peak value) the system will provide the user with the option of assessing each peak location individually for zoom scan averaging.

Area Scan Parameters extracted from KDB 865664 D01 SAR Measurement 100 MHz to 6 GHz

	≤ 3 GHz	> 3 GHz
Maximum distance from closest measurement point (geometric center of probe sensors) to phantom surface	5 mm ± 1 mm	$\frac{1}{2} \cdot \delta \cdot \ln(2)$ mm ± 0.5 mm
Maximum probe angle from probe axis to phantom surface normal at the measurement location	30° ± 1°	20° ± 1°
Maximum area scan spatial resolution: $\Delta x_{Area}$ , $\Delta y_{Area}$	≤ 2 GHz: ≤ 15 mm 2 – 3 GHz: ≤ 12 mm	3 – 4 GHz: ≤ 12 mm 4 – 6 GHz: ≤ 10 mm
	When the x or y dimension of the test device, in the measurement plane orientation, is smaller than the above, the measurement resolution must be ≤ the corresponding x or y dimension of the test device with at least one measurement point on the test device.	

### Step 3: Zoom Scan (Cube Scan Averaging)

The averaging zoom scan volume utilized in the DASY5 software is in the shape of a cube and the side dimension of a 1 g or 10 g mass is dependent on the density of the liquid representing the simulated tissue. A density of 1000 kg/m<sup>3</sup> is used to represent the head and body tissue density and not the phantom liquid density, in order to be consistent with the definition of the liquid dielectric properties, i.e. the side length of the 1g cube is 10mm, with the side length of the 10g cube is 21.5mm.

Zoom Scan Parameters extracted from KDB 865664 D01 SAR Measurement 100 MHz to 6 GHz

			≤ 3 GHz	> 3 GHz
Maximum zoom scan spatial resolution: $\Delta x_{Zoom}$ , $\Delta y_{Zoom}$			≤ 2 GHz: ≤ 8 mm 2 – 3 GHz: ≤ 5 mm*	3 – 4 GHz: ≤ 5 mm* 4 – 6 GHz: ≤ 4 mm*
Maximum zoom scan spatial resolution, normal to phantom surface	uniform grid: $\Delta z_{Zoom}(n)$		≤ 5 mm	3 – 4 GHz: ≤ 4 mm 4 – 5 GHz: ≤ 3 mm 5 – 6 GHz: ≤ 2 mm
	graded grid	$\Delta z_{Zoom}(1)$ : between 1 <sup>st</sup> two points closest to phantom surface	≤ 4 mm	3 – 4 GHz: ≤ 3 mm 4 – 5 GHz: ≤ 2.5 mm 5 – 6 GHz: ≤ 2 mm
		$\Delta z_{Zoom}(n>1)$ : between subsequent points	≤ 1.5 · $\Delta z_{Zoom}(n-1)$ mm	
Minimum zoom scan volume	x, y, z	≥ 30 mm	3 – 4 GHz: ≥ 28 mm 4 – 5 GHz: ≥ 25 mm 5 – 6 GHz: ≥ 22 mm	
Note: $\delta$ is the penetration depth of a plane-wave at normal incidence to the tissue medium; see IEEE Std 1528-2013 for details.				
* When zoom scan is required and the <i>reported</i> SAR from the <i>area scan based 1-g SAR estimation</i> procedures of KDB Publication 447498 is ≤ 1.4 W/kg, ≤ 8 mm, ≤ 7 mm and ≤ 5 mm zoom scan resolution may be applied, respectively, for 2 GHz to 3 GHz, 3 GHz to 4 GHz and 4 GHz to 6 GHz.				

### Step 4: Power Drift Measurement

The Power Drift Measurement measures the field at the same location as the most recent power reference measurement within the same procedure, and with the same settings. The Power Drift Measurement gives the field difference in dB from the reading conducted within the last Power Reference Measurement. This allows a user to monitor the power drift of the device under test within a batch process. The measurement procedure is the same as Step 1.

When the cube intersects with the surface of the phantom, it is oriented so that 3 vertices touch the surface of the shell or the center of a face is tangent to the surface. The face of the cube closest to the surface is modified in order to conform to the tangent surface.

The zoom scan integer steps can be user defined so as to reduce uncertainty, but normal practice for typical test applications (including FCC) utilize a physical step of 7 x7 x 7 (5mmx5mmx5mm) providing a volume of 30 mm in the X & Y & Z axis.

### Tissue Dielectric Parameters for Head and Body Phantoms

The head tissue dielectric parameters recommended by the IEC 62209-1:2016

#### Recommended Tissue Dielectric Parameters for Head liquid

**Table A.3 – Dielectric properties of the head tissue-equivalent liquid**

Frequency MHz	Relative permittivity $\epsilon_r$	Conductivity ( $\sigma$ ) S/m
300	45,3	0,87
450	43,5	0,87
<i>750</i>	<i>41,9</i>	<i>0,89</i>
835	41,5	0,90
900	41,5	0,97
1 450	40,5	1,20
<i>1 500</i>	<i>40,4</i>	<i>1,23</i>
<i>1 640</i>	<i>40,2</i>	<i>1,31</i>
<i>1 750</i>	<i>40,1</i>	<i>1,37</i>
1 800	40,0	1,40
1 900	40,0	1,40
2 000	40,0	1,40
<i>2 100</i>	<i>39,8</i>	<i>1,49</i>
<i>2 300</i>	<i>39,5</i>	<i>1,67</i>
2 450	39,2	1,80
<i>2 600</i>	<i>39,0</i>	<i>1,96</i>
3 000	38,5	2,40
<i>3 500</i>	<i>37,9</i>	<i>2,91</i>
<i>4 000</i>	<i>37,4</i>	<i>3,43</i>
<i>4 500</i>	<i>36,8</i>	<i>3,94</i>
<i>5 000</i>	<i>36,2</i>	<i>4,45</i>
<i>5 200</i>	<i>36,0</i>	<i>4,66</i>
<i>5 400</i>	<i>35,8</i>	<i>4,86</i>
<i>5 600</i>	<i>35,5</i>	<i>5,07</i>
<i>5 800</i>	<i>35,3</i>	<i>5,27</i>
<i>6 000</i>	<i>35,1</i>	<i>5,48</i>

NOTE For convenience, permittivity and conductivity values at those frequencies which are not part of the original data provided by Drossos et al. [33] or the extension to 5 800 MHz are provided (i.e. the values shown *in italics*). These values were linearly interpolated between the values in this table that are immediately above and below these values, except the values at 6 000 MHz that were linearly extrapolated from the values at 3 000 MHz and 5 800 MHz.



### 3. EQUIPMENT LIST AND CALIBRATION

#### 3.1 Equipments List & Calibration Information

Equipment	Model	S/N	Calibration Date	Calibration Due Date
DASY5 Test Software	DASY52.10	N/A	NCR	NCR
DASY5 Measurement Server	DASY5 4.5.12	1567	NCR	NCR
Data Acquisition Electronics	DAE4	1493	2023/3/17	2024/3/16
E-Field Probe	EX3DV4	7522	2023/5/29	2024/5/28
Mounting Device	MD4HHTV5	BJPCTC0152	NCR	NCR
Twin SAM	Twin SAM V5.0	1470	NCR	NCR
Dipole, 750 MHz	D750V3	1230	2023/3/24	2026/3/23
Dipole, 1900 MHz	D1900V2	5d251	2023/3/27	2026/3/26
Dipole, 2450 MHz	D2450V2	1102	2023/3/27	2026/3/26
Dipole, 2600 MHz	D2600V2	1206	2023/3/27	2026/3/26
Dipole,5GHz	D5GHzV2	1246	2022/11/1	2025/10/31
Simulated Tissue Liquid Head(500-9500 MHz)	HBBL600-10000V6	220420-2	Each Time	/
Network Analyzer	8753B	2828A00170	2022/10/24	2023/10/23
Dielectric assessment kit	1253	SM DAK 040 CA	NCR	NCR
MXG Vector Signal Generator	N5182B	MY51350144	2022/7/15	2023/7/14
USB Wideband Power Sensor	U2021XA	MY54080015	2022/7/15	2023/7/14
Power Amplifier	ZVA-183-S+	5969001149	NCR	NCR
Directional Coupler	441493	520Z	NCR	NCR
Attenuator	20dB, 100W	LN749	NCR	NCR
Attenuator	6dB, 150W	2754	NCR	NCR
Universal Radio Communication Tester	CMU200	110 825	2022/07/15	2023/07/14
Wideband Radio Communication Tester	CMW500	149218	2022/07/15	2023/07/14

## 4. SAR MEASUREMENT SYSTEM VERIFICATION

### 4.1 Liquid Verification

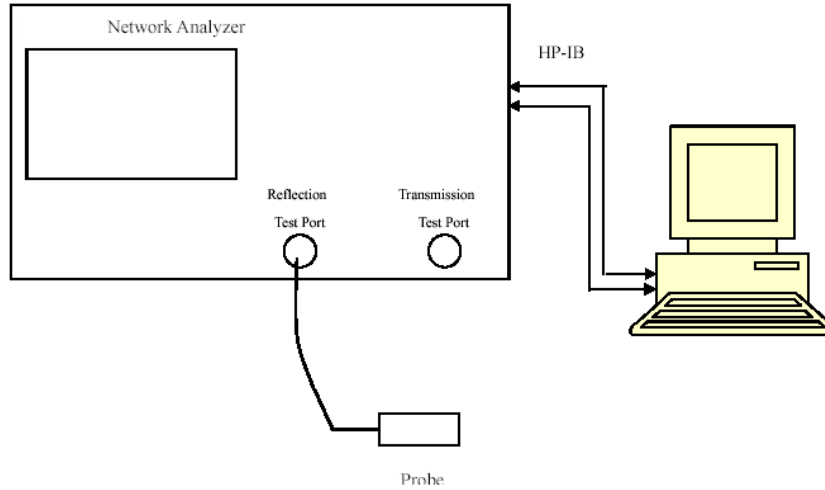

Liquid Verification Setup Block Diagram

### Liquid Verification Results

Frequency (MHz)	Liquid Type	Liquid		Target Value		Delta(%)		Tolerance (%)
		$\epsilon_r$	$\sigma$	$\epsilon_r$	$\sigma$ (S/m)	$\Delta \epsilon_r$	$\Delta \sigma$	
650	Simulated Tissue Liquid Head	43.252	0.854	42.43	0.88	1.94	-2.95	$\pm 5$
660	Simulated Tissue Liquid Head	43.222	0.863	42.38	0.88	1.99	-1.93	$\pm 5$
670	Simulated Tissue Liquid Head	43.196	0.873	42.33	0.88	2.05	-0.80	$\pm 5$
680	Simulated Tissue Liquid Head	43.080	0.875	42.27	0.89	1.92	-1.69	$\pm 5$
690	Simulated Tissue Liquid Head	43.058	0.877	42.22	0.89	1.98	-1.46	$\pm 5$
700	Simulated Tissue Liquid Head	43.027	0.882	42.17	0.89	2.03	-0.90	$\pm 5$
710	Simulated Tissue Liquid Head	43.004	0.884	42.11	0.89	2.12	-0.67	$\pm 5$
720	Simulated Tissue Liquid Head	42.973	0.886	42.06	0.89	2.17	-0.45	$\pm 5$
730	Simulated Tissue Liquid Head	42.942	0.891	42.01	0.89	2.22	0.11	$\pm 5$
740	Simulated Tissue Liquid Head	42.922	0.899	41.95	0.89	2.32	1.01	$\pm 5$
750	Simulated Tissue Liquid Head	42.890	0.904	41.90	0.89	2.36	1.57	$\pm 5$
760	Simulated Tissue Liquid Head	42.859	0.908	41.85	0.89	2.41	2.02	$\pm 5$
770	Simulated Tissue Liquid Head	42.820	0.910	41.81	0.89	2.42	2.25	$\pm 5$
780	Simulated Tissue Liquid Head	42.797	0.911	41.76	0.89	2.48	2.36	$\pm 5$
790	Simulated Tissue Liquid Head	42.779	0.911	41.71	0.89	2.56	2.36	$\pm 5$
800	Simulated Tissue Liquid Head	42.754	0.919	41.66	0.90	2.63	2.11	$\pm 5$
810	Simulated Tissue Liquid Head	42.683	0.921	41.62	0.90	2.55	2.33	$\pm 5$
820	Simulated Tissue Liquid Head	42.618	0.923	41.57	0.90	2.52	2.56	$\pm 5$
830	Simulated Tissue Liquid Head	42.595	0.926	41.52	0.90	2.59	2.89	$\pm 5$
840	Simulated Tissue Liquid Head	42.547	0.937	41.50	0.91	2.52	2.97	$\pm 5$
850	Simulated Tissue Liquid Head	42.536	0.941	41.50	0.92	2.50	2.28	$\pm 5$

\*Liquid Verification above was performed on 2023/07/03.

Frequency (MHz)	Liquid Type	Liquid		Target Value		Delta(%)		Tolerance (%)
		$\epsilon_r$	$\sigma$	$\epsilon_r$	$\sigma$ (S/m)	$\Delta \epsilon_r$	$\Delta \sigma$	
650	Simulated Tissue Liquid Head	43.871	0.845	42.43	0.88	3.40	-3.98	$\pm 5$
660	Simulated Tissue Liquid Head	43.724	0.852	42.38	0.88	3.17	-3.18	$\pm 5$
670	Simulated Tissue Liquid Head	43.587	0.858	42.33	0.88	2.97	-2.50	$\pm 5$
680	Simulated Tissue Liquid Head	43.454	0.864	42.27	0.89	2.80	-2.92	$\pm 5$
690	Simulated Tissue Liquid Head	43.317	0.870	42.22	0.89	2.60	-2.25	$\pm 5$
700	Simulated Tissue Liquid Head	43.177	0.876	42.17	0.89	2.39	-1.57	$\pm 5$
710	Simulated Tissue Liquid Head	43.037	0.881	42.11	0.89	2.20	-1.01	$\pm 5$
720	Simulated Tissue Liquid Head	42.898	0.887	42.06	0.89	1.99	-0.34	$\pm 5$
730	Simulated Tissue Liquid Head	42.767	0.892	42.01	0.89	1.80	0.22	$\pm 5$
740	Simulated Tissue Liquid Head	42.641	0.897	41.95	0.89	1.65	0.79	$\pm 5$
750	Simulated Tissue Liquid Head	42.506	0.901	41.90	0.89	1.45	1.24	$\pm 5$
760	Simulated Tissue Liquid Head	42.376	0.906	41.85	0.89	1.26	1.80	$\pm 5$
770	Simulated Tissue Liquid Head	42.243	0.910	41.81	0.89	1.04	2.25	$\pm 5$
780	Simulated Tissue Liquid Head	42.118	0.914	41.76	0.89	0.86	2.70	$\pm 5$
790	Simulated Tissue Liquid Head	41.986	0.918	41.71	0.89	0.66	3.15	$\pm 5$
800	Simulated Tissue Liquid Head	41.856	0.922	41.66	0.90	0.47	2.44	$\pm 5$
810	Simulated Tissue Liquid Head	41.725	0.926	41.62	0.90	0.25	2.89	$\pm 5$
820	Simulated Tissue Liquid Head	41.593	0.929	41.57	0.90	0.06	3.22	$\pm 5$
830	Simulated Tissue Liquid Head	41.470	0.932	41.52	0.90	-0.12	3.56	$\pm 5$
840	Simulated Tissue Liquid Head	41.347	0.935	41.50	0.91	-0.37	2.75	$\pm 5$
850	Simulated Tissue Liquid Head	41.233	0.938	41.50	0.92	-0.64	1.96	$\pm 5$

\*Liquid Verification above was performed on 2023/07/04.

Frequency (MHz)	Liquid Type	Liquid		Target Value		Delta(%)		Tolerance (%)
		$\epsilon_r$	O	$\epsilon_r$	O(S/m)	$\Delta \epsilon_r$	$\Delta O$	
1850	Simulated Tissue Liquid Head	39.634	1.332	40.00	1.40	-0.91	-4.86	±5
1860	Simulated Tissue Liquid Head	39.591	1.339	40.00	1.40	-1.02	-4.36	±5
1870	Simulated Tissue Liquid Head	39.547	1.348	40.00	1.40	-1.13	-3.71	±5
1880	Simulated Tissue Liquid Head	39.503	1.357	40.00	1.40	-1.24	-3.07	±5
1890	Simulated Tissue Liquid Head	39.452	1.366	40.00	1.40	-1.37	-2.43	±5
1900	Simulated Tissue Liquid Head	39.427	1.375	40.00	1.40	-1.43	-1.79	±5
1910	Simulated Tissue Liquid Head	39.385	1.384	40.00	1.40	-1.54	-1.14	±5
1920	Simulated Tissue Liquid Head	39.344	1.385	40.00	1.40	-1.64	-1.07	±5
1930	Simulated Tissue Liquid Head	39.295	1.392	40.00	1.40	-1.76	-0.57	±5
1940	Simulated Tissue Liquid Head	39.243	1.401	40.00	1.40	-1.89	0.07	±5
1950	Simulated Tissue Liquid Head	39.201	1.410	40.00	1.40	-2.00	0.71	±5
1960	Simulated Tissue Liquid Head	39.155	1.418	40.00	1.40	-2.11	1.29	±5
1970	Simulated Tissue Liquid Head	39.102	1.428	40.00	1.40	-2.25	2.00	±5
1980	Simulated Tissue Liquid Head	39.047	1.437	40.00	1.40	-2.38	2.64	±5
1990	Simulated Tissue Liquid Head	38.987	1.446	40.00	1.40	-2.53	3.29	±5
2000	Simulated Tissue Liquid Head	38.930	1.456	40.00	1.40	-2.68	4.00	±5

\*Liquid Verification above was performed on 2023/06/30.

Frequency (MHz)	Liquid Type	Liquid		Target Value		Delta(%)		Tolerance (%)
		$\epsilon_r$	O	$\epsilon_r$	O(S/m)	$\Delta \epsilon_r$	$\Delta O$	
2400	Simulated Tissue Liquid Head	40.372	1.758	39.30	1.76	2.73	-0.11	±5
2410	Simulated Tissue Liquid Head	40.329	1.769	39.28	1.77	2.67	-0.06	±5
2420	Simulated Tissue Liquid Head	40.285	1.780	39.26	1.77	2.61	0.56	±5
2430	Simulated Tissue Liquid Head	40.248	1.791	39.24	1.78	2.57	0.62	±5
2440	Simulated Tissue Liquid Head	40.213	1.802	39.22	1.79	2.53	0.67	±5
2450	Simulated Tissue Liquid Head	40.177	1.812	39.20	1.80	2.49	0.67	±5
2460	Simulated Tissue Liquid Head	40.144	1.823	39.19	1.81	2.43	0.72	±5
2470	Simulated Tissue Liquid Head	40.112	1.833	39.17	1.82	2.40	0.71	±5
2480	Simulated Tissue Liquid Head	40.084	1.843	39.16	1.83	2.36	0.71	±5
2490	Simulated Tissue Liquid Head	40.039	1.856	39.15	1.84	2.27	0.87	±5
2500	Simulated Tissue Liquid Head	40.000	1.868	39.13	1.85	2.22	0.97	±5
2510	Simulated Tissue Liquid Head	39.959	1.880	39.12	1.86	2.14	1.08	±5
2520	Simulated Tissue Liquid Head	39.919	1.893	39.11	1.87	2.07	1.23	±5
2530	Simulated Tissue Liquid Head	39.879	1.906	39.09	1.89	2.02	0.85	±5
2540	Simulated Tissue Liquid Head	39.836	1.919	39.08	1.90	1.93	1.00	±5
2550	Simulated Tissue Liquid Head	39.784	1.932	39.07	1.91	1.83	1.15	±5

\*Liquid Verification above was performed on 2023/07/01.

Frequency (MHz)	Liquid Type	Liquid		Target Value		Delta(%)		Tolerance (%)
		$\epsilon_r$	$\sigma$	$\epsilon_r$	$\sigma$ (S/m)	$\Delta \epsilon_r$	$\Delta \sigma$	
2550	Simulated Tissue Liquid Head	38.796	1.971	39.07	1.91	-0.70	3.19	$\pm 5$
2560	Simulated Tissue Liquid Head	38.776	1.979	39.05	1.92	-0.70	3.07	$\pm 5$
2570	Simulated Tissue Liquid Head	38.755	1.989	39.04	1.93	-0.73	3.06	$\pm 5$
2580	Simulated Tissue Liquid Head	38.728	1.999	39.03	1.94	-0.77	3.04	$\pm 5$
2590	Simulated Tissue Liquid Head	38.702	2.009	39.01	1.95	-0.79	3.03	$\pm 5$
2600	Simulated Tissue Liquid Head	38.674	2.019	39.00	1.96	-0.84	3.01	$\pm 5$
2610	Simulated Tissue Liquid Head	38.645	2.029	38.99	1.97	-0.88	2.99	$\pm 5$
2620	Simulated Tissue Liquid Head	38.616	2.041	38.98	1.98	-0.93	3.08	$\pm 5$
2630	Simulated Tissue Liquid Head	38.582	2.050	38.96	1.99	-0.97	3.02	$\pm 5$
2640	Simulated Tissue Liquid Head	38.548	2.061	38.95	2.00	-1.03	3.05	$\pm 5$
2650	Simulated Tissue Liquid Head	38.504	2.072	38.94	2.02	-1.12	2.57	$\pm 5$
2660	Simulated Tissue Liquid Head	38.471	2.083	38.93	2.03	-1.18	2.61	$\pm 5$
2670	Simulated Tissue Liquid Head	38.437	2.094	38.91	2.04	-1.22	2.65	$\pm 5$
2680	Simulated Tissue Liquid Head	38.406	2.106	38.90	2.05	-1.27	2.73	$\pm 5$
2690	Simulated Tissue Liquid Head	38.375	2.118	38.89	2.06	-1.32	2.82	$\pm 5$
2700	Simulated Tissue Liquid Head	38.347	2.131	38.88	2.07	-1.37	2.95	$\pm 5$

\*Liquid Verification above was performed on 2023/07/02.

Frequency (MHz)	Liquid Type	Liquid		Target Value		Delta(%)		Tolerance (%)
		$\epsilon_r$	$\sigma$ (S/m)	$\epsilon_r$	$\sigma$ (S/m)	$\Delta \epsilon_r$	$\Delta \sigma$	
5150	Simulated Tissue Liquid Head	36.264	4.539	36.05	4.61	0.59	-1.54	$\pm 5$
5160	Simulated Tissue Liquid Head	36.233	4.543	36.04	4.62	0.54	-1.67	$\pm 5$
5170	Simulated Tissue Liquid Head	36.201	4.558	36.03	4.63	0.47	-1.56	$\pm 5$
5180	Simulated Tissue Liquid Head	36.172	4.570	36.02	4.64	0.42	-1.51	$\pm 5$
5190	Simulated Tissue Liquid Head	36.139	4.582	36.01	4.65	0.36	-1.46	$\pm 5$
5200	Simulated Tissue Liquid Head	36.107	4.593	36.00	4.66	0.30	-1.44	$\pm 5$
5210	Simulated Tissue Liquid Head	36.076	4.605	35.99	4.67	0.24	-1.39	$\pm 5$
5220	Simulated Tissue Liquid Head	36.044	4.616	35.98	4.68	0.18	-1.37	$\pm 5$
5230	Simulated Tissue Liquid Head	36.013	4.627	35.97	4.69	0.12	-1.34	$\pm 5$
5240	Simulated Tissue Liquid Head	35.982	4.635	35.96	4.70	0.06	-1.38	$\pm 5$
5250	Simulated Tissue Liquid Head	35.950	4.646	35.95	4.71	0.00	-1.36	$\pm 5$

\*Liquid Verification above was performed on 2023/07/03.

Frequency (MHz)	Liquid Type	Liquid		Target Value		Delta(%)		Tolerance (%)
		$\epsilon_r$	$\sigma$ (S/m)	$\epsilon_r$	$\sigma$ (S/m)	$\Delta \epsilon_r$	$\Delta \sigma$	
5740	Simulated Tissue Liquid Head	34.412	5.237	35.36	5.21	-2.68	0.52	$\pm 5$
5750	Simulated Tissue Liquid Head	34.380	5.246	35.35	5.22	-2.74	0.50	$\pm 5$
5760	Simulated Tissue Liquid Head	34.349	5.258	35.34	5.23	-2.80	0.54	$\pm 5$
5770	Simulated Tissue Liquid Head	34.317	5.266	35.33	5.24	-2.87	0.50	$\pm 5$
5780	Simulated Tissue Liquid Head	34.286	5.277	35.32	5.25	-2.93	0.51	$\pm 5$
5790	Simulated Tissue Liquid Head	34.255	5.289	35.31	5.26	-2.99	0.55	$\pm 5$
5800	Simulated Tissue Liquid Head	34.223	5.301	35.30	5.27	-3.05	0.59	$\pm 5$
5810	Simulated Tissue Liquid Head	34.192	5.322	35.29	5.28	-3.11	0.80	$\pm 5$
5820	Simulated Tissue Liquid Head	34.160	5.353	35.28	5.29	-3.17	1.19	$\pm 5$
5830	Simulated Tissue Liquid Head	34.129	5.374	35.27	5.30	-3.24	1.40	$\pm 5$
5840	Simulated Tissue Liquid Head	34.098	5.393	35.26	5.31	-3.30	1.56	$\pm 5$
5850	Simulated Tissue Liquid Head	34.066	5.414	35.25	5.32	-3.36	1.77	$\pm 5$

\*Liquid Verification above was performed on 2023/07/02.

### 4.2 System Accuracy Verification

Prior to the assessment, the system validation kit was used to test whether the system was operating within its specifications of  $\pm 10\%$ . The validation results are tabulated below. And also the corresponding SAR plot is attached as well in the SAR plots files.

The spacing distances in the **System Verification Setup Block Diagram** is given by the following:

- a)  $s = 15 \text{ mm} \pm 0,2 \text{ mm}$  for  $300 \text{ MHz} \leq f \leq 1\,000 \text{ MHz}$ ;
- b)  $s = 10 \text{ mm} \pm 0,2 \text{ mm}$  for  $1\,000 \text{ MHz} < f \leq 3\,000 \text{ MHz}$ ;
- c)  $s = 10 \text{ mm} \pm 0,2 \text{ mm}$  for  $3\,000 \text{ MHz} < f \leq 6\,000 \text{ MHz}$ .

#### System Verification Setup Block Diagram

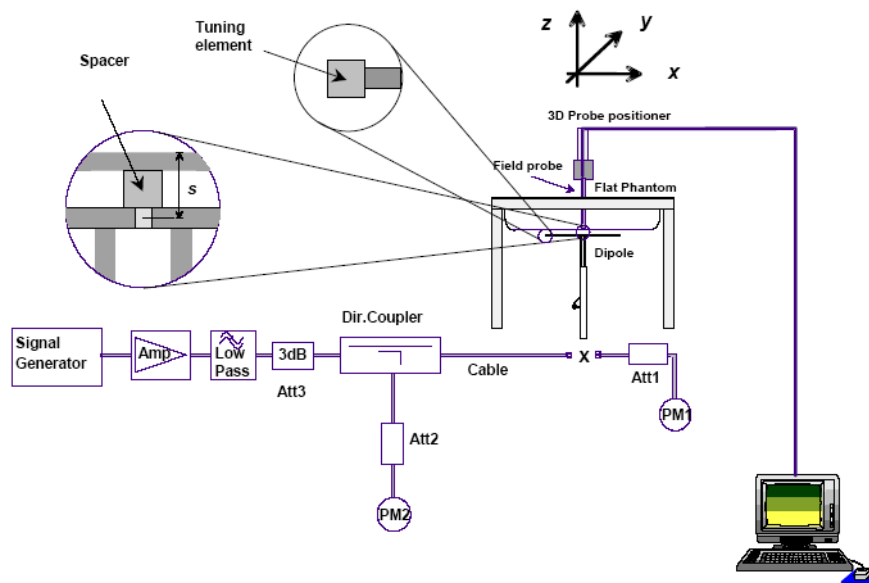

#### System Accuracy Check Results

Date	Frequency Band	Liquid Type	Input Power (mW)	Measured SAR (W/kg)	Normalized to 1W (W/kg)	Target Value (W/kg)	Delta (%)	Tolerance (%)
2023/07/03	750 MHz	Simulated Tissue Liquid Head	100	1g 0.863	8.63	8.49	1.65	$\pm 10$
2023/07/04	750 MHz	Simulated Tissue Liquid Head	100	1g 0.869	8.69	8.49	2.36	$\pm 10$
2023/06/30	1900 MHz	Simulated Tissue Liquid Head	100	1g 4.17	41.7	38.9	7.20	$\pm 10$
2023/07/01	2450 MHz	Simulated Tissue Liquid Head	100	1g 5.33	53.3	50.9	4.72	$\pm 10$
2023/07/02	2600 MHz	Simulated Tissue Liquid Head	100	1g 5.86	58.6	56	4.64	$\pm 10$
2023/07/03	5250 MHz	Simulated Tissue Liquid Head	100	1g 8.11	81.1	77.5	4.65	$\pm 10$
2023/07/02	5750 MHz	Simulated Tissue Liquid Head	100	1g 7.73	77.3	78.4	-1.40	$\pm 10$

\*The SAR values above are normalized to 1 Watt forward power.

### 4.3 SAR SYSTEM VALIDATION DATA

System Performance 750 MHz was performed on 2023/07/03.

DUT: D750V3; Type: 750 MHz; Serial: 1230

Communication System: CW; Frequency: 750 MHz; Duty Cycle: 1:1  
Medium parameters used:  $f = 750$  MHz;  $\sigma = 0.904$  S/m;  $\epsilon_r = 42.89$ ;  $\rho = 1000$  kg/m<sup>3</sup>  
Phantom section: Flat Section

DASY5 Configuration:

- Probe: EX3DV4 - SN7522; ConvF(9.9, 9.9, 9.9) @ 750 MHz; Calibrated: 2023/5/29
- Sensor-Surface: 1.4mm (Mechanical Surface Detection)
- Electronics: DAE4 Sn1493; Calibrated: 2023/3/17
- Phantom: Twin SAM; Type: Twin SAM V5.0; Serial: TP:1470
- Measurement SW: DASY52, Version 52.10 (2); SEMCAD X Version 14.6.12 (7470)

Area Scan (7x14x1): Measurement grid: dx=15mm, dy=15mm  
Maximum value of SAR (measured) = 0.947 W/kg

Zoom Scan (5x5x7)/Cube 0: Measurement grid: dx=8mm, dy=8mm, dz=5mm  
Reference Value = 32.73 V/m; Power Drift = -0.03 dB  
Peak SAR (extrapolated) = 1.33 W/kg  
SAR(1 g) = 0.863 W/kg; SAR(10 g) = 0.568 W/kg  
Maximum value of SAR (measured) = 0.977 W/kg

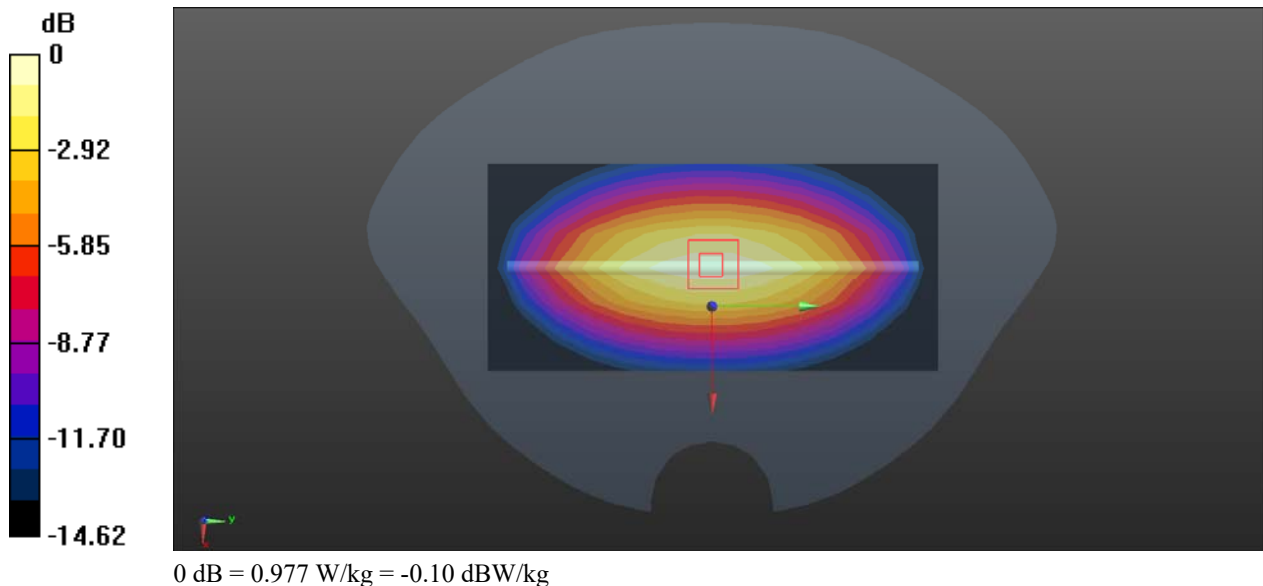



**System Performance 750 MHz was performed on 2023/07/04.**

**DUT: D750V3; Type: 750 MHz; Serial: 1230**

Communication System: CW; Frequency: 750 MHz; Duty Cycle: 1:1  
Medium parameters used:  $f = 750$  MHz;  $\sigma = 0.901$  S/m;  $\epsilon_r = 42.506$ ;  $\rho = 1000$  kg/m<sup>3</sup>  
Phantom section: Flat Section

DASY5 Configuration:

- Probe: EX3DV4 - SN7522; ConvF(9.9, 9.9, 9.9) @ 750 MHz; Calibrated: 2023/5/29
- Sensor-Surface: 1.4mm (Mechanical Surface Detection)
- Electronics: DAE4 Sn1493; Calibrated: 2023/3/17
- Phantom: Twin SAM; Type: Twin SAM V5.0; Serial: TP:1470
- Measurement SW: DASY52, Version 52.10 (2); SEMCAD X Version 14.6.12 (7470)

**Area Scan (7x14x1):** Measurement grid: dx=15mm, dy=15mm  
Maximum value of SAR (measured) = 0.956 W/kg

**Zoom Scan (5x5x7)/Cube 0:** Measurement grid: dx=8mm, dy=8mm, dz=5mm  
Reference Value = 32.39 V/m; Power Drift = -0.12 dB  
Peak SAR (extrapolated) = 1.33 W/kg  
**SAR(1 g) = 0.869 W/kg; SAR(10 g) = 0.572 W/kg**  
Maximum value of SAR (measured) = 0.983 W/kg

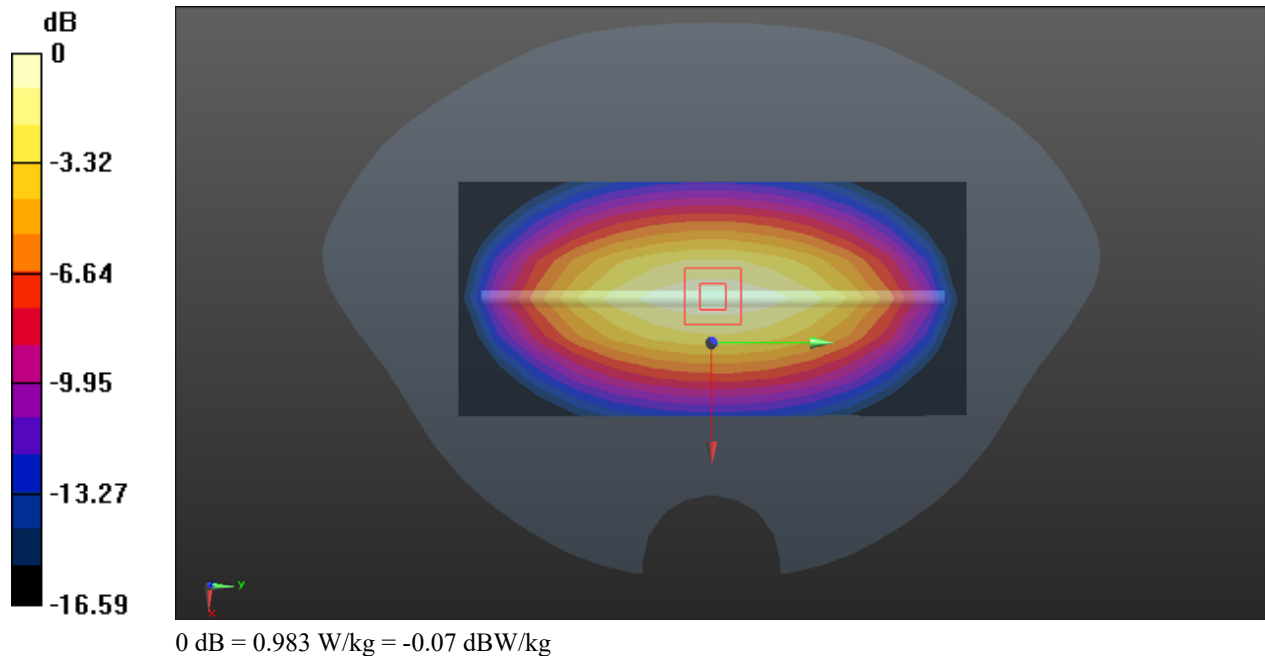

**System Performance 1900MHz****DUT: D1900V2; Type: 1900 MHz; Serial: 5d251**

Communication System: CW; Frequency: 1900 MHz; Duty Cycle: 1:1  
Medium parameters used:  $f = 1900$  MHz;  $\sigma = 1.375$  S/m;  $\epsilon_r = 39.427$ ;  $\rho = 1000$  kg/m<sup>3</sup>  
Phantom section: Flat Section

DASY5 Configuration:

- Probe: EX3DV4 - SN7522; ConvF(7.94, 7.94, 7.94) @ 1900 MHz; Calibrated: 2023/5/29
- Sensor-Surface: 1.4mm (Mechanical Surface Detection)
- Electronics: DAE4 Sn1493; Calibrated: 2023/3/17
- Phantom: Twin SAM; Type: Twin SAM V5.0; Serial: TP:1470
- Measurement SW: DASY52, Version 52.10 (2); SEMCAD X Version 14.6.12 (7470)

**Area Scan (7x9x1):** Measurement grid: dx=15mm, dy=15mm  
Maximum value of SAR (measured) = 5.16 W/kg

**Zoom Scan (5x5x7)/Cube 0:** Measurement grid: dx=8mm, dy=8mm, dz=5mm  
Reference Value = 59.38 V/m; Power Drift = -0.06 dB  
Peak SAR (extrapolated) = 8.22 W/kg  
**SAR(1 g) = 4.17 W/kg; SAR(10 g) = 2.03 W/kg**  
Maximum value of SAR (measured) = 4.58 W/kg

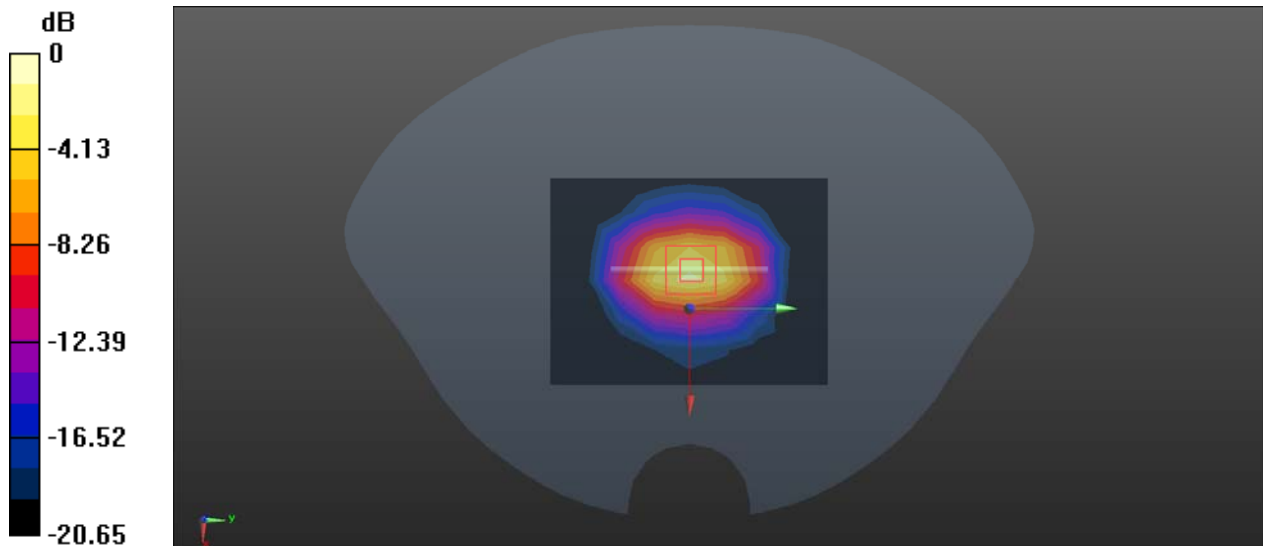

**System Performance 2450MHz****DUT: D2450V2; Type: 2450 MHz; Serial: SN1102**

Communication System: CW; Frequency: 2450 MHz; Duty Cycle: 1:1

Medium parameters used:  $f = 2450$  MHz;  $\sigma = 1.812$  S/m;  $\epsilon_r = 40.177$ ;  $\rho = 1000$  kg/m<sup>3</sup>

Phantom section: Flat Section

DASY5 Configuration:

- Probe: EX3DV4 - SN7522; ConvF(7.42, 7.42, 7.42) @ 2450 MHz; Calibrated: 2023/5/29
- Sensor-Surface: 1.4mm (Mechanical Surface Detection)
- Electronics: DAE4 Sn1493; Calibrated: 2023/3/17
- Phantom: Twin SAM; Type: Twin SAM V5.0; Serial: TP:1470
- Measurement SW: DASY52, Version 52.10 (2); SEMCAD X Version 14.6.12 (7470)

**Area Scan (9x11x1):** Measurement grid: dx=12mm, dy=12mm

Maximum value of SAR (measured) = 9.81 W/kg

**Zoom Scan (7x7x7)/Cube 0:** Measurement grid: dx=5mm, dy=5 mm, dz=5mm

Reference Value = 56.25 V/m; Power Drift = -0.16 dB

Peak SAR (extrapolated) = 11.8 W/kg

**SAR(1 g) = 5.33 W/kg; SAR(10 g) = 2.44 W/kg**

Maximum value of SAR (measured) = 9.27 W/kg

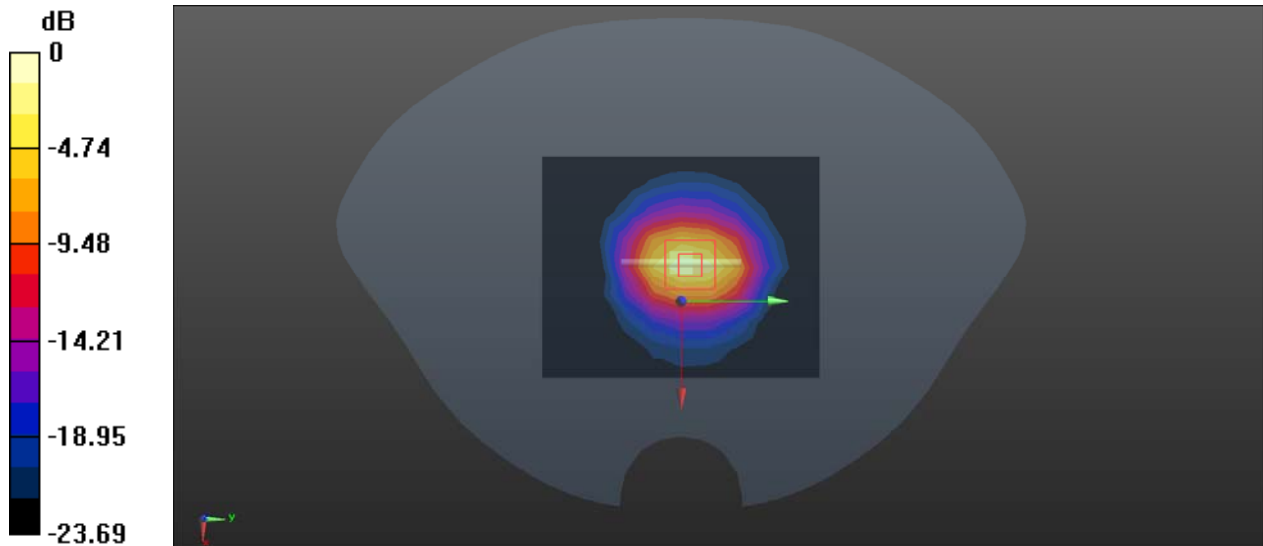

**System Performance 2600MHz****DUT: D2600V2; Type: 2600 MHz; Serial: SN1206**

Communication System: CW; Frequency: 2600 MHz; Duty Cycle: 1:1  
Medium parameters used:  $f = 2600$  MHz;  $\sigma = 2.019$  S/m;  $\epsilon_r = 38.674$ ;  $\rho = 1000$  kg/m<sup>3</sup>  
Phantom section: Flat Section

DASY5 Configuration:

- Probe: EX3DV4 - SN7522; ConvF(7.23, 7.23, 7.23) @ 2600 MHz; Calibrated: 2023/5/29
- Sensor-Surface: 1.4mm (Mechanical Surface Detection)
- Electronics: DAE4 Sn1493; Calibrated: 2023/3/17
- Phantom: Twin SAM; Type: Twin SAM V5.0; Serial: TP:1470
- Measurement SW: DASY52, Version 52.10 (2); SEMCAD X Version 14.6.12 (7470)

**Area Scan (9x11x1):** Measurement grid: dx=12mm, dy=12mm

Maximum value of SAR (measured) = 11.7 W/kg

**Zoom Scan (7x7x7)/Cube 0:** Measurement grid: dx=5mm, dy=5mm, dz=5mm

Reference Value = 64.53 V/m; Power Drift = -0.11 dB

Peak SAR (extrapolated) = 12.5 W/kg

**SAR(1 g) = 5.86 W/kg; SAR(10 g) = 2.58 W/kg**

Maximum value of SAR (measured) = 11.7 W/kg

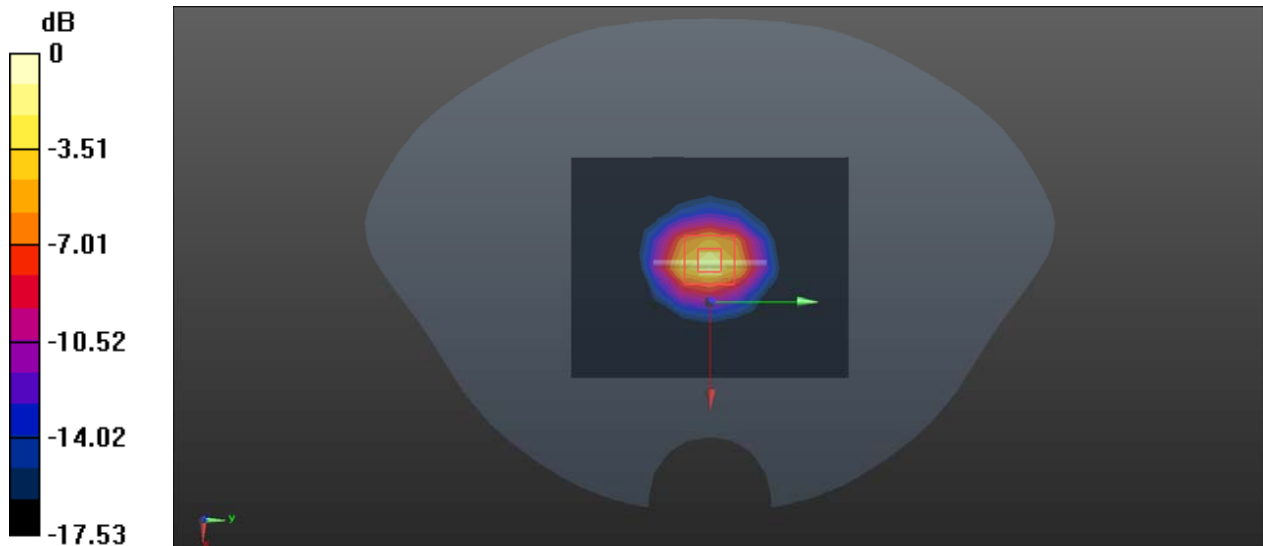

0 dB = 11.7 W/kg = 10.68 dBW/kg

**System Performance 5250 MHz****DUT: D5GHzV2; Type: 5250 MHz; Serial: 1246**

Communication System: CW; Frequency: 5250 MHz; Duty Cycle: 1:1

Medium parameters used:  $f = 5250$  MHz;  $\sigma = 4.646$  S/m;  $\epsilon_r = 35.95$ ;  $\rho = 1000$  kg/m<sup>3</sup>

Phantom section: Flat Section

DASY5 Configuration:

- Probe: EX3DV4 - SN7522; ConvF(5.36, 5.36, 5.36) @ 5250 MHz; Calibrated: 2023/5/29
- Sensor-Surface: 1.4mm (Mechanical Surface Detection)
- Electronics: DAE4 Sn1493; Calibrated: 2023/3/17
- Phantom: Twin SAM; Type: Twin SAM V5.0; Serial: TP:1470
- Measurement SW: DASY52, Version 52.10 (2); SEMCAD X Version 14.6.12 (7470)

**Area Scan (9x11x1):** Measurement grid: dx=10mm, dy=10mm

Maximum value of SAR (measured) = 24.3 W/kg

**Zoom Scan (7x7x16)/Cube 0:** Measurement grid: dx=4mm, dy=4mm, dz=2mm

Reference Value = 48.45 V/m; Power Drift = -0.11 dB

Peak SAR (extrapolated) = 33.6 W/kg

**SAR(1 g) = 8.11 W/kg; SAR(10 g) = 2.25 W/kg**

Maximum value of SAR (measured) = 24.5 W/kg

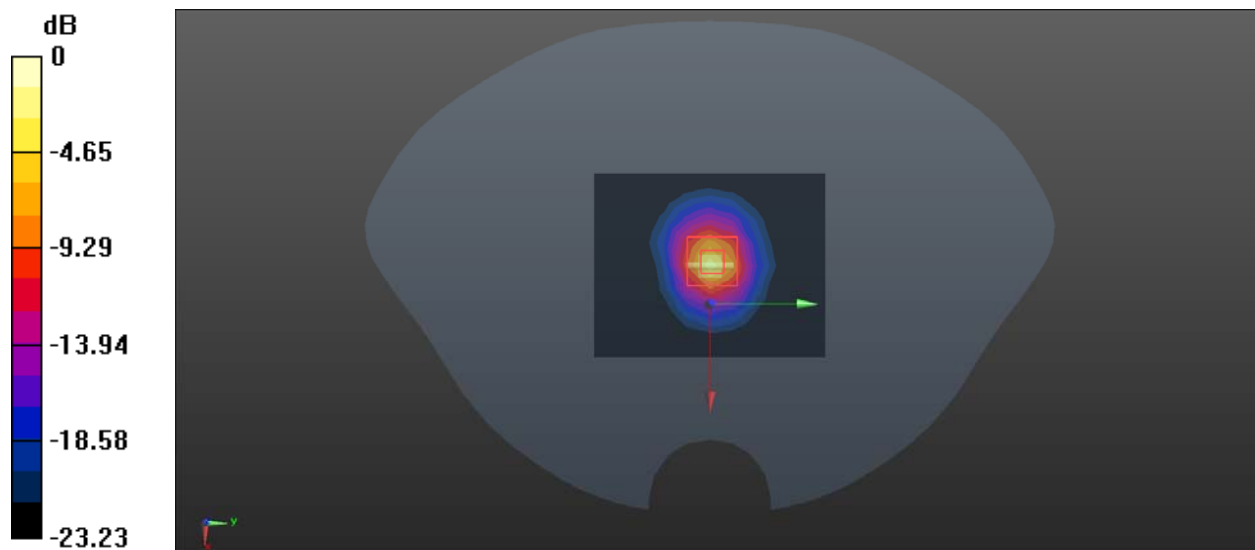

**System Performance 5750 MHz****DUT: D5GHzV2; Type: 5750 MHz; Serial: 1246**

Communication System: CW; Frequency: 5750 MHz; Duty Cycle: 1:1  
Medium parameters used:  $f = 5750$  MHz;  $\sigma = 5.246$  S/m;  $\epsilon_r = 34.38$ ;  $\rho = 1000$  kg/m<sup>3</sup>  
Phantom section: Flat Section

DASY5 Configuration:

- Probe: EX3DV4 - SN7522; ConvF(4.9, 4.9, 4.9) @ 5750 MHz; Calibrated: 2023/5/29
- Sensor-Surface: 1.4mm (Mechanical Surface Detection)
- Electronics: DAE4 Sn1493; Calibrated: 2023/3/17
- Phantom: Twin SAM; Type: Twin SAM V5.0; Serial: TP:1470
- Measurement SW: DASY52, Version 52.10 (2); SEMCAD X Version 14.6.12 (7470)

**Area Scan (8x8x1):** Measurement grid: dx=10mm, dy=10mm  
Maximum value of SAR (measured) = 25.6 W/kg

**Zoom Scan (7x7x16)/Cube 0:** Measurement grid: dx=4mm, dy=4mm, dz=2mm  
Reference Value = 43.63 V/m; Power Drift = 0.05 dB  
Peak SAR (extrapolated) = 30.5 W/kg  
**SAR(1 g) = 7.73 W/kg; SAR(10 g) = 2.21 W/kg**  
Maximum value of SAR (measured) = 24.2 W/kg

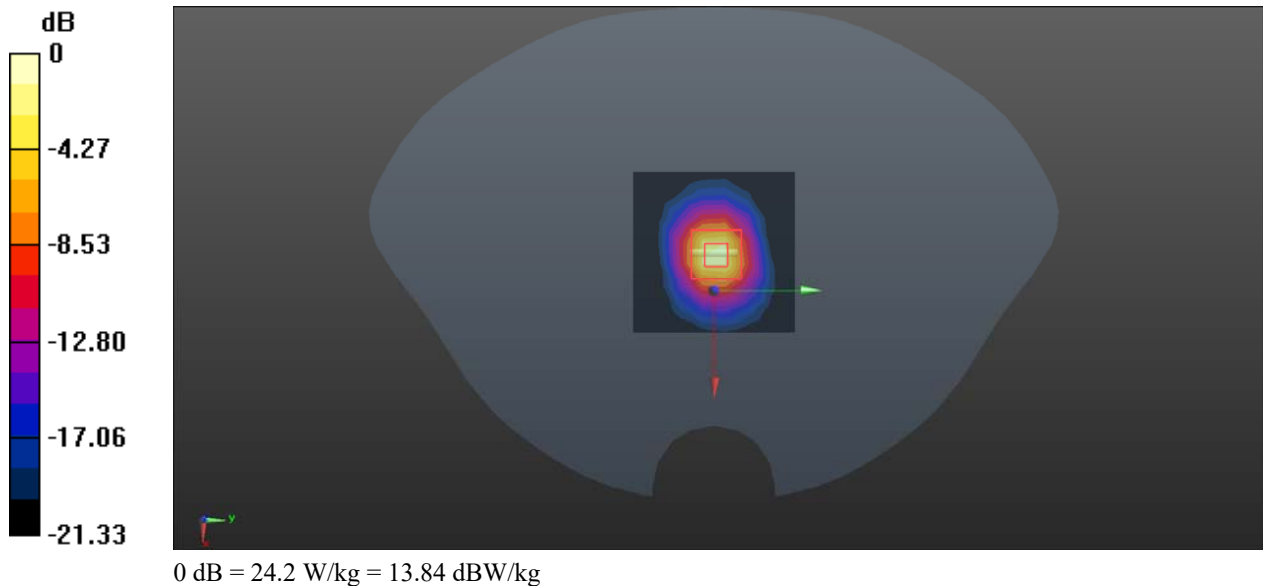

## 5. EUT TEST STRATEGY AND METHODOLOGY

### 5.1 Test Positions for Device Operating Next to a Person's Ear

This category includes most wireless handsets with fixed, retractable or internal antennas located toward the top half of the device, with or without a foldout, sliding or similar keypad cover. The handset should have its earpiece located within the upper ¼ of the device, either along the centerline or off-centered, as perceived by its users. This type of handset should be positioned in a normal operating position with the “test device reference point” located along the “vertical centerline” on the front of the device aligned to the “ear reference point”. The “test device reference point” should be located at the same level as the center of the earpiece region. The “vertical centerline” should bisect the front surface of the handset at its top and bottom edges. A “ear reference point” is located on the outer surface of the head phantom on each ear spacer. It is located 1.5 cm above the center of the ear canal entrance in the “phantom reference plane” defined by the three lines joining the center of each “ear reference point” (left and right) and the tip of the mouth.

A handset should be initially positioned with the earpiece region pressed against the ear spacer of a head phantom. For the SCC-34/SC-2 head phantom, the device should be positioned parallel to the “N-F” line defined along the base of the ear spacer that contains the “ear reference point”. For interim head phantoms, the device should be positioned parallel to the cheek for maximum RF energy coupling. The “test device reference point” is aligned to the “ear reference point” on the head phantom and the “vertical centerline” is aligned to the “phantom reference plane”. This is called the “initial ear position”. While maintaining these three alignments, the body of the handset is gradually adjusted to each of the following positions for evaluating SAR:

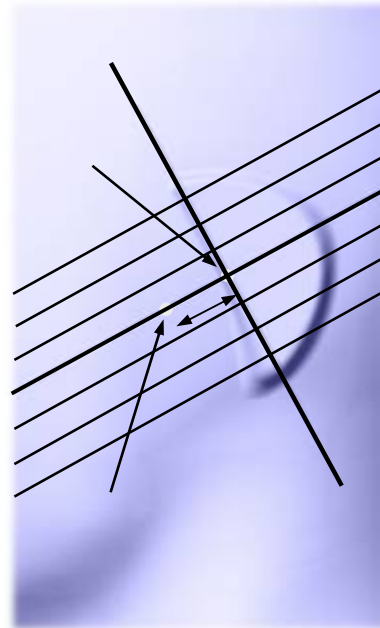
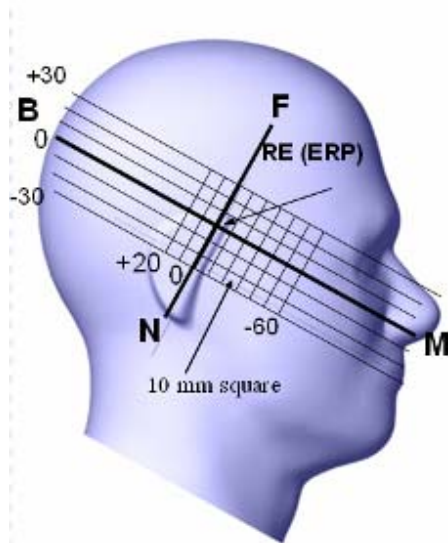

## 5.2 Cheek/Touch Position

The device is brought toward the mouth of the head phantom by pivoting against the “ear reference point” or along the “N-F” line for the SCC-34/SC-2 head phantom.

This test position is established:

When any point on the display, keypad or mouthpiece portions of the handset is in contact with the phantom.

(or) When any portion of a foldout, sliding or similar keypad cover opened to its intended self-adjusting normal use position is in contact with the cheek or mouth of the phantom.

For existing head phantoms – when the handset loses contact with the phantom at the pivoting point, rotation should continue until the device touches the cheek of the phantom or breaks its last contact from the ear spacer.

### Cheek /Touch Position

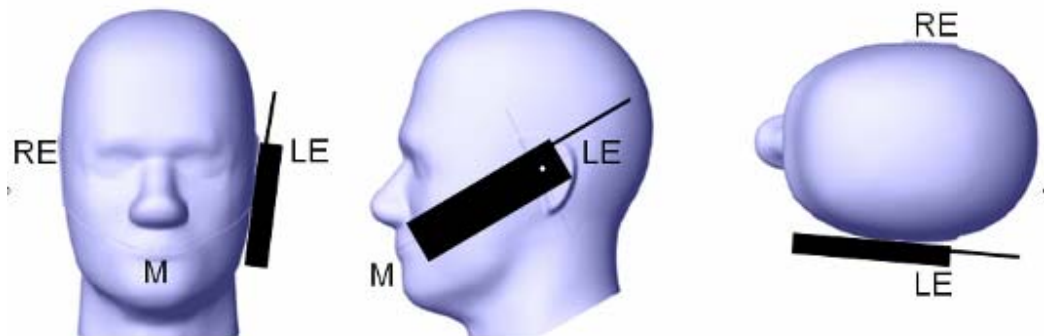

## 5.3 Ear/Tilt Position

With the handset aligned in the “Cheek/Touch Position”:

1) If the earpiece of the handset is not in full contact with the phantom’s ear spacer (in the “Cheek/Touch position”) and the peak SAR location for the “Cheek/Touch” position is located at the ear spacer region or corresponds to the earpiece region of the handset, the device should be returned to the “initial ear position” by rotating it away from the mouth until the earpiece is in full contact with the ear spacer.

2) (otherwise) The handset should be moved (translated) away from the cheek perpendicular to the line passes through both “ear reference points” (note: one of these ear reference points may not physically exist on a split head model) for approximate 2-3 cm. While it is in this position, the device handset is tilted away from the mouth with respect to the “test device reference point” until the inside angle between the vertical centerline on the front surface of the phone and the horizontal line passing through the ear reference point is by  $15^{\circ}$  to  $80^{\circ}$ . After the tilt, it is then moved (translated) back toward the head perpendicular to the line passes through both “ear reference points” until the device touches the phantom or the ear spacer. If the antenna touches the head first, the positioning process should be repeated with a tilt angle less than  $15^{\circ}$  so that the device and its antenna would touch the phantom simultaneously. This test position may require a device holder or positioner to achieve the translation and tilting with acceptable positioning repeatability.

If a device is also designed to transmit with its keypad cover closed for operating in the head position, such positions should also be considered in the SAR evaluation. The device should be tested on the left and



right side of the head phantom in the “Cheek/Touch” and “Ear/Tilt” positions. When applicable, each configuration should be tested with the antenna in its fully extended and fully retracted positions. These test configurations should be tested at the high, middle and low frequency channels of each operating mode; for example, AMPS, CDMA, and TDMA. If the SAR measured at the middle channel for each test configuration (left, right, Cheek/Touch, Tilt/Ear, extended and retracted) is at least 2.0 dB lower than the SAR limit, testing at the high and low channels is optional for such test configuration(s). If the transmission band of the test device is less than 10 MHz, testing at the high and low frequency channels is optional.

#### Ear /Tilt 15° Position

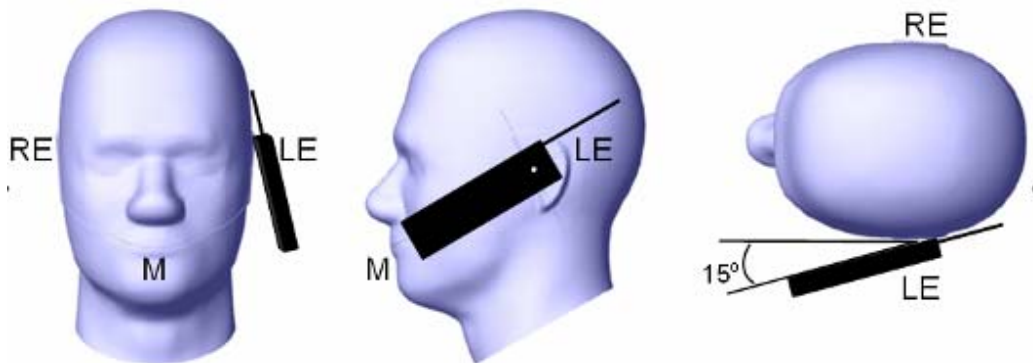

#### **5.4 Test positions for body-worn and other configurations**

Body-worn operating configurations should be tested with the belt-clips and holsters attached to the device and positioned against a flat phantom in normal use configurations. Devices with a headset output should be tested with a headset connected to the device. When multiple accessories that do not contain metallic components are supplied with the device, the device may be tested with only the accessory that dictates the closest spacing to the body. When multiple accessories that contain metallic components are supplied with the device, the device must be tested with each accessory that contains a unique metallic component. If multiple accessories share an identical metallic component (e.g., the same metallic belt-clip used with different holsters with no other metallic components), only the accessory that dictates the closest spacing to the body must be tested.

Body-worn accessories may not always be supplied or available as options for some devices that are intended to be authorized for body-worn use. A separation distance of 1.5 cm between the back of the device and a flat phantom is recommended for testing body-worn SAR compliance under such circumstances. Other separation distances may be used, but they should not exceed 2.5 cm. In these cases, the device may use body-worn accessories that provide a separation distance greater than that tested for the device provided however that the accessory contains no metallic components.

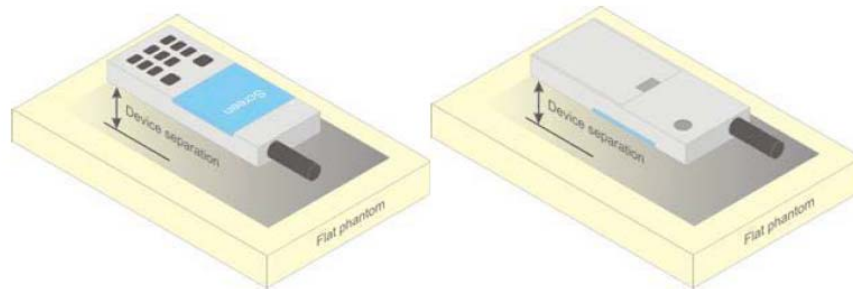

Figure 5 – Test positions for body-worn devices

### 5.5 Test Distance for SAR Evaluation

In this case the EUT(Equipment Under Test) is set 10mm away from the phantom, the test distance is 10mm.

## 5.6 SAR Evaluation Procedure

The evaluation was performed with the following procedure:

Step 1: Measurement of the SAR value at a fixed location above the ear point or central position was used as a reference value for assessing the power drop. The SAR at this point is measured at the start of the test and then again at the end of the testing.

Step 2: The SAR distribution at the exposed side of the head was measured at a distance of 4 mm from the inner surface of the shell. The area covered the entire dimension of the head or radiating structures of the EUT, the horizontal grid spacing was 15 mm x 15 mm, and the SAR distribution was determined by integrated grid of 1.5mm x 1.5mm. Based on these data, the area of the maximum absorption was determined by spline interpolation. The first Area Scan covers the entire dimension of the EUT to ensure that the hotspot was correctly identified.

Step 3: Around this point, a volume of 30 mm x 30 mm x 30 mm was assessed by measuring 7x 7 x 7 points. On the basis of this data set, the spatial peak SAR value was evaluated under the following procedure:

1) The data at the surface were extrapolated, since the center of the dipoles is 1.2 mm away from the tip of the probe and the distance between the surface and the lowest measuring point is 1.3 mm. The extrapolation was based on a least square algorithm. A polynomial of the fourth order was calculated through the points in z-axes. This polynomial was then used to evaluate the points between the surface and the probe tip.

2) The maximum interpolated value was searched with a straightforward algorithm. Around this maximum the SAR values averaged over the spatial volumes (1 g or 10 g) were computed by the 3D-Spline interpolation algorithm. The 3D-Spline is composed of three one dimensional splines with the "Not a knot"-condition (in x, y and z-directions). The volume was integrated with the trapezoidal-algorithm. One thousand points (10 x 10 x 10) were interpolated to calculate the averages.

All neighboring volumes were evaluated until no neighboring volume with a higher average value was found.

Step 4: Re-measurement of the SAR value at the same location as in Step 1. If the value changed by more than 5%, the evaluation was repeated.

## 6. CONDUCTED OUTPUT POWER MEASUREMENT

### 6.1 Test Procedure

The RF output of the transmitter was connected to the input of the Wireless Communication Test Set through Connector.

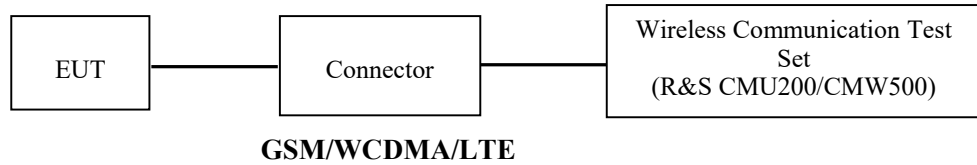

The RF output of the transmitter was connected to the input port of the USB Wideband Power Sensor through Connector.

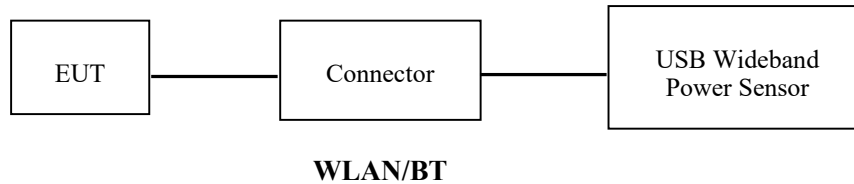

## 6.2 Description of Test Configuration

### EUT Operation Condition:

<b>EUT Operation Mode:</b>	The system was configured for testing in each operation mode.
<b>Equipment Modifications:</b>	No
<b>EUT Exercise Software:</b>	No

The maximum power was configured per 3GPP Standard for each operation modes as below setting:

GSM/GPRS/EGPRS

Function: Menu select > GSM Mobile Station > GSM 850/1900  
 Press Connection control to choose the different menus  
 Press RESET > choose all the reset all settings  
 Connection Press Signal Off to turn off the signal and change settings  
 Network Support > GSM + GPRS or GSM + EGSM  
 Main Service > Packet Data  
 Service selection > Test Mode A – Auto Slot Config. off  
 MS Signal Press Slot Config Bottom on the right twice to select and change the number of time slots and power setting

- > Slot configuration > Uplink/Gamma
- > 33 dBm for GPRS 850
- > 30 dBm for GPRS 1900
- > 27 dBm for EGPRS 850
- > 26 dBm for EGPRS 1900

BS Signal Enter the same channel number for TCH channel (test channel) and BCCH channel  
 Frequency Offset > + 0 Hz  
 Mode > BCCH and TCH

BCCH Level > -85 dBm (May need to adjust if link is not stable)  
 BCCH Channel > choose desire test channel [Enter the same channel number for TCH channel (test channel) and BCCH channel]

Channel Type > Off  
 P0 > 4 dB  
 Slot Config > Unchanged (if already set under MS signal)  
 TCH > choose desired test channel  
 Hopping > Off  
 Main Timeslot > 3  
 Network Coding Scheme > CS4 (GPRS) and MCS5 (EGPRS)

Bit Stream > 2E9-1 PSR Bit Stream  
 AF/RF Enter appropriate offsets for Ext. Att. Output and Ext. Att. Input  
 Connection Press Signal on to turn on the signal and change settings

**WCDMA Release 99**

The following tests were conducted according to the test requirements outlines in section 5.2 of the 3GPP TS34.121-1 specification. The EUT has a nominal maximum output power of 24dBm (+1.7/-3.7).

<b>WCDMA General Settings</b>	Loopback Mode	Test Mode 1
	Rel99 RMC	12.2kbps RMC
	Power Control Algorithm	Algorithm2
	$\beta_c/\beta_d$	8/15

**WCDMA HSDPA**

The following tests were conducted according to the test requirements outlines in section 5.2 of the 3GPP TS34.121-1 specification.

	Mode	HSDPA	HSDPA	HSDPA	HSDPA
	Subset	1	2	3	4
<b>WCDMA General Settings</b>	Loopback Mode	Test Mode 1			
	Rel99 RMC	12.2kbps RMC			
	HSDPA FRC	H-Set1			
	Power Control Algorithm	Algorithm2			
	$\beta_c$	2/15	12/15	15/15	15/15
	$\beta_d$	1 /15	15/15	8/15	4/15
	$\beta_d$ (SF)	64			
	$\beta_c/\beta_d$	2/15	12/15	15/8	15/4
	$\beta_{hs}$	4/15	24/15	30/15	30/15
	MPR(dB)	0	0	0.5	0.5
<b>HSDPA Specific Settings</b>	DACK	8			
	DNAK	8			
	DCQI	8			
	Ack-Nack repetition factor	3			
	CQI Feedback	4ms			
	CQI Repetition Factor	2			
	$A_{hs}=\beta_{hs}/\beta_c$	30/15			

**WCDMA HSUPA**

The following tests were conducted according to the test requirements outlines in section 5.2 of the 3GPP TS34.121-1 specification.

	Mode	HSUPA	HSUPA	HSUPA	HSUPA	HSUPA
	Subset	1	2	3	4	5
<b>WCDMA General Settings</b>	Loopback Mode	Test Mode 1				
	Rel99 RMC	12.2kbps RMC				
	HSDPA FRC	H-Set1				
	HSUPA Test	HSUPA Loopback				
	Power Control Algorithm	Algorithm2				
	$\beta_c$	11/15	6/15	15/15	2/15	15/15
	$\beta_d$	15/15	15/15	9/15	15/15	0
	$\beta_{cc}$	209/225	12/15	30/15	2/15	5/15
	$\beta_c / \beta_d$	11/15	6/15	15/9	2/15	-
	$\beta_{hs}$	22/15	12/15	30/15	4/15	5/15
	CM(dB)	1.0	3.0	2.0	3.0	1.0
MPR(dB)	0	2	1	2	0	
<b>HSDPA Specific Settings</b>	DACK	8				
	DNAK	8				
	DCQI	8				
	Ack-Nack repetition factor	3				
	CQI Feedback	4ms				
	CQI Repetition Factor	2				
	$A_{hs} = \beta_{hs} / \beta_c$	30/15				
<b>HSUPA Specific Settings</b>	DE-DPCCH	6	8	8	5	7
	DHARQ	0	0	0	0	0
	AG Index	20	12	15	17	21
	ETFCI	75	67	92	71	81
	Associated Max UL Data Rate kbps	242.1	174.9	482.8	205.8	308.9
	Reference E_FCI	E-TFCI 11 E-TFCI PO 4 E-TFCI 67 E-TFCI PO 18 E-TFCI 71 E-TFCI PO23 E-TFCI 75 E-TFCI PO26 E-TFCI 81 E-TFCI PO 27	E-TFCI 11 E-TFCI PO4 E-TFCI 92 E-TFCI PO 18	E-TFCI 11 E-TFCI PO 4 E-TFCI 67 E-TFCI PO 18 E-TFCI 71 E-TFCI PO23 E-TFCI 75 E-TFCI PO26 E-TFCI 81 E-TFCI PO 27	E-TFCI 11 E-TFCI PO 4 E-TFCI 67 E-TFCI PO 18 E-TFCI 71 E-TFCI PO23 E-TFCI 75 E-TFCI PO26 E-TFCI 81 E-TFCI PO 27	

**HSPA+**

Sub-test	$\beta_c$ (Note3)	$\beta_d$	$\beta_{HS}$ (Note1)	$\beta_{ec}$	$\beta_{ed}$ (2xSF2) (Note 4)	$\beta_{ed}$ (2xSF4) (Note 4)	CM (dB) (Note 2)	MPR (dB) (Note 2)	AG Index (Note 4)	E-TFCI (Note 5)	E-TFCI (boost)
1	1	0	30/15	30/15	$\beta_{ed1}$ : 30/15 $\beta_{ed2}$ : 30/15	$\beta_{ed3}$ : 24/15 $\beta_{ed4}$ : 24/15	3.5	2.5	14	105	105

Note 1:  $\Delta_{ACK}$ ,  $\Delta_{NACK}$  and  $\Delta_{CQI} = 30/15$  with  $\beta_{hs} = 30/15 * \beta_c$ .

Note 2: CM = 3.5 and the MPR is based on the relative CM difference, MPR = MAX(CM-1,0).

Note 3: DPDCH is not configured, therefore the  $\beta_c$  is set to 1 and  $\beta_d = 0$  by default.

Note 4:  $\beta_{ed}$  can not be set directly; it is set by Absolute Grant Value.

Note 5: All the sub-tests require the UE to transmit 2SF2+2SF4 16QAM EDCH and they apply for UE using E-DPDCH category 7. E-DCH TTI is set to 2ms TTI and E-DCH table index = 2. To support these E-DCH configurations DPDCH is not allocated. The UE is signalled to use the extrapolation algorithm.

The following tests were conducted according to the test requirements in Table C.11.1.4 of 3GPP TS 34.121-1



**LTE (FDD):**

The following tests were conducted according to the test requirements in 3GPP TS36.101

The following tests were conducted according to the test requirements outlined in section 6.2 of the 3GPP TS36.101 specification.

UE Power Class: 3 (23 +/- 2dBm). The allowed Maximum Power Reduction (MPR) for the maximum output power due to higher order modulation and transmit bandwidth configuration (resource blocks) is specified in Table 6.2.3-1 of the 3GPP TS36.101.

**Table 6.2.3-1: Maximum Power Reduction (MPR) for Power Class 3**

Modulation	Channel bandwidth / Transmission bandwidth (RB)						MPR (dB)
	1.4 MHz	3.0 MHz	5 MHz	10 MHz	15 MHz	20 MHz	
QPSK	> 5	> 4	> 8	> 12	> 16	> 18	≤ 1
16 QAM	≤ 5	≤ 4	≤ 8	≤ 12	≤ 16	≤ 18	≤ 1
16 QAM	> 5	> 4	> 8	> 12	> 16	> 18	≤ 2

The allowed A-MPR values specified below in Table 6.2.4.-1 of 3GPP TS36.101 are in addition to the allowed MPR requirements. All the measurements below were performed with A-MPR disabled, by using Network Signaling Value of "NS\_01".

**Table 6.2.4-1: Additional Maximum Power Reduction (A-MPR)**

Network Signalling value	Requirements (sub-clause)	E-UTRA Band	Channel bandwidth (MHz)	Resources Blocks ( $N_{RB}$ )	A-MPR (dB)
NS_01	6.6.2.1.1	Table 5.5-1	1.4, 3, 5, 10, 15, 20	Table 5.6-1	NA
NS_03	6.6.2.2.1	2, 4, 10, 23, 25, 35, 36	3	>5	≤ 1
			5	>6	≤ 1
			10	>6	≤ 1
			15	>8	≤ 1
NS_04	6.6.2.2.2	41	20	>10	≤ 1
			5	>6	≤ 1
NS_05	6.6.3.3.1	1	10, 15, 20	≥ 50	≤ 1
NS_06	6.6.2.2.3	12, 13, 14, 17	1.4, 3, 5, 10	Table 5.6-1	n/a
NS_07	6.6.2.2.3	13	10	Table 6.2.4-2	Table 6.2.4-2
	6.6.3.3.2				
NS_08	6.6.3.3.3	19	10, 15	> 44	≤ 3
NS_09	6.6.3.3.4	21	10, 15	> 40	≤ 1
				> 55	≤ 2
NS_10		20	15, 20	Table 6.2.4-3	Table 6.2.4-3
NS_11	6.6.2.2.1	23 <sup>1</sup>	1.4, 3, 5, 10	Table 6.2.4-5	Table 6.2.4-5
..					
NS_32	-	-	-	-	-

Note 1: Applies to the lower block of Band 23, i.e. a carrier placed in the 2000-2010 MHz region.

**TDD-LTE**

P TS 36.211 section 4.2 for Type 2 Frame Structure and Table 4.2-2 for uplink-downlink configurations and Table 4.2-1 for Special subframe configurations.

Table 4.2-1: Configuration of special subframe (lengths of DwPTS/GP/UpPTS).

Special subframe configuration	Normal cyclic prefix in downlink			Extended cyclic prefix in downlink		
	DwPTS	UpPTS		DwPTS	UpPTS	
		Normal cyclic prefix in uplink	Extended cyclic prefix in uplink		Normal cyclic prefix in uplink	Extended cyclic prefix in uplink
0	$6592 \cdot T_s$	$2192 \cdot T_s$	$2560 \cdot T_s$	$7680 \cdot T_s$	$2192 \cdot T_s$	$2560 \cdot T_s$
1	$19760 \cdot T_s$			$20480 \cdot T_s$		
2	$21952 \cdot T_s$			$23040 \cdot T_s$		
3	$24144 \cdot T_s$			$25600 \cdot T_s$		
4	$26336 \cdot T_s$			$7680 \cdot T_s$		
5	$6592 \cdot T_s$	$4384 \cdot T_s$	$5120 \cdot T_s$	$20480 \cdot T_s$	$4384 \cdot T_s$	$5120 \cdot T_s$
6	$19760 \cdot T_s$			$23040 \cdot T_s$		
7	$21952 \cdot T_s$			$12800 \cdot T_s$		
8	$24144 \cdot T_s$			-		
9	$13168 \cdot T_s$			-		

Table 4.2-2: Uplink-downlink configurations.

Uplink-downlink configuration	Downlink-to-Uplink Switch-point periodicity	Subframe number									
		0	1	2	3	4	5	6	7	8	9
0	5 ms	D	S	U	U	U	D	S	U	U	U
1	5 ms	D	S	U	U	D	D	S	U	U	D
2	5 ms	D	S	U	D	D	D	S	U	D	D
3	10 ms	D	S	U	U	U	D	D	D	D	D
4	10 ms	D	S	U	U	D	D	D	D	D	D
5	10 ms	D	S	U	D	D	D	D	D	D	D
6	5 ms	D	S	U	U	U	D	S	U	U	D

**Calculated Duty Cycle**

Uplink-Downlink Configuration	Downlink-to-Uplink Switch-point Periodicity	Subframe Number										Calculated Duty Cycle (%)
		0	1	2	3	4	5	6	7	8	9	
0	5 ms	D	S	U	U	U	D	S	U	U	U	63.33
1	5 ms	D	S	U	U	D	D	S	U	U	D	43.33
2	5 ms	D	S	U	D	D	D	S	U	D	D	23.33
3	10 ms	D	S	U	U	U	D	D	D	D	D	31.67
4	10 ms	D	S	U	U	D	D	D	D	D	D	21.67
5	10 ms	D	S	U	D	D	D	D	D	D	D	11.67
6	5 ms	D	S	U	U	U	D	S	U	U	D	53.33

We used configuration 0 for SAR test, that is 63.33%(1:1.58)for duty cycle

### 6.3 Maximum Target Output Power

Max Target Power(dBm)			
Mode/Band	Channel		
	Low	Middle	High
GSM 850	33.5	33.5	33.5
GPRS 1 TX Slot	33	33	33
GPRS 2 TX Slot	31.5	31.5	31.5
GPRS 3 TX Slot	29.5	29.5	29.5
GPRS 4 TX Slot	27.5	27.5	27.5
PCS 1900	30	30	30
GPRS 1 TX Slot	30.5	30.5	30.5
GPRS 2 TX Slot	28	28	28
GPRS 3 TX Slot	26.5	26.5	26.5
GPRS 4 TX Slot	24.5	24.5	24.5
WCDMA Band 2	21.5	21.5	21.5
HSDPA	21	21	21
HSUPA	21	21	21
HSPA+	21	21	21
WCDMA Band 5	24	24	24
HSDPA	22.5	22.5	22.5
HSUPA	22.5	22.5	22.5
HSPA+	23	23	23
LTE Band 2	20.5	20.5	20.5
LTE Band 5	24.5	24.5	24.5
LTE Band 7	23.5	23.5	23.5
LTE Band 12	24.5	24.5	24.5
LTE Band 41	24	24	24
WLAN 2.4G(802.11b)	13	13	13
WLAN 2.4G(802.11g)	12	12	12
WLAN 2.4G(802.11n ht20)	12	12	12
WLAN 2.4G(802.11n ht40)	11	11	11
WLAN 5.2G(802.11a)	13.5	13.5	13.5
WLAN 5.2G(802.11ac20)	13	13	13
WLAN 5.2G(802.11ac40)	10.5	/	10.5
WLAN 5.2G(802.11ac80)	/	11	/
WLAN 5.8G(802.11a)	8	8	8
WLAN 5.8G(802.11ac20)	9	9	9
WLAN 5.8G(802.11ac40)	8.5	/	8.5
WLAN 5.8G(802.11ac80)	/	7.5	/
Bluetooth BDR/EDR	-1	-1	-1
BLE 1M/2M	-0.5	-0.5	-0.5

**6.4 Test Results:****GSM:**

Band	Channel No.	Frequency (MHz)	RF Output Power (dBm)
GSM 850	128	824.2	33.10
	190	836.6	<b>33.19</b>
	251	848.8	33.07
PCS 1900	512	1850.2	<b>29.87</b>
	661	1880	29.51
	810	1909.8	29.63

**GPRS:**

Band	Channel No.	Frequency (MHz)	RF Output Power (dBm)			
			1 slot	2 slots	3 slots	4 slots
GSM 850	128	824.2	<b>32.80</b>	31.25	29.21	27.16
	190	836.6	32.69	31.32	29.27	27.03
	251	848.8	32.50	31.39	29.18	27.21
PCS 1900	512	1850.2	30.06	27.88	26.36	24.32
	661	1880	30.00	27.70	26.06	24.01
	810	1909.8	<b>30.30</b>	27.55	26.22	24.03

For SAR, the time based average power is relevant, the difference in between depends on the duty cycle of the TDMA signal.

Number of Time slot	1	2	3	4
Duty Cycle	1:8	1:4	1:2.66	1:2
Time based Ave. power compared to slotted Ave. power	-9 dB	-6 dB	-4.25 dB	-3 dB
Crest Factor	8	4	2.66	2

#### The time based average power for GPRS

Band	Channel No.	Frequency (MHz)	Time based average Power (dBm)			
			1 slot	2 slot	3 slots	4 slots
GSM 850	128	824.2	23.80	25.25	24.96	24.16
	190	836.6	23.69	25.32	25.02	24.03
	251	848.8	23.50	<b>25.39</b>	24.93	24.21
PCS 1900	512	1850.2	21.06	21.88	<b>22.11</b>	21.32
	661	1880	21.00	21.70	21.81	21.01
	810	1909.8	21.30	21.55	21.97	21.03

#### Note:

1. Rohde & Schwarz Radio Communication Tester (CMU200) was used for the measurement of GSM peak and average output power for active timeslots.
2. For GSM voice, 1 timeslot has been activated with power level 5 (850 MHz band) and 0 (1900 MHz band).
3. For GPRS, 1, 2, 3 and 4 timeslots has been activated separately with power level 3(850 MHz band) and 3(1900 MHz band).
4. When the maximum output power and tune-up tolerance specified for production units in a secondary mode is  $\leq \frac{1}{4}$  dB higher than the primary mode or when the highest *reported* SAR of the primary mode is scaled by the ratio of specified maximum output power and tune-up tolerance of secondary to primary mode and the adjusted SAR is  $\leq 1.2$  W/kg, SAR measurement is not required for the secondary mode.

**WCDMA:  
Results (12.2kbps RMC)**

Band	Frequency (MHz)	RF Output Power (dBm)
WCDMA Band 2	1852.4	21.33
	1880	<b>21.37</b>
	1907.6	21.29
WCDMA Band 5	826.4	23.79
	836.6	23.55
	846.6	<b>23.89</b>

**Results (HSDPA)**

Band	Frequency (MHz)	RF Output Power (dBm)			
		Subset 1	Subset 2	Subset 3	Subset 4
WCDMA Band 2	1852.4	20.51	20.64	20.84	20.65
	1880	20.77	20.85	20.61	20.62
	1907.6	20.71	20.84	20.62	20.64
WCDMA Band 5	826.4	22.08	22.06	22.16	22.06
	836.6	22.1	22.2	22.3	22.19
	846.6	21.99	22.11	22.02	22.36

**Results (HSUPA)**

Band	Frequency (MHz)	RF Output Power (dBm)				
		Subset 1	Subset 2	Subset 3	Subset 4	Subset 5
WCDMA Band 2	1852.4	20.72	20.65	20.71	20.74	20.72
	1880	20.53	20.51	20.72	20.68	20.59
	1907.6	20.49	20.85	20.79	20.79	20.59
WCDMA Band 5	826.4	22.37	22.29	22.01	22.39	22.03
	836.6	22.05	22.07	22.36	22.32	22.24
	846.6	22.24	22.03	22.3	22.01	22.21

**Results (HSPA+)**

<b>Band</b>	<b>Frequency (MHz)</b>	<b>RF Output Power (dBm)</b>
WCDMA Band 2	1852.4	20.63
	1880	20.72
	1907.6	20.73
WCDMA Band 5	826.4	22.76
	836.6	22.49
	846.6	22.75

**Note:**

1. The default test configuration is to measure SAR with an established radio link between the EUT and a communication test set using a 12.2 kbps RMC (reference measurement Channel) Configured in Test Loop Model 1.
2. KDB 941225 D01-Body SAR is not required for HSDPA/HSUPA/HSPA+ when the maximum average output of each RF channel is less than  $\frac{1}{4}$  dB higher than measured 12.2kbps RMC or the maximum SAR for 12.2kbps RMC is  $< 75\%$  of SAR limit.

**LTE Band 2:**

Test Bandwidth	Test Modulation	Resource Block & RB offset	Target MPR	Meas MPR	Low Channel (dBm)	Middle Channel (dBm)	High Channel (dBm)
1.4M	QPSK	RB1#0	0	0	20.18	20.37	20.4
		RB1#3	0	0	19.95	20.34	20.42
		RB1#5	0	0	20.08	20.21	<b>20.49</b>
		RB3#0	1	1	20.37	20.21	20.4
		RB3#3	1	1	20.35	20.18	20.31
		RB6#0	1	1	19.18	19.16	19.32
	16-QAM	RB1#0	1	1	18.99	19.66	20.15
		RB1#3	1	1	19.03	19.53	20.2
		RB1#5	2	2	18.94	19.59	<b>20.32</b>
		RB3#0	2	2	19.31	19.24	19.67
		RB3#3	2	2	19.36	19.03	19.58
		RB6#0	2	2	18.51	18.23	18.64
3M	QPSK	RB1#0	0	0	20.25	20.11	20.17
		RB1#8	0	0	20.29	19.97	<b>20.32</b>
		RB1#14	0	0	20.23	20.14	20.29
		RB6#0	1	1	19.15	19.18	19.22
		RB6#9	1	1	19.32	19.15	19.38
		RB15#0	1	1	19.42	19.27	19.41
	16-QAM	RB1#0	1	1	19.9	18.74	19.55
		RB1#8	1	1	19.97	18.91	19.67
		RB1#14	1	1	<b>19.98</b>	18.94	19.53
		RB6#0	2	2	18.4	18.05	18.5
		RB6#9	2	2	18.35	18.13	18.52
		RB15#0	2	2	18.25	18.27	18.47
5M	QPSK	RB1#0	0	0	20.25	19.96	20.13
		RB1#13	0	0	20.26	20.04	20.26
		RB1#24	0	0	<b>20.31</b>	20.08	20.16
		RB15#0	1	1	19.29	19.06	19.26
		RB15#10	1	1	19.13	19.29	19.45
		RB25#0	1	1	19.19	19.05	19.26
	16-QAM	RB1#0	1	1	19.32	19.17	18.45
		RB1#13	1	1	<b>19.47</b>	19.21	18.46
		RB1#24	1	1	19.37	19.2	18.51
		RB15#0	2	2	18.11	18.2	18.42
		RB15#10	2	2	18.35	18.24	18.51
		RB25#0	2	2	18.36	18.3	18.51



Test Bandwidth	Test Modulation	Resource Block & RB offset	Target MPR	Meas MPR	Low Channel (dBm)	Middle Channel (dBm)	High Channel (dBm)
10M	QPSK	RB1#0	0	0	20.28	20.17	20.18
		RB1#25	0	0	20.35	20	20.33
		RB1#49	1	1	20.36	20.12	<b>20.41</b>
		RB25#0	1	1	19.37	19.17	19.27
		RB25#25	1	1	19.18	19.18	19.37
		RB50#0	1	1	19.33	19.19	19.31
	16-QAM	RB1#0	1	1	19.36	18.87	19.55
		RB1#25	1	1	19.34	18.82	<b>19.82</b>
		RB1#49	1	1	19.37	18.82	19.75
		RB25#0	2	2	18.37	18.41	18.33
		RB25#25	2	2	18.47	18.41	18.44
		RB50#0	2	2	18.38	18.3	18.29
15M	QPSK	RB1#0	0	0	<b>20.37</b>	19.9	20.18
		RB1#38	0	0	20.25	20.06	20.17
		RB1#74	1	1	20.26	19.86	20.26
		RB36#0	1	1	19.2	19.21	19.2
		RB36#39	1	1	19.27	19.24	19.22
		RB75#0	1	1	19.15	19.18	19.21
	16-QAM	RB1#0	1	1	19.44	19.33	19.63
		RB1#38	1	1	19.44	19.33	19.67
		RB1#74	2	2	19.34	19.36	<b>19.8</b>
		RB36#0	2	2	18.47	18.29	18.17
		RB36#39	2	2	18.43	18.22	18.43
		RB75#0	2	2	18.38	18.11	18.38
20M	QPSK	RB1#0	0	0	20.22	20.07	20.15
		RB1#50	0	0	20.23	20.12	20.24
		RB1#99	0	0	20.18	20.17	<b>20.4</b>
		RB50#0	1	1	20.09	20.19	20.22
		RB50#50	1	1	19.88	19.66	19.51
		RB100#0	1	1	20.07	20.07	20.31
	16-QAM	RB1#0	1	1	19.44	<b>19.99</b>	19.38
		RB1#50	1	1	19.44	19.79	19.33
		RB1#99	2	2	19.48	19.97	19.43
		RB50#0	2	2	18.35	18.34	18.36
		RB50#50	2	2	18.33	18.25	18.52
		RB100#0	2	2	18.36	18.27	18.27

**LTE Band 5:**

Test Bandwidth	Test Modulation	Resource Block & RB offset	Target MPR	Meas MPR	Low Channel (dBm)	Middle Channel (dBm)	High Channel (dBm)
1.4M	QPSK	RB1#0	0	0	24.47	<b>24.48</b>	24.42
		RB1#3	0	0	24.31	24.44	24.27
		RB1#5	0	0	24.27	24.33	24.28
		RB3#0	1	1	24.43	24.46	24.17
		RB3#3	1	1	24.41	24.28	24.28
		RB6#0	1	1	23.35	23.16	23.31
	16-QAM	RB1#0	1	1	23.95	24	23.2
		RB1#3	1	1	23.97	<b>24.12</b>	23.26
		RB1#5	2	2	23.85	<b>24.12</b>	23.13
		RB3#0	2	2	23.54	23.34	23.08
		RB3#3	2	2	23.5	23.28	23.17
		RB6#0	2	2	22.7	22.45	22.32
3M	QPSK	RB1#0	0	0	24.33	24.33	24.3
		RB1#8	0	0	24.3	<b>24.4</b>	24.11
		RB1#14	1	1	24.28	24.27	24.28
		RB6#0	1	1	23.5	23.4	23.14
		RB6#9	1	1	23.26	23.32	23.19
		RB15#0	1	1	23.26	23.4	23.39
	16-QAM	RB1#0	1	1	<b>24.08</b>	22.85	23.45
		RB1#8	1	1	24	22.8	23.57
		RB1#14	2	2	<b>24.08</b>	22.73	23.38
		RB6#0	2	2	22.57	22.31	22.46
		RB6#9	2	2	22.55	22.48	22.43
		RB15#0	2	2	22.44	22.41	22.3
5M	QPSK	RB1#0	0	0	<b>24.47</b>	24.25	24.06
		RB1#13	0	0	24.46	24.06	24.13
		RB1#24	0	0	24.46	24.12	24.19
		RB15#0	1	1	23.29	23.27	23.24
		RB15#10	1	1	23.29	23.27	23.26
		RB25#0	1	1	23.32	23.4	23.3
	16-QAM	RB1#0	1	1	23.34	23.25	22.54
		RB1#13	1	1	23.44	23.25	22.47
		RB1#24	1	1	<b>23.45</b>	23.43	22.32
		RB15#0	2	2	22.33	22.23	22.35
		RB15#10	2	2	22.11	22.25	22.18
		RB25#0	2	2	22.42	22.4	22.27

Test Bandwidth	Test Modulation	Resource Block & RB offset	Target MPR	Meas MPR	Low Channel (dBm)	Middle Channel (dBm)	High Channel (dBm)
10M	QPSK	RB1#0	0	0	<b>24.49</b>	24.38	24.37
		RB1#25	0	0	24.3	24.15	24.09
		RB1#49	1	1	24.28	24.09	24.28
		RB25#0	1	1	23.32	23.23	23.26
		RB25#25	1	1	23.43	23.41	23.33
		RB50#0	1	1	23.36	23.32	23.18
	16-QAM	RB1#0	1	1	23.48	23.22	23.62
		RB1#25	1	1	23.45	22.98	<b>23.7</b>
		RB1#49	2	2	23.35	23	23.66
		RB25#0	2	2	22.51	22.49	22.33
		RB25#25	2	2	22.52	22.6	22.28
		RB50#0	2	2	22.38	22.32	22.21

## LTE Band 7:

Test Bandwidth	Test Modulation	Resource Block & RB offset	Target MPR	Meas MPR	Low Channel (dBm)	Middle Channel (dBm)	High Channel (dBm)
5M	QPSK	RB1#0	0	0	23.22	23.43	23.32
		RB1#13	0	0	23.27	<b>23.45</b>	23.44
		RB1#24	0	0	23.42	23.42	23.35
		RB15#0	1	1	22.34	22.46	22.44
		RB15#10	1	1	22.41	22.31	22.55
		RB25#0	1	1	22.16	22.42	22.43
	16-QAM	RB1#0	1	1	22.28	22.06	21.72
		RB1#13	1	1	<b>22.3</b>	22.07	21.81
		RB1#24	1	1	22.25	21.98	21.77
		RB15#0	2	2	21.29	21.48	21.48
		RB15#10	2	2	21.26	21.54	21.58
		RB25#0	2	2	21.45	21.39	21.57
10M	QPSK	RB1#0	0	0	23.15	23.34	23.32
		RB1#25	0	0	23.29	<b>23.46</b>	23.35
		RB1#49	1	1	23.36	23.35	23.26
		RB25#0	1	1	22.29	22.46	22.49
		RB25#25	1	1	22.3	22.34	22.49
		RB50#0	1	1	22.34	22.51	22.5
	16-QAM	RB1#0	1	1	22.92	21.85	22.66
		RB1#25	1	1	23.13	21.98	22.74
		RB1#49	2	2	<b>23.23</b>	21.89	22.77
		RB25#0	2	2	21.42	21.74	21.7
		RB25#25	2	2	21.59	21.63	21.56
		RB50#0	2	2	21.51	21.59	21.52
15M	QPSK	RB1#0	0	0	23.27	23.35	23.32
		RB1#38	0	0	23.33	<b>23.48</b>	23.29
		RB1#74	1	1	23.22	23.38	23.28
		RB36#0	1	1	22.39	22.37	22.55
		RB36#39	1	1	22.27	22.33	22.55
		RB75#0	1	1	22.28	22.51	22.47
	16-QAM	RB1#0	1	1	23	22.71	22.61
		RB1#38	1	1	23.05	22.74	22.65
		RB1#74	2	2	<b>23.22</b>	22.82	22.66
		RB36#0	2	2	21.44	21.63	21.67
		RB36#39	2	2	21.47	21.67	21.61
		RB75#0	2	2	21.43	21.48	21.69

Test Bandwidth	Test Modulation	Resource Block & RB offset	Target MPR	Meas MPR	Low Channel (dBm)	Middle Channel (dBm)	High Channel (dBm)
20M	QPSK	RB1#0	0	0	23.2	23.16	23.39
		RB1#50	0	0	23.31	23.3	23.36
		RB1#99	0	0	23.33	23.37	<b>23.45</b>
		RB50#0	1	1	22.94	22.86	22.76
		RB50#50	1	1	22.43	22.57	22.59
		RB100#0	1	1	22.49	22.44	22.41
	16-QAM	RB1#0	1	1	22.74	23.1	22.32
		RB1#50	1	1	22.89	23.26	22.62
		RB1#99	2	2	22.92	<b>23.39</b>	22.38
		RB50#0	2	2	21.56	21.46	21.58
		RB50#50	2	2	21.64	21.49	21.49
		RB100#0	2	2	21.51	21.6	21.69

**LTE Band 12:**

Test Bandwidth	Test Modulation	Resource Block & RB offset	Target MPR	Meas MPR	Low Channel (dBm)	Middle Channel (dBm)	High Channel (dBm)
1.4M	QPSK	RB1#0	0	0	23.83	23.85	23.85
		RB1#3	0	0	23.84	23.69	23.91
		RB1#5	0	0	<b>23.95</b>	23.86	23.74
		RB3#0	1	1	23.92	23.77	23.93
		RB3#3	1	1	23.69	23.79	23.88
		RB6#0	1	1	22.85	22.78	22.69
	16-QAM	RB1#0	1	1	23.62	22.75	23.19
		RB1#3	1	1	23.52	22.79	23.34
		RB1#5	2	2	23.52	22.98	<b>23.64</b>
		RB3#0	2	2	22.69	22.64	22.76
		RB3#3	2	2	22.71	22.5	22.74
RB6#0	2	2	21.78	21.77	21.77		
3M	QPSK	RB1#0	0	0	23.85	23.78	23.89
		RB1#8	0	0	<b>24</b>	23.79	23.88
		RB1#14	1	1	23.8	23.71	23.8
		RB6#0	1	1	22.95	22.69	22.97
		RB6#9	1	1	22.96	22.9	22.74
		RB15#0	1	1	22.81	22.8	22.92
	16-QAM	RB1#0	1	1	23.02	22.2	23.02
		RB1#8	1	1	23	22.21	<b>23.13</b>
		RB1#14	2	2	23.04	22.27	22.96
		RB6#0	2	2	21.92	21.85	21.87
		RB6#9	2	2	21.98	21.8	21.91
		RB15#0	2	2	21.86	21.77	21.92
5M	QPSK	RB1#0	0	0	<b>24.03</b>	23.69	23.69
		RB1#13	0	0	23.84	23.67	23.78
		RB1#24	0	0	23.88	23.65	23.78
		RB15#0	1	1	22.85	22.83	22.78
		RB15#10	1	1	22.73	22.78	22.88
		RB25#0	1	1	22.67	22.83	22.84
	16-QAM	RB1#0	1	1	22.71	22.66	21.87
		RB1#13	1	1	22.7	22.76	21.89
		RB1#24	1	1	22.69	<b>22.82</b>	21.97
		RB15#0	2	2	21.68	21.67	21.77
		RB15#10	2	2	21.64	21.61	21.79
		RB25#0	2	2	21.62	21.77	21.88

Test Bandwidth	Test Modulation	Resource Block & RB offset	Target MPR	Meas MPR	Low Channel (dBm)	Middle Channel (dBm)	High Channel (dBm)
10M	QPSK	RB1#0	0	0	23.82	23.72	23.74
		RB1#25	0	0	<b>23.92</b>	23.64	23.67
		RB1#49	1	1	23.77	23.8	23.87
		RB25#0	1	1	22.91	22.75	22.7
		RB25#25	1	1	22.76	22.85	22.88
		RB50#0	1	1	22.89	22.89	22.7
	16-QAM	RB1#0	1	1	<b>23.62</b>	22.55	22.88
		RB1#25	1	1	23.54	22.48	23.09
		RB1#49	2	2	23.48	22.51	22.88
		RB25#0	2	2	21.94	21.9	21.9
		RB25#25	2	2	21.82	22.15	21.88
		RB50#0	2	2	21.86	21.83	21.85

**LTE Band 41:**

Test Bandwidth	Test Modulation	Resource Block & RB offset	Target MPR	Meas MPR	Low Channel (dBm)	2570 MHz (dBm)	Middle Channel (dBm)	High Channel (dBm)
5M	QPSK	RB1#0	0	0	23.65	<b>23.78</b>	23.33	23.29
		RB1#13	0	0	23.49	23.57	23.32	23.21
		RB1#24	1	1	23.61	23.63	23.32	23.26
		RB15#0	1	1	22.62	22.54	22.42	22.3
		RB15#10	1	1	22.62	22.6	22.37	22.34
		RB25#0	1	1	22.41	22.68	22.25	22.33
	16-QAM	RB1#0	1	1	22.65	22.9	22.12	22.01
		RB1#13	1	1	22.22	<b>22.91</b>	22.08	22.11
		RB1#24	1	1	22.54	22.89	22.32	22.26
		RB15#0	2	2	21.62	21.87	21.51	21.55
		RB15#10	2	2	21.64	21.81	21.67	21.64
		RB25#0	2	2	21.74	21.82	21.3	21.17
10M	QPSK	RB1#0	0	0	23.53	23.63	23.38	23.51
		RB1#25	0	0	23.45	23.55	23.31	23.37
		RB1#49	0	0	<b>23.66</b>	<b>23.66</b>	23.62	23.52
		RB25#0	1	1	22.52	22.68	22.29	22.41
		RB25#25	1	1	22.66	22.6	22.37	22.35
		RB50#0	1	1	22.56	22.68	22.25	22.29
	16-QAM	RB1#0	1	1	22.74	22.51	22.42	22.45
		RB1#25	1	1	<b>22.8</b>	22.61	22.43	22.43
		RB1#49	2	2	22.56	22.51	22.38	22.49
		RB25#0	2	2	21.73	22.02	21.31	21.38
		RB25#25	2	2	21.7	22.08	21.4	21.27
		RB50#0	2	2	21.87	21.77	21.35	21.47
15M	QPSK	RB1#0	0	0	23.52	23.51	23.44	23.51
		RB1#38	0	0	23.52	<b>23.59</b>	23.51	23.34
		RB1#74	1	1	23.47	23.52	23.52	23.43
		RB36#0	1	1	22.34	22.58	22.56	22.44
		RB36#39	1	1	22.48	22.69	22.27	22.35
		RB75#0	1	1	22.38	22.67	22.5	22.4
	16-QAM	RB1#0	1	1	22.62	22.13	22.48	22.53
		RB1#38	1	1	22.54	22.22	22.52	22.6
		RB1#74	2	2	<b>22.83</b>	22.04	22.47	22.55
		RB36#0	2	2	21.45	21.99	21.38	21.53
		RB36#39	2	2	21.56	21.88	21.36	21.29
		RB75#0	2	2	21.62	21.82	21.42	21.53



Test Bandwidth	Test Modulation	Resource Block & RB offset	Target MPR	Meas MPR	Low Channel (dBm)	2570 MHz (dBm)	Middle Channel (dBm)	High Channel (dBm)
20M	QPSK	RB1#0	0	0	23.26	<b>23.83</b>	23.33	23.35
		RB1#50	0	0	23.6	23.68	23.42	23.29
		RB1#99	1	1	23.48	23.79	23.3	23.46
		RB50#0	1	1	22.39	22.71	22.35	22.5
		RB50#50	1	1	22.63	22.72	22.38	22.23
		RB100#0	1	1	22.41	22.61	22.39	22.45
	16-QAM	RB1#0	1	1	22.2	23.19	22.88	22.92
		RB1#50	1	1	22.4	<b>23.37</b>	22.75	22.7
		RB1#99	2	2	22.29	23.28	22.87	22.75
		RB50#0	2	2	21.5	21.75	21.63	21.7
		RB50#50	2	2	21.71	21.81	21.58	21.57
		RB100#0	2	2	21.55	21.63	21.5	21.64

**WLAN 2.4G:**

Mode	Channel frequency (MHz)	Data Rate	Duty cycle (%)	RF Output Power (dBm)
802.11b	2412	1Mbps	97.9	<b>12.81</b>
	2437			12.73
	2462			12.57
802.11g	2412	6Mbps	88.61	11.64
	2437			11.84
	2462			11.8
802.11n ht20	2412	MCS0	85.4	11.54
	2437			11.83
	2462			11.56
802.11n ht40	2422	MCS0	68.6	10.79
	2437			10.5
	2452			10.84

**Wi-Fi 5.2G:**

Mode	Channel frequency (MHz)	Data Rate	Duty cycle (%)	RF Output Power (dBm)
802.11a	5180	6Mbps	88.61	13.29
	5200			<b>13.46</b>
	5240			13.37
802.11ac20	5180	MCS0	86.76	12.89
	5200			12.69
	5240			12.61
802.11ac40	5190	MCS0	70.24	10.11
	5230			10.3
802.11ac80	5210	MCS0	63.04	10.67

**Wi-Fi 5.8G:**

Mode	Channel frequency (MHz)	Data Rate	Duty cycle (%)	RF Output Power (dBm)
802.11a	5745	6Mbps	88.61	7.72
	5785			7.87
	5825			7.62
802.11ac20	5745	MCS0	86.76	8.95
	5785			8.93
	5825			<b>8.98</b>
802.11ac40	5755	MCS0	70.24	8.02
	5795			8.06
802.11ac80	5775	MCS0	63.04	7.3

**Bluetooth:**

Mode	Channel frequency (MHz)	RF Output Power (dBm)
BDR(GFSK)	2402	-2.69
	2441	-2.96
	2480	-1.79
EDR( $\pi/4$ -DQPSK)	2402	-3.05
	2441	-3.04
	2480	-1.47
EDR(8DPSK)	2402	-2.69
	2441	-2.71
	2480	<b>-1.15</b>
BLE_1M	2402	-1.78
	2440	-1.86
	2480	<b>-0.65</b>
BLE_2M	2402	-1.73
	2440	-1.9
	2480	<b>-0.73</b>

## 7. Standalone SAR test exclusion considerations

### Antennas Location:

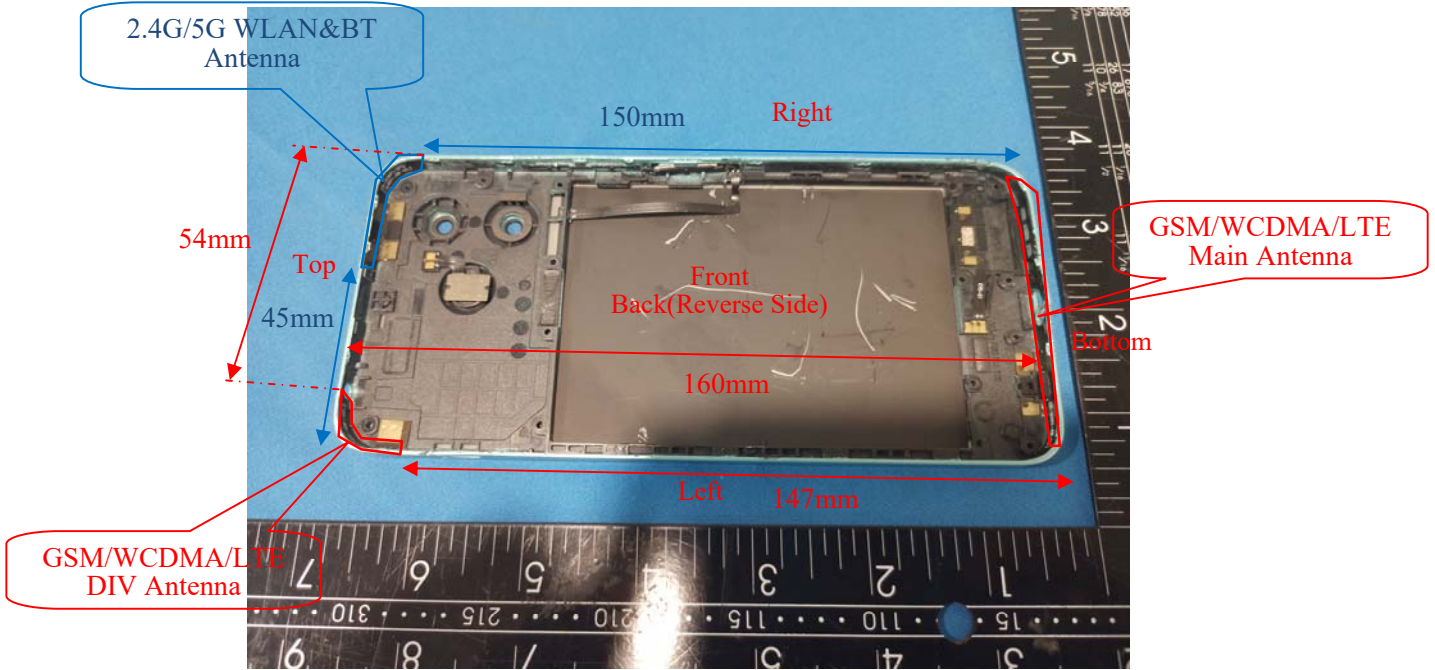

### 7.1 Antenna Distance To Edge

Antenna Distance To Edge(mm)						
Antenna	Back	Front	Left	Right	Top	Bottom
WWAN(GSM/WCDMA/LTE) Main Antenna	< 5	< 5	< 5	< 5	160	< 5
WWAN(GSM/WCDMA/LTE) DIV Antenna	< 5	< 5	< 5	54	< 5	147
2.4G/5G WLAN&BT Antenna	< 5	< 5	45	< 5	< 5	150

#### Each antenna supports the following frequency bands:

WWAN(GSM/WCDMA/LTE) Main Antenna:  
 GSM 850/WCDMA Band 5/LTE Band 5/LTE Band 7/LTE BAND 12/LTE BAND 41;

WWAN(GSM/WCDMA/LTE) DIV Antenna:  
 PCS 1900/WCDMA BAND 2/LTE BAND 2.

## 7.2 Standalone SAR test exclusion considerations

Mode	Frequency (MHz)	Output Power (dBm)	Output Power (mW)	Distance (mm)	Calculated value	Threshold (1-g)	SAR Test Exclusion
WLAN 2.4G	2462	13	19.953	0	6.3	3	NO
WLAN 5.2G	5240	13.5	22.387	0	10.2	3	NO
WLAN 5.8G	5825	9	7.943	0	3.8	3	NO
Bluetooth	2480	-0.5	0.891	0	0.3	3	YES

*Note: The Wi-Fi based average power for calculation, The bluetooth based peak power for calculation.*

### NOTE:

The 1-g and 10-g SAR test exclusion thresholds for 100 MHz to 6 GHz at test separation distances  $\leq 50$  mm are determined by:

$[(\text{max. power of channel, including tune-up tolerance, mW}) / (\text{min. test separation distance, mm})] \cdot [\sqrt{f(\text{GHz})}] \leq 3.0$  for 1-g SAR and  $\leq 7.5$  for 10-g extremity SAR, where

- f(GHz) is the RF channel transmit frequency in GHz.
- Power and distance are rounded to the nearest mW and mm before calculation.
- The result is rounded to one decimal place for comparison.
- When the minimum test separation distance is  $< 5$  mm, a distance of 5 mm is applied to determine SAR test Exclusion.

### 7.3 Standalone SAR estimation:

Mode	Frequency (MHz)	Output Power (dBm)	Output Power (mW)	Distance (mm)	Estimated 1-g (W/kg)
Bluetooth Head	2480	-0.5	0.891	0	0.04
Bluetooth Body	2480	-0.5	0.891	10	0.02

When standalone SAR test exclusion applies to an antenna that transmits simultaneously with other antennas, the standalone SAR must be estimated according to following to determine simultaneous transmission SAR test exclusion:

$[(\text{max. power of channel, including tune-up tolerance, mW}) / (\text{min. test separation distance, mm})] \cdot [\sqrt{f(\text{GHz})} / x]$

W/kg for test separation distances  $\leq 50$  mm;

where  $x = 7.5$  for 1-g SAR.

When the minimum test separation distance is  $< 5$  mm, a distance of 5 mm is applied to determine SAR test Exclusion.

### 7.4 SAR test exclusion for the EUT edge considerations Result

Mode	Antenna Distance To Edge(mm)					
	Back	Front	Left	Right	Top	Bottom
WWAN(GSM/WCDMA/LTE) Main	Required	Required	Required	Required	Exclusion	Required
WWAN(GSM/WCDMA/LTE) DIV	Required	Required	Required	Exclusion	Required	Exclusion
2.4G/5.2G WLAN	Required	Required	Exclusion	Required	Required	Exclusion
BT	Exclusion*	Exclusion*	Exclusion*	Exclusion*	Exclusion*	Exclusion*

**Note:**

**Required:** The distance to Edge is less than 25mm, testing is required.

**Exclusion\*:** SAR test exclusion evaluation has been done above.

**Exclusion:** The distance to Edge is more than 25 mm, testing is not required.

**Extremity Exposure Considerations**

Per KDB 648474 D04 D04v01r03, this device is considered a “Phablet” since the diagonal dimension is >160mm and < 200mm, when hotspot mode applies, extremity SAR is required only for the surfaces and edges with hotspot mode scaled to the maximum output power (with tolerance is 1g SAR > 1.2W/kg)

Extremity Exposure Condition		
Worst Mode	Hotspot SAR value	Extremity Condition Test
LTE Band 7	1.12W/kg@1g	Exclusion

## 8. SAR MEASUREMENT RESULTS

---

This page summarizes the results of the performed dosimetric evaluation.

### 8.1 SAR Test Data

#### Environmental Conditions

<b>Temperature:</b>	21.8-22.5 °C	22.4-23.2 °C	22.1-22.9 °C	22.4-23.1 °C	22.6-23.4 °C
<b>Relative Humidity:</b>	52 %	61 %	57 %	62 %	59 %
<b>ATM Pressure:</b>	99.9 kPa	100.2 kPa	100.1 kPa	100.3 kPa	100.2 kPa
<b>Test Date:</b>	2023/06/30	2023/07/01	2023/07/02	2023/07/03	2023/07/04

*Testing was performed by Carl Chen, Weidong Lu, Jaime Zong.*

**GSM 850:**

EUT Position	Frequency (MHz)	Test Mode	Max. Meas. Power (dBm)	Max. Rated Power (dBm)	1g SAR (W/kg)			
					Scaled Factor	Meas. SAR	Scaled SAR	Plot
Head Left Cheek	824.2	GPRS	/	/	/	/	/	/
	836.6	GPRS	31.32	31.5	1.042	0.137	0.14	1#
	848.8	GPRS	/	/	/	/	/	/
Head Left Tilt	824.2	GPRS	/	/	/	/	/	/
	836.6	GPRS	31.32	31.5	1.042	0.107	0.11	2#
	848.8	GPRS	/	/	/	/	/	/
Head Right Cheek	824.2	GPRS	/	/	/	/	/	/
	836.6	GPRS	31.32	31.5	1.042	0.165	<b>0.17</b>	3#
	848.8	GPRS	/	/	/	/	/	/
Head Right Tilt	824.2	GPRS	/	/	/	/	/	/
	836.6	GPRS	31.32	31.5	1.042	0.104	0.11	4#
	848.8	GPRS	/	/	/	/	/	/
Body Worn Front (10mm)	824.2	GSM	/	/	/	/	/	/
	836.6	GSM	33.19	33.5	1.074	0.193	0.21	5#
	848.8	GSM	/	/	/	/	/	/
Body Worn Back (10mm)	824.2	GSM	/	/	/	/	/	/
	836.6	GSM	33.19	33.5	1.074	0.192	0.21	6#
	848.8	GSM	/	/	/	/	/	/
Body Front (10mm)	824.2	GPRS	/	/	/	/	/	/
	836.6	GPRS	31.32	31.5	1.042	0.152	0.16	7#
	848.8	GPRS	/	/	/	/	/	/
Body Back (10mm)	824.2	GPRS	31.25	31.5	1.059	0.182	0.19	8#
	836.6	GPRS	31.32	31.5	1.042	0.204	0.21	9#
	848.8	GPRS	31.39	31.5	1.026	0.21	<b>0.22</b>	10#
Body Left (10mm)	824.2	GPRS	/	/	/	/	/	/
	836.6	GPRS	31.32	31.5	1.042	0.098	0.10	11#
	848.8	GPRS	/	/	/	/	/	/
Body Right (10mm)	824.2	GPRS	/	/	/	/	/	/
	836.6	GPRS	31.32	31.5	1.042	0.142	0.15	12#
	848.8	GPRS	/	/	/	/	/	/
Body Bottom (10mm)	824.2	GPRS	/	/	/	/	/	/
	836.6	GPRS	31.32	31.5	1.042	0.166	0.17	13#
	848.8	GPRS	/	/	/	/	/	/

*The data above was performed on 2023/07/03.*

**Note7**

1. When the 1-g SAR is  $\leq 0.8\text{W/Kg}$ , testing for other channels are optional.
2. The EUT transmit and receive through the same GSM antenna while testing SAR.
3. When SAR or MPE is not measured at the maximum power level allowed for production units, the results must be scaled to the maximum tune-up tolerance limit according to the power applied to the individual channels tested to determine compliance.



4. When the maximum output power variation across the required test channels is  $> 0.5$  dB, instead of the middle channel, the highest output power channel must be used.
5. The Multi-slot Classes of EUT is Class 12 which has maximum 4 Downlink slots and 4 Uplink slots, the maximum active slots is 5, when perform the multiple slots scan, 3DL+2UL is the worst case.

**PCS 1900:**

EUT Position	Frequency (MHz)	Test Mode	Max. Meas. Power (dBm)	Max. Rated Power (dBm)	1g SAR (W/kg)			
					Scaled Factor	Meas. SAR	Scaled SAR	Plot
Head Left Cheek	1850.2	GPRS	/	/	/	/	/	/
	1880	GPRS	26.06	26.5	1.107	0.539	0.60	14#
	1909.8	GPRS	/	/	/	/	/	/
Head Left Tilt	1850.2	GPRS	/	/	/	/	/	/
	1880	GPRS	26.06	26.5	1.107	0.701	0.78	15#
	1909.8	GPRS	/	/	/	/	/	/
Head Right Cheek	1850.2	GPRS	26.36	26.5	1.033	0.764	0.79	16#
	1880	GPRS	26.06	26.5	1.107	0.813	<b>0.90</b>	17#
	1909.8	GPRS	26.22	26.5	1.067	0.83	0.89	18#
Head Right Tilt	1850.2	GPRS	/	/	/	/	/	/
	1880	GPRS	26.06	26.5	1.107	0.682	0.75	19#
	1909.8	GPRS	/	/	/	/	/	/
Body Worn Front (10mm)	1850.2	GSM	/	/	/	/	/	/
	1880	GSM	29.51	30	1.119	0.256	0.29	20#
	1909.8	GSM	/	/	/	/	/	/
Body Worn Back (10mm)	1850.2	GSM	/	/	/	/	/	/
	1880	GSM	29.51	30	1.119	0.328	0.37	21#
	1909.8	GSM	/	/	/	/	/	/
Body Front (10mm)	1850.2	GPRS	/	/	/	/	/	/
	1880	GPRS	26.06	26.5	1.107	0.228	0.25	22#
	1909.8	GPRS	/	/	/	/	/	/
Body Back (10mm)	1850.2	GPRS	/	/	/	/	/	/
	1880	GPRS	26.06	26.5	1.107	0.267	<b>0.30</b>	23#
	1909.8	GPRS	/	/	/	/	/	/
Body Left (10mm)	1850.2	GPRS	/	/	/	/	/	/
	1880	GPRS	26.06	26.5	1.107	0.259	0.29	24#
	1909.8	GPRS	/	/	/	/	/	/
Body Top (10mm)	1850.2	GPRS	/	/	/	/	/	/
	1880	GPRS	26.06	26.5	1.107	0.249	0.28	25#
	1909.8	GPRS	/	/	/	/	/	/

**Note:**

1. When the 1-g SAR is  $\leq 0.8\text{W/Kg}$ , testing for other channels are optional.
2. The EUT transmit and receive through the same GSM antenna while testing SAR.
3. When SAR or MPE is not measured at the maximum power level allowed for production units, the results must be scaled to the maximum tune-up tolerance limit according to the power applied to the individual channels tested to determine compliance.
4. When the maximum output power variation across the required test channels is  $> 0.5\text{ dB}$ , instead of the middle channel, the highest output power channel must be used.
5. The Multi-slot Classes of EUT is Class 12 which has maximum 4 Downlink slots and 4 Uplink slots, the maximum active slots is 5, when perform the multiple slots scan, 2DL+3UL is the worst case.

**WCDMA Band 2:**

EUT Position	Frequency (MHz)	Test Mode	Max. Meas. Power (dBm)	Max. Rated Power (dBm)	1g SAR (W/kg)			
					Scaled Factor	Meas. SAR	Scaled SAR	Plot
Head Left Cheek	1852.4	RMC	/	/	/	/	/	/
	1880	RMC	21.37	21.50	1.03	0.604	0.62	26#
	1907.6	RMC	/	/	/	/	/	/
Head Left Tilt	1852.4	RMC	/	/	/	/	/	/
	1880	RMC	21.37	21.50	1.03	0.654	0.67	27#
	1907.6	RMC	/	/	/	/	/	/
Head Right Cheek	1852.4	RMC	21.33	21.50	1.04	1.02	<b>1.06</b>	28#
	1880	RMC	21.37	21.50	1.03	1.01	1.04	29#
	1907.6	RMC	21.29	21.50	1.05	0.821	0.86	30#
Head Right Tilt	1852.4	RMC	/	/	/	/	/	/
	1880	RMC	21.37	21.50	1.03	0.666	0.69	31#
	1907.6	RMC	/	/	/	/	/	/
Body Front (10mm)	1852.4	RMC	/	/	/	/	/	/
	1880	RMC	21.37	21.50	1.03	0.265	0.27	32#
	1907.6	RMC	/	/	/	/	/	/
Body Back (10mm)	1852.4	RMC	/	/	/	/	/	/
	1880	RMC	21.37	21.50	1.03	0.251	0.26	33#
	1907.6	RMC	/	/	/	/	/	/
Body Left (10mm)	1852.4	RMC	/	/	/	/	/	/
	1880	RMC	21.37	21.50	1.03	0.357	<b>0.37</b>	34#
	1907.6	RMC	/	/	/	/	/	/
Body Top (10mm)	1852.4	RMC	/	/	/	/	/	/
	1880	RMC	21.37	21.50	1.03	0.285	0.29	35#
	1907.6	RMC	/	/	/	/	/	/

**WCDMA Band 5:**

EUT Position	Frequency (MHz)	Test Mode	Max. Meas. Power (dBm)	Max. Rated Power (dBm)	1g SAR (W/kg)			
					Scaled Factor	Meas. SAR	Scaled SAR	Plot
Head Left Cheek	826.4	RMC	/	/	/	/	/	/
	836.6	RMC	23.55	24.00	1.109	0.14	0.16	36#
	846.6	RMC	/	/	/	/	/	/
Head Left Tilt	826.4	RMC	/	/	/	/	/	/
	836.6	RMC	23.55	24.00	1.109	0.077	0.09	37#
	846.6	RMC	/	/	/	/	/	/
Head Right Cheek	826.4	RMC	/	/	/	/	/	/
	836.6	RMC	23.55	24.00	1.109	0.17	<b>0.19</b>	38#
	846.6	RMC	/	/	/	/	/	/
Head Right Tilt	826.4	RMC	/	/	/	/	/	/
	836.6	RMC	23.55	24.00	1.109	0.078	0.09	39#
	846.6	RMC	/	/	/	/	/	/
Body Front (10mm)	826.4	RMC	/	/	/	/	/	/
	836.6	RMC	23.55	24.00	1.109	0.165	0.18	40#
	846.6	RMC	/	/	/	/	/	/
Body Back (10mm)	826.4	RMC	23.79	24.00	1.05	0.16	0.17	41#
	836.6	RMC	23.55	24.00	1.109	0.213	<b>0.24</b>	42#
	846.6	RMC	23.89	24.00	1.026	0.187	0.19	43#
Body Left (10mm)	826.4	RMC	/	/	/	/	/	/
	836.6	RMC	23.55	24.00	1.109	0.117	0.13	44#
	846.6	RMC	/	/	/	/	/	/
Body Right (10mm)	826.4	RMC	/	/	/	/	/	/
	836.6	RMC	23.55	24.00	1.109	0.167	0.19	45#
	846.6	RMC	/	/	/	/	/	/
Body Bottom (10mm)	826.4	RMC	/	/	/	/	/	/
	836.6	RMC	23.55	24.00	1.109	0.171	0.19	46#
	846.6	RMC	/	/	/	/	/	/

*The data above was performed on 2023/07/03.*

**Note:**

1. When the 1-g SAR is  $\leq 0.8\text{W/Kg}$ , testing for other channels are optional.
2. The EUT transmit and receive through the same antenna while testing SAR.
3. The default test configuration is to measure SAR with an established radio link between the EUT and a communication test set using a 12.2 kbps RMC (reference measurement Channel) Configured in Test Loop Model.
4. KDB 941225 D01-Body SAR is not required for HSDPA/HSUPA/HSPA+ when the maximum average output of each RF channel is less than  $\frac{1}{4}$  dB higher than measured 12.2kbps RMC or the maximum SAR for 12.2kbps RMC is  $< 75\%$  of SAR limit.
5. When SAR or MPE is not measured at the maximum power level allowed for production units, the results must be scaled to the maximum tune-up tolerance limit according to the power applied to the individual channels tested to determine compliance.

**LTE Band 2:**

EUT Position	Frequency (MHz)	Bandwidth (MHz)	Test Mode	Max. Meas. Power (dBm)	Max. Rated Power (dBm)	1g SAR (W/kg)			
						Scaled Factor	Meas. SAR	Scaled SAR	Plot
Head Left Cheek	1860	20	1RB	/	/	/	/	/	/
	1880	20	1RB	20.17	20.5	1.079	0.577	0.62	47#
	1900	20	1RB	/	/	/	/	/	/
	1880	20	50%RB	20.19	20.5	1.074	0.554	0.59	48#
Head Left Tilt	1860	20	1RB	/	/	/	/	/	/
	1880	20	1RB	20.17	20.5	1.079	0.644	0.69	49#
	1900	20	1RB	/	/	/	/	/	/
	1880	20	50%RB	20.19	20.5	1.074	0.605	0.65	50#
Head Right Cheek	1860	20	1RB	20.23	20.5	1.064	0.795	0.85	51#
	1880	20	1RB	20.17	20.5	1.079	0.939	1.01	52#
	1900	20	1RB	20.4	20.5	1.023	1.04	1.06	53#
	1860	20	50%RB	20.09	20.5	1.099	0.846	0.93	54#
	1880	20	50%RB	20.19	20.5	1.074	0.899	0.97	55#
	1900	20	50%RB	20.22	20.5	1.067	1.05	<b>1.12</b>	56#
	1900	20	100%RB	20.31	20.5	1.045	1.02	1.07	57#
Head Right Tilt	1860	20	1RB	/	/	/	/	/	/
	1880	20	1RB	20.17	20.5	1.079	0.646	0.70	58#
	1900	20	1RB	/	/	/	/	/	/
	1880	20	50%RB	20.19	20.5	1.074	0.629	0.68	59#
Body Front (10mm)	1860	20	1RB	/	/	/	/	/	/
	1880	20	1RB	20.17	20.5	1.079	0.478	0.52	60#
	1900	20	1RB	/	/	/	/	/	/
	1880	20	50%RB	20.19	20.5	1.074	0.388	0.42	61#
Body Back (10mm)	1860	20	1RB	/	/	/	/	/	/
	1880	20	1RB	20.17	20.5	1.079	0.489	0.53	62#
	1900	20	1RB	/	/	/	/	/	/
	1880	20	50%RB	20.19	20.5	1.074	0.417	0.45	63#
Body Left (10mm)	1860	20	1RB	/	/	/	/	/	/
	1880	20	1RB	20.17	20.5	1.079	0.554	<b>0.60</b>	64#
	1900	20	1RB	/	/	/	/	/	/
	1880	20	50%RB	20.19	20.5	1.074	0.444	0.48	65#
Body Top (10mm)	1860	20	1RB	/	/	/	/	/	/
	1880	20	1RB	20.17	20.5	1.079	0.083	0.09	66#
	1900	20	1RB	/	/	/	/	/	/
	1880	20	50%RB	20.19	20.5	1.074	0.068	0.07	67#

**LTE Band 5:**

EUT Position	Frequency (MHz)	Bandwidth (MHz)	Test Mode	Max. Meas. Power (dBm)	Max. Rated Power (dBm)	1g SAR (W/kg)			
						Scaled Factor	Meas. SAR	Scaled SAR	Plot
Head Left Cheek	829	10	1RB	/	/	/	/	/	/
	836.5	10	1RB	24.38	24.5	1.028	0.078	0.08	68#
	844	10	1RB	/	/	/	/	/	/
	836.5	10	50%RB	23.41	24.5	1.285	0.073	0.09	69#
Head Left Tilt	829	10	1RB	/	/	/	/	/	/
	836.5	10	1RB	24.38	24.5	1.028	0.131	0.13	70#
	844	10	1RB	/	/	/	/	/	/
	836.5	10	50%RB	23.41	24.5	1.285	0.111	0.14	71#
Head Right Cheek	829	10	1RB	/	/	/	/	/	/
	836.5	10	1RB	24.38	24.5	1.028	0.222	0.23	72#
	844	10	1RB	/	/	/	/	/	/
	836.5	10	50%RB	23.41	24.5	1.285	0.185	<b>0.24</b>	73#
Head Right Tilt	829	10	1RB	/	/	/	/	/	/
	836.5	10	1RB	24.38	24.5	1.028	0.118	0.12	74#
	844	10	1RB	/	/	/	/	/	/
	836.5	10	50%RB	23.41	24.5	1.285	0.1	0.13	75#
Body Front (10mm)	829	10	1RB	/	/	/	/	/	/
	836.5	10	1RB	24.38	24.5	1.028	0.205	0.21	76#
	844	10	1RB	/	/	/	/	/	/
	836.5	10	50%RB	23.41	24.5	1.285	0.175	0.22	77#
Body Back (10mm)	829	10	1RB	24.49	24.5	1.002	0.266	0.27	78#
	836.5	10	1RB	24.38	24.5	1.028	0.264	0.27	79#
	844	10	1RB	24.37	24.5	1.03	0.324	<b>0.33</b>	80#
	836.5	10	50%RB	23.41	24.5	1.285	0.225	0.29	81#
Body Left (10mm)	829	10	1RB	/	/	/	/	/	/
	836.5	10	1RB	24.38	24.5	1.028	0.097	0.10	82#
	844	10	1RB	/	/	/	/	/	/
	836.5	10	50%RB	23.41	24.5	1.285	0.08	0.10	83#
Body Right (10mm)	829	10	1RB	/	/	/	/	/	/
	836.5	10	1RB	24.38	24.5	1.028	0.115	0.12	84#
	844	10	1RB	/	/	/	/	/	/
	836.5	10	50%RB	23.41	24.5	1.285	0.091	0.12	85#
Body Bottom (10mm)	829	10	1RB	/	/	/	/	/	/
	836.5	10	1RB	24.38	24.5	1.028	0.266	0.27	86#
	844	10	1RB	/	/	/	/	/	/
	836.5	10	50%RB	23.41	24.5	1.285	0.228	0.29	87#

*The data above was performed on 2023/07/04.*

**LTE Band 7:**

EUT Position	Frequency (MHz)	Bandwidth (MHz)	Test Mode	Max. Meas. Power (dBm)	Max. Rated Power (dBm)	1g SAR (W/kg)			
						Scaled Factor	Meas. SAR	Scaled SAR	Plot
Head Left Cheek	2510	20	1RB	/	/	/	/	/	/
	2535	20	1RB	23.37	23.5	1.03	0.378	<b>0.39</b>	88#
	2560	20	1RB	/	/	/	/	/	/
	2535	20	50%RB	22.86	23.5	1.159	0.281	0.33	89#
Head Left Tilt	2510	20	1RB	/	/	/	/	/	/
	2535	20	1RB	23.37	23.5	1.03	0.169	0.17	90#
	2560	20	1RB	/	/	/	/	/	/
	2535	20	50%RB	22.86	23.5	1.159	0.129	0.15	91#
Head Right Cheek	2510	20	1RB	/	/	/	/	/	/
	2535	20	1RB	23.37	23.5	1.03	0.247	0.25	92#
	2560	20	1RB	/	/	/	/	/	/
	2535	20	50%RB	22.86	23.5	1.159	0.188	0.22	93#
Head Right Tilt	2510	20	1RB	/	/	/	/	/	/
	2535	20	1RB	23.37	23.5	1.03	0.265	0.27	94#
	2560	20	1RB	/	/	/	/	/	/
	2535	20	50%RB	22.86	23.5	1.159	0.189	0.22	95#
Body Front (10mm)	2510	20	1RB	/	/	/	/	/	/
	2535	20	1RB	23.37	23.5	1.03	0.6	0.62	96#
	2560	20	1RB	/	/	/	/	/	/
	2535	20	50%RB	22.86	23.5	1.159	0.421	0.49	97#
Body Back (10mm)	2510	20	1RB	23.33	23.5	1.04	1.02	1.06	98#
	2535	20	1RB	23.37	23.5	1.03	1.09	<b>1.12</b>	99#
	2560	20	1RB	23.45	23.5	1.012	0.915	0.93	100#
	2510	20	50%RB	22.94	23.5	1.138	0.951	1.08	101#
	2535	20	50%RB	22.86	23.5	1.159	0.764	0.89	102#
	2560	20	50%RB	22.76	23.5	1.186	0.853	1.01	103#
	2535	20	100%RB	22.44	23.5	1.276	0.623	0.79	104#
Body Left (10mm)	2510	20	1RB	/	/	/	/	/	/
	2535	20	1RB	23.37	23.5	1.03	0.629	0.65	105#
	2560	20	1RB	/	/	/	/	/	/
	2535	20	50%RB	22.86	23.5	1.159	0.467	0.54	106#
Body Right (10mm)	2510	20	1RB	/	/	/	/	/	/
	2535	20	1RB	23.37	23.5	1.03	0.112	0.12	107#
	2560	20	1RB	/	/	/	/	/	/
	2535	20	50%RB	22.86	23.5	1.159	0.088	0.10	108#
Body Bottom (10mm)	2510	20	1RB	/	/	/	/	/	/
	2535	20	1RB	23.37	23.5	1.03	0.447	0.46	109#
	2560	20	1RB	/	/	/	/	/	/
	2535	20	50%RB	22.86	23.5	1.159	0.356	0.41	110#

**LTE Band 12:**

EUT Position	Frequency (MHz)	Bandwidth (MHz)	Test Mode	Max. Meas. Power (dBm)	Max. Rated Power (dBm)	1g SAR (W/kg)			
						Scaled Factor	Meas. SAR	Scaled SAR	Plot
Head Left Cheek	704	10	1RB	/	/	/	/	/	/
	707.5	10	1RB	23.8	24.5	1.175	0.14	0.16	111#
	711	10	1RB	/	/	/	/	/	/
	707.5	10	50%RB	22.85	24.5	1.462	0.108	0.16	112#
Head Left Tilt	704	10	1RB	/	/	/	/	/	/
	707.5	10	1RB	23.8	24.5	1.175	0.053	0.06	113#
	711	10	1RB	/	/	/	/	/	/
	707.5	10	50%RB	22.85	24.5	1.462	0.059	0.09	114#
Head Right Cheek	704	10	1RB	/	/	/	/	/	/
	707.5	10	1RB	23.8	24.5	1.175	0.14	0.16	115#
	711	10	1RB	/	/	/	/	/	/
	707.5	10	50%RB	22.85	24.5	1.462	0.117	<b>0.17</b>	116#
Head Right Tilt	704	10	1RB	/	/	/	/	/	/
	707.5	10	1RB	23.8	24.5	1.175	0.063	0.07	117#
	711	10	1RB	/	/	/	/	/	/
	707.5	10	50%RB	22.85	24.5	1.462	0.047	0.07	118#
Body Front (10mm)	704	10	1RB	/	/	/	/	/	/
	707.5	10	1RB	23.8	24.5	1.175	0.176	0.21	119#
	711	10	1RB	/	/	/	/	/	/
	707.5	10	50%RB	22.85	24.5	1.462	0.141	0.21	120#
Body Back (10mm)	704	10	1RB	/	/	/	/	/	/
	707.5	10	1RB	23.8	24.5	1.175	0.184	0.22	121#
	711	10	1RB	/	/	/	/	/	/
	707.5	10	50%RB	22.85	24.5	1.462	0.172	0.25	122#
Body Left (10mm)	704	10	1RB	/	/	/	/	/	/
	707.5	10	1RB	23.8	24.5	1.175	0.171	0.20	123#
	711	10	1RB	/	/	/	/	/	/
	707.5	10	50%RB	22.85	24.5	1.462	0.135	0.20	124#
Body Right (10mm)	704	10	1RB	23.92	24.5	1.143	0.217	<b>0.25</b>	125#
	707.5	10	1RB	23.8	24.5	1.175	0.213	0.25	126#
	711	10	1RB	23.87	24.5	1.156	0.216	0.25	127#
	707.5	10	50%RB	22.85	24.5	1.462	0.171	0.25	128#
Body Bottom (10mm)	704	10	1RB	/	/	/	/	/	/
	707.5	10	1RB	23.8	24.5	1.175	0.079	0.09	129#
	711	10	1RB	/	/	/	/	/	/
	707.5	10	50%RB	22.85	24.5	1.462	0.067	0.10	130#

*The data above was performed on 2023/07/04.*



## LTE Band 41:

EUT Position	Frequency (MHz)	Bandwidth (MHz)	Test Mode	Max. Meas. Power (dBm)	Max. Rated Power (dBm)	1g SAR (W/kg)			
						Scaled Factor	Meas. SAR	Scaled SAR	Plot
Head Left Cheek	2545	20	1RB	/	/	/	/	/	/
	2570	20	1RB	/	/	/	/	/	/
	2595	20	1RB	23.42	24	1.143	0.207	<b>0.24</b>	131#
	2645	20	1RB	/	/	/	/	/	/
	2595	20	50%RB	22.38	24	1.452	0.167	0.24	132#
Head Left Tilt	2545	20	1RB	/	/	/	/	/	/
	2570	20	1RB	/	/	/	/	/	/
	2595	20	1RB	23.42	24	1.143	0.083	0.10	133#
	2645	20	1RB	/	/	/	/	/	/
	2595	20	50%RB	22.38	24	1.452	0.068	0.10	134#
Head Right Cheek	2545	20	1RB	/	/	/	/	/	/
	2570	20	1RB	/	/	/	/	/	/
	2595	20	1RB	23.42	24	1.143	0.123	0.14	135#
	2645	20	1RB	/	/	/	/	/	/
	2595	20	50%RB	22.38	24	1.452	0.089	0.13	136#
Head Right Tilt	2545	20	1RB	/	/	/	/	/	/
	2570	20	1RB	/	/	/	/	/	/
	2595	20	1RB	23.42	24	1.143	0.116	0.13	137#
	2645	20	1RB	/	/	/	/	/	/
	2595	20	50%RB	22.38	24	1.452	0.094	0.14	138#
Body Front (10mm)	2545	20	1RB	/	/	/	/	/	/
	2570	20	1RB	/	/	/	/	/	/
	2595	20	1RB	23.42	24	1.143	0.3	0.34	139#
	2645	20	1RB	/	/	/	/	/	/
	2595	20	50%RB	22.38	24	1.452	0.234	0.34	140#
Body Back (10mm)	2545	20	1RB	23.6	24	1.096	0.526	<b>0.58</b>	141#
	2570	20	1RB	23.83	24	1.04	0.498	0.52	142#
	2595	20	1RB	23.42	24	1.143	0.499	0.57	143#
	2645	20	1RB	23.46	24	1.132	0.427	0.48	144#
	2595	20	50%RB	22.38	24	1.452	0.354	0.51	145#
Body Left (10mm)	2545	20	1RB	/	/	/	/	/	/
	2570	20	1RB	/	/	/	/	/	/
	2595	20	1RB	23.42	24	1.143	0.309	0.35	146#
	2645	20	1RB	/	/	/	/	/	/
	2595	20	50%RB	22.38	24	1.452	0.257	0.37	147#

EUT Position	Frequency (MHz)	Bandwidth (MHz)	Test Mode	Max. Meas. Power (dBm)	Max. Rated Power (dBm)	1g SAR (W/kg)			
						Scaled Factor	Meas. SAR	Scaled SAR	Plot
Body Right (10mm)	2545	20	1RB	/	/	/	/	/	/
	2570	20	1RB	/	/	/	/	/	/
	2595	20	1RB	23.42	24	1.143	0.084	0.10	148#
	2645	20	1RB	/	/	/	/	/	/
	2595	20	50%RB	22.38	24	1.452	0.069	0.10	149#
Body Bottom (10mm)	2545	20	1RB	/	/	/	/	/	/
	2570	20	1RB	/	/	/	/	/	/
	2595	20	1RB	23.42	24	1.143	0.28	0.32	150#
	2645	20	1RB	/	/	/	/	/	/
	2595	20	50%RB	22.38	24	1.452	0.226	0.33	151#

Note:

1. The frequency range of LTE Band 41 is 2535~ 2655MHz. Per KDB 447498 D01, according to the following formula Calculate  $N_c$  is 4.

KDB procedures, the following should be applied to determine the number of required test channels. The test channels should be evenly spread across the transmission frequency band of each wireless mode.<sup>14</sup>

$$N_c = \text{Round} \left\{ \left[ 100(f_{\text{high}} - f_{\text{low}}) / f_c \right]^{0.5} \times (f_c / 100)^{0.2} \right\},$$

where

- $N_c$  is the number of test channels, rounded to the nearest integer,
- $f_{\text{high}}$  and  $f_{\text{low}}$  are the highest and lowest channel frequencies within the transmission band,
- $f_c$  is the mid-band channel frequency,
- all frequencies are in MHz.

2. The power class 3 used for LTE Band 41 SAR testing.

**Note:**

1. When the 1-g SAR is  $\leq 0.8$ W/Kg, testing for other channels are optional.
2. SAR for LTE band exposure configurations is measured according to the procedures of KDB 941225 D05 SAR for LTE Devices v02.
3. KDB941225D05-SAR for higher order modulation is required only when the highest maximum output power for the configuration in the higher order modulation is  $> 0.5$  dB higher than the same configuration in QPSK or when the reported SAR for the QPSK configuration is  $> 1.45$  W/kg
4. KDB941225D05-For QPSK with 100% RB allocation, when the reported SAR measured for the Highest output power channel is  $< 1.45$  W/kg, tests for the remaining required test channels are optional.
5. KDB941225D05- For QPSK with 100% RB allocation, SAR is not required when the highest maximum output power for 100 % RB allocation is less than the highest maximum output power in 50% and 1 RB allocations and the highest reported SAR for 1 RB and 50% RB allocation are  $\leq 0.8$  W/kg.
6. KDB941225D05- Start with the largest channel bandwidth and measure SAR for QPSK with 1 RB allocation, using the RB offset and required test channel combination with the highest maximum output power among RB offset the upper edge, middle and lower edge of each required test channel.
7. KDB941225D05- other channel bandwidths SAR test is required when the highest maximum output power of a configuration requiring testing in the smaller channel bandwidth is  $> 0.5$  dB higher than the equivalent channel configurations in the largest channel bandwidth configuration or the reported SAR of a configuration for the largest channel bandwidth is  $> 1.45$  W/kg.
8. Worst case SAR for 50% RB allocation is selected to be tested.

**WLAN 2.4G:**

EUT Position	Frequency (MHz)	Test Mode	Max. Meas. Power (dBm)	Max. Rated Power (dBm)	1g SAR (W/kg)				
					Scaled Factor	Duty cycle Factor	Meas. SAR	Scaled SAR	Plot
Head Left Cheek	2412	802.11b	12.81	13.00	1.045	1.021	0.103	0.11	152#
	2437	802.11b	12.73	13.00	1.064	1.021	0.195	<b>0.21</b>	153#
	2462	802.11b	12.57	13.00	1.104	1.021	0.11	0.12	154#
Head Left Tilt	2412	802.11b	/	/	/	/	/	/	/
	2437	802.11b	12.73	13.00	1.064	1.021	0.172	0.19	155#
	2462	802.11b	/	/	/	/	/	/	/
Head Right Cheek	2412	802.11b	/	/	/	/	/	/	/
	2437	802.11b	12.73	13.00	1.064	1.021	0.127	0.14	156#
	2462	802.11b	/	/	/	/	/	/	/
Head Right Tilt	2412	802.11b	/	/	/	/	/	/	/
	2437	802.11b	12.73	13.00	1.064	1.021	0.153	0.17	157#
	2462	802.11b	/	/	/	/	/	/	/
Body Front (10mm)	2412	802.11b	/	/	/	/	/	/	/
	2437	802.11b	12.73	13.00	1.064	1.021	0.04	0.04	158#
	2462	802.11b	/	/	/	/	/	/	/
Body Back (10mm)	2412	802.11b	/	/	/	/	/	/	/
	2437	802.11b	12.73	13.00	1.064	1.021	0.059	<b>0.06</b>	159#
	2462	802.11b	/	/	/	/	/	/	/
Body Right (10mm)	2412	802.11b	/	/	/	/	/	/	/
	2437	802.11b	12.73	13.00	1.064	1.021	0.042	0.05	160#
	2462	802.11b	/	/	/	/	/	/	/
Body Top (10mm)	2412	802.11b	/	/	/	/	/	/	/
	2437	802.11b	12.73	13.00	1.064	1.021	0.032	0.03	161#
	2462	802.11b	/	/	/	/	/	/	/

**Note:**

1. When the 1-g SAR is  $\leq 0.8$ W/kg, testing for other channels are optional.
2. When SAR or MPE is not measured at the maximum power level allowed for production units, the results must be scaled to the maximum tune-up tolerance limit according to the power applied to the individual channels tested to determine compliance.
3. KDB 248227 D01-SAR measurement is not required for 2.4 GHz OFDM(802.11g/n) when the highest reported SAR for DSSS(802.11b) is  $\leq 1.2$  W/kg, and the output power for DSSS is not less than that for OFDM.

## WLAN 5.2G:

EUT Position	Frequency (MHz)	Test Mode	Max. Meas. Power (dBm)	Max. Rated Power (dBm)	1g SAR (W/kg)				
					Scaled Factor	Duty cycle Factor	Meas. SAR	Scaled SAR	Plot
Head Left Cheek	5180	802.11a	13.29	13.50	1.05	1.129	0.648	0.77	162#
	5200	802.11a	13.46	13.50	1.009	1.129	0.805	<b>0.92</b>	163#
	5240	802.11a	13.37	13.50	1.03	1.129	0.592	0.69	164#
Head Left Tilt	5180	802.11a	/	/	/	/	/	/	/
	5200	802.11a	13.46	13.50	1.009	1.129	0.552	0.63	165#
	5240	802.11a	/	/	/	/	/	/	/
Head Right Cheek	5180	802.11a	/	/	/	/	/	/	/
	5200	802.11a	13.46	13.50	1.009	1.129	0.369	0.42	166#
	5240	802.11a	/	/	/	/	/	/	/
Head Right Tilt	5180	802.11a	/	/	/	/	/	/	/
	5200	802.11a	13.46	13.50	1.009	1.129	0.462	0.53	167#
	5240	802.11a	/	/	/	/	/	/	/
Body Front (10mm)	5180	802.11a	/	/	/	/	/	/	/
	5200	802.11a	13.46	13.50	1.009	1.129	0.123	0.14	168#
	5240	802.11a	/	/	/	/	/	/	/
Body Back (10mm)	5180	802.11a	/	/	/	/	/	/	/
	5200	802.11a	13.46	13.50	1.009	1.129	0.173	0.20	169#
	5240	802.11a	/	/	/	/	/	/	/
Body Right (10mm)	5180	802.11a	/	/	/	/	/	/	/
	5200	802.11a	13.46	13.50	1.009	1.129	0.06	0.07	170#
	5240	802.11a	/	/	/	/	/	/	/
Body Top (10mm)	5180	802.11a	/	/	/	/	/	/	/
	5200	802.11a	13.46	13.50	1.009	1.129	0.262	<b>0.30</b>	171#
	5240	802.11a	/	/	/	/	/	/	/

**WLAN 5.8G:**

EUT Position	Frequency (MHz)	Test Mode	Max. Meas. Power (dBm)	Max. Rated Power (dBm)	1g SAR (W/kg)				
					Scaled Factor	Duty cycle Factor	Meas. SAR	Scaled SAR	Plot
Head Left Cheek	5745	802.11ac20	/	/	/	/	/	/	/
	5785	802.11ac20	8.93	9.00	1.016	1.129	0.347	0.40	172#
	5825	802.11ac20	/	/	/	/	/	/	/
Head Left Tilt	5745	802.11ac20	/	/	/	/	/	/	/
	5785	802.11ac20	8.93	9.00	1.016	1.129	0.363	0.42	173#
	5825	802.11ac20	/	/	/	/	/	/	/
Head Right Cheek	5745	802.11ac20	/	/	/	/	/	/	/
	5785	802.11ac20	8.93	9.00	1.016	1.129	0.336	0.39	174#
	5825	802.11ac20	/	/	/	/	/	/	/
Head Right Tilt	5745	802.11ac20	8.95	9.00	1.012	1.129	0.357	0.41	175#
	5785	802.11ac20	8.93	9.00	1.016	1.129	0.366	<b>0.42</b>	176#
	5825	802.11ac20	8.98	9.00	1.005	1.129	0.346	0.39	177#
Body Front (10mm)	5745	802.11ac20	/	/	/	/	/	/	/
	5785	802.11ac20	8.93	9.00	1.016	1.129	0.083	0.10	178#
	5825	802.11ac20	/	/	/	/	/	/	/
Body Back (10mm)	5745	802.11ac20	/	/	/	/	/	/	/
	5785	802.11ac20	8.93	9.00	1.016	1.129	0.103	0.12	179#
	5825	802.11ac20	/	/	/	/	/	/	/
Body Right (10mm)	5745	802.11ac20	/	/	/	/	/	/	/
	5785	802.11ac20	8.93	9.00	1.016	1.129	0.059	0.07	180#
	5825	802.11ac20	/	/	/	/	/	/	/
Body Top (10mm)	5745	802.11ac20	/	/	/	/	/	/	/
	5785	802.11ac20	8.93	9.00	1.016	1.129	0.165	<b>0.19</b>	181#
	5825	802.11ac20	/	/	/	/	/	/	/

**Note:**

1. When the 1-g SAR is  $\leq 0.8\text{W/kg}$ , testing for other channels are optional.
2. When SAR or MPE is not measured at the maximum power level allowed for production units, the results must be scaled to the maximum tune-up tolerance limit according to the power applied to the individual channels tested to determine compliance.

## 9. Measurement Variability

In accordance with published RF Exposure KDB procedure 865664 D01 SAR measurement 100 MHz to 6 GHz v01. These additional measurements are repeated after the completion of all measurements requiring the same head or body tissue-equivalent medium in a frequency band. The test device should be returned to ambient conditions (normal room temperature) with the battery fully charged before it is re-mounted on the device holder for the repeated measurement(s) to minimize any unexpected variations in the repeated results

- 1) Repeated measurement is not required when the original highest measured SAR is  $< 0.80$  W/kg; steps 2) through 4) do not apply.
- 2) When the original highest measured SAR is  $\geq 0.80$  W/kg, repeat that measurement once.
- 3) Perform a second repeated measurement only if the ratio of largest to smallest SAR for the original and first repeated measurements is  $> 1.20$  or when the original or repeated measurement is  $\geq 1.45$  W/kg (~ 10% from the 1-g SAR limit).
- 4) Perform a third repeated measurement only if the original, first or second repeated measurement is  $\geq 1.5$  W/kg and the ratio of largest to smallest SAR for the original, first and second repeated measurements is  $> 1.20$ .

*Note: The same procedures should be adapted for measurements according to extremity and occupational exposure limits by applying a factor of 2.5 for extremity exposure and a factor of 5 for occupational exposure to the corresponding SAR thresholds.*

### The Highest Measured SAR Configuration in Each Frequency Band

#### Head

SAR probe calibration point	Frequency Band	Freq.(MHz)	EUT Position	Meas. SAR (W/kg)		Largest to Smallest SAR Ratio
				Original	Repeated	
1900MHz (1850-2000MHz)	LTE Band 2	1900	Head Right Cheek	1.05	1.03	1.02
5250MHz (5140-5360MHz)	5.2G WIFI	5200	Head Left Cheek	0.805	0.793	1.02

#### Body

SAR probe calibration point	Frequency Band	Freq.(MHz)	EUT Position	Meas. SAR (W/kg)		Largest to Smallest SAR Ratio
				Original	Repeated	
2450MHz (2400-2550MHz)	LTE Band 7	2535	Body Back	1.09	1.02	1.07
2600MHz (2550-2700MHz)	LTE Band 7	2560	Body Back	0.915	0.903	1.01

#### Note:

1. Second Repeated Measurement is not required since the ratio of the largest to smallest SAR for the original and first repeated measurement is not  $> 1.20$ .
2. The measured SAR results **do not** have to be scaled to the maximum tune-up tolerance to determine if repeated measurements are required.
3. SAR measurement variability must be assessed for each frequency band, which is determined by the **SAR probe calibration point and tissue-equivalent medium** used for the device measurements.

## 10. SAR SIMULTANEOUS TRANSMISSION DESCRIPTION

### Simultaneous Transmission:

Description of Simultaneous Transmit Capabilities		
Transmitter Combination	Simultaneous?	Hotspot?
WWAN(GSM/WCDMA/LTE) Main Antenna + BT Antenna	√	×
WWAN(GSM/WCDMA/LTE) DIV Antenna + BT Antenna	√	×
WWAN(GSM/WCDMA/LTE) Main Antenna + 2.4G/5G WLAN Antenna	√	√
WWAN(GSM/WCDMA/LTE) DIV Antenna + 2.4G/5G WLAN Antenna	√	√
WWAN(GSM/WCDMA/LTE) Main Antenna + WWAN(GSM/WCDMA/LTE) DIV Antenna	×	×



**Simultaneous SAR test exclusion considerations:**

Mode(SAR1+SAR2)	Position	Reported SAR(W/kg)		$\Sigma$ SAR < 1.6W/kg
		MAX <sub>SAR1</sub>	MAX <sub>SAR2</sub>	
WWAN(GSM/WCDMA/LTE) Main Antenna + Bluetooth ANT	Head Left Cheek	0.39	0.04	0.43
	Head Left Tilt	0.17	0.04	0.21
	Head Right Cheek	0.25	0.04	0.29
	Head Right Tilt	0.27	0.04	0.31
	Body Front	0.62	0.02	0.64
	Body Back	1.12	0.02	1.14
	Body Left	0.65	0.02	0.67
	Body Right	0.25	0.02	0.27
	Body Top	NA	0.02	NA
	Body Bottom	0.46	0.02	0.48
WWAN(GSM/WCDMA/LTE) DIV Antenna + Bluetooth ANT	Head Left Cheek	0.62	0.04	0.66
	Head Left Tilt	0.78	0.04	0.82
	Head Right Cheek	1.12	0.04	<b>1.16</b>
	Head Right Tilt	0.75	0.04	0.79
	Body Front	0.52	0.02	0.54
	Body Back	0.53	0.02	0.55
	Body Left	0.6	0.02	0.62
	Body Right	NA	0.02	NA
	Body Top	0.29	0.02	0.31
	Body Bottom	NA	0.02	NA

Mode(SAR1+SAR2)	Position	Reported SAR(W/kg)		$\Sigma$ SAR < 1.6W/kg
		MAX <sub>SAR1</sub>	MAX <sub>SAR2</sub>	
WWAN(GSM/WCDMA/LTE) Main Antenna + 2.4G WLAN ANT	Head Left Cheek	0.39	0.21	0.6
	Head Left Tilt	0.17	0.19	0.36
	Head Right Cheek	0.25	0.14	0.39
	Head Right Tilt	0.27	0.17	0.44
WWAN(GSM/WCDMA/LTE) Main Antenna + 2.4G WLAN ANT (Hotspot)	Body Front	0.62	0.04	0.66
	Body Back	1.12	0.06	1.18
	Body Left	0.65	NA	NA
	Body Right	0.25	0.05	0.3
	Body Top	NA	0.03	NA
	Body Bottom	0.46	NA	NA
WWAN(GSM/WCDMA/LTE) DIV Antenna + 2.4G WLAN ANT	Head Left Cheek	0.62	0.21	0.83
	Head Left Tilt	0.78	0.19	0.97
	Head Right Cheek	1.12	0.14	<b>1.26</b>
	Head Right Tilt	0.75	0.17	0.92
WWAN(GSM/WCDMA/LTE) DIV Antenna + 2.4G WLAN ANT (Hotspot)	Body Front	0.52	0.04	0.56
	Body Back	0.53	0.06	0.59
	Body Left	0.6	NA	NA
	Body Right	NA	0.05	NA
	Body Top	0.29	0.03	0.32

Mode(SAR1+SAR2)	Position	Reported SAR(W/kg)		$\Sigma$ SAR < 1.6W/kg
		MAX <sub>SAR1</sub>	MAX <sub>SAR2</sub>	
WWAN(GSM/WCDMA/LTE) Main Antenna + 5G WLAN ANT	Head Left Cheek	0.39	0.92	1.31
	Head Left Tilt	0.17	0.63	0.8
	Head Right Cheek	0.25	0.42	0.67
	Head Right Tilt	0.27	0.53	0.8
WWAN(GSM/WCDMA/LTE) Main Antenna + 5G WLAN ANT (Hotspot)	Body Front	0.62	0.14	0.76
	Body Back	1.12	0.2	1.32
	Body Left	0.65	NA	NA
	Body Right	0.25	0.07	0.32
	Body Top	NA	0.3	NA
	Body Bottom	0.46	NA	NA
WWAN(GSM/WCDMA/LTE) DIV Antenna + 5G WLAN ANT	Head Left Cheek	0.62	0.92	<b>1.54</b>
	Head Left Tilt	0.78	0.63	1.41
	Head Right Cheek	1.12	0.42	<b>1.54</b>
	Head Right Tilt	0.75	0.53	1.28
WWAN(GSM/WCDMA/LTE) DIV Antenna + 5G WLAN ANT (Hotspot)	Body Front	0.52	0.14	0.66
	Body Back	0.53	0.2	0.73
	Body Left	0.6	NA	NA
	Body Right	NA	0.07	NA
	Body Top	0.29	0.3	0.59

**Conclusion:**

Sum of SAR:  $\Sigma$ SAR  $\leq$  1.6 W/kg therefore simultaneous transmission SAR with Volume Scans is **not required**.

## **11. SAR Plots**

---

**Please Refer to the Attachment.**

## APPENDIX A MEASUREMENT UNCERTAINTY

The uncertainty budget has been determined for the measurement system and is given in the following Table.

### Measurement uncertainty evaluation for IEEE1528-2013 SAR test

Source of uncertainty	Tolerance/uncertainty ± %	Probability distribution	Divisor	ci (1 g)	ci (10 g)	Standard uncertainty ± %, (1 g)	Standard uncertainty ± %, (10 g)
<b>Measurement system</b>							
Probe calibration	6.55	N	1	1	1	6.3	6.3
Axial Isotropy	4.7	R	$\sqrt{3}$	1	1	2.7	2.7
Hemispherical Isotropy	9.6	R	$\sqrt{3}$	0	0	0.0	0.0
Boundary effect	1.0	R	$\sqrt{3}$	1	1	0.6	0.6
Linearity	4.7	R	$\sqrt{3}$	1	1	2.7	2.7
Detection limits	1.0	R	$\sqrt{3}$	1	1	0.6	0.6
Readout electronics	0.3	N	1	1	1	0.3	0.3
Response time	0.0	R	$\sqrt{3}$	1	1	0.0	0.0
Integration time	0.0	R	$\sqrt{3}$	1	1	0.0	0.0
RF ambient conditions – noise	1.0	R	$\sqrt{3}$	1	1	0.6	0.6
RF ambient conditions– reflections	1.0	R	$\sqrt{3}$	1	1	0.6	0.6
Probe positioner mech. Restrictions	0.8	R	$\sqrt{3}$	1	1	0.5	0.5
Probe positioning with respect to phantom shell	6.7	R	$\sqrt{3}$	1	1	3.9	3.9
Post-processing	2.0	R	$\sqrt{3}$	1	1	1.2	1.2
<b>Test sample related</b>							
Test sample positioning	2.8	N	1	1	1	2.8	2.8
Device holder uncertainty	6.3	N	1	1	1	6.3	6.3
Drift of output power	5.0	R	$\sqrt{3}$	1	1	2.9	2.9
<b>Phantom and set-up</b>							
Phantom uncertainty (shape and thickness tolerances)	4.0	R	$\sqrt{3}$	1	1	2.3	2.3
Liquid conductivity target)	5.0	R	$\sqrt{3}$	0.64	0.43	1.8	1.2
Liquid conductivity meas.)	2.5	N	1	0.64	0.43	1.6	1.1
Liquid permittivity target)	5.0	R	$\sqrt{3}$	0.6	0.49	1.7	1.4
Liquid permittivity meas.)	2.5	N	1	0.6	0.49	1.5	1.2
Combined standard uncertainty		RSS				12.2	12.0
Expanded uncertainty 95 % confidence interval)						24.1	23.7

## Measurement uncertainty evaluation for IEC62209-1 SAR test

Source of uncertainty	Tolerance/uncertainty ± %	Probability distribution	Divisor	ci (1 g)	ci (10 g)	Standard uncertainty ± %, (1 g)	Standard uncertainty ± %, (10 g)
<b>Measurement system</b>							
Probe calibration	6.55	N	1	1	1	6.3	6.3
Axial Isotropy	4.7	R	$\sqrt{3}$	1	1	2.7	2.7
Hemispherical Isotropy	9.6	R	$\sqrt{3}$	0	0	0.0	0.0
Boundary effect	1.0	R	$\sqrt{3}$	1	1	0.6	0.6
Linearity	4.7	R	$\sqrt{3}$	1	1	2.7	2.7
Detection limits	1.0	R	$\sqrt{3}$	1	1	0.6	0.6
Readout electronics	0.3	N	1	1	1	0.3	0.3
Response time	0.0	R	$\sqrt{3}$	1	1	0.0	0.0
Integration time	0.0	R	$\sqrt{3}$	1	1	0.0	0.0
RF ambient conditions – noise	1.0	R	$\sqrt{3}$	1	1	0.6	0.6
Probe positioning with respect to phantom shell	6.7	R	$\sqrt{3}$	1	1	3.9	3.9
Probe positioner mech. Restrictions	0.8	R	$\sqrt{3}$	1	1	0.5	0.5
RF ambient conditions– reflections	1.0	R	$\sqrt{3}$	1	1	0.6	0.6
Post-processing	2.0	R	$\sqrt{3}$	1	1	1.2	1.2
<b>Test sample related</b>							
Test sample positioning	2.8	N	1	1	1	2.8	2.8
Device holder uncertainty	6.3	N	1	1	1	6.3	6.3
Drift of output power	5.0	R	$\sqrt{3}$	1	1	2.9	2.9
<b>Phantom and set-up</b>							
Phantom uncertainty (shape and thickness tolerances)	4.0	R	$\sqrt{3}$	1	1	2.3	2.3
Liquid conductivity target)	5.0	R	$\sqrt{3}$	0.64	0.43	1.8	1.2
Liquid conductivity meas.)	2.5	N	1	0.64	0.43	1.6	1.1
Liquid permittivity target)	5.0	R	$\sqrt{3}$	0.6	0.49	1.7	1.4
Liquid permittivity meas.)	2.5	N	1	0.6	0.49	1.5	1.2
Combined standard uncertainty		RSS				12.2	12.0
Expanded uncertainty 95 % confidence interval)						24.0	23.6

## **APPENDIX B EUT TEST POSITION PHOTOS**

---

**Please Refer to the Attachment.**

## **APPENDIX C CALIBRATION CERTIFICATES**

---

**Please Refer to the Attachment.**

**\*\*\*\*\* END OF REPORT \*\*\*\*\***