

ANWEI commnuication Equipment Co.,Ltd

APPROVAL SHEET

Customer	Youmi	Specs	G5 ULTRA
Part Number	G5 ULTRA-MAIN-AW G5 ULTRA-DIV-AW G5 ULTRA-5GWIFI/GPS/ 2.4GWIFI-AW	Frequency Band	2G:GSM850/900/1800/1900 3G:W1/2/5/8 4G:LTE-B1/2/3/4/5/7/8/12/13/17/ 18/19/20/26/28A/B/66/71+TDD34/38/39/40/41
Color	Black	Antenna Type	FPC
Salesperson	Mr.Xie	Edition	REV:A0
Structure	QIN YUN LIN	Design	ZHONG ZHI HUI
Date	2023/2/02		

Customer confirmation:

ANT Manufacturers: ANWEI commnuication Equipment Co.,Ltd

Address:2nd Floor, East Block, Building 5, Yifenghua Innovation Industrial Park, Huaning Road, Dalang Street, Longhua District, Shenzhen City, Guangdong Province

● Project development environment

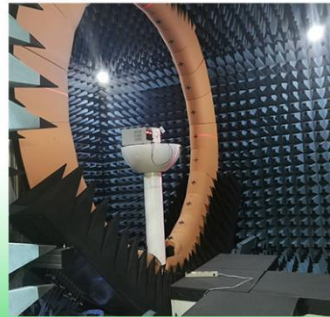
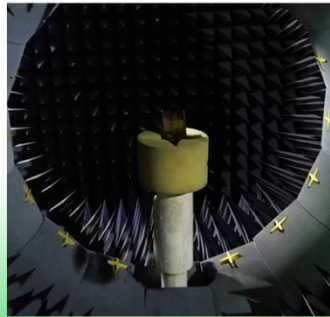
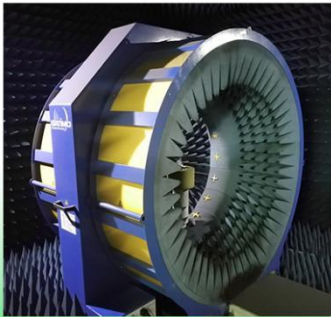

安威无线一直都是您值得信赖且优秀的合作伙伴，我们为您提供全方位一站式的的产品以及技术服务！

“质量第一，服务至上”是安威一直以来的发展宗旨

Main ANT



工作频段(Working frequency band): 647MHZ~960MHZ 1710~2690MHZ

2G:GSM850/900/1800/1900

3G:W1/2/5/8

4G:LTE-B1/2/3/4/5/7/8/12/13/17/

18/19/20/26/28A/B/66/71+TDD34/38/39/40/41

DIV ANT



工作频段(Working frequency band): 647MHZ~960MHZ 1710~2690MHZ

2G:GSM850/900/1800/1900

3G:W1/2/5/8

4G:LTE-B1/2/3/4/5/7/8/12/13/17/

18/19/20/26/28A/B/66/71+TDD34/38/39/40/41

天线匹配(Matcheing network)

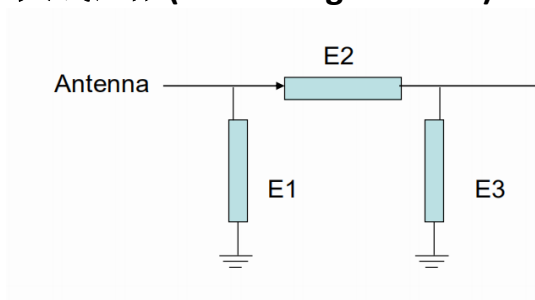

E1=NC

E2= 0Ω

E3= NC

(GPS antenna) + (2.4G/5G WIFI/BT antenna)

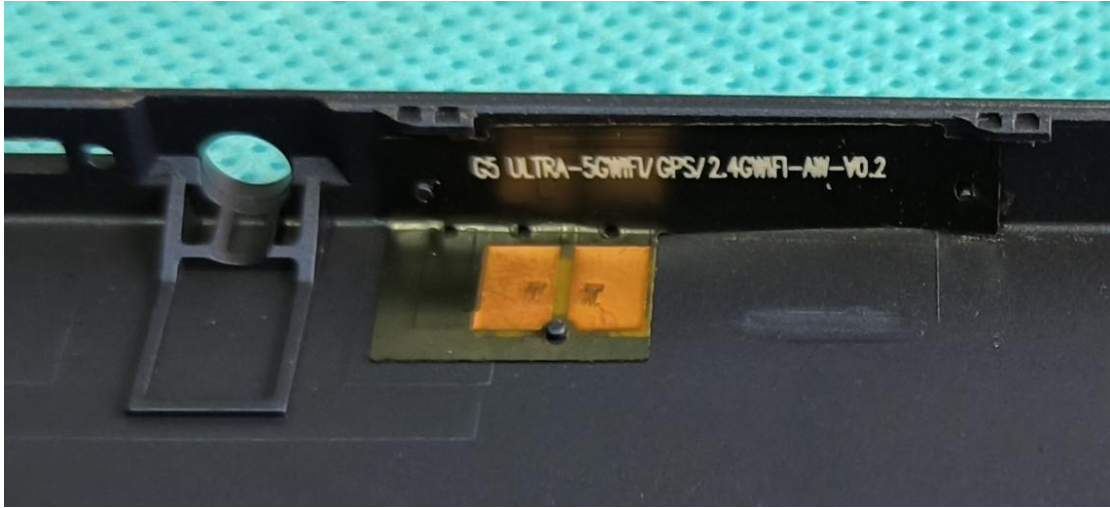

GPS 天线工作频段 (Working frequency band of GPS antenna) : 1559MHZ~1580MHZ

5GWIFI 工作频段 (Working frequency band of 5GWIFI antenna) : 2400~2500,5150MHZ~5850MH

ANWEI ANT TRP&TIS parameter Summary of G3TAB

BAND	Channel	TRP (dBm)	TIS (dBm)
FDD B1	L	18.24	
	M	18.45	
	H	18.45	-93.41
FDD B2	L	18.23	
	M	18.62	
	H	18.89	-94.20
FDD B3	L	17.53	
	M	17.00	
	H	17.81	-94.33
FDD B4	L	17.67	
	M	17.62	
	H	17.24	-94.70
FDD B5	L	17.39	
	M	18.04	
	H	18.60	-92.15
FDD B7	L	18.19	
	M	19.47	
	H	18.42	-94.57
FDD B8	L	18.31	
	M	18.02	
	H	17.55	-92.03
FDD B12	L	15.60	
	M	16.10	
	H	16.17	-92.09
FDD B13	L		
	M	17.32	-92.53
	H		

FDD B17	L	16.31	
	M	16.34	
	H	17.14	-92.09
FDD B18	L	16.96	
	M	18.04	
	H	18.15	-92.44
FDD B19	L	17.76	
	M	18.70	
	H	18.53	-92.42
FDD B20	L	18.56	
	M	19.99	
	H	18.73	-93.33
FDD B25	L	17.73	
	M	18.45	
	H	18.43	-94.59
FDD B26	L	16.25	
	M	16.51	
	H	17.69	-93.64
FDD B28A	L	16.97	
	M	16.52	
	H	16.73	-92.58
FDD B28B	L	16.74	
	M	17.45	
	H	17.48	-93.14
FDD B66	L	16.66	
	M	17.49	
	H	18.07	-94.53
	L	15.20	
	M	15.61	
	H	15.17	-90.78

FDD B71			
TDD B34	L	18.24	
	M	19.31	
	H	18.09	-93.80
TDD B38	L	18.67	
	M	18.87	
	H	18.19	-90.23
TDD B39	L	18.41	
	M	18.37	
	H	18.54	-92.42
TDD B40	L	16.40	
	M	16.78	
	H	16.95	-89.62
TDD B41	L		
	M	18.01	-90.88
	H		
WCDMA-B1	L	18.82	
	M	18.75	
	H	18.71	-106.58
WCDMA-B2	L	18.76	
	M	18.95	
	H	19.42	-106.85
WCDMA-B4	L	18.31	
	M	18.29	
	H	18.32	-106.08
WCDMA-B5	L	17.64	
	M	18.32	
	H	18.62	-105.14

WCDMA-B8	L	19.14	
	M	18.07	
	H	18.39	-104.26

	Channel	TRP (dBm)	TIS (dBm)
GSM850	L	25.72	
	M	26.49	
	H	26.86	-103.25
GSM900	L	26.35	
	M	25.93	
	H	25.52	-103.77
DCS1800	L	25.16	
	M	24.99	
	H	24.54	-105.63
PCS1900	L	24.05	
	M	24.44	
	H	25.40	-104.80
2.4G WIFI	L	14.54	-84.04
	M	14.58	-83.96
B mode 11M	H	14.34	-83.94
5 G WIFI	L	12.55	-72.58
	M	11.22	-71.72
A mode 54M	H	11.41	-72.19

天线增益(Antenna gain)

Standard	Band	Frequency	Gain(dbi)
TDD_LTE	TDD_B34	2020	1.52
TDD_LTE	TDD_B38	2600	1.81
TDD_LTE	TDD_B39	1900	1.14
TDD_LTE	TDD_B40	2360	0.52
TDD_LTE	TDD_B41	2600	1.81
FDD_LTE	FDD_B1	1960	1.71
FDD_LTE	FDD_B2	1900	1.14
FDD_LTE	FDD_B3	1720	1.03
FDD_LTE	FDD_B4	1720	1.03
FDD_LTE	FDD_B5	820	-0.76
FDD_LTE	FDD_B7	2520	1.05
FDD_LTE	FDD_B8	900	-1.13
FDD_LTE	FDD_B12	711	-2.37
FDD_LTE	FDD_B13	782	-2.71
FDD_LTE	FDD_B17	711	-2.37
FDD_LTE	FDD_B18	820	-0.76
FDD_LTE	FDD_B19	820	-0.76
FDD_LTE	FDD_B20	820	-0.76
FDD_LTE	FDD_B25	1900	1.14
FDD_LTE	FDD_B26	820	-0.76
FDD_LTE	FDD_B28	711	-2.37
FDD_LTE	FDD_B66	1720	1.03
FDD_LTE	FDD_B71	693	-3.14
WCDMA	WCDMA_B1	1960	1.71
WCDMA	WCDMA_B2	1900	1.14
WCDMA	WCDMA_B4	1720	1.03

WCDMA	WCDMA_B5	820	-0.76
WCDMA	WCDMA_B8	900	-1.13
GSM	GSM850	820	-0.76
GSM	GSM900	900	-1.13
GSM	DCS1800	1720	1.03
GSM	PCS1900	1900	1.14
5GWIFI		5200	0.88
5GWIFI		5400	2.09
5GWIFI		5800	3.91
2.4GWIFI		2400	0.97
BT		2400	0.97

antenna PolarGraphs

H Theta=90 freq=693MHz

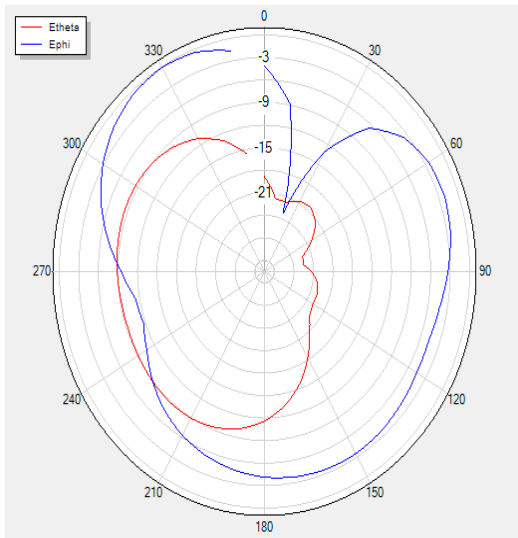

H Theta=0 freq=693MHz

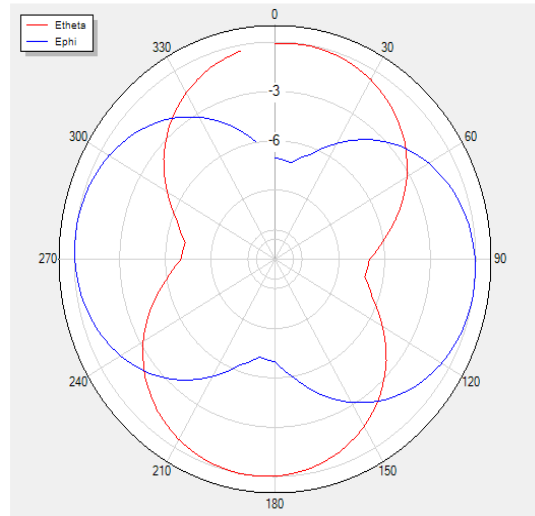

V Phi=90 freq=693MHz

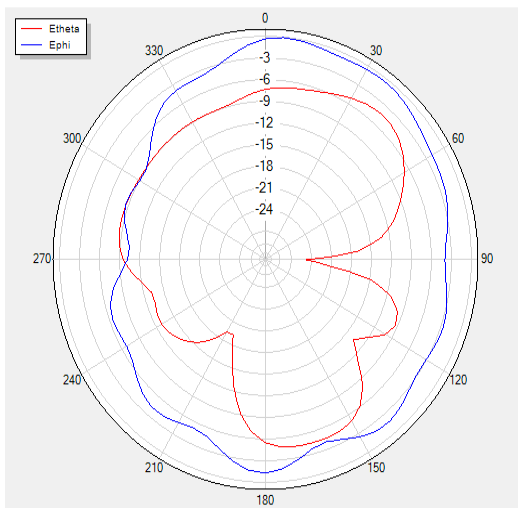

V Phi=0 freq=693MHz

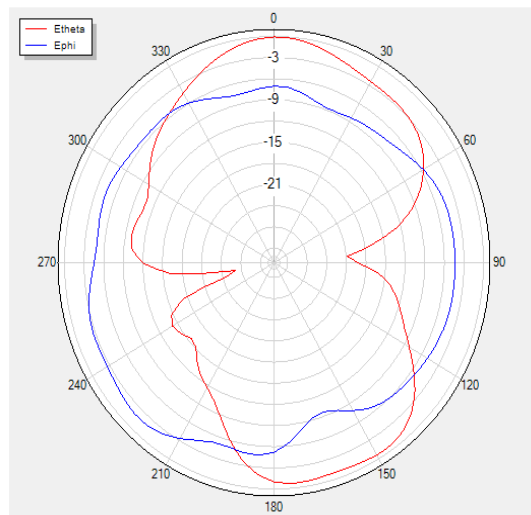

H Theta=90 freq=711MHz

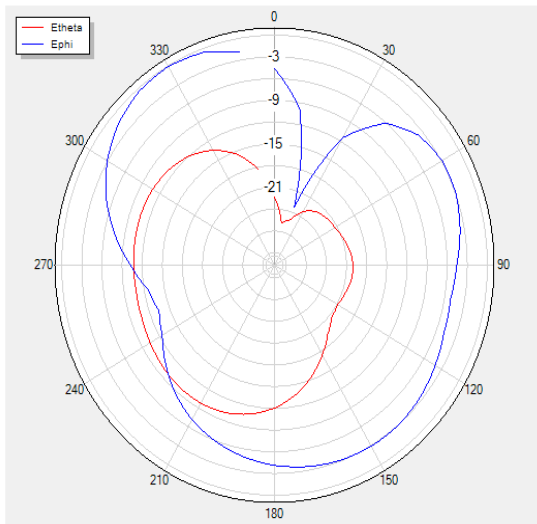

H Theta=0 freq=711MHz

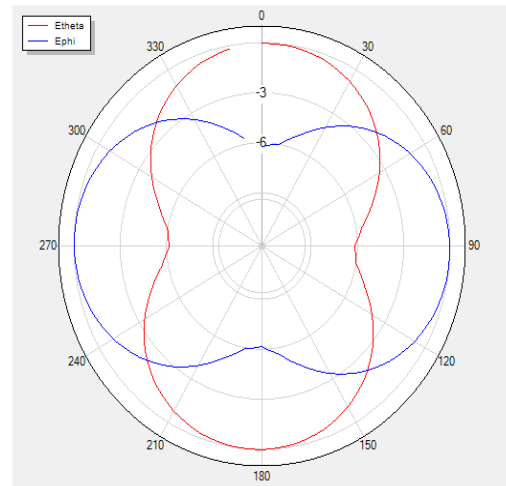

V Phi=90 freq=711MHz

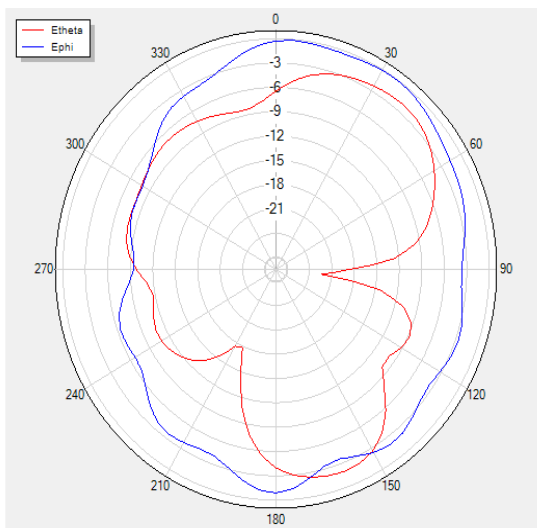

V Phi=0 freq=711MHz

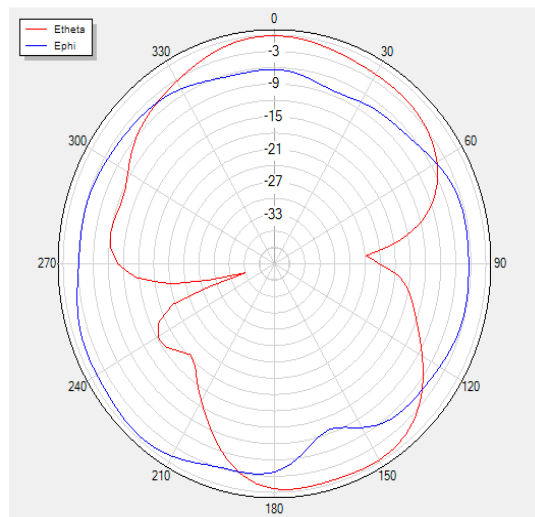

H Theta=90 freq=782MHz

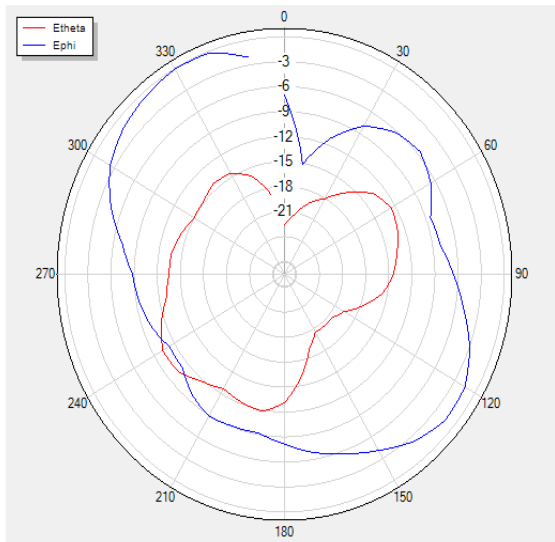

H Theta=0 freq=782MHz

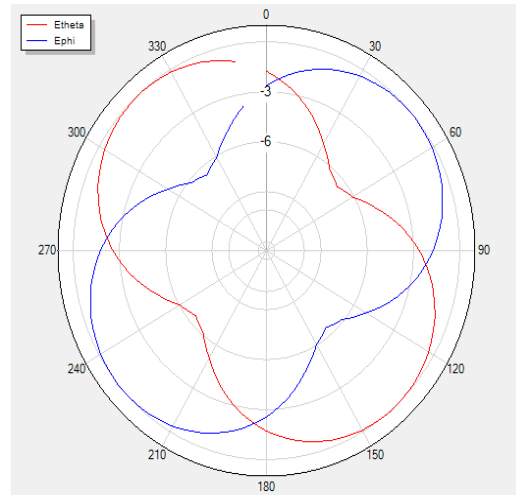

V Phi=90 freq=782MHz

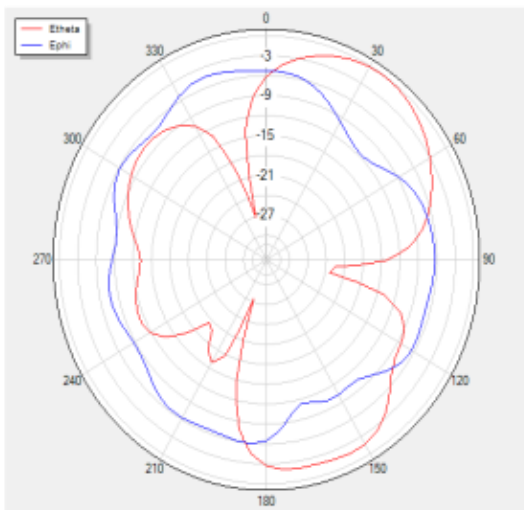

V Phi=0 freq=782MHz

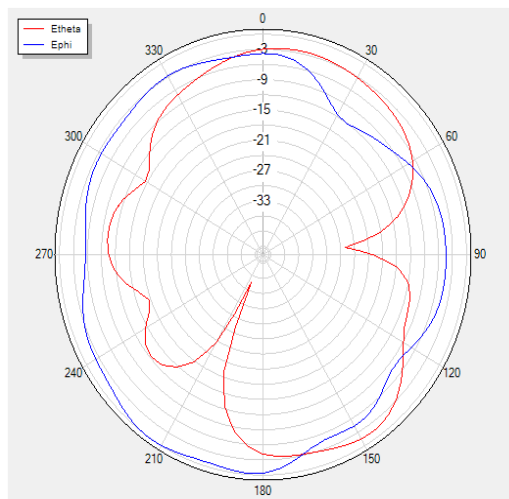

H Theta=90 freq=820MHz

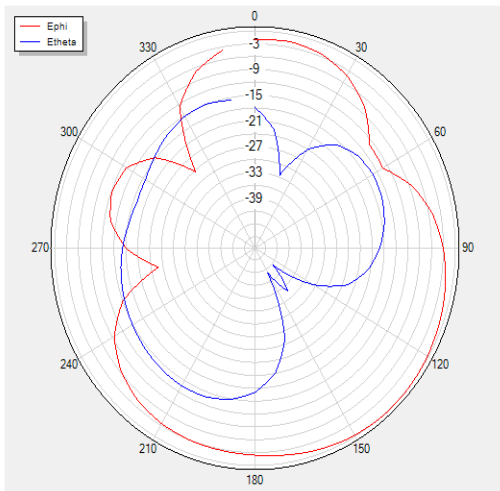

H Theta=0 freq=820MHz

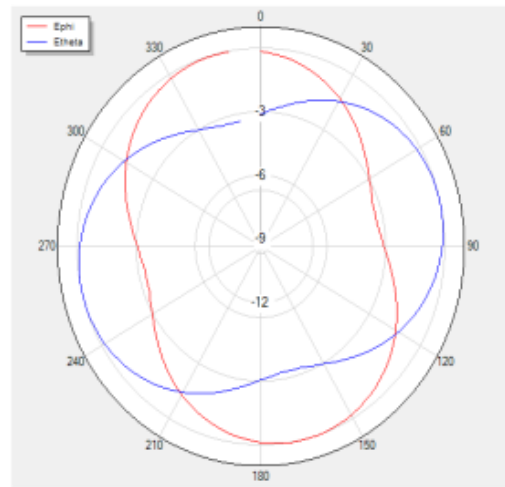

V Phi=90 freq=820MHz

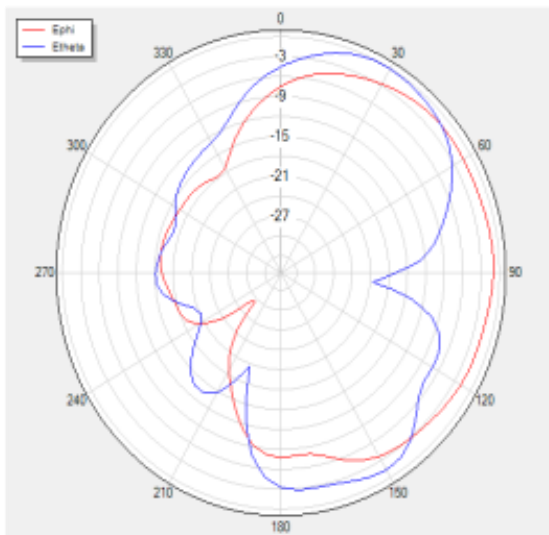

V Phi=0 freq=820MHz

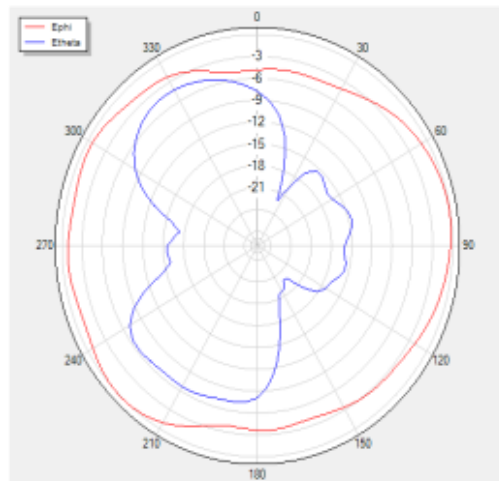

H Theta=90 freq=900MHz

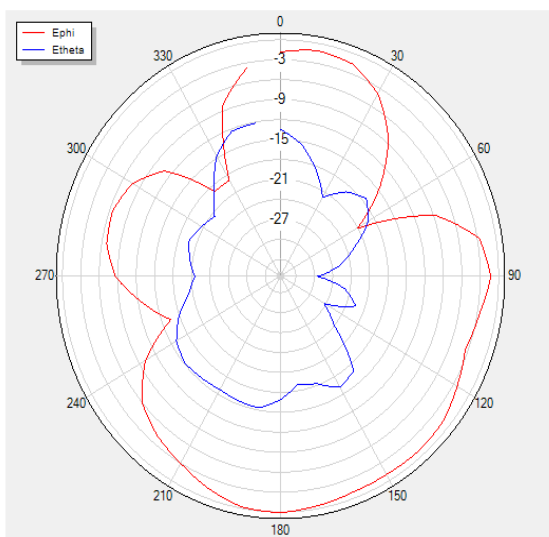

H Theta=0 freq=900MHz

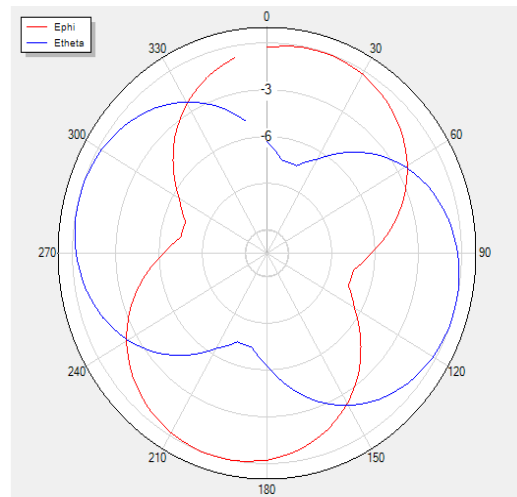

V Phi=0 freq=900MHz

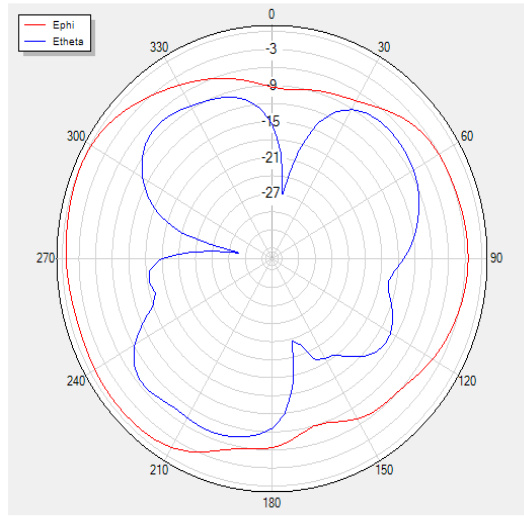

V Phi=90 freq=900MHz

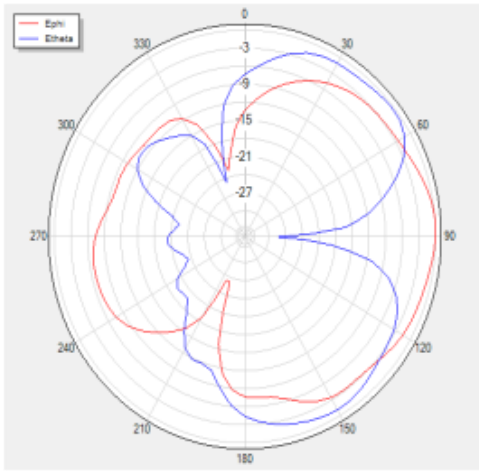

H Theta=0 freq=1720MHz

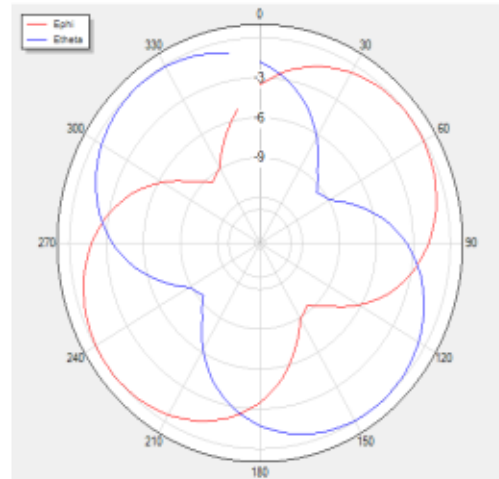

H Theta=90 freq=1720MHz

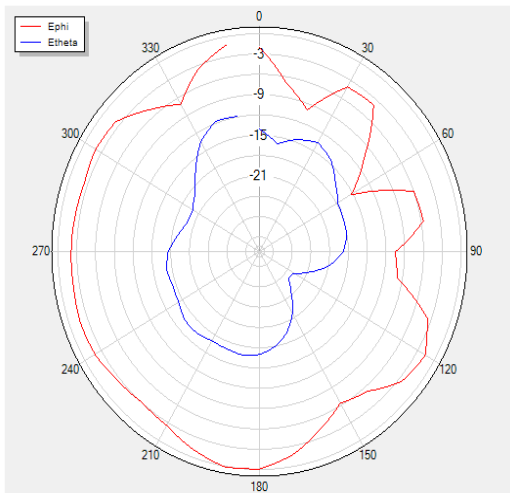

V Phi=0 freq=1720MHz

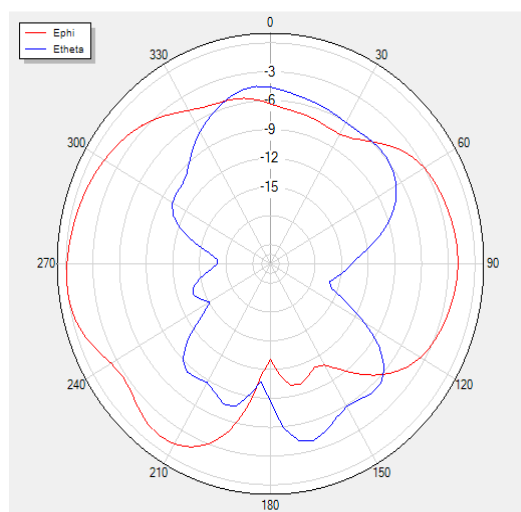

V Phi=90 freq=1720MHz

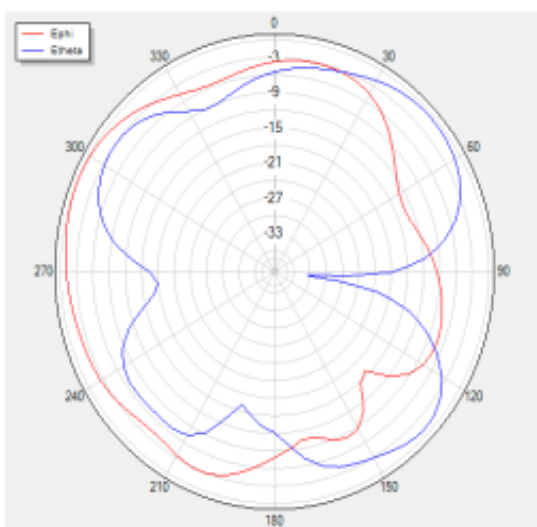

H Theta=90 freq=1900MHz

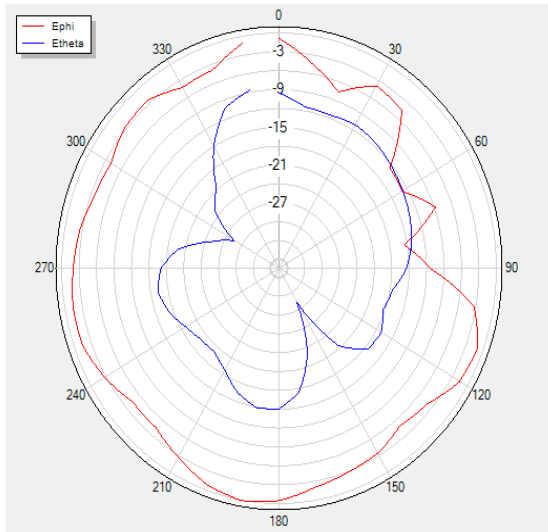

H Theta=0 freq=1900MHz

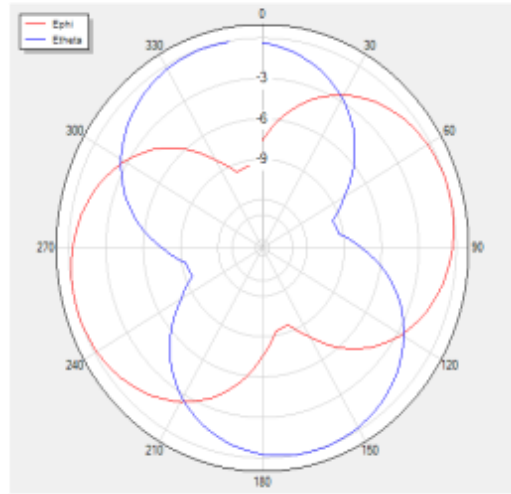

V Phi=90 freq=1900MHz

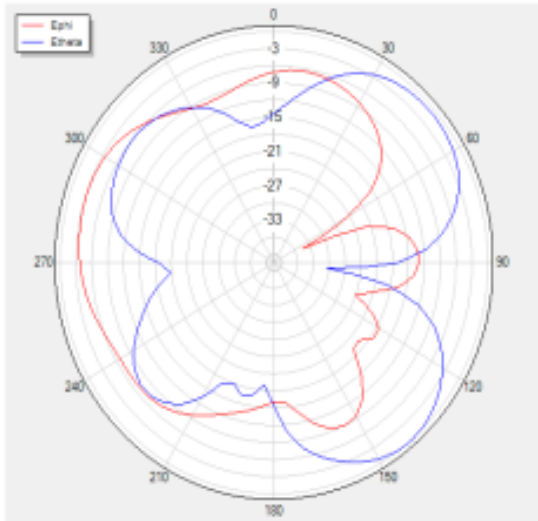

V Phi=0 freq=1900MHz

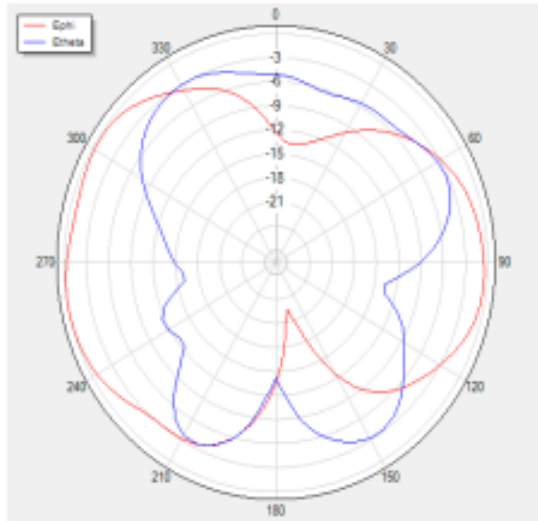

H Theta=90 freq=1960MHz

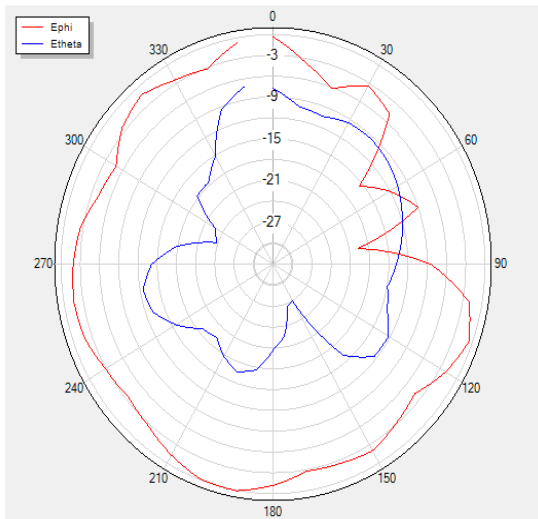

H Theta=0 freq=1960MHz

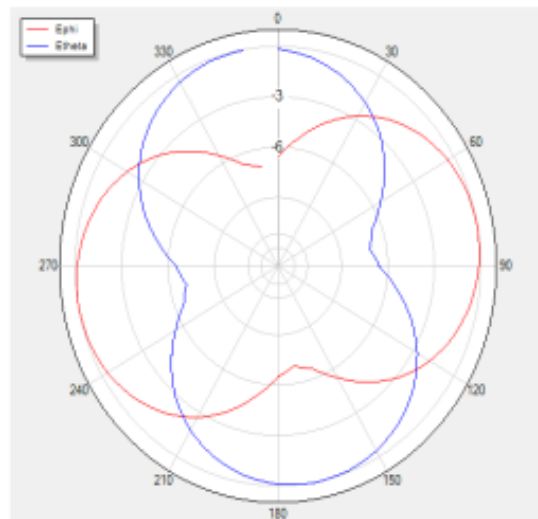

V Phi=90 freq=1960MHz

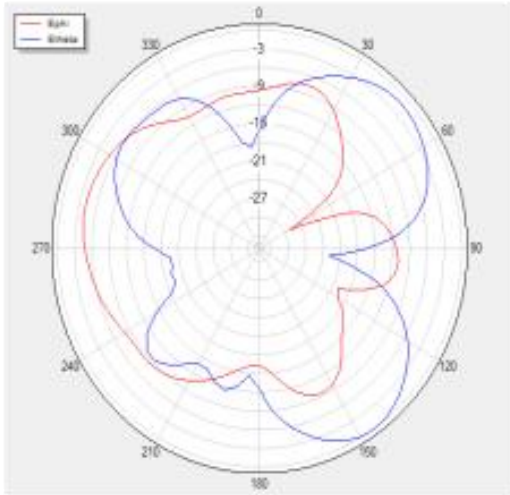

V Phi=0 freq=1960MHz

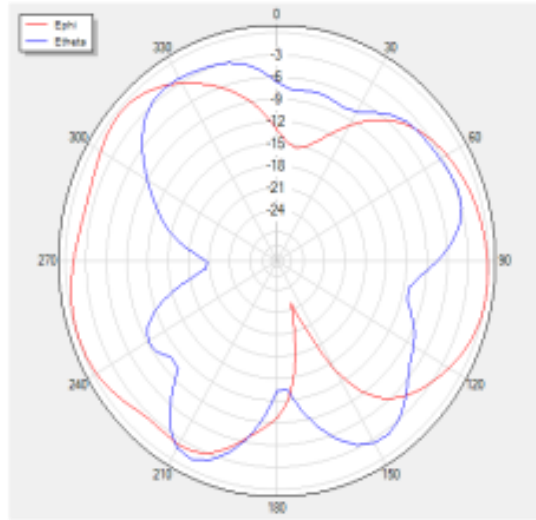

H Theta=90 freq=2020MHz

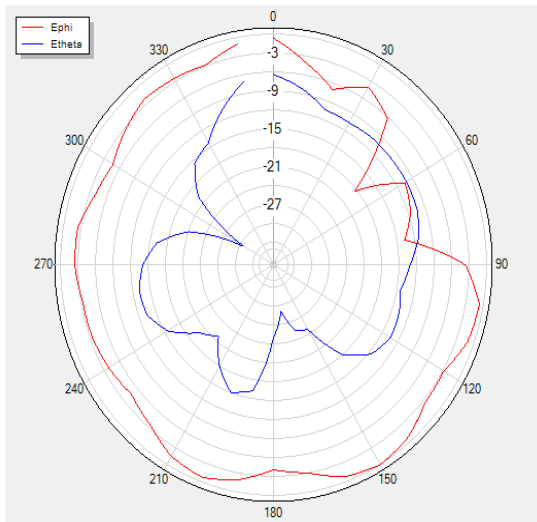

H Theta=0 freq=2020MHz

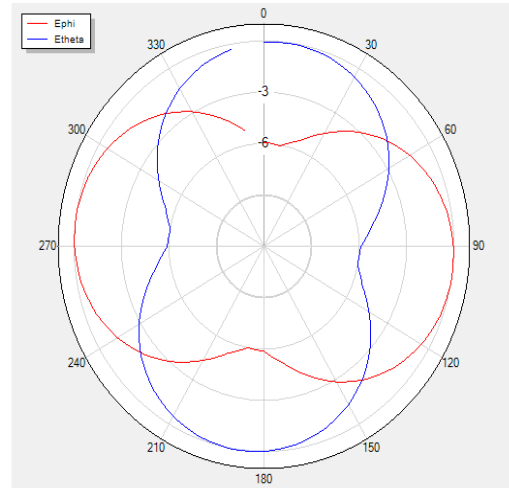

V Phi=90 freq=2020MHz

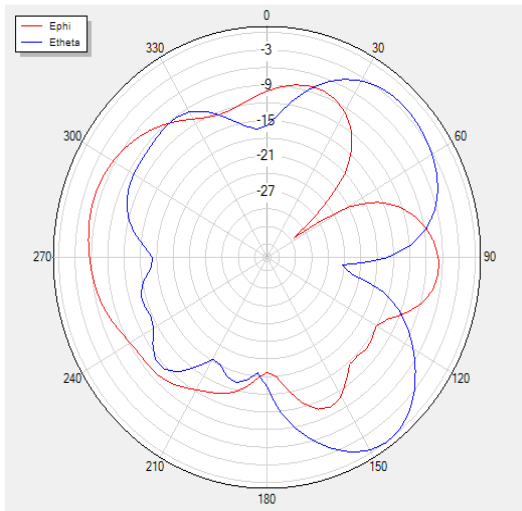

V Phi=0 freq=2020MHz

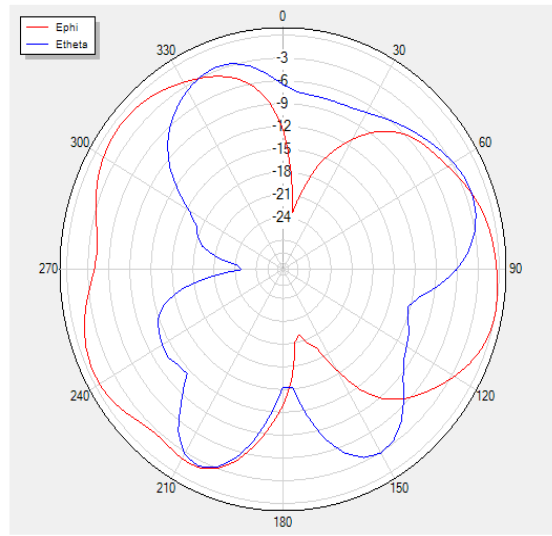

H Theta=90 freq=2360MHz

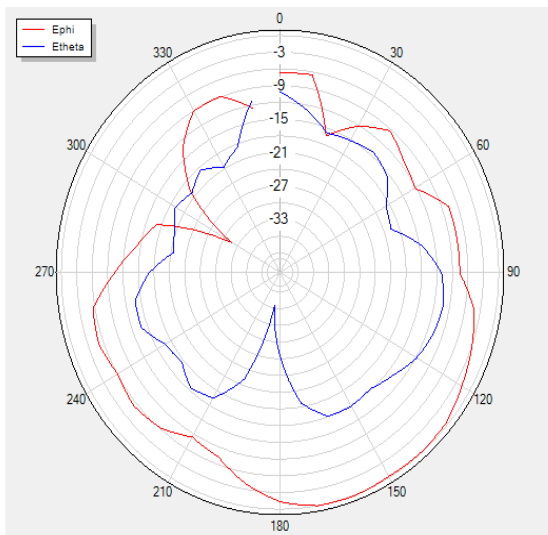

H Theta=0 freq=2360MHz

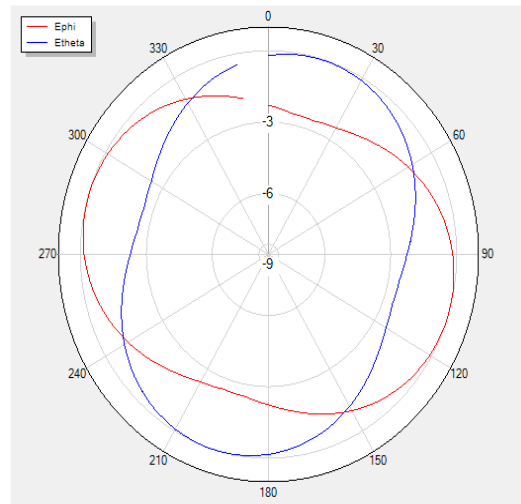

V Phi=90 freq=2360MHz

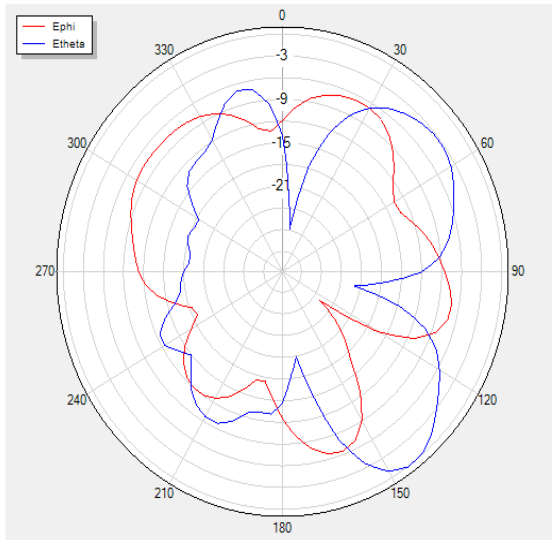

V Phi=0 freq=2360MHz

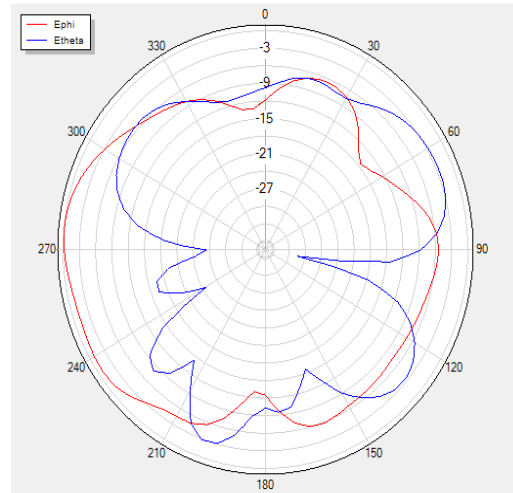

H Theta=90 freq=2520MHz

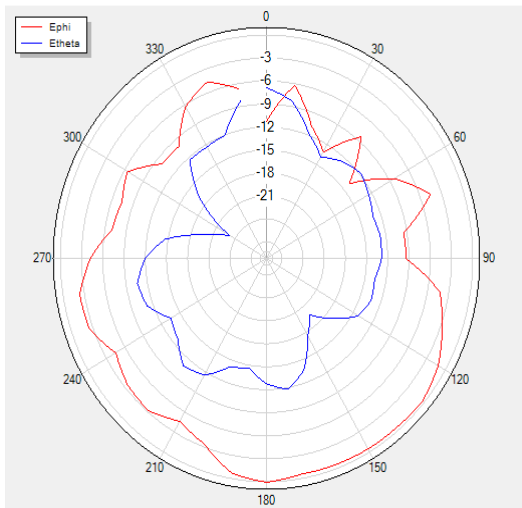

H Theta=0 freq=2520MHz

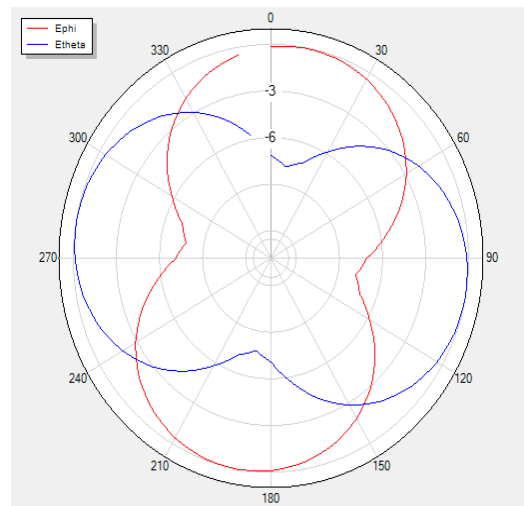

V Phi=0 freq=2520MHz

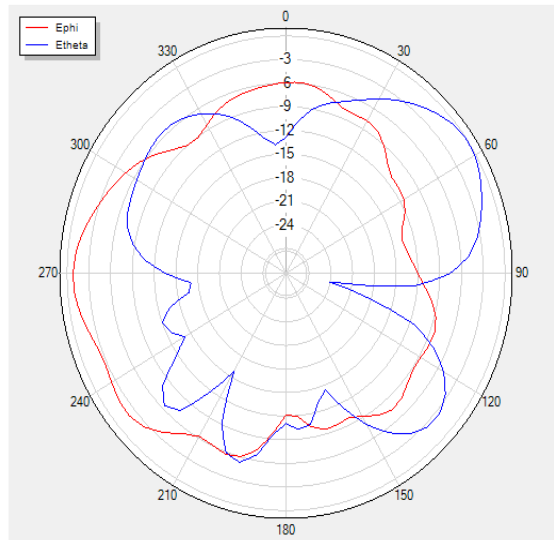

V Phi=90 freq=2520MHz

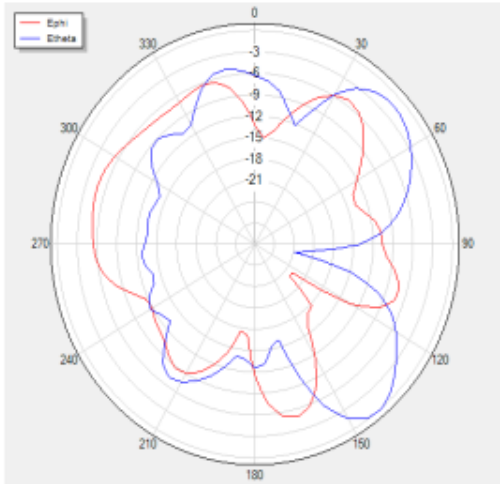

H Theta=0 freq=2600MHz

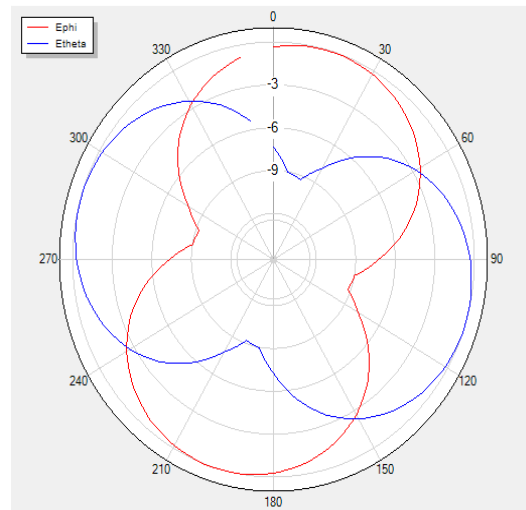

H Theta=90 freq=2600MHz

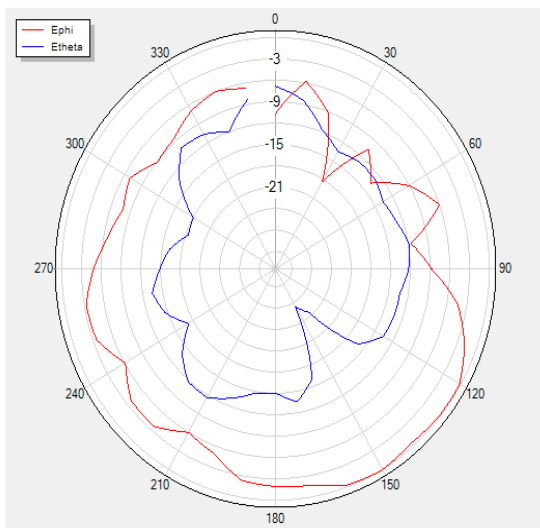

V Phi=90 freq=2600MHz

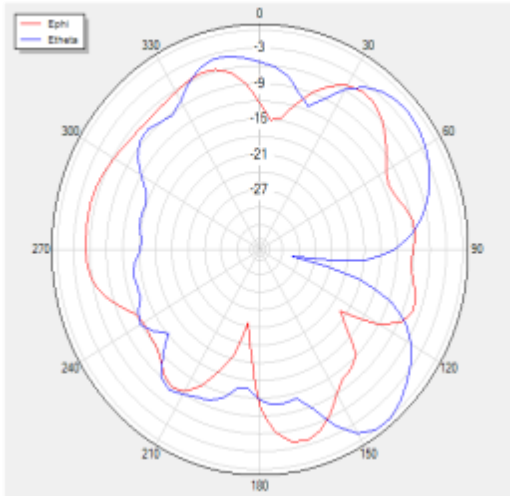

V Phi=0 freq=2600MHz

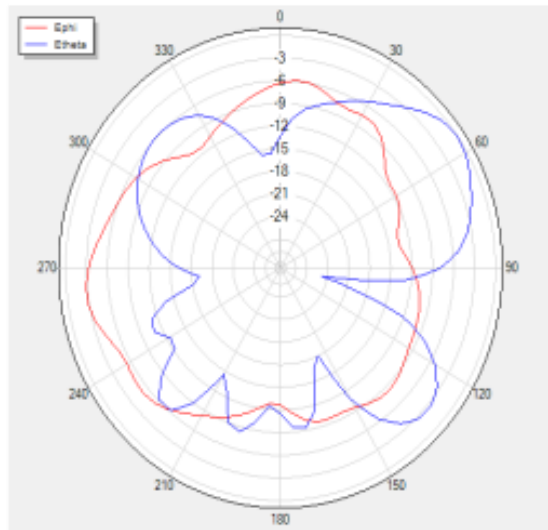

(GPS antenna) + (2.4G/5G WIFI/BT antenna) PolarGraphs

H Theta=90 freq=1575MHz

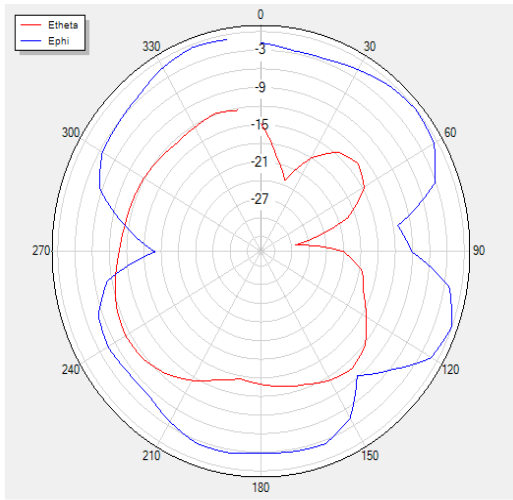

H Theta=0 freq=1575MHz

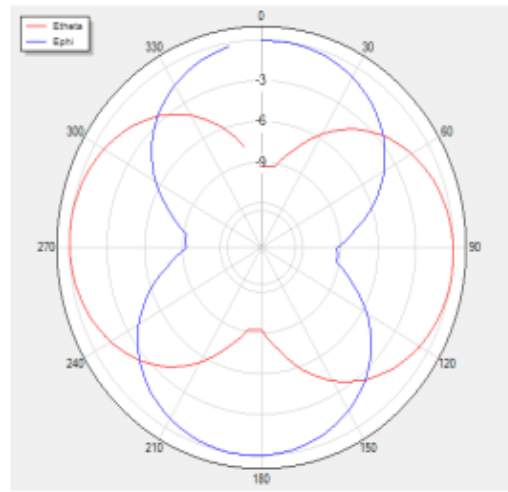

V Phi=90 freq=1575MHz

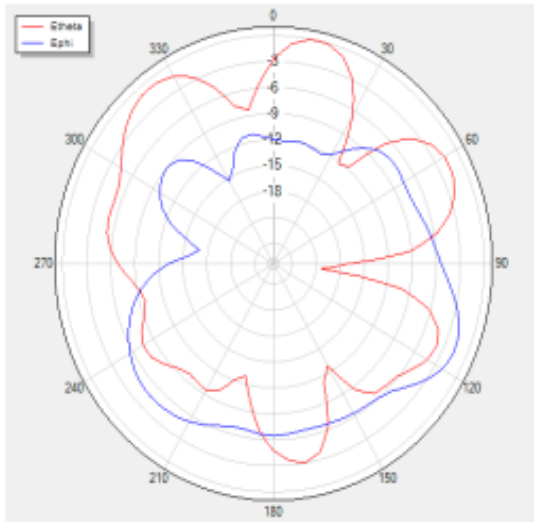

V Phi=0 freq=1575MHz

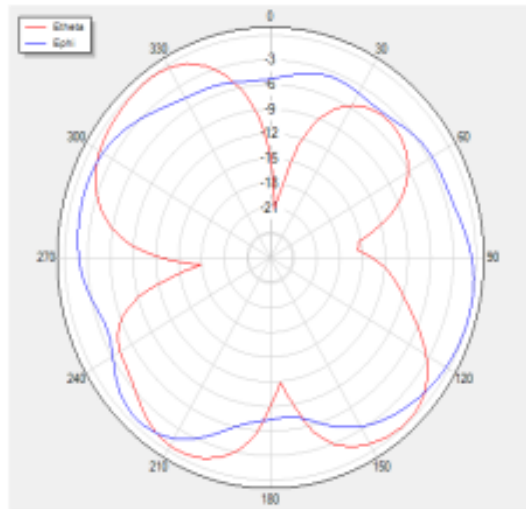

H Theta=90 freq=2400MHz

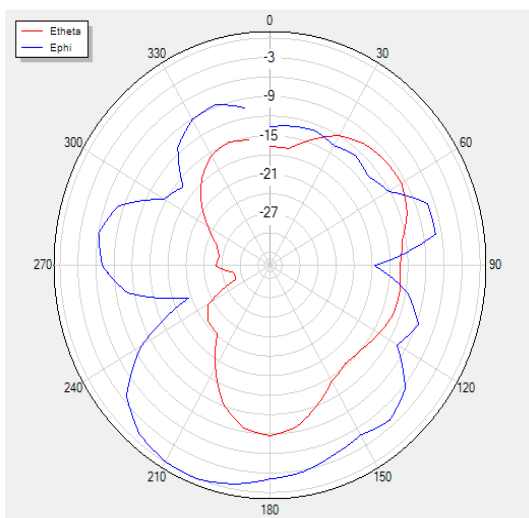

H Theta=0 freq=2400MHz

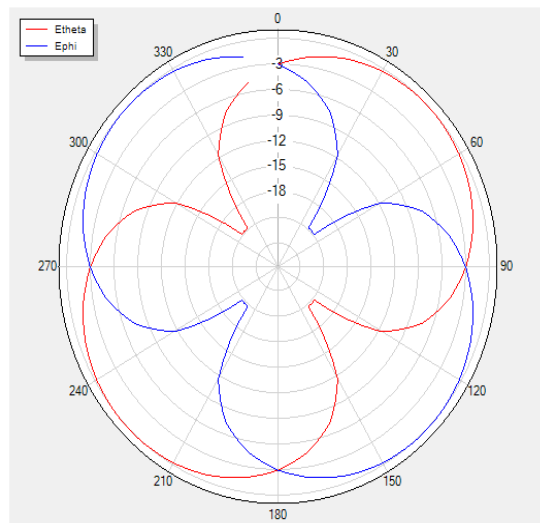

V Phi=90 freq=2400MHz

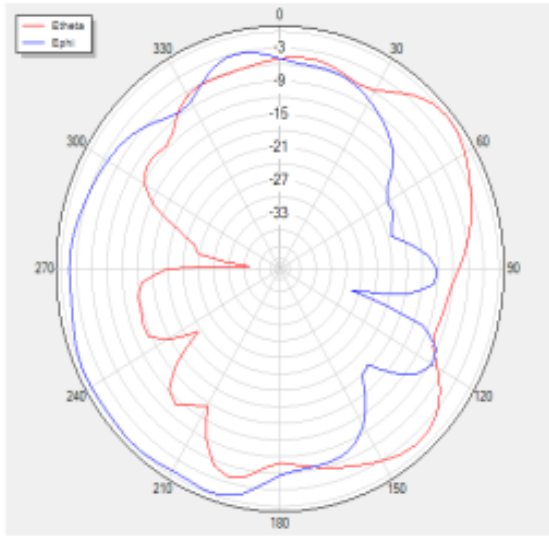

V Phi=0 freq=2400MHz

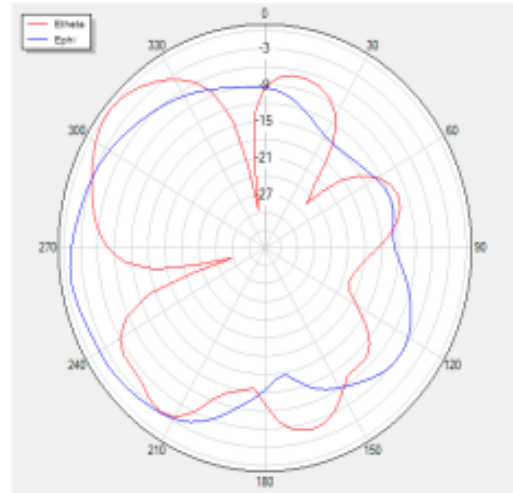

H Theta=90 freq=2450MHz

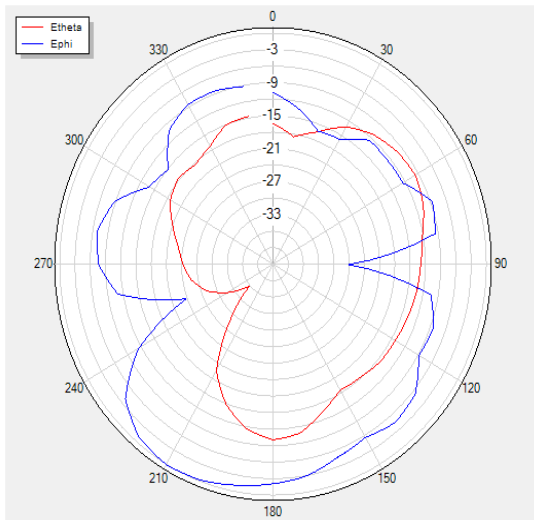

H Theta=0 freq=2450MHz

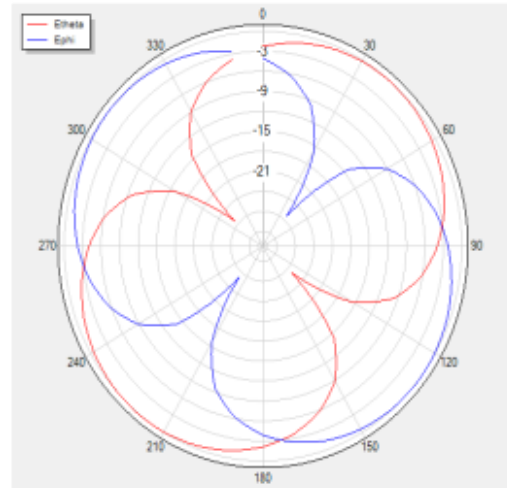

V Phi=90 freq=2450MHz

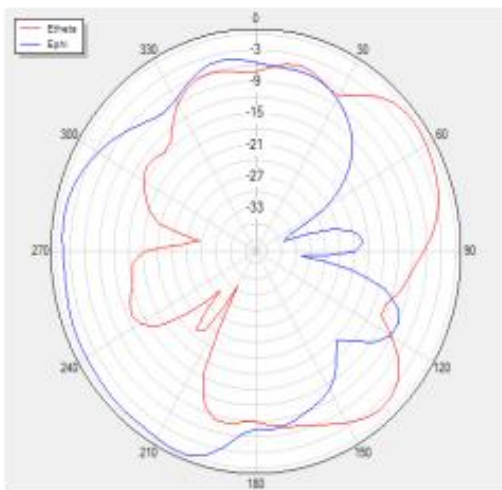

V Phi=0 freq=2450MHz

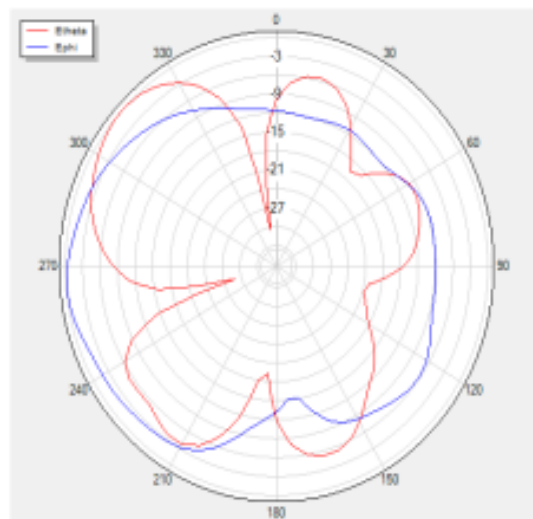

H Theta=90 freq=2500MHz

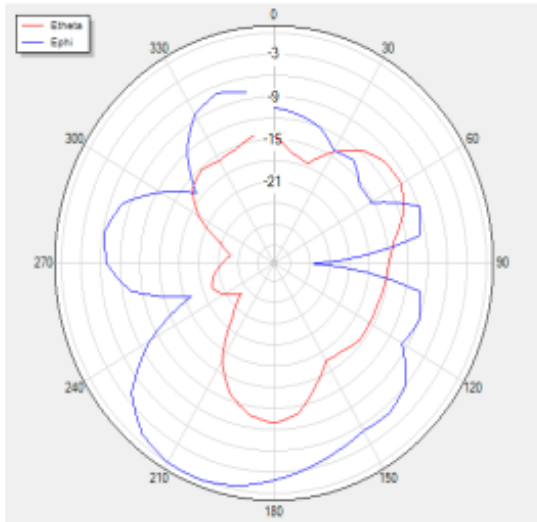

H Theta=0 freq=2500MHz

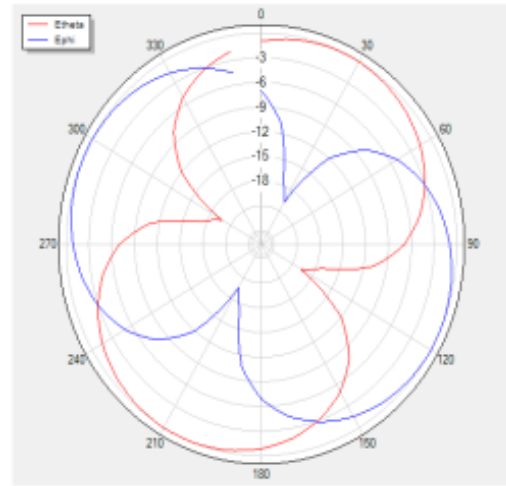

V Phi=0 freq=2500MHz

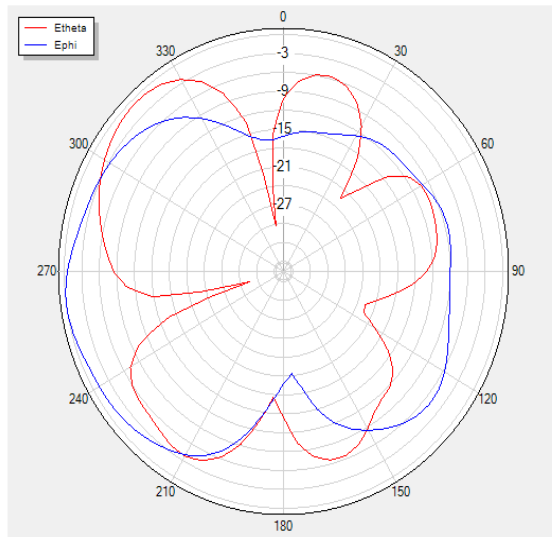

V Phi=90 freq=2500MHz

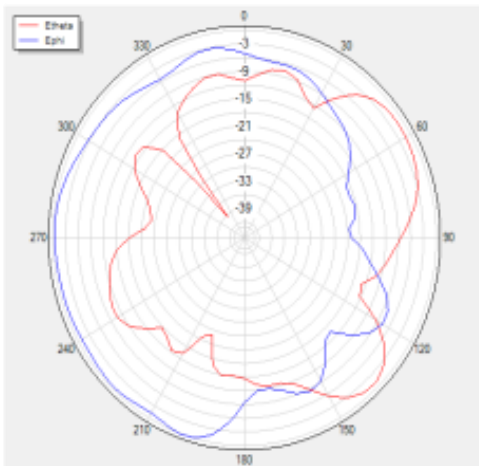

H Theta=90 freq=5200MHz

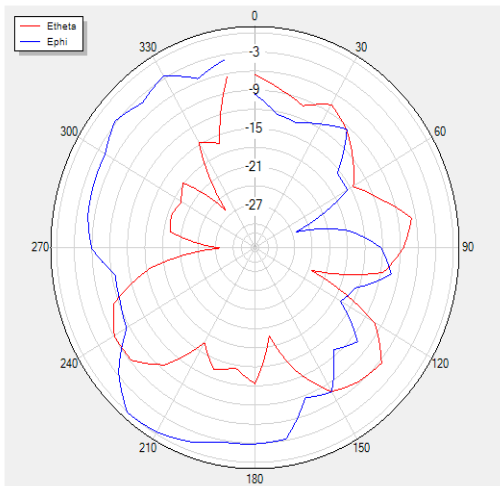

H Theta=0 freq=5200MHz

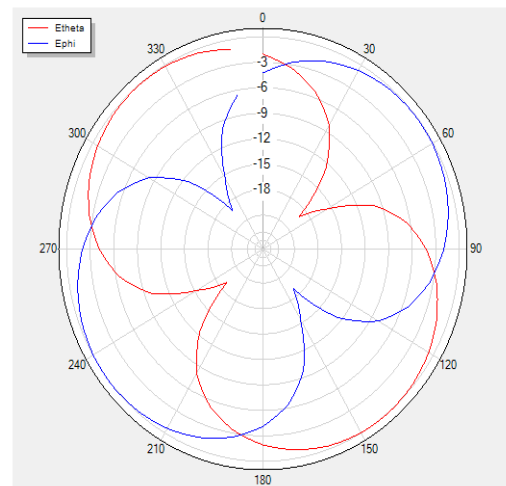

V Phi=90 freq=5200MHz

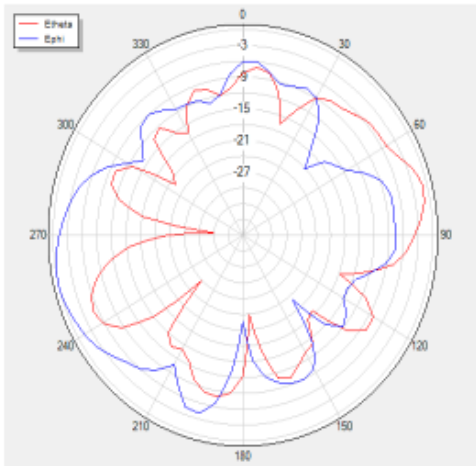

V Phi=0 freq=5200MHz

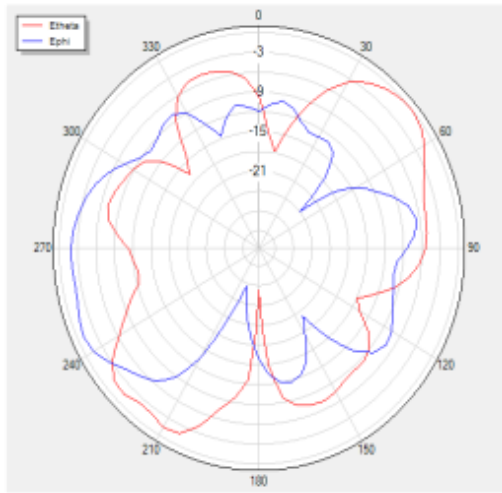

H Theta=90 freq=5400MHz

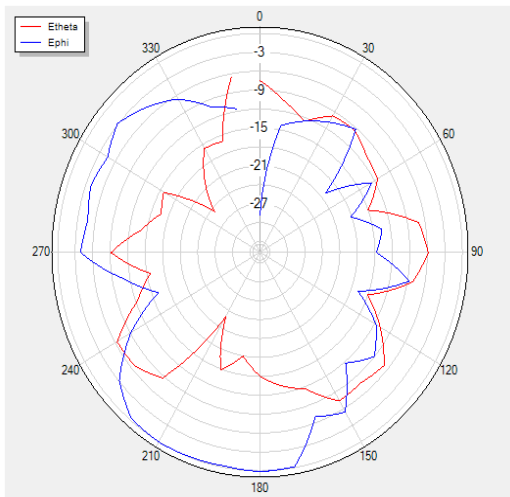

H Theta=0 freq=5400MHz

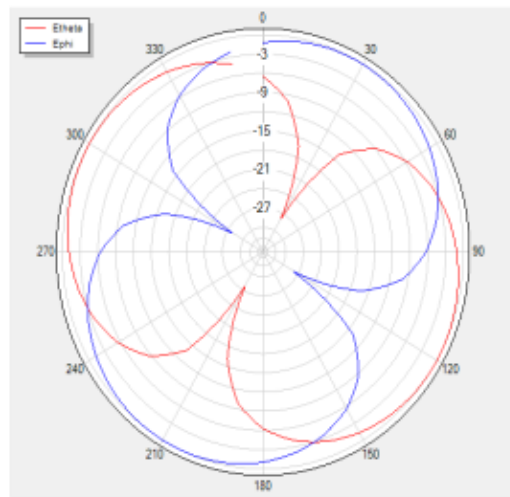

V Phi=90 freq=5400MHz

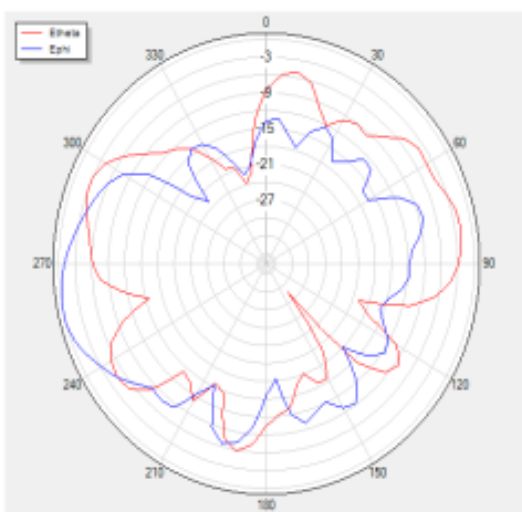

V Phi=0 freq=5400MHz

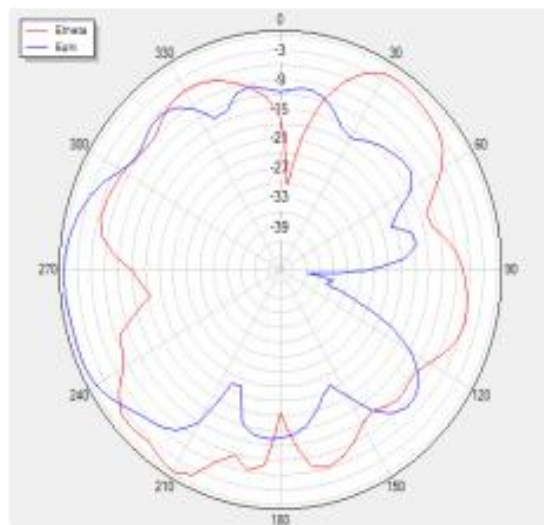

H Theta=90 freq=5800MHz

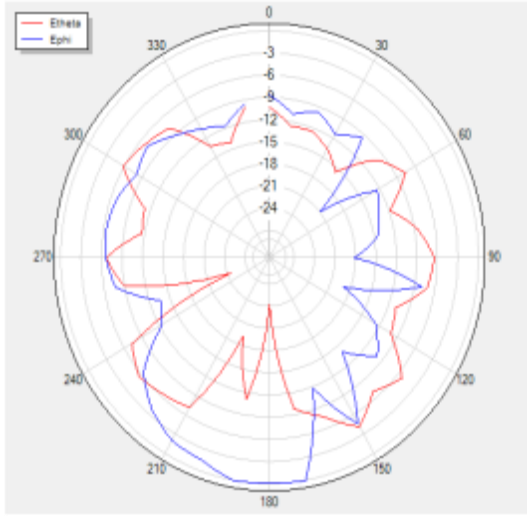

H Theta=0 freq=5800MHz

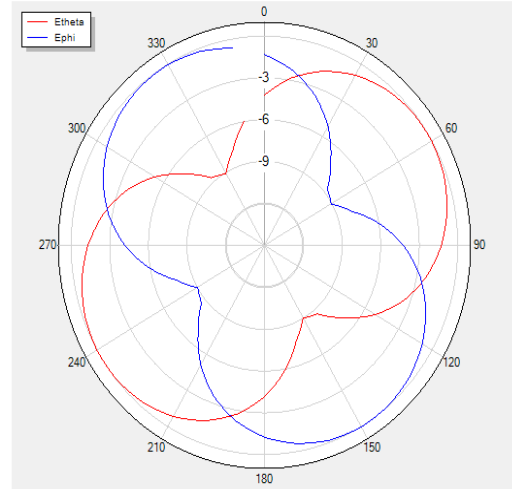

V Phi=90 freq=5800MHz

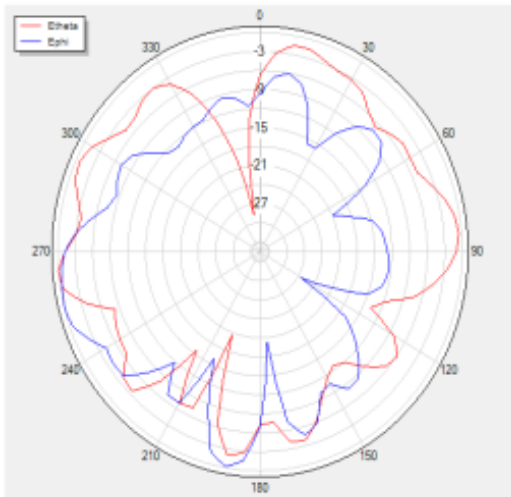

V Phi=0 freq=5800MHz

