



中认信通
CHINA CERTIFICATION ICT CO., LTD (DONGGUAN)



TEST REPORT

Applicant: Shenzhen Youmi Intelligent Technology Co., Ltd

Address: 406-407 Jinqi Zhigu Building, 4/F, 1 Tangling Road, Nanshan District, Shenzhen City, China

FCC ID: 2ATZ4-G3TAB

IC: 26074-G3TAB

HVIN: M869YCR100

Product Name: Smart Tablet Computer

**Standard(s): 47 CFR Part 15, Subpart C(15.247)
RSS-247 Issue 2, February 2017
RSS-Gen, Issue 5, February 2021 Amendment 2
ANSI C63.10-2013
KDB 558074 D01 15.247 Meas Guidance v05r02**

The above equipment has been tested and found compliant with the requirement of the relative standards by China Certification ICT Co., Ltd (Dongguan)

Report Number: CR230205724-00B

Date Of Issue: 2023/3/17

Reviewed By: Sun Zhong

Sun Zhong

Title: Manager

Test Laboratory: China Certification ICT Co., Ltd (Dongguan)

No. 113, Pingkang Road, Dalang Town, Dongguan,
Guangdong, China
Tel: +86-769-82016888

Test Facility

The Test site used by China Certification ICT Co., Ltd (Dongguan) to collect test data is located on the No. 113, Pingkang Road, Dalang Town, Dongguan, Guangdong, China.

The lab has been recognized as the FCC accredited lab under the KDB 974614 D01 and is listed in the FCC Public Access Link (PAL) database, FCC Registration No. : 442868, the FCC Designation No. : CN1314.

The lab has been recognized by Innovation, Science and Economic Development Canada to test to Canadian radio equipment requirements, the CAB identifier: CN0123.

Declarations

China Certification ICT Co., Ltd (Dongguan) is not responsible for the authenticity of any test data provided by the applicant. Data included from the applicant that may affect test results are marked with a triangle symbol “▲”. Customer model name, addresses, names, trademarks etc. are not considered data.

Unless otherwise stated the results shown in this test report refer only to the sample(s) tested.

This report cannot be reproduced except in full, without prior written approval of the Company.

This report is valid only with a valid digital signature. The digital signature may be available only under the Adobe software above version 7.0.

This report may contain data that are not covered by the accreditation scope and shall be marked with an asterisk “★”.

CONTENTS

TEST FACILITY	2
DECLARATIONS.....	2
DOCUMENT REVISION HISTORY	5
1. GENERAL INFORMATION	6
1.1 PRODUCT DESCRIPTION FOR EQUIPMENT UNDER TEST (EUT)	6
1.2 DESCRIPTION OF TEST CONFIGURATION.....	8
1.2.2 Support Equipment List and Details	8
1.2.3 Support Cable List and Details	8
1.2.4 Block Diagram of Test Setup.....	9
1.3 MEASUREMENT UNCERTAINTY	11
2. SUMMARY OF TEST RESULTS	12
3. REQUIREMENTS AND TEST PROCEDURES	13
3.1 AC LINE CONDUCTED EMISSIONS.....	13
3.1.1 Applicable Standard.....	13
3.1.2 EUT Setup.....	15
3.1.3 EMI Test Receiver Setup	15
3.1.4 Test Procedure	16
3.1.5 Corrected Amplitude & Margin Calculation.....	16
3.2 RADIATED SPURIOUS EMISSIONS.....	17
3.2.1 Applicable Standard.....	17
3.2.2 EUT Setup.....	17
3.2.3 EMI Test Receiver & Spectrum Analyzer Setup	18
3.2.4 Test Procedure	18
3.2.5 Corrected Amplitude & Margin Calculation.....	19
3.3 MINIMUM 6 DB BANDWIDTH:	20
3.3.1 Applicable Standard.....	20
3.3.2 EUT Setup.....	20
3.3.3 Test Procedure	20
3.4 99% OCCUPIED BANDWIDTH:	21
3.4.1 Applicable Standard.....	21
3.4.2 EUT Setup.....	22
3.4.3 Test Procedure	22
3.5 MAXIMUM CONDUCTED OUTPUT POWER:	23
3.5.1 Applicable Standard.....	23
3.5.2 EUT Setup.....	23
3.5.3 Test Procedure	23
3.6 MAXIMUM POWER SPECTRAL DENSITY:	24
3.6.1 Applicable Standard.....	24
3.6.2 EUT Setup.....	24
3.6.3 Test Procedure	24
3.7 100 KHZ BANDWIDTH OF FREQUENCY BAND EDGE:.....	25

3.7.1 Applicable Standard.....	25
3.7.2 EUT Setup.....	25
3.7.3 Test Procedure	25
3.8 DUTY CYCLE:.....	26
3.8.1 EUT Setup.....	26
3.8.2 Test Procedure	26
3.9 ANTENNA REQUIREMENT.....	27
3.9.1 Applicable Standard.....	27
3.9.2 Judgment.....	27
4. Test DATA AND RESULTS	28
4.1 AC LINE CONDUCTED EMISSIONS.....	28
4.2 RADIATION SPURIOUS EMISSIONS	31
4.3 MINIMUM 6 dB BANDWIDTH:	40
4.4 99% OCCUPIED BANDWIDTH:	45
4.5 MAXIMUM CONDUCTED OUTPUT POWER:	50
4.6 MAXIMUM POWER SPECTRAL DENSITY:	51
4.7 100 KHZ BANDWIDTH OF FREQUENCY BAND EDGE:	56
4.8 DUTY CYCLE:.....	61

DOCUMENT REVISION HISTORY

Revision Number	Report Number	Description of Revision	Date of Revision
1.0	CR230205724-00B	Original Report	2023/3/17

1. GENERAL INFORMATION

1.1 Product Description for Equipment under Test (EUT)

EUT Name:	Smart Tablet Computer
EUT Model:	G3 Tab
Firmware Version:	UMIDIGI_G3 Tab_V1.0
Operation Frequency:	2412-2462 MHz(802.11b/g/n ht20), 2422-2452MHz(802.11n ht40)
Maximum Average Output Power (Conducted):	13.08dBm
Modulation Type:	802.11b:DSSS-DBPSK, DQPSK, CCK 802.11g/n: OFDM-BPSK, QPSK, 16QAM, 64QAM
Rated Input Voltage:	DC 3.8V from battery or DC 5V from adapter
Serial Number:	2295
EUT Received Date:	2023/02/22
EUT Received Status:	Good

Operation Frequency Detail: For 802.11b/g/n ht20:

Channel	Frequency (MHz)	Channel	Frequency (MHz)
1	2412	7	2442
2	2417	8	2447
3	2422	9	2452
4	2427	10	2457
5	2432	11	2462
6	2437	/	/

Per section 15.31(m)/RSS-Gen, the below frequencies were performed the test as below:

Test Channel	Frequency (MHz)
Lowest	2412
Middle	2437
Highest	2462

For 802.11n ht40:

Channel	Frequency (MHz)	Channel	Frequency (MHz)
3	2422	7	2442
4	2427	8	2447
5	2432	9	2452
6	2437	/	/

Per section 15.31(m), the below frequencies were performed the test as below:

Test Channel	Frequency (MHz)
Lowest	2422
Middle	2437
Highest	2452

Antenna Information Detail▲:

Antenna Manufacturer	Antenna Type	input impedance (Ohm)	Frequency Range	Antenna Gain
ANWEI communication Equipment Co.,Ltd	FPC	50	2.4~2.5GHz	0.97 dBi

The Method of §15.203 Compliance:

- Antenna must be permanently attached to the unit.
- Antenna must use a unique type of connector to attach to the EUT.
- Unit must be professionally installed, and installer shall be responsible for verifying that the correct antenna is employed with the unit.

Accessory Information:

Accessory Description	Manufacturer	Model	Parameters
Adapter	UMIDIGI	HJ-0502000W2-US	Input: 100-240V~50/60Hz, 0.3A Output: 5.0V, 2A

1.2 Description of Test Configuration

1.2.1 EUT Operation Condition:

EUT Operation Mode:	The system was configured for testing in Engineering Mode, which was provided by the manufacturer.
Equipment Modifications:	No
EUT Exercise Software:	Engineering mode

The software was provided by manufacturer. The maximum power was configured as below, that was provided by the manufacturer ▲:

Test Modes	Data Rate	Power Level Setting		
		Lowest Channel	Middle Channel	Highest Channel
802.11b	1Mbps	18	18	18
802.11g	6Mbps	17	17	17
802.11n ht20	MCS0	17	17	17
802.11n ht40	MCS0	16	16	16

The above are the worst-case data rates, which are determined for each mode based upon investigations by measuring the average power and PSD across all data rates, bandwidths, and modulations.

1.2.2 Support Equipment List and Details

Manufacturer	Description	Model	Serial Number
Unknown	Earphone	Unknown	Earphone 01

1.2.3 Support Cable List and Details

Cable Description	Shielding Type	Ferrite Core	Length (m)	From Port	To
USB Cable	Yes	No	0.8	Adapter	EUT
Earphone Cable	No	No	1.2	EUT	Earphone

1.2.4 Block Diagram of Test Setup

AC line conducted emissions:

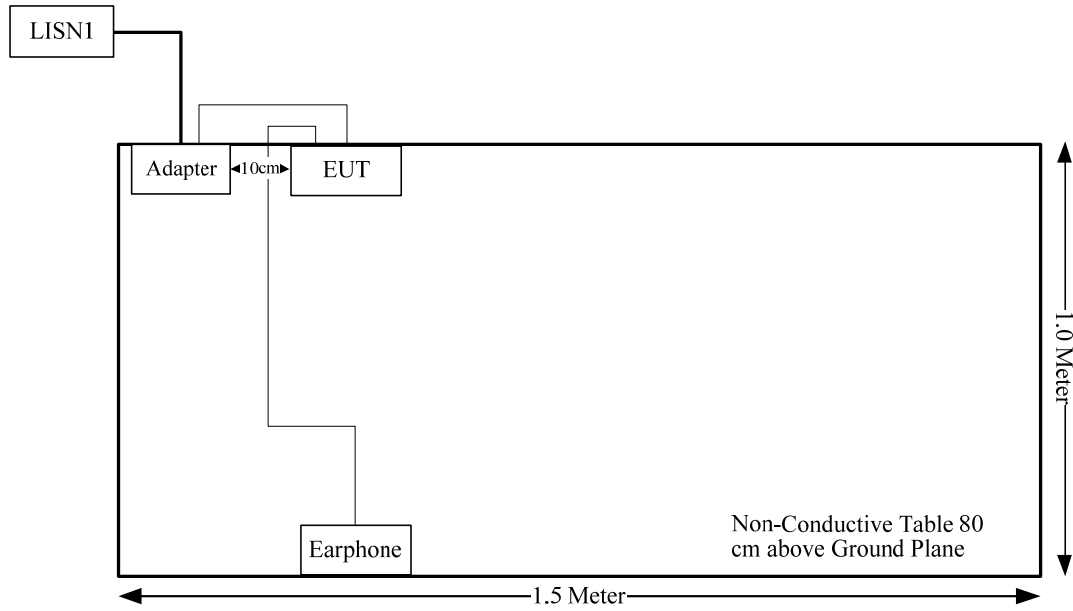

Radiated Spurious Emissions:
Below 1GHz:

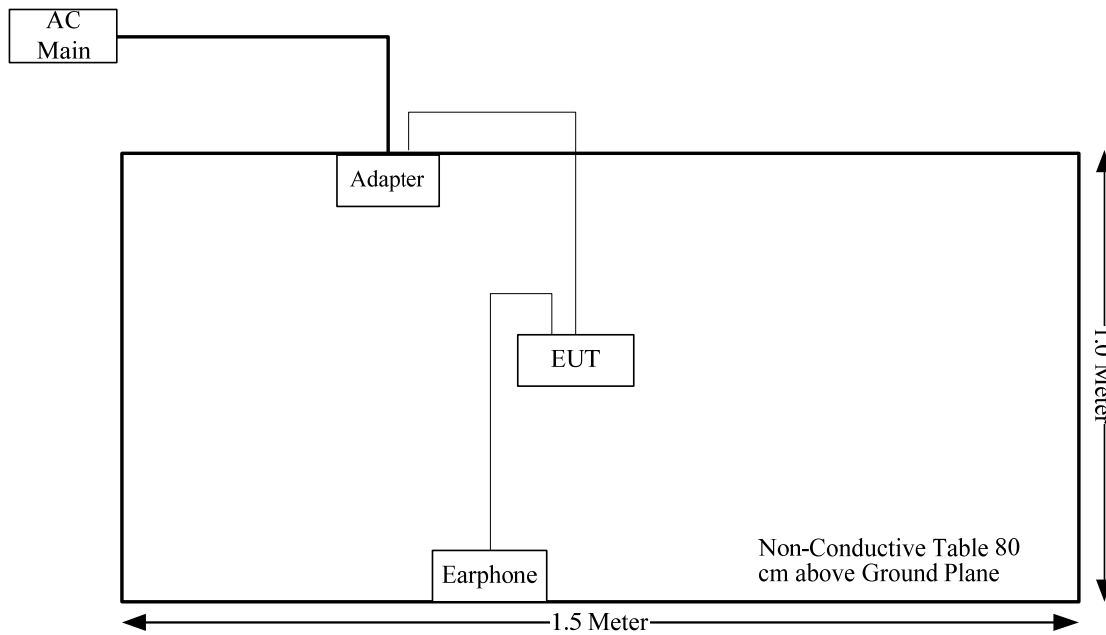

Above 1GHz:

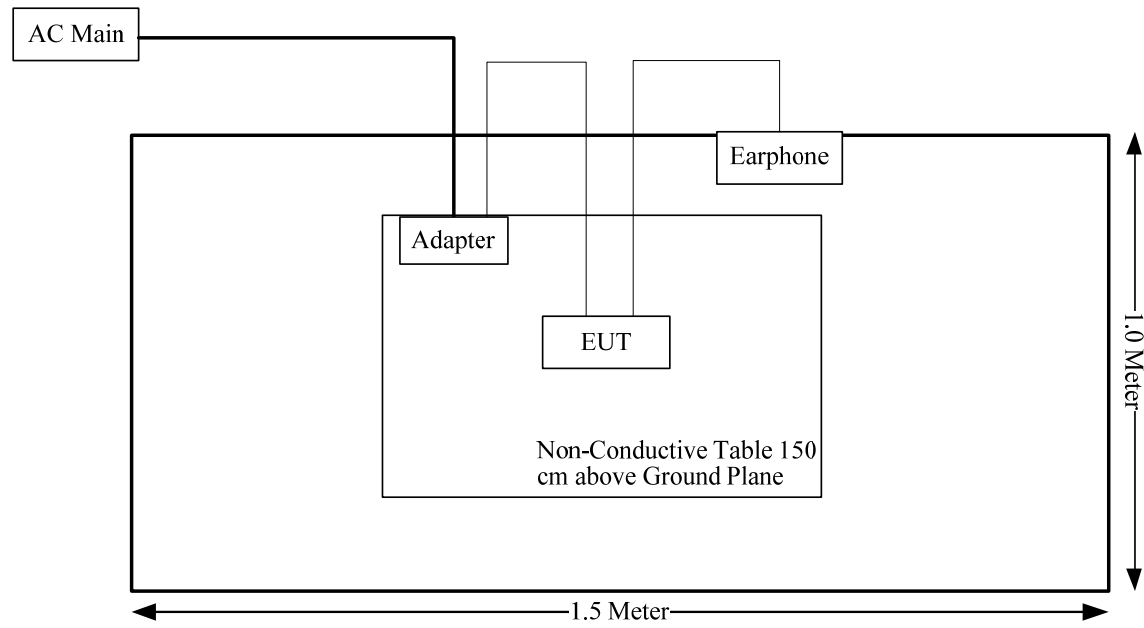

1.3 Measurement Uncertainty

Otherwise required by the applicant or Product Regulations, Decision Rule in this report did not consider the uncertainty. The extended uncertainty given in this report is obtained by combining the standard uncertainty times the coverage factor K with the 95% confidence interval.

Parameter	Measurement Uncertainty
Occupied Channel Bandwidth	±5 %
RF output power, conducted	±0.61dB
Power Spectral Density, conducted	±0.61 dB
Unwanted Emissions, radiated	30M~200MHz: 4.15 dB,200M~1GHz: 5.61 dB,1G~6GHz: 5.14 dB, 6G~18GHz: 5.93 dB,18G~26.5G:5.47 dB,26.5G~40G:5.63 dB
Unwanted Emissions, conducted	±1.26 dB
Temperature	±1 °C
Humidity	±5%
DC and low frequency voltages	±0.4%
Duty Cycle	1%
AC Power Lines Conducted Emission	2.8 dB (150 kHz to 30 MHz)

2. SUMMARY OF TEST RESULTS

Standard(s) Section	Test Items	Result
§15.207(a) RSS-Gen Clause 8.8	AC line Conducted Emissions	Compliant
§15.205, §15.209, §15.247(d) RSS-Gen Clause 8.10	Radiated Spurious Emissions	Compliant
§15.247 (a)(2) RSS-247 Clause 5.2 a)	Minimum 6 dB Bandwidth	Compliant
RSS-Gen Clause 6.7	99% Occupied Bandwidth	Compliant
§15.247(b)(3) RSS-247 Clause 5.4 d)	Maximum Conducted Output Power	Compliant
§15.247(d) RSS-247 Clause5.5	100 kHz Bandwidth Of Frequency Band Edge	Compliant
§15.247(e) RSS-247 Clause5.2 b)	Power Spectral Density	Compliant
§15.203 RSS-GEN Clause 6.8	Antenna Requirement	Compliant

3. REQUIREMENTS AND TEST PROCEDURES

3.1 AC Line Conducted Emissions

3.1.1 Applicable Standard

FCC§15.207(a).

(a) Except as shown in paragraphs (b) and (c) of this section, for an intentional radiator that is designed to be connected to the public utility (AC) power line, the radio frequency voltage that is conducted back onto the AC power line on any frequency or frequencies, within the band 150 kHz to 30 MHz, shall not exceed the limits in the following table, as measured using a 50 μ H/50 ohms line impedance stabilization network (LISN). Compliance with the provisions of this paragraph shall be based on the measurement of the radio frequency voltage between each power line and ground at the power terminal. The lower limit applies at the boundary between the frequency ranges.

Frequency of emission (MHz)	Conducted limit (dB μ V)	
	Quasi-peak	Average
0.15-0.5	66 to 56*	56 to 46*
0.5-5	56	46
5-30	60	50

*Decreases with the logarithm of the frequency.

(b) The limit shown in paragraph (a) of this section shall not apply to carrier current systems operating as intentional radiators on frequencies below 30 MHz. In lieu thereof, these carrier current systems shall be subject to the following standards:

(1) For carrier current system containing their fundamental emission within the frequency band 535-1705 kHz and intended to be received using a standard AM broadcast receiver: no limit on conducted emissions.

(2) For all other carrier current systems: 1000 μ V within the frequency band 535-1705 kHz, as measured using a 50 μ H/50 ohms LISN.

(3) Carrier current systems operating below 30 MHz are also subject to the radiated emission limits in §15.205, §15.209, §15.221, §15.223, or §15.227, as appropriate.

(c) Measurements to demonstrate compliance with the conducted limits are not required for devices which only employ battery power for operation and which do not operate from the AC power lines or contain provisions for operation while connected to the AC power lines. Devices that include, or make provisions for, the use of battery chargers which permit operating while charging, AC adapters or battery eliminators or that connect to the AC power lines indirectly, obtaining their power through another device which is connected to the AC power lines, shall be tested to demonstrate compliance with the conducted limits.

RSS-Gen Clause 8.8

Unless stated otherwise in the applicable RSS, for radio apparatus that are designed to be connected to the public utility AC power network, the radio frequency voltage that is conducted back onto the AC power line on any frequency or frequencies within the range 150 kHz to 30 MHz shall not exceed the limits in table 4, as measured using a 50 μ H / 50 Ω line impedance stabilization network. This requirement applies for the radio frequency voltage measured between each power line and the ground terminal of each AC power-line mains cable of the EUT.

For an EUT that connects to the AC power lines indirectly, through another device, the requirement for compliance with the limits in table 4 shall apply at the terminals of the AC power-line mains cable of a representative support device, while it provides power to the EUT. The lower limit applies at the boundary between the frequency ranges. The device used to power the EUT shall be representative of typical applications.

Table 4 – AC power-line conducted emissions limits

Frequency (MHz)	Conducted limit (dB μ V)	
	Quasi-peak	Average
0.15 - 0.5	66 to 56 ¹	56 to 46 ¹
0.5 – 5	56	46
5 – 30	60	50

Note 1: The level decreases linearly with the logarithm of the frequency.

For an EUT with a permanent or detachable antenna operating between 150 kHz and 30 MHz, the AC power-line conducted emissions must be measured using the following configurations:

(a) Perform the AC power-line conducted emissions test with the antenna connected to determine compliance with the limits of table 4 outside the transmitter's fundamental emission band.

(b) Retest with a dummy load instead of the antenna to determine compliance with the limits of table 4 within the transmitter's fundamental emission band. For a detachable antenna, remove the antenna and connect a suitable dummy load to the antenna connector. For a permanent antenna, remove the antenna and terminate the RF output with a dummy load or network that simulates the antenna in the fundamental frequency band.

3.1.2 EUT Setup

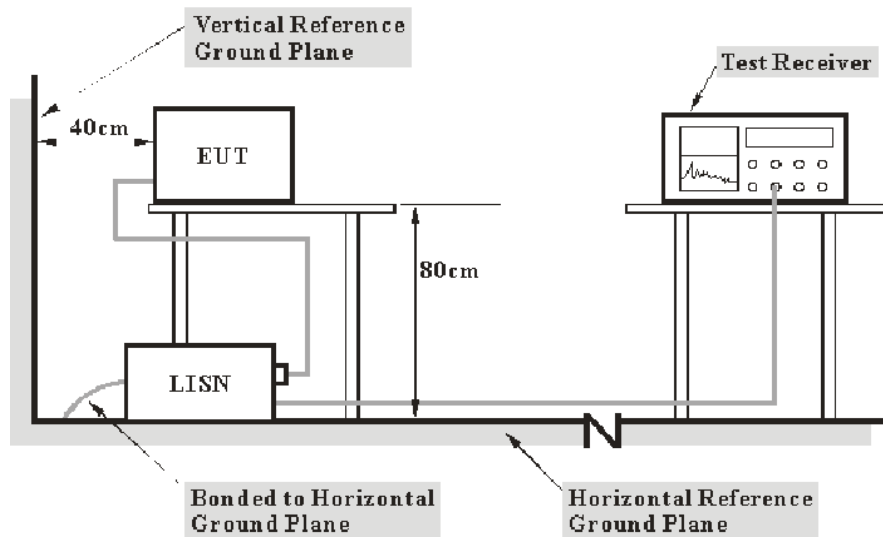

- Note: 1. Support units were connected to second LISN.
 2. Both of LISNs (AMN) 80 cm from EUT and at the least 80 cm from other units and other metal planes support units.

The setup of EUT is according with per ANSI C63.10-2013 measurement procedure. The specification used was with the FCC Part 15.207,RSS-Gen limits.

The spacing between the peripherals was 10 cm.

The adapter or EUT was connected to the main LISN with a 120 V/60 Hz AC power source.

3.1.3 EMI Test Receiver Setup

The EMI test receiver was set to investigate the spectrum from 150 kHz to 30 MHz.

During the conducted emission test, the EMI test receiver was set with the following configurations:

Frequency Range	IF B/W
150 kHz – 30 MHz	9 kHz

3.1.4 Test Procedure

The frequency and amplitude of the six highest ac power-line conducted emissions relative to the limit, measured over all the current-carrying conductors of the EUT power cords, and the operating frequency or frequency to which the EUT is tuned (if appropriate), should be reported, unless such emissions are more than 20 dB below the limit. AC power-line conducted emissions measurements are to be separately carried out only on each of the phase (“hot”) line(s) and (if used) on the neutral line(s), but not on the ground [protective earth] line(s). If less than six emission frequencies are within 20 dB of the limit, then the noise level of the measuring instrument at representative frequencies should be reported. The specific conductor of the power-line cord for each of the reported emissions should be identified. Measure the six highest emissions with respect to the limit on each current-carrying conductor of each power cord associated with the EUT (but not the power cords of associated or peripheral equipment that are part of the test configuration). Then, report the six highest emissions with respect to the limit from among all the measurements identifying the frequency and specific current-carrying conductor identified with the emission. The six highest emissions should be reported for each of the current-carrying conductors, or the six highest emissions may be reported over all the current-carrying conductors.

3.1.5 Corrected Amplitude & Margin Calculation

The basic equation is as follows:

Result = Reading + Factor

Factor = attenuation caused by cable loss + voltage division factor of AMN

The “**Margin**” column of the following data tables indicates the degree of compliance within the applicable limit. The equation for margin calculation is as follows:

Margin = Limit – Result

3.2 Radiated Spurious Emissions

3.2.1 Applicable Standard

FCC §15.247 (d);

In any 100 kHz bandwidth outside the frequency band in which the spread spectrum or digitally modulated intentional radiator is operating, the radio frequency power that is produced by the intentional radiator shall be at least 20 dB below that in the 100 kHz bandwidth within the band that contains the highest level of the desired power, based on either an RF conducted or a radiated measurement, provided the transmitter demonstrates compliance with the peak conducted power limits. If the transmitter complies with the conducted power limits based on the use of RMS averaging over a time interval, as permitted under paragraph (b)(3) of this section, the attenuation required under this paragraph shall be 30 dB instead of 20 dB. Attenuation below the general limits specified in §15.209(a) is not required. In addition, radiated emissions which fall in the restricted bands, as defined in §15.205(a), must also comply with the radiated emission limits specified in §15.209(a) (see §15.205(c)).

RSS-247 Clause 5.5

In any 100 kHz bandwidth outside the frequency band in which the spread spectrum or digitally modulated device is operating, the RF power that is produced shall be at least 20 dB below that in the 100 kHz bandwidth within the band that contains the highest level of the desired power, based on either an RF conducted or a radiated measurement, provided that the transmitter demonstrates compliance with the peak conducted power limits. If the transmitter complies with the conducted power limits based on the use of root-mean-square averaging over a time interval, as permitted under section 5.4(d), the attenuation required shall be 30 dB instead of 20 dB. Attenuation below the general field strength limits specified in RSS-Gen is not required

3.2.2 EUT Setup

Below 1GHz:

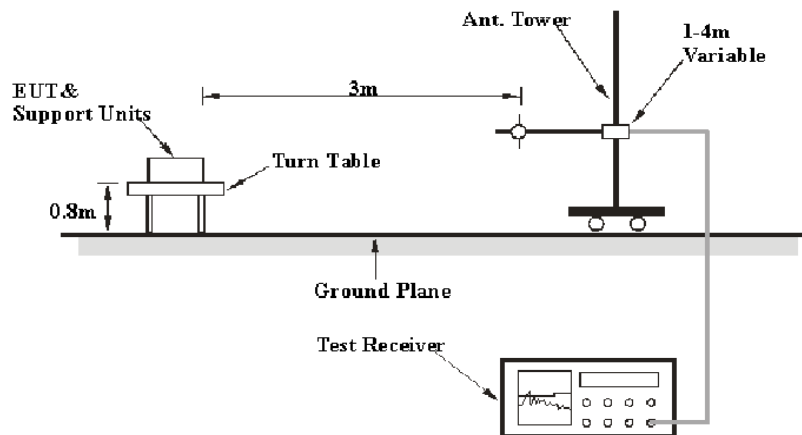

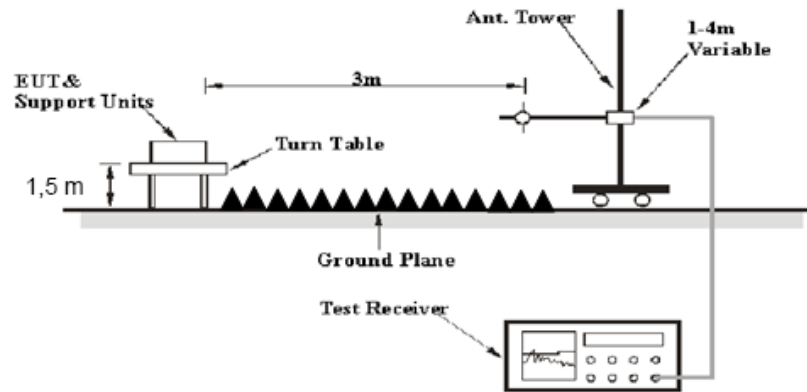
Above 1GHz:

The radiated emissions were performed in the 3 meters distance, using the setup accordance with the ANSI C63.10-2013. The specification used was the FCC 15.209, and FCC 15.247, RSS-247, RSS-Gen limits.

The external I/O cables were draped along the test table and formed a bundle 30 to 40 cm long in the middle.

The spacing between the peripherals was 10 cm.

3.2.3 EMI Test Receiver & Spectrum Analyzer Setup

The system was investigated from 30 MHz to 25 GHz.

During the radiated emission test, the EMI test receiver & Spectrum Analyzer Setup were set with the following configurations:

30-1000MHz:

Detector	RBW	Video B/W	IF B/W
QP	120 kHz	300 kHz	120kHz

1GHz- 25GHz:

Measurement	Duty cycle	RBW	Video B/W
PK	Any	1MHz	3 MHz
AV	>98%	1MHz	10 Hz
	<98%	1MHz	1/T

Note: T is minimum transmission duration

If the maximized peak measured value complies with under the QP/Average limit more than 6dB, then it is unnecessary to perform an QP/Average measurement.

3.2.4 Test Procedure

Maximizing procedure was performed on the highest emissions to ensure that the EUT complied with all installation combinations.

Data was recorded in Quasi-peak detection mode for frequency range of 30 MHz-1 GHz, peak and Average detection modes for frequencies above 1 GHz.

3.2.5 Corrected Amplitude & Margin Calculation

The basic equation is as follows:

$$\text{Result} = \text{Reading} + \text{Factor}$$

$$\text{Factor} = \text{Antenna Factor} + \text{Cable Loss} - \text{Amplifier Gain}$$

The “**Margin**” column of the following data tables indicates the degree of compliance within the applicable limit. The equation for margin calculation is as follows:

$$\text{Margin} = \text{Limit} - \text{Result}$$

3.3 Minimum 6 dB Bandwidth:

3.3.1 Applicable Standard

FCC §15.247 (a)(2)

Systems using digital modulation techniques may operate in the 902-928 MHz, 2400-2483.5 MHz, and 5725-5850 MHz bands. The minimum 6 dB bandwidth shall be at least 500 kHz.

RSS-247 Clause 5.2 a

The minimum 6 dB bandwidth shall be 500 kHz.

3.3.2 EUT Setup

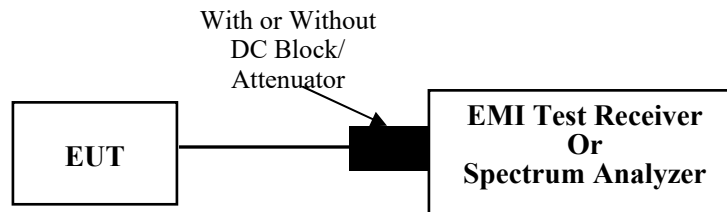

3.3.3 Test Procedure

According to ANSI C63.10-2013 Section 11.8

- a) Set RBW = 100 kHz.
- b) Set the video bandwidth (VBW) $\geq 3 \times$ RBW.
- c) Detector = Peak.
- d) Trace mode = max hold.
- e) Sweep = auto couple.
- f) Allow the trace to stabilize.
- g) Measure the maximum width of the emission that is constrained by the frequencies associated with the two outermost amplitude points (upper and lower frequencies) that are attenuated by 6 dB relative to the maximum level measured in the fundamental emission.

3.4 99% Occupied Bandwidth:

3.4.1 Applicable Standard

RSS-Gen Clause 6.7

The occupied bandwidth or the “99% emission bandwidth” is defined as the frequency range between two points, one above and the other below the carrier frequency, within which 99% of the total transmitted power of the fundamental transmitted emission is contained. The occupied bandwidth shall be reported for all equipment in addition to the specified bandwidth required in the applicable RSSs.

In some cases, the “x dB bandwidth” is required, which is defined as the frequency range between two points, one at the lowest frequency below and one at the highest frequency above the carrier frequency, at which the maximum power level of the transmitted emission is attenuated x dB below the maximum in-band power level of the modulated signal, where the two points are on the outskirts of the in-band emission.

The following conditions shall be observed for measuring the occupied bandwidth and x dB bandwidth:

- The transmitter shall be operated at its maximum carrier power measured under normal test conditions.
- The span of the spectrum analyzer shall be set large enough to capture all products of the modulation process, including the emission skirts, around the carrier frequency, but small enough to avoid having other emissions (e.g. on adjacent channels) within the span.
- The detector of the spectrum analyzer shall be set to “Sample”. However, a peak, or peak hold, may be used in place of the sampling detector since this usually produces a wider bandwidth than the actual bandwidth (worst-case measurement). Use of a peak hold (or “Max Hold”) may be necessary to determine the occupied / x dB bandwidth if the device is not transmitting continuously.
- The resolution bandwidth (RBW) shall be in the range of 1% to 5% of the actual occupied / x dB bandwidth and the video bandwidth (VBW) shall not be smaller than three times the RBW value. Video averaging is not permitted.

Note: It may be necessary to repeat the measurement a few times until the RBW and VBW are in compliance with the above requirement.

For the 99% emission bandwidth, the trace data points are recovered and directly summed in linear power level terms. The recovered amplitude data points, beginning at the lowest frequency, are placed in a running sum until 0.5% of the total is reached, and that frequency recorded. The process is repeated for the highest frequency data points (starting at the highest frequency, at the right side of the span, and going down in frequency). This frequency is then recorded. The difference between the two recorded frequencies is the occupied bandwidth (or the 99% emission bandwidth).

3.4.2 EUT Setup

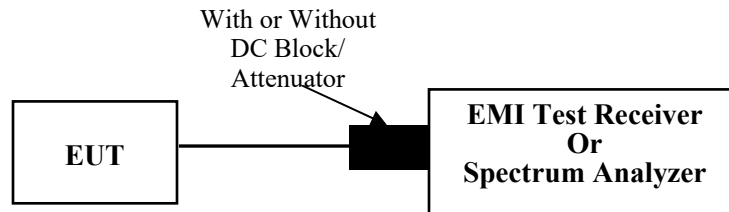

3.4.3 Test Procedure

According to ANSI C63.10-2013 Section 6.9.3

The occupied bandwidth is the frequency bandwidth such that, below its lower and above its upper frequency limits, the mean powers are each equal to 0.5% of the total mean power of the given emission. The following procedure shall be used for measuring 99% power bandwidth:

- a) The instrument center frequency is set to the nominal EUT channel center frequency. The frequency span for the spectrum analyzer shall be between 1.5 times and 5.0 times the OBW.
- b) The nominal IF filter bandwidth (3 dB RBW) shall be in the range of 1% to 5% of the OBW, and VBW shall be approximately three times the RBW, unless otherwise specified by the applicable requirement.
- c) Set the reference level of the instrument as required, keeping the signal from exceeding the maximum input mixer level for linear operation. In general, the peak of the spectral envelope shall be more than $[10 \log (OBW/RBW)]$ below the reference level. Specific guidance is given in 4.1.5.2.
- d) Step a) through step c) might require iteration to adjust within the specified range.
- e) Video averaging is not permitted. Where practical, a sample detection and single sweep mode shall be used. Otherwise, peak detection and max hold mode (until the trace stabilizes) shall be used.
- f) Use the 99% power bandwidth function of the instrument (if available) and report the measured bandwidth.
- g) If the instrument does not have a 99% power bandwidth function, then the trace data points are recovered and directly summed in linear power terms. The recovered amplitude data points, beginning at the lowest frequency, are placed in a running sum until 0.5% of the total is reached; that frequency is recorded as the lower frequency. The process is repeated until 99.5% of the total is reached; that frequency is recorded as the upper frequency. The 99% power bandwidth is the difference between these two frequencies.
- h) The occupied bandwidth shall be reported by providing plot(s) of the measuring instrument display; the plot axes and the scale units per division shall be clearly labeled. Tabular data may be reported in addition to the plot(s).

3.5 Maximum Conducted Output Power:

3.5.1 Applicable Standard

FCC §15.247 (b)(3)

For systems using digital modulation in the 902-928 MHz, 2400-2483.5 MHz, and 5725-5850 MHz bands: 1 Watt. As an alternative to a peak power measurement, compliance with the one Watt limit can be based on a measurement of the maximum conducted output power. Maximum Conducted Output Power is defined as the total transmit power delivered to all antennas and antenna elements averaged across all symbols in the signaling alphabet when the transmitter is operating at its maximum power control level. Power must be summed across all antennas and antenna elements. The average must not include any time intervals during which the transmitter is off or is transmitting at a reduced power level. If multiple modes of operation are possible (e.g., alternative modulation methods), the maximum conducted output power is the highest total transmit power occurring in any mode.

RSS-247 Clause 5.4 d

For DTSs employing digital modulation techniques operating in the bands 902-928 MHz and 2400-2483.5 MHz, the maximum peak conducted output power shall not exceed 1W. The e.i.r.p. shall not exceed 4 W, except as provided in section 5.4(e).

3.5.2 EUT Setup

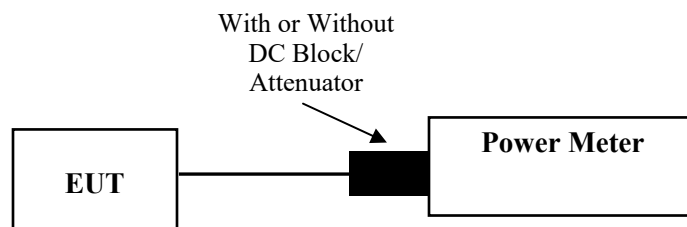

3.5.3 Test Procedure

According to ANSI C63.10-2013 Section 11.9.2.3.2

Method AVGP-G is a measurement using a gated RF average power meter.

Alternatively, measurements may be performed using a wideband gated RF power meter provided that the gate parameters are adjusted such that the power is measured only when the EUT is transmitting at its maximum power control level. Because the measurement is made only during the ON time of the transmitter, no duty cycle correction factor is required.

3.6 Maximum Power Spectral Density:

3.6.1 Applicable Standard

FCC §15.247 (e)

For digitally modulated systems, the power spectral density conducted from the intentional radiator to the antenna shall not be greater than 8 dBm in any 3 kHz band during any time interval of continuous transmission. This power spectral density shall be determined in accordance with the provisions of paragraph (b) of this section. The same method of determining the conducted output power shall be used to determine the power spectral density.

RSS-247 Clause 5.2 b

The transmitter power spectral density conducted from the transmitter to the antenna shall not be greater than 8 dBm in any 3 kHz band during any time interval of continuous transmission. This power spectral density shall be determined in accordance with the provisions of section 5.4(d), (i.e. the power spectral density shall be determined using the same method as is used to determine the conducted output power).

3.6.2 EUT Setup

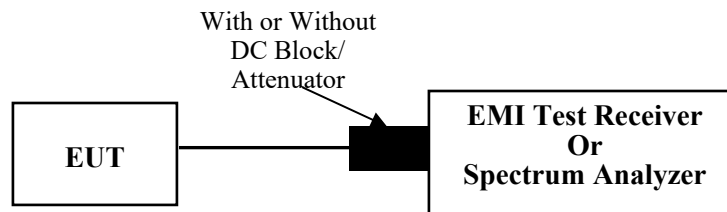

3.6.3 Test Procedure

Duty cycle $\geq 98\%$

According to ANSI C63.10-2013 Section 11.10.3

Duty cycle $< 98\%$, duty cycle variations are less than $\pm 2\%$

According to ANSI C63.10-2013 Section 11.10.5

Duty cycle $< 98\%$, duty cycle variations exceed $\pm 2\%$

According to ANSI C63.10-2013 Section 11.10.7

3.7 100 kHz Bandwidth Of Frequency Band Edge:

3.7.1 Applicable Standard

FCC §15.247 (d);

In any 100 kHz bandwidth outside the frequency band in which the spread spectrum or digitally modulated intentional radiator is operating, the radio frequency power that is produced by the intentional radiator shall be at least 20 dB below that in the 100 kHz bandwidth within the band that contains the highest level of the desired power, based on either an RF conducted or a radiated measurement, provided the transmitter demonstrates compliance with the peak conducted power limits. If the transmitter complies with the conducted power limits based on the use of RMS averaging over a time interval, as permitted under paragraph (b)(3) of this section, the attenuation required under this paragraph shall be 30 dB instead of 20 dB. Attenuation below the general limits specified in §15.209(a) is not required. In addition, radiated emissions which fall in the restricted bands, as defined in §15.205(a), must also comply with the radiated emission limits specified in §15.209(a) (see §15.205(c)).

RSS-247 Clause 5.5

In any 100 kHz bandwidth outside the frequency band in which the spread spectrum or digitally modulated device is operating, the RF power that is produced shall be at least 20 dB below that in the 100 kHz bandwidth within the band that contains the highest level of the desired power, based on either an RF conducted or a radiated measurement, provided that the transmitter demonstrates compliance with the peak conducted power limits. If the transmitter complies with the conducted power limits based on the use of root-mean-square averaging over a time interval, as permitted under section 5.4(d), the attenuation required shall be 30 dB instead of 20 dB. Attenuation below the general field strength limits specified in RSS-Gen is not required

3.7.2 EUT Setup

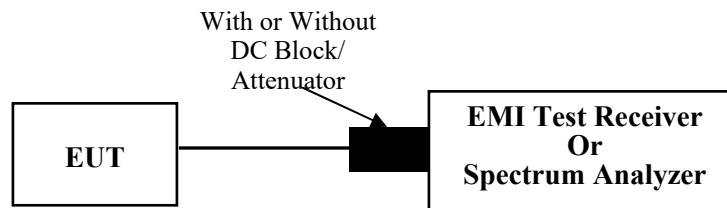

3.7.3 Test Procedure

According to ANSI C63.10-2013 Section 11.11

- a) Set the center frequency and span to encompass frequency range to be measured.
- b) Set the RBW = 100 kHz.
- c) Set the VBW $\geq [3 \times \text{RBW}]$.
- d) Detector = peak.
- e) Sweep time = auto couple.
- f) Trace mode = max hold.
- g) Allow trace to fully stabilize.
- h) Use the peak marker function to determine the maximum amplitude level.

Ensure that the amplitude of all unwanted emissions outside of the authorized frequency band (excluding restricted frequency bands) is attenuated by at least the minimum requirements specified in 11.11. Report the three highest emissions relative to the limit.

3.8 Duty Cycle:

3.8.1 EUT Setup

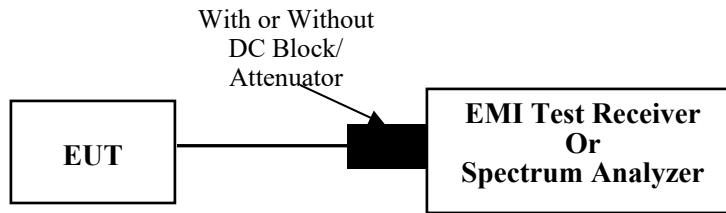

3.8.2 Test Procedure

According to ANSI C63.10-2013 Section 11.6

The zero-span mode on a spectrum analyzer or EMI receiver if the response time and spacing between bins on the sweep are sufficient to permit accurate measurements of the ON and OFF times of the transmitted signal:

- 1) Set the center frequency of the instrument to the center frequency of the transmission.
- 2) Set $RBW \geq OBW$ if possible; otherwise, set RBW to the largest available value.
- 3) Set $VBW \geq RBW$. Set detector = peak or average.
- 4) The zero-span measurement method shall not be used unless both RBW and VBW are $> 50/T$ and the number of sweep points across duration T exceeds 100. (For example, if VBW and/or RBW are limited to 3 MHz, then the zero-span method of measuring the duty cycle shall not be used if $T \leq 16.7 \mu s$.)

3.9 Antenna Requirement

3.9.1 Applicable Standard

FCC §15.203

An intentional radiator shall be designed to ensure that no antenna other than that furnished by the responsible party shall be used with the device. The use of a permanently attached antenna or of an antenna that uses a unique coupling to the intentional radiator shall be considered sufficient to comply with the provisions of this section. The manufacturer may design the unit so that a broken antenna can be replaced by the user, but the use of a standard antenna jack or electrical connector is prohibited. This requirement does not apply to carrier current devices or to devices operated under the provisions of §§15.211, 15.213, 15.217, 15.219, 15.221, or §15.236. Further, this requirement does not apply to intentional radiators that must be professionally installed, such as perimeter protection systems and some field disturbance sensors, or to other intentional radiators which, in accordance with §15.31(d), must be measured at the installation site. However, the installer shall be responsible for ensuring that the proper antenna is employed so that the limits in this part are not exceeded.

RSS-GEN Clause 6.8

The applicant for equipment certification shall provide a list of all antenna types that may be used with the transmitter, where applicable (i.e. for transmitters with detachable antenna), indicating the maximum permissible antenna gain (in dBi) and the required impedance for each antenna. The test report shall demonstrate the compliance of the transmitter with the limit for maximum equivalent isotropically radiated power (e.i.r.p.) specified in the applicable RSS, when the transmitter is equipped with any antenna type, selected from this list.

For expediting the testing, measurements may be performed using only the antenna with highest gain of each combination of transmitter and antenna type, with the transmitter output power set at the maximum level. However, the transmitter shall comply with the applicable requirements under all operational conditions and when in combination with any type of antenna from the list provided in the test report (and in the notice to be included in the user manual, provided below).

When measurements at the antenna port are used to determine the RF output power, the effective gain of the device's antenna shall be stated, based on a measurement or on data from the antenna's manufacturer.

The test report shall state the RF power, output power setting and spurious emission measurements with each antenna type that is used with the transmitter being tested.

For licence-exempt equipment with detachable antennas, the user manual shall also contain the following notice in a conspicuous location:

This radio transmitter [enter the device's ISED certification number] has been approved by Innovation, Science and Economic Development Canada to operate with the antenna types listed below, with the maximum permissible gain indicated. Antenna types not included in this list that have a gain greater than the maximum gain indicated for any type listed are strictly prohibited for use with this device.

Immediately following the above notice, the manufacturer shall provide a list of all antenna types which can be used with the transmitter, indicating the maximum permissible antenna gain (in dBi) and the required impedance for each antenna type.

3.9.2 Judgment

Compliant. Please refer to the Antenna Information detail in Section 1.

4. Test DATA AND RESULTS

4.1 AC Line Conducted Emissions

Serial Number:	2295	Test Date:	2023/03/09
Test Site:	CE	Test Mode:	Transmitting (802.11b middle channel was the worst)
Tester:	Bob Yang	Test Result:	Pass

Environmental Conditions:

Temperature: (°C)	23.5	Relative Humidity: (%)	60	ATM Pressure: (kPa)	101.8
----------------------	------	---------------------------	----	------------------------	-------

Test Equipment List and Details:

Manufacturer	Description	Model	Serial Number	Calibration Date	Calibration Due Date
R&S	LISN	ENV216	101134	2022/04/01	2023/03/31
R&S	EMI Test Receiver	ESR3	102726	2022/07/15	2023/07/14
MICRO-COAX	Coaxial Cable	UTIFLEX	C-0200-01	2022/08/07	2023/08/06
Audix	Test Software	E3	190306 (V9)	N/A	N/A

* Statement of Traceability: China Certification ICT Co., Ltd (Dongguan) attests that all calibrations have been performed, traceable to National Primary Standards and International System of Units (SI).

Test Data:

Test Mode: Transmitting
 Port: Line
 Note:

Date: 2023-03-09

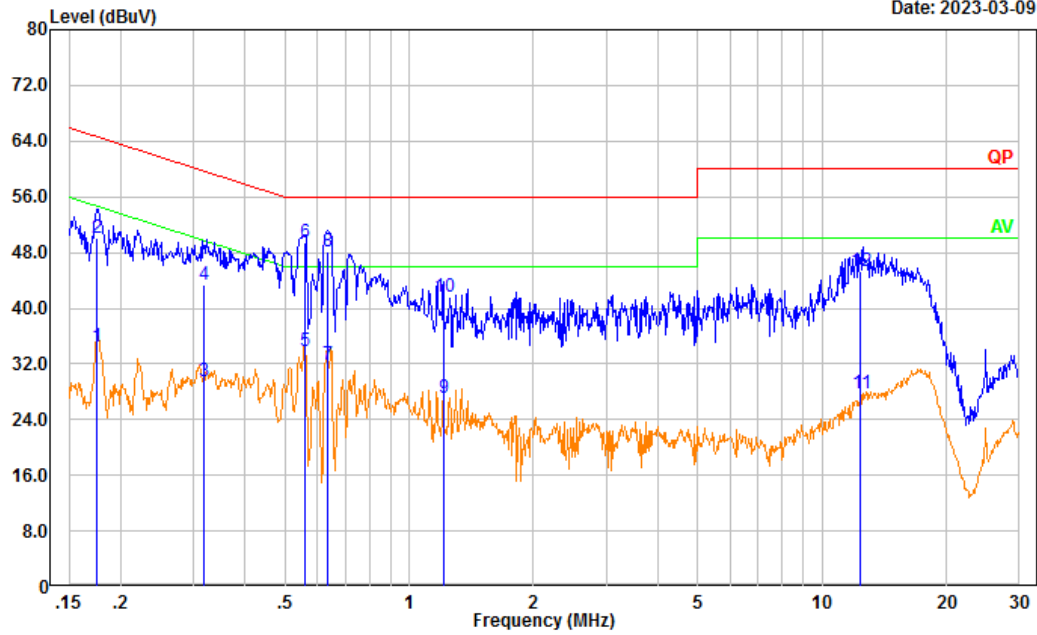

No.	Frequency (MHz)	Reading (dBμV)	Factor (dB)	Result (dBμV)	Limit (dBμV)	Margin (dB)	Detector
1	0.175	24.82	9.61	34.43	54.74	20.31	Average
2	0.175	40.46	9.61	50.07	64.74	14.67	QP
3	0.319	19.82	9.61	29.43	49.73	20.30	Average
4	0.319	33.64	9.61	43.25	59.73	16.48	QP
5	0.560	24.16	9.62	33.78	46.00	12.22	Average
6	0.560	39.79	9.62	49.41	56.00	6.59	QP
7	0.633	22.21	9.62	31.83	46.00	14.17	Average
8	0.633	38.54	9.62	48.16	56.00	7.84	QP
9	1.208	17.39	9.62	27.01	46.00	18.99	Average
10	1.208	31.99	9.62	41.61	56.00	14.39	QP
11	12.384	18.19	9.67	27.86	50.00	22.14	Average
12	12.384	35.54	9.67	45.21	60.00	14.79	QP

Test Mode: Transmitting
 Port: neutral
 Note:

Date: 2023-03-09

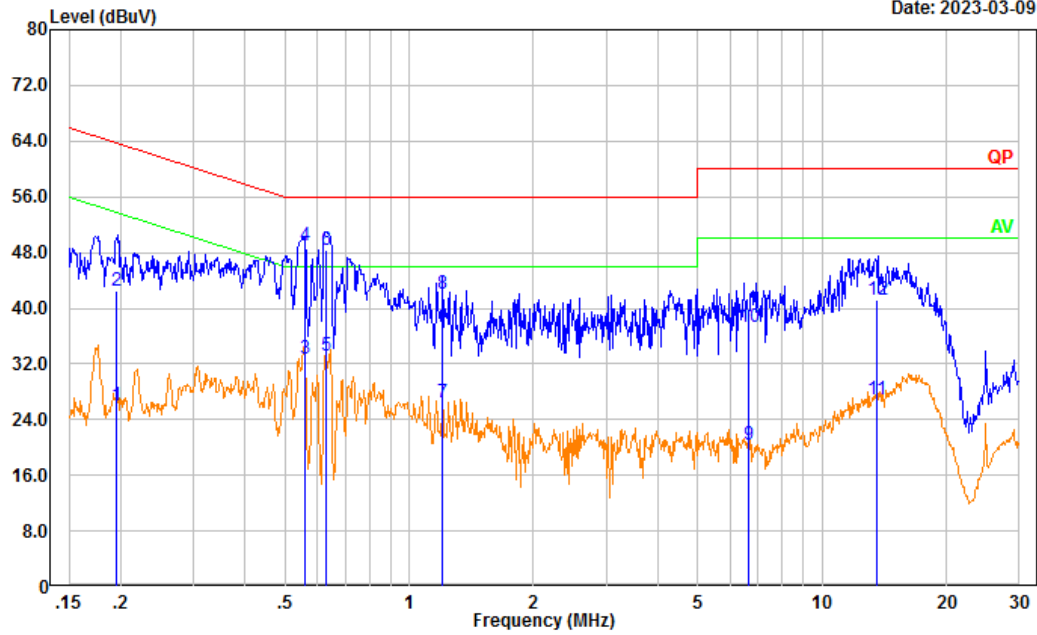

No.	Frequency (MHz)	Reading (dBμV)	Factor (dB)	Result (dBμV)	Limit (dBμV)	Margin (dB)	Detector
1	0.196	16.38	9.61	25.99	53.77	27.78	Average
2	0.196	32.82	9.61	42.43	63.77	21.34	QP
3	0.559	23.20	9.62	32.82	46.00	13.18	Average
4	0.559	39.42	9.62	49.04	56.00	6.96	QP
5	0.630	23.49	9.62	33.11	46.00	12.89	Average
6	0.630	38.66	9.62	48.28	56.00	7.72	QP
7	1.206	16.76	9.62	26.38	46.00	19.62	Average
8	1.206	32.38	9.62	42.00	56.00	14.00	QP
9	6.651	10.66	9.66	20.32	50.00	29.68	Average
10	6.651	27.59	9.66	37.25	60.00	22.75	QP
11	13.521	17.28	9.68	26.96	50.00	23.04	Average
12	13.521	31.46	9.68	41.14	60.00	18.86	QP

4.2 Radiation Spurious Emissions

Serial Number:	2295	Test Date:	2023/03/08 ~2023/03/11
Test Site:	966-1/966-2	Test Mode:	Transmitting
Tester:	Vic Du, Mack Huang	Test Result:	Pass

Environmental Conditions:

Temperature: (°C)	23.4~24.9	Relative Humidity: (%)	40~42	ATM Pressure: (kPa)	101.8~102
----------------------	-----------	---------------------------	-------	------------------------	-----------

Test Equipment List and Details:

Manufacturer	Description	Model	Serial Number	Calibration Date	Calibration Due Date
Sunol Sciences	Antenna	JB6	A082520-5	2020/10/19	2023/10/18
R&S	EMI Test Receiver	ESR3	102724	2022/07/15	2023/07/14
TIMES MICROWAVE	Coaxial Cable	LMR-600-UltraFlex	C-0470-02	2022/07/17	2023/07/16
TIMES MICROWAVE	Coaxial Cable	LMR-600-UltraFlex	C-0780-01	2022/07/17	2023/07/16
Sonoma	Amplifier	310N	186165	2022/07/17	2023/07/16
Audix	Test Software	E3	201021 (V9)	N/A	N/A
ETS-Lindgren	Horn Antenna	3115	9912-5985	2020/10/13	2023/10/12
R&S	Spectrum Analyzer	FSV40	101591	2022/07/15	2023/07/14
MICRO-COAX	Coaxial Cable	UFA210A-1-1200-70U300	217423-008	2022/08/07	2023/08/06
MICRO-COAX	Coaxial Cable	UFA210A-1-2362-300300	235780-001	2022/08/07	2023/08/06
Mini	Pre-amplifier	ZVA-183-S+	5969001149	2022/11/09	2023/11/08
PASTERNAK	Horn Antenna	PE9852/2F-20	112002	2021/02/05	2024/02/04
AH	Preamplifier	PAM-1840VH	190	2022/11/09	2023/11/08
MICRO-COAX	Coaxial Cable	UFB142A-1-2362-200200	235772-001	2022/08/07	2023/08/06
E-Microwave	Band Rejection Filter	2400-2483.5MHz	OE01902424	2022/08/07	2023/08/06
Mini Circuits	High Pass Filter	VHF-6010+	31119	2022/08/07	2023/08/06

* Statement of Traceability: China Certification ICT Co., Ltd (Dongguan) attests that all calibrations have been performed, traceable to National Primary Standards and International System of Units (SI).

Test Data:

Please refer to the below table and plots.

Note: The device can be mounted in multiple orientations, test was performed with X,Y, Z Axis according to C63.10 Figure 8, the worst orientation was photographed and it's data was recorded.

1) 30MHz-1GHz(802.11b mode middle channel was the worst)

Test Mode: Transmitting
 Polarization: vertical
 Note:

Date: 2023-03-08

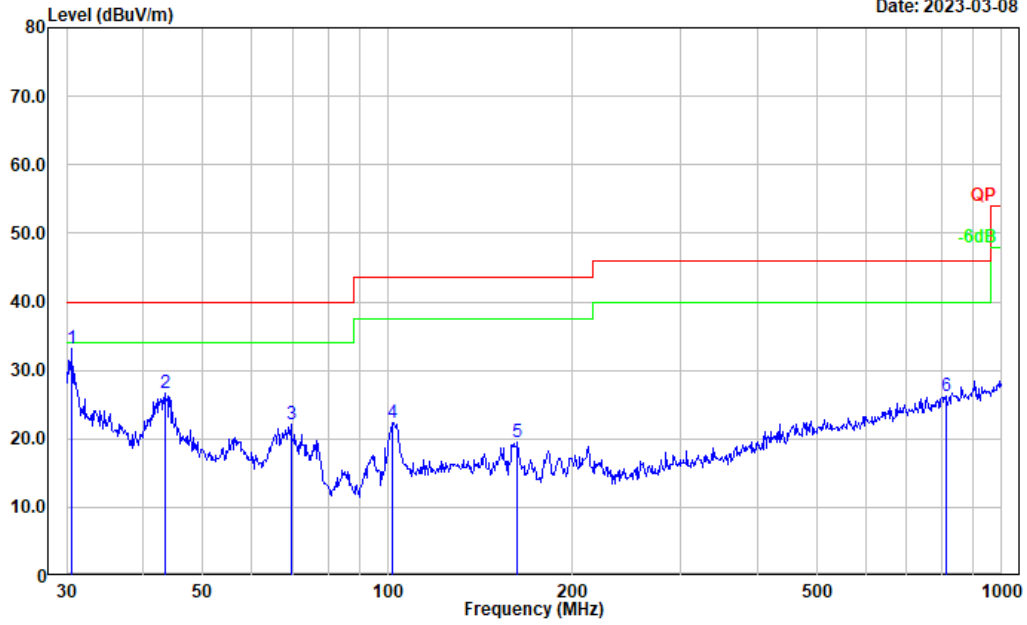

No.	Frequency (MHz)	Reading (dB μ V)	Factor (dB/m)	Result (dB μ V/m)	Limit (dB μ V/m)	Margin (dB)	Detector
1	30.638	37.22	-4.09	33.13	40.00	6.87	Peak
2	43.353	40.01	-13.29	26.72	40.00	13.28	Peak
3	69.600	38.68	-16.52	22.16	40.00	17.84	Peak
4	102.001	36.36	-13.97	22.39	43.50	21.11	Peak
5	162.611	31.83	-12.31	19.52	43.50	23.98	Peak
6	810.265	28.08	-1.94	26.14	46.00	19.86	Peak

Test Mode: Transmitting
 Polarization: horizontal
 Note:

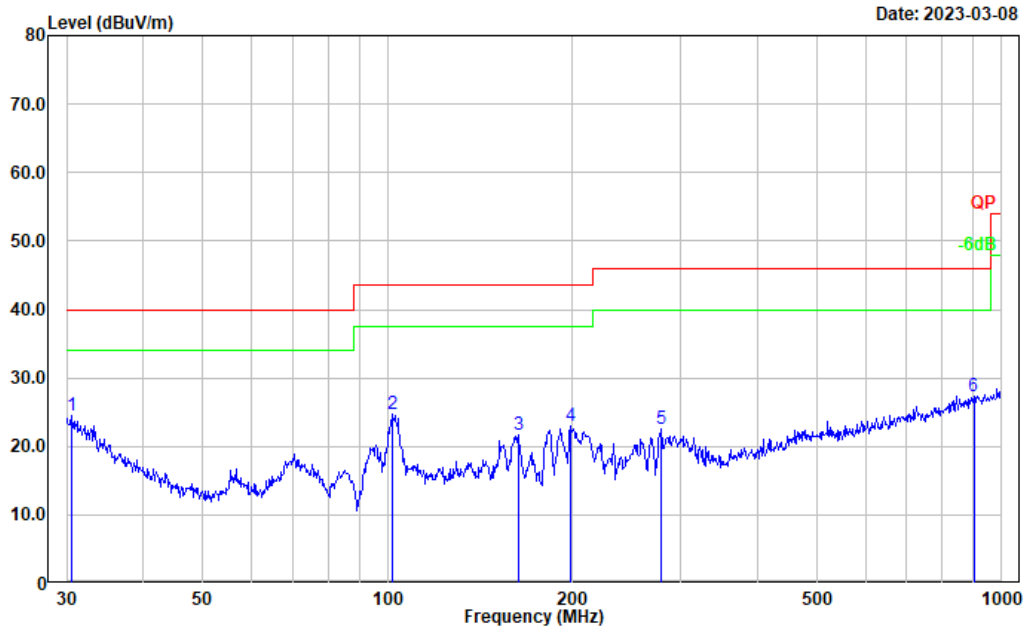

No.	Frequency (MHz)	Reading (dBμV)	Factor (dB/m)	Result (dBμV/m)	Limit (dBμV/m)	Margin (dB)	Detector
1	30.531	28.52	-4.00	24.52	40.00	15.48	Peak
2	102.001	38.65	-13.97	24.68	43.50	18.82	Peak
3	163.182	34.02	-12.35	21.67	43.50	21.83	Peak
4	198.588	35.37	-12.38	22.99	43.50	20.51	Peak
5	279.044	34.28	-11.71	22.57	46.00	23.43	Peak
6	900.147	28.37	-0.96	27.41	46.00	18.59	Peak

**2) 1-25GHz:
802.11b Mode:**

Frequency (MHz)	Receiver		Polar (H/V)	Factor (dB/m)	Result (dB μ V/m)	Limit (dB μ V/m)	Margin (dB)
	Reading (dB μ V)	Detector					
Low Channel: 2412 MHz							
2412.000	73.67	PK	H	31.53	105.20	N/A	N/A
2412.000	71.08	AV	H	31.53	102.61	N/A	N/A
2412.000	70.13	PK	V	31.53	101.66	N/A	N/A
2412.000	68.39	AV	V	31.53	99.92	N/A	N/A
2390.000	26.75	PK	H	31.46	58.21	74.00	15.79
2390.000	13.86	AV	H	31.46	45.32	54.00	8.68
4824.000	39.03	PK	H	10.94	49.97	74.00	24.03
4824.000	35.02	AV	H	10.94	45.96	54.00	8.04
7236.000	35.16	PK	H	14.44	49.60	74.00	24.40
7236.000	23.08	AV	H	14.44	37.52	54.00	16.48
Middle Channel: 2437 MHz							
2437.000	73.47	PK	H	31.60	105.07	N/A	N/A
2437.000	71.26	AV	H	31.60	102.86	N/A	N/A
2437.000	71.13	PK	V	31.60	102.73	N/A	N/A
2437.000	69.27	AV	V	31.60	100.87	N/A	N/A
4874.000	45.20	PK	H	11.05	56.25	74.00	17.75
4874.000	41.23	AV	H	11.05	52.28	54.00	1.72
7311.000	34.21	PK	H	14.80	49.01	74.00	24.99
7311.000	22.11	AV	H	14.80	36.91	54.00	17.09
High Channel: 2462MHz							
2462.000	73.26	PK	H	31.63	104.89	N/A	N/A
2462.000	70.67	AV	H	31.63	102.30	N/A	N/A
2462.000	71.34	PK	V	31.63	102.97	N/A	N/A
2462.000	68.42	AV	V	31.63	100.05	N/A	N/A
2483.500	27.03	PK	H	31.64	58.67	74.00	15.33
2483.500	14.33	AV	H	31.64	45.97	54.00	8.03
4924.000	39.19	PK	H	11.18	50.37	74.00	23.63
4924.000	35.10	AV	H	11.18	46.28	54.00	7.72
7386.000	33.77	PK	H	14.89	48.66	74.00	25.34
7386.000	21.39	AV	H	14.89	36.28	54.00	17.72

802.11g Mode:

Frequency (MHz)	Receiver		Polar (H/V)	Factor (dB/m)	Result (dB μ V/m)	Limit (dB μ V/m)	Margin (dB)
	Reading (dB μ V)	Detector					
Low Channel: 2412 MHz							
2412.000	76.58	PK	H	31.53	108.11	N/A	N/A
2412.000	67.20	AV	H	31.53	98.73	N/A	N/A
2412.000	74.11	PK	V	31.53	105.64	N/A	N/A
2412.000	65.03	AV	V	31.53	96.56	N/A	N/A
2390.000	32.39	PK	H	31.46	63.85	74.00	10.15
2390.000	14.37	AV	H	31.46	45.83	54.00	8.17
4824.000	35.44	PK	H	10.94	46.38	74.00	27.62
4824.000	23.22	AV	H	10.94	34.16	54.00	19.84
7236.000	35.09	PK	H	14.44	49.53	74.00	24.47
7236.000	23.05	AV	H	14.44	37.49	54.00	16.51
Middle Channel: 2437 MHz							
2437.000	75.12	PK	H	31.60	106.72	N/A	N/A
2437.000	65.39	AV	H	31.60	96.99	N/A	N/A
2437.000	72.24	PK	V	31.60	103.84	N/A	N/A
2437.000	62.31	AV	V	31.60	93.91	N/A	N/A
4874.000	39.30	PK	H	11.05	50.35	74.00	23.65
4874.000	27.15	AV	H	11.05	38.20	54.00	15.80
7311.000	35.24	PK	H	14.80	50.04	74.00	23.96
7311.000	23.12	AV	H	14.80	37.92	54.00	16.08
High Channel: 2462MHz							
2462.000	76.70	PK	H	31.63	108.33	N/A	N/A
2462.000	66.82	AV	H	31.63	98.45	N/A	N/A
2462.000	73.94	PK	V	31.63	105.57	N/A	N/A
2462.000	63.18	AV	V	31.63	94.81	N/A	N/A
2483.500	39.71	PK	H	31.64	71.35	74.00	2.65
2483.500	19.16	AV	H	31.64	50.80	54.00	3.20
4924.000	35.78	PK	H	11.18	46.96	74.00	27.04
4924.000	23.39	AV	H	11.18	34.57	54.00	19.43
7386.000	33.77	PK	H	14.89	48.66	74.00	25.34
7386.000	21.39	AV	H	14.89	36.28	54.00	17.72

802.11n ht20 Mode:

Frequency (MHz)	Receiver		Polar (H/V)	Factor (dB/m)	Result (dB μ V/m)	Limit (dB μ V/m)	Margin (dB)
	Reading (dB μ V)	Detector					
Low Channel: 2412 MHz							
2412.000	76.87	PK	H	31.53	108.40	N/A	N/A
2412.000	66.90	AV	H	31.53	98.43	N/A	N/A
2412.000	73.12	PK	V	31.53	104.65	N/A	N/A
2412.000	63.25	AV	V	31.53	94.78	N/A	N/A
2390.000	33.73	PK	H	31.46	65.19	74.00	8.81
2390.000	14.78	AV	H	31.46	46.24	54.00	7.76
4824.000	36.74	PK	H	10.94	47.68	74.00	26.32
4824.000	24.37	AV	H	10.94	35.31	54.00	18.69
7236.000	34.83	PK	H	14.44	49.27	74.00	24.73
7236.000	22.42	AV	H	14.44	36.86	54.00	17.14
Middle Channel: 2437 MHz							
2437.000	76.58	PK	H	31.60	108.18	N/A	N/A
2437.000	66.43	AV	H	31.60	98.03	N/A	N/A
2437.000	74.13	PK	V	31.60	105.73	N/A	N/A
2437.000	64.58	AV	V	31.60	96.18	N/A	N/A
4874.000	37.42	PK	H	11.05	48.47	74.00	25.53
4874.000	25.21	AV	H	11.05	36.26	54.00	17.74
7311.000	34.25	PK	H	14.80	49.05	74.00	24.95
7311.000	22.13	AV	H	14.80	36.93	54.00	17.07
High Channel: 2462MHz							
2462.000	75.82	PK	H	31.63	107.45	N/A	N/A
2462.000	65.66	AV	H	31.63	97.29	N/A	N/A
2462.000	73.27	PK	V	31.63	104.90	N/A	N/A
2462.000	63.40	AV	V	31.63	95.03	N/A	N/A
2483.500	39.82	PK	H	31.64	71.46	74.00	2.54
2483.500	17.84	AV	H	31.64	49.48	54.00	4.52
4924.000	35.09	PK	H	11.18	46.27	74.00	27.73
4924.000	23.05	AV	H	11.18	34.23	54.00	19.77
7386.000	34.17	PK	H	14.89	49.06	74.00	24.94
7386.000	22.09	AV	H	14.89	36.98	54.00	17.02

802.11n ht40 Mode:

Frequency (MHz)	Receiver		Polar (H/V)	Factor (dB/m)	Result (dB μ V/m)	Limit (dB μ V/m)	Margin (dB)
	Reading (dB μ V)	Detector					
Low Channel: 2422 MHz							
2422.000	75.26	PK	H	31.56	106.82	N/A	N/A
2422.000	64.76	AV	H	31.56	96.32	N/A	N/A
2422.000	72.22	PK	V	31.56	103.78	N/A	N/A
2422.000	61.09	AV	V	31.56	92.65	N/A	N/A
2390.000	38.45	PK	H	31.46	69.91	74.00	4.09
2390.000	19.66	AV	H	31.46	51.12	54.00	2.88
4844.000	34.19	PK	H	10.96	45.15	74.00	28.85
4844.000	22.10	AV	H	10.96	33.06	54.00	20.94
7266.000	34.70	PK	H	14.63	49.33	74.00	24.67
7266.000	22.35	AV	H	14.63	36.98	54.00	17.02
Middle Channel: 2437 MHz							
2437.000	76.03	PK	H	31.60	107.63	N/A	N/A
2437.000	65.27	AV	H	31.60	96.87	N/A	N/A
2437.000	73.45	PK	V	31.60	105.05	N/A	N/A
2437.000	62.18	AV	V	31.60	93.78	N/A	N/A
4874.000	35.14	PK	H	11.05	46.19	74.00	27.81
4874.000	23.07	AV	H	11.05	34.12	54.00	19.88
7311.000	34.40	PK	H	14.80	49.20	74.00	24.80
7311.000	22.20	AV	H	14.80	37.00	54.00	17.00
High Channel: 2452MHz							
2452.000	75.10	PK	H	31.63	106.73	N/A	N/A
2452.000	64.83	AV	H	31.63	96.46	N/A	N/A
2452.000	72.48	PK	V	31.63	104.11	N/A	N/A
2452.000	61.37	AV	V	31.63	93.00	N/A	N/A
2483.500	40.03	PK	H	31.64	71.67	74.00	2.33
2483.500	20.75	AV	H	31.64	52.39	54.00	1.61
4904.000	35.30	PK	H	11.14	46.44	74.00	27.56
4904.000	23.15	AV	H	11.14	34.29	54.00	19.71
7356.000	33.97	PK	H	14.80	48.77	74.00	25.23
7356.000	21.49	AV	H	14.80	36.29	54.00	17.71

Worst Test plots(802.11b middle channel was the worst)

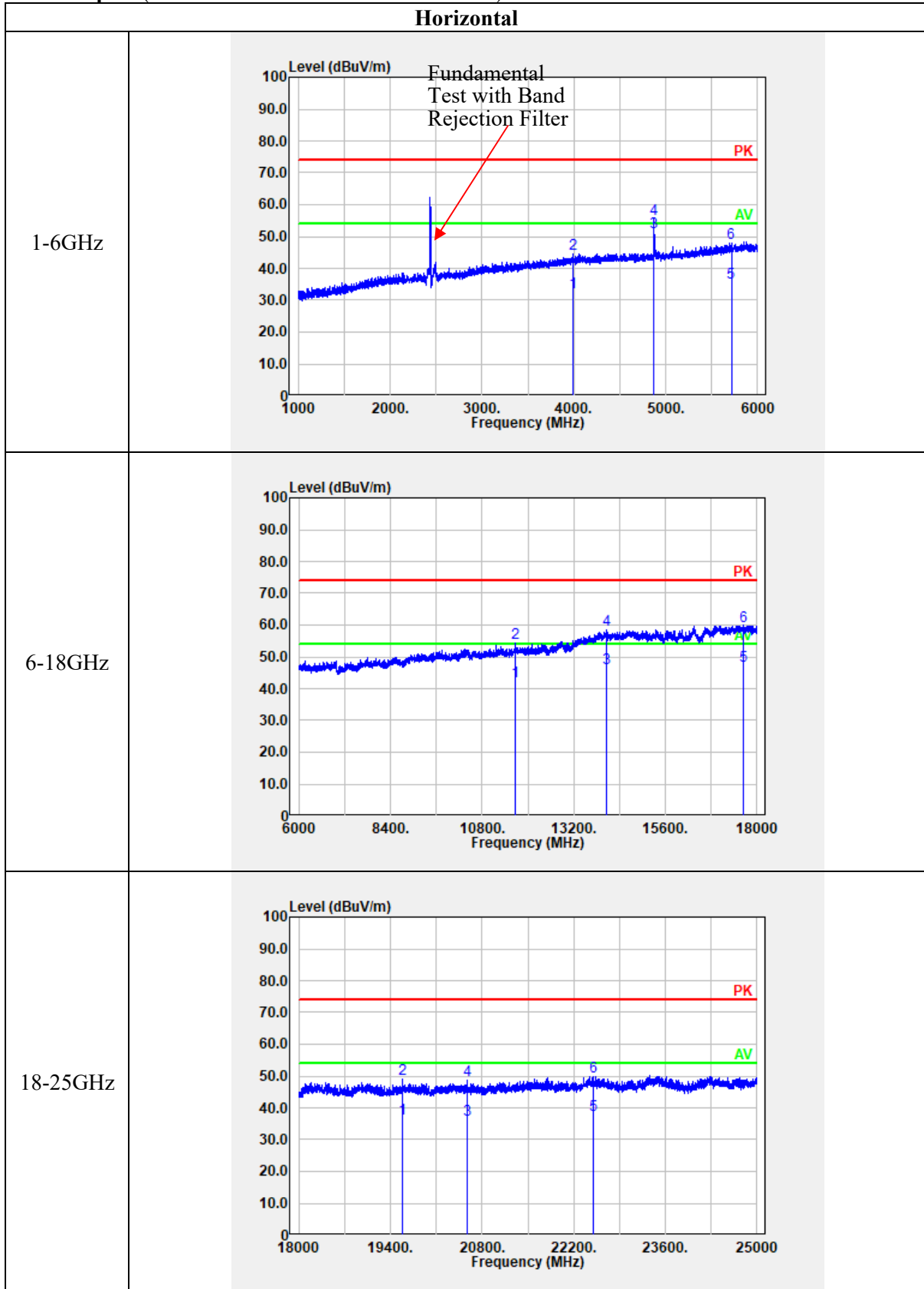

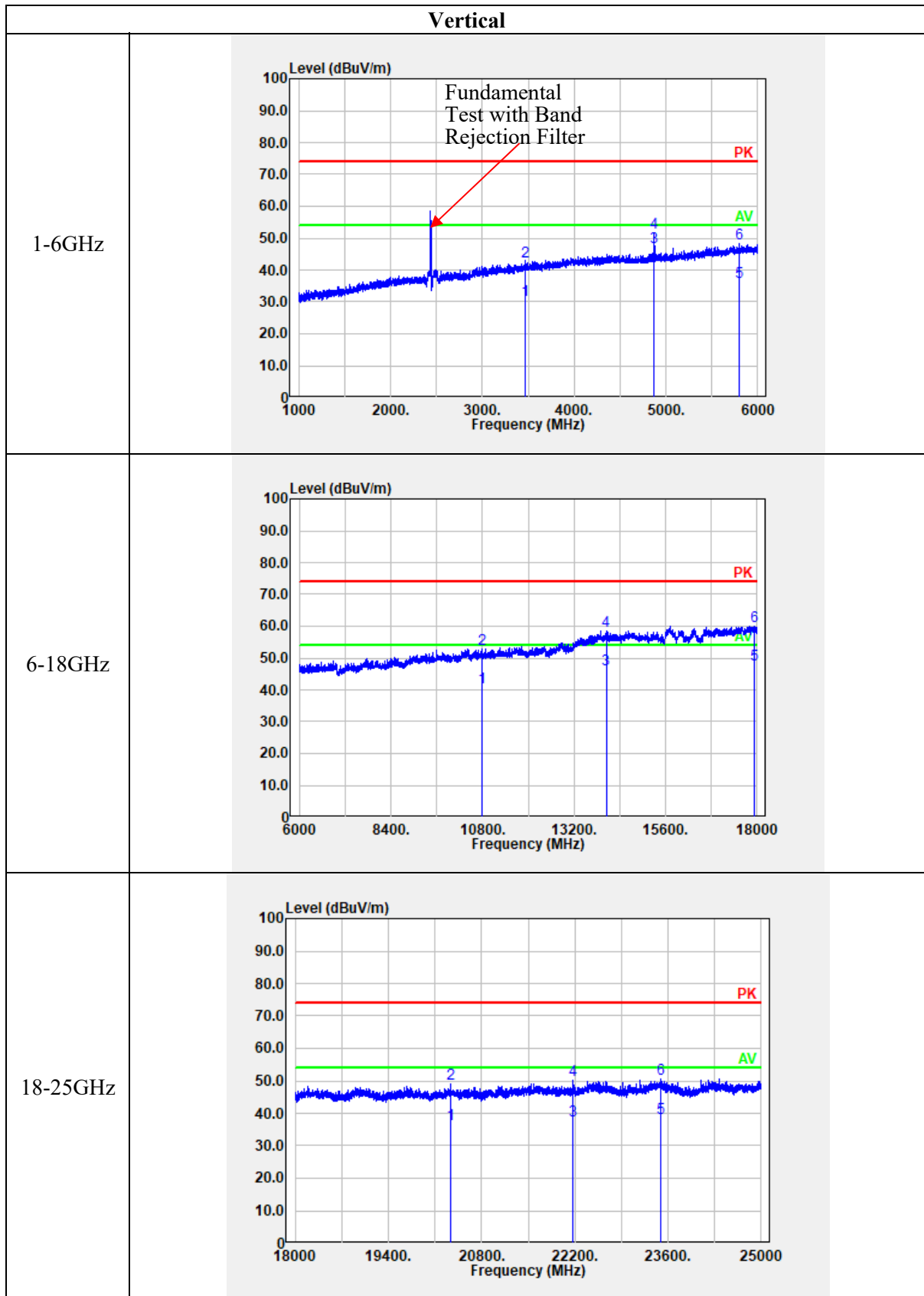

4.3 Minimum 6 dB Bandwidth:

Serial Number:	2295	Test Date:	2023/02/25
Test Site:	RF	Test Mode:	Transmitting
Tester:	Julie Tan	Test Result:	Pass

Environmental Conditions:

Temperature: (°C)	25.3	Relative Humidity: (%)	33	ATM Pressure: (kPa)	101.2
----------------------	------	------------------------------	----	------------------------	-------

Test Equipment List and Details:

Manufacturer	Description	Model	Serial Number	Calibration Date	Calibration Due Date
R&S	Spectrum Analyzer	FSV40	101943	2022/07/25	2023/07/24
HuiXunDa	DC Block	SMA-JK 18G	DCB181108043	Each time	N/A
zhuoxiang	Coaxial Cable	SMA-178	211001	Each time	N/A

* Statement of Traceability: China Certification ICT Co., Ltd (Dongguan) attests that all calibrations have been performed, traceable to National Primary Standards and International System of Units (SI).

Test Data:

Test Modes	Test Frequency (MHz)	6 dB Bandwidth (MHz)	Limit (MHz)
802.11b	2412	7.04	0.5
	2437	8.56	0.5
	2462	6.64	0.5
802.11g	2412	12.56	0.5
	2437	16.27	0.5
	2462	10.11	0.5
802.11n ht20	2412	11.36	0.5
	2437	17.49	0.5
	2462	10.1	0.5
802.11n ht40	2422	17.44	0.5
	2437	36.76	0.5
	2452	16.16	0.5

Minimum 6dB Emission Bandwidth

802.11b
Lowest Channel

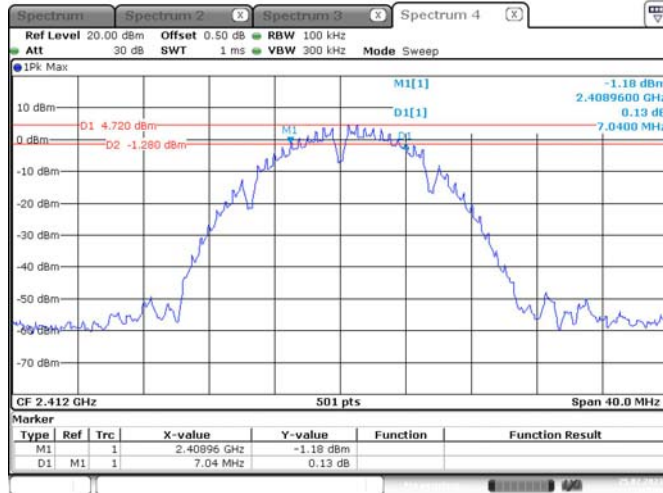

Date: 25.FEB.2023 15:58:30

802.11b
Middle Channel

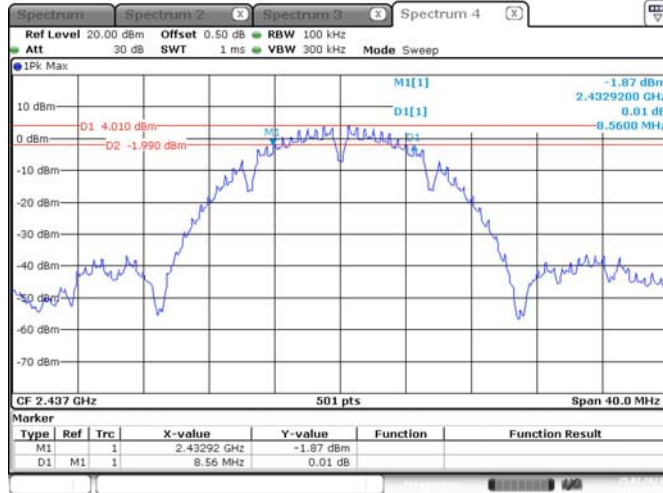

Date: 25.FEB.2023 15:59:56

802.11b
Highest Channel

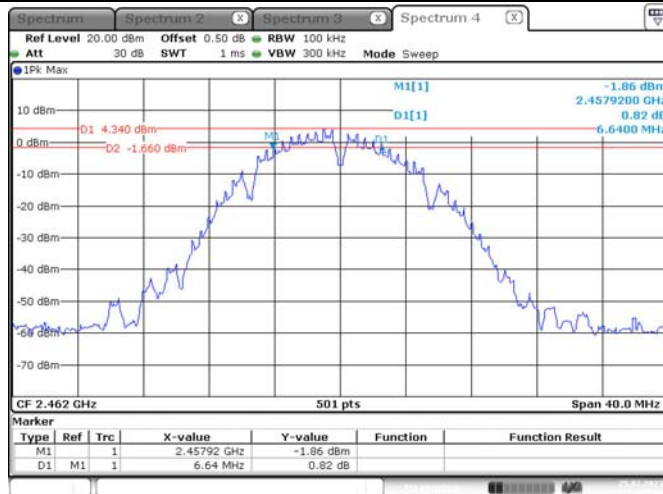

Date: 25.FEB.2023 16:00:35

Minimum 6dB Emission Bandwidth

802.11g
Lowest Channel

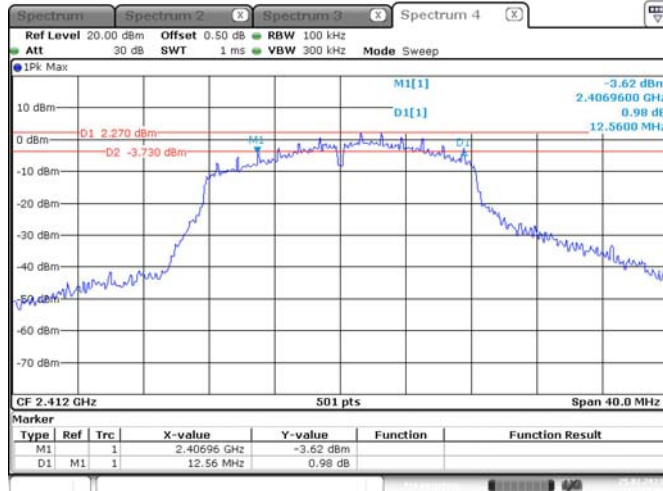

Date: 25.FEB.2023 16:02:40

802.11g
Middle Channel

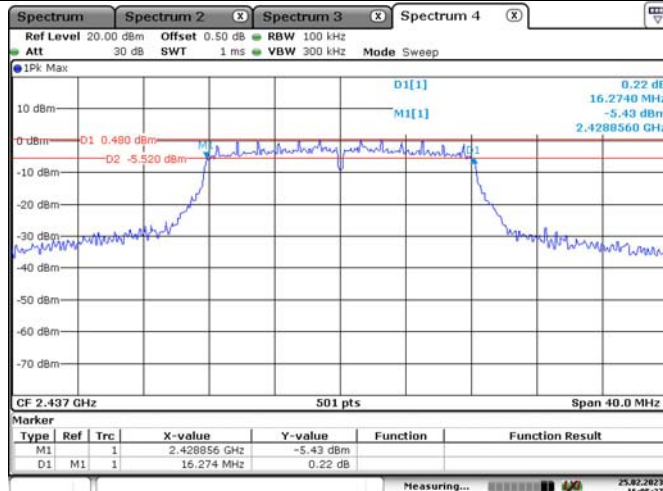

Date: 25.FEB.2023 16:05:28

802.11g
Highest Channel

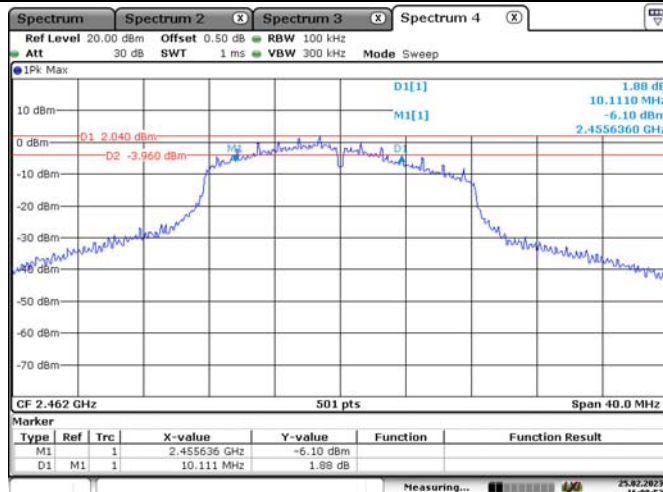

Date: 25.FEB.2023 16:08:54

Minimum 6dB Emission Bandwidth

802.11n ht20
Lowest Channel

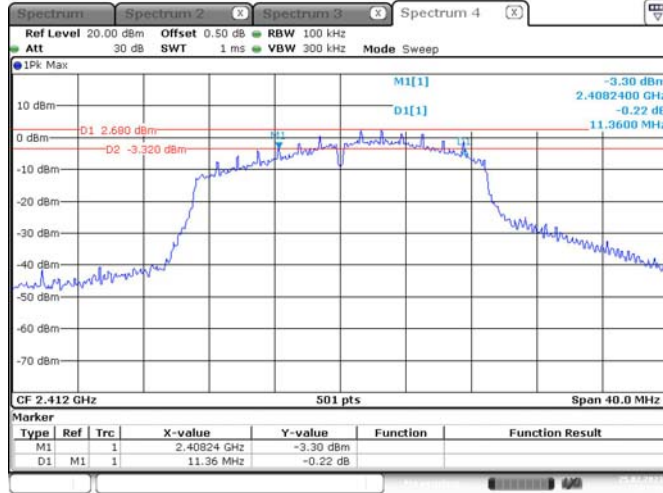

Date: 25.FEB.2023 17:01:18

802.11n ht20
Middle Channel

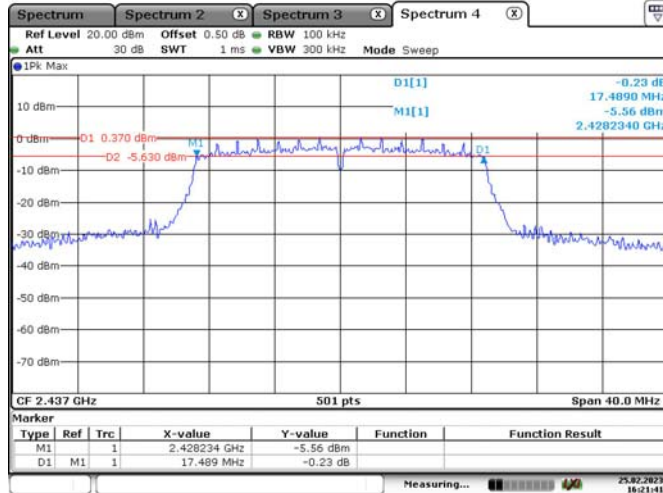

Date: 25.FEB.2023 16:21:41

802.11n ht20
Highest Channel

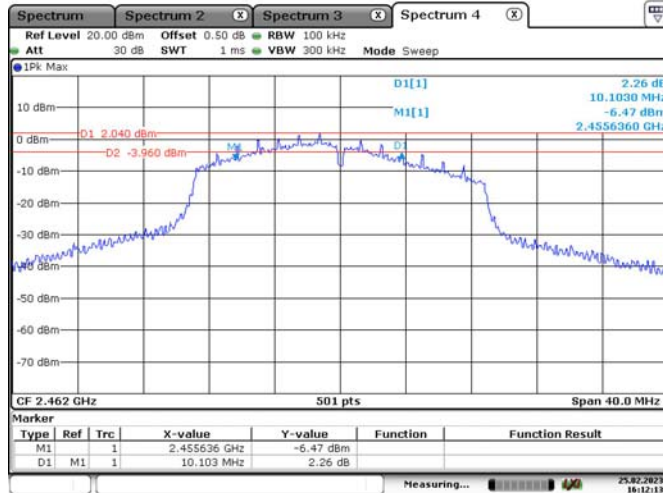

Date: 25.FEB.2023 16:12:13

Minimum 6dB Emission Bandwidth

802.11n ht40
Lowest Channel

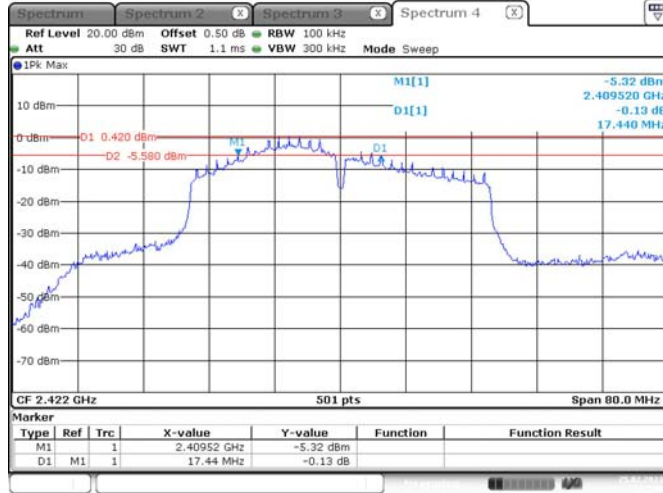

Date: 25.FEB.2023 17:02:51

802.11n ht40
Middle Channel

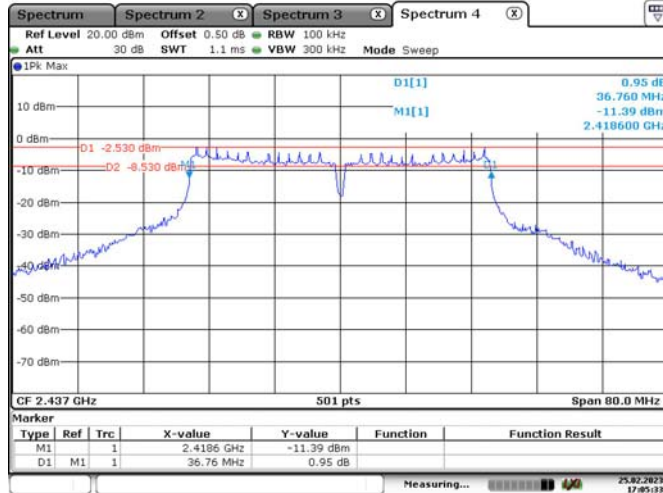

Date: 25.FEB.2023 17:05:33

802.11n ht40
Highest Channel

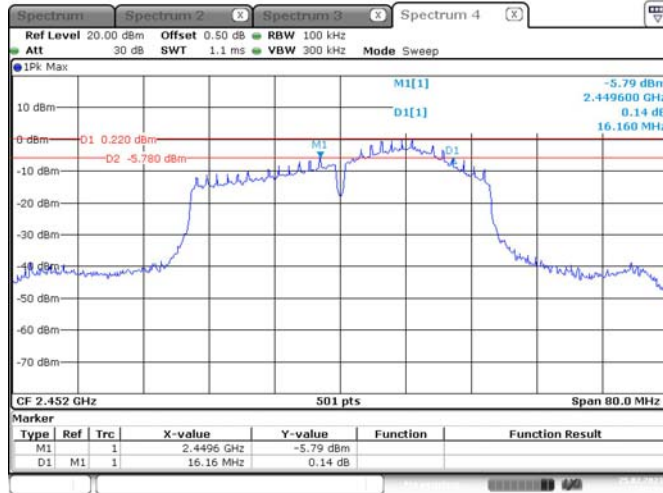

Date: 25.FEB.2023 17:06:13

4.4 99% Occupied Bandwidth:

Serial Number:	2295	Test Date:	2023/02/25
Test Site:	RF	Test Mode:	Transmitting
Tester:	Julie Tan	Test Result:	N/A

Environmental Conditions:

Temperature: (°C)	25.3	Relative Humidity: (%)	33	ATM Pressure: (kPa)	101.2
----------------------	------	------------------------------	----	------------------------	-------

Test Equipment List and Details:

Manufacturer	Description	Model	Serial Number	Calibration Date	Calibration Due Date
R&S	Spectrum Analyzer	FSV40	101943	2022/07/25	2023/07/24
HuiXunDa	DC Block	SMA-JK 18G	DCB181108043	Each time	N/A
zhuoxiang	Coaxial Cable	SMA-178	211001	Each time	N/A

* Statement of Traceability: China Certification ICT Co., Ltd (Dongguan) attests that all calibrations have been performed, traceable to National Primary Standards and International System of Units (SI).

Test Data:

Test Modes	Test Channel	Test Frequency (MHz)	99% Occupied Bandwidth (MHz)
802.11b	Lowest	2412	11.497
	Middle	2437	13.333
	Highest	2462	11.816
802.11g	Lowest	2412	16.287
	Middle	2437	17.325
	Highest	2462	16.208
802.11n ht20	Lowest	2412	17.325
	Middle	2437	18.204
	Highest	2462	17.246
802.11n ht40	Lowest	2422	35.609
	Middle	2437	38.962
	Highest	2452	35.289

99% Occupied Bandwidth

802.11b
Lowest Channel

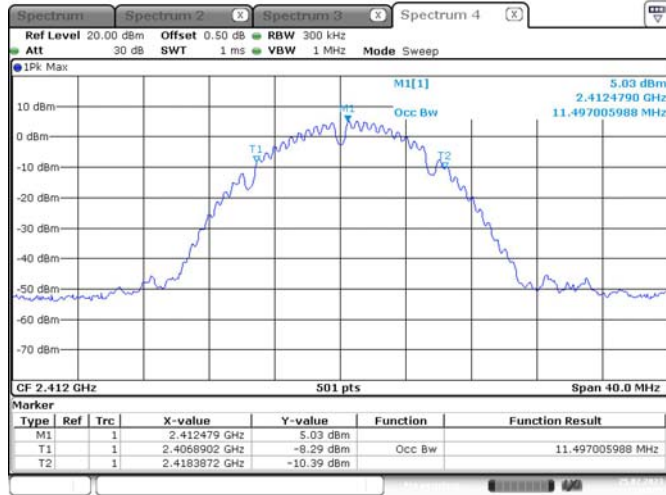

Date: 25.FEB.2023 15:58:47

802.11b
Middle Channel

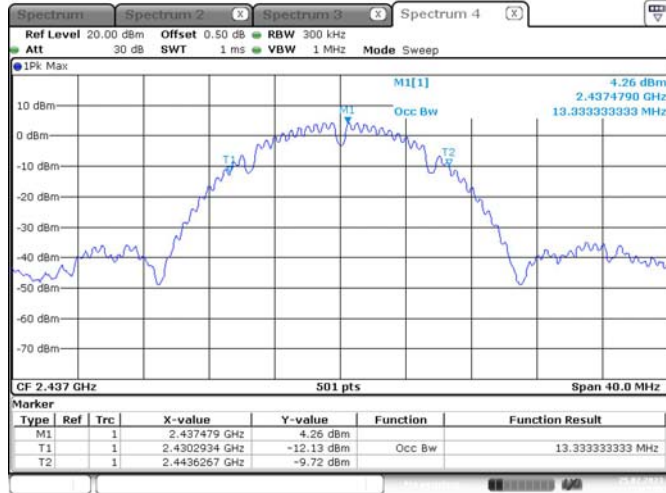

Date: 25.FEB.2023 15:59:31

802.11b
Highest Channel

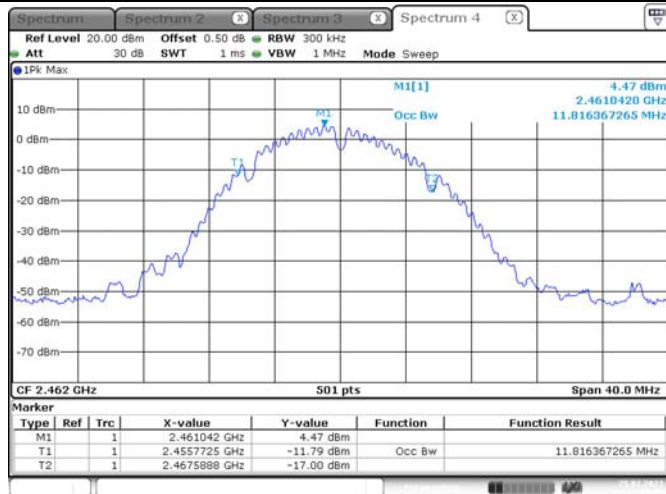

Date: 25.FEB.2023 16:00:45

99% Occupied Bandwidth

802.11g
Lowest Channel



Date: 25.FEB.2023 16:02:03

802.11g
Middle Channel

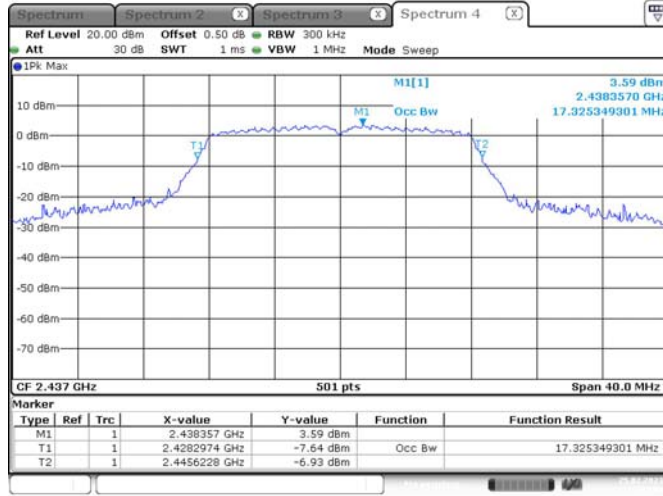

Date: 25.FEB.2023 16:03:54

802.11g
Highest Channel

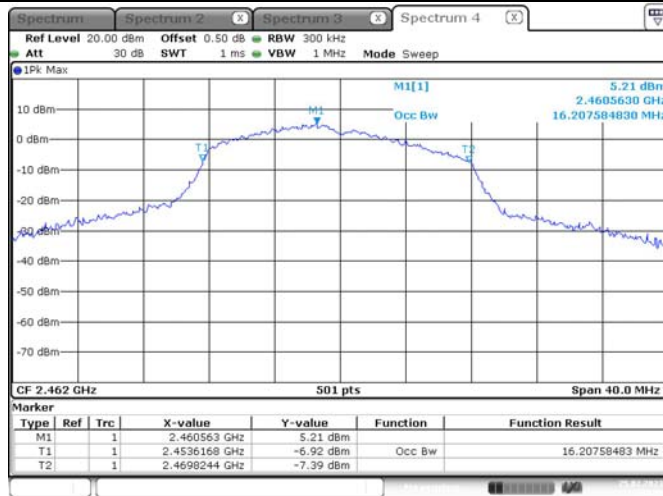

Date: 25.FEB.2023 16:06:43

99% Occupied Bandwidth

802.11n ht20
Lowest Channel



Date: 25.FEB.2023 17:01:45

802.11n ht20
Middle Channel

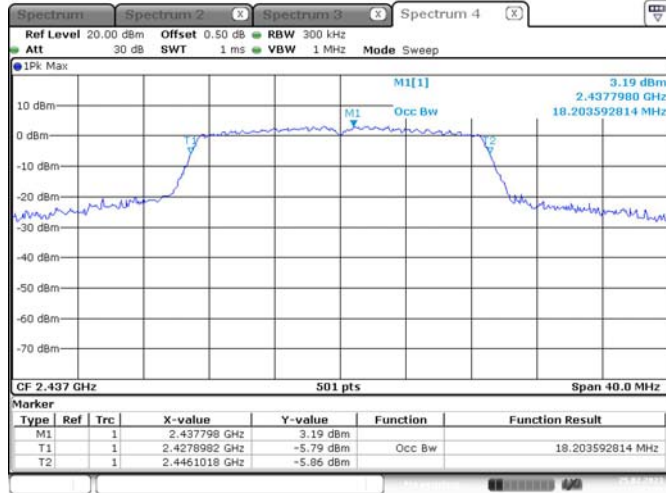

Date: 25.FEB.2023 16:13:30

802.11n ht20
Highest Channel



Date: 25.FEB.2023 16:10:21

99% Occupied Bandwidth

802.11n ht40
Lowest Channel

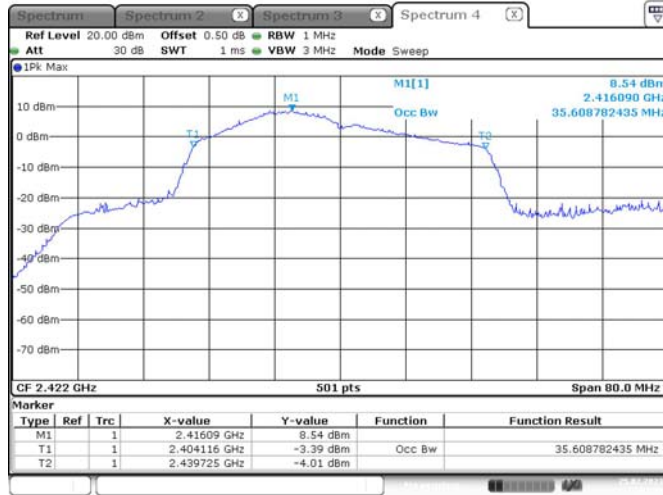

Date: 25.FEB.2023 17:03:11

802.11n ht40
Middle Channel



Date: 25.FEB.2023 17:04:06

802.11n ht40
Highest Channel



Date: 25.FEB.2023 17:06:36

4.5 Maximum Conducted Output Power:

Serial Number:	2295	Test Date:	2023/02/25
Test Site:	RF	Test Mode:	Transmitting
Tester:	Julie Tan	Test Result:	Pass

Environmental Conditions:

Temperature: (°C)	25.3	Relative Humidity: (%)	33	ATM Pressure: (kPa)	101.2
----------------------	------	---------------------------	----	------------------------	-------

Test Equipment List and Details:

Manufacturer	Description	Model	Serial Number	Calibration Date	Calibration Due Date
Agilent	USB Wideband Power Sensor	U2021XA	MY54080015	2022/07/15	2023/07/14
eastsheep	Coaxial Attenuator	2W-SMA-JK-18G	21060301	Each time	N/A
zhuoxiang	Coaxial Cable	SMA-178	211001	Each time	N/A

* Statement of Traceability: China Certification ICT Co., Ltd (Dongguan) attests that all calibrations have been performed, traceable to National Primary Standards and International System of Units (SI).

Test Data:

Test Modes	Test Frequency (MHz)	Maximum Conducted Average Output Power (dBm)	Limit (dBm)
802.11b	2412	12.98	30
	2437	13.08	30
	2462	12.47	30
802.11g	2412	11.75	30
	2437	12.21	30
	2462	11.52	30
802.11n ht20	2412	11.56	30
	2437	11.93	30
	2462	11.39	30
802.11n ht40	2422	11.02	30
	2437	10.77	30
	2452	10.83	30
Antenna Gain(dBi):	0.97	Max.EIRP(dBm):	14.05
EIRP Limit for RSS-247:36 dBm			

4.6 Maximum Power Spectral Density:

Serial Number:	2295	Test Date:	2023/02/25
Test Site:	RF	Test Mode:	Transmitting
Tester:	Julie Tan	Test Result:	Pass

Environmental Conditions:

Temperature: (°C)	25.3	Relative Humidity: (%)	33	ATM Pressure: (kPa)	101.2
----------------------	------	------------------------------	----	------------------------	-------

Test Equipment List and Details:

Manufacturer	Description	Model	Serial Number	Calibration Date	Calibration Due Date
R&S	Spectrum Analyzer	FSV40	101943	2022/07/25	2023/07/24
HuiXunDa	DC Block	SMA-JK 18G	DCB181108043	Each time	N/A
zhuoxiang	Coaxial Cable	SMA-178	211001	Each time	N/A

* Statement of Traceability: China Certification ICT Co., Ltd (Dongguan) attests that all calibrations have been performed, traceable to National Primary Standards and International System of Units (SI).

Test Data:

Test Channel	Test Frequency (MHz)	Reading (dBm/10kHz)	Duty Cycle Factor (dBm/10kHz)	Power Spectral Density (dBm/10kHz)	Limit (dBm/3kHz)
802.11b	2412	-13.15	/	-13.15	8.00
	2437	-13.96	/	-13.96	8.00
	2462	-13.91	/	-13.91	8.00
802.11g	2412	-16.14	/	-16.14	8.00
	2437	-17.18	/	-17.18	8.00
	2462	-16.08	/	-16.08	8.00
802.11n ht20	2412	-16.12	/	-16.12	8.00
	2437	-16.96	/	-16.96	8.00
	2462	-15.7	/	-15.7	8.00
802.11n ht40	2422	-10.79	/	-10.79	8.00
	2437	-12.77	/	-12.77	8.00
	2452	-11.21	/	-11.21	8.00

Maximum power spectral density

802.11b
Lowest Channel



802.11b
Middle Channel

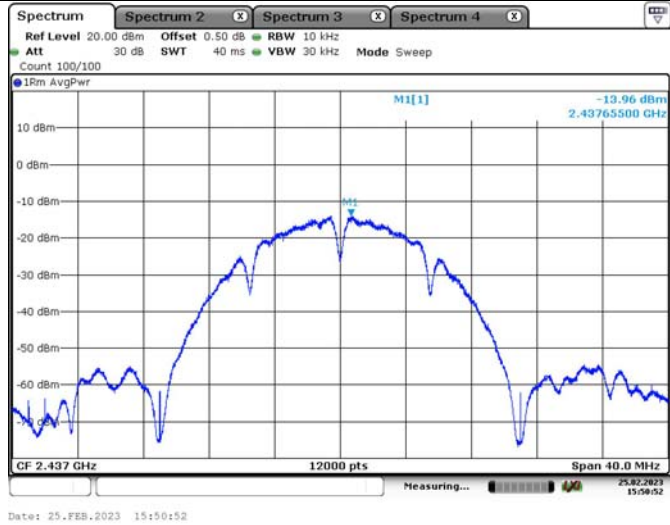

802.11b
Highest Channel



Maximum power spectral density

802.11g
Lowest Channel

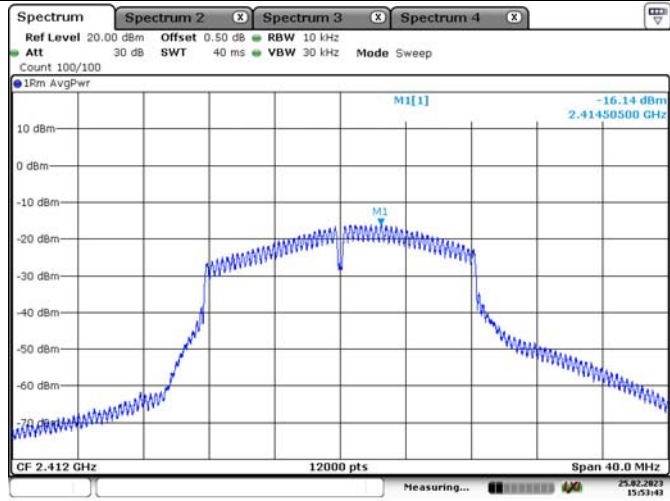

Date: 25.FEB.2023 15:53:44

802.11g
Middle Channel

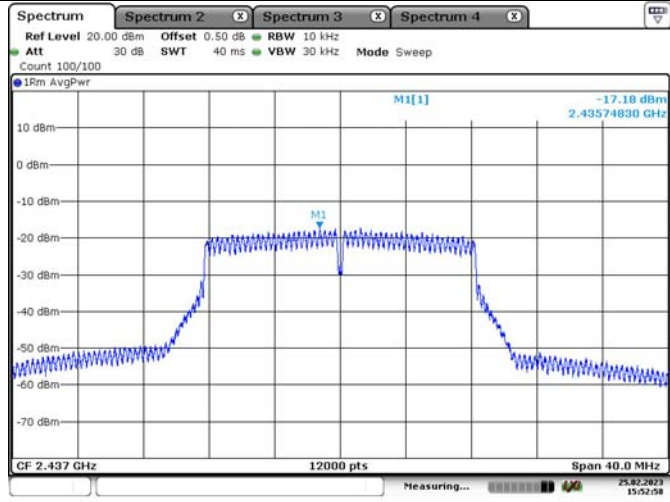

Date: 25.FEB.2023 15:52:58

802.11g
Highest Channel

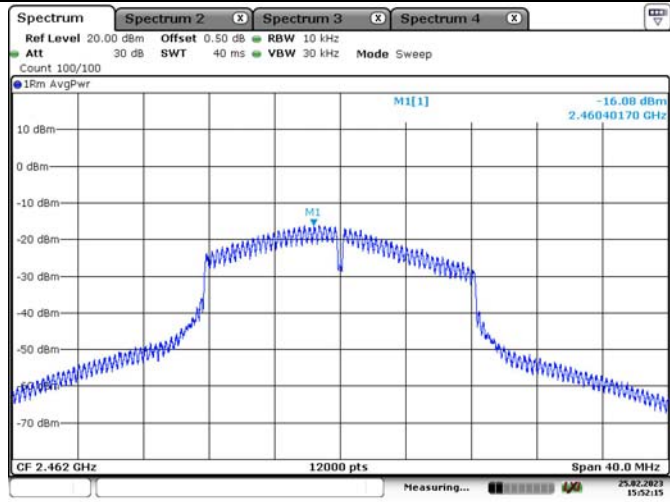

Date: 25.FEB.2023 15:52:15

Maximum power spectral density

802.11n ht20
Lowest Channel

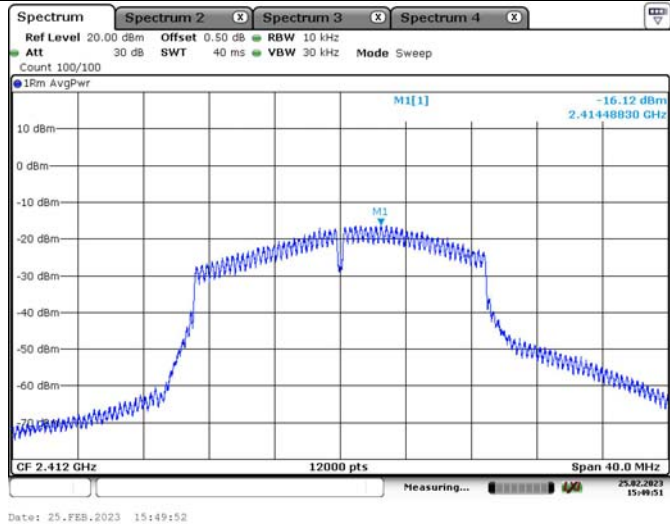

802.11n ht20
Middle Channel

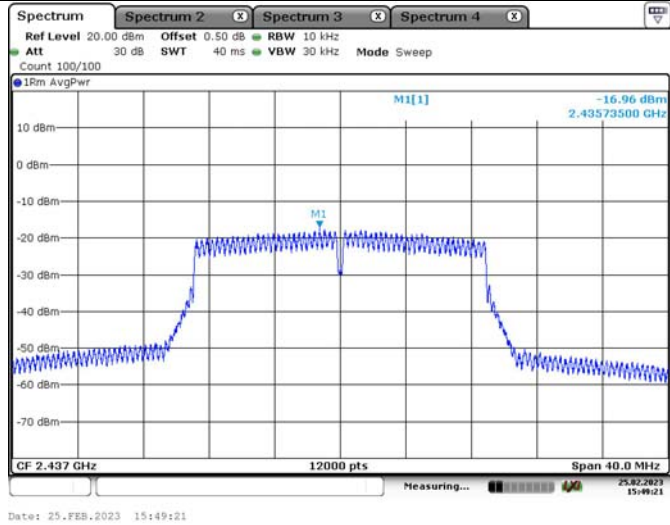

802.11n ht20
Highest Channel

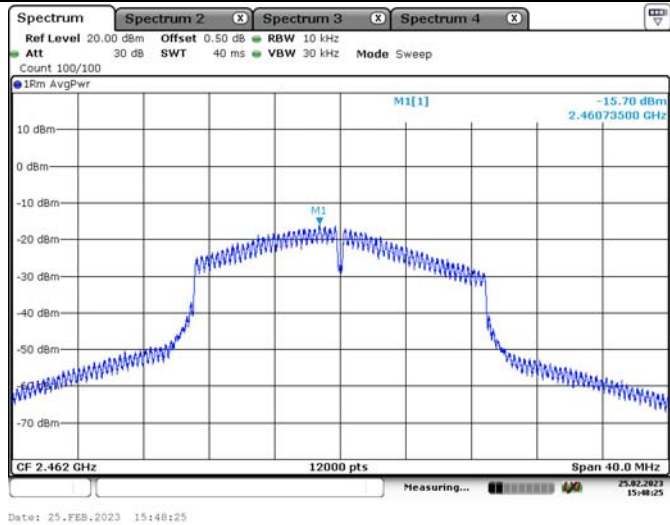

Maximum power spectral density

802.11n ht40
Lowest Channel

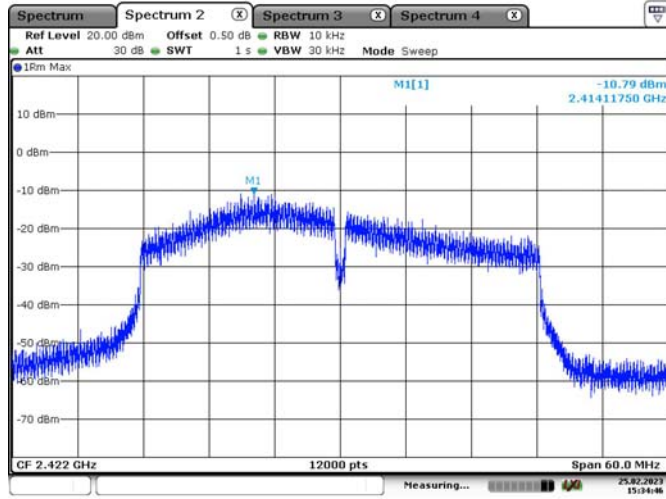

802.11n ht40
Middle Channel

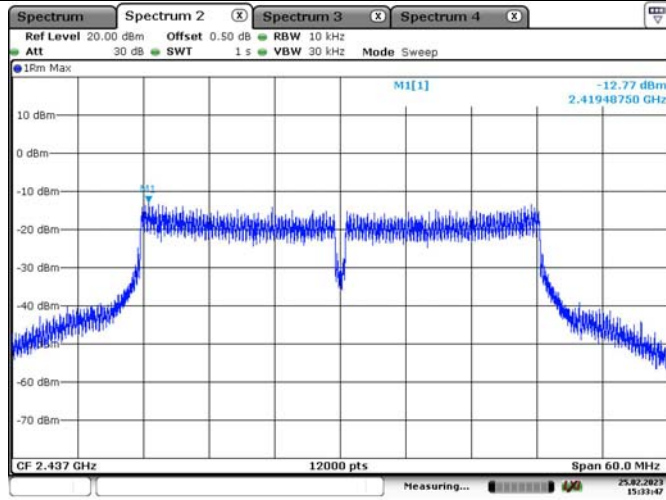

802.11n ht40
Highest Channel

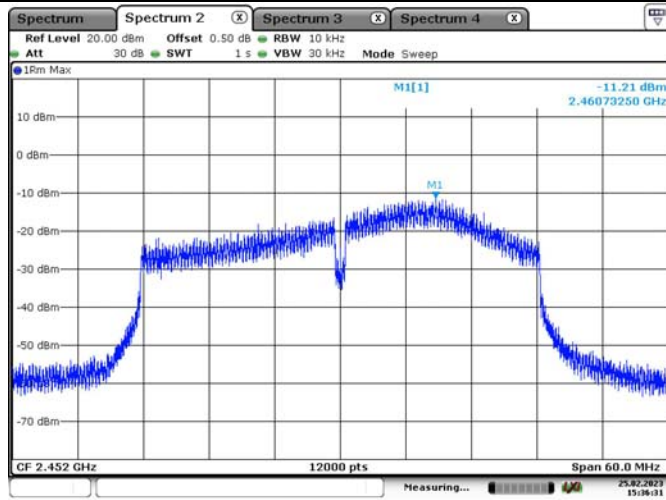

4.7 100 kHz Bandwidth of Frequency Band Edge:

Serial Number:	2295	Test Date:	2023/02/25
Test Site:	RF	Test Mode:	Transmitting
Tester:	Julie Tan	Test Result:	Pass

Environmental Conditions:

Temperature: (°C)	25.3	Relative Humidity: (%)	33	ATM Pressure: (kPa)	101.2
----------------------	------	------------------------------	----	------------------------	-------

Test Equipment List and Details:

Manufacturer	Description	Model	Serial Number	Calibration Date	Calibration Due Date
R&S	Spectrum Analyzer	FSV40	101943	2022/07/25	2023/07/24
HuiXunDa	DC Block	SMA-JK 18G	DCB181108043	Each time	N/A
zhuoxiang	Coaxial Cable	SMA-178	211001	Each time	N/A

** Statement of Traceability: China Certification ICT Co., Ltd (Dongguan) attests that all calibrations have been performed, traceable to National Primary Standards and International System of Units (SI).*

Test Data:

100 kHz Bandwidth of Frequency Band Edge

802.11b
Lowest Band edge

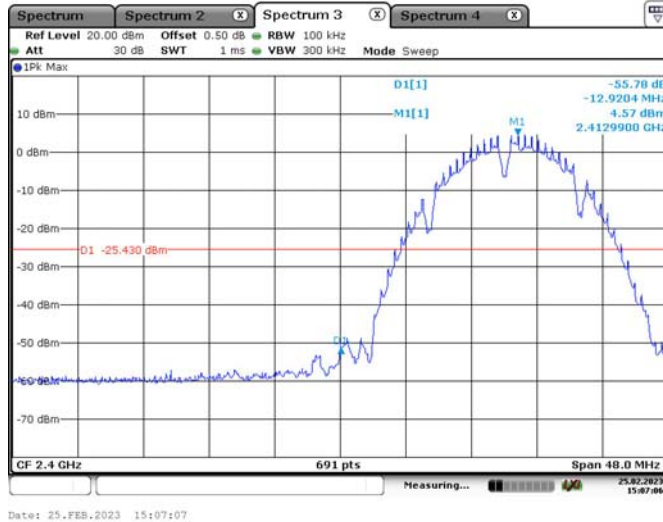

802.11b
Highest Band edge

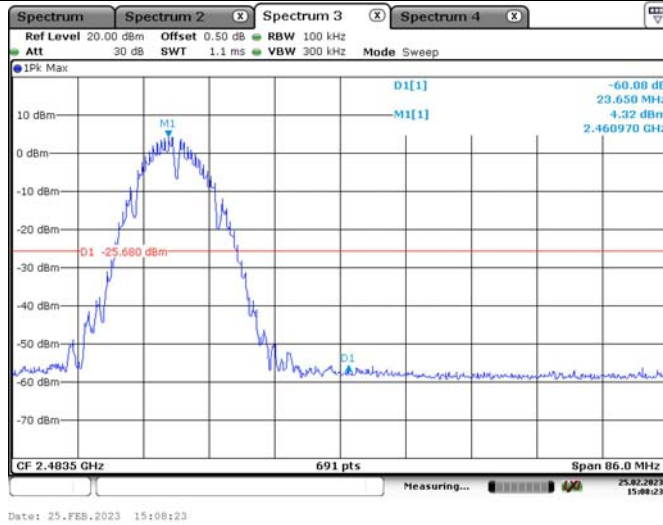

100 kHz Bandwidth of Frequency Band Edge

802.11g
Lowest Band edge



802.11g
Highest Band edge

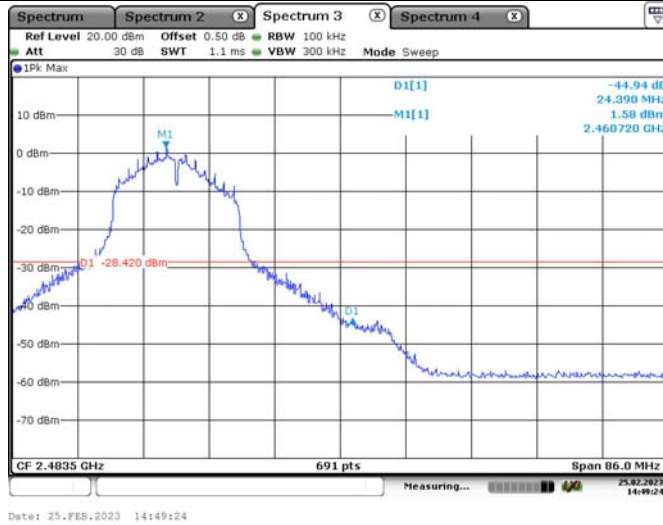

100 kHz Bandwidth of Frequency Band Edge

802.11n ht20
Lowest Band edge

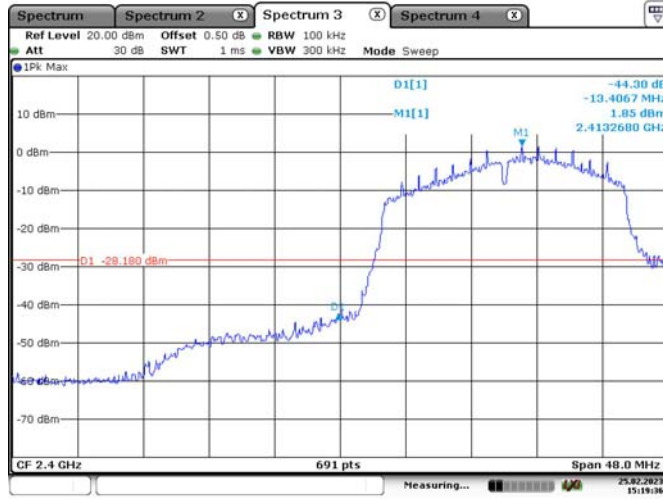

802.11n ht20
Highest Band edge



100 kHz Bandwidth of Frequency Band Edge

802.11n ht40
Lowest Band edge

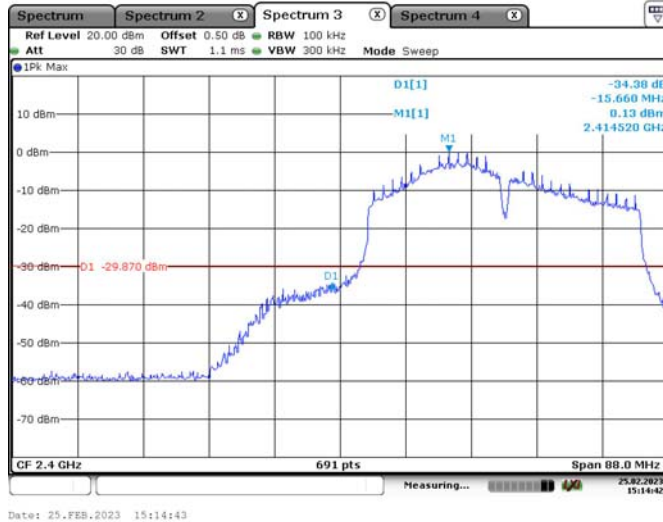

802.11n ht40
Highest Band edge

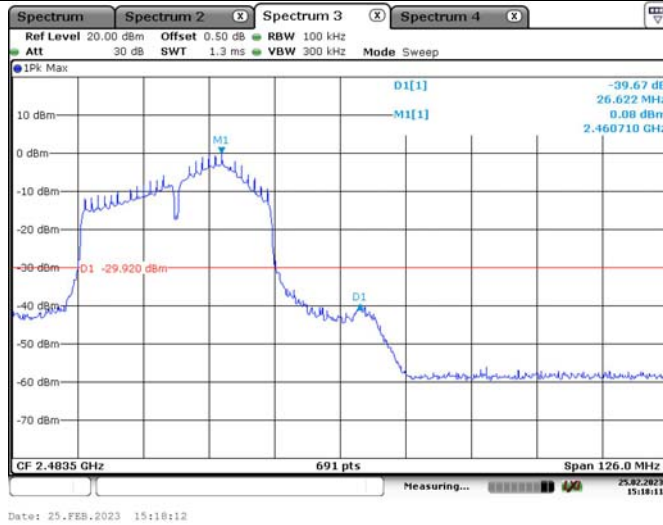

4.8 Duty Cycle:

Serial Number:	2295	Test Date:	2023/02/25
Test Site:	RF	Test Mode:	Transmitting
Tester:	Julie Tan	Test Result:	N/A

Environmental Conditions:

Temperature: (°C)	25.3	Relative Humidity: (%)	33	ATM Pressure: (kPa)	101.2
----------------------	------	------------------------------	----	------------------------	-------

Test Equipment List and Details:

Manufacturer	Description	Model	Serial Number	Calibration Date	Calibration Due Date
R&S	Spectrum Analyzer	FSV40	101943	2022/07/25	2023/07/24
HuiXunDa	DC Block	SMA-JK 18G	DCB181108043	Each time	N/A
zhuoxiang	Coaxial Cable	SMA-178	211001	Each time	N/A

** Statement of Traceability: China Certification ICT Co., Ltd (Dongguan) attests that all calibrations have been performed, traceable to National Primary Standards and International System of Units (SI).*

Test Data:

Test Modes	Ton (ms)	Ton+off (ms)	Duty cycle (%)	1/T (Hz)	Duty Cycle Factor (dB)
802.11b	100	100	100.00	/	/
802.11g	1.425	1.437	99.16	/	/
802.11n ht20	1.333	1.349	98.81	/	/
802.11n ht40	0.665	/	Not constant	1504	/

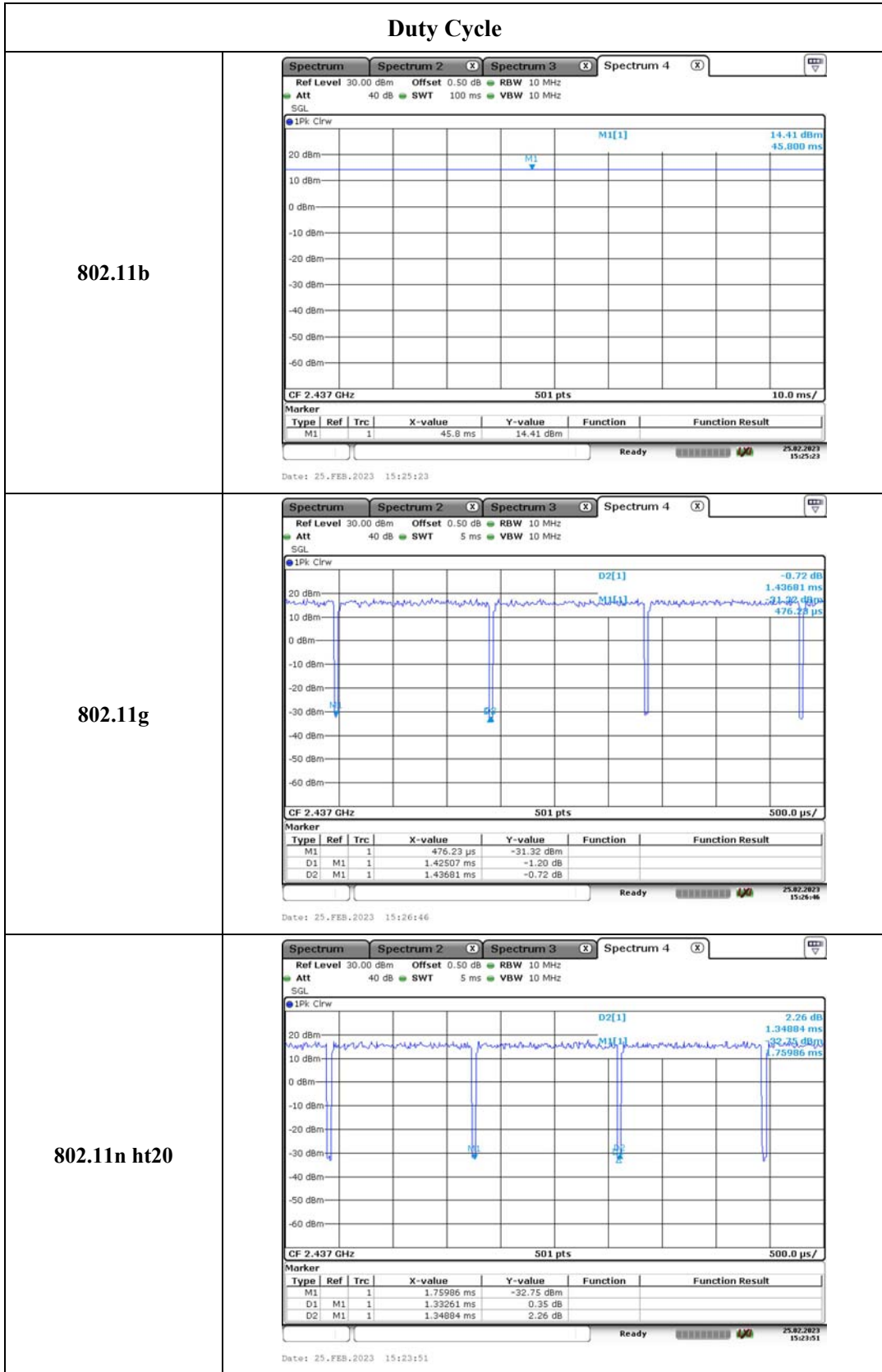

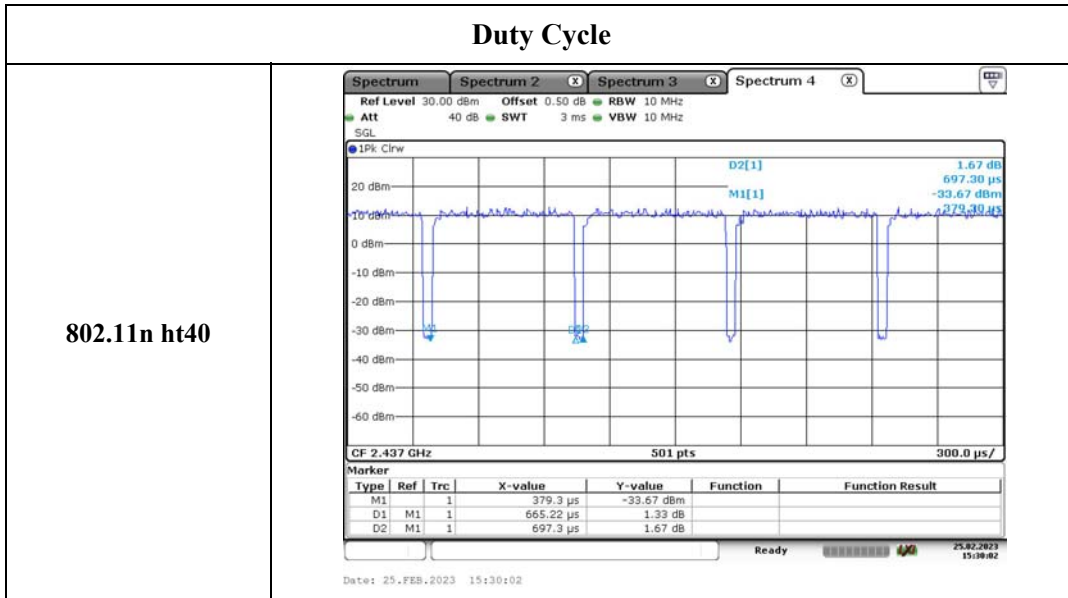

==== END OF REPORT ====