

APPENDIX C CALIBRATION CERTIFICATES



Add: No.52 HuaYuanBei Road, Haidian District, Beijing, 100191, China
 Tel: +86-10-62304633-2117
 E-mail: emf@caict.ac.cn http://www.caict.ac.cn



Client **CCICT**

Certificate No: **Z23-60188**

CALIBRATION CERTIFICATE

Object ES3DV3 - SN : 3157

Calibration Procedure(s) FF-Z11-004-02
 Calibration Procedures for Dosimetric E-field Probes

Calibration date: April 10, 2023

This calibration Certificate documents the traceability to national standards, which realize the physical units of measurements(SI). The measurements and the uncertainties with confidence probability are given on the following pages and are part of the certificate.

All calibrations have been conducted in the closed laboratory facility: environment temperature(22±3)°C and humidity<70%.

Calibration Equipment used (M&TE critical for calibration)

| Primary Standards | ID # | Cal Date(Calibrated by, Certificate No.) | Scheduled Calibration |
|--------------------------|-------------|--|-----------------------|
| Power Meter NRP2 | 101919 | 14-Jun-22(CTTL, No.J22X04181) | Jun-23 |
| Power sensor NRP-Z91 | 101547 | 14-Jun-22(CTTL, No.J22X04181) | Jun-23 |
| Power sensor NRP-Z91 | 101548 | 14-Jun-22(CTTL, No.J22X04181) | Jun-23 |
| Reference 10dBAttenuator | 18N50W-10dB | 19-Jan-23(CTTL, No.J23X00212) | Jan-25 |
| Reference 20dBAttenuator | 18N50W-20dB | 19-Jan-23(CTTL, No.J23X00211) | Jan-25 |
| Reference Probe EX3DV4 | SN 3846 | 20-May-22(SPEAG, No.EX3-3846_May22) | May-23 |
| DAE4 | SN 1555 | 25-Aug-22(SPEAG, No.DAE4-1555_Aug22) | Aug-23 |
| DAE4 | SN 549 | 24-Jan-23(SPEAG, No.DAE4-549_Jan23) | Jan-24 |
| Secondary Standards | ID # | Cal Date(Calibrated by, Certificate No.) | Scheduled Calibration |
| SignalGenerator MG3700A | 6201052605 | 14-Jun-22(CTTL, No.J22X04182) | Jun-23 |
| Network Analyzer E5071C | MY46110673 | 10-Jan-23(CTTL, No.J23X00104) | Jan-24 |

| | Name | Function | Signature |
|----------------|-------------|--------------------|-----------|
| Calibrated by: | Yu Zongying | SAR Test Engineer | |
| Reviewed by: | Lin Hao | SAR Test Engineer | |
| Approved by: | Qi Dianyuan | SAR Project Leader | |

Issued: April 15, 2023

This calibration certificate shall not be reproduced except in full without written approval of the laboratory.



In Collaboration with
s p e a g
CALIBRATION LABORATORY



Add: No.52 HuaYuanBei Road, Haidian District, Beijing, 100191, China
Tel: +86-10-62304633-2117
E-mail: emf@caict.ac.cn <http://www.caict.ac.cn>

Glossary:

| | |
|-----------------------|--|
| TSL | tissue simulating liquid |
| NORM _{x,y,z} | sensitivity in free space |
| ConvF | sensitivity in TSL / NORM _{x,y,z} |
| DCP | diode compression point |
| CF | crest factor (1/duty_cycle) of the RF signal |
| A,B,C,D | modulation dependent linearization parameters |
| Polarization Φ | Φ rotation around probe axis |
| Polarization θ | θ rotation around an axis that is in the plane normal to probe axis (at measurement center), $\theta=0$ is normal to probe axis |

Connector Angle information used in DASY system to align probe sensor X to the robot coordinate system

Calibration is Performed According to the Following Standards:

- IEEE Std 1528-2013, "IEEE Recommended Practice for Determining the Peak Spatial-Averaged Specific Absorption Rate (SAR) in the Human Head from Wireless Communications Devices: Measurement Techniques", June 2013
- IEC 62209-1, "Measurement procedure for the assessment of Specific Absorption Rate (SAR) from hand-held and body-mounted devices used next to the ear (frequency range of 300 MHz to 6 GHz)", July 2016
- IEC 62209-2, "Procedure to determine the Specific Absorption Rate (SAR) for wireless communication devices used in close proximity to the human body (frequency range of 30 MHz to 6 GHz)", March 2010
- KDB 865664, "SAR Measurement Requirements for 100 MHz to 6 GHz"

Methods Applied and Interpretation of Parameters:

- NORM_{x,y,z}**: Assessed for E-field polarization $\theta=0$ ($f \leq 900\text{MHz}$ in TEM-cell; $f > 1800\text{MHz}$: waveguide). NORM_{x,y,z} are only intermediate values, i.e., the uncertainties of NORM_{x,y,z} does not effect the E^2 -field uncertainty inside TSL (see below ConvF).
- NORM(f)_{x,y,z}** = NORM_{x,y,z} * frequency_response (see Frequency Response Chart). This linearization is implemented in DASY4 software versions later than 4.2. The uncertainty of the frequency response is included in the stated uncertainty of ConvF.
- DCP_{x,y,z}**: DCP are numerical linearization parameters assessed based on the data of power sweep (no uncertainty required). DCP does not depend on frequency nor media.
- PAR**: PAR is the Peak to Average Ratio that is not calibrated but determined based on the signal characteristics.
- A_{x,y,z}; B_{x,y,z}; C_{x,y,z}; VR_{x,y,z}**: A,B,C are numerical linearization parameters assessed based on the data of power sweep for specific modulation signal. The parameters do not depend on frequency nor media. VR is the maximum calibration range expressed in RMS voltage across the diode.
- ConvF and Boundary Effect Parameters**: Assessed in flat phantom using E-field (or Temperature Transfer Standard for $f \leq 800\text{MHz}$) and inside waveguide using analytical field distributions based on power measurements for $f > 800\text{MHz}$. The same setups are used for assessment of the parameters applied for boundary compensation (alpha, depth) of which typical uncertainty valued are given. These parameters are used in DASY4 software to improve probe accuracy close to the boundary. The sensitivity in TSL corresponds to NORM_{x,y,z} ConvF whereby the uncertainty corresponds to that given for ConvF. A frequency dependent ConvF is used in DASY version 4.4 and higher which allows extending the validity from $\pm 50\text{MHz}$ to $\pm 100\text{MHz}$.
- Spherical isotropy (3D deviation from isotropy)**: in a field of low gradients realized using a flat phantom exposed by a patch antenna.
- Sensor Offset**: The sensor offset corresponds to the offset of virtual measurement center from the probe tip (on probe axis). No tolerance required.
- Connector Angle**: The angle is assessed using the information gained by determining the NORM_x (no uncertainty required).

DASY/EASY – Parameters of Probe: ES3DV3 – SN:3157

Basic Calibration Parameters

| | Sensor X | Sensor Y | Sensor Z | Unc ($k=2$) |
|--------------------------------------|----------|----------|----------|---------------|
| Norm($\mu V/(V/m)^2$) ^A | 0.97 | 1.14 | 0.96 | $\pm 10.0\%$ |
| DCP(mV) ^B | 102.2 | 102.6 | 103.6 | |

Modulation Calibration Parameters

| UID | Communication System Name | | A dB | B dB $\sqrt{\mu V}$ | C | D dB | VR mV | Unc ^E ($k=2$) |
|-----|---------------------------|---|---------|------------------------|-----|---------|----------|-------------------------------|
| 0 | CW | X | 0.0 | 0.0 | 1.0 | 0.00 | 224.4 | $\pm 2.0\%$ |
| | | Y | 0.0 | 0.0 | 1.0 | | 247.0 | |
| | | Z | 0.0 | 0.0 | 1.0 | | 223.9 | |

The reported uncertainty of measurement is stated as the standard uncertainty of Measurement multiplied by the coverage factor $k=2$, which for a normal distribution Corresponds to a coverage probability of approximately 95%.

^A The uncertainties of Norm X, Y, Z do not affect the E²-field uncertainty inside TSL (see Page 4).

^B Numerical linearization parameter: uncertainty not required.

^E Uncertainty is determined using the max. deviation from linear response applying rectangular distribution and is expressed for the square of the field value.

DASY/EASY – Parameters of Probe: ES3DV3 – SN:3157

Calibration Parameter Determined in Head Tissue Simulating Media

| f [MHz] ^C | Relative Permittivity ^F | Conductivity (S/m) ^F | ConvF X | ConvF Y | ConvF Z | Alpha ^G | Depth ^G (mm) | Unct. (k=2) |
|----------------------|------------------------------------|---------------------------------|---------|---------|---------|--------------------|-------------------------|-------------|
| 750 | 41.9 | 0.89 | 6.48 | 6.48 | 6.48 | 0.35 | 1.53 | ± 12.7% |
| 900 | 41.5 | 0.97 | 6.25 | 6.25 | 6.25 | 0.37 | 1.53 | ± 12.7% |
| 1750 | 40.1 | 1.37 | 5.38 | 5.38 | 5.38 | 0.60 | 1.31 | ± 12.7% |
| 1900 | 40.0 | 1.40 | 5.18 | 5.18 | 5.18 | 0.65 | 1.26 | ± 12.7% |
| 2300 | 39.5 | 1.67 | 4.96 | 4.96 | 4.96 | 0.90 | 1.10 | ± 12.7% |
| 2450 | 39.2 | 1.80 | 4.74 | 4.74 | 4.74 | 0.90 | 1.10 | ± 12.7% |
| 2600 | 39.0 | 1.96 | 4.52 | 4.52 | 4.52 | 0.90 | 1.16 | ± 12.7% |

^C Frequency validity above 300 MHz of ±100MHz only applies for DASY v4.4 and higher (Page 2), else it is restricted to ±50MHz. The uncertainty is the RSS of ConvF uncertainty at calibration frequency and the uncertainty for the indicated frequency band. Frequency validity below 300 MHz is ± 10, 25, 40, 50 and 70 MHz for ConvF assessments at 30, 64, 128, 150 and 220 MHz respectively. Above 5 GHz frequency validity can be extended to ± 110 MHz.

^F At frequency up to 6 GHz, the validity of tissue parameters (ϵ and σ) can be relaxed to ±10% if liquid compensation formula is applied to measured SAR values. The uncertainty is the RSS of the ConvF uncertainty for indicated target tissue parameters.

^G Alpha/Depth are determined during calibration. SPEAG warrants that the remaining deviation due to the boundary effect after compensation is always less than ± 1% for frequencies below 3 GHz and below ± 2% for the frequencies between 3-6 GHz at any distance larger than half the probe tip diameter from the boundary.

Frequency Response of E-Field (TEM-Cell: ifi110 EXX, Waveguide: R22)

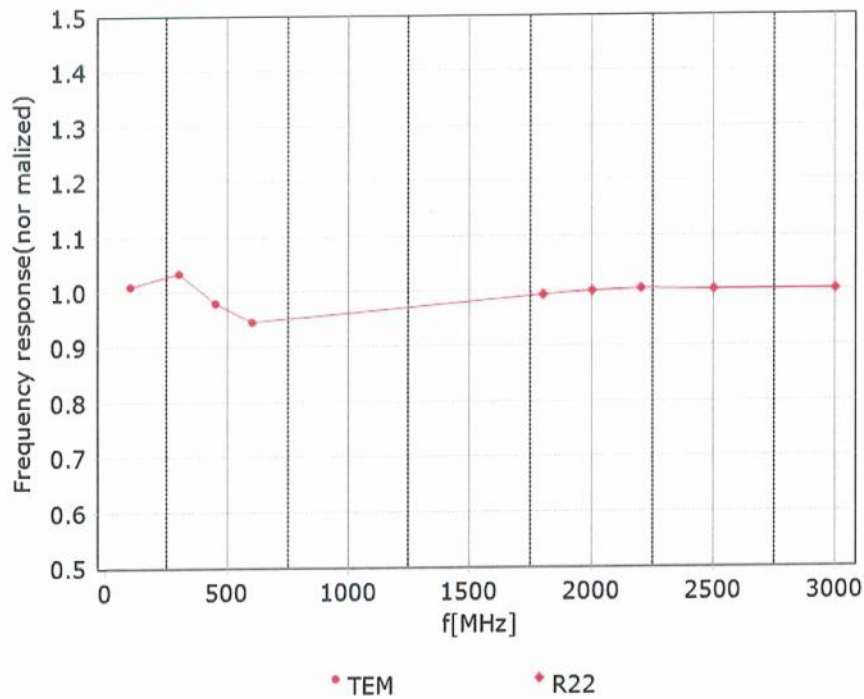

Uncertainty of Frequency Response of E-field: $\pm 7.4\%$ ($k=2$)

Add: No.52 HuaYuanBei Road, Haidian District, Beijing, 100191, China
 Tel: +86-10-62304633-2117
 E-mail: emf@caict.ac.cn http://www.caict.ac.cn

Receiving Pattern (Φ), $\theta=0^\circ$

f=600 MHz, TEM

f=1800 MHz, R22

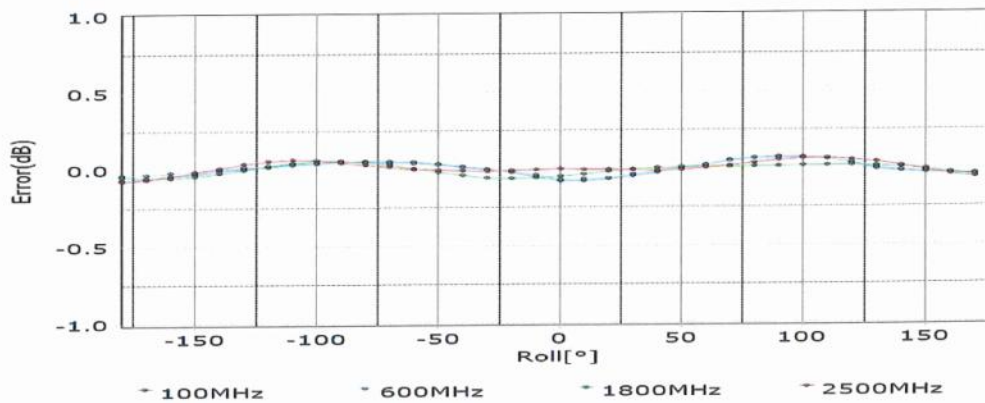
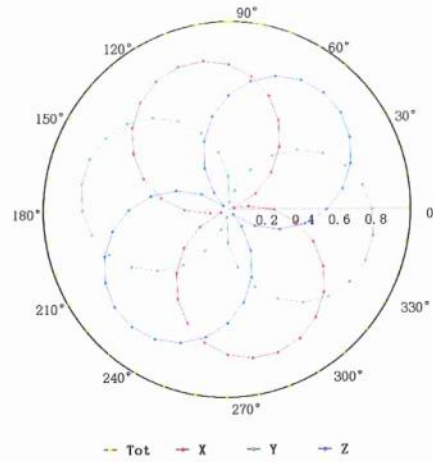
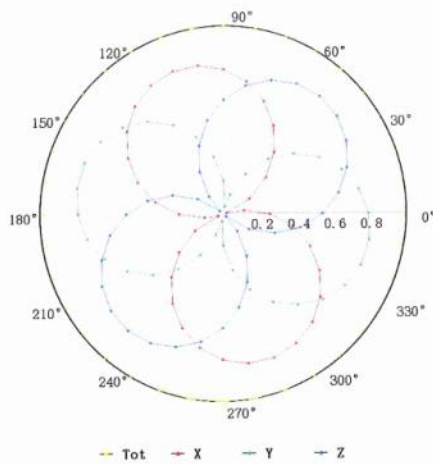

Uncertainty of Axial Isotropy Assessment: $\pm 1.2\%$ ($k=2$)

Add: No.52 HuaYuanBei Road, Haidian District, Beijing, 100191, China
 Tel: +86-10-62304633-2117
 E-mail: emf@caict.ac.cn http://www.caict.ac.cn

Dynamic Range f(SAR_{head}) (TEM cell, f = 900 MHz)

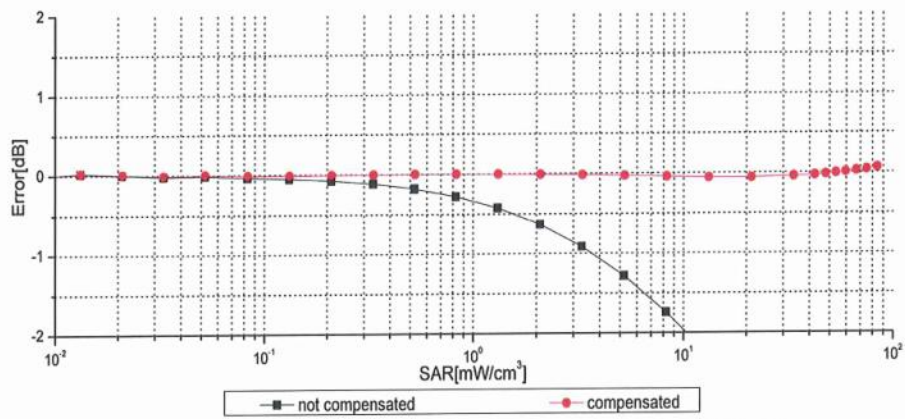
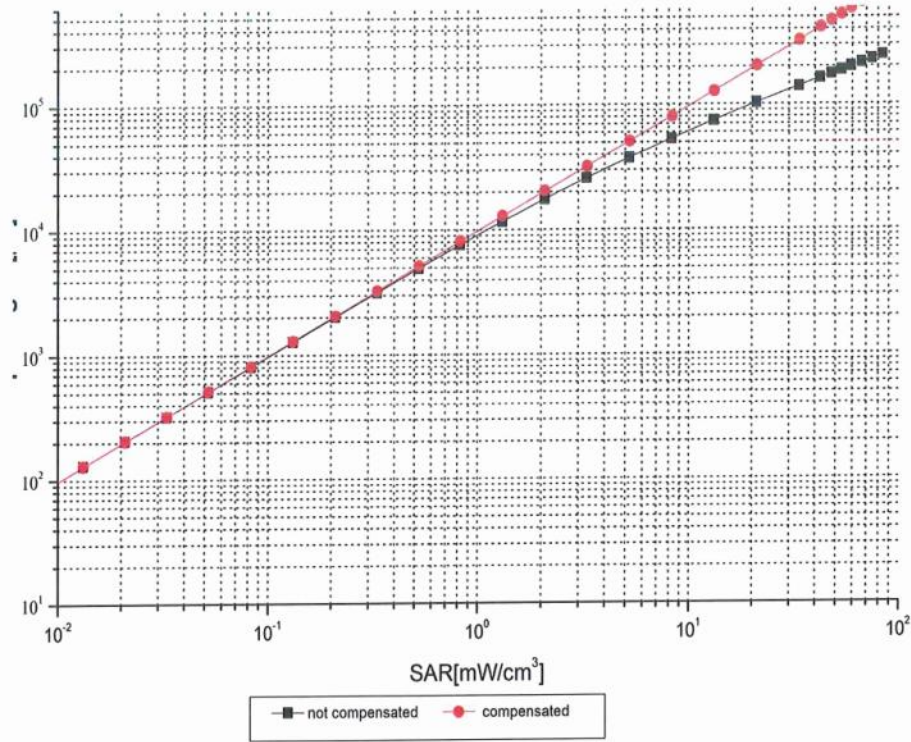

Uncertainty of Linearity Assessment: ±0.9% (k=2)

Conversion Factor Assessment

f=750 MHz,WGLS R9(H_convF)

f=1750 MHz,WGLS R22(H_convF)

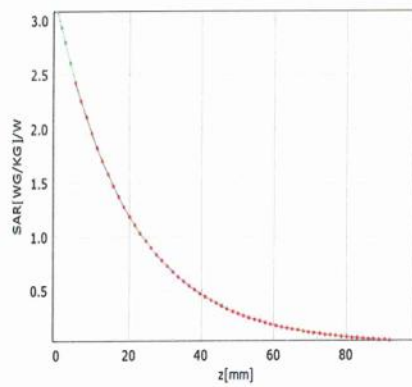

* analytical * measured

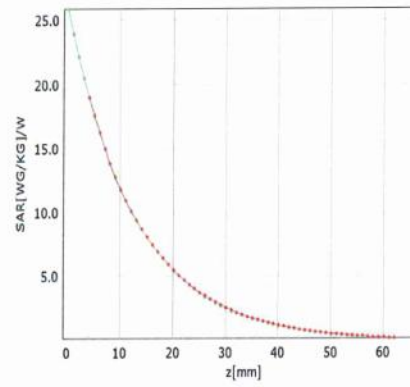

* analytical * measured

Deviation from Isotropy in Liquid

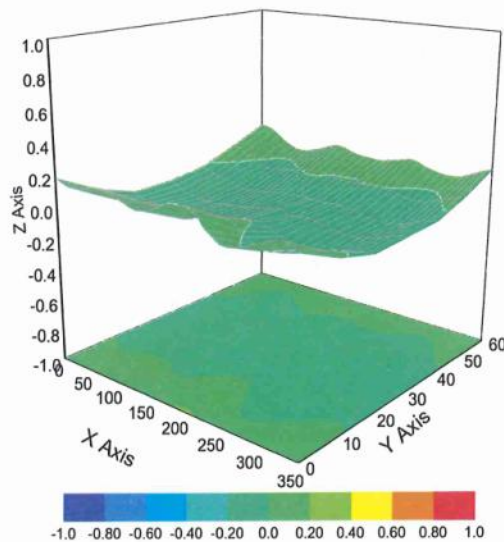

Uncertainty of Spherical Isotropy Assessment: $\pm 3.2\%$ ($k=2$)

DASY/EASY – Parameters of Probe: ES3DV3 – SN:3157

Other Probe Parameters

| | |
|--|-------------------|
| Sensor Arrangement | Triangular |
| Connector Angle (°) | 56.2 |
| Mechanical Surface Detection Mode | enabled |
| Optical Surface Detection Mode | disable |
| Probe Overall Length | 337mm |
| Probe Body Diameter | 10mm |
| Tip Length | 10mm |
| Tip Diameter | 4mm |
| Probe Tip to Sensor X Calibration Point | 2mm |
| Probe Tip to Sensor Y Calibration Point | 2mm |
| Probe Tip to Sensor Z Calibration Point | 2mm |
| Recommended Measurement Distance from Surface | 3mm |

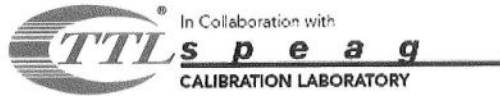

In Collaboration with

CALIBRATION LABORATORY

Add: No.52 HuaYuanBei Road, Haidian District, Beijing, 100191, China
 Tel: +86-10-62304633-2117
 E-mail: emf@caict.ac.cn http://www.caict.ac.cn



中国认可
 国际互认
 校准
 CALIBRATION
 CNAS L0570

Client **CCICT**

Certificate No: **J23Z60226**

CALIBRATION CERTIFICATE

Object EX3DV4 - SN : 7522

Calibration Procedure(s) FF-Z11-004-02
 Calibration Procedures for Dosimetric E-field Probes

Calibration date: May 29, 2023

This calibration Certificate documents the traceability to national standards, which realize the physical units of measurements(SI). The measurements and the uncertainties with confidence probability are given on the following pages and are part of the certificate.

All calibrations have been conducted in the closed laboratory facility: environment temperature(22±3)°C and humidity<70%.

Calibration Equipment used (M&TE critical for calibration)

| Primary Standards | ID # | Cal Date(Calibrated by, Certificate No.) | Scheduled Calibration |
|--------------------------|-------------|--|-----------------------|
| Power Meter NRP2 | 101919 | 14-Jun-22(CTTL, No.J22X04181) | Jun-23 |
| Power sensor NRP-Z91 | 101547 | 14-Jun-22(CTTL, No.J22X04181) | Jun-23 |
| Power sensor NRP-Z91 | 101548 | 14-Jun-22(CTTL, No.J22X04181) | Jun-23 |
| Reference 10dBAttenuator | 18N50W-10dB | 19-Jan-23(CTTL, No.J23X00212) | Jan-25 |
| Reference 20dBAttenuator | 18N50W-20dB | 19-Jan-23(CTTL, No.J23X00211) | Jan-25 |
| OCP DAK-3.5 | SN 1040 | 18-Jan-23(SPEAG, No.OCP-DAK3.5-1040_Jan23) | Jan-24 |
| Reference Probe EX3DV4 | SN 7517 | 27-Jan-23(SPEAG, No.EX-7517_Jan23) | Jan-24 |
| DAE4 | SN 1555 | 25-Aug-22(SPEAG, No.DAE4-1555_Aug22) | Aug-23 |
| Secondary Standards | ID # | Cal Date(Calibrated by, Certificate No.) | Scheduled Calibration |
| SignalGenerator MG3700A | 6201052605 | 14-Jun-22(CTTL, No.J22X04182) | Jun-23 |
| Network Analyzer E5071C | MY46110673 | 10-Jan-23(CTTL, No.J23X00104) | Jan-24 |
| Reference 10dBAttenuator | BT0520 | 11-May-23(CTTL, No.J23X04061) | May-25 |
| Reference 20dBAttenuator | BT0267 | 11-May-23(CTTL, No.J23X04062) | May-25 |

| | Name | Function | Signature |
|----------------|-------------|--------------------|-----------|
| Calibrated by: | Yu Zongying | SAR Test Engineer | |
| Reviewed by: | Lin Hao | SAR Test Engineer | |
| Approved by: | Qi Dianyuan | SAR Project Leader | |

Issued: June 04, 2023

This calibration certificate shall not be reproduced except in full without written approval of the laboratory.



In Collaboration with
s p e a g
CALIBRATION LABORATORY



Add: No.52 HuaYuanBei Road, Haidian District, Beijing, 100191, China
Tel: +86-10-62304633-2117
E-mail: emf@caict.ac.cn <http://www.caict.ac.cn>

Glossary:

| | |
|-----------------------|---|
| TSL | tissue simulating liquid |
| NORM _{x,y,z} | sensitivity in free space |
| ConvF | sensitivity in TSL / NORM _{x,y,z} |
| DCP | diode compression point |
| CF | crest factor (1/duty_cycle) of the RF signal |
| A,B,C,D | modulation dependent linearization parameters |
| Polarization Φ | Φ rotation around probe axis |
| Polarization θ | θ rotation around an axis that is in the plane normal to probe axis (at measurement center), i $\theta=0$ is normal to probe axis |

Connector Angle information used in DASY system to align probe sensor X to the robot coordinate system

Calibration is Performed According to the Following Standards:

- IEEE Std 1528-2013, "IEEE Recommended Practice for Determining the Peak Spatial-Averaged Specific Absorption Rate (SAR) in the Human Head from Wireless Communications Devices: Measurement Techniques", June 2013
- IEC 62209-1, "Measurement procedure for the assessment of Specific Absorption Rate (SAR) from hand-held and body-mounted devices used next to the ear (frequency range of 300 MHz to 6 GHz)", July 2016
- IEC 62209-2, "Procedure to determine the Specific Absorption Rate (SAR) for wireless communication devices used in close proximity to the human body (frequency range of 30 MHz to 6 GHz)", March 2010
- KDB 865664, "SAR Measurement Requirements for 100 MHz to 6 GHz"

Methods Applied and Interpretation of Parameters:

- NORM_{x,y,z}: Assessed for E-field polarization $\theta=0$ ($f \leq 900$ MHz in TEM-cell; $f > 1800$ MHz: waveguide). NORM_{x,y,z} are only intermediate values, i.e., the uncertainties of NORM_{x,y,z} does not effect the E^2 -field uncertainty inside TSL (see below ConvF).
- NORM(f)_{x,y,z} = NORM_{x,y,z} * frequency_response (see Frequency Response Chart). This linearization is implemented in DASY4 software versions later than 4.2. The uncertainty of the frequency response is included in the stated uncertainty of ConvF.
- DCP_{x,y,z}: DCP are numerical linearization parameters assessed based on the data of power sweep (no uncertainty required). DCP does not depend on frequency nor media.
- PAR: PAR is the Peak to Average Ratio that is not calibrated but determined based on the signal characteristics.
- A_{x,y,z}; B_{x,y,z}; C_{x,y,z}; VR_{x,y,z}; A,B,C are numerical linearization parameters assessed based on the data of power sweep for specific modulation signal. The parameters do not depend on frequency nor media. VR is the maximum calibration range expressed in RMS voltage across the diode.
- ConvF and Boundary Effect Parameters: Assessed in flat phantom using E-field (or Temperature Transfer Standard for $f \leq 800$ MHz) and inside waveguide using analytical field distributions based on power measurements for $f > 800$ MHz. The same setups are used for assessment of the parameters applied for boundary compensation (alpha, depth) of which typical uncertainty valued are given. These parameters are used in DASY4 software to improve probe accuracy close to the boundary. The sensitivity in TSL corresponds to NORM_{x,y,z} * ConvF whereby the uncertainty corresponds to that given for ConvF. A frequency dependent ConvF is used in DASY version 4.4 and higher which allows extending the validity from ± 50 MHz to ± 100 MHz.
- Spherical isotropy (3D deviation from isotropy): in a field of low gradients realized using a flat phantom exposed by a patch antenna.
- Sensor Offset: The sensor offset corresponds to the offset of virtual measurement center from the probe tip (on probe axis). No tolerance required.
- Connector Angle: The angle is assessed using the information gained by determining the NORM_x (no uncertainty required).



In Collaboration with
s p e a g
 CALIBRATION LABORATORY



Add: No.52 HuaYuanBei Road, Haidian District, Beijing, 100191, China
 Tel: +86-10-62304633-2117
 E-mail: emf@caict.ac.cn http://www.caict.ac.cn

DASY/EASY – Parameters of Probe: EX3DV4 – SN:7522

Basic Calibration Parameters

| | Sensor X | Sensor Y | Sensor Z | Unc (k=2) |
|--|----------|----------|----------|-----------|
| Norm($\mu\text{V}/(\text{V}/\text{m})^2$) ^A | 0.44 | 0.45 | 0.53 | ±10.0% |
| DCP(mV) ^B | 99.4 | 98.3 | 99.1 | |

Modulation Calibration Parameters

| UID | Communication System Name | | A dB | B dB $\sqrt{\mu\text{V}}$ | C | D dB | VR mV | Unc ^E (k=2) |
|-----|---------------------------|---|---------|------------------------------|-----|---------|----------|---------------------------|
| 0 | CW | X | 0.0 | 0.0 | 1.0 | 0.00 | 156.8 | ±2.8% |
| | | Y | 0.0 | 0.0 | 1.0 | | 158.4 | |
| | | Z | 0.0 | 0.0 | 1.0 | | 176.2 | |

The reported uncertainty of measurement is stated as the standard uncertainty of Measurement multiplied by the coverage factor $k=2$, which for a normal distribution Corresponds to a coverage probability of approximately 95%.

^A The uncertainties of Norm X, Y, Z do not affect the E²-field uncertainty inside TSL (see Page 4).

^B Numerical linearization parameter: uncertainty not required.

^E Uncertainty is determined using the max. deviation from linear response applying rectangular distribution and is expressed for the square of the field value.



In Collaboration with
s p e a g
 CALIBRATION LABORATORY



Add: No.52 HuaYuanBei Road, Haidian District, Beijing, 100191, China
 Tel: +86-10-62304633-2117
 E-mail: emf@caict.ac.cn http://www.caict.ac.cn

DASY/EASY – Parameters of Probe: EX3DV4 – SN:7522

Calibration Parameter Determined in Head Tissue Simulating Media

| f [MHz] ^C | Relative Permittivity ^F | Conductivity (S/m) ^F | ConvF X | ConvF Y | ConvF Z | Alpha ^G | Depth ^G (mm) | Unct. (k=2) |
|----------------------|------------------------------------|---------------------------------|---------|---------|---------|--------------------|-------------------------|-------------|
| 750 | 41.9 | 0.89 | 9.90 | 9.90 | 9.90 | 0.11 | 1.85 | ± 12.7% |
| 900 | 41.5 | 0.97 | 9.37 | 9.37 | 9.37 | 0.15 | 1.74 | ± 12.7% |
| 1750 | 40.1 | 1.37 | 8.15 | 8.15 | 8.15 | 0.25 | 1.13 | ± 12.7% |
| 1900 | 40.0 | 1.40 | 7.94 | 7.94 | 7.94 | 0.23 | 1.09 | ± 12.7% |
| 2300 | 39.5 | 1.67 | 7.67 | 7.67 | 7.67 | 0.65 | 0.69 | ± 12.7% |
| 2450 | 39.2 | 1.80 | 7.42 | 7.42 | 7.42 | 0.65 | 0.69 | ± 12.7% |
| 2600 | 39.0 | 1.96 | 7.23 | 7.23 | 7.23 | 0.50 | 0.83 | ± 12.7% |
| 5250 | 35.9 | 4.71 | 5.36 | 5.36 | 5.36 | 0.45 | 1.47 | ± 13.9% |
| 5500 | 35.6 | 4.96 | 4.85 | 4.85 | 4.85 | 0.50 | 1.40 | ± 13.9% |
| 5750 | 35.4 | 5.22 | 4.90 | 4.90 | 4.90 | 0.45 | 1.50 | ± 13.9% |

^C Frequency validity above 300 MHz of ±100MHz only applies for DASY v4.4 and higher (Page 2), else it is restricted to ±50MHz. The uncertainty is the RSS of ConvF uncertainty at calibration frequency and the uncertainty for the indicated frequency band. Frequency validity below 300 MHz is ± 10, 25, 40, 50 and 70 MHz for ConvF assessments at 30, 64, 128, 150 and 220 MHz respectively. Above 5 GHz frequency validity can be extended to ± 110 MHz.

^F At frequency up to 6 GHz, the validity of tissue parameters (ϵ and σ) can be relaxed to ±10% if liquid compensation formula is applied to measured SAR values. The uncertainty is the RSS of the ConvF uncertainty for indicated target tissue parameters.

^G Alpha/Depth are determined during calibration. SPEAG warrants that the remaining deviation due to the boundary effect after compensation is always less than ± 1% for frequencies below 3 GHz and below ± 2% for the frequencies between 3-6 GHz at any distance larger than half the probe tip diameter from the boundary.



In Collaboration with
s p e a g
CALIBRATION LABORATORY

CAICT

Add: No.52 HuaYuanBei Road, Haidian District, Beijing, 100191, China
Tel: +86-10-62304633-2117
E-mail: emf@caict.ac.cn <http://www.caict.ac.cn>

Frequency Response of E-Field (TEM-Cell: ifi110 EXX, Waveguide: R22)

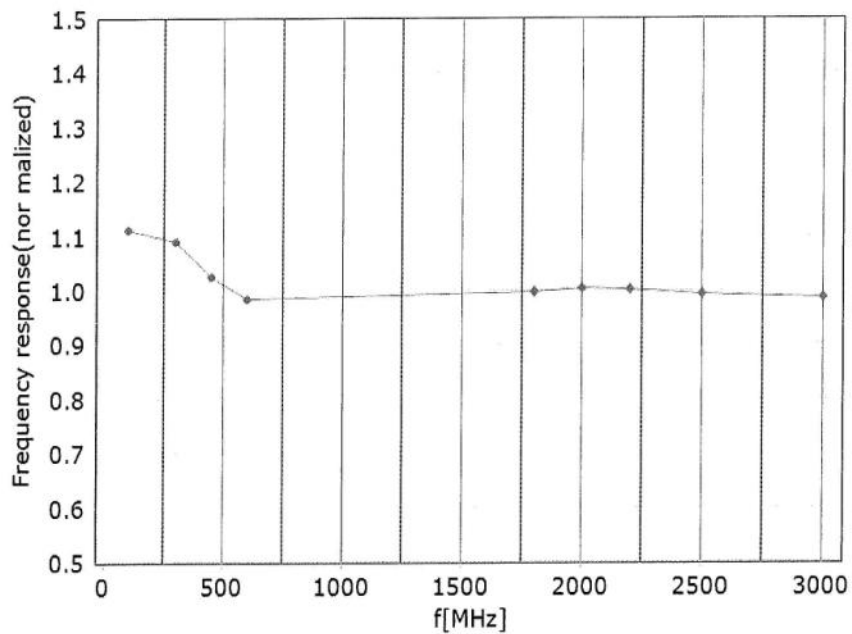

* TEM

* R22

Uncertainty of Frequency Response of E-field: $\pm 7.4\%$ ($k=2$)

Add: No.52 HuaYuanBei Road, Haidian District, Beijing, 100191, China
 Tel: +86-10-62304633-2117
 E-mail: emf@caict.ac.cn http://www.caict.ac.cn

Receiving Pattern (Φ), $\theta=0^\circ$

f=600 MHz, TEM

f=1800 MHz, R22

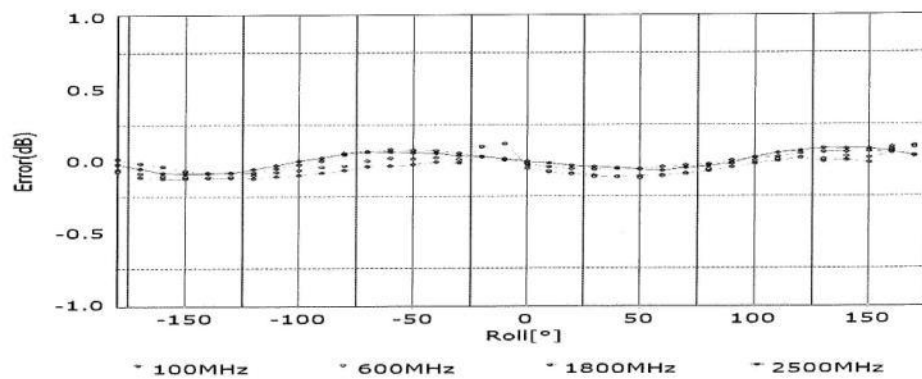
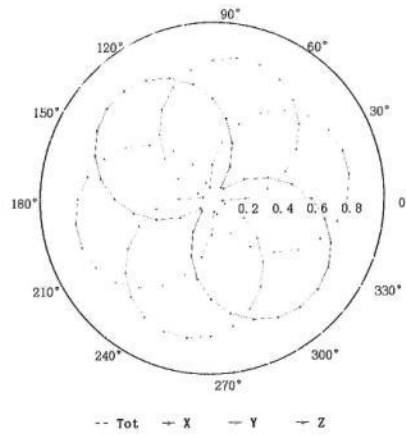
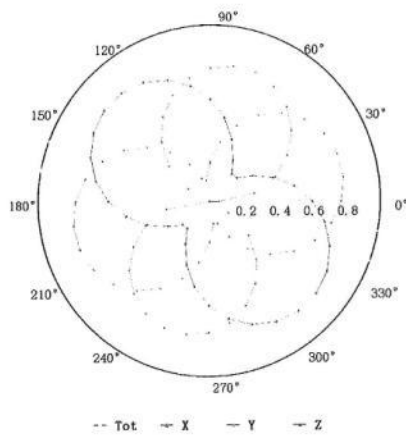

Uncertainty of Axial Isotropy Assessment: $\pm 1.2\%$ ($k=2$)



In Collaboration with
s p e a g
CALIBRATION LABORATORY



Add: No.52 HuaYuanBei Road, Haidian District, Beijing, 100191, China
Tel: +86-10-62304633-2117
E-mail: emf@caict.ac.cn <http://www.caict.ac.cn>

Dynamic Range f(SAR_{head}) (TEM cell, f = 900 MHz)

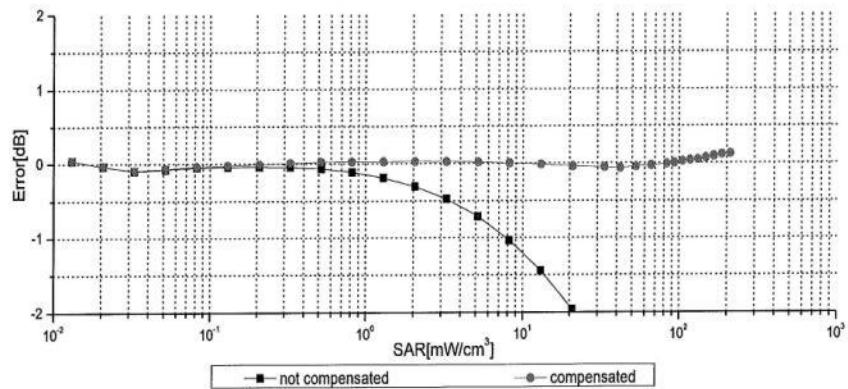
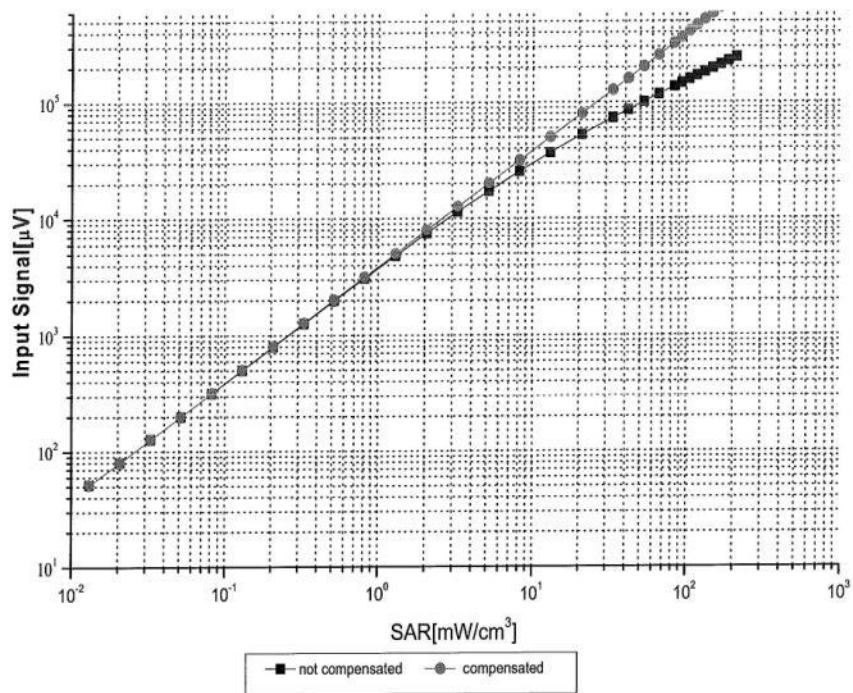

Uncertainty of Linearity Assessment: ±0.9% (k=2)



In Collaboration with
s p e a g
CALIBRATION LABORATORY



Add: No.52 HuaYuanBei Road, Haidian District, Beijing, 100191, China
Tel: +86-10-62304633-2117
E-mail: emf@caict.ac.cn http://www.caict.ac.cn

Conversion Factor Assessment

f=750 MHz,WGLS R9(H_convF)

f=1750 MHz,WGLS R22(H_convF)

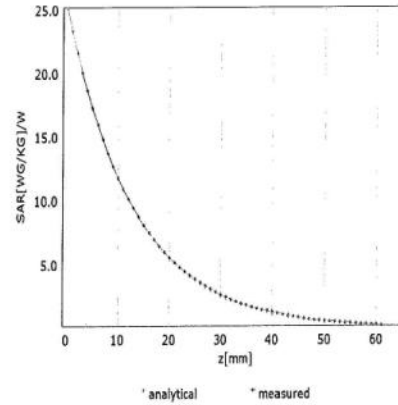
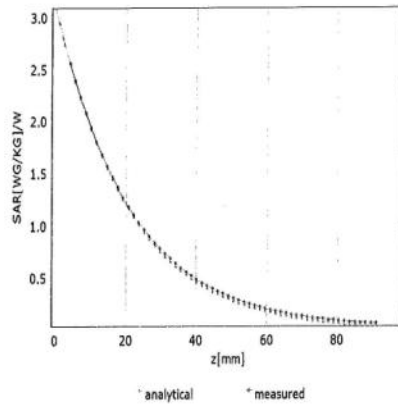

Deviation from Isotropy in Liquid

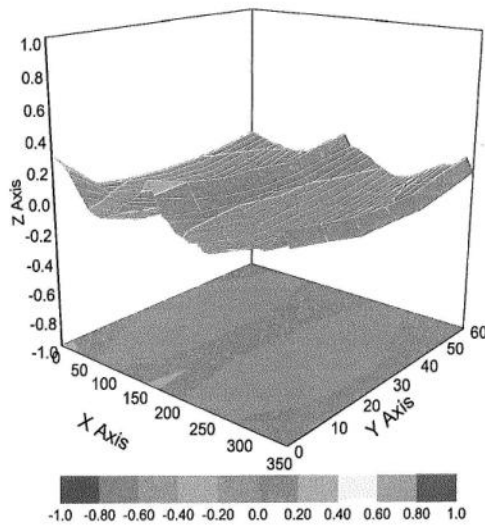

Uncertainty of Spherical Isotropy Assessment: $\pm 3.2\%$ ($k=2$)



In Collaboration with
s p e a g
CALIBRATION LABORATORY



Add: No.52 HuaYuanBei Road, Haidian District, Beijing, 100191, China
Tel: +86-10-62304633-2117
E-mail: emf@caict.ac.cn <http://www.caict.ac.cn>

DASY/EASY – Parameters of Probe: EX3DV4 – SN:7522

Other Probe Parameters

| | |
|---|------------|
| Sensor Arrangement | Triangular |
| Connector Angle (°) | 31.1 |
| Mechanical Surface Detection Mode | enabled |
| Optical Surface Detection Mode | disable |
| Probe Overall Length | 337mm |
| Probe Body Diameter | 10mm |
| Tip Length | 9mm |
| Tip Diameter | 2.5mm |
| Probe Tip to Sensor X Calibration Point | 1mm |
| Probe Tip to Sensor Y Calibration Point | 1mm |
| Probe Tip to Sensor Z Calibration Point | 1mm |
| Recommended Measurement Distance from Surface | 1.4mm |

DIPOLE CALIBRATION CERTIFICATES

**Calibration Laboratory of
Schmid & Partner
Engineering AG**
Zeughausstrasse 43, 8004 Zurich, Switzerland



S Schweizerischer Kalibrierdienst
C Service suisse d'étalonnage
S Servizio svizzero di taratura
S Swiss Calibration Service

Accredited by the Swiss Accreditation Service (SAS)
The Swiss Accreditation Service is one of the signatories to the EA
Multilateral Agreement for the recognition of calibration certificates

Accreditation No.: **SCS 0108**

Client **BACL USA**
Sunnyvale, USA

Certificate No. **D750V3-1230_Mar23**

CALIBRATION CERTIFICATE

Object **D750V3 - SN:1230**

Calibration procedure(s) **QA CAL-05.v12
Calibration Procedure for SAR Validation Sources between 0.7-3 GHz**

Calibration date: **March 24, 2023**

This calibration certificate documents the traceability to national standards, which realize the physical units of measurements (SI).
The measurements and the uncertainties with confidence probability are given on the following pages and are part of the certificate.

All calibrations have been conducted in the closed laboratory facility: environment temperature (22 ± 3)°C and humidity < 70%.

Calibration Equipment used (M&TE critical for calibration)

| Primary Standards | ID # | Cal Date (Certificate No.) | Scheduled Calibration |
|---------------------------------|--------------------|-----------------------------------|------------------------|
| Power meter NRP | SN: 104778 | 04-Apr-22 (No. 217-03525/03524) | Apr-23 |
| Power sensor NRP-Z91 | SN: 103244 | 04-Apr-22 (No. 217-03524) | Apr-23 |
| Power sensor NRP-Z91 | SN: 103245 | 04-Apr-22 (No. 217-03525) | Apr-23 |
| Reference 20 dB Attenuator | SN: BH9394 (20k) | 04-Apr-22 (No. 217-03527) | Apr-23 |
| Type-N mismatch combination | SN: 310982 / 06327 | 04-Apr-22 (No. 217-03528) | Apr-23 |
| Reference Probe EX3DV4 | SN: 7349 | 10-Jan-23 (No. EX3-7349_Jan23) | Jan-24 |
| DAE4 | SN: 601 | 19-Dec-22 (No. DAE4-601_Dec22) | Dec-23 |
| Secondary Standards | ID # | Check Date (in house) | Scheduled Check |
| Power meter E4419B | SN: GB39512475 | 30-Oct-14 (in house check Oct-22) | In house check: Oct-24 |
| Power sensor HP 8481A | SN: US37292783 | 07-Oct-15 (in house check Oct-22) | In house check: Oct-24 |
| Power sensor HP 8481A | SN: MY41093315 | 07-Oct-15 (in house check Oct-22) | In house check: Oct-24 |
| RF generator R&S SMT-06 | SN: 100972 | 15-Jun-15 (in house check Oct-22) | In house check: Oct-24 |
| Network Analyzer Agilent E8358A | SN: US41080477 | 31-Mar-14 (in house check Oct-22) | In house check: Oct-24 |

Calibrated by: **Name** Michael Weber **Function** Laboratory Technician

Signature

Approved by: **Name** Sven Kühn **Function** Technical Manager

Issued: March 24, 2023

This calibration certificate shall not be reproduced except in full without written approval of the laboratory.

**Calibration Laboratory of
Schmid & Partner
Engineering AG**
Zeughausstrasse 43, 8004 Zurich, Switzerland



S Schweizerischer Kalibrierdienst
C Service suisse d'étalonnage
S Servizio svizzero di taratura
S Swiss Calibration Service

Accredited by the Swiss Accreditation Service (SAS)
The Swiss Accreditation Service is one of the signatories to the EA
Multilateral Agreement for the recognition of calibration certificates

Accreditation No.: **SCS 0108**

Glossary:

| | |
|-------|---------------------------------|
| TSL | tissue simulating liquid |
| ConvF | sensitivity in TSL / NORM x,y,z |
| N/A | not applicable or not measured |

Calibration is Performed According to the Following Standards:

- IEC/IEEE 62209-1528, "Measurement Procedure For The Assessment Of Specific Absorption Rate Of Human Exposure To Radio Frequency Fields From Hand-Held And Body-Worn Wireless Communication Devices - Part 1528: Human Models, Instrumentation And Procedures (Frequency Range of 4 MHz to 10 GHz)", October 2020.
- KDB 865664, "SAR Measurement Requirements for 100 MHz to 6 GHz"

Additional Documentation:

- DASY System Handbook

Methods Applied and Interpretation of Parameters:

- Measurement Conditions:* Further details are available from the Validation Report at the end of the certificate. All figures stated in the certificate are valid at the frequency indicated.
- Antenna Parameters with TSL:* The source is mounted in a touch configuration below the center marking of the flat phantom.
- Return Loss:* This parameter is measured with the source positioned under the liquid filled phantom (as described in the measurement condition clause). The Return Loss ensures low reflected power. No uncertainty required.
- SAR measured:* SAR measured at the stated antenna input power.
- SAR normalized:* SAR as measured, normalized to an input power of 1 W at the antenna connector.
- SAR for nominal TSL parameters:* The measured TSL parameters are used to calculate the nominal SAR result.

The reported uncertainty of measurement is stated as the standard uncertainty of measurement multiplied by the coverage factor $k=2$, which for a normal distribution corresponds to a coverage probability of approximately 95%.

Measurement Conditions

DASY system configuration, as far as not given on page 1.

| | | |
|------------------------------|------------------------|-------------|
| DASY Version | DASY52 | V52.10.4 |
| Extrapolation | Advanced Extrapolation | |
| Phantom | Modular Flat Phantom | |
| Distance Dipole Center - TSL | 15 mm | with Spacer |
| Zoom Scan Resolution | dx, dy, dz = 5 mm | |
| Frequency | 750 MHz \pm 1 MHz | |

Head TSL parameters

The following parameters and calculations were applied.

| | Temperature | Permittivity | Conductivity |
|---|---------------------|----------------|----------------------|
| Nominal Head TSL parameters | 22.0 °C | 41.9 | 0.89 mho/m |
| Measured Head TSL parameters | (22.0 \pm 0.2) °C | 41.0 \pm 6 % | 0.90 mho/m \pm 6 % |
| Head TSL temperature change during test | < 0.5 °C | ---- | ---- |

SAR result with Head TSL

| SAR averaged over 1 cm ³ (1 g) of Head TSL | Condition | |
|---|--------------------|--|
| SAR measured | 250 mW input power | 2.15 W/kg |
| SAR for nominal Head TSL parameters | normalized to 1W | 8.49 W/kg \pm 17.0 % (k=2) |

| SAR averaged over 10 cm ³ (10 g) of Head TSL | condition | |
|---|--------------------|--|
| SAR measured | 250 mW input power | 1.40 W/kg |
| SAR for nominal Head TSL parameters | normalized to 1W | 5.54 W/kg \pm 16.5 % (k=2) |

Appendix (Additional assessments outside the scope of SCS 0108)

Antenna Parameters with Head TSL

| | |
|--------------------------------------|-----------------------------|
| Impedance, transformed to feed point | $53.0 \Omega + 0.9 j\Omega$ |
| Return Loss | - 30.3 dB |

General Antenna Parameters and Design

| | |
|----------------------------------|----------|
| Electrical Delay (one direction) | 1.037 ns |
|----------------------------------|----------|

After long term use with 100W radiated power, only a slight warming of the dipole near the feedpoint can be measured.

The dipole is made of standard semirigid coaxial cable. The center conductor of the feeding line is directly connected to the second arm of the dipole. The antenna is therefore short-circuited for DC-signals. On some of the dipoles, small end caps are added to the dipole arms in order to improve matching when loaded according to the position as explained in the "Measurement Conditions" paragraph. The SAR data are not affected by this change. The overall dipole length is still according to the Standard.

No excessive force must be applied to the dipole arms, because they might bend or the soldered connections near the feedpoint may be damaged.

Additional EUT Data

| | |
|-----------------|-------|
| Manufactured by | SPEAG |
|-----------------|-------|

DASY5 Validation Report for Head TSL

Date: 24.03.2023

Test Laboratory: SPEAG, Zurich, Switzerland

DUT: Dipole 750 MHz; Type: D750V3; Serial: D750V3 - SN:1230

Communication System: UID 0 - CW; Frequency: 750 MHz

Medium parameters used: $f = 750$ MHz; $\sigma = 0.9$ S/m; $\epsilon_r = 41$; $\rho = 1000$ kg/m³

Phantom section: Flat Section

Measurement Standard: DASY5 (IEEE/IEC/ANSI C63.19-2011)

DASY52 Configuration:

- Probe: EX3DV4 - SN7349; ConvF(10.11, 10.11, 10.11) @ 750 MHz; Calibrated: 10.01.2023
- Sensor-Surface: 1.4mm (Mechanical Surface Detection)
- Electronics: DAE4 Sn601; Calibrated: 19.12.2022
- Phantom: Flat Phantom 4.9 (front); Type: QD 00L P49 AA; Serial: 1001
- DASY52 52.10.4(1535); SEMCAD X 14.6.14(7501)

Dipole Calibration for Head Tissue/Pin=250 mW, d=15mm/Zoom Scan (7x7x7)/Cube 0:

Measurement grid: dx=5mm, dy=5mm, dz=5mm

Reference Value = 60.71 V/m; Power Drift = -0.03 dB

Peak SAR (extrapolated) = 3.26 W/kg

SAR(1 g) = 2.15 W/kg; SAR(10 g) = 1.4 W/kg

Smallest distance from peaks to all points 3 dB below = 21.2 mm

Ratio of SAR at M2 to SAR at M1 = 65.7%

Maximum value of SAR (measured) = 2.90 W/kg

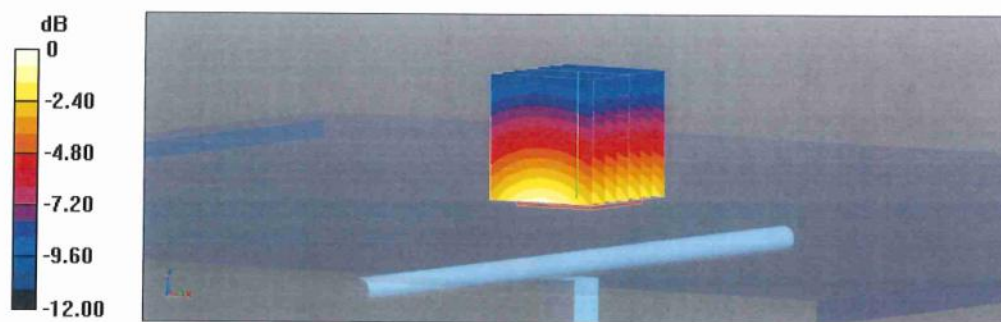

Impedance Measurement Plot for Head TSL

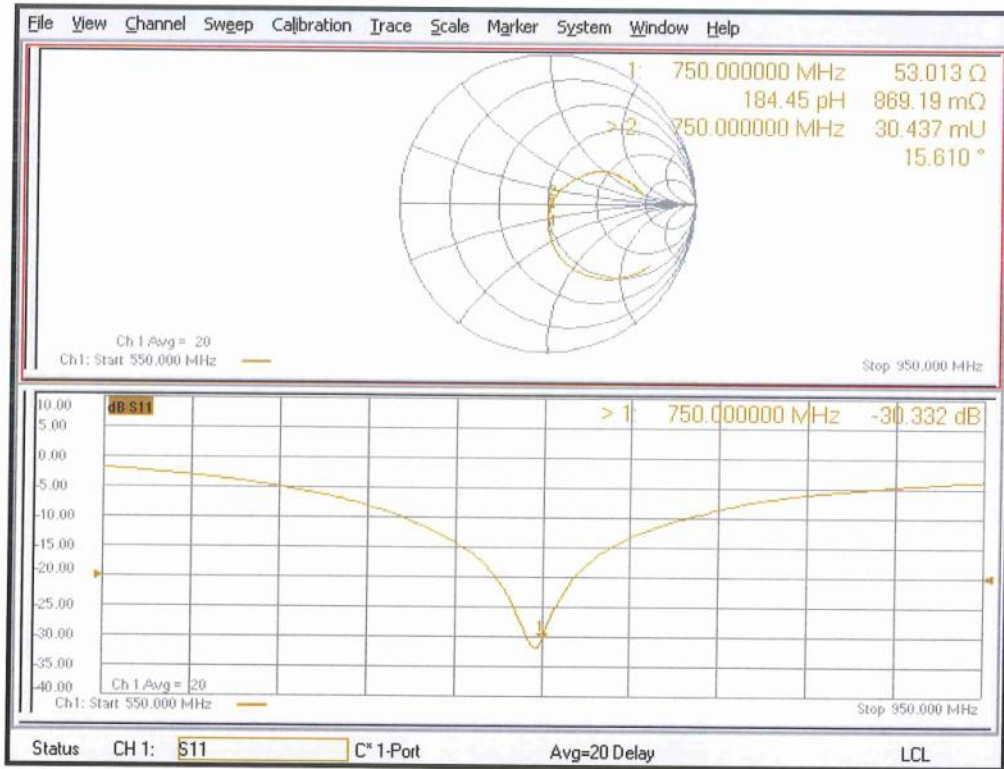

**Calibration Laboratory of
Schmid & Partner
Engineering AG**
Zeughausstrasse 43, 8004 Zurich, Switzerland



S Schweizerischer Kalibrierdienst
C Service suisse d'étalonnage
S Servizio svizzero di taratura
S Swiss Calibration Service

Accredited by the Swiss Accreditation Service (SAS)
The Swiss Accreditation Service is one of the signatories to the EA
Multilateral Agreement for the recognition of calibration certificates

Accreditation No.: **SCS 0108**

Client **BACL**
Sunnyvale USA

Certificate No. **D1750V2-1200_Mar23**

CALIBRATION CERTIFICATE

Object **D1750V2 - SN:1200**

Calibration procedure(s) **QA CAL-05.v12
Calibration Procedure for SAR Validation Sources between 0.7-3 GHz**

Calibration date: **March 27, 2023**

This calibration certificate documents the traceability to national standards, which realize the physical units of measurements (SI).
The measurements and the uncertainties with confidence probability are given on the following pages and are part of the certificate.

All calibrations have been conducted in the closed laboratory facility: environment temperature (22 ± 3)°C and humidity < 70%.

Calibration Equipment used (M&TE critical for calibration)

| Primary Standards | ID # | Cal Date (Certificate No.) | Scheduled Calibration |
|-----------------------------|--------------------|---------------------------------|-----------------------|
| Power meter NRP | SN: 104778 | 04-Apr-22 (No. 217-03525/03524) | Apr-23 |
| Power sensor NRP-Z91 | SN: 103244 | 04-Apr-22 (No. 217-03524) | Apr-23 |
| Power sensor NRP-Z91 | SN: 103245 | 04-Apr-22 (No. 217-03525) | Apr-23 |
| Reference 20 dB Attenuator | SN: BH9394 (20k) | 04-Apr-22 (No. 217-03527) | Apr-23 |
| Type-N mismatch combination | SN: 310982 / 06327 | 04-Apr-22 (No. 217-03528) | Apr-23 |
| Reference Probe EX3DV4 | SN: 7349 | 10-Jan-23 (No. EX3-7349_Jan23) | Jan-24 |
| DAE4 | SN: 601 | 19-Dec-22 (No. DAE4-601_Dec22) | Dec-23 |

| Secondary Standards | ID # | Check Date (in house) | Scheduled Check |
|---------------------------------|----------------|-----------------------------------|------------------------|
| Power meter E4419B | SN: GB39512475 | 30-Oct-14 (in house check Oct-22) | In house check: Oct-24 |
| Power sensor HP 8481A | SN: US37292783 | 07-Oct-15 (in house check Oct-22) | In house check: Oct-24 |
| Power sensor HP 8481A | SN: MY41093315 | 07-Oct-15 (in house check Oct-22) | In house check: Oct-24 |
| RF generator R&S SMT-06 | SN: 100972 | 15-Jun-15 (in house check Oct-22) | In house check: Oct-24 |
| Network Analyzer Agilent E8358A | SN: US41080477 | 31-Mar-14 (in house check Oct-22) | In house check: Oct-24 |

| | | | |
|----------------|---------------------------|-----------------------------------|---------------|
| Calibrated by: | Name Paulo Pina | Function Laboratory Technician | Signature |
| Approved by: | Name Sven Kühn | Function Technical Manager | Signature |

Issued: March 27, 2023

This calibration certificate shall not be reproduced except in full without written approval of the laboratory.

**Calibration Laboratory of
Schmid & Partner
Engineering AG**
Zeughausstrasse 43, 8004 Zurich, Switzerland



S Schweizerischer Kalibrierdienst
C Service suisse d'étalonnage
S Servizio svizzero di taratura
S Swiss Calibration Service

Accreditation No.: **SCS 0108**

Accredited by the Swiss Accreditation Service (SAS)

The Swiss Accreditation Service is one of the signatories to the EA
Multilateral Agreement for the recognition of calibration certificates

Glossary:

| | |
|-------|---------------------------------|
| TSL | tissue simulating liquid |
| ConvF | sensitivity in TSL / NORM x,y,z |
| N/A | not applicable or not measured |

Calibration is Performed According to the Following Standards:

- IEC/IEEE 62209-1528, "Measurement Procedure For The Assessment Of Specific Absorption Rate Of Human Exposure To Radio Frequency Fields From Hand-Held And Body-Worn Wireless Communication Devices - Part 1528: Human Models, Instrumentation And Procedures (Frequency Range of 4 MHz to 10 GHz)", October 2020.
- KDB 865664, "SAR Measurement Requirements for 100 MHz to 6 GHz"

Additional Documentation:

- DASY System Handbook

Methods Applied and Interpretation of Parameters:

- Measurement Conditions:* Further details are available from the Validation Report at the end of the certificate. All figures stated in the certificate are valid at the frequency indicated.
- Antenna Parameters with TSL:* The source is mounted in a touch configuration below the center marking of the flat phantom.
- Return Loss:* This parameter is measured with the source positioned under the liquid filled phantom (as described in the measurement condition clause). The Return Loss ensures low reflected power. No uncertainty required.
- SAR measured:* SAR measured at the stated antenna input power.
- SAR normalized:* SAR as measured, normalized to an input power of 1 W at the antenna connector.
- SAR for nominal TSL parameters:* The measured TSL parameters are used to calculate the nominal SAR result.

The reported uncertainty of measurement is stated as the standard uncertainty of measurement multiplied by the coverage factor $k=2$, which for a normal distribution corresponds to a coverage probability of approximately 95%.

Measurement Conditions

DASY system configuration, as far as not given on page 1.

| | | |
|------------------------------|------------------------|-------------|
| DASY Version | DASY52 | V52.10.4 |
| Extrapolation | Advanced Extrapolation | |
| Phantom | Modular Flat Phantom | |
| Distance Dipole Center - TSL | 10 mm | with Spacer |
| Zoom Scan Resolution | dx, dy, dz = 5 mm | |
| Frequency | 1750 MHz \pm 1 MHz | |

Head TSL parameters

The following parameters and calculations were applied.

| | Temperature | Permittivity | Conductivity |
|---|---------------------|----------------|----------------------|
| Nominal Head TSL parameters | 22.0 °C | 40.1 | 1.37 mho/m |
| Measured Head TSL parameters | (22.0 \pm 0.2) °C | 38.8 \pm 6 % | 1.33 mho/m \pm 6 % |
| Head TSL temperature change during test | < 0.5 °C | ---- | ---- |

SAR result with Head TSL

| SAR averaged over 1 cm ³ (1 g) of Head TSL | Condition | |
|---|--------------------|--|
| SAR measured | 250 mW input power | 8.85 W/kg |
| SAR for nominal Head TSL parameters | normalized to 1W | 35.8 W/kg \pm 17.0 % (k=2) |

| SAR averaged over 10 cm ³ (10 g) of Head TSL | condition | |
|---|--------------------|--|
| SAR measured | 250 mW input power | 4.67 W/kg |
| SAR for nominal Head TSL parameters | normalized to 1W | 18.8 W/kg \pm 16.5 % (k=2) |

Appendix (Additional assessments outside the scope of SCS 0108)

Antenna Parameters with Head TSL

| | |
|--------------------------------------|-----------------------------|
| Impedance, transformed to feed point | $46.9 \Omega + 3.1 j\Omega$ |
| Return Loss | - 27.0 dB |

General Antenna Parameters and Design

| | |
|----------------------------------|----------|
| Electrical Delay (one direction) | 1.209 ns |
|----------------------------------|----------|

After long term use with 100W radiated power, only a slight warming of the dipole near the feedpoint can be measured.

The dipole is made of standard semirigid coaxial cable. The center conductor of the feeding line is directly connected to the second arm of the dipole. The antenna is therefore short-circuited for DC-signals. On some of the dipoles, small end caps are added to the dipole arms in order to improve matching when loaded according to the position as explained in the "Measurement Conditions" paragraph. The SAR data are not affected by this change. The overall dipole length is still according to the Standard.

No excessive force must be applied to the dipole arms, because they might bend or the soldered connections near the feedpoint may be damaged.

Additional EUT Data

| | |
|-----------------|-------|
| Manufactured by | SPEAG |
|-----------------|-------|

DASY5 Validation Report for Head TSL

Date: 27.03.2023

Test Laboratory: SPEAG, Zurich, Switzerland

DUT: Dipole 1750 MHz; Type: D1750V2; Serial: D1750V2 - SN:1200

Communication System: UID 0 - CW; Frequency: 1750 MHz

Medium parameters used: $f = 1750$ MHz; $\sigma = 1.33$ S/m; $\epsilon_r = 38.8$; $\rho = 1000$ kg/m³

Phantom section: Flat Section

Measurement Standard: DASY5 (IEEE/IEC/ANSI C63.19-2011)

DASY52 Configuration:

- Probe: EX3DV4 - SN7349; ConvF(8.67, 8.67, 8.67) @ 1750 MHz; Calibrated: 10.01.2023
- Sensor-Surface: 1.4mm (Mechanical Surface Detection)
- Electronics: DAE4 Sn601; Calibrated: 19.12.2022
- Phantom: Flat Phantom 5.0 (front); Type: QD 000 P50 AA; Serial: 1001
- DASY52 52.10.4(1535); SEMCAD X 14.6.14(7501)

Dipole Calibration for Head Tissue/Pin=250 mW, d=10mm/Zoom Scan (7x7x7)/Cube 0:

Measurement grid: dx=5mm, dy=5mm, dz=5mm

Reference Value = 104.6 V/m; Power Drift = 0.01 dB

Peak SAR (extrapolated) = 16.3 W/kg

SAR(1 g) = 8.85 W/kg; SAR(10 g) = 4.67 W/kg

Smallest distance from peaks to all points 3 dB below = 10.4 mm

Ratio of SAR at M2 to SAR at M1 = 54.4%

Maximum value of SAR (measured) = 13.7 W/kg

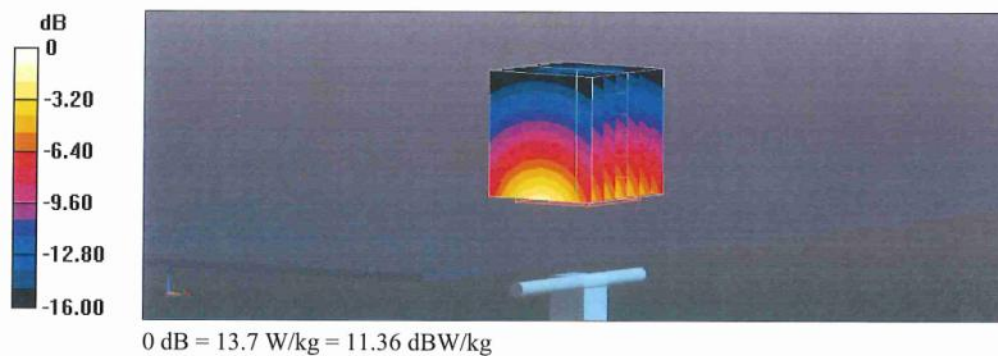

Impedance Measurement Plot for Head TSL

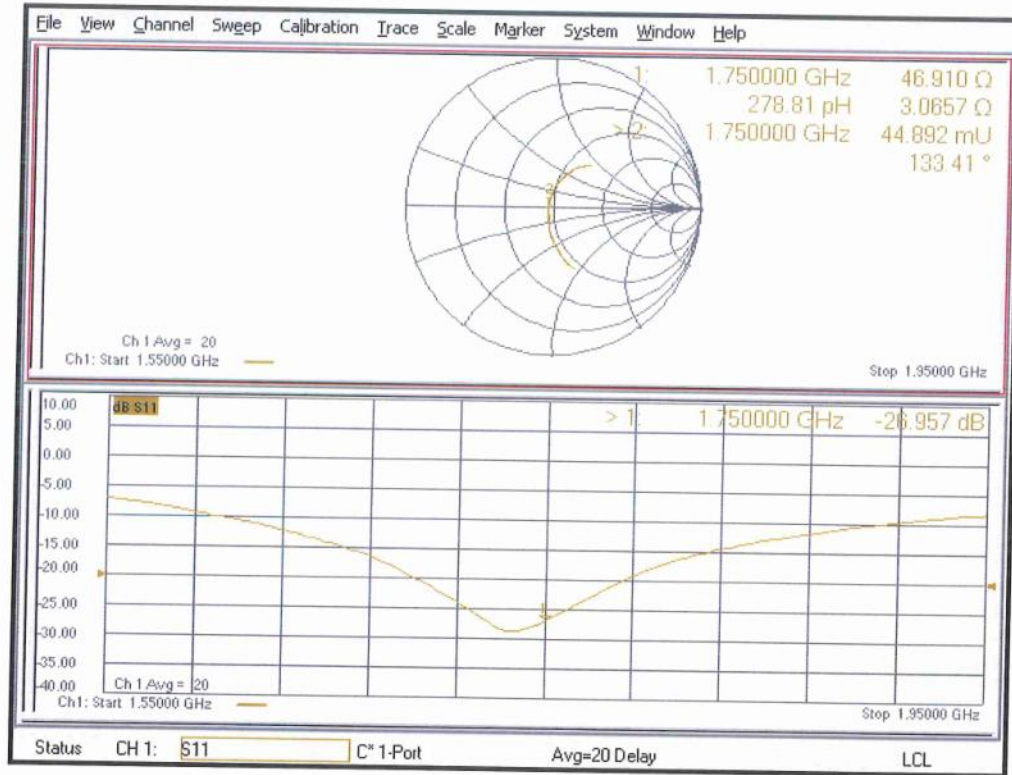

**Calibration Laboratory of
Schmid & Partner
Engineering AG**
Zeughausstrasse 43, 8004 Zurich, Switzerland



S Schweizerischer Kalibrierdienst
C Service suisse d'étalonnage
S Servizio svizzero di taratura
S Swiss Calibration Service

Accredited by the Swiss Accreditation Service (SAS)
The Swiss Accreditation Service is one of the signatories to the EA
Multilateral Agreement for the recognition of calibration certificates

Accreditation No.: **SCS 0108**

Client **BACL**
Sunnyvale, USA

Certificate No. **D1900V2-5d251_Mar23**

CALIBRATION CERTIFICATE

Object **D1900V2 - SN:5d251**

Calibration procedure(s) **QA CAL-05.v12
Calibration Procedure for SAR Validation Sources between 0.7-3 GHz**

Calibration date: **March 27, 2023**

This calibration certificate documents the traceability to national standards, which realize the physical units of measurements (SI).
The measurements and the uncertainties with confidence probability are given on the following pages and are part of the certificate.

All calibrations have been conducted in the closed laboratory facility: environment temperature (22 ± 3)°C and humidity < 70%.

Calibration Equipment used (M&TE critical for calibration)

| Primary Standards | ID # | Cal Date (Certificate No.) | Scheduled Calibration |
|---------------------------------|--------------------|-----------------------------------|------------------------|
| Power meter NRP | SN: 104778 | 04-Apr-22 (No. 217-03525/03524) | Apr-23 |
| Power sensor NRP-Z91 | SN: 103244 | 04-Apr-22 (No. 217-03524) | Apr-23 |
| Power sensor NRP-Z91 | SN: 103245 | 04-Apr-22 (No. 217-03525) | Apr-23 |
| Reference 20 dB Attenuator | SN: BH9394 (20k) | 04-Apr-22 (No. 217-03527) | Apr-23 |
| Type-N mismatch combination | SN: 310982 / 06327 | 04-Apr-22 (No. 217-03528) | Apr-23 |
| Reference Probe EX3DV4 | SN: 7349 | 10-Jan-23 (No. EX3-7349_Jan23) | Jan-24 |
| DAE4 | SN: 601 | 19-Dec-22 (No. DAE4-601_Dec22) | Dec-23 |
| Secondary Standards | ID # | Check Date (in house) | Scheduled Check |
| Power meter E4419B | SN: GB39512475 | 30-Oct-14 (in house check Oct-22) | In house check: Oct-24 |
| Power sensor HP 8481A | SN: US37292783 | 07-Oct-15 (in house check Oct-22) | In house check: Oct-24 |
| Power sensor HP 8481A | SN: MY41093315 | 07-Oct-15 (in house check Oct-22) | In house check: Oct-24 |
| RF generator R&S SMT-06 | SN: 100972 | 15-Jun-15 (in house check Oct-22) | In house check: Oct-24 |
| Network Analyzer Agilent E8358A | SN: US41080477 | 31-Mar-14 (in house check Oct-22) | In house check: Oct-24 |

| | | | |
|----------------|------------------------|-----------------------------------|---------------|
| Calibrated by: | Name Jeton Kastrati | Function Laboratory Technician | Signature |
| Approved by: | Name Sven Kühn | Function Technical Manager | Signature |

Issued: March 27, 2023

This calibration certificate shall not be reproduced except in full without written approval of the laboratory.

**Calibration Laboratory of
Schmid & Partner
Engineering AG**
Zeughausstrasse 43, 8004 Zurich, Switzerland



S Schweizerischer Kalibrierdienst
C Service suisse d'étalonnage
S Servizio svizzero di taratura
S Swiss Calibration Service

Accreditation No.: **SCS 0108**

Accredited by the Swiss Accreditation Service (SAS)
The Swiss Accreditation Service is one of the signatories to the EA
Multilateral Agreement for the recognition of calibration certificates

Glossary:

| | |
|-------|---------------------------------|
| TSL | tissue simulating liquid |
| ConvF | sensitivity in TSL / NORM x,y,z |
| N/A | not applicable or not measured |

Calibration is Performed According to the Following Standards:

- a) IEC/IEEE 62209-1528, "Measurement Procedure For The Assessment Of Specific Absorption Rate Of Human Exposure To Radio Frequency Fields From Hand-Held And Body-Worn Wireless Communication Devices - Part 1528: Human Models, Instrumentation And Procedures (Frequency Range of 4 MHz to 10 GHz)", October 2020.
- b) KDB 865664, "SAR Measurement Requirements for 100 MHz to 6 GHz"

Additional Documentation:

- c) DASY System Handbook

Methods Applied and Interpretation of Parameters:

- *Measurement Conditions:* Further details are available from the Validation Report at the end of the certificate. All figures stated in the certificate are valid at the frequency indicated.
- *Antenna Parameters with TSL:* The source is mounted in a touch configuration below the center marking of the flat phantom.
- *Return Loss:* This parameter is measured with the source positioned under the liquid filled phantom (as described in the measurement condition clause). The Return Loss ensures low reflected power. No uncertainty required.
- *SAR measured:* SAR measured at the stated antenna input power.
- *SAR normalized:* SAR as measured, normalized to an input power of 1 W at the antenna connector.
- *SAR for nominal TSL parameters:* The measured TSL parameters are used to calculate the nominal SAR result.

The reported uncertainty of measurement is stated as the standard uncertainty of measurement multiplied by the coverage factor $k=2$, which for a normal distribution corresponds to a coverage probability of approximately 95%.

Measurement Conditions

DASY system configuration, as far as not given on page 1.

| | | |
|------------------------------|------------------------|-------------|
| DASY Version | DASY52 | V52.10.4 |
| Extrapolation | Advanced Extrapolation | |
| Phantom | Modular Flat Phantom | |
| Distance Dipole Center - TSL | 10 mm | with Spacer |
| Zoom Scan Resolution | dx, dy, dz = 5 mm | |
| Frequency | 1900 MHz \pm 1 MHz | |

Head TSL parameters

The following parameters and calculations were applied.

| | Temperature | Permittivity | Conductivity |
|---|---------------------|----------------|----------------------|
| Nominal Head TSL parameters | 22.0 °C | 40.0 | 1.40 mho/m |
| Measured Head TSL parameters | (22.0 \pm 0.2) °C | 39.0 \pm 6 % | 1.36 mho/m \pm 6 % |
| Head TSL temperature change during test | < 0.5 °C | ---- | ---- |

SAR result with Head TSL

| SAR averaged over 1 cm ³ (1 g) of Head TSL | Condition | |
|---|--------------------|--|
| SAR measured | 250 mW input power | 9.61 W/kg |
| SAR for nominal Head TSL parameters | normalized to 1W | 38.9 W/kg \pm 17.0 % (k=2) |

| SAR averaged over 10 cm ³ (10 g) of Head TSL | condition | |
|---|--------------------|--|
| SAR measured | 250 mW input power | 5.04 W/kg |
| SAR for nominal Head TSL parameters | normalized to 1W | 20.3 W/kg \pm 16.5 % (k=2) |

Appendix (Additional assessments outside the scope of SCS 0108)

Antenna Parameters with Head TSL

| | |
|--------------------------------------|-----------------------------|
| Impedance, transformed to feed point | $49.5 \Omega + 6.5 j\Omega$ |
| Return Loss | - 23.7 dB |

General Antenna Parameters and Design

| | |
|----------------------------------|----------|
| Electrical Delay (one direction) | 1.191 ns |
|----------------------------------|----------|

After long term use with 100W radiated power, only a slight warming of the dipole near the feedpoint can be measured.

The dipole is made of standard semirigid coaxial cable. The center conductor of the feeding line is directly connected to the second arm of the dipole. The antenna is therefore short-circuited for DC-signals. On some of the dipoles, small end caps are added to the dipole arms in order to improve matching when loaded according to the position as explained in the "Measurement Conditions" paragraph. The SAR data are not affected by this change. The overall dipole length is still according to the Standard.

No excessive force must be applied to the dipole arms, because they might bend or the soldered connections near the feedpoint may be damaged.

Additional EUT Data

| | |
|-----------------|-------|
| Manufactured by | SPEAG |
|-----------------|-------|

DASY5 Validation Report for Head TSL

Date: 27.03.2023

Test Laboratory: SPEAG, Zurich, Switzerland

DUT: Dipole 1900 MHz; Type: D1900V2; Serial: D1900V2 - SN:5d251

Communication System: UID 0 - CW; Frequency: 1900 MHz

Medium parameters used: $f = 1900$ MHz; $\sigma = 1.36$ S/m; $\epsilon_r = 39$; $\rho = 1000$ kg/m³

Phantom section: Flat Section

Measurement Standard: DASY5 (IEEE/IEC/ANSI C63.19-2011)

DASY52 Configuration:

- Probe: EX3DV4 - SN7349; ConvF(8.35, 8.35, 8.35) @ 1900 MHz; Calibrated: 10.01.2023
- Sensor-Surface: 1.4mm (Mechanical Surface Detection)
- Electronics: DAE4 Sn601; Calibrated: 19.12.2022
- Phantom: Flat Phantom 5.0 (front); Type: QD 000 P50 AA; Serial: 1001
- DASY52 52.10.4(1535); SEMCAD X 14.6.14(7501)

Dipole Calibration for Head Tissue/Pin=250 mW, d=10mm/Zoom Scan (7x7x7)/Cube 0:

Measurement grid: dx=5mm, dy=5mm, dz=5mm

Reference Value = 108.9 V/m; Power Drift = -0.01 dB

Peak SAR (extrapolated) = 17.4 W/kg

SAR(1 g) = 9.61 W/kg; SAR(10 g) = 5.04 W/kg

Smallest distance from peaks to all points 3 dB below = 10 mm

Ratio of SAR at M2 to SAR at M1 = 55.4%

Maximum value of SAR (measured) = 14.8 W/kg

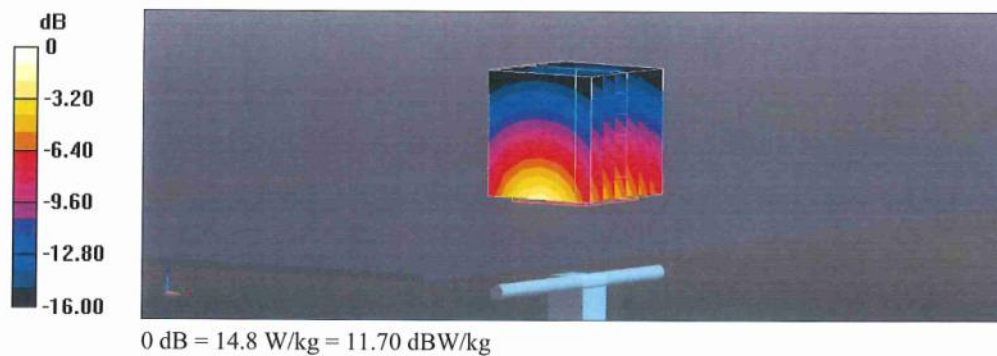

Impedance Measurement Plot for Head TSL

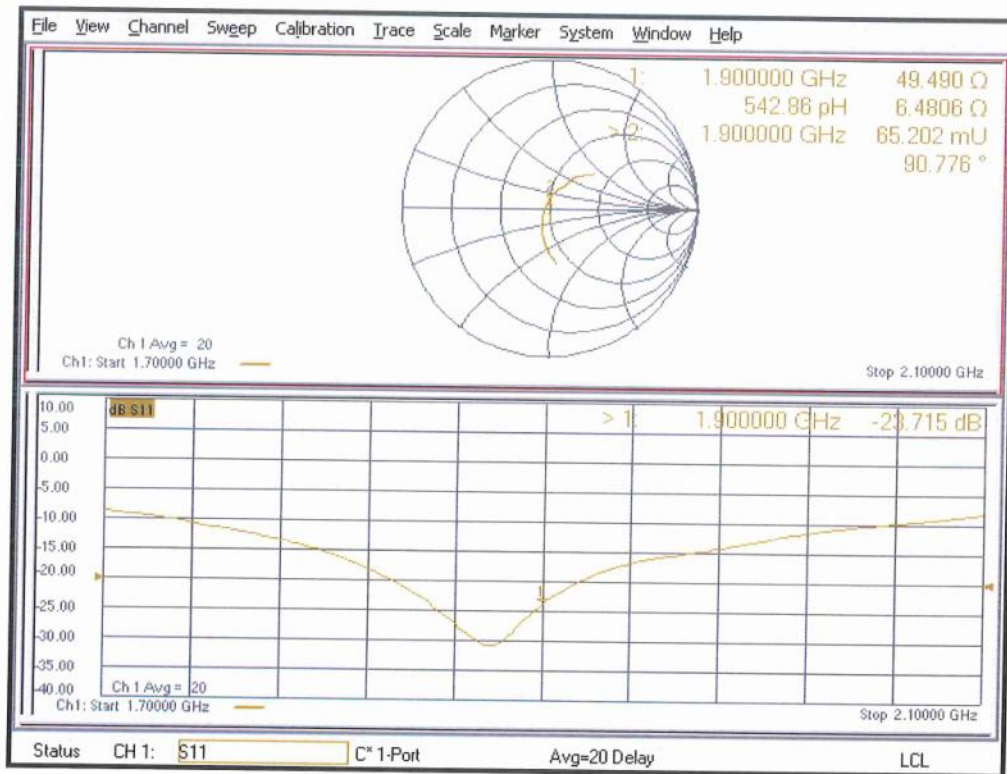

**Calibration Laboratory of
Schmid & Partner
Engineering AG**
Zeughausstrasse 43, 8004 Zurich, Switzerland



S Schweizerischer Kalibrierdienst
C Service suisse d'étalonnage
S Servizio svizzero di taratura
S Swiss Calibration Service

Accredited by the Swiss Accreditation Service (SAS)
The Swiss Accreditation Service is one of the signatories to the EA
Multilateral Agreement for the recognition of calibration certificates

Accreditation No.: **SCS 0108**

Client **BACL**
Sunnyvale, USA

Certificate No. **D2450V2-1102_Mar23**

CALIBRATION CERTIFICATE

Object **D2450V2 - SN:1102**

Calibration procedure(s) **QA CAL-05.v12
Calibration Procedure for SAR Validation Sources between 0.7-3 GHz**

Calibration date: **March 27, 2023**

This calibration certificate documents the traceability to national standards, which realize the physical units of measurements (SI).
The measurements and the uncertainties with confidence probability are given on the following pages and are part of the certificate.

All calibrations have been conducted in the closed laboratory facility: environment temperature (22 ± 3)°C and humidity < 70%.

Calibration Equipment used (M&TE critical for calibration)

| Primary Standards | ID # | Cal Date (Certificate No.) | Scheduled Calibration |
|-----------------------------|--------------------|---------------------------------|-----------------------|
| Power meter NRP | SN: 104778 | 04-Apr-22 (No. 217-03525/03524) | Apr-23 |
| Power sensor NRP-Z91 | SN: 103244 | 04-Apr-22 (No. 217-03524) | Apr-23 |
| Power sensor NRP-Z91 | SN: 103245 | 04-Apr-22 (No. 217-03525) | Apr-23 |
| Reference 20 dB Attenuator | SN: BH9394 (20k) | 04-Apr-22 (No. 217-03527) | Apr-23 |
| Type-N mismatch combination | SN: 310982 / 06327 | 04-Apr-22 (No. 217-03528) | Apr-23 |
| Reference Probe EX3DV4 | SN: 7349 | 10-Jan-23 (No. EX3-7349_Jan23) | Jan-24 |
| DAE4 | SN: 601 | 19-Dec-22 (No. DAE4-601_Dec22) | Dec-23 |

| Secondary Standards | ID # | Check Date (in house) | Scheduled Check |
|---------------------------------|----------------|-----------------------------------|------------------------|
| Power meter E4419B | SN: GB39512475 | 30-Oct-14 (in house check Oct-22) | In house check: Oct-24 |
| Power sensor HP 8481A | SN: US37292783 | 07-Oct-15 (in house check Oct-22) | In house check: Oct-24 |
| Power sensor HP 8481A | SN: MY41093315 | 07-Oct-15 (in house check Oct-22) | In house check: Oct-24 |
| RF generator R&S SMT-06 | SN: 100972 | 15-Jun-15 (in house check Oct-22) | In house check: Oct-24 |
| Network Analyzer Agilent E8358A | SN: US41080477 | 31-Mar-14 (in house check Oct-22) | In house check: Oct-24 |

| | Name | Function | Signature |
|----------------|----------------|-----------------------|-----------|
| Calibrated by: | Jeton Kastrati | Laboratory Technician | |
| Approved by: | Sven Kühn | Technical Manager | |

Issued: March 27, 2023

This calibration certificate shall not be reproduced except in full without written approval of the laboratory.

**Calibration Laboratory of
Schmid & Partner
Engineering AG**
Zeughausstrasse 43, 8004 Zurich, Switzerland



S Schweizerischer Kalibrierdienst
C Service suisse d'étalonnage
S Servizio svizzero di taratura
S Swiss Calibration Service

Accreditation No.: **SCS 0108**

Accredited by the Swiss Accreditation Service (SAS)

The Swiss Accreditation Service is one of the signatories to the EA
Multilateral Agreement for the recognition of calibration certificates

Glossary:

| | |
|-------|---------------------------------|
| TSL | tissue simulating liquid |
| ConvF | sensitivity in TSL / NORM x,y,z |
| N/A | not applicable or not measured |

Calibration is Performed According to the Following Standards:

- a) IEC/IEEE 62209-1528, "Measurement Procedure For The Assessment Of Specific Absorption Rate Of Human Exposure To Radio Frequency Fields From Hand-Held And Body-Worn Wireless Communication Devices - Part 1528: Human Models, Instrumentation And Procedures (Frequency Range of 4 MHz to 10 GHz)", October 2020.
- b) KDB 865664, "SAR Measurement Requirements for 100 MHz to 6 GHz"

Additional Documentation:

- c) DASYS System Handbook

Methods Applied and Interpretation of Parameters:

- *Measurement Conditions:* Further details are available from the Validation Report at the end of the certificate. All figures stated in the certificate are valid at the frequency indicated.
- *Antenna Parameters with TSL:* The source is mounted in a touch configuration below the center marking of the flat phantom.
- *Return Loss:* This parameter is measured with the source positioned under the liquid filled phantom (as described in the measurement condition clause). The Return Loss ensures low reflected power. No uncertainty required.
- *SAR measured:* SAR measured at the stated antenna input power.
- *SAR normalized:* SAR as measured, normalized to an input power of 1 W at the antenna connector.
- *SAR for nominal TSL parameters:* The measured TSL parameters are used to calculate the nominal SAR result.

The reported uncertainty of measurement is stated as the standard uncertainty of measurement multiplied by the coverage factor $k=2$, which for a normal distribution corresponds to a coverage probability of approximately 95%.

Measurement Conditions

DASY system configuration, as far as not given on page 1.

| | | |
|------------------------------|------------------------|-------------|
| DASY Version | DASY52 | V52.10.4 |
| Extrapolation | Advanced Extrapolation | |
| Phantom | Modular Flat Phantom | |
| Distance Dipole Center - TSL | 10 mm | with Spacer |
| Zoom Scan Resolution | dx, dy, dz = 5 mm | |
| Frequency | 2450 MHz \pm 1 MHz | |

Head TSL parameters

The following parameters and calculations were applied.

| | Temperature | Permittivity | Conductivity |
|---|---------------------|----------------|----------------------|
| Nominal Head TSL parameters | 22.0 °C | 39.2 | 1.80 mho/m |
| Measured Head TSL parameters | (22.0 \pm 0.2) °C | 38.0 \pm 6 % | 1.81 mho/m \pm 6 % |
| Head TSL temperature change during test | < 0.5 °C | ---- | ---- |

SAR result with Head TSL

| SAR averaged over 1 cm ³ (1 g) of Head TSL | Condition | |
|---|--------------------|--|
| SAR measured | 250 mW input power | 12.9 W/kg |
| SAR for nominal Head TSL parameters | normalized to 1W | 50.9 W/kg \pm 17.0 % (k=2) |

| SAR averaged over 10 cm ³ (10 g) of Head TSL | condition | |
|---|--------------------|--|
| SAR measured | 250 mW input power | 6.07 W/kg |
| SAR for nominal Head TSL parameters | normalized to 1W | 24.1 W/kg \pm 16.5 % (k=2) |

Appendix (Additional assessments outside the scope of SCS 0108)

Antenna Parameters with Head TSL

| | |
|--------------------------------------|--------------------------------|
| Impedance, transformed to feed point | 53.9 Ω + 4.8 j Ω |
| Return Loss | - 24.6 dB |

General Antenna Parameters and Design

| | |
|----------------------------------|----------|
| Electrical Delay (one direction) | 1.155 ns |
|----------------------------------|----------|

After long term use with 100W radiated power, only a slight warming of the dipole near the feedpoint can be measured.

The dipole is made of standard semirigid coaxial cable. The center conductor of the feeding line is directly connected to the second arm of the dipole. The antenna is therefore short-circuited for DC-signals. On some of the dipoles, small end caps are added to the dipole arms in order to improve matching when loaded according to the position as explained in the "Measurement Conditions" paragraph. The SAR data are not affected by this change. The overall dipole length is still according to the Standard.

No excessive force must be applied to the dipole arms, because they might bend or the soldered connections near the feedpoint may be damaged.

Additional EUT Data

| | |
|-----------------|-------|
| Manufactured by | SPEAG |
|-----------------|-------|

DASY5 Validation Report for Head TSL

Date: 27.03.2023

Test Laboratory: SPEAG, Zurich, Switzerland

DUT: Dipole 2450 MHz; Type: D2450V2; Serial: D2450V2 - SN:1102

Communication System: UID 0 - CW; Frequency: 2450 MHz

Medium parameters used: $f = 2450$ MHz; $\sigma = 1.81$ S/m; $\epsilon_r = 38$; $\rho = 1000$ kg/m³

Phantom section: Flat Section

Measurement Standard: DASY5 (IEEE/IEC/ANSI C63.19-2011)

DASY52 Configuration:

- Probe: EX3DV4 - SN7349; ConvF(7.88, 7.88, 7.88) @ 2450 MHz; Calibrated: 10.01.2023
- Sensor-Surface: 1.4mm (Mechanical Surface Detection)
- Electronics: DAE4 Sn601; Calibrated: 19.12.2022
- Phantom: Flat Phantom 5.0 (front); Type: QD 000 P50 AA; Serial: 1001
- DASY52 52.10.4(1535); SEMCAD X 14.6.14(7501)

Dipole Calibration for Head Tissue/Pin=250 mW, d=10mm/Zoom Scan (7x7x7)/Cube 0:

Measurement grid: dx=5mm, dy=5mm, dz=5mm

Reference Value = 115.0 V/m; Power Drift = -0.01 dB

Peak SAR (extrapolated) = 24.7 W/kg

SAR(1 g) = 12.9 W/kg; SAR(10 g) = 6.07 W/kg

Smallest distance from peaks to all points 3 dB below = 9 mm

Ratio of SAR at M2 to SAR at M1 = 51.9%

Maximum value of SAR (measured) = 20.7 W/kg

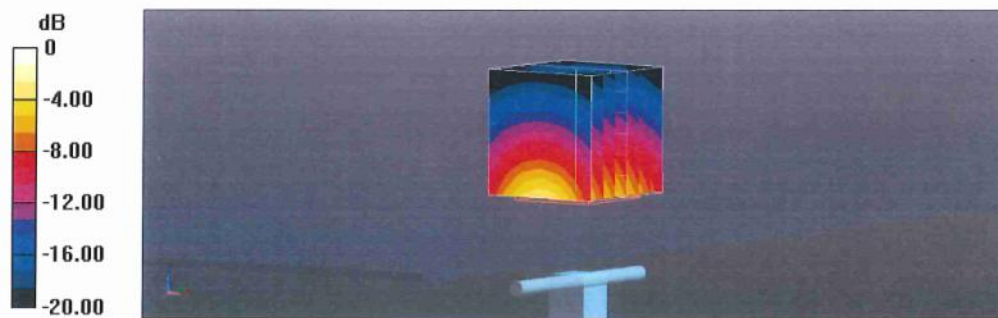

0 dB = 20.7 W/kg = 13.16 dBW/kg

Impedance Measurement Plot for Head TSL

