



中认信通

CHINA CERTIFICATION ICT CO., LTD (DONGGUAN)



TEST REPORT

Applicant: Shenzhen Youmi Intelligent Technology Co., Ltd

Address: 406-407 Jinqi Zhigu Building, 4/F, 1 Tangling Road, Nanshan District, Shenzhen City, China

FCC ID: 2ATZ4-A15UPG

IC: 26074-A15UPG

HVIN: HCT-V9000MB-A

Product Name: Smart phone

Standard(s): 47 CFR Part 15, Subpart E(15.407)
RSS-247 Issue 2, February 2017
RSS-Gen, Issue 5, February 2021 Amendment 2
ANSI C63.10-2013
KDB 789033 D02 General U-NII Test Procedures New Rules v02r01

The above equipment has been tested and found compliant with the requirement of the relative standards by China Certification ICT Co., Ltd (Dongguan)

Report Number: CR230745207-00D

Date Of Issue: 2023/10/30

Reviewed By: Julie Tan
Title: RF Engineer

Julie Tan

Approved By: Sun Zhong
Title: Manager

Sun Zhong

Test Laboratory: China Certification ICT Co., Ltd (Dongguan)

No. 113, Pingkang Road, Dalang Town, Dongguan,
Guangdong, China
Tel: +86-769-82016888

Test Facility

The Test site used by China Certification ICT Co., Ltd (Dongguan) to collect test data is located on the No. 113, Pingkang Road, Dalang Town, Dongguan, Guangdong, China.

The lab has been recognized as the FCC accredited lab under the KDB 974614 D01 and is listed in the FCC Public Access Link (PAL) database, FCC Registration No. : 442868, the FCC Designation No. : CN1314.

The lab has been recognized by Innovation, Science and Economic Development Canada to test to Canadian radio equipment requirements, the CAB identifier: CN0123.

Declarations

China Certification ICT Co., Ltd (Dongguan) is not responsible for the authenticity of any test data provided by the applicant. Data included from the applicant that may affect test results are marked with a triangle symbol “▲”. Customer model name, addresses, names, trademarks etc. are not considered data.

Unless otherwise stated the results shown in this test report refer only to the sample(s) tested.

This report cannot be reproduced except in full, without prior written approval of the Company.

This report is valid only with a valid digital signature. The digital signature may be available only under the Adobe software above version 7.0.

This report may contain data that are not covered by the accreditation scope and shall be marked with an asterisk “★”.

CONTENTS

TEST FACILITY	2
DECLARATIONS.....	2
DOCUMENT REVISION HISTORY	5
1. GENERAL INFORMATION	6
1.1 PRODUCT DESCRIPTION FOR EQUIPMENT UNDER TEST (EUT)	6
1.2 DESCRIPTION OF TEST CONFIGURATION.....	8
1.2.1 EUT Operation Condition:	8
1.2.2 Support Equipment List and Details	8
1.2.3 Support Cable List and Details	8
1.2.4 Block Diagram of Test Setup.....	9
1.3 MEASUREMENT UNCERTAINTY	11
2. SUMMARY OF TEST RESULTS	12
3. REQUIREMENTS AND TEST PROCEDURES	13
3.1 AC LINE CONDUCTED EMISSIONS.....	13
3.1.1 Applicable Standard.....	13
3.1.2 EUT Setup.....	14
3.1.3 EMI Test Receiver Setup	15
3.1.4 Test Procedure	15
3.1.5 Corrected Amplitude & Margin Calculation.....	15
3.2 RADIATION SPURIOUS EMISSIONS.....	16
3.2.1 Applicable Standard.....	16
3.2.2 EUT Setup.....	18
3.2.3 EMI Test Receiver & Spectrum Analyzer Setup	18
3.2.4 Test Procedure	19
3.2.5 Corrected Amplitude & Margin Calculation.....	19
3.3 26dB ATTENUATED BELOW THE CHANNEL POWER.....	20
3.3.1 Applicable Standard.....	20
3.3.2 EUT Setup.....	20
3.3.3 Test Procedure	20
3.4 EMISSION BANDWIDTH.....	21
3.4.1 Applicable Standard.....	21
3.4.2 EUT Setup.....	22
3.4.3 Test Procedure	22
3.5 MAXIMUM CONDUCTED OUTPUT POWER.....	24
3.5.1 Applicable Standard.....	24
3.5.2 EUT Setup.....	25
3.5.3 Test Procedure	25
3.6 MAXIMUM POWER SPECTRAL DENSITY	26
3.6.1 Applicable Standard.....	26
3.6.2 EUT Setup.....	27
3.6.3 Test Procedure	27

3.7 DUTY CYCLE	28
3.7.1 EUT Setup.....	28
3.7.2 Test Procedure	28
3.8 TRANSMITTER FREQUENCY STABILITY	29
3.8.1 Applicable Standard.....	29
3.8.2 EUT Setup.....	29
3.8.3 Test Procedure	29
3.9 ANTENNA REQUIREMENT	31
3.9.1 Applicable Standard.....	31
3.9.2 Judgment.....	31
3.10 ADDITIONAL REQUIREMENT	32
3.10.1 Applicable Standard.....	32
3.10.2 Judgment.....	33
4. Test DATA AND RESULTS	34
4.1 AC LINE CONDUCTED EMISSIONS	34
4.2 RADIATION SPURIOUS EMISSIONS	37
4.3 26dB ATTENUATED BELOW THE CHANNEL POWER	47
4.4 EMISSION BANDWIDTH:	51
4.5 MAXIMUM CONDUCTED OUTPUT POWER:	65
4.6 MAXIMUM POWER SPECTRAL DENSITY:	67
4.7 DUTY CYCLE:	75
4.8 FREQUENCY STABILITY:	77
5. EUT PHOTOGRAPHS	79
6. TEST SETUP PHOTOGRAPHS	80

DOCUMENT REVISION HISTORY

Revision Number	Report Number	Description of Revision	Date of Revision
1.0	CR230745207-00D	Original Report	2023/10/30

1. GENERAL INFORMATION

1.1 Product Description for Equipment under Test (EUT)

EUT Name:	Smart phone
EUT Model:	MP32
Operation Frequency:	5180-5240 MHz (802.11a/n ht20/ac vht20) 5190-5230 MHz(802.11n ht40/ac vht40) 5210MHz(802.11ac vht80) 5745-5825 MHz (802.11a/n ht20/ac vht20) 5755-5795 MHz(802.11n ht40/ac vht40) 5775MHz(802.11ac vht80)
Maximum Average Output Power (Conducted):	14.35dBm (5150-5250 MHz) 14.28dBm (5725-5850 MHz)
Modulation Type:	802.11a/n/ac: OFDM-BPSK, QPSK, 16QAM, 64QAM, 256QAM
Rated Input Voltage:	DC 5V or 9V or 12V or 15V or 20V or 11V from adapter or DC 3.87V from battery
Serial Number:	29L3-4(for Radiated Spurious Emissions test) 29L3-1(for AC line conducted emissions and RF Conducted test)
EUT Received Date:	2023/8/14
EUT Received Status:	Good

1.1.2 Operation Frequency Detail: For 802.11a/n ht20/ac vht20:

5150-5250MHz Band		5725-5850MHz Band	
Channel	Frequency (MHz)	Channel	Frequency (MHz)
36	5180	149	5745
40	5200	153	5765
44	5220	157	5785
48	5240	161	5805
/	/	165	5825
Per section 15.31(m), the below frequencies were performed the test as below:			
36	5180	149	5745
40	5200	157	5785
48	5240	165	5825

For 802.11n ht40/ac vht40:

5150-5250MHz Band		5725-5850MHz Band	
Channel	Frequency (MHz)	Channel	Frequency (MHz)
38	5190	151	5755
46	5230	159	5795
Per section 15.31(m), the below frequencies were performed the test as below:			
38	5190	151	5755
46	5230	159	5795

For 802.11ac vht80:

5150-5250MHz Band		5725-5850MHz Band	
Channel	Frequency (MHz)	Channel	Frequency (MHz)
42	5210	155	5775
Per section 15.31(m), the below frequencies were performed the test as below:			
42	5210	155	5775

1.1.3 Antenna Information Detail▲:

Antenna Manufacturer	Antenna Type	input impedance (Ohm)	Frequency Range	Antenna Gain
ANWEI communication Equipment Co.,Ltd	FPC	50	5150~5250MHz	-1.74 dBi
			5725~5850MHz	-1.74 dBi

The Method of §15.203 Compliance:

- Antenna must be permanently attached to the unit.
 Antenna must use a unique type of connector to attach to the EUT.
 Unit must be professionally installed, and installer shall be responsible for verifying that the correct antenna is employed with the unit.

1.1.4 Accessory Information:

Accessory Description	Manufacturer	Model	Parameters
Adapter	Shenzhen Hujian Electronics Co.,Ltd	HJ-PD66W-US	Input: 100-240V~50/60Hz, 1.5A Output: 5.0V, 3A 15.0W; or 9.0V 3.0A 27.0W; or 12.0V 3.0A 36.0W; or 15.0V 3.0A 45.0W; or 20.0V 3.25A 65.0W; or 11.0V 6.0A 66.0W MAX

1.2 Description of Test Configuration

1.2.1 EUT Operation Condition:

EUT Operation Mode:		The system was configured for testing in Engineering Mode, which was provided by the manufacturer.		
Equipment Modifications:		No		
EUT Exercise Software:		Engineering mode		
The software was provided by manufacturer. The maximum power was configured as below, that was provided by the manufacturer▲:				
5150-5250 MHz Band:				
Test Modes	Test Channels	Test Frequency (MHz)	Data rate	Power Level Setting
802.11a	Lowest	5180	6Mbps	24
	Middle	5200	6Mbps	24
	Highest	5240	6Mbps	24
802.11n ht20	Lowest	5180	MCS0	24
	Middle	5200	MCS0	24
	Highest	5240	MCS0	24
802.11n ht40	Lowest	5190	MCS0	24
	Highest	5230	MCS0	24
802.11ac vht80	Middle	5210	MCS0	24
5725-5850 MHz Band:				
Test Modes	Test Channels	Test Frequency (MHz)	Data rate	Power Level Setting
802.11a	Lowest	5745	6Mbps	24
	Middle	5785	6Mbps	24
	Highest	5825	6Mbps	24
802.11n ht20	Lowest	5745	MCS0	24
	Middle	5785	MCS0	24
	Highest	5825	MCS0	24
802.11n ht40	Lowest	5755	MCS0	24
	Highest	5795	MCS0	24
802.11ac vht80	Middle	5775	MCS0	24
Note:				
The system support 802.11a/n ht20/n ht40/ac vht20/ac vht40, the ac vht20/vht40 were reduced since the identical parameters with 802.11n ht20 and ht40.				
The above are the worst-case data rates, which are determined for each mode based upon investigations by measuring the average power and PSD across all data rates, bandwidths, and modulations.				

1.2.2 Support Equipment List and Details

Manufacturer	Description	Model	Serial Number
/	/	/	/

1.2.3 Support Cable List and Details

Cable Description	Shielding Type	Ferrite Core	Length (m)	From Port	To
USB Cable	No	No	0.8	Adapter	EUT

1.2.4 Block Diagram of Test Setup

AC line conducted emissions:

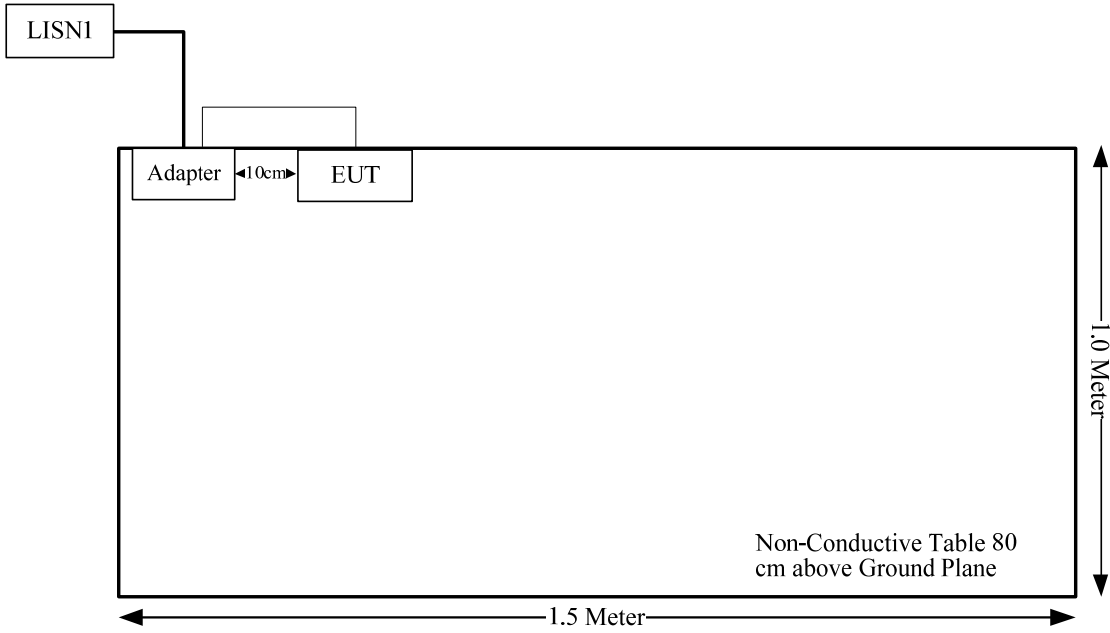

Radiated Spurious Emissions:
Below 1GHz:

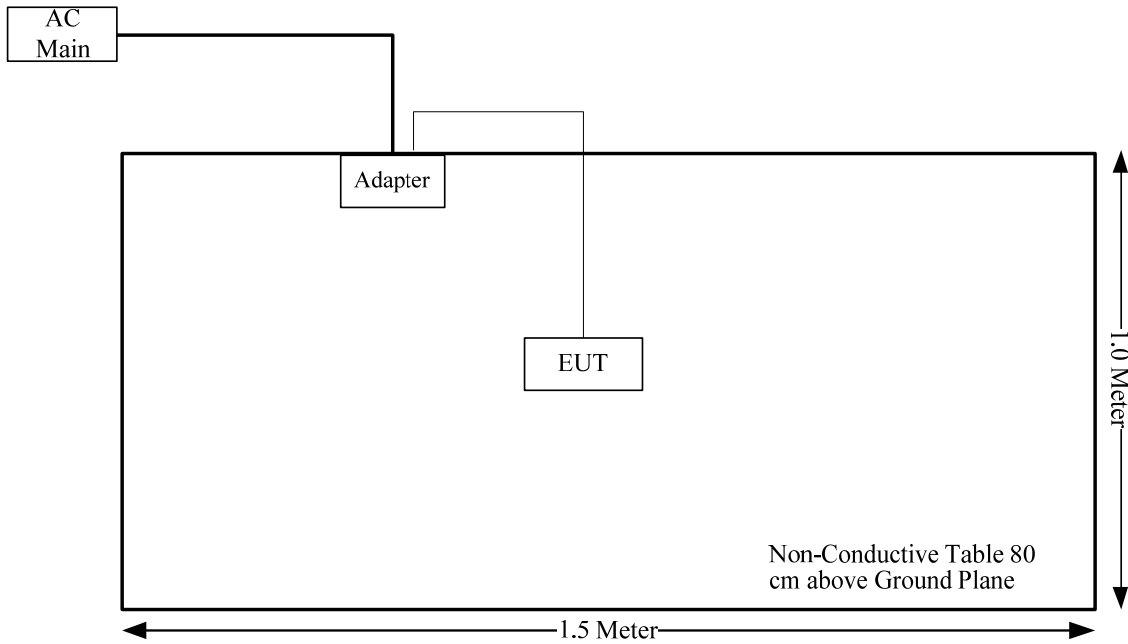

Above 1GHz:

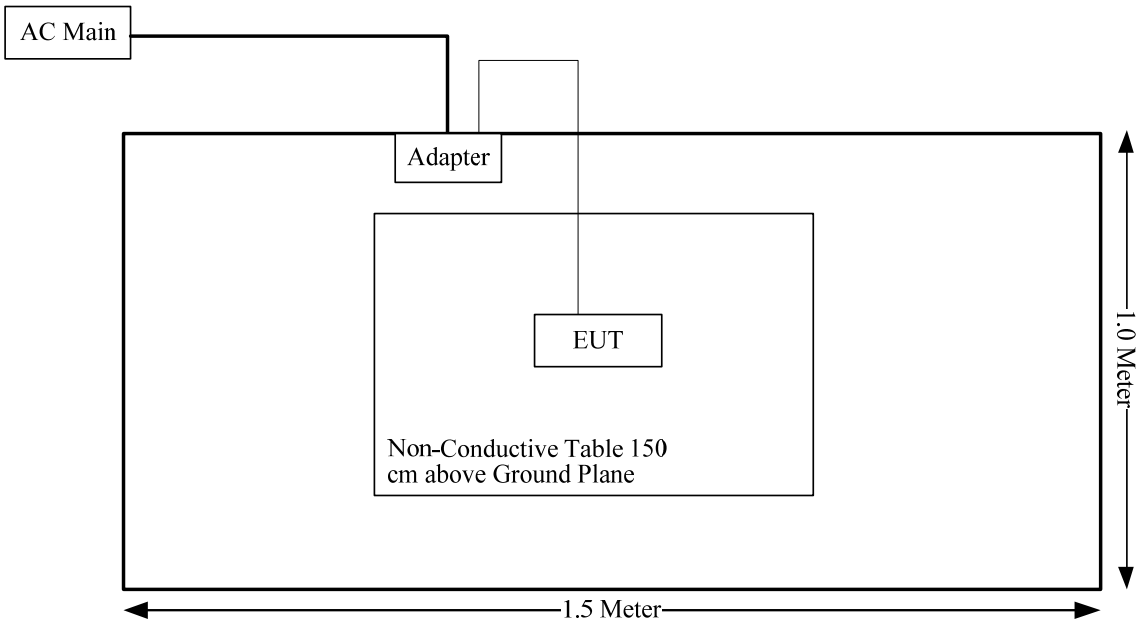

1.3 Measurement Uncertainty

Otherwise required by the applicant or Product Regulations, Decision Rule in this report did not consider the uncertainty. The extended uncertainty given in this report is obtained by combining the standard uncertainty times the coverage factor K with the 95% confidence interval.

Parameter	Measurement Uncertainty
Occupied Channel Bandwidth	±5 %
RF output power, conducted	±0.61dB
Power Spectral Density, conducted	±0.61 dB
Unwanted Emissions, radiated	30M~200MHz: 4.15 dB,200M~1GHz: 5.61 dB,1G~6GHz: 5.14 dB, 6G~18GHz: 5.93 dB,18G~26.5G:5.47 dB,26.5G~40G:5.63 dB
Unwanted Emissions, conducted	±1.26 dB
Temperature	±1 °C
Humidity	±5%
DC and low frequency voltages	±0.4%
Duty Cycle	1%
AC Power Lines Conducted Emission	2.8 dB (150 kHz to 30 MHz)

2. SUMMARY OF TEST RESULTS

Standard(s) Section	Test Items	Result
§15.207(a) RSS-Gen Clause 8.8	AC line conducted emissions	Compliant
FCC§15.205& §15.209 &§15.407(b) RSS-247 Clause 6.2	Undesirable Emission& Restricted Bands	Compliant
RSS-247 Clause 6.2.1.2	26dB attenuated below the channel power	Compliant
FCC§15.407(a) (e) RSS-247 Clause 6.2 RSS-Gen Clause 6.7	Emission Bandwidth	Compliant
FCC§15.407(a) RSS-247 Clause 6.2	Maximum Conducted Output Power	Compliant
FCC§15.407 (a) RSS-247 Clause 6.2	Power Spectral Density	Compliant
§15.203 RSS-GEN Clause 6.8	Antenna Requirement	Compliant
RSS-247 Clause 6.4	Additional requirements	Compliant
RSS-Gen Clause 6.11	Frequency Stability	Compliant

3. REQUIREMENTS AND TEST PROCEDURES

3.1 AC Line Conducted Emissions

3.1.1 Applicable Standard

FCC§15.207(a).

(a) Except as shown in paragraphs (b) and (c) of this section, for an intentional radiator that is designed to be connected to the public utility (AC) power line, the radio frequency voltage that is conducted back onto the AC power line on any frequency or frequencies, within the band 150 kHz to 30 MHz, shall not exceed the limits in the following table, as measured using a 50 μ H/50 ohms line impedance stabilization network (LISN). Compliance with the provisions of this paragraph shall be based on the measurement of the radio frequency voltage between each power line and ground at the power terminal. The lower limit applies at the boundary between the frequency ranges.

Frequency of emission (MHz)	Conducted limit (dB μ V)	
	Quasi-peak	Average
0.15-0.5	66 to 56*	56 to 46*
0.5-5	56	46
5-30	60	50

*Decreases with the logarithm of the frequency.

(b) The limit shown in paragraph (a) of this section shall not apply to carrier current systems operating as intentional radiators on frequencies below 30 MHz. In lieu thereof, these carrier current systems shall be subject to the following standards:

(1) For carrier current system containing their fundamental emission within the frequency band 535-1705 kHz and intended to be received using a standard AM broadcast receiver: no limit on conducted emissions.

(2) For all other carrier current systems: 1000 μ V within the frequency band 535-1705 kHz, as measured using a 50 μ H/50 ohms LISN.

(3) Carrier current systems operating below 30 MHz are also subject to the radiated emission limits in §15.205, §15.209, §15.221, §15.223, or §15.227, as appropriate.

(c) Measurements to demonstrate compliance with the conducted limits are not required for devices which only employ battery power for operation and which do not operate from the AC power lines or contain provisions for operation while connected to the AC power lines. Devices that include, or make provisions for, the use of battery chargers which permit operating while charging, AC adapters or battery eliminators or that connect to the AC power lines indirectly, obtaining their power through another device which is connected to the AC power lines, shall be tested to demonstrate compliance with the conducted limits.

RSS-Gen Clause 8.8

Unless stated otherwise in the applicable RSS, for radio apparatus that are designed to be connected to the public utility AC power network, the radio frequency voltage that is conducted back onto the AC power line on any frequency or frequencies within the range 150 kHz to 30 MHz shall not exceed the limits in table 4, as measured using a 50 μ H / 50 Ω line impedance stabilization network. This requirement applies for the radio frequency voltage measured between each power line and the ground terminal of each AC power-line mains cable of the EUT.

For an EUT that connects to the AC power lines indirectly, through another device, the requirement for compliance with the limits in table 4 shall apply at the terminals of the AC power-line mains cable of a representative support device, while it provides power to the EUT. The lower limit applies at the

boundary between the frequency ranges. The device used to power the EUT shall be representative of typical applications.

Table 4 – AC power-line conducted emissions limits

Frequency (MHz)	Conducted limit (dB μ V)	
	Quasi-peak	Average
0.15 - 0.5	66 to 56 ¹	56 to 46 ¹
0.5 – 5	56	46
5 – 30	60	50

Note 1: The level decreases linearly with the logarithm of the frequency.

For an EUT with a permanent or detachable antenna operating between 150 kHz and 30 MHz, the AC power-line conducted emissions must be measured using the following configurations:

(a) Perform the AC power-line conducted emissions test with the antenna connected to determine compliance with the limits of table 4 outside the transmitter's fundamental emission band.

(b) Retest with a dummy load instead of the antenna to determine compliance with the limits of table 4 within the transmitter's fundamental emission band. For a detachable antenna, remove the antenna and connect a suitable dummy load to the antenna connector. For a permanent antenna, remove the antenna and terminate the RF output with a dummy load or network that simulates the antenna in the fundamental frequency band.

3.1.2 EUT Setup

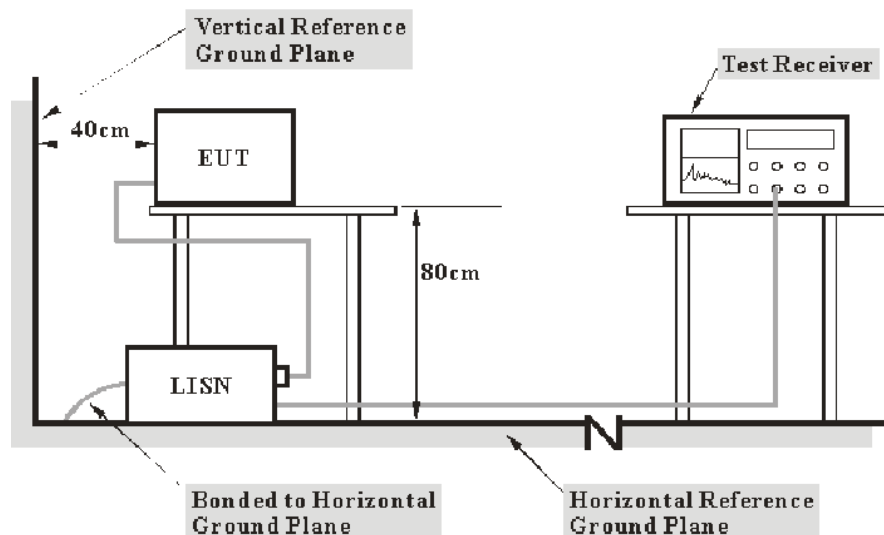

- Note: 1. Support units were connected to second LISN.
 2. Both of LISNs (AMN) 80 cm from EUT and at the least 80 cm from other units and other metal planes support units.

The setup of EUT is according with per ANSI C63.10-2013 measurement procedure. The specification used was with the FCC Part 15.207,RSS-Gen limits.

The spacing between the peripherals was 10 cm.

The adapter or EUT was connected to the main LISN with a 120 V/60 Hz AC power source.

3.1.3 EMI Test Receiver Setup

The EMI test receiver was set to investigate the spectrum from 150 kHz to 30 MHz.

During the conducted emission test, the EMI test receiver was set with the following configurations:

Frequency Range	IF B/W
150 kHz – 30 MHz	9 kHz

3.1.4 Test Procedure

The frequency and amplitude of the six highest ac power-line conducted emissions relative to the limit, measured over all the current-carrying conductors of the EUT power cords, and the operating frequency or frequency to which the EUT is tuned (if appropriate), should be reported, unless such emissions are more than 20 dB below the limit. AC power-line conducted emissions measurements are to be separately carried out only on each of the phase (“hot”) line(s) and (if used) on the neutral line(s), but not on the ground [protective earth] line(s). If less than six emission frequencies are within 20 dB of the limit, then the noise level of the measuring instrument at representative frequencies should be reported. The specific conductor of the power-line cord for each of the reported emissions should be identified. Measure the six highest emissions with respect to the limit on each current-carrying conductor of each power cord associated with the EUT (but not the power cords of associated or peripheral equipment that are part of the test configuration). Then, report the six highest emissions with respect to the limit from among all the measurements identifying the frequency and specific current-carrying conductor identified with the emission. The six highest emissions should be reported for each of the current-carrying conductors, or the six highest emissions may be reported over all the current-carrying conductors.

3.1.5 Corrected Amplitude & Margin Calculation

The basic equation is as follows:

Result = Reading + Factor

Factor = attenuation caused by cable loss + voltage division factor of AMN

The “**Margin**” column of the following data tables indicates the degree of compliance within the applicable limit. The equation for margin calculation is as follows:

Margin = Limit – Result

3.2 Radiation Spurious Emissions

3.2.1 Applicable Standard

FCC §15.407 (b);

Undesirable emission limits. Except as shown in paragraph (b)(7) of this section, the maximum emissions outside of the frequency bands of operation shall be attenuated in accordance with the following limits:

(1) For transmitters operating in the 5.15-5.25 GHz band: All emissions outside of the 5.15-5.35 GHz band shall not exceed an e.i.r.p. of - 27 dBm/MHz.

(2) For transmitters operating in the 5.25-5.35 GHz band: All emissions outside of the 5.15-5.35 GHz band shall not exceed an e.i.r.p. of - 27 dBm/MHz.

(3) For transmitters operating in the 5.47-5.725 GHz band: All emissions outside of the 5.47-5.725 GHz band shall not exceed an e.i.r.p. of - 27 dBm/MHz.

(4) For transmitters operating solely in the 5.725-5.850 GHz band:

(i) All emissions shall be limited to a level of - 27 dBm/MHz at 75 MHz or more above or below the band edge increasing linearly to 10 dBm/MHz at 25 MHz above or below the band edge, and from 25 MHz above or below the band edge increasing linearly to a level of 15.6 dBm/MHz at 5 MHz above or below the band edge, and from 5 MHz above or below the band edge increasing linearly to a level of 27 dBm/MHz at the band edge.

(ii) Devices certified before March 2, 2017 with antenna gain greater than 10 dBi may demonstrate compliance with the emission limits in § 15.247(d), but manufacturing, marketing and importing of devices certified under this alternative must cease by March 2, 2018. Devices certified before March 2, 2018 with antenna gain of 10 dBi or less may demonstrate compliance with the emission limits in § 15.247(d), but manufacturing, marketing and importing of devices certified under this alternative must cease before March 2, 2020.

(8) The emission measurements shall be performed using a minimum resolution bandwidth of 1 MHz. A lower resolution bandwidth may be employed near the band edge, when necessary, provided the measured energy is integrated to show the total power over 1 MHz.

(9) Unwanted emissions below 1 GHz must comply with the general field strength limits set forth in § 15.209. Further, any U-NII devices using an AC power line are required to comply also with the conducted limits set forth in § 15.207.

(10) The provisions of § 15.205 apply to intentional radiators operating under this section.

(11) When measuring the emission limits, the nominal carrier frequency shall be adjusted as close to the upper and lower frequency band edges as the design of the equipment permits.

(c) The device shall automatically discontinue transmission in case of either absence of information to transmit or operational failure. These provisions are not intended to preclude the transmission of control or signalling information or the use of repetitive codes used by certain digital technologies to complete frame or burst intervals. Applicants shall include in their application for equipment authorization a description of how this requirement is met.

Frequency band 5150-5250 MHz:

RSS-247 Clause 6.2.1.2

For transmitters with operating frequencies in the band 5150-5250 MHz, all emissions outside the band 5150-5350 MHz shall not exceed -27 dBm/MHz e.i.r.p. Any unwanted emissions that fall into the band 5250-5350 MHz shall be attenuated below the channel power by at least 26 dB, when measured using a resolution bandwidth between 1 and 5% of the occupied bandwidth (i.e. 99% bandwidth), above 5250 MHz. The 26 dB bandwidth may fall into the 5250-5350 MHz band; however, if the occupied bandwidth also falls within the 5250-5350 MHz band, the transmission is considered as intentional and the devices shall comply with all requirements in the band 5250-5350 MHz including implementing dynamic frequency selection (DFS) and TPC, on the portion of the emission that resides in the 5250-5350 MHz band.

Frequency band 5250-5350 MHz:

RSS-247 Clause 6.2.2.2

For transmitters with operating frequencies in the band 5150-5250 MHz, all emissions outside the band 5150-5350 MHz shall not exceed -27 dBm/MHz e.i.r.p. Any unwanted emissions that fall into the band 5250-5350 MHz shall be attenuated below the channel power by at least 26 dB, when measured using a resolution bandwidth between 1 and 5% of the occupied bandwidth (i.e. 99% bandwidth), above 5250 MHz. The 26 dB bandwidth may fall into the 5250-5350 MHz band; however, if the occupied bandwidth also falls within the 5250-5350 MHz band, the transmission is considered as intentional and the devices shall comply with all requirements in the band 5250-5350 MHz including implementing dynamic frequency selection (DFS) and TPC, on the portion of the emission that resides in the 5250-5350 MHz band.

Frequency bands 5470-5600 MHz and 5650-5725 MHz:

RSS-247 Clause 6.2.3.2

Emissions outside the band 5470-5600 MHz and 5650-5725 MHz shall not exceed -27 dBm/MHz e.i.r.p. However, devices with bandwidth overlapping the band edge of 5725 MHz can meet the emission limit of -27 dBm/MHz e.i.r.p. at 5850 MHz instead of 5725 MHz.

Frequency band 5725-5850 MHz

RSS-247 Clause 6.2.4.2

Devices operating in the band 5725-5850 MHz with antenna gain greater than 10 dBi can have unwanted emissions that comply with either the limits in this section or in section 5.5 until six (6) months after the publication date of this standard for certification. Certified devices that do not comply with emission limits in this section shall not be manufactured, imported, distributed, leased, offered for sale or sold after April 1, 2018.

Devices operating in the band 5725-5850 MHz with antenna gain of 10 dBi or less can have unwanted emissions that comply with either the limits in this section or in section 5.5 until April 1, 2018 for certification. Certified devices that do not comply with emission limits in this section shall not be manufactured, imported, distributed, leased, offered for sale or sold after April 1, 2020.

Devices operating in the band 5725-5850 MHz shall have e.i.r.p. of unwanted emissions comply with the following:

- a) 27 dBm/MHz at frequencies from the band edges decreasing linearly to 15.6 dBm/MHz at 5 MHz above or below the band edges;
- b) 15.6 dBm/MHz at 5 MHz above or below the band edges decreasing linearly to 10 dBm/MHz at 25 MHz above or below the band edges;
- c) 10 dBm/MHz at 25 MHz above or below the band edges decreasing linearly to -27 dBm/MHz at 75 MHz above or below the band edges; and
- d) -27 dBm/MHz at frequencies more than 75 MHz above or below the band edges.

3.2.2 EUT Setup

Below 1GHz:

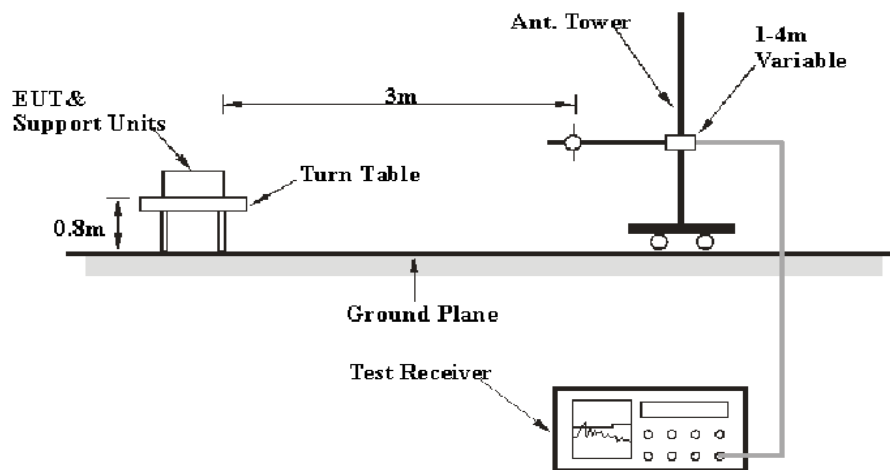

1-40 GHz:

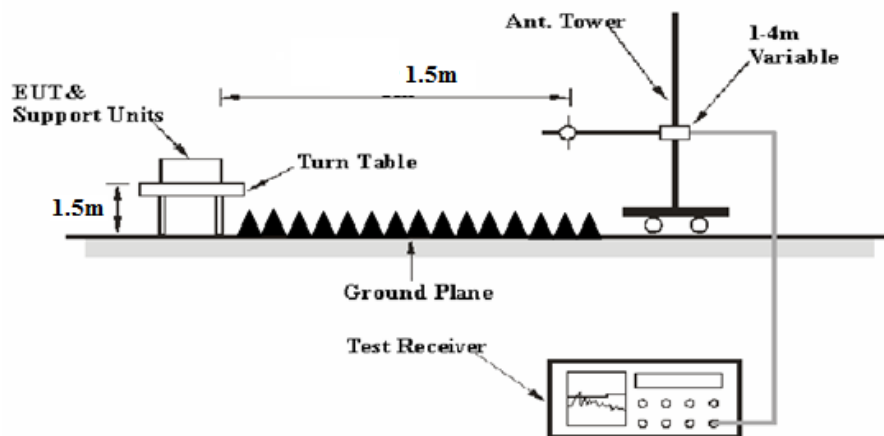

The radiated emission tests were performed in the 3 meters chamber test site, using the setup accordance with the ANSI C63.10-2013. The specification used was FCC 15.209, FCC 15.407, RSS-247, RSS-Gen limits.

The external I/O cables were draped along the test table and formed a bundle 30 to 40 cm long in the middle.

The spacing between the peripherals was 10 cm.

3.2.3 EMI Test Receiver & Spectrum Analyzer Setup

The system was investigated from 30 MHz to 40 GHz.

During the radiated emission test, the EMI test receiver & Spectrum Analyzer Setup were set with the following configurations:

30-1000MHz:

Detector	RBW	Video B/W	IF B/W
QP	120 kHz	300 kHz	120kHz

1GHz- 40GHz:

Measurement	Duty cycle	RBW	Video B/W
PK	Any	1MHz	3 MHz
AV	>98%	1MHz	10 Hz
	<98%	1MHz	$\geq 1/T$

Note: T is minimum transmission duration

If the maximized peak measured value complies with under the QP/Average limit more than 6dB, then it is unnecessary to perform an QP/Average measurement.

3.2.4 Test Procedure

During the radiated emission test, the adapter was connected to the first AC floor outlet.

Data was recorded in Quasi-peak detection mode for frequency range of 30 MHz-1GHz, peak and Average detection modes for frequencies above 1GHz.

According to KDB 789033 D02 General UNII Test Procedures New Rules v02r01, emission shall be computed as: $E [dB\mu V/m] = EIRP[dBm] + 95.2$, for $d = 3$ meters.

According to C63.10, the above 1G test result shall be extrapolated to the specified distance using an extrapolation Factor of 20dB/decade from 3m to 1.5m

Distance extrapolation Factor = $20 \log (\text{specific distance } [3m] / \text{test distance } [1.5m])$ dB = 6.02 dB

All emissions under the average limit and under the noise floor have not recorded in the report.

3.2.5 Corrected Amplitude & Margin Calculation

The basic equation is as follows:

Factor = Antenna Factor + Cable Loss - Amplifier Gain

For 30MHz-1GHz:

Result = Reading + Factor

For 1GHz-40GHz

Result = Reading + Factor - Distance extrapolation Factor

The “**Margin**” column of the following data tables indicates the degree of compliance within the applicable limit. The equation for margin calculation is as follows:

Margin = Limit – Result

3.3 26dB Attenuated Below The Channel Power

3.3.1 Applicable Standard

RSS-247 Clause 6.2.1.2

For transmitters with operating frequencies in the band 5150-5250 MHz, all emissions outside the band 5150-5350 MHz shall not exceed -27 dBm/MHz e.i.r.p. Any unwanted emissions that fall into the band 5250-5350 MHz shall be attenuated below the channel power by at least 26 dB, when measured using a resolution bandwidth between 1 and 5% of the occupied bandwidth (i.e. 99% bandwidth), above 5250 MHz. The 26 dB bandwidth may fall into the 5250-5350 MHz band; however, if the occupied bandwidth also falls within the 5250-5350 MHz band, the transmission is considered as intentional and the devices shall comply with all requirements in the band 5250-5350 MHz including implementing dynamic frequency selection (DFS) and TPC, on the portion of the emission that resides in the 5250-5350 MHz band.

3.3.2 EUT Setup

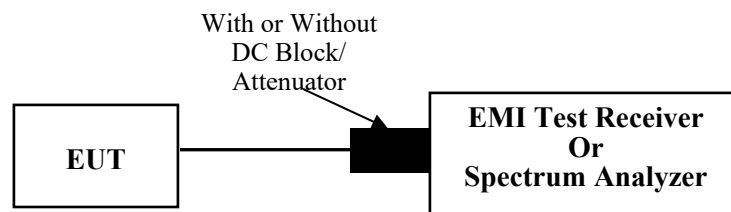

3.3.3 Test Procedure

- a) Set RBW = 1%~5% of the emission bandwidth.
- b) Set the VBW > RBW.
- c) Detector = RMS.
- d) Trace mode = max hold
- e) Measure the emission attenuated below the channel power

3.4 Emission Bandwidth

3.4.1 Applicable Standard

FCC §15.407 (a)

(2) For the 5.25-5.35 GHz and 5.47-5.725 GHz bands, the maximum conducted output power over the frequency bands of operation shall not exceed the lesser of 250 mW or $11 \text{ dBm} + 10 \log B$, where B is the 26 dB emission bandwidth in megahertz. In addition, the maximum power spectral density shall not exceed 11 dBm in any 1 megahertz band. If transmitting antennas of directional gain greater than 6 dBi are used, both the maximum conducted output power and the maximum power spectral density shall be reduced by the amount in dB that the directional gain of the antenna exceeds 6 dBi.

FCC §15.407 (e)

Within the 5.725-5.850 GHz and 5.850-5.895 GHz bands, the minimum 6 dB bandwidth of U-NII devices shall be at least 500 kHz.

FCC §15.407 (h)

(h)(2) Radar Detection Function of Dynamic Frequency Selection (DFS). U-NII devices operating with any part of its 26 dB emission bandwidth in the 5.25-5.35 GHz and 5.47-5.725 GHz bands shall employ a DFS radar detection mechanism to detect the presence of radar systems and to avoid co-channel operation with radar systems.

RSS-247 Clause 6.2.1.2

For transmitters with operating frequencies in the band 5150-5250 MHz, all emissions outside the band 5150-5350 MHz shall not exceed -27 dBm/MHz e.i.r.p. Any unwanted emissions that fall into the band 5250-5350 MHz shall be attenuated below the channel power by at least 26 dB, when measured using a resolution bandwidth between 1 and 5% of the occupied bandwidth (i.e. 99% bandwidth), above 5250 MHz. The 26 dB bandwidth may fall into the 5250-5350 MHz band; however, if the occupied bandwidth also falls within the 5250-5350 MHz band, the transmission is considered as intentional and the devices shall comply with all requirements in the band 5250-5350 MHz including implementing dynamic frequency selection (DFS) and TPC, on the portion of the emission that resides in the 5250-5350 MHz band.

RSS-247 Clause 6.2.2.1

Devices, other than devices installed in vehicles, shall comply with the following:

- a) The maximum conducted output power shall not exceed 250 mW or $11 + 10 \log_{10} B$, dBm, whichever is less. The power spectral density shall not exceed 11 dBm in any 1.0 MHz band;
- b) The maximum e.i.r.p. shall not exceed 1.0 W or $17 + 10 \log_{10} B$, dBm, whichever is less. B is the 99% emission bandwidth in megahertz. Note that devices with a maximum e.i.r.p. greater than 500 mW shall implement TPC in order to have the capability to operate at least 6 dB below the maximum permitted e.i.r.p. of 1 W

RSS-247 Clause 6.2.3.1

The maximum conducted output power shall not exceed 250 mW or $11 + 10 \log_{10} B$, dBm, whichever is less. The power spectral density shall not exceed 11 dBm in any 1.0 MHz band.

The maximum e.i.r.p. shall not exceed 1.0 W or $17 + 10 \log_{10}B$, dBm, whichever is less. B is the 99% emission bandwidth in megahertz. Note that devices with a maximum e.i.r.p. greater than 500 mW shall implement TPC in order to have the capability to operate at least 6 dB below the maximum permitted e.i.r.p. of 1 W.

RSS-247 Clause 6.2.4.1

For equipment operating in the band 5725-5850 MHz, the minimum 6 dB bandwidth shall be at least 500 kHz.

3.4.2 EUT Setup

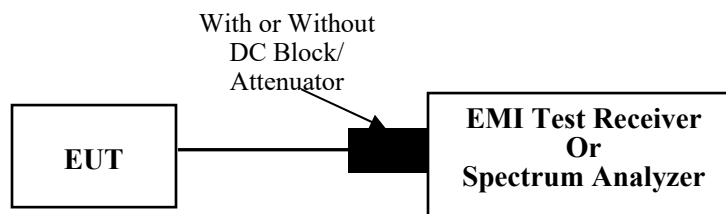

3.4.3 Test Procedure

26dB Emission Bandwidth:

According to ANSI C63.10-2013 Section 12.4.1

- a) Set RBW = approximately 1% of the emission bandwidth.
- b) Set the VBW > RBW.
- c) Detector = peak.
- d) Trace mode = max hold
- e) Measure the maximum width of the emission that is 26 dB down from the peak of the emission. Compare this with the RBW setting of the instrument. Readjust RBW and repeat measurement as needed until the RBW/EBW ratio is approximately 1%.

6 dB emission bandwidth:

According to KDB 789033 D02 General UNII Test Procedures New Rules v02r01

- a) Set RBW = 100 kHz.
- b) Set the video bandwidth (VBW) ≥ 3 RBW.
- c) Detector = Peak.
- d) Trace mode = max hold.
- e) Sweep = auto couple.
- f) Allow the trace to stabilize.
- g) Measure the maximum width of the emission that is constrained by the frequencies associated with the two outermost amplitude points (upper and lower frequencies) that are attenuated by 6 dB relative to the maximum level measured in the fundamental emission.

Note: The automatic bandwidth measurement capability of a spectrum analyzer or EMI receiver may be employed if it implements the functionality described in this section. For devices that use channel aggregation refer to III.A and III.C for determining emission bandwidth.

99% Occupied Bandwidth:

According to ANSI C63.10-2013 Section 12.4.2&6.9.3

The occupied bandwidth is the frequency bandwidth such that, below its lower and above its upper frequency limits, the mean powers are each equal to 0.5% of the total mean power of the given emission.

The following procedure shall be used for measuring 99% power bandwidth:

- a) The instrument center frequency is set to the nominal EUT channel center frequency. The frequency span for the spectrum analyzer shall be between 1.5 times and 5.0 times the OBW.
- b) The nominal IF filter bandwidth (3 dB RBW) shall be in the range of 1% to 5% of the OBW, and VBW shall be approximately three times the RBW, unless otherwise specified by the applicable requirement.
- c) Set the reference level of the instrument as required, keeping the signal from exceeding the maximum input mixer level for linear operation. In general, the peak of the spectral envelope shall be more than $[10 \log (OBW/RBW)]$ below the reference level. Specific guidance is given in 4.1.5.2.
- d) Step a) through step c) might require iteration to adjust within the specified range.
- e) Video averaging is not permitted. Where practical, a sample detection and single sweep mode shall be used. Otherwise, peak detection and max hold mode (until the trace stabilizes) shall be used.
- f) Use the 99% power bandwidth function of the instrument (if available) and report the measured bandwidth.
- g) If the instrument does not have a 99% power bandwidth function, then the trace data points are recovered and directly summed in linear power terms. The recovered amplitude data points, beginning at the lowest frequency, are placed in a running sum until 0.5% of the total is reached; that frequency is recorded as the lower frequency. The process is repeated until 99.5% of the total is reached; that frequency is recorded as the upper frequency. The 99% power bandwidth is the difference between these two frequencies.
- h) The occupied bandwidth shall be reported by providing plot(s) of the measuring instrument display; the plot axes and the scale units per division shall be clearly labeled. Tabular data may be reported in addition to the plot(s).

3.5 Maximum Conducted Output Power

3.5.1 Applicable Standard

FCC §15.407(a) (1)

(ii) For an indoor access point operating in the band 5.15-5.25 GHz, the maximum conducted output power over the frequency band of operation shall not exceed 1 W provided the maximum antenna gain does not exceed 6 dBi. In addition, the maximum power spectral density shall not exceed 17 dBm in any 1 megahertz band. If transmitting antennas of directional gain greater than 6 dBi are used, both the maximum conducted output power and the maximum power spectral density shall be reduced by the amount in dB that the directional gain of the antenna exceeds 6 dBi.

FCC §15.407(a) (2)

For the 5.25-5.35 GHz and 5.47-5.725 GHz bands, the maximum conducted output power over the frequency bands of operation shall not exceed the lesser of 250 mW or $11 \text{ dBm} + 10 \log B$, where B is the 26 dB emission bandwidth in megahertz. In addition, the maximum power spectral density shall not exceed 11 dBm in any 1 megahertz band. If transmitting antennas of directional gain greater than 6 dBi are used, both the maximum conducted output power and the maximum power spectral density shall be reduced by the amount in dB that the directional gain of the antenna exceeds 6 dBi.

FCC §15.407(a) (3)(i)

For the band 5.725-5.850 GHz, the maximum conducted output power over the frequency band of operation shall not exceed 1 W. In addition, the maximum power spectral density shall not exceed 30 dBm in any 500-kHz band. If transmitting antennas of directional gain greater than 6 dBi are used, both the maximum conducted output power and the maximum power spectral density shall be reduced by the amount in dB that the directional gain of the antenna exceeds 6 dBi. However, fixed point-to-point U-NII devices operating in this band may employ transmitting antennas with directional gain greater than 6 dBi without any corresponding reduction in transmitter conducted power. Fixed, point-to-point operations exclude the use of point-to-multipoint systems, omnidirectional applications, and multiple collocated transmitters transmitting the same information. The operator of the U-NII device, or if the equipment is professionally installed, the installer, is responsible for ensuring that systems employing high gain directional antennas are used exclusively for fixed, point-to-point operations.

RSS-247 Clause 6.2.1.1

For OEM devices installed in vehicles, the maximum e.i.r.p. shall not exceed 30 mW or $1.76 + 10 \log_{10} B$, dBm, whichever is less stringent. Devices shall implement transmitter power control (TPC) in order to have the capability to operate at least 3 dB below the maximum permitted e.i.r.p. of 30 mW.

For other devices, the maximum e.i.r.p. shall not exceed 200 mW or $10 + 10 \log_{10} B$, dBm, whichever power is less. B is the 99% emission bandwidth in megahertz. The e.i.r.p. spectral density shall not exceed 10 dBm in any 1.0 MHz band.

RSS-247 Clause 6.2.2.1

Devices, other than devices installed in vehicles, shall comply with the following:

a) The maximum conducted output power shall not exceed 250 mW or $11 + 10 \log_{10} B$, dBm, whichever is less. The power spectral density shall not exceed 11 dBm in any 1.0 MHz band;

b) The maximum e.i.r.p. shall not exceed 1.0 W or $17 + 10 \log_{10}B$, dBm, whichever is less. B is the 99% emission bandwidth in megahertz. Note that devices with a maximum e.i.r.p. greater than 500 mW shall implement TPC in order to have the capability to operate at least 6 dB below the maximum permitted e.i.r.p. of 1 W.

RSS-247 Clause 6.2.3.1

The maximum conducted output power shall not exceed 250 mW or $11 + 10 \log_{10}B$, dBm, whichever is less. The power spectral density shall not exceed 11 dBm in any 1.0 MHz band.

The maximum e.i.r.p. shall not exceed 1.0 W or $17 + 10 \log_{10}B$, dBm, whichever is less. B is the 99% emission bandwidth in megahertz. Note that devices with a maximum e.i.r.p. greater than 500 mW shall implement TPC in order to have the capability to operate at least 6 dB below the maximum permitted e.i.r.p. of 1 W.

RSS-247 Clause 6.2.4.1

The maximum conducted output power shall not exceed 1 W. The output power spectral density shall not exceed 30 dBm in any 500 kHz band. If transmitting antennas of directional gain greater than 6 dBi are used, both the maximum conducted output power and the output power spectral density shall be reduced by the amount in dB that the directional gain of the antenna exceeds 6 dBi. However, fixed point-to-point devices operating in this band may employ transmitting antennas with directional gain greater than 6 dBi without any corresponding reduction in transmitter conducted power. Fixed point-to-point operations exclude the use of point-to-multipoint systems, omnidirectional applications and multiple collocated transmitters transmitting the same information.

3.5.2 EUT Setup

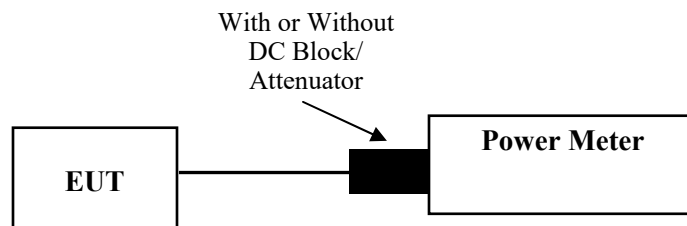

3.5.3 Test Procedure

According to ANSI C63.10-2013 Section 12.3.3.2

Method PM-G is measurement using a gated RF average power meter. Measurements may be performed using a wideband gated RF power meter provided that the gate parameters are adjusted such that the power is measured only when the EUT is transmitting at its maximum power control level. Because the measurement is made only during the ON time of the transmitter, no duty cycle correction factor is required.

3.6 Maximum Power Spectral Density

3.6.1 Applicable Standard

FCC §15.407(a) (1)

(ii) For an indoor access point operating in the band 5.15-5.25 GHz, the maximum conducted output power over the frequency band of operation shall not exceed 1 W provided the maximum antenna gain does not exceed 6 dBi. In addition, the maximum power spectral density shall not exceed 17 dBm in any 1 megahertz band. If transmitting antennas of directional gain greater than 6 dBi are used, both the maximum conducted output power and the maximum power spectral density shall be reduced by the amount in dB that the directional gain of the antenna exceeds 6 dBi.

FCC §15.407(a) (2)

For the 5.25-5.35 GHz and 5.47-5.725 GHz bands, the maximum conducted output power over the frequency bands of operation shall not exceed the lesser of 250 mW or $11 \text{ dBm} + 10 \log B$, where B is the 26 dB emission bandwidth in megahertz. In addition, the maximum power spectral density shall not exceed 11 dBm in any 1 megahertz band. If transmitting antennas of directional gain greater than 6 dBi are used, both the maximum conducted output power and the maximum power spectral density shall be reduced by the amount in dB that the directional gain of the antenna exceeds 6 dBi.

FCC §15.407(a) (3)(i)

For the band 5.725-5.850 GHz, the maximum conducted output power over the frequency band of operation shall not exceed 1 W. In addition, the maximum power spectral density shall not exceed 30 dBm in any 500-kHz band. If transmitting antennas of directional gain greater than 6 dBi are used, both the maximum conducted output power and the maximum power spectral density shall be reduced by the amount in dB that the directional gain of the antenna exceeds 6 dBi. However, fixed point-to-point U-NII devices operating in this band may employ transmitting antennas with directional gain greater than 6 dBi without any corresponding reduction in transmitter conducted power. Fixed, point-to-point operations exclude the use of point-to-multipoint systems, omnidirectional applications, and multiple collocated transmitters transmitting the same information. The operator of the U-NII device, or if the equipment is professionally installed, the installer, is responsible for ensuring that systems employing high gain directional antennas are used exclusively for fixed, point-to-point operations.

RSS-247 Clause 6.2.1.1

For OEM devices installed in vehicles, the maximum e.i.r.p. shall not exceed 30 mW or $1.76 + 10 \log_{10} B$, dBm, whichever is less stringent. Devices shall implement transmitter power control (TPC) in order to have the capability to operate at least 3 dB below the maximum permitted e.i.r.p. of 30 mW.

For other devices, the maximum e.i.r.p. shall not exceed 200 mW or $10 + 10 \log_{10} B$, dBm, whichever power is less. B is the 99% emission bandwidth in megahertz. The e.i.r.p. spectral density shall not exceed 10 dBm in any 1.0 MHz band.

RSS-247 Clause 6.2.2.1

Devices, other than devices installed in vehicles, shall comply with the following:

a) The maximum conducted output power shall not exceed 250 mW or $11 + 10 \log_{10} B$, dBm, whichever is less. The power spectral density shall not exceed 11 dBm in any 1.0 MHz band;

b) The maximum e.i.r.p. shall not exceed 1.0 W or $17 + 10 \log_{10}B$, dBm, whichever is less. B is the 99% emission bandwidth in megahertz. Note that devices with a maximum e.i.r.p. greater than 500 mW shall implement TPC in order to have the capability to operate at least 6 dB below the maximum permitted e.i.r.p. of 1 W.

RSS-247 Clause 6.2.3.1

The maximum conducted output power shall not exceed 250 mW or $11 + 10 \log_{10}B$, dBm, whichever is less. The power spectral density shall not exceed 11 dBm in any 1.0 MHz band.

The maximum e.i.r.p. shall not exceed 1.0 W or $17 + 10 \log_{10}B$, dBm, whichever is less. B is the 99% emission bandwidth in megahertz. Note that devices with a maximum e.i.r.p. greater than 500 mW shall implement TPC in order to have the capability to operate at least 6 dB below the maximum permitted e.i.r.p. of 1 W.

RSS-247 Clause 6.2.4.1

The maximum conducted output power shall not exceed 1 W. The output power spectral density shall not exceed 30 dBm in any 500 kHz band. If transmitting antennas of directional gain greater than 6 dBi are used, both the maximum conducted output power and the output power spectral density shall be reduced by the amount in dB that the directional gain of the antenna exceeds 6 dBi. However, fixed point-to-point devices operating in this band may employ transmitting antennas with directional gain greater than 6 dBi without any corresponding reduction in transmitter conducted power. Fixed point-to-point operations exclude the use of point-to-multipoint systems, omnidirectional applications and multiple collocated transmitters transmitting the same information.

3.6.2 EUT Setup

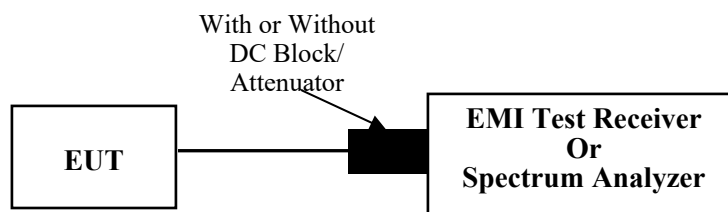

3.6.3 Test Procedure

According to ANSI C63.10-2013 Section 12.3.2

Duty cycle $\geq 98\%$

Method SA-1 was used.

Duty cycle $< 98\%$, duty cycle variations are less than $\pm 2\%$

Method SA-2 was used.

Duty cycle $< 98\%$, duty cycle variations exceed $\pm 2\%$

Method SA-3 was used.

3.7 Duty Cycle

3.7.1 EUT Setup

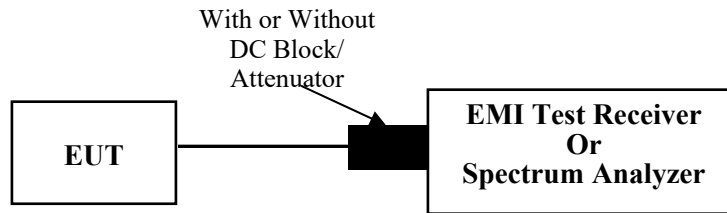

3.7.2 Test Procedure

According to ANSI C63.10-2013 Section 12.2

The zero-span mode on a spectrum analyzer or EMI receiver if the response time and spacing between bins on the sweep are sufficient to permit accurate measurements of the ON and OFF times of the transmitted signal:

- 1) Set the center frequency of the instrument to the center frequency of the transmission.
- 2) Set $RBW \geq OBW$ if possible; otherwise, set RBW to the largest available value.
- 3) Set $VBW \geq RBW$. Set detector = peak or average.
- 4) The zero-span measurement method shall not be used unless both RBW and VBW are $> 50/T$ and the number of sweep points across duration T exceeds 100. (For example, if VBW and/or RBW are limited to 3 MHz, then the zero-span method of measuring the duty cycle shall not be used if $T \leq 16.7 \mu s$.)

3.8 Transmitter frequency stability

3.8.1 Applicable Standard

RSS-Gen Clause 8.11

If the frequency stability of the licence-exempt radio apparatus is not specified in the applicable RSS, the fundamental emissions of the radio apparatus should be kept within at least the central 80% of its permitted operating frequency band in order to minimize the possibility of out-of-band operation. In addition, its occupied bandwidth shall be entirely outside the restricted bands and the prohibited TV bands of 54-72 MHz, 76-88 MHz, 174-216 MHz, and 470-602 MHz, unless otherwise indicated.

3.8.2 EUT Setup

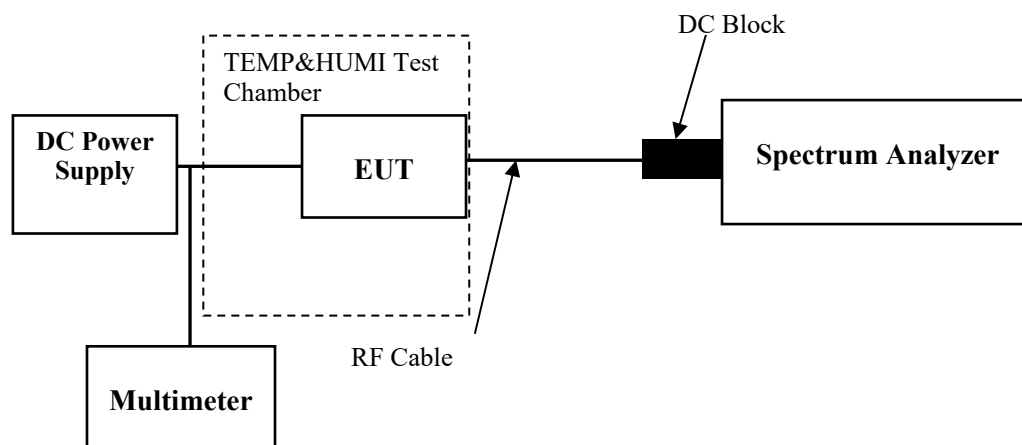

3.8.3 Test Procedure

According to ANSI C63.10-2013 Section 6.8

Frequency stability with respect to ambient temperature

- a) Supply the EUT with a nominal ac voltage or install a new or fully charged battery in the EUT. If possible, a dummy load shall be connected to the EUT because an antenna near the metallic walls of an environmental test chamber could affect the output frequency of the EUT. If the EUT is equipped with a permanently attached, adjustable-length antenna, then the EUT shall be placed in the center of the chamber with the antenna adjusted to the shortest length possible. Turn ON the EUT and tune it to one of the number of frequencies shown in 5.6.
- b) Couple the unlicensed wireless device output to the measuring instrument by connecting an antenna to the measuring instrument with a suitable length of coaxial cable and placing the measuring antenna near the EUT (e.g., 15 cm away), or by connecting a dummy load to the measuring instrument, through an attenuator if necessary.

NOTE—An instrument that has an adequate level of accuracy as specified by the procuring or regulatory agency is the recommended measuring instrument.

- c) Adjust the location of the measurement antenna and the controls on the measurement instrument to obtain a suitable signal level (i.e., a level that will not overload the measurement instrument but is strong enough to allow measurement of the operating or fundamental frequency of the EUT).

- d) Turn the EUT OFF and place it inside the environmental temperature chamber. For devices that have oscillator heaters, energize only the heater circuit.
- e) Set the temperature control on the chamber to the highest specified in the regulatory requirements for the type of device and allow the oscillator heater and the chamber temperature to stabilize.
- f) While maintaining a constant temperature inside the environmental chamber, turn the EUT ON and record the operating frequency at startup, and at 2 minutes, 5 minutes, and 10 minutes after the EUT is energized. Four measurements in total are made.
- g) Measure the frequency at each of frequencies specified in 5.6.
- h) Switch OFF the EUT but do not switch OFF the oscillator heater.
- i) Lower the chamber temperature by not more than 10 °C, and allow the temperature inside the chamber to stabilize.
- j) Repeat step f) through step i) down to the lowest specified temperature.

Frequency stability when varying supply voltage

Unless otherwise specified, these tests shall be made at ambient room temperature (+15 °C to +25 °C). An antenna shall be connected to the antenna output terminals of the EUT if possible. If the EUT is equipped with or uses an adjustable-length antenna, then it shall be fully extended.

- a) Supply the EUT with nominal voltage or install a new or fully charged battery in the EUT. Turn ON the EUT and couple its output to a frequency counter or other frequency-measuring instrument.
NOTE—An instrument that has an adequate level of accuracy as specified by the procuring or regulatory agency is the recommended measuring instrument.
- b) Tune the EUT to one of the number of frequencies required in 5.6. Adjust the location of the measurement antenna and the controls on the measurement instrument to obtain a suitable signal level (i.e., a level that will not overload the measurement instrument but is strong enough to allow measurement of the operating or fundamental frequency of the EUT).
- c) Measure the frequency at each of the frequencies specified in 5.6.
- d) Repeat the above procedure at 85% and 115% of the nominal supply voltage as described in 5.13.

3.9 Antenna Requirement

3.9.1 Applicable Standard

FCC §15.203

An intentional radiator shall be designed to ensure that no antenna other than that furnished by the responsible party shall be used with the device. The use of a permanently attached antenna or of an antenna that uses a unique coupling to the intentional radiator shall be considered sufficient to comply with the provisions of this section. The manufacturer may design the unit so that a broken antenna can be replaced by the user, but the use of a standard antenna jack or electrical connector is prohibited. This requirement does not apply to carrier current devices or to devices operated under the provisions of §§15.211, 15.213, 15.217, 15.219, 15.221, or §15.236. Further, this requirement does not apply to intentional radiators that must be professionally installed, such as perimeter protection systems and some field disturbance sensors, or to other intentional radiators which, in accordance with §15.31(d), must be measured at the installation site. However, the installer shall be responsible for ensuring that the proper antenna is employed so that the limits in this part are not exceeded.

RSS-GEN Clause 6.8

The applicant for equipment certification shall provide a list of all antenna types that may be used with the transmitter, where applicable (i.e. for transmitters with detachable antenna), indicating the maximum permissible antenna gain (in dBi) and the required impedance for each antenna. The test report shall demonstrate the compliance of the transmitter with the limit for maximum equivalent isotropically radiated power (e.i.r.p.) specified in the applicable RSS, when the transmitter is equipped with any antenna type, selected from this list.

For expediting the testing, measurements may be performed using only the antenna with highest gain of each combination of transmitter and antenna type, with the transmitter output power set at the maximum level. However, the transmitter shall comply with the applicable requirements under all operational conditions and when in combination with any type of antenna from the list provided in the test report (and in the notice to be included in the user manual, provided below).

When measurements at the antenna port are used to determine the RF output power, the effective gain of the device's antenna shall be stated, based on a measurement or on data from the antenna's manufacturer.

The test report shall state the RF power, output power setting and spurious emission measurements with each antenna type that is used with the transmitter being tested.

For licence-exempt equipment with detachable antennas, the user manual shall also contain the following notice in a conspicuous location:

This radio transmitter [enter the device's ISED certification number] has been approved by Innovation, Science and Economic Development Canada to operate with the antenna types listed below, with the maximum permissible gain indicated. Antenna types not included in this list that have a gain greater than the maximum gain indicated for any type listed are strictly prohibited for use with this device.

Immediately following the above notice, the manufacturer shall provide a list of all antenna types which can be used with the transmitter, indicating the maximum permissible antenna gain (in dBi) and the required impedance for each antenna type.

3.9.2 Judgment

Result: Compliant. Please refer to the Antenna Information detail in Section 1.

3.10 Additional requirement

3.10.1 Applicable Standard

According to RSS-247 Clause 6.4 Additional requirement

The following requirements shall apply:

- a) The device shall automatically discontinue transmission in cases of absence of information to transmit, or operational failure. A description on how this is done shall accompany the application for equipment certification. Note that this is not intended to prohibit transmission of control or signalling information or the use of repetitive codes where required by the technology.
- b) All LE-LAN devices must contain security features to protect against modification of software by unauthorized parties.

Manufacturers must implement security features in any digitally modulated devices capable of operating in any of the frequency ranges within the 5 GHz band, so that third parties are not able to reprogram the device to operate outside the parameters for which the device was certified. The software must prevent the user from operating the transmitter with operating frequencies, output power, modulation types or other radio frequency parameters outside those that were approved for the device. Manufacturers may use various means, including the use of a private network that allows only authenticated users to download software, electronic signatures in software or coding in hardware that is decoded by software to verify that new software can be legally loaded into a device to meet these requirements and must describe the methods in their application for equipment certification.

Manufacturers must take steps to ensure that DFS functionality cannot be disabled by the operator of the LE-LAN device.

- c) The user manual for LE-LAN devices shall contain instructions related to the restrictions mentioned in the above sections, namely that:
 - i. the device for operation in the band 5150–5250 MHz is only for indoor use to reduce the potential for harmful interference to co-channel mobile satellite systems;⁴
 - ii. for devices with detachable antenna(s), the maximum antenna gain permitted for devices in the bands 5250-5350 MHz and 5470-5725 MHz shall be such that the equipment still complies with the e.i.r.p. limit;
 - iii. for devices with detachable antenna(s), the maximum antenna gain permitted for devices in the band 5725-5850 MHz shall be such that the equipment still complies with the e.i.r.p. limits as appropriate; and
 - iv. where applicable, antenna type(s), antenna models(s), and worst-case tilt angle(s) necessary to remain compliant with the e.i.r.p. elevation mask requirement set forth in section 6.2.2.3 shall be clearly indicated.

3.10.2 Judgment

RSS-247 Clause 6.4 a):

The device shall automatically discontinue transmission in cases of absence of information to transmit, or operational failure. Please refer to the declaration

RSS-247 Clause 6.4 b):

The devices must contain security features to protect against modification of software by unauthorized parties. Please refer to the declaration

RSS-247 Clause 6.4 c):

- i). The device operates on 5150-5250MHz is only for indoor use.
- ii). The device operates on 5250-5350MHz/5470-5725MHz, the EIRP meet the requirement.
- iii). The antenna permanently attached to the unit, and all the EIPR compliance with RSS-247 requirement. Please refer to the conducted output power test result.
- iv). Compliant, please refer to the antenna information and output power section.

4. Test DATA AND RESULTS

4.1 AC Line Conducted Emissions

Serial Number:	29L3-1	Test Date:	2023/08/18
Test Site:	CE	Test Mode:	Transmitting maximum output power mode (802.11a mode 5200MHz)
Tester:	David Huang	Test Result:	Pass

Environmental Conditions:

Temperature: (°C)	25.3	Relative Humidity: (%)	65	ATM Pressure: (kPa)	100.5
----------------------	------	------------------------------	----	------------------------	-------

Test Equipment List and Details:

Manufacturer	Description	Model	Serial Number	Calibration Date	Calibration Due Date
R&S	LISN	ENV216	101134	2023/03/31	2024/03/30
R&S	EMI Test Receiver	ESR3	102726	2023/03/31	2024/03/30
MICRO-COAX	Coaxial Cable	UTIFLEX	C-0200-01	2023/08/06	2024/08/05
Audix	Test Software	E3	190306 (V9)	N/A	N/A

* Statement of Traceability: China Certification ICT Co., Ltd (Dongguan) attests that all calibrations have been performed, traceable to National Primary Standards and International System of Units (SI).

Test Data:

Please refer to the below table and plots.

Test Mode: Transmitting
 Port: Line
 Note:

Date: 2023-08-18

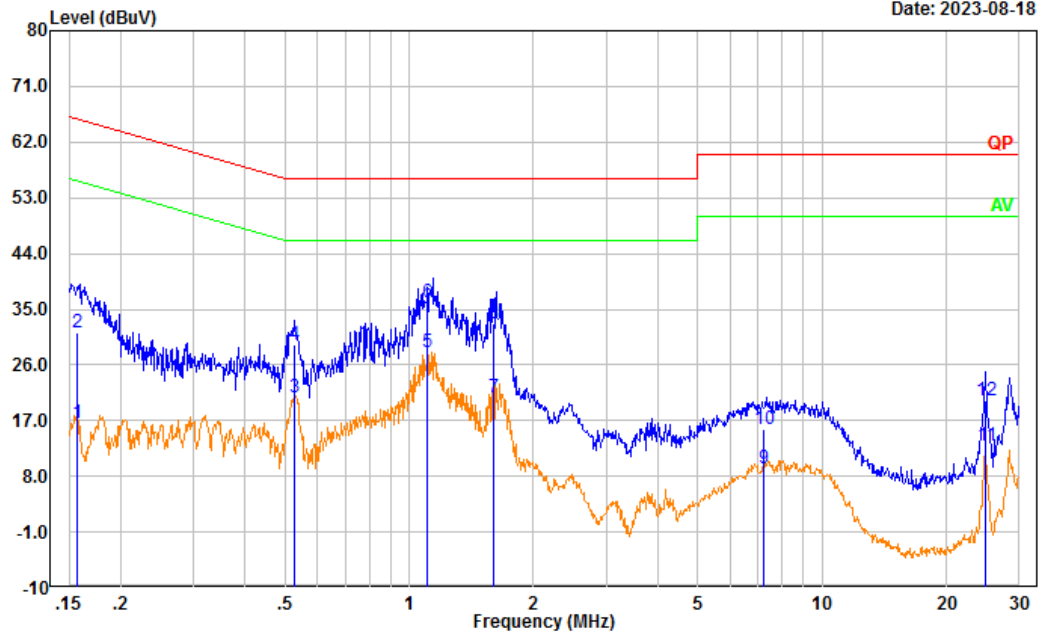

No.	Frequency (MHz)	Reading (dBμV)	Factor (dB)	Result (dBμV)	Limit (dBμV)	Margin (dB)	Detector
1	0.157	7.08	9.61	16.69	55.63	38.94	Average
2	0.157	21.56	9.61	31.17	65.63	34.46	QP
3	0.526	11.08	9.61	20.69	46.00	25.31	Average
4	0.526	19.69	9.61	29.30	56.00	26.70	QP
5	1.108	18.34	9.62	27.96	46.00	18.04	Average
6	1.108	26.47	9.62	36.09	56.00	19.91	QP
7	1.602	10.99	9.63	20.62	46.00	25.38	Average
8	1.602	23.05	9.63	32.68	56.00	23.32	QP
9	7.226	-0.47	9.66	9.19	50.00	40.81	Average
10	7.226	6.00	9.66	15.66	60.00	44.34	QP
11	24.916	3.07	9.81	12.88	50.00	37.12	Average
12	24.916	10.34	9.81	20.15	60.00	39.85	QP

Test Mode: Transmitting
 Port: neutral
 Note:

Date: 2023-08-18

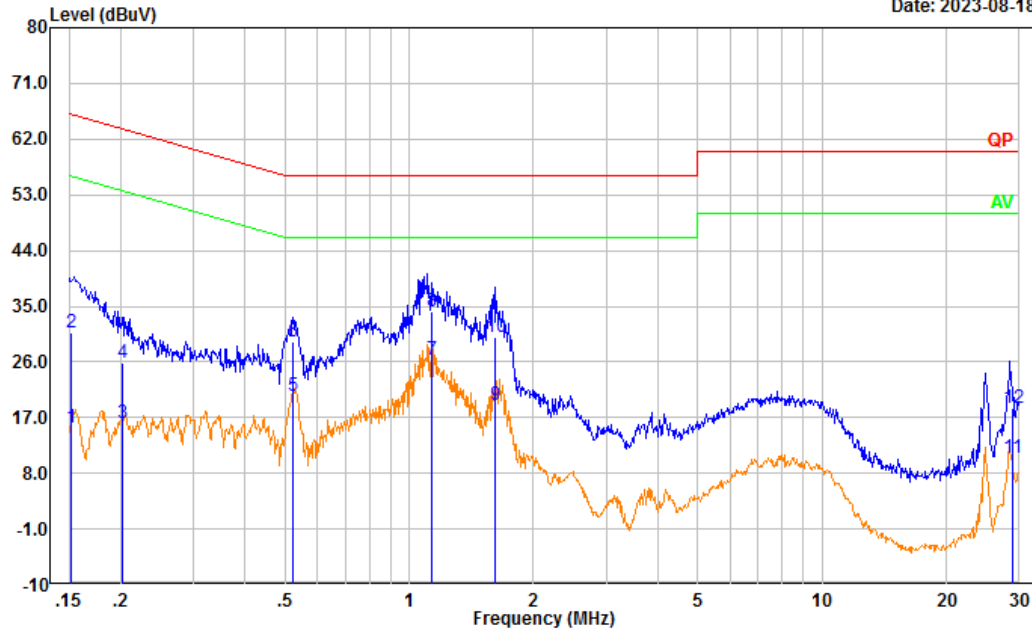

No.	Frequency (MHz)	Reading (dBμV)	Factor (dB)	Result (dBμV)	Limit (dBμV)	Margin (dB)	Detector
1	0.152	5.66	9.61	15.27	55.88	40.61	Average
2	0.152	21.12	9.61	30.73	65.88	35.15	QP
3	0.202	6.56	9.61	16.17	53.54	37.37	Average
4	0.202	16.17	9.61	25.78	63.54	37.76	QP
5	0.525	10.81	9.61	20.42	46.00	25.58	Average
6	0.525	19.57	9.61	29.18	56.00	26.82	QP
7	1.133	16.76	9.62	26.38	46.00	19.62	Average
8	1.133	24.40	9.62	34.02	56.00	21.98	QP
9	1.615	9.29	9.63	18.92	46.00	27.08	Average
10	1.615	20.32	9.63	29.95	56.00	26.05	QP
11	28.820	0.78	9.81	10.59	50.00	39.41	Average
12	28.820	8.67	9.81	18.48	60.00	41.52	QP

4.2 Radiation Spurious Emissions

Serial Number:	29L3-4	Test Date:	2023/8/28~2023/8/31
Test Site:	966-1/966-2	Test Mode:	Transmitting
Tester:	Carl Xue, Tao Zhu	Test Result:	Pass

Environmental Conditions:

Temperature: (°C)	25.8~26.3	Relative Humidity: (%)	59~62	ATM Pressure: (kPa)	99.7~100.1
----------------------	-----------	------------------------------	-------	------------------------	------------

Test Equipment List and Details:

Manufacturer	Description	Model	Serial Number	Calibration Date	Calibration Due Date
Sunol Sciences	Antenna	JB6	A082520-5	2020/10/19	2023/10/18
R&S	EMI Test Receiver	ESR3	102724	2023/3/31	2024/3/30
TIMES MICROWAVE	Coaxial Cable	LMR-600-UltraFlex	C-0470-02	2023/7/16	2024/7/15
TIMES MICROWAVE	Coaxial Cable	LMR-600-UltraFlex	C-0780-01	2023/7/16	2024/7/15
Sonoma	Amplifier	310N	186165	2023/7/16	2024/7/15
ETS-Lindgren	Horn Antenna	3115	9912-5985	2020/10/13	2023/10/12
R&S	Spectrum Analyzer	FSV40	101591	2023/3/31	2024/3/30
MICRO-COAX	Coaxial Cable	UFA210A-1-1200-70U300	217423-008	2023/8/6	2024/8/5
MICRO-COAX	Coaxial Cable	UFA210A-1-2362-300300	235780-001	2023/8/6	2024/8/5
Mini	Pre-amplifier	ZVA-183-S+	5969001149	2022/11/9	2023/11/8
Audix	Test Software	E3	201021 (V9)	N/A	N/A
PASTERNAK	Horn Antenna	PE9852/2F-20	112002	2021/2/5	2024/2/4
Quinstar	Preamplifier	QLW-18405536-JO	15964001005	2022/9/16	2023/9/15
MICRO-COAX	Coaxial Cable	UFB142A-1-2362-200200	235772-001	2023/8/6	2024/8/5
E-Microwave	Band Rejection Filter	5150-5850MHz	OE01902423	2023/8/6	2024/8/5
Mini Circuits	High Pass Filter	VHF-6010+	31119	2023/8/6	2024/8/5
PASTERNAK	Horn Antenna	PE9850/2F-20	072001	2021/2/5	2024/2/4

* Statement of Traceability: China Certification ICT Co., Ltd (Dongguan) attests that all calibrations have been performed, traceable to National Primary Standards and International System of Units (SI).

Test Data:

Please refer to the below table and plots.

After pre-scan in the X, Y and Z axes of orientation, the worst case is below:

1) 30MHz-1GHz :maximum output power mode (802.11a mode 5200MHz)

Project No.: CR230745207-RF
 Tester: Carl Xue
 Polarization: horizontal
 Note:

Date: 2023-08-31

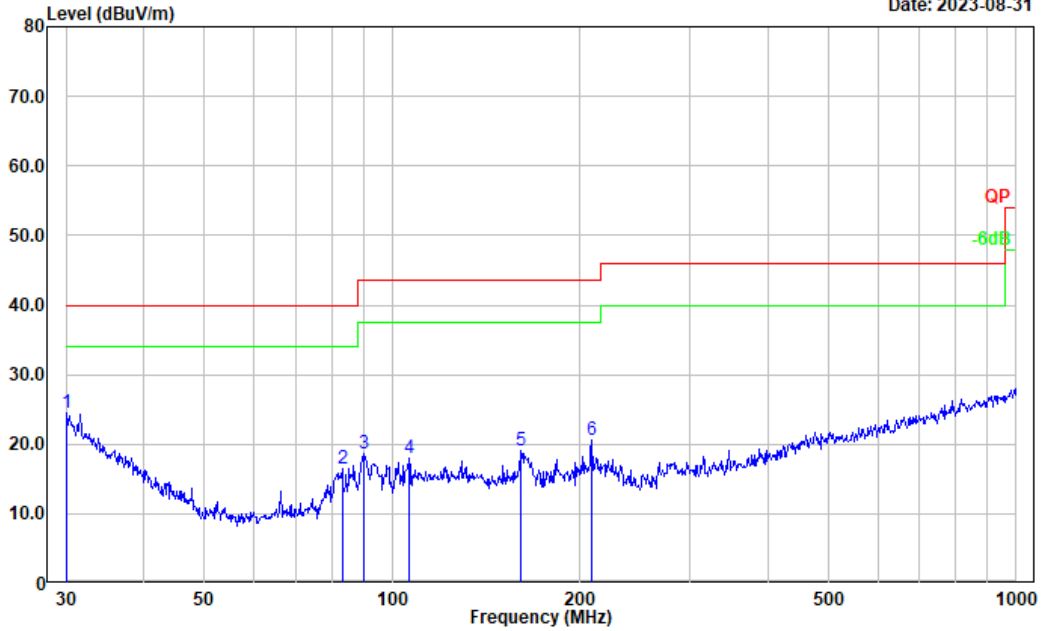

No.	Frequency (MHz)	Reading (dBuV)	Factor (dB/m)	Result (dBuV/m)	Limit (dBuV/m)	Margin (dB)	Detector
1	30.105	28.23	-3.68	24.55	40.00	15.45	Peak
2	83.230	33.71	-17.23	16.48	40.00	23.52	Peak
3	90.220	35.58	-16.87	18.71	43.50	24.79	Peak
4	106.385	30.98	-13.07	17.91	43.50	25.59	Peak
5	160.909	31.21	-12.15	19.06	43.50	24.44	Peak
6	208.580	32.96	-12.44	20.52	43.50	22.98	Peak

Project No.: CR230745207-RF
 Tester: Carl Xue
 Polarization: vertical
 Note:

Date: 2023-08-31

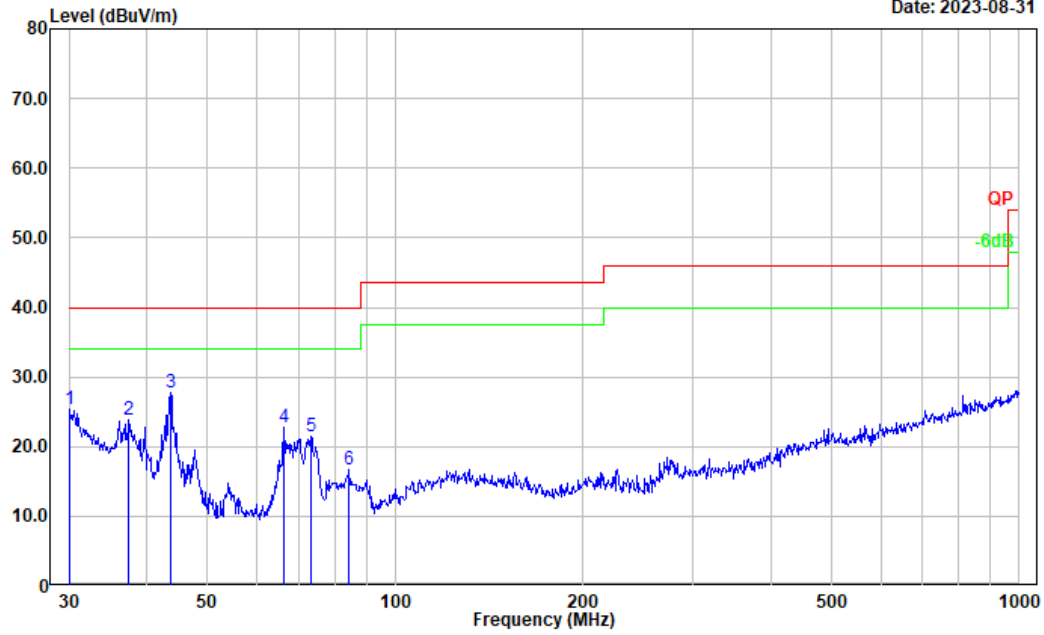

No.	Frequency (MHz)	Reading (dBμV)	Factor (dB/m)	Result (dBμV/m)	Limit (dBμV/m)	Margin (dB)	Detector
1	30.000	28.99	-3.60	25.39	40.00	14.61	Peak
2	37.416	33.06	-9.31	23.75	40.00	16.25	Peak
3	43.659	41.20	-13.46	27.74	40.00	12.26	Peak
4	66.266	39.61	-16.84	22.77	40.00	17.23	Peak
5	73.103	38.12	-16.75	21.37	40.00	18.63	Peak
6	84.405	33.85	-17.22	16.63	40.00	23.37	Peak

**2) 1GHz-40GHz:
5150-5250MHz
802.11a:**

Frequency (MHz)	Receiver		Polar (H/V)	Factor (dB/m)	Result (dB μ V/m)	Limit (dB μ V/m)	Margin (dB)
	Reading (dB μ V)	Detector					
Low Channel: 5180 MHz							
5150.000	26.98	PK	H	38.64	59.60	74.00	14.40
5150.000	14.78	AV	H	38.64	47.40	54.00	6.60
10360.000	38.62	PK	H	19.18	51.78	68.20	16.42
15540.000	37.47	PK	H	22.44	53.89	74.00	20.11
15540.000	25.40	AV	H	22.44	41.82	54.00	12.18
Middle Channel: 5200 MHz							
10400.000	39.07	PK	H	19.16	52.21	68.20	15.99
15600.000	37.11	PK	H	22.41	53.50	74.00	20.50
15600.000	25.72	AV	H	22.41	42.11	54.00	11.89
High Channel: 5240 MHz							
5350.000	26.17	PK	H	39.03	59.18	74.00	14.82
5350.000	13.54	AV	H	39.03	46.55	54.00	7.45
10480.000	37.85	PK	H	18.86	50.69	68.20	17.51
15720.000	36.25	PK	H	22.28	52.51	74.00	21.49
15720.000	24.56	AV	H	22.28	40.82	54.00	13.18

802.11n ht20:

Frequency (MHz)	Receiver		Polar (H/V)	Factor (dB/m)	Result (dB μ V/m)	Limit (dB μ V/m)	Margin (dB)
	Reading (dB μ V)	Detector					
Low Channel: 5180MHz							
5150.000	34.47	PK	H	38.64	67.09	74.00	6.91
5150.000	15.21	AV	H	38.64	47.83	54.00	6.17
10360.000	37.86	PK	H	19.18	51.02	68.20	17.18
15540.000	37.30	PK	H	22.44	53.72	74.00	20.28
15540.000	25.60	AV	H	22.44	42.02	54.00	11.98
Middle Channel: 5200 MHz							
10400.000	39.37	PK	H	19.16	52.51	68.20	15.69
15600.000	36.99	PK	H	22.41	53.38	74.00	20.62
15600.000	25.51	AV	H	22.41	41.90	54.00	12.10
High Channel: 5240 MHz							
5350.000	26.09	PK	H	39.03	59.10	74.00	14.90
5350.000	13.90	AV	H	39.03	46.91	54.00	7.09
10480.000	38.04	PK	H	18.86	50.88	68.20	17.32
15720.000	36.43	PK	H	22.28	52.69	74.00	21.31
15720.000	24.66	AV	H	22.28	40.92	54.00	13.08

802.11n ht40:

Frequency (MHz)	Receiver		Polar (H/V)	Factor (dB/m)	Result (dB μ V/m)	Limit (dB μ V/m)	Margin (dB)
	Reading (dB μ V)	Detector					
Low Channel: 5190 MHz							
5150.000	35.30	PK	H	38.64	67.92	74.00	6.08
5150.000	17.41	AV	H	38.64	50.03	54.00	3.97
10380.000	36.95	PK	H	19.17	50.10	68.20	18.10
15570.000	37.06	PK	H	22.43	53.47	74.00	20.53
15570.000	25.09	AV	H	22.43	41.50	54.00	12.50
High Channel: 5230 MHz							
5350.000	26.82	PK	H	39.03	59.83	74.00	14.17
5350.000	14.07	AV	H	39.03	47.08	54.00	6.92
10460.000	37.17	PK	H	18.94	50.09	68.20	18.11
15690.000	36.72	PK	H	22.29	52.99	74.00	21.01
15690.000	24.65	AV	H	22.29	40.92	54.00	13.08

802.11 ac vht80:

Frequency (MHz)	Receiver		Polar (H/V)	Factor (dB/m)	Result (dB μ V/m)	Limit (dB μ V/m)	Margin (dB)
	Reading (dB μ V)	Detector					
Middle Channel: 5210 MHz							
5150.000	34.02	PK	H	38.64	66.64	74.00	7.36
5150.000	18.13	AV	H	38.64	50.75	54.00	3.25
5350.000	26.68	PK	H	39.03	59.69	74.00	14.31
5350.000	14.72	AV	H	39.03	47.73	54.00	6.27
10420.000	36.37	PK	H	19.09	49.44	68.20	18.76
15630.000	37.11	PK	H	22.37	53.46	74.00	20.54
15630.000	25.48	AV	H	22.37	41.83	54.00	12.17

Note:

Result = Reading + Factor- Distance extrapolation Factor

For 1-40GHz:

Distance extrapolation Factor = $20 \log (\text{specific distance [3m]}/\text{test distance [1.5m]})$ dB = 6.02 dB

5725-5850MHz:**802.11a:**

Frequency (MHz)	Receiver		Polar (H/V)	Factor (dB/m)	Result (dB μ V/m)	Limit (dB μ V/m)	Margin (dB)
	Reading (dB μ V)	Detector					
Low Channel: 5745MHz							
5725.000	43.07	PK	H	39.48	76.53	122.20	45.67
5720.000	35.77	PK	H	39.49	69.24	110.80	41.56
5700.000	24.93	PK	H	39.51	58.42	105.20	46.78
5650.000	24.57	PK	H	39.49	58.04	68.20	10.16
11490.000	36.09	PK	H	20.67	50.74	74.00	23.26
11490.000	24.84	AV	H	20.67	39.49	54.00	14.51
17235.000	31.96	PK	H	26.76	52.70	68.20	15.50
Middle Channel: 5785 MHz							
11570.000	36.43	PK	H	20.83	51.24	74.00	22.76
11570.000	25.09	AV	H	20.83	39.90	54.00	14.10
17355.000	28.32	PK	H	27.74	50.04	68.20	18.16
High Channel: 5825 MHz							
5850.000	29.38	PK	H	39.49	62.85	122.20	59.35
5855.000	26.05	PK	H	39.51	59.54	110.80	51.26
5875.000	25.33	PK	H	39.60	58.91	105.20	46.29
5925.000	25.01	PK	H	39.68	58.67	68.20	9.53
11650.000	37.52	PK	H	21.07	52.57	74.00	21.43
11650.000	25.32	AV	H	21.07	40.37	54.00	13.63
17475.000	29.59	PK	H	28.61	52.18	68.20	16.02

802.11n ht20:

Frequency (MHz)	Receiver		Polar (H/V)	Factor (dB/m)	Result (dB μ V/m)	Limit (dB μ V/m)	Margin (dB)
	Reading (dB μ V)	Detector					
Low Channel: 5745MHz							
5725.000	44.07	PK	H	39.48	77.53	122.20	44.67
5720.000	35.86	PK	H	39.49	69.33	110.80	41.47
5700.000	24.90	PK	H	39.51	58.39	105.20	46.81
5650.000	25.17	PK	H	39.49	58.64	68.20	9.56
11490.000	35.41	PK	H	20.67	50.06	74.00	23.94
11490.000	23.28	AV	H	20.67	37.93	54.00	16.07
17235.000	39.36	PK	H	26.76	60.10	68.20	8.10
Middle Channel: 5785 MHz							
11570.000	35.90	PK	H	20.83	50.71	74.00	23.29
11570.000	23.20	AV	H	20.83	38.01	54.00	15.99
17355.000	35.81	PK	H	27.74	57.53	68.20	10.67
High Channel: 5825 MHz							
5850.000	32.72	PK	H	39.49	66.19	122.20	56.01
5855.000	29.06	PK	H	39.51	62.55	110.80	48.25
5875.000	26.33	PK	H	39.60	59.91	105.20	45.29
5925.000	25.52	PK	H	39.68	59.18	68.20	9.02
11650.000	34.85	PK	H	21.07	49.90	74.00	24.10
11650.000	23.86	AV	H	21.07	38.91	54.00	15.09
17475.000	40.23	PK	H	28.61	62.82	68.20	5.38

802.11n ht40:

Frequency (MHz)	Receiver		Polar (H/V)	Factor (dB/m)	Result (dBµV/m)	Limit (dBµV/m)	Margin (dB)
	Reading (dBµV)	Detector					
Low Channel: 5755 MHz							
5725.000	43.52	PK	H	39.48	76.98	122.20	45.22
5720.000	43.06	PK	H	39.49	76.53	110.80	34.27
5700.000	30.64	PK	H	39.51	64.13	105.20	41.07
5650.000	26.39	PK	H	39.49	59.86	68.20	8.34
11510.000	35.65	PK	H	20.67	50.30	74.00	23.70
11510.000	23.97	AV	H	20.67	38.62	54.00	15.38
17265.000	30.00	PK	H	26.94	50.92	68.20	17.28
High Channel: 5795 MHz							
5850.000	36.39	PK	H	39.49	69.86	122.20	52.34
5855.000	33.74	PK	H	39.51	67.23	110.80	43.57
5875.000	28.54	PK	H	39.60	62.12	105.20	43.08
5925.000	27.52	PK	H	39.68	61.18	68.20	7.02
11590.000	36.71	PK	H	20.88	51.57	74.00	22.43
11590.000	24.68	AV	H	20.88	39.54	54.00	14.46
17385.000	26.22	PK	H	28.07	48.27	68.20	19.93

802.11 ac vht80:

Frequency (MHz)	Receiver		Polar (H/V)	Factor (dB/m)	Result (dBµV/m)	Limit (dBµV/m)	Margin (dB)
	Reading (dBµV)	Detector					
Middle Channel: 5775 MHz							
5725.000	44.26	PK	H	39.48	77.72	122.20	44.48
5720.000	43.85	PK	H	39.49	77.32	110.80	33.48
5700.000	41.05	PK	H	39.51	74.54	105.20	30.66
5650.000	28.00	PK	H	39.49	61.47	68.20	6.73
5850.000	41.26	PK	H	39.49	74.73	122.20	47.47
5855.000	40.87	PK	H	39.51	74.36	110.80	36.44
5875.000	37.64	PK	H	39.60	71.22	105.20	33.98
5925.000	27.30	PK	H	39.68	60.96	68.20	7.24
11550.000	34.51	PK	H	20.78	49.27	74.00	24.73
11550.000	23.24	AV	H	20.78	38.00	54.00	16.00
17325.000	28.79	PK	H	27.41	50.18	68.20	18.02

Note:

Result = Reading + Factor- Distance extrapolation Factor

For I-40GHz:

Distance extrapolation Factor = $20 \log (\text{specific distance [3m]}/\text{test distance [1.5m]}) \text{ dB} = 6.02 \text{ dB}$

Worst Test plots(802.11n ht20 5785MHz)



Vertical

1-18GHz

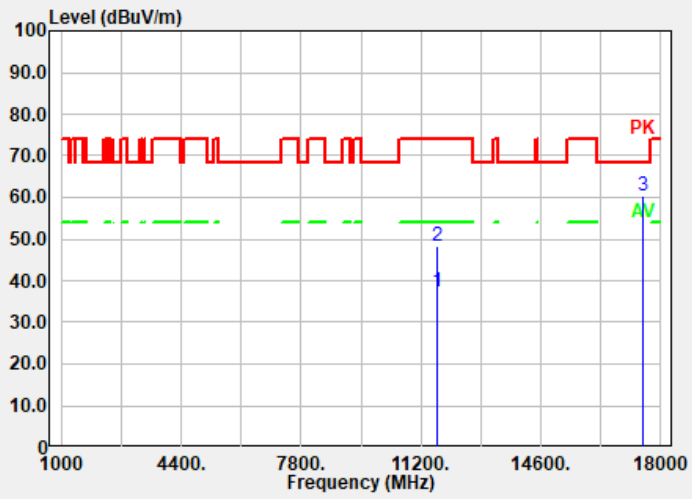

18-40GHz

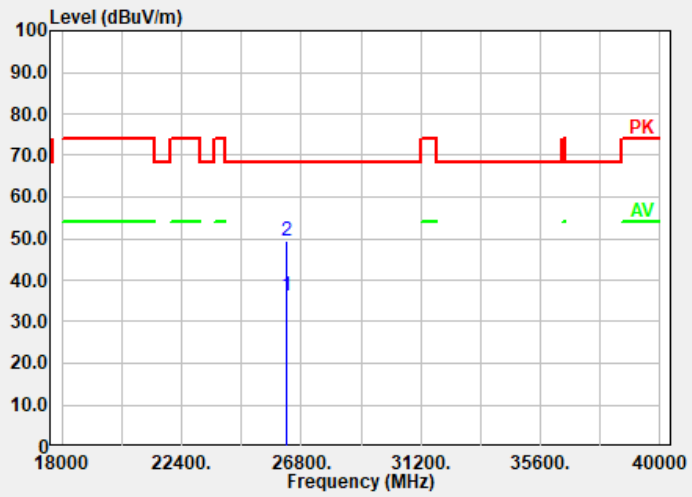

Worst Band edge Test plots (AC80 5775MHz)

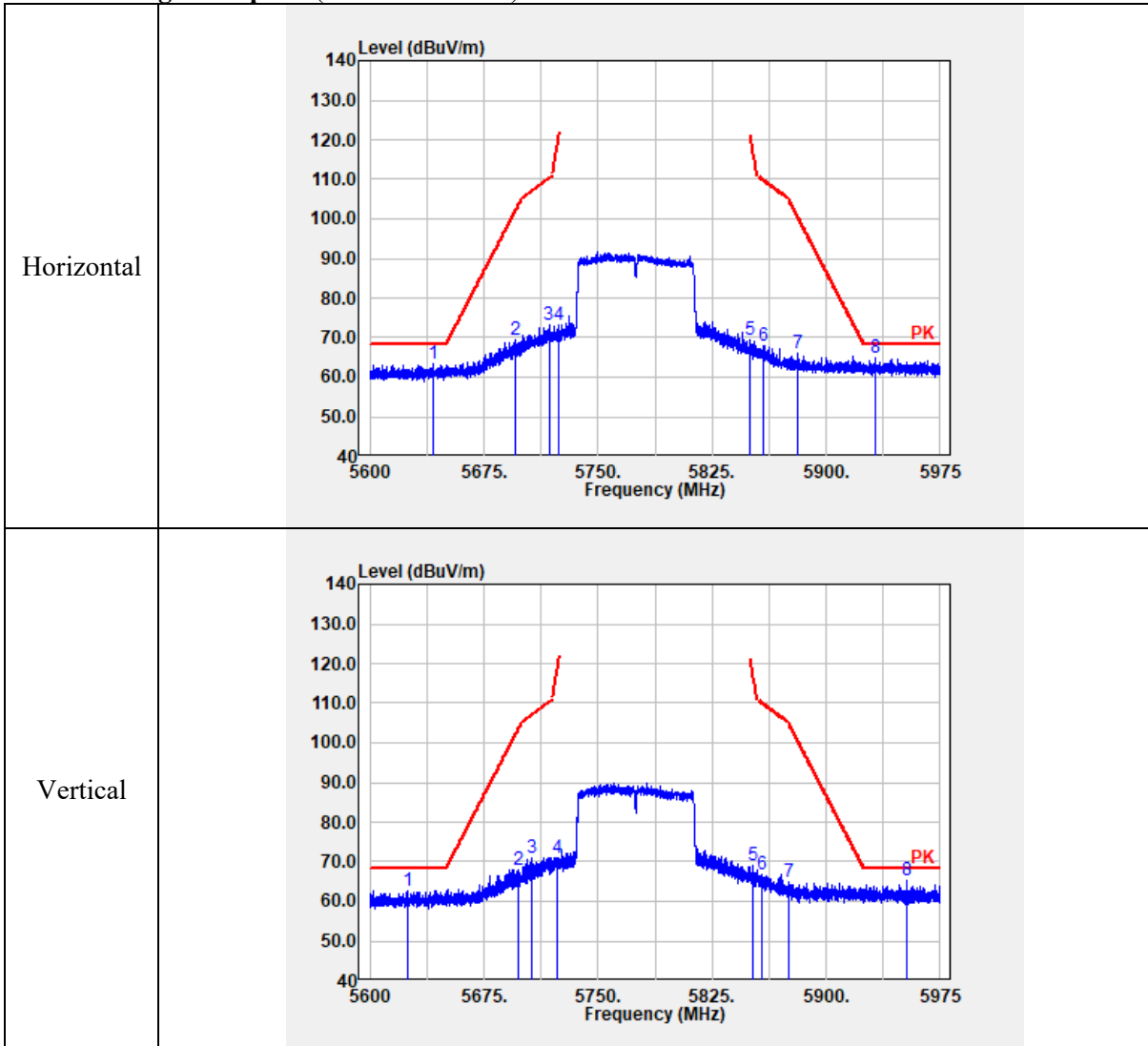

4.3 26dB attenuated below the channel power

Serial Number:	29L3-1	Test Date:	2023/10/7
Test Site:	RF	Test Mode:	Transmitting
Tester:	Jou Zhou	Test Result:	Pass

Environmental Conditions:

Temperature: (°C)	26.4	Relative Humidity: (%)	67	ATM Pressure: (kPa)	100.4
----------------------	------	------------------------------	----	------------------------	-------

Test Equipment List and Details:

Manufacturer	Description	Model	Serial Number	Calibration Date	Calibration Due Date
R&S	Spectrum Analyzer	FSV40	101943	2023/3/31	2024/3/30
zhuoxiang	Coaxial Cable	SMA-178	211002	Each time	N/A
HuiXunDa	DC Block	SMA-JK 18G	DCB181108042	Each time	N/A

* Statement of Traceability: China Certification ICT Co., Ltd (Dongguan) attests that all calibrations have been performed, traceable to National Primary Standards and International System of Units (SI).

Test Data:

Note: the requirement is for 5150-5250 MHz band. The channel power please refer to the power test result in section 4.5.

5150-5250MHz:

26dB attenuated below the channel power

802.11a
Lowest Channel

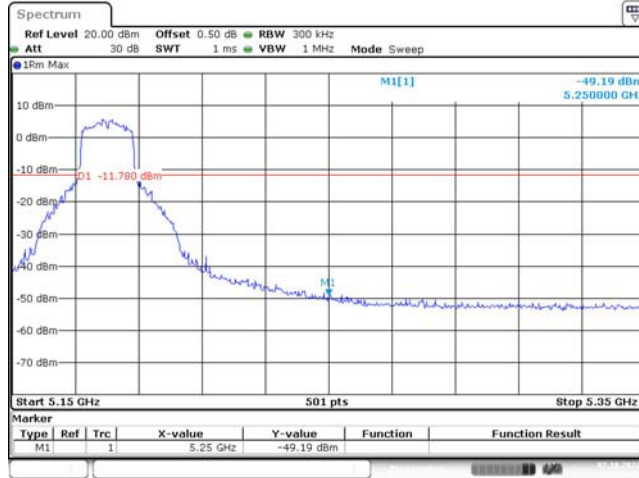

ProjectNo.:CR230745207 Tester:Jou Zhou
Date: 7.OCT.2023 11:04:37

802.11a
Middle Channel

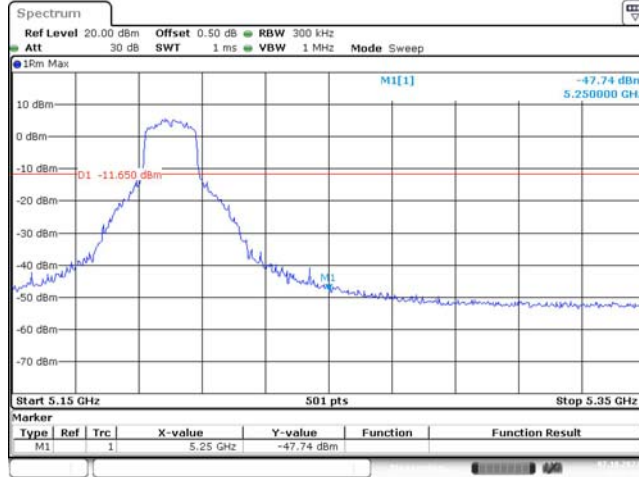

ProjectNo.:CR230745207 Tester:Jou Zhou
Date: 7.OCT.2023 11:07:05

802.11a
Highest Channel

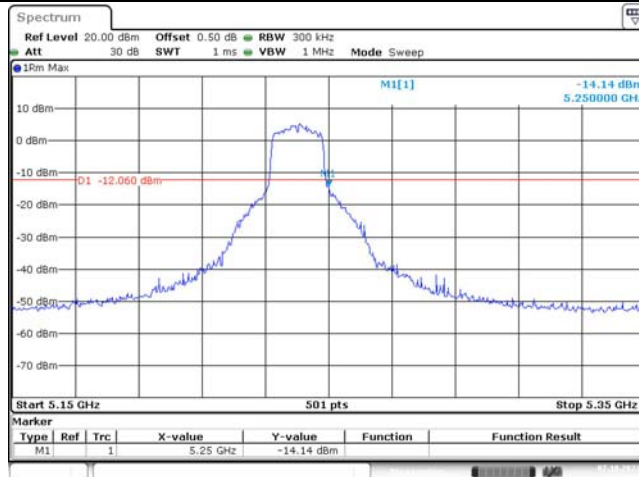

ProjectNo.:CR230745207 Tester:Jou Zhou
Date: 7.OCT.2023 11:08:27

26dB attenuated below the channel power

802.11n ht20
Lowest Channel

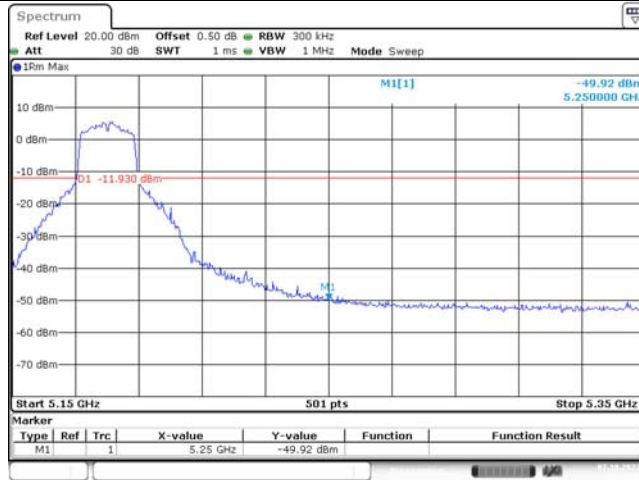

ProjectNo.:CR230745207 Tester:Jou Zhou
Date: 7.OCT.2023 11:10:34

802.11n ht20
Middle Channel

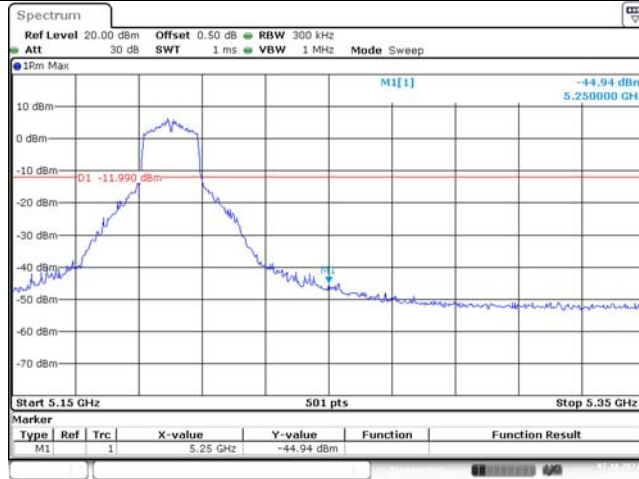

ProjectNo.:CR230745207 Tester:Jou Zhou
Date: 7.OCT.2023 11:12:59

802.11n ht20
Highest Channel

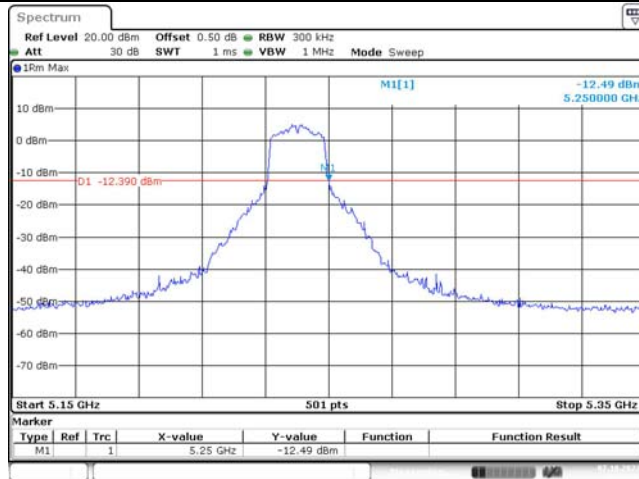

ProjectNo.:CR230745207 Tester:Jou Zhou
Date: 7.OCT.2023 11:14:18

26dB attenuated below the channel power

802.11n ht40
Lowest Channel

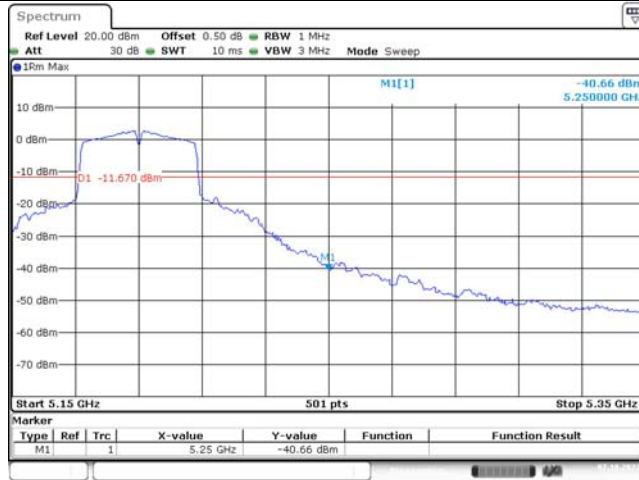

ProjectNo.:CR230745207 Tester:Jou Zhou
Date: 7.OCT.2023 11:16:13

802.11n ht40
Highest Channel

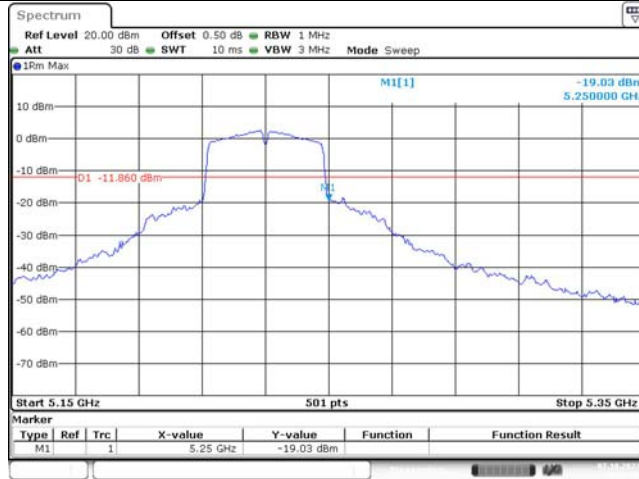

ProjectNo.:CR230745207 Tester:Jou Zhou
Date: 7.OCT.2023 11:17:09

802.11ac80
Middle Channel

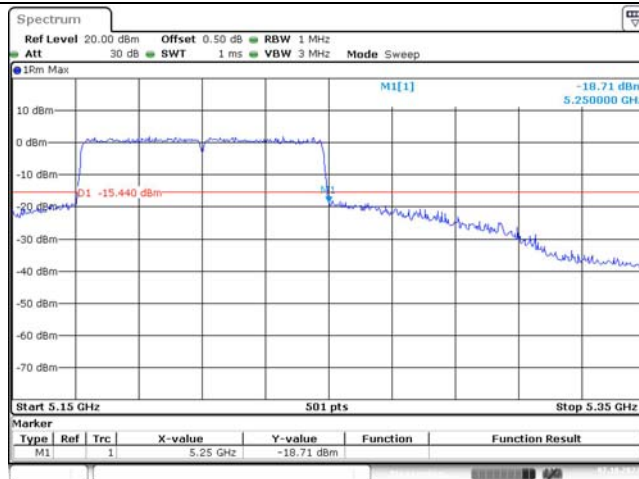

ProjectNo.:CR230745207 Tester:Jou Zhou
Date: 7.OCT.2023 11:19:05

4.4 Emission Bandwidth:

Serial Number:	29L3-1	Test Date:	2023/9/23~2023/10/7
Test Site:	RF	Test Mode:	Transmitting
Tester:	Jou Zhou	Test Result:	Pass

Environmental Conditions:

Temperature: (°C)	25.8~26.4	Relative Humidity: (%)	61~67	ATM Pressure: (kPa)	100.2~100.7
----------------------	-----------	------------------------------	-------	------------------------	-------------

Test Equipment List and Details:

Manufacturer	Description	Model	Serial Number	Calibration Date	Calibration Due Date
R&S	Spectrum Analyzer	FSV40	101943	2023/3/31	2024/3/30
zhuoxiang	Coaxial Cable	SMA-178	211002	Each time	N/A
HuiXunDa	DC Block	SMA-JK 18G	DCB181108042	Each time	N/A

* Statement of Traceability: China Certification ICT Co., Ltd (Dongguan) attests that all calibrations have been performed, traceable to National Primary Standards and International System of Units (SI).

Test Data:

5150-5250 MHz:

Test Modes	Test Frequency (MHz)	26 dB Bandwidth (MHz)	99% Occupied Bandwidth (MHz)
802.11a	5180	34.40	17.96
	5200	33.13	17.96
	5240	33.18	17.88
802.11n ht20	5180	39.85	18.60
	5200	36.99	18.84
	5240	34.22	18.52
802.11n ht40	5190	85.97	39.60
	5230	87.51	39.12
802.11ac vht80	5210	195.51	76.97
Note: The 99% Occupied Bandwidth have not fall into the band 5250-5350MHz, please refer to the test plots of 99% Occupied Bandwidth			

5725-5850 MHz:

Test Modes	Test Frequency (MHz)	6 dB Bandwidth (MHz)	99% Occupied Bandwidth (MHz)
802.11a	5745	16.35	17.49
	5785	15.55	17.65
	5825	15.57	17.17
802.11n ht20	5745	15.41	18.44
	5785	15.59	18.52
	5825	15.32	18.36
802.11n ht40	5755	35.90	39.12
	5795	35.97	39.28
802.11ac vht80	5775	76.90	76.97
Note:6dB Emission Bandwidth Limit: ≥ 0.5 MHz The 99% Occupied Bandwidth have not fall into the band 5470-5725MHz, please refer to the test plots of 99% Occupied Bandwidth.			

5150-5250MHz:

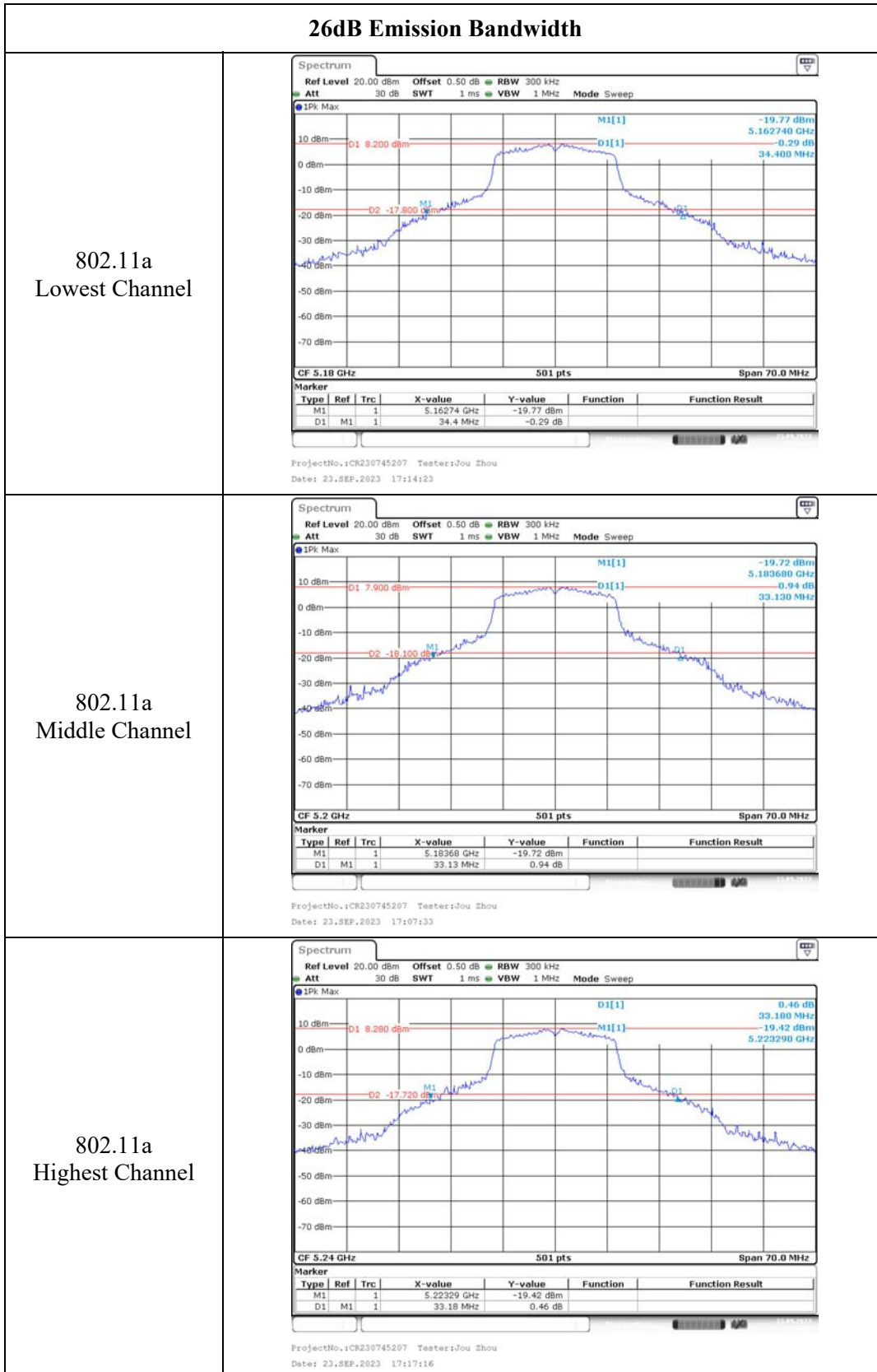

26dB Emission Bandwidth

802.11n ht20
Lowest Channel

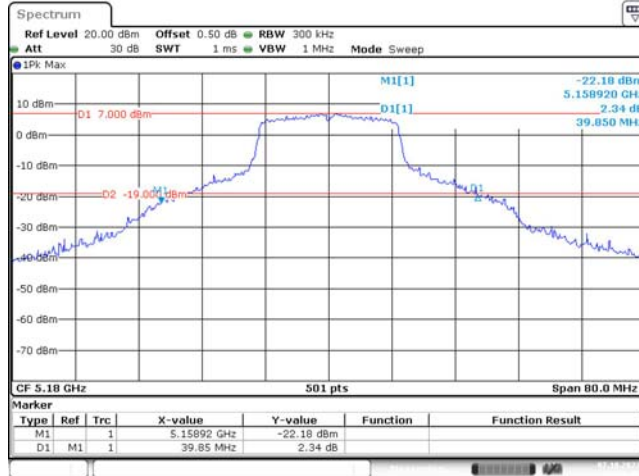

ProjectNo.:CR230745207 Testeri:Jou Zhou
Date: 7.OCT.2023 09:26:09

802.11n ht20
Middle Channel

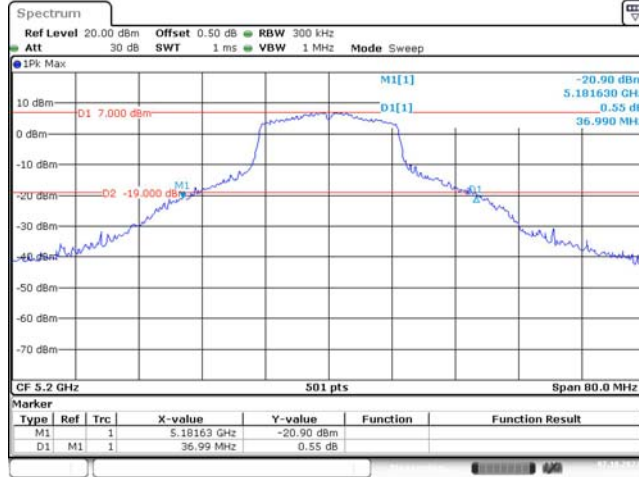

ProjectNo.:CR230745207 Testeri:Jou Zhou
Date: 7.OCT.2023 09:31:27

802.11n ht20
Highest Channel

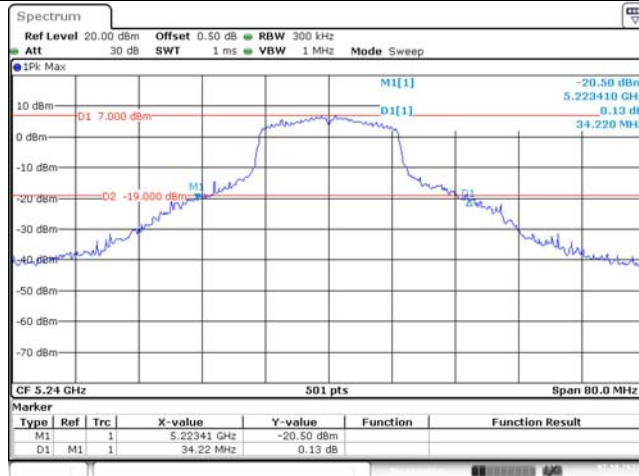

ProjectNo.:CR230745207 Testeri:Jou Zhou
Date: 7.OCT.2023 09:34:41

26dB Emission Bandwidth

802.11n ht40
Lowest Channel

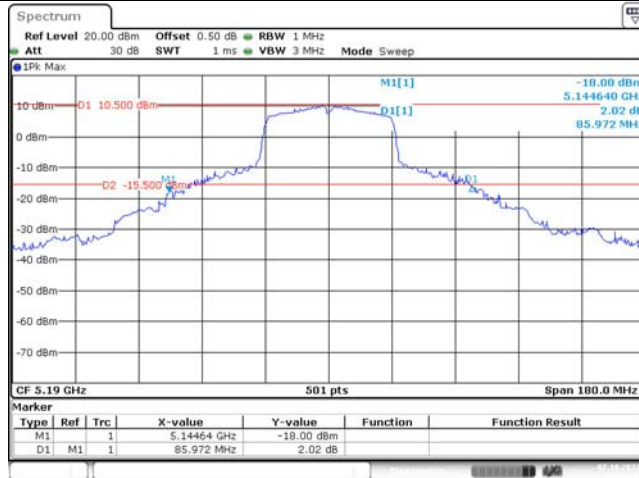

ProjectNo.:CR230745207 Testeri:Jou Zhou
Date: 7.OCT.2023 09:50:49

802.11n ht40
Highest Channel

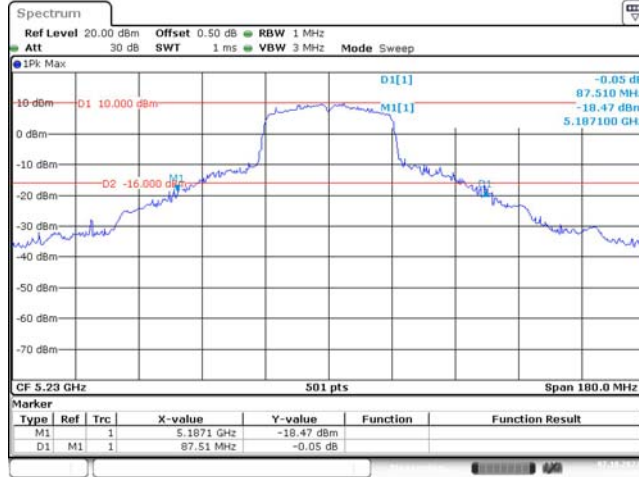

ProjectNo.:CR230745207 Testeri:Jou Zhou
Date: 7.OCT.2023 09:53:42

802.11ac80
Middle Channel

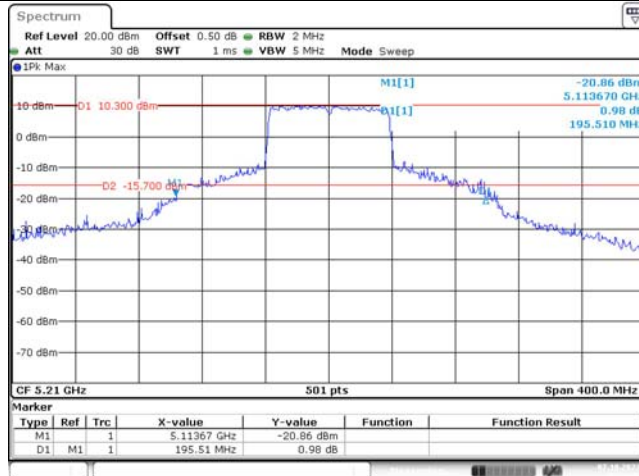

ProjectNo.:CR230745207 Testeri:Jou Zhou
Date: 7.OCT.2023 10:16:43

99% Emission Bandwidth

802.11a
Lowest Channel



ProjectNo.:ICR230745207 Testeri:Jou Zhou
Date: 7.OCT.2023 11:20:20

802.11a
Middle Channel



ProjectNo.:ICR230745207 Testeri:Jou Zhou
Date: 7.OCT.2023 11:21:03

802.11a
Highest Channel

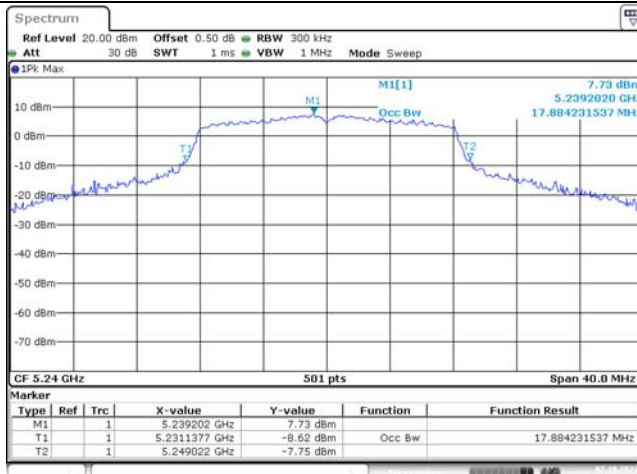

ProjectNo.:ICR230745207 Testeri:Jou Zhou
Date: 7.OCT.2023 11:21:58

99% Emission Bandwidth

802.11n ht20
Lowest Channel

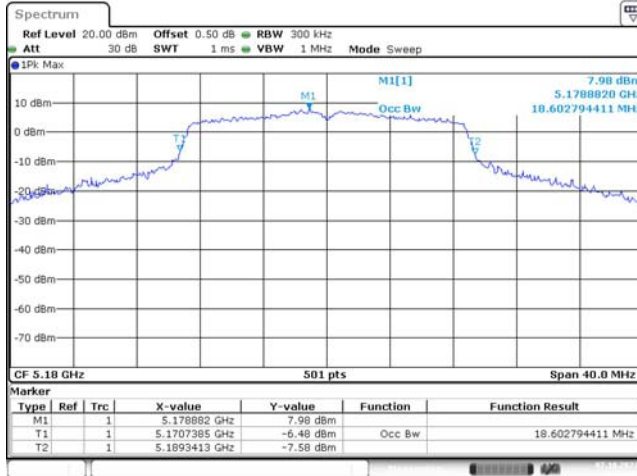

ProjectNo.:ICR230745207 Testeri:Jou Zhou
Date: 7.OCT.2023 11:22:48

802.11n ht20
Middle Channel

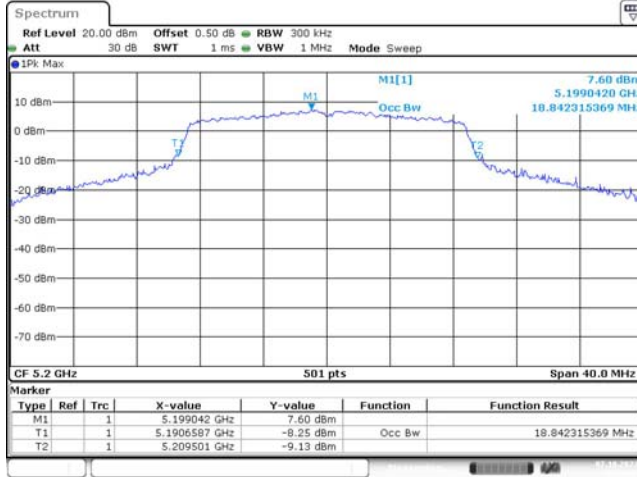

ProjectNo.:ICR230745207 Testeri:Jou Zhou
Date: 7.OCT.2023 11:23:22

802.11n ht20
Highest Channel

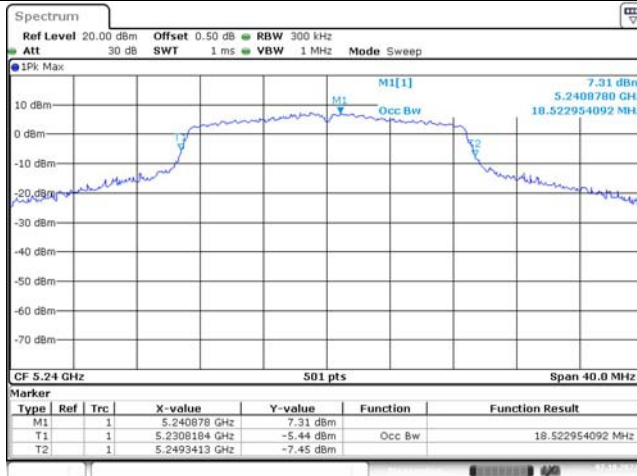

ProjectNo.:ICR230745207 Testeri:Jou Zhou
Date: 7.OCT.2023 11:24:02

99% Emission Bandwidth

802.11n ht40
Lowest Channel



ProjectNo.:CR230745207 Tester:Jou Zhou
Date: 7.OCT.2023 11:24:53

802.11n ht40
Highest Channel

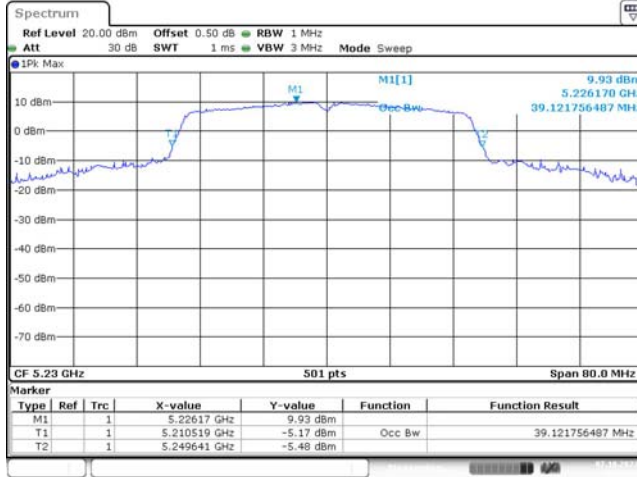

ProjectNo.:CR230745207 Tester:Jou Zhou
Date: 7.OCT.2023 11:25:34

802.11ac80
Middle Channel

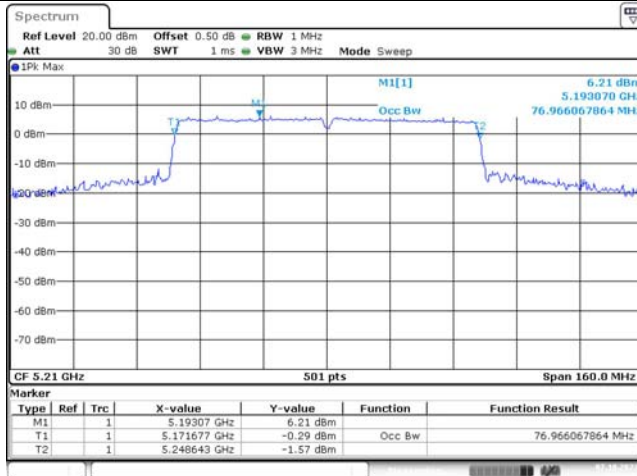

ProjectNo.:CR230745207 Tester:Jou Zhou
Date: 7.OCT.2023 11:26:40

5725-5850MHz:

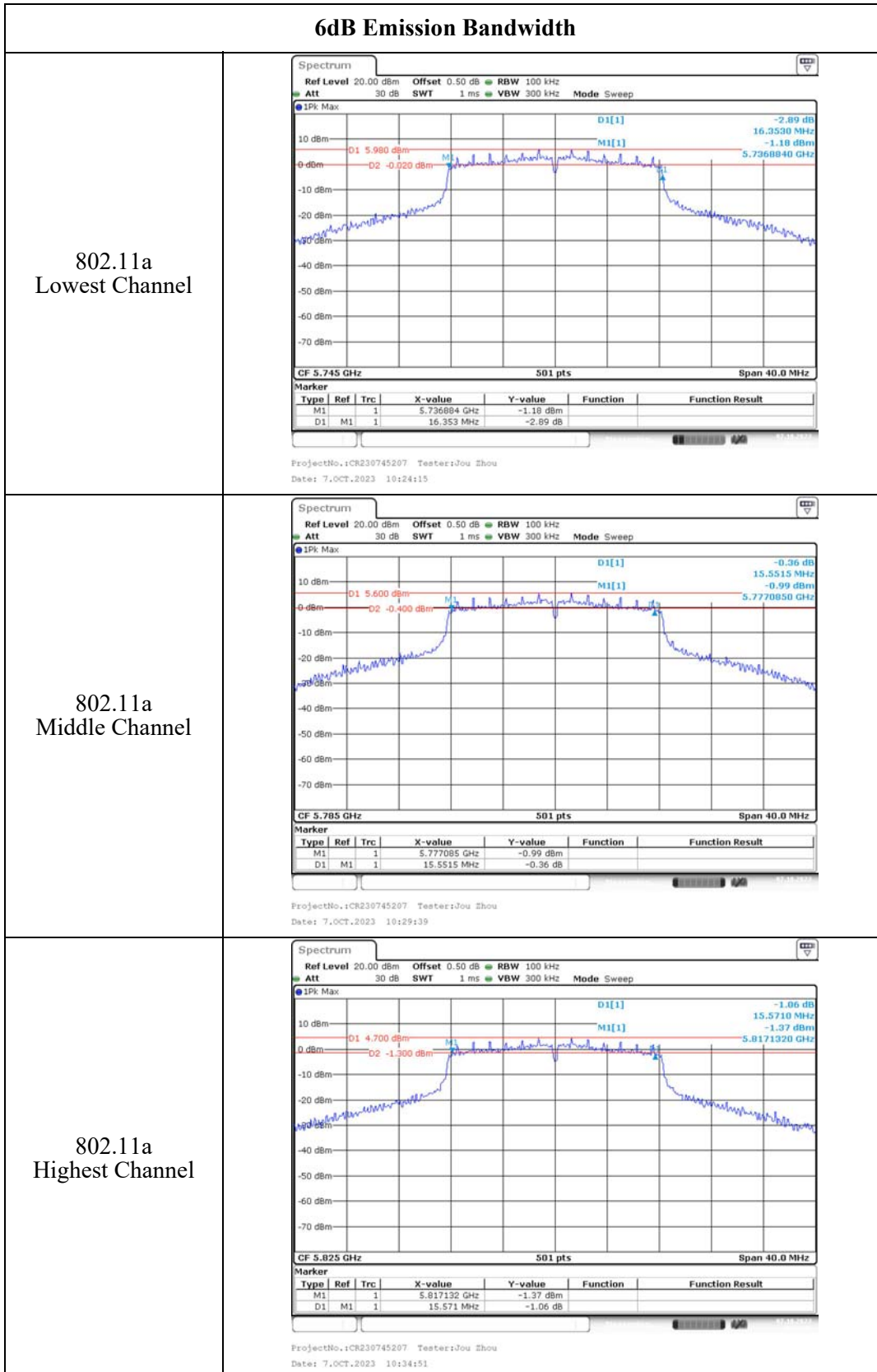

6dB Emission Bandwidth

802.11n ht20
Lowest Channel

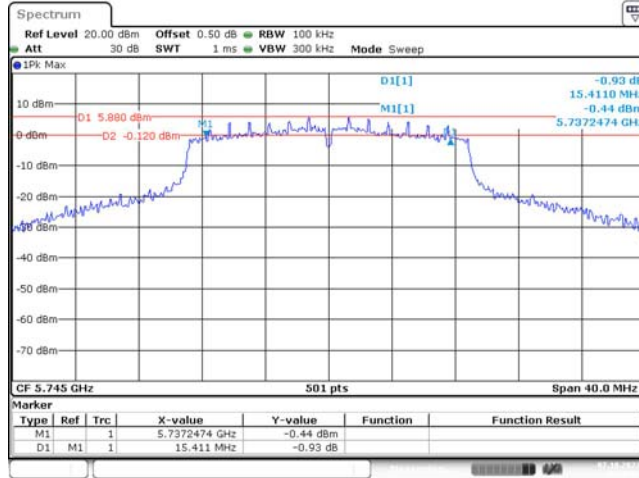

802.11n ht20
Middle Channel

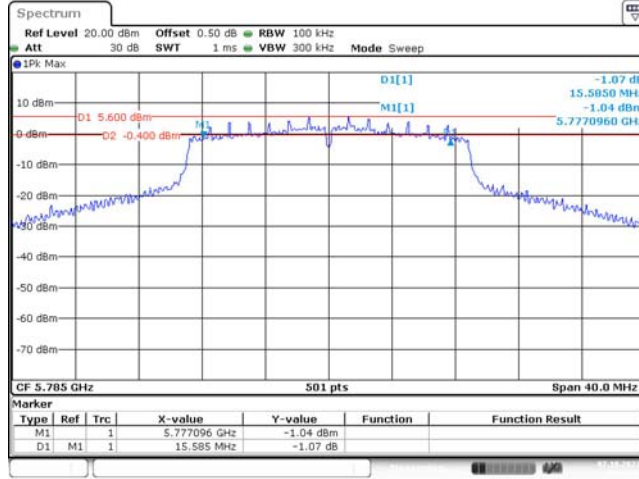

802.11n ht20
Highest Channel

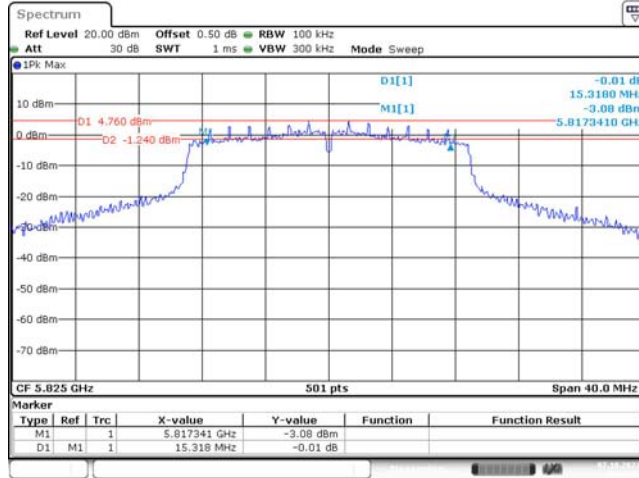

6dB Emission Bandwidth

802.11n ht40
Lowest Channel

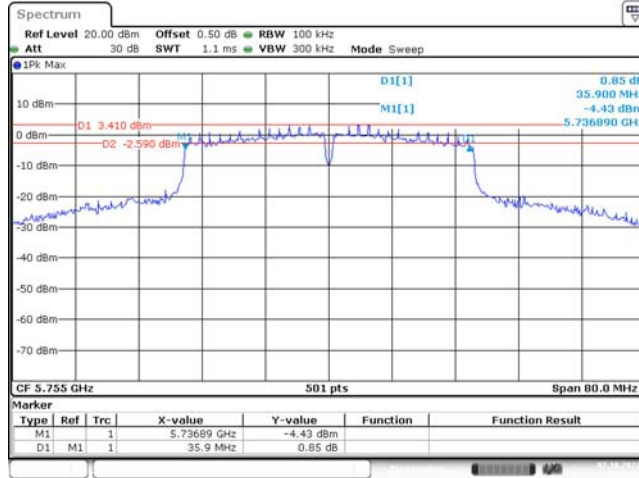

ProjectNo.:CR230745207 Tester:Jou Zhou
Date: 7.OCT.2023 10:48:32

802.11n ht40
Highest Channel

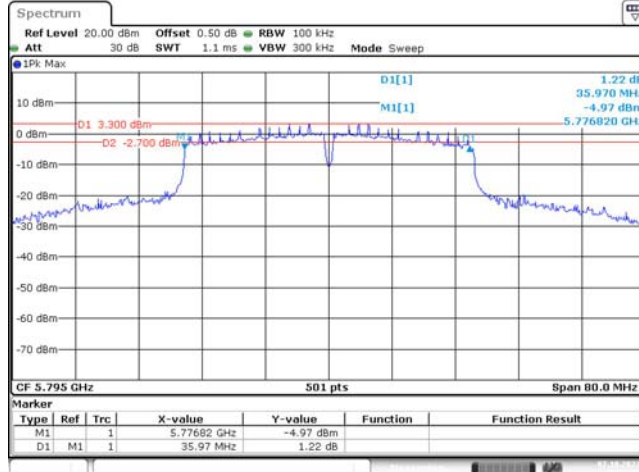

ProjectNo.:CR230745207 Tester:Jou Zhou
Date: 7.OCT.2023 10:50:20

802.11ac80
Middle Channel

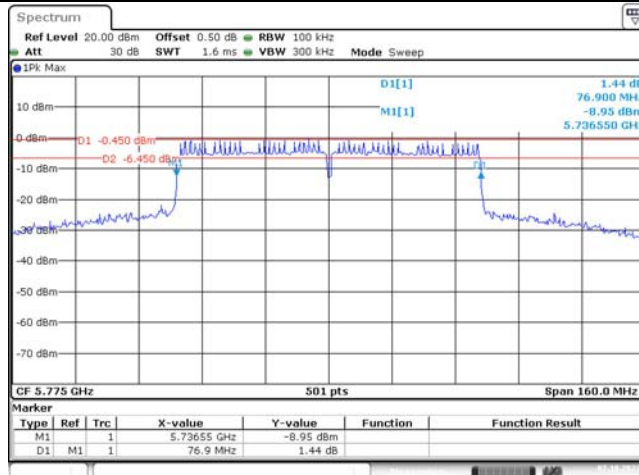

ProjectNo.:CR230745207 Tester:Jou Zhou
Date: 7.OCT.2023 10:52:36

99% Emission Bandwidth

802.11a
Lowest Channel

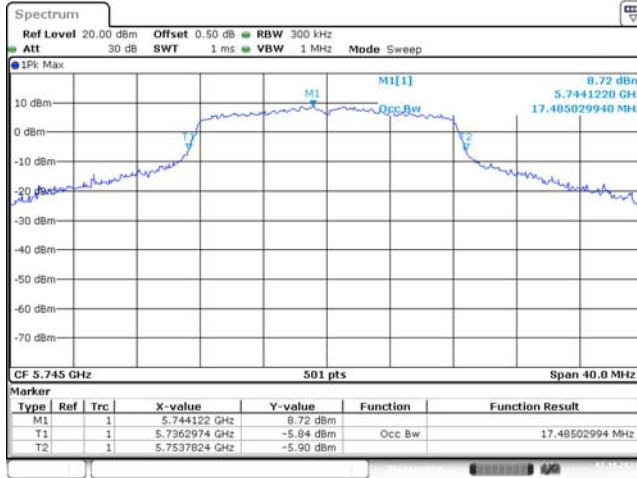

ProjectNo.:CR230745207 Tester:Jou Zhou
Date: 7.OCT.2023 11:27:47

802.11a
Middle Channel

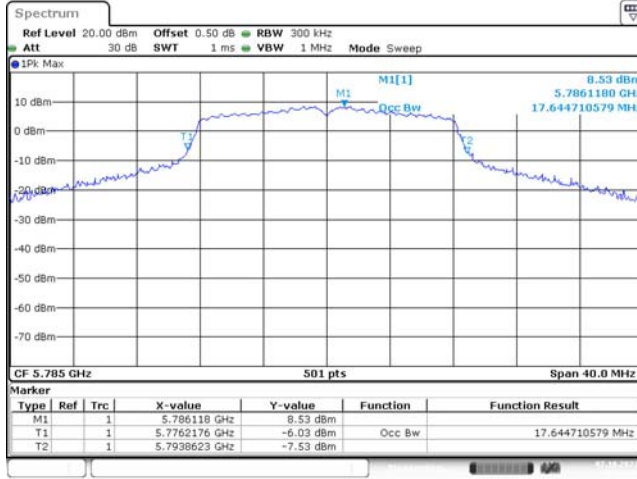

ProjectNo.:CR230745207 Tester:Jou Zhou
Date: 7.OCT.2023 11:28:37

802.11a
Highest Channel



ProjectNo.:CR230745207 Tester:Jou Zhou
Date: 7.OCT.2023 11:29:23

99% Emission Bandwidth

802.11n ht20
Lowest Channel

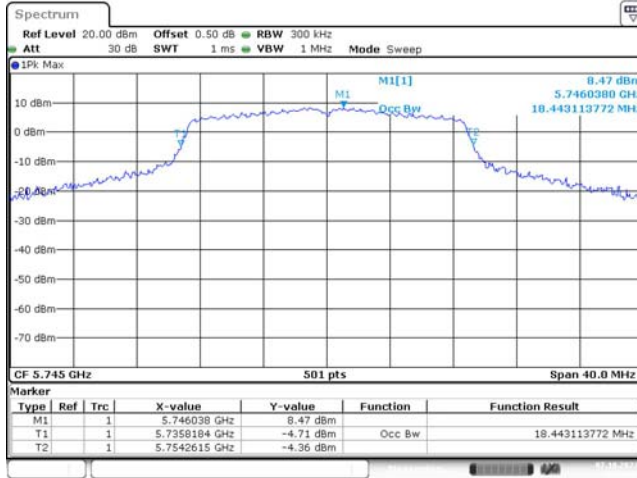

ProjectNo.:CR230745207 Tester:Jou Zhou
Date: 7.OCT.2023 11:30:19

802.11n ht20
Middle Channel

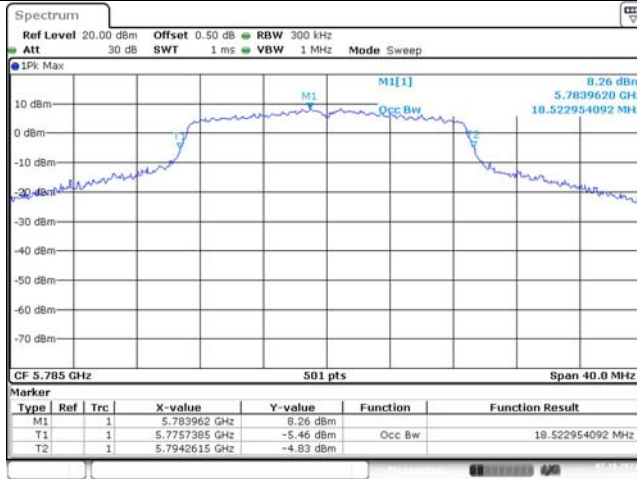

ProjectNo.:CR230745207 Tester:Jou Zhou
Date: 7.OCT.2023 11:31:12

802.11n ht20
Highest Channel

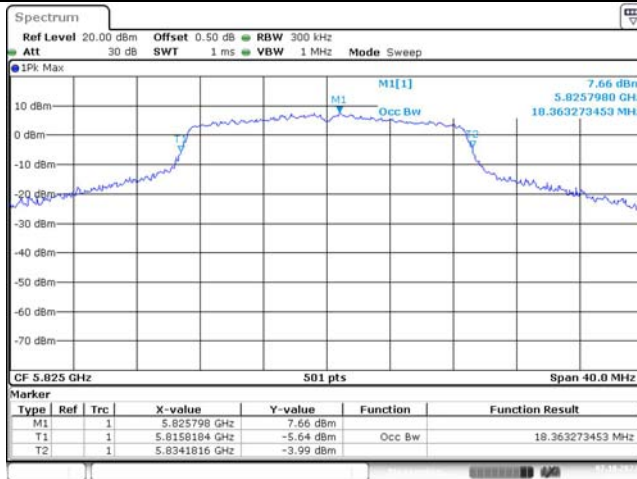

ProjectNo.:CR230745207 Tester:Jou Zhou
Date: 7.OCT.2023 11:32:04

99% Emission Bandwidth

802.11n ht40
Lowest Channel

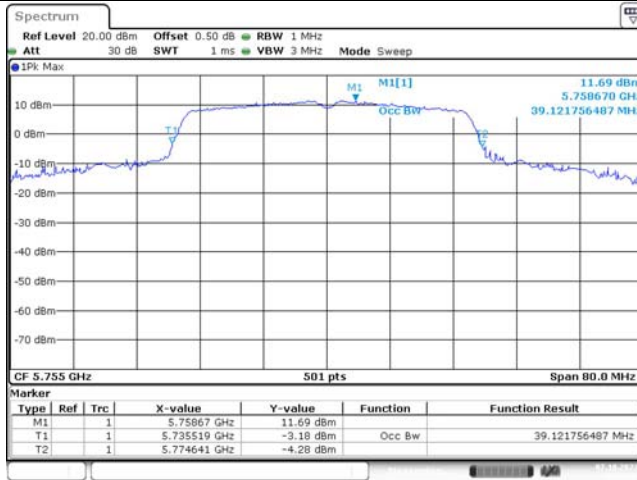

ProjectNo.:CR230745207 Tester:Jou Zhou
Date: 7.OCT.2023 11:33:14

802.11n ht40
Highest Channel



ProjectNo.:CR230745207 Tester:Jou Zhou
Date: 7.OCT.2023 11:34:08

802.11ac80
Middle Channel

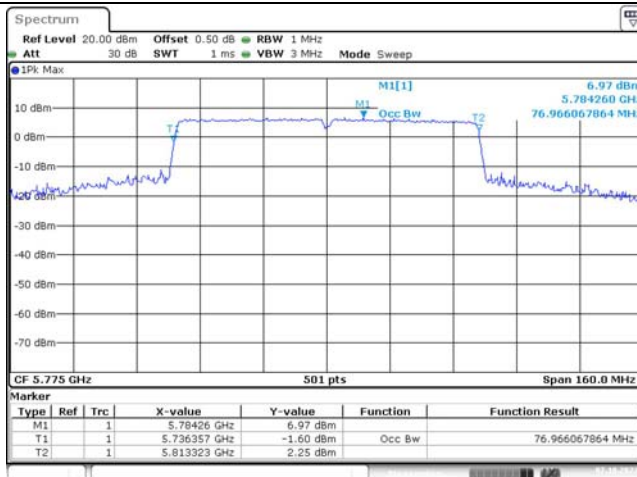

ProjectNo.:CR230745207 Tester:Jou Zhou
Date: 7.OCT.2023 11:35:13

4.5 Maximum Conducted Output Power:

Serial Number:	29L3-1	Test Date:	2023/10/7
Test Site:	RF	Test Mode:	Transmitting
Tester:	Jou Zhou	Test Result:	Pass

Environmental Conditions:

Temperature: (°C)	26.4	Relative Humidity: (%)	67	ATM Pressure: (kPa)	100.4
----------------------	------	---------------------------	----	------------------------	-------

Test Equipment List and Details:

Manufacturer	Description	Model	Serial Number	Calibration Date	Calibration Due Date
Agilent	USB Average Power Sensor	U2001H	MY50000432	2023/3/31	2024/3/30
zhuoxiang	Coaxial Cable	SMA-178	211002	Each time	N/A
HuiXunDa	DC Block	SMA-JK 18G	DCB181108042	Each time	N/A

* Statement of Traceability: China Certification ICT Co., Ltd (Dongguan) attests that all calibrations have been performed, traceable to National Primary Standards and International System of Units (SI).

Test Data:

5150-5250 MHz:

Test Modes	Test Frequency (MHz)	Max. Conducted Average Output Power(dBm)		EIRP (dBm)	
		Result	FCC Limit	Result	RSS-247 Limit
802.11a	5180	14.22	24	12.48	22.54
	5200	14.35	24	12.61	22.54
	5240	13.94	24	12.20	22.52
802.11n ht20	5180	14.07	24	12.33	22.70
	5200	14.01	24	12.27	22.75
	5240	13.61	24	11.87	22.68
802.11n ht40	5190	14.33	24	12.59	23.00
	5230	14.14	24	12.40	23.00
802.11ac vht80	5210	10.56	24	8.82	23.00
Antenna Gain:	-1.74	dB <i>i</i>	Maximum EIRP:	12.61	dB <i>m</i>

Note: The device is a client device.

5725-5850 MHz:

Test Modes	Test Frequency (MHz)	Max. Conducted Average Output Power(dBm)	
		Result	Limit
802.11a	5745	14.28	30
	5785	13.86	30
	5825	13.78	30
802.11n ht20	5745	14.13	30
	5785	13.78	30
	5825	13.58	30
802.11n ht40	5755	13.41	30
	5795	13.12	30
802.11ac vht80	5775	9.71	30
Antenna Gain:	-1.74	dB <i>i</i>	

4.6 Maximum power spectral density:

Serial Number:	29L3-1	Test Date:	2023/10/7
Test Site:	RF	Test Mode:	Transmitting
Tester:	Jou Zhou	Test Result:	Pass

Environmental Conditions:

Temperature: (°C)	26.4	Relative Humidity: (%)	67	ATM Pressure: (kPa)	100.4
----------------------	------	---------------------------	----	------------------------	-------

Test Equipment List and Details:

Manufacturer	Description	Model	Serial Number	Calibration Date	Calibration Due Date
R&S	Spectrum Analyzer	FSV40	101943	2023/3/31	2024/3/30
zhuoxiang	Coaxial Cable	SMA-178	211002	Each time	N/A
HuiXunDa	DC Block	SMA-JK 18G	DCB181108042	Each time	N/A

* Statement of Traceability: China Certification ICT Co., Ltd (Dongguan) attests that all calibrations have been performed, traceable to National Primary Standards and International System of Units (SI).

Test Data:

5150-5250

MHz:

Test Modes	Test Frequency (MHz)	Maximum Power Spectral Density(dBm/MHz)			Maximum EIRP Power Spectral Density(dBm/MHz)	
		Reading	Result	FCC Limit	Result	RSS-247 Limit
802.11a	5180	4.47	4.47	11	2.73	10
	5200	4.24	4.24	11	2.50	10
	5240	4.00	4.00	11	2.26	10
802.11n ht20	5180	4.26	4.26	11	2.52	10
	5200	4.08	4.08	11	2.34	10
	5240	3.78	3.78	11	2.04	10
802.11n ht40	5190	2.88	2.88	11	1.14	10
	5230	1.17	1.17	11	-0.57	10
802.11ac vht80	5210	-3.08	-3.08	11	-4.82	10
Antenna Gain:	-1.74	dB	Maximum EIRP:	2.73	(dBm/MHz)	

Note:

The device is a client device.

Method SA-3 in KDB 789033 D02 General UNII Test Procedures New Rules v02r01 was used for PSD test.

5725-5850 MHz:

Test Modes	Test Frequency (MHz)	Maximum Power Spectral Density(dBm/500kHz)		
		Result	Result	Limit
802.11a	5745	2.83	2.83	30
	5785	2.57	2.57	30
	5825	1.56	1.56	30
802.11n ht20	5745	2.58	2.58	30
	5785	2.34	2.34	30
	5825	1.37	1.37	30
802.11n ht40	5755	0.07	0.07	30
	5795	-0.36	-0.36	30
802.11ac vht80	5775	-4.67	-4.67	30
Antenna Gain:	-1.74	dB		

Note: Method SA-3 in KDB 789033 D02 General UNII Test Procedures New Rules v02r01 was used for PSD test.

5150-5250MHz:

Maximum power spectral density

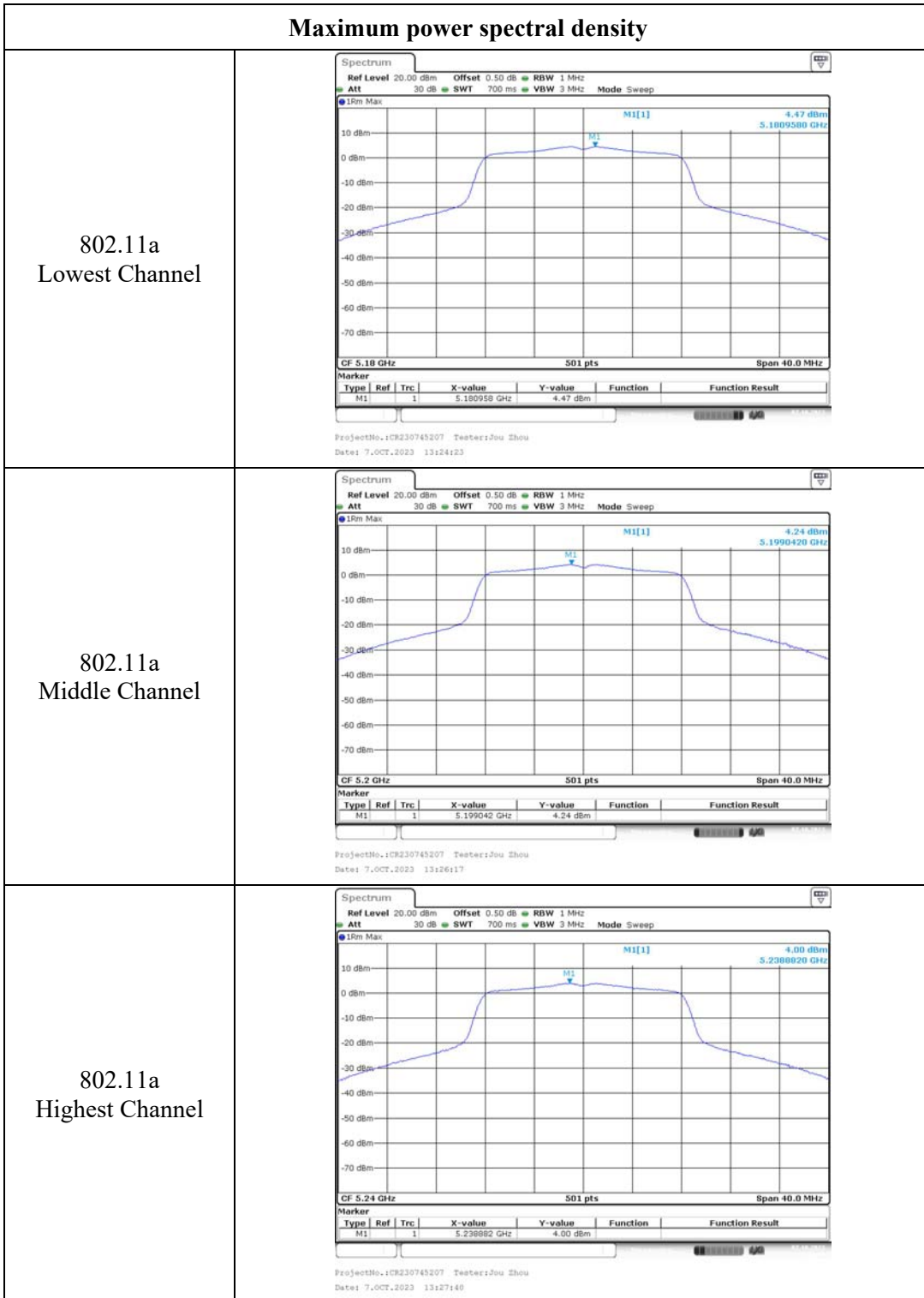

Maximum power spectral density

802.11n ht20
Lowest Channel

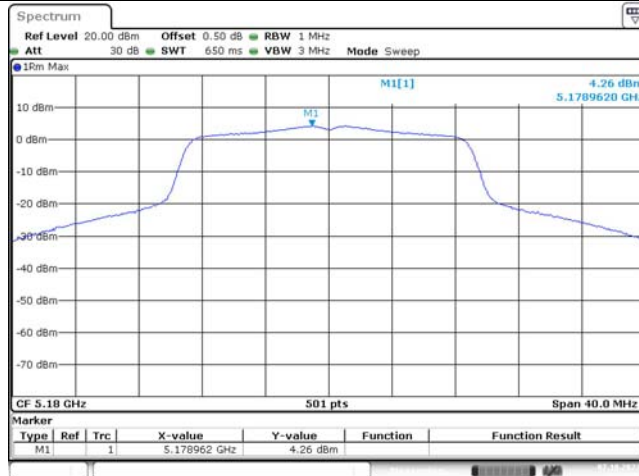

ProjectNo.:CR230745207 Testeri:Jou Zhou
Date: 7.OCT.2023 13:29:55

802.11n ht20
Middle Channel

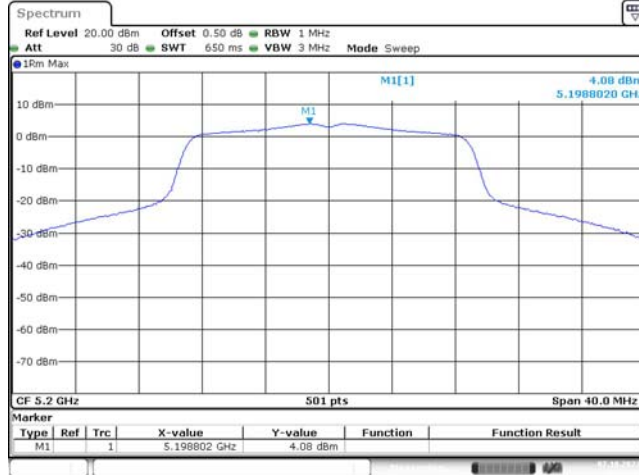

ProjectNo.:CR230745207 Testeri:Jou Zhou
Date: 7.OCT.2023 13:31:25

802.11n ht20
Highest Channel

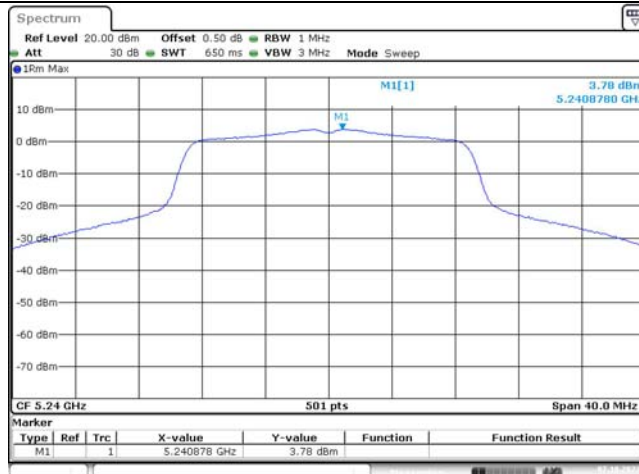

ProjectNo.:CR230745207 Testeri:Jou Zhou
Date: 7.OCT.2023 13:32:48

Maximum power spectral density

802.11n ht40
Lowest Channel

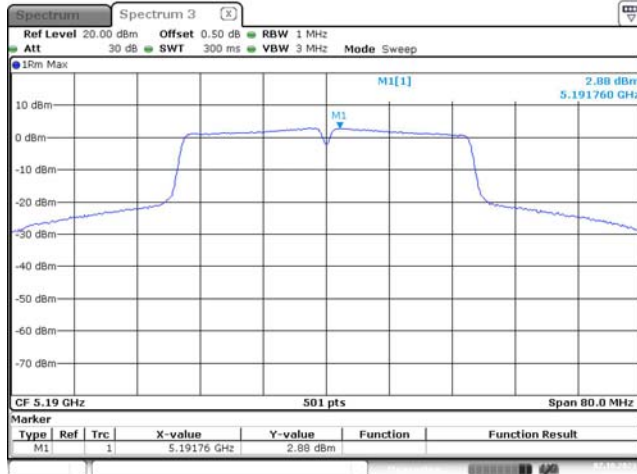

ProjectNo.:CR230745207 Testeri:Jou Zhou
Date: 7.OCT.2023 13:55:05

802.11n ht40
Highest Channel

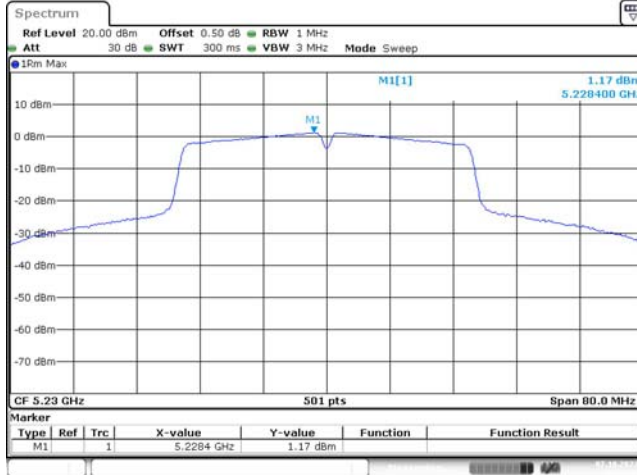

ProjectNo.:CR230745207 Testeri:Jou Zhou
Date: 7.OCT.2023 13:37:16

802.11ac80
Middle Channel

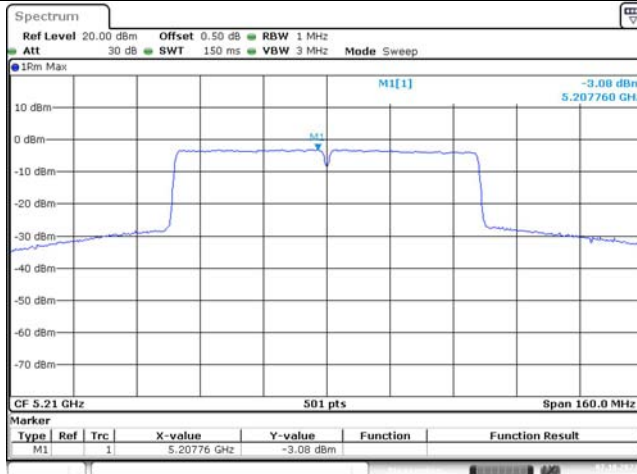

ProjectNo.:CR230745207 Testeri:Jou Zhou
Date: 7.OCT.2023 13:41:08

5725-5850MHz

Maximum power spectral density

802.11a
Lowest Channel

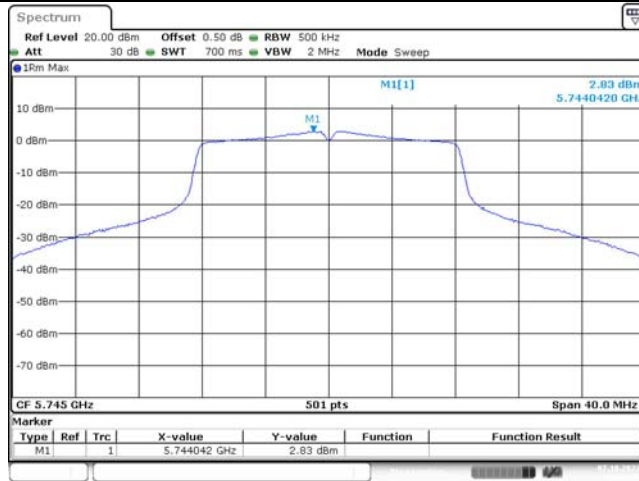

ProjectNo.:CR230745207 Tester:Jou Zhou
Date: 7.OCT.2023 13:43:40

802.11a
Middle Channel

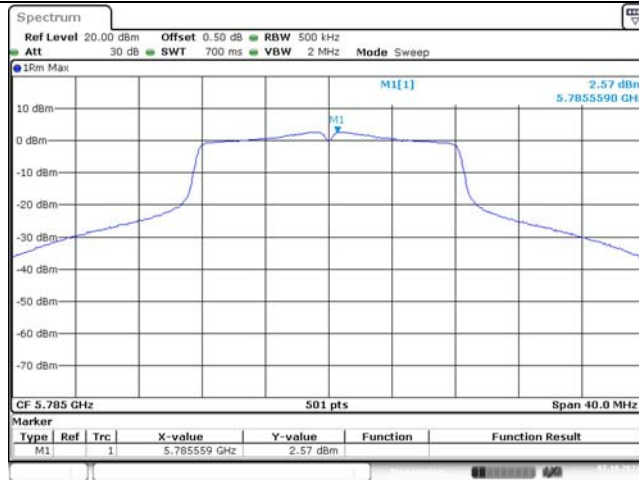

ProjectNo.:CR230745207 Tester:Jou Zhou
Date: 7.OCT.2023 13:44:58

802.11a
Highest Channel

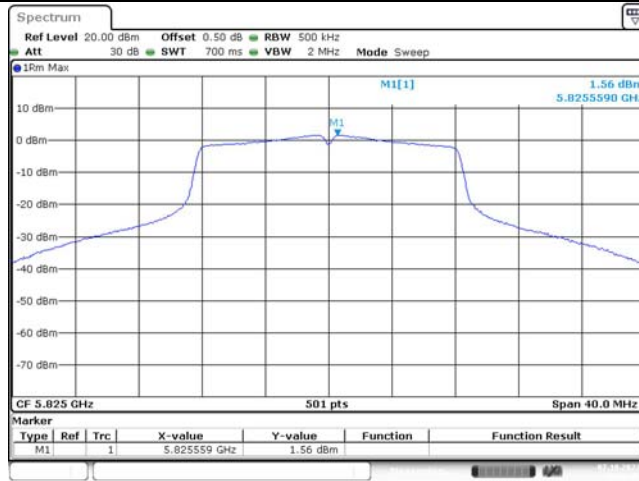

ProjectNo.:CR230745207 Tester:Jou Zhou
Date: 7.OCT.2023 13:46:05

Maximum power spectral density

802.11n ht20
Lowest Channel

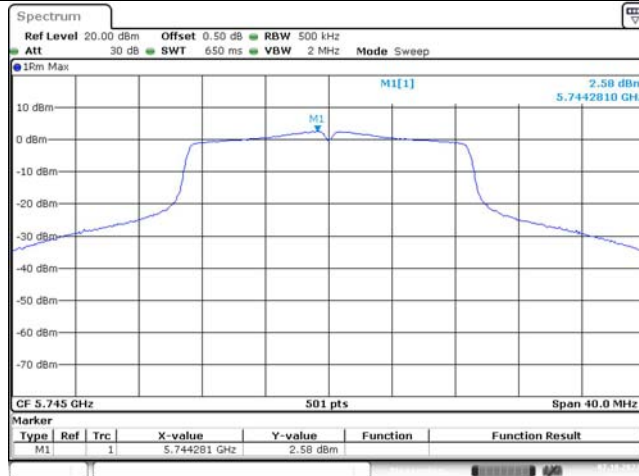

ProjectNo.:CR230745207 Testeri:Jou Zhou
Date: 7.OCT.2023 13:47:59

802.11n ht20
Middle Channel

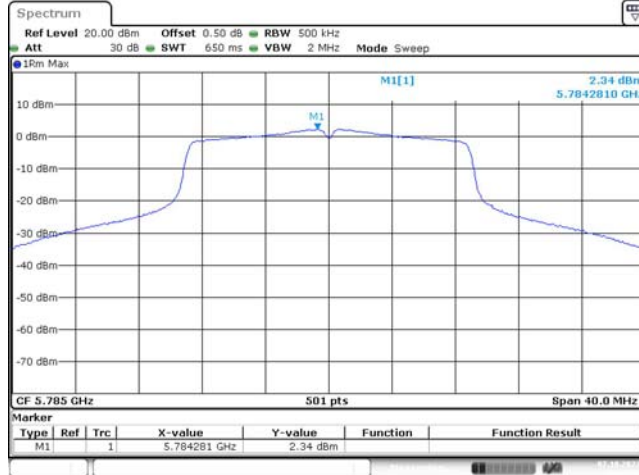

ProjectNo.:CR230745207 Testeri:Jou Zhou
Date: 7.OCT.2023 13:49:06

802.11n ht20
Highest Channel

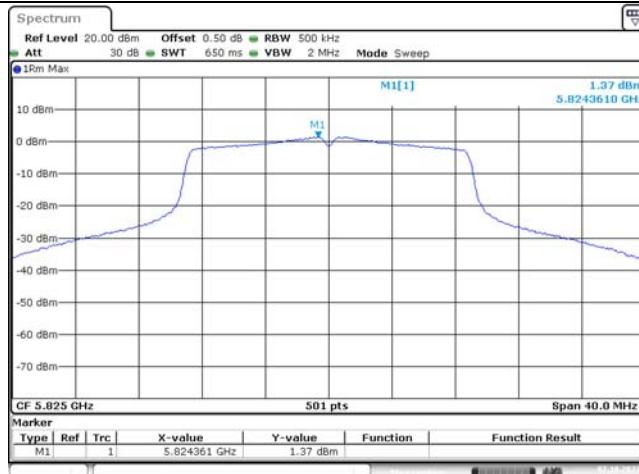

ProjectNo.:CR230745207 Testeri:Jou Zhou
Date: 7.OCT.2023 13:50:14

Maximum power spectral density

802.11n ht40
Lowest Channel

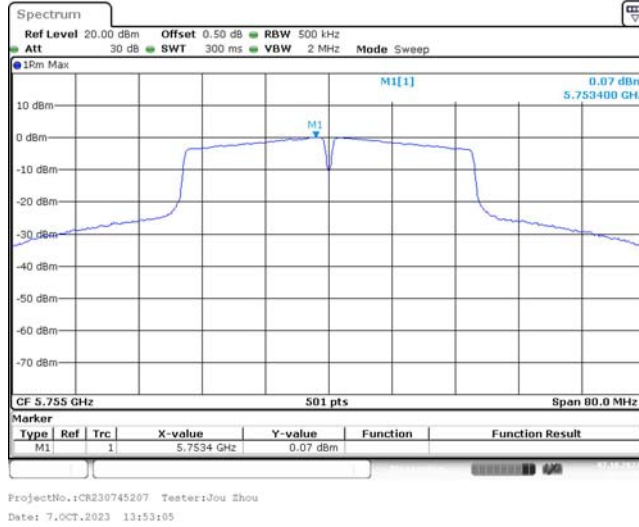

802.11n ht40
Highest Channel

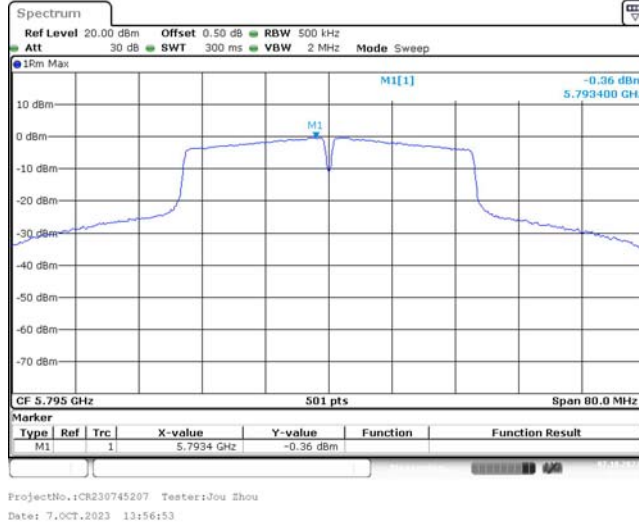

802.11ac80
Middle Channel

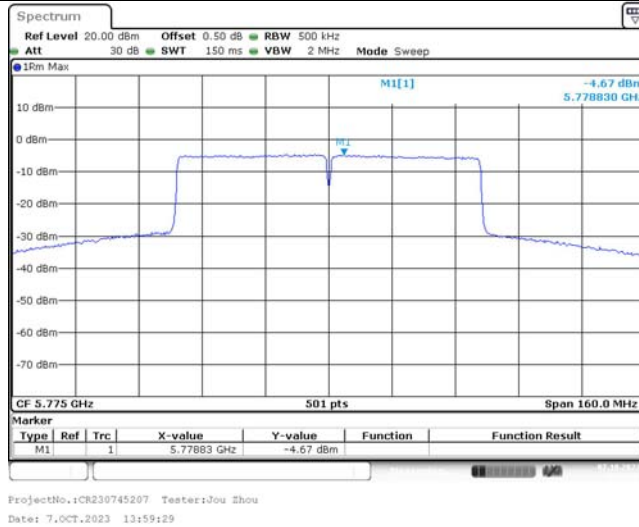

4.7 Duty Cycle:

Serial Number:	29L3-1	Test Date:	2023/10/7
Test Site:	RF	Test Mode:	Transmitting
Tester:	Jou Zhou	Test Result:	N/A

Environmental Conditions:

Temperature: (°C)	26.4	Relative Humidity: (%)	67	ATM Pressure: (kPa)	100.4
----------------------	------	---------------------------	----	------------------------	-------

Test Equipment List and Details:

Manufacturer	Description	Model	Serial Number	Calibration Date	Calibration Due Date
R&S	Spectrum Analyzer	FSV40	101943	2023/3/31	2024/3/30
zhuoxiang	Coaxial Cable	SMA-178	211002	Each time	N/A
HuiXunDa	DC Block	SMA-JK 18G	DCB181108042	Each time	N/A

* Statement of Traceability: China Certification ICT Co., Ltd (Dongguan) attests that all calibrations have been performed, traceable to National Primary Standards and International System of Units (SI).

Test Data:

Test Modes	Ton (ms)	Ton+off (ms)	Duty cycle (%)	1/T (Hz)	Duty Factor (dB)	VBW Setting (kHz)
802.11a	1.479	/	Not constant	676	/	1
802.11n ht20	1.363	/	Not constant	734	/	1
802.11n ht40	0.697	/	Not constant	1435	/	2
802.11ac vht80	0.350	/	Not constant	2857	/	3

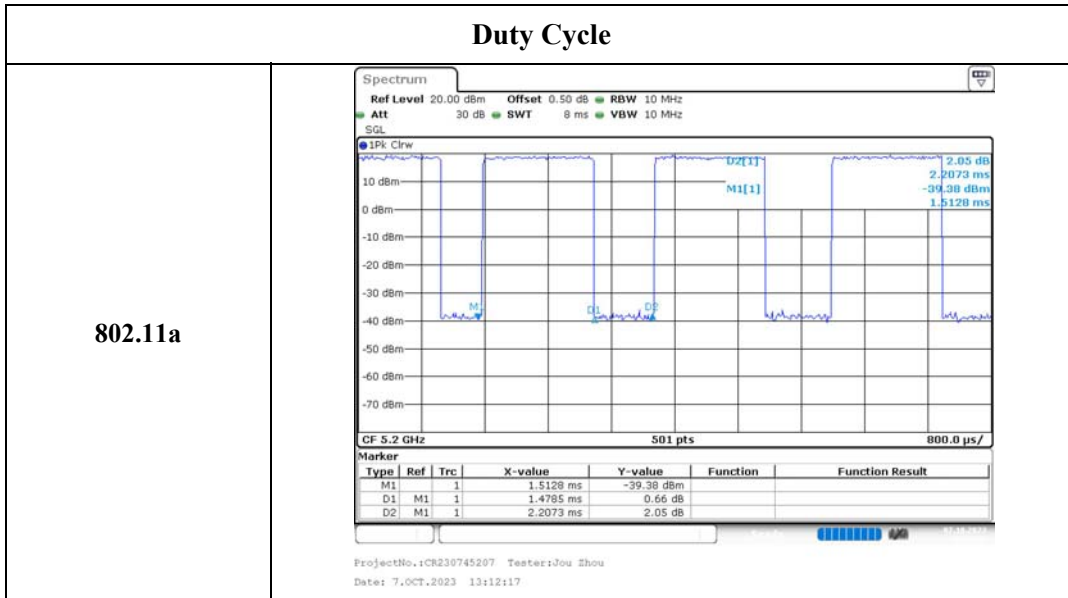

Duty Cycle

802.11n ht20

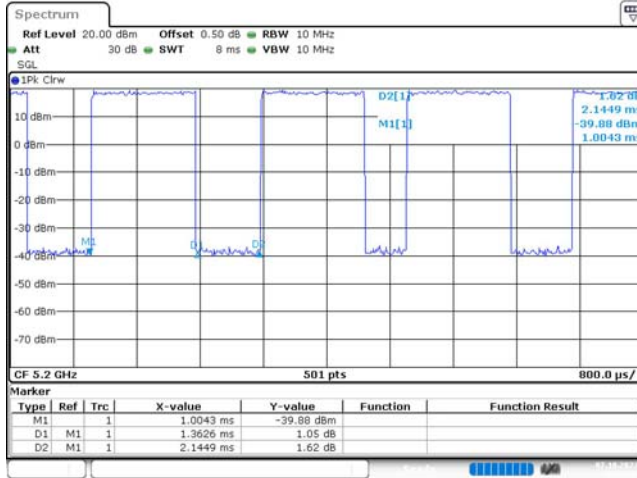

802.11n ht40

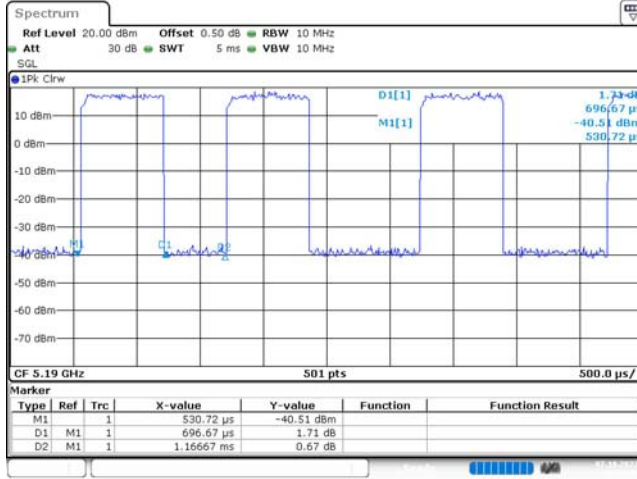

802.11ac80

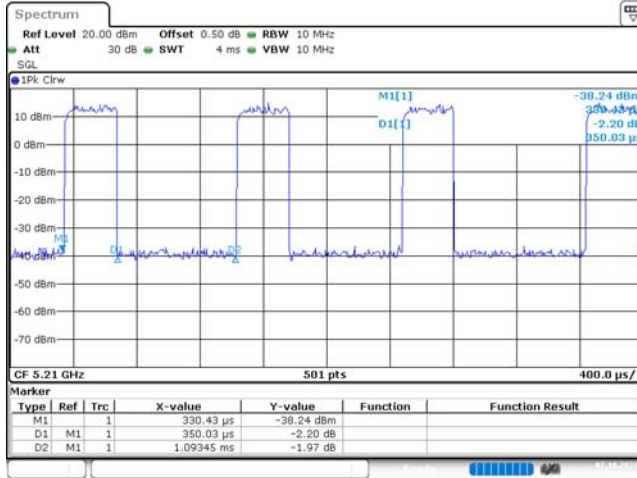

4.8 Frequency Stability:

Serial Number:	29L3-1	Test Date:	2023/10/29
Test Site:	RF	Test Mode:	Transmitting
Tester:	Jou Zhou	Test Result:	Pass

Environmental Conditions:

Temperature: (°C)	24.3	Relative Humidity: (%)	50	ATM Pressure: (kPa)	101
----------------------	------	------------------------------	----	---------------------------	-----

Test Equipment List and Details:

Manufacturer	Description	Model	Serial Number	Calibration Date	Calibration Due Date
R&S	Spectrum Analyzer	FSV40	101943	2023/3/31	2024/3/30
zhuoxiang	Coaxial Cable	SMA-178	211002	Each time	N/A
Mini-Circuits	DC Block	BLK-18-S+	1554404	Each time	N/A
BACL	TEMP&HUMI Test Chamber	BTH-150-40	30174	2023/3/31	2024/3/30
UNI-T	Multimeter	UT39A+	C210582554	2023/9/28	2024/9/27

* Statement of Traceability: China Certification ICT Co., Ltd (Dongguan) attests that all calibrations have been performed, traceable to National Primary Standards and International System of Units (SI).

Test Data:

5150-5250 MHz Band:

Test Mode:	802.11a					
Test Item	Temperature (°C)	Voltage (V _{DC})	F _L at Low Channel (MHz)		F _H at High Channel (MHz)	
			Result	Limit	Result	Limit
Frequency Stability vs. Temperature	-30	3.85	5171.693	5150	5248.868	5250
	-20	3.85	5171.669	5150	5248.852	5250
	-10	3.85	5171.636	5150	5248.838	5250
	0	3.85	5171.629	5150	5248.866	5250
	10	3.85	5171.625	5150	5248.853	5250
	20	3.85	5171.641	5150	5248.831	5250
	30	3.85	5171.666	5150	5248.862	5250
	40	3.85	5171.631	5150	5248.824	5250
Frequency Stability vs. Voltage	50	3.85	5171.608	5150	5248.812	5250
	20	3.2	5171.652	5150	5248.891	5250
	20	4.45	5171.643	5150	5248.832	5250

5725-5850 MHz Band:

Test Mode:	802.11a					
Test Item	Temperature (°C)	Voltage (V _{DC})	F _L at Low Channel (MHz)		F _H at High Channel (MHz)	
			Result	Limit	Result	Limit
Frequency Stability vs. Temperature	-30	3.85	5736.553	5725	5833.569	5850
	-20	3.85	5736.548	5725	5833.551	5850
	-10	3.85	5736.542	5725	5833.546	5850
	0	3.85	5736.532	5725	5833.539	5850
	10	3.85	5736.521	5725	5833.531	5850
	20	3.85	5736.519	5725	5833.522	5850
	30	3.85	5736.508	5725	5833.518	5850
	40	3.85	5735.995	5725	5833.516	5850
Frequency Stability vs. Voltage	50	3.85	5735.984	5725	5833.509	5850
	20	3.2	5736.668	5725	5833.596	5850
	20	4.45	5736.029	5725	5833.538	5850

5. EUT PHOTOGRAPHS

Please refer to the attachment CR230745207-EXP EUT EXTERNAL PHOTOGRAPHS and
CR230745207-INP EUT INTERNAL PHOTOGRAPHS

6. TEST SETUP PHOTOGRAPHS

Please refer to the attachment CR230745207-00D-TSP TEST SETUP PHOTOGRAPHS.

===== END OF REPORT =====