

FCC Radio Test Report

FCC ID: 2ATYCHMX04

Report No. : BTL-FCCP-4-2101T111
Equipment : HIPCAM
Model Name : Outdoor Spotlight Camera Max
Brand Name : HIPCAM
Applicant : Hipcam Global LLC
Address : 112 Capitol Trail, Newark, Delaware, 19711 United States
Manufacturer : Goldtek Technology Co., Ltd.
Address : 16F., No.166, Jian 1st Rd., Zhonghe Dist., New Taipei City 235, Taiwan (R.O.C.)

Radio Function : RLAN 5 GHz (U-NII 1, U-NII 2A, U-NII 2C, U-NII 3)

FCC Rule Part(s) : FCC Part15, Subpart E (15.407)
Measurement Procedure(s) : ANSI C63.10-2013

Date of Receipt : 2021/2/2
Date of Test : 2021/2/2 ~ 2021/3/17
Issued Date : 2021/4/16

The above equipment has been tested and found in compliance with the requirement of the above standards by BTL Inc.

Prepared by :

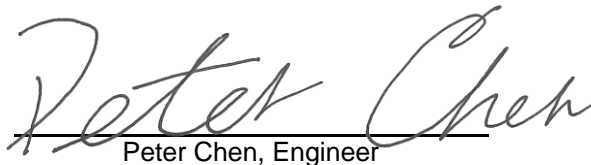
Peter Chen, Engineer

**Approved by** :

Scott Hsu, Manager

BTL Inc.

No.18, Ln. 171, Sec. 2, Jiuzong Rd., Neihu Dist., Taipei City 114, Taiwan

Tel: +886-2-2657-3299

Fax: +886-2-2657-3331

Web: www.newbtl.com

Declaration

BTL represents to the client that testing is done in accordance with standard procedures as applicable and that test instruments used has been calibrated with standards traceable to international standard(s) and/or national standard(s).

BTL's reports apply only to the specific samples tested under conditions. It is manufacture's responsibility to ensure that additional production units of this model are manufactured with the identical electrical and mechanical components. **BTL** shall have no liability for any declarations, inferences or generalizations drawn by the client or others from **BTL** issued reports.

This report is the confidential property of the client. As a mutual protection to the clients, the public and ourselves, the test report shall not be reproduced, except in full, without our written approval.

BTL's laboratory quality assurance procedures are in compliance with the **ISO/IEC 17025** requirements, and accredited by the conformity assessment authorities listed in this test report.

BTL is not responsible for the sampling stage, so the results only apply to the sample as received.

The information, data and test plan are provided by manufacturer which may affect the validity of results, so it is manufacturer's responsibility to ensure that the apparatus meets the essential requirements of applied standards and in all the possible configurations as representative of its intended use.

Limitation

For the use of the authority's logo is limited unless the Test Standard(s)/Scope(s)/Item(s) mentioned in this test report is (are) included in the conformity assessment authorities acceptance respective.

Please note that the measurement uncertainty is provided for informational purpose only and are not use in determining the Pass/Fail results.

CONTENTS

REVISION HISTORY	5
1 SUMMARY OF TEST RESULTS	6
1.1 TEST FACILITY	7
1.2 MEASUREMENT UNCERTAINTY	7
1.3 TEST ENVIRONMENT CONDITIONS	7
1.4 TABLE OF PARAMETERS OF TEST SOFTWARE SETTING	8
1.5 DUTY CYCLE	9
2 GENERAL INFORMATION	10
2.1 DESCRIPTION OF EUT	10
2.2 TEST MODES	12
2.3 BLOCK DIAGRAM SHOWING THE CONFIGURATION OF SYSTEM TESTED	13
2.4 SUPPORT UNITS	14
3 AC POWER LINE CONDUCTED EMISSIONS TEST	15
3.1 LIMIT	15
3.2 TEST PROCEDURE	15
3.3 DEVIATION FROM TEST STANDARD	15
3.4 TEST SETUP	16
3.5 TEST RESULT	16
4 RADIATED EMISSIONS TEST	17
4.1 LIMIT	17
4.2 TEST PROCEDURE	18
4.3 DEVIATION FROM TEST STANDARD	18
4.4 TEST SETUP	19
4.5 EUT OPERATING CONDITIONS	20
4.6 TEST RESULT – 30 MHZ TO 1 GHZ	20
4.7 TEST RESULT – ABOVE 1 GHZ	20
5 BANDWIDTH TEST	21
5.1 LIMIT	21
5.2 TEST PROCEDURE	21
5.3 DEVIATION FROM TEST STANDARD	21
5.4 TEST SETUP	21
5.5 EUT OPERATING CONDITIONS	21
5.6 TEST RESULT	21
6 OUTPUT POWER TEST	22
6.1 LIMIT	22
6.2 TEST PROCEDURE	22
6.3 DEVIATION FROM TEST STANDARD	22
6.4 TEST SETUP	22
6.5 EUT OPERATING CONDITIONS	22
6.6 TEST RESULT	22
7 POWER SPECTRAL DENSITY	23
7.1 LIMIT	23
7.2 TEST PROCEDURE	23
7.3 DEVIATION FROM TEST STANDARD	23
7.4 TEST SETUP	23
7.5 EUT OPERATING CONDITIONS	23
7.6 TEST RESULT	23

8	LIST OF MEASURING EQUIPMENTS	24
9	EUT TEST PHOTO	26
10	EUT PHOTOS	26
APPENDIX A	AC POWER LINE CONDUCTED EMISSIONS	27
APPENDIX B	RADIATED EMISSIONS - 30 MHZ TO 1 GHZ	32
APPENDIX C	RADIATED EMISSIONS - ABOVE 1 GHZ	35
APPENDIX D	BANDWIDTH	126
APPENDIX E	CONDUCTED OUTPUT POWER	148
APPENDIX F	POWER SPECTRAL DENSITY	151

REVISION HISTORY

Report No.	Version	Description	Issued Date
BTL-FCCP-4-2101T111	R00	Original Report.	2021/4/9
BTL-FCCP-4-2101T111	R01	Revised report to address TCB's comments.	2021/4/16

1 SUMMARY OF TEST RESULTS

Test procedures according to the technical standards.

FCC Part 15, Subpart E (15.407)				
Standard(s) Section	Description	Test Result	Judgement	Remark
15.207	AC Power Line Conducted Emissions	APPENDIX A	Pass	-----
15.205 15.209 15.407(b)	Radiated Emissions	APPENDIX B APPENDIX C	Pass	-----
15.407(a)	Bandwidth	APPENDIX D	Pass	-----
15.407(a)	Output Power	APPENDIX E	Pass	-----
15.407(a)	Power Spectral Density	APPENDIX F	Pass	-----
15.203	Antenna Requirement	-----	Pass	-----
15.407(c)	Automatically Discontinue Transmission	-----	Pass	NOTE (3)

NOTE:

- (1) "N/A" denotes test is not applicable in this Test Report.
- (2) The report format version is TP.1.1.1.
- (3) The EUT can detect the controlling signal of ACK message transmitting from remote device and verify whether it shall resend or discontinue transmission.

1.1 TEST FACILITY

The test facilities used to collect the test data in this report:

No. 68-1, Ln. 169, Sec. 2, Datong Rd., Xizhi Dist., New Taipei City 221, Taiwan

The test sites and facilities are covered under FCC RN: 674415 and DN: TW0659.

- C05 CB08 CB11 CB15 CB16
 SR05

1.2 MEASUREMENT UNCERTAINTY

The reported uncertainty of measurement $y \pm U$, where expanded uncertainty U is based on a standard uncertainty multiplied by a coverage factor of $k = 2$, providing a level of confidence of approximately **95 %**. The measurement instrumentation uncertainty considerations contained in CISPR 16-4-2. The BTL measurement uncertainty is less than the CISPR 16-4-2 U_{cispr} requirement.

A. AC power line conducted emissions test:

Test Site	Method	Measurement Frequency Range	U (dB)
C05	CISPR	150 kHz ~ 30MHz	3.44

B. Radiated emissions test :

Test Site	Measurement Frequency Range	U,(dB)
CB15	0.03 GHz ~ 0.2 GHz	4.17
	0.2 GHz ~ 1 GHz	4.72
	1 GHz ~ 6 GHz	5.21
	6 GHz ~ 18 GHz	5.51
	18 GHz ~ 26 GHz	3.69
	26 GHz ~ 40 GHz	4.23

C. Conducted test :

Test Item	U,(dB)
Bandwidth	1.13
Output power	1.07
Power Spectral Density	1.20
Conducted Band edges	1.13
Frequency Stability	1.13

NOTE:

Unless specifically mentioned, the uncertainty of measurement has not been taken into account to declare the compliance or non-compliance to the specification.

1.3 TEST ENVIRONMENT CONDITIONS

Test Item	Environment Condition	Test Voltage	Tested by
AC Power Line Conducted Emissions	21 °C, 70 %	AC 120V	Vincent Lee
Radiated emissions below 1 GHz	21 °C, 68 %	AC 120V	Jay Kao
Radiated emissions above 1 GHz	22 °C, 66 %	AC 120V	Jay Kao
Bandwidth	22 °C, 52 %	AC 120V	Nero Hsieh
Output Power	22 °C, 52 %	AC 120V	Nero Hsieh
Power Spectral Density	22 °C, 52 %	AC 120V	Nero Hsieh

1.4 TABLE OF PARAMETERS OF TEST SOFTWARE SETTING

UNII-1				
Test Software	Ampak RFTestTool v7.0			
Mode	5180 MHz	5200 MHz	5240 MHz	Data Rate
IEEE 802.11a	DEF	DEF	DEF	6 Mbps
IEEE 802.11n (HT20)	DEF	DEF	DEF	MCS 0
Mode	5190 MHz	5230 MHz		Data Rate
IEEE 802.11n (HT40)	DEF	DEF		MCS 0

UNII-2A				
Test Software	Ampak RFTestTool v7.0			
Mode	5260 MHz	5300 MHz	5320 MHz	Data Rate
IEEE 802.11a	DEF	DEF	DEF	6 Mbps
IEEE 802.11n (HT20)	DEF	DEF	DEF	MCS 0
Mode	5270 MHz	5310 MHz		Data Rate
IEEE 802.11n (HT40)	DEF	DEF		MCS 0

UNII-2C				
Test Software	Ampak RFTestTool v7.0			
Mode	5500 MHz	5580 MHz	5700 MHz	Data Rate
IEEE 802.11a	DEF	DEF	DEF	6 Mbps
IEEE 802.11n (HT20)	DEF	DEF	DEF	MCS 0
Mode	5510 MHz	5550 MHz	5670 MHz	Data Rate
IEEE 802.11n (HT40)	DEF	DEF	DEF	MCS 0

UNII-3				
Test Software	Ampak RFTestTool v7.0			
Mode	5745 MHz	5785 MHz	5825 MHz	Data Rate
IEEE 802.11a	DEF	DEF	DEF	6 Mbps
IEEE 802.11n (HT20)	DEF	DEF	DEF	MCS 0
Mode	5755 MHz	5795 MHz		Data Rate
IEEE 802.11n (HT40)	DEF	DEF		MCS 0

1.5 DUTY CYCLE

If duty cycle is $\geq 98\%$, duty factor is not required.

If duty cycle is $< 98\%$, duty factor shall be considered.

Remark	Delta 1			Delta 2	On Time/Period	10 log(1/Duty Cycle)
Mode	ON (ms)	Numbers (ON)	On Time (B) (ms)	Period (ON+OFF) (ms)	Duty Cycle (%)	Duty Factor (dB)
IEEE 802.11a	1.380	1	1.380	1.450	95.17%	0.21
IEEE 802.11n (HT20)	1.290	1	1.290	1.360	94.85%	0.23
IEEE 802.11n (HT40)	0.620	1	0.620	0.695	89.21%	0.50

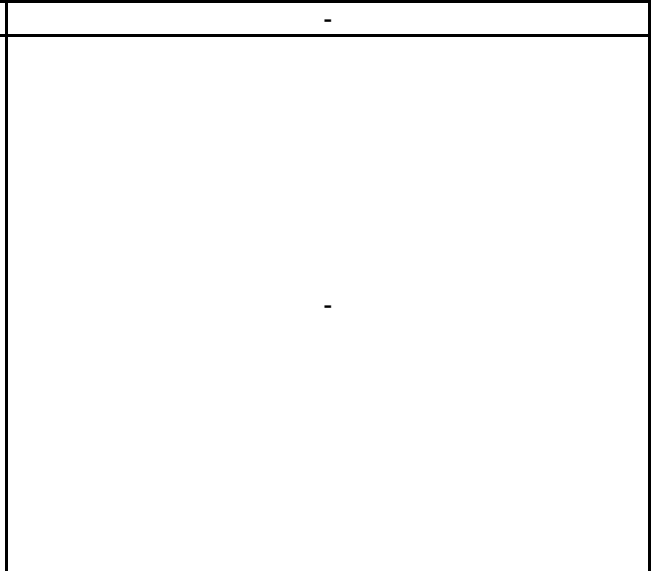
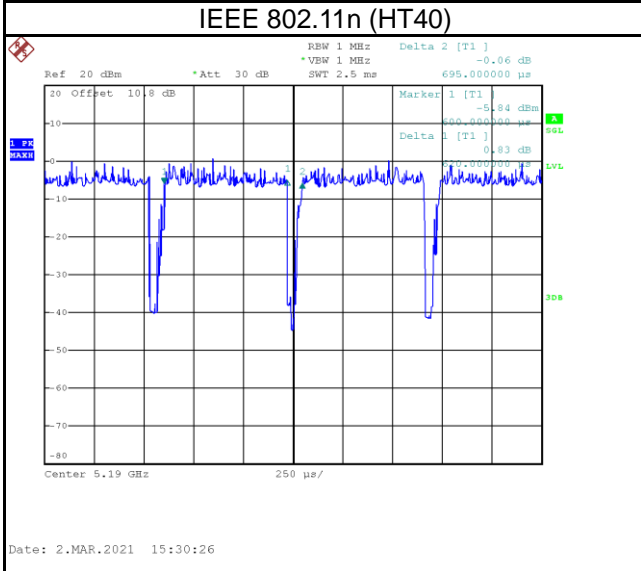
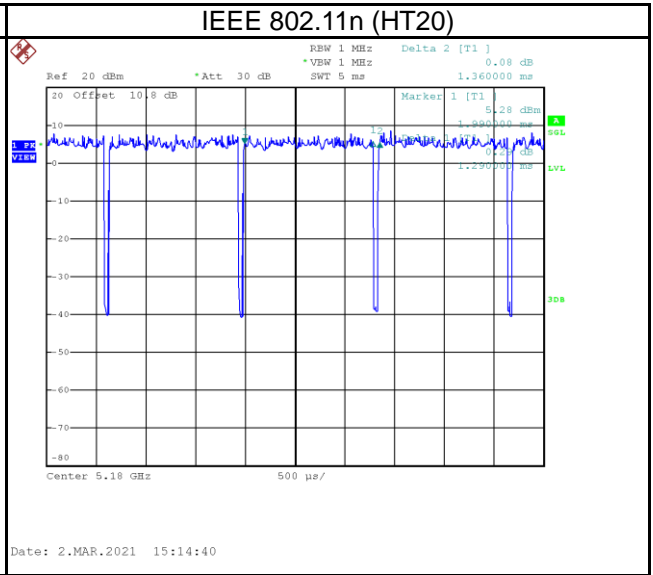
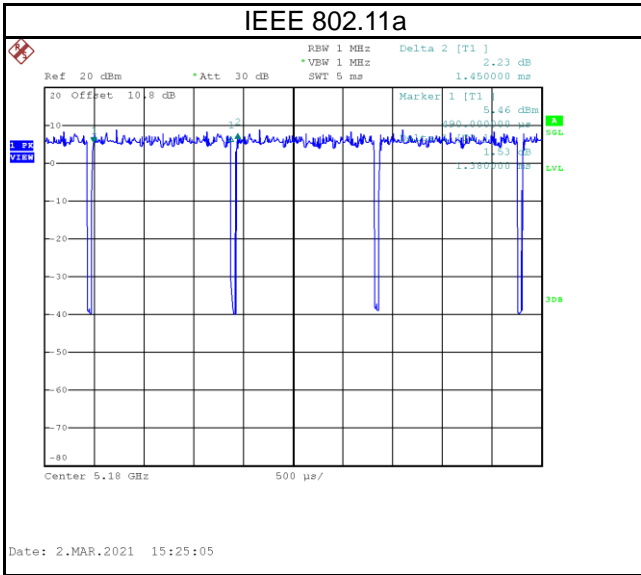

2 GENERAL INFORMATION

2.1 DESCRIPTION OF EUT

Equipment	HIPCAM
Model Name	Outdoor Spotlight Camera Max
Brand Name	HIPCAM
Model Difference	N/A
Power Source	DC Voltage supplied from AC/DC adapter.
Power Rating	I/P: 100-240V~ 50/60Hz 0.6A Max O/P: 12.0Vdc 2.0A 24.0W
Products Covered	1 * Adapter: SIMSUKIAN / SK03T-1200200Z 1 * Base
Operation Band	UNII-1: 5150 MHz to 5250 MHz UNII-2A: 5250 MHz to 5350 MHz UNII-2C: 5470 MHz to 5725 MHz UNII-3: 5725 MHz to 5850 MHz
Operation Frequency	UNII-1: 5180 MHz ~ 5240 MHz UNII-2A: 5260 MHz ~ 5320 MHz UNII-2C: 5500 MHz ~ 5700 MHz UNII-3: 5745 MHz ~ 5825 MHz
Modulation Technology	OFDM
Transfer Rate	802.11a: 54/48/36/24/18/12/9/6 Mbps 802.11n: Up to 150Mbps
Output Power Max. for UNII-1	IEEE 802.11a: 13.30 dBm (0.0214 W) IEEE 802.11n (HT20): 13.07 dBm (0.0203 W) IEEE 802.11n (HT40): 9.90 dBm (0.0098 W)
Output Power Max. for UNII-2A	IEEE 802.11a: 13.49 dBm (0.0223 W) IEEE 802.11n (HT20): 12.85 dBm (0.0193 W) IEEE 802.11n (HT40): 10.40 dBm (0.0110 W)
Output Power Max. for UNII-2C	IEEE 802.11a: 10.53 dBm (0.0113 W) IEEE 802.11n (HT20): 10.37 dBm (0.0109 W) IEEE 802.11n (HT40): 10.10 dBm (0.0102 W)
Output Power Max. for UNII-3	IEEE 802.11a: 10.24 dBm (0.0106W) IEEE 802.11n (HT20): 10.17 dBm (0.0104 W) IEEE 802.11n (HT40): 10.07 dBm (0.0102 W)
Test Model	Outdoor Spotlight Camera Max
Sample Status	Engineering Sample
EUT Modification(s)	N/A

NOTE:

(1) For a more detailed features description, please refer to the manufacturer's specifications or the user's manual.

(2) Channel List:

IEEE 802.11a IEEE 802.11n (HT20)		IEEE 802.11n (HT40)	
UNII-1		UNII-1	
Channel	Frequency (MHz)	Channel	Frequency (MHz)
36	5180	38	5190
40	5200	46	5230
44	5220		
48	5240		

IEEE 802.11a IEEE 802.11n (HT20)		IEEE 802.11n (HT40)	
UNII-2A		UNII-2A	
Channel	Frequency (MHz)	Channel	Frequency (MHz)
52	5260	54	5270
56	5280	62	5310
60	5300		
64	5320		

IEEE 802.11a IEEE 802.11n (HT20)		IEEE 802.11n (HT40)	
UNII-2C		UNII-2C	
Channel	Frequency (MHz)	Channel	Frequency (MHz)
100	5500	102	5510
104	5520	110	5550
108	5540	118	5590
112	5560	126	5630
116	5580	134	5670
120	5600		
124	5620		
128	5640		
132	5660		
136	5680		
140	5700		

IEEE 802.11a IEEE 802.11n (HT20)		IEEE 802.11n (HT40)	
UNII-3		UNII-3	
Channel	Frequency (MHz)	Channel	Frequency (MHz)
149	5745	151	5755
153	5765	159	5795
157	5785		
161	5805		
165	5825		

(3) Table for Filed Antenna:

Ant.	Manufacture	Product	Type	Connector	Frequency Range (MHz)	Gain (dBi)
1		Wi-Fi Ant.	PCB	N/A	5150-5250	4.67
					5250-5350	5.38
					5470-5725	5.23
					5725-5850	5.23

2.2 TEST MODES

Test Items	Test mode	Channel	Note
AC power line conducted emissions	Normal/Idle	-	-
Transmitter Radiated Emissions (below 1GHz)	TX Mode_IEEE 802.11a	36	-
Transmitter Radiated Emissions (above 1GHz)	TX Mode_IEEE 802.11a TX Mode_IEEE 802.11n (HT20)	36/48, 52/64 100/140, 149/165	Bandedge
	TX Mode_IEEE 802.11n (HT40)	38/46, 54/62 102/134, 151/159	
	TX Mode_IEEE 802.11a TX Mode_IEEE 802.11n (HT20)	36/40/48 52/60/64 100/116/140 149/157/165	Harmonic
	TX Mode_IEEE 802.11n (HT40)	38/46, 54/62 102/110/134 151/159	
Bandwidth & Power Spectral Density	TX Mode_IEEE 802.11a TX Mode_IEEE 802.11n (HT20)	36/40/48 52/60/64 100/116/140 149/157/165	-
	TX Mode_IEEE 802.11n (HT40)	38/46, 54/62 102/110/134 151/159	
Output Power	TX Mode_IEEE 802.11a TX Mode_IEEE 802.11n (HT20)	36/40/48 52/60/64 100/116/140 149/157/165	-
	TX Mode_IEEE 802.11n (HT40)	38/46, 54/62 102/110/134 151/159	

NOTE:

- (1) The Radiated emissions test was verified based on the worst conducted power and Bandwidth test results reported in the original report.
- (2) For radiated emission band edge test, both Vertical and Horizontal are evaluated, but only the worst case (Vertical) is recorded.
- (3) All X, Y and Z axes are evaluated, but only the worst case (Y axis) is recorded.
- (4) There were no emissions found below 30 MHz within 20 dB of the limit.

2.3 BLOCK DIAGRAM SHOWING THE CONFIGURATION OF SYSTEM TESTED

Equipment letters and Cable numbers refer to item numbers described in the tables of clause 2.4.

AC power line conducted emissions

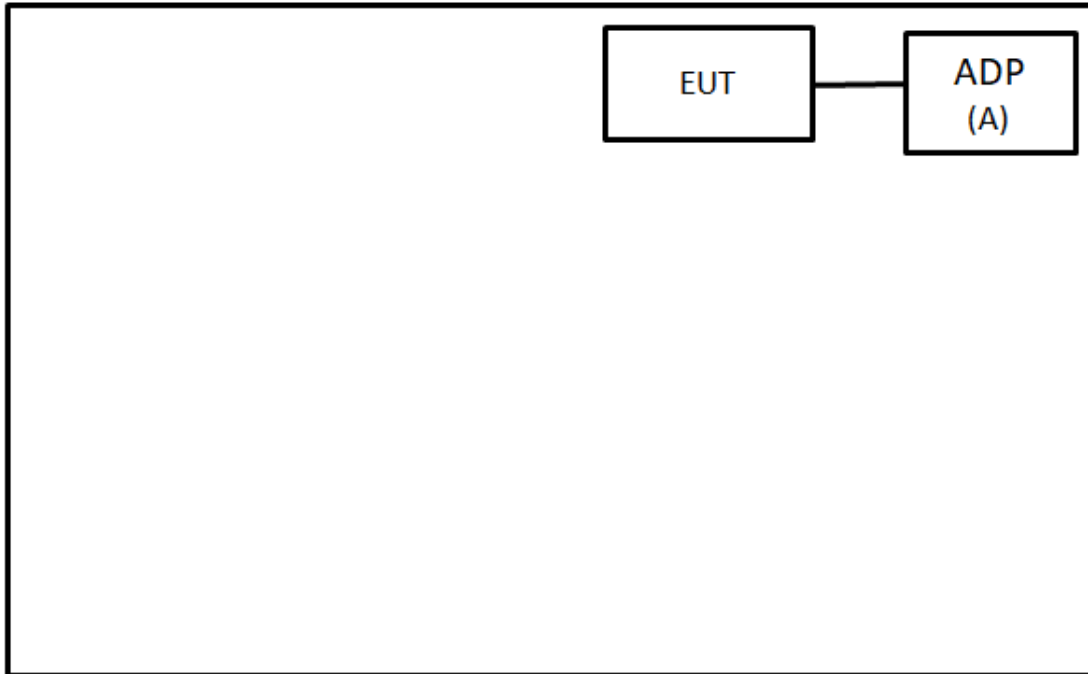

Radiated Emissions

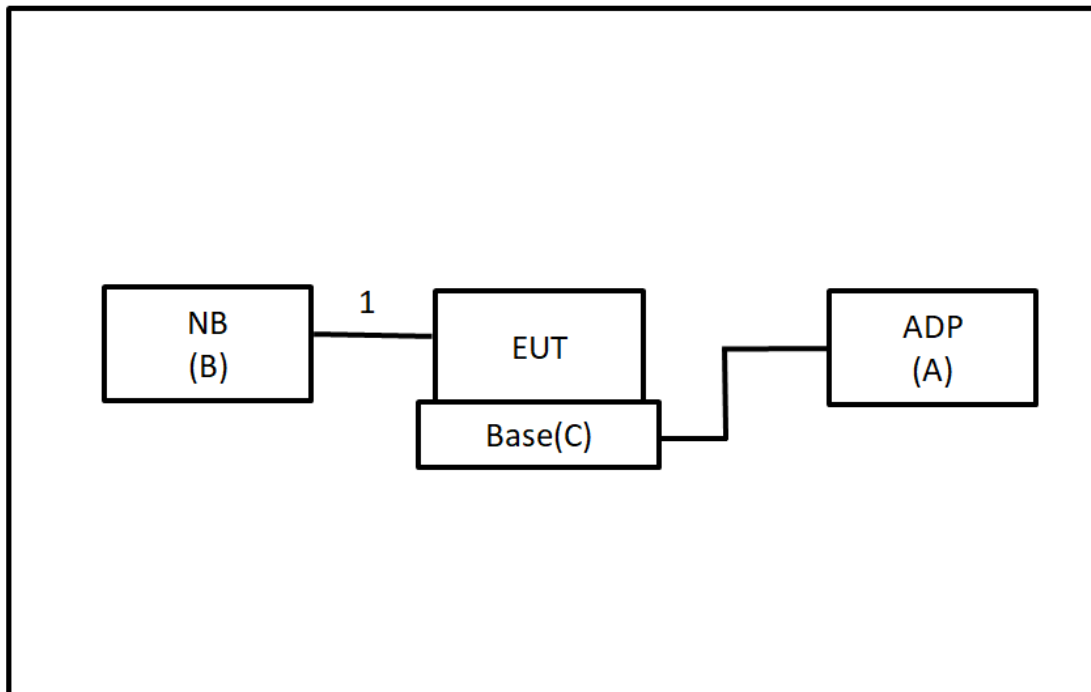

2.4 SUPPORT UNITS

Item	Equipment	Brand	Model No.	Series No.	Remarks
A	Adapter	SIMSUKIAN	SK03T-1200200Z	N/A	Supplied by test requester.
B	NB	hp	TPN-I119	N/A	Furnished by test lab.
C	Base	HIPCAM	N/A	N/A	Supplied by test requester.

Item	Shielded	Ferrite Core	Length	Cable Type	Remarks
1	N/A	N/A	1m	USB Cable	Furnished by test lab.

3 AC POWER LINE CONDUCTED EMISSIONS TEST

3.1 LIMIT

Frequency (MHz)	Limit (dB μ V)	
	Quasi-peak	Average
0.15 - 0.5	66 - 56 *	56 - 46 *
0.50 - 5.0	56	46
5.0 - 30.0	60	50

NOTE:

- (1) The tighter limit applies at the band edges.
- (2) The limit of " * " marked band means the limitation decreases linearly with the logarithm of the frequency in the range.
- (3) The test result calculated as following:
 Measurement Value = Reading Level + Correct Factor
 Correct Factor = Insertion Loss + Cable Loss + Attenuator Factor (if use)
 Margin Level = Measurement Value – Limit Value
 Calculation example:

Reading Level		Correct Factor		Measurement Value
38.22	+	3.45	=	41.67

Measurement Value		Limit Value		Margin Level
41.67	-	60	=	-18.33

The following table is the setting of the receiver.

Receiver Parameter	Setting
Attenuation	10 dB
Start Frequency	0.15 MHz
Stop Frequency	30 MHz
IF Bandwidth	9 KHz

3.2 TEST PROCEDURE

- a. The EUT was placed 0.8 m above the horizontal ground plane with the EUT being connected to the power mains through a line impedance stabilization network (LISN).
 All other support equipment were powered from an additional LISN(s).
 The LISN provides 50 Ohm/50uH of impedance for the measuring instrument.
- b. Interconnecting cables that hang closer than 40 cm to the ground plane shall be folded back and forth in the center forming a bundle to keep the cable above 40 cm.
- c. Excess I/O cables that are not connected to a peripheral shall be bundled in the center.
 The end of the cable will be terminated, using the correct terminating impedance.
 The overall length shall not exceed 1 m.
- d. The LISN is spaced at least 80 cm from the nearest part of the EUT chassis.
- e. For the actual test configuration, please refer to the related Item – EUT TEST PHOTO.

NOTE:

- (1) In the results, each reading is marked as Peak, QP or AVG per the detector used.
 BW=9 kHz (6 dB Bandwidth)
- (2) All readings are Peak unless otherwise stated QP or AVG in column of Note. Both the QP and the AVG readings must be less than the limit for compliance.

3.3 DEVIATION FROM TEST STANDARD

No deviation.

3.4 TEST SETUP

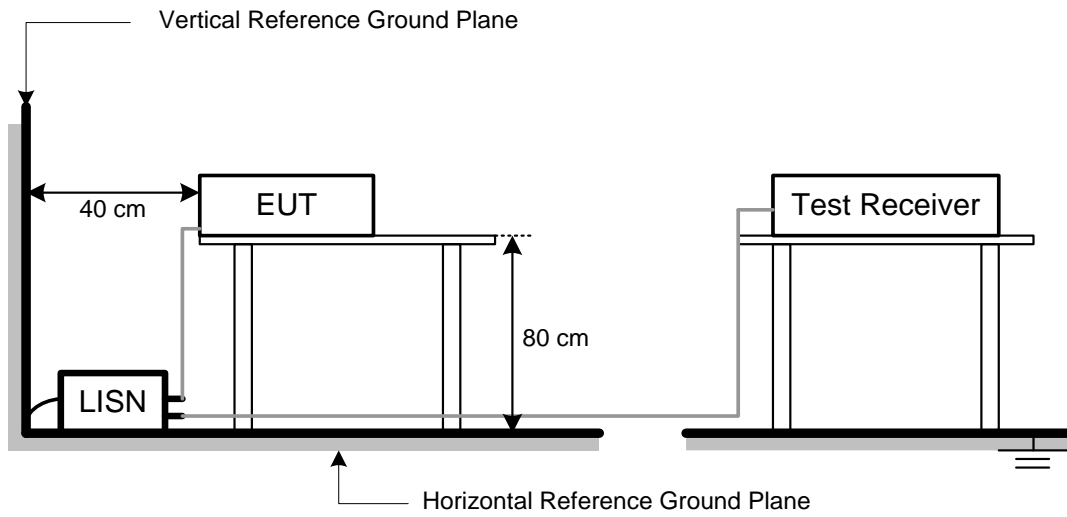

3.5 TEST RESULT

Please refer to the APPENDIX A.

4 RADIATED EMISSIONS TEST

4.1 LIMIT

In case the emission fall within the restricted band specified on 15.205, then the 15.209 limit in the table below has to be followed.

LIMITS OF RADIATED EMISSIONS MEASUREMENT (9 kHz to 1000 MHz)

Frequency (MHz)	Field Strength (microvolts/meter)	Measurement Distance (meters)
0.009~0.490	2400/F(KHz)	300
0.490~1.705	24000/F(KHz)	30
1.705~30.0	30	30
30~88	100	3
88~216	150	3
216~960	200	3
960~1000	500	3

LIMITS OF UNWANTED EMISSION OUT OF THE RESTRICTED BANDS

Frequency (MHz)	EIRP Limit (dBm)	Equivalent Field Strength at 3m (dBμV/m)
5150-5250	-27	68.3
5250-5350	-27	68.3
5470-5725	-27	68.3
5725-5850	-27 (NOTE 2)	68.3
	10 (NOTE 2)	105.3
	15.6 (NOTE 2)	110.9
	27 (NOTE 2)	122.3

NOTE:

(1) The following formula is used to convert the equipment isotropic radiated power (eirp) to field strength:

$$E = \frac{1000000\sqrt{30P}}{3} \mu\text{V/m, where P is the eirp (Watts)}$$

(2) According to FCC 16-24, All emissions shall be limited to a level of -27 dBm/MHz at 75 MHz or more above or below the band edge increasing linearly to 10 dBm/MHz at 25 MHz above or below the band edge, and from 25 MHz above or below the band edge increasing linearly to a level of 15.6 dBm/MHz at 5 MHz above or below the band edge, and from 5 MHz above or below the band edge increasing linearly to a level of 27 dBm/MHz at the band edge.

(3) The test result calculated as following:

Measurement Value = Reading Level + Correct Factor

Correct Factor = Antenna Factor + Cable Loss - Amplifier Gain(if use)

Margin Level = Measurement Value - Limit Value

Calculation example:

Reading Level		Correct Factor		Measurement Value
36.23	+	-11.97	=	24.26

Measurement Value		Limit Value		Margin Level
24.26	-	40	=	-15.74

Spectrum Parameter	Setting
Attenuation	Auto
Start Frequency	1000 MHz
Stop Frequency	10th carrier harmonic
RBW / VBW (Emission in restricted band)	1MHz / 3MHz for Peak, 1MHz / 1/T for Average

Spectrum Parameter	Setting
Attenuation	Auto
Start ~ Stop Frequency	9KHz~90KHz for PK/AVG detector
Start ~ Stop Frequency	90KHz~110KHz for QP detector
Start ~ Stop Frequency	110KHz~490KHz for PK/AVG detector
Start ~ Stop Frequency	490KHz~30MHz for QP detector
Start ~ Stop Frequency	30MHz~1000MHz for QP detector

4.2 TEST PROCEDURE

- a. The measuring distance of 3 m shall be used for measurements. The EUT was placed on the top of a rotating table 0.8 meter above the ground at a 3 meter semi-anechoic chamber. The table was rotated 360 degrees to determine the position of the highest radiation.(below 1GHz)
- b. The measuring distance of 3 m shall be used for measurements. The EUT was placed on the top of a rotating table 1.5 meter above the ground at a 3 meter semi-anechoic chamber. The table was rotated 360 degrees to determine the position of the highest radiation.(above 1GHz)
- c. The height of the equipment or of the substitution antenna shall be 0.8 m or 1.5 m, the height of the test antenna shall vary between 1 m to 4 m. Both horizontal and vertical polarizations of the antenna are set to make the measurement.
- d. For each suspected emission, the EUT was arranged to its worst case and then the antenna was tuned to heights find the maximum reading (used Bore sight function).
- e. The receiver system was set to peak and average detect function and specified bandwidth with maximum hold mode when the test frequency is above 1GHz.
- f. The initial step in collecting radiated emission data is a receiver peak detector mode pre-scanning the measurement frequency range. Significant peaks are then marked and then Quasi Peak detector mode re-measured.
- g. All readings are Peak unless otherwise stated QP in column of Note. Peak denotes that the Peak reading compliance with the QP Limits and then QP Mode measurement didn't perform. (below 1GHz)
- h. All readings are Peak Mode value unless otherwise stated AVG in column of Note. If the Peak Mode Measured value compliance with the Peak Limits and lower than AVG Limits, the EUT shall be deemed to meet both Peak & AVG Limits and then only Peak Mode was measured, but AVG Mode didn't perform. (above 1GHz)
- i. For the actual test configuration, please refer to the related Item – EUT TEST PHOTO.

4.3 DEVIATION FROM TEST STANDARD

No deviation.

4.4 TEST SETUP

30 MHz to 1 GHz

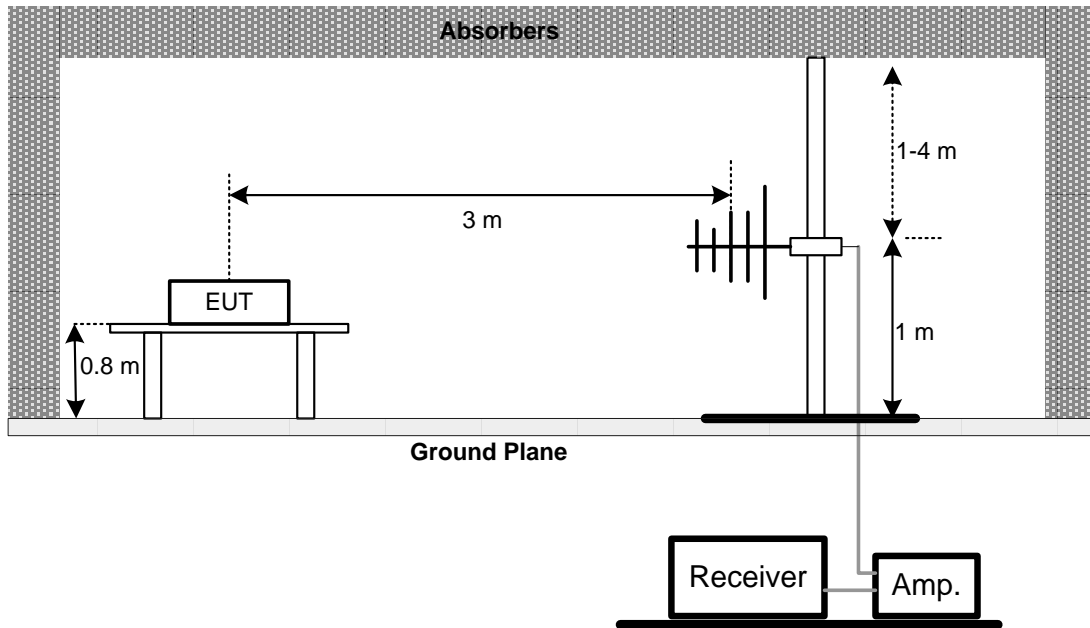

Above 1 GHz

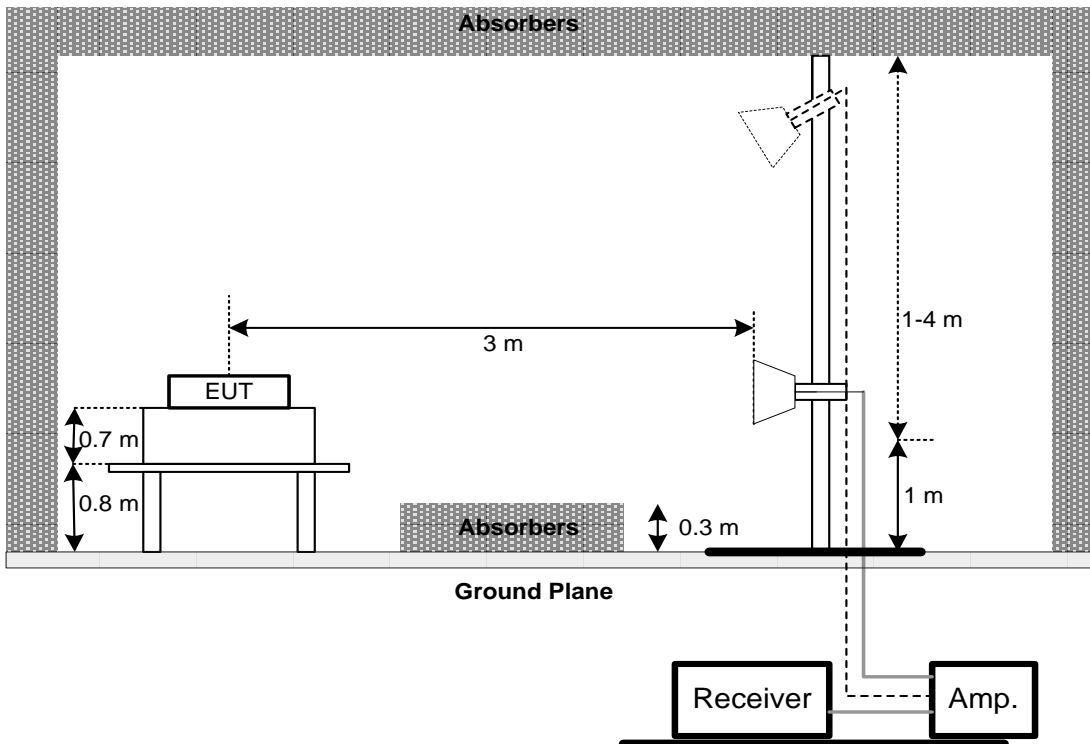

4.5 EUT OPERATING CONDITIONS

The EUT was programmed to be in continuously transmitting mode.

4.6 TEST RESULT – 30 MHZ TO 1 GHZ

Please refer to the APPENDIX B.

4.7 TEST RESULT – ABOVE 1 GHZ

Please refer to the APPENDIX C.

NOTE:

- (1) No limit: This is fundamental signal, the judgment is not applicable.
For fundamental signal judgment was referred to Peak output test.

5 BANDWIDTH TEST

5.1 LIMIT

FCC Part15, Subpart E (15.407)		
Section	Test Item	Frequency Range (MHz)
15.407(a)	26 dB Bandwidth	5150-5250
		5250-5350
		5470-5725
	Minimum 500 kHz 6 dB Bandwidth	5725-5850

5.2 TEST PROCEDURE

- a. The EUT was directly connected to the spectrum analyzer and antenna output port as show in the block diagram below.
- b. Spectrum Setting:

Spectrum Parameter	Setting
Attenuation	Auto
Span Frequency	> 26 dB Bandwidth
RBW	300 kHz(Bandwidth 20 MHz) 1 MHz(Bandwidth 40 MHz and 80 MHz)
VBW	1 MHz(Bandwidth 20 MHz) 3 MHz(Bandwidth 40 MHz and 80 MHz)
Detector	Peak
Trace	Max Hold
Sweep Time	Auto

5.3 DEVIATION FROM TEST STANDARD

No deviation.

5.4 TEST SETUP



5.5 EUT OPERATING CONDITIONS

The EUT was programmed to be in continuously transmitting mode.

5.6 TEST RESULT

Please refer to the APPENDIX D.

6 OUTPUT POWER TEST

6.1 LIMIT

FCC Part15, Subpart E (15.407)			
Section	Test Item	Limit	Frequency Range (MHz)
15.407(a)	Maximum Output Power	Fixed:1 Watt (30 dBm) Mobile and portable: 250 mW (24 dBm)	5150-5250
		250 mW (24 dBm)	5250-5350
			5470-5725
		1 Watt (30dBm)	5725-5850

Note: The maximum e.i.r.p at any elevation angle above 30 degrees as measured from the horizon must not exceed 125 mW(21 dBm).

6.2 TEST PROCEDURE

- a. The EUT was directly connected to the power meter and antenna output port as show in the block diagram below.
- b. Spectrum Setting:

Spectrum Parameter	Setting
Attenuation	Auto
Span Frequency	Encompass the entire emissions bandwidth (EBW) of the signal
RBW	= 1 MHz
VBW	≥ 3 MHz
Detector	RMS
Trace	Max Hold
Sweep Time	auto

- c. The maximum peak conducted output power was performed in accordance with method of FCC KDB 789033 D02 General UNII Test Procedures New Rules v02r01.

6.3 DEVIATION FROM TEST STANDARD

No deviation.

6.4 TEST SETUP



6.5 EUT OPERATING CONDITIONS

The EUT was programmed to be in continuously transmitting mode.

6.6 TEST RESULT

Please refer to the APPENDIX E.

7 POWER SPECTRAL DENSITY

7.1 LIMIT

FCC Part15, Subpart E (15.407)			
Section	Test Item	Limit	Frequency Range (MHz)
15.407(a)	Power Spectral Density	Other than Mobile and portable: 17 dBm/MHz	5150-5250
		Mobile and portable: 11 dBm/MHz	
		11 dBm/MHz	5250-5350
		30 dBm/500 kHz	5470-5725
			5725-5850

7.2 TEST PROCEDURE

- The EUT was directly connected to the spectrum analyzer and antenna output port as show in the block diagram below.
- Spectrum Setting:

Spectrum Parameter	Setting
Attenuation	Auto
Span Frequency	Encompass the entire emissions bandwidth (EBW) of the signal
RBW	= 1 MHz
VBW	≥ 3 MHz
Detector	RMS
Trace	Max Hold
Sweep Time	Auto

7.3 DEVIATION FROM TEST STANDARD

No deviation.

7.4 TEST SETUP



7.5 EUT OPERATING CONDITIONS

The EUT was programmed to be in continuously transmitting mode.

7.6 TEST RESULT

Please refer to the APPENDIX F.

8 LIST OF MEASURING EQUIPMENTS

AC Power Line Conducted Emissions						
Item	Kind of Equipment	Manufacturer	Type No.	Serial No.	Calibrated Date	Calibrated Until
1	TWO-LINE V-NETWORK	R&S	ENV216	101050	2020/6/11	2021/6/10
2	Test Cable	EMCI	EMC400-BM-BM-5000	170501	2020/6/8	2021/6/7
3	EMI Test Receiver	R&S	ESCI	100080	2020/6/15	2021/6/14
4	Measurement Software	EZ	EZ EMC (Version NB-03A1-01)	N/A	N/A	N/A

Radiated Emissions						
Item	Kind of Equipment	Manufacturer	Type No.	Serial No.	Calibrated Date	Calibrated Until
1	Preamplifier	EMCI	EMC001340	980555	2020/4/10	2021/4/9
2	Preamplifier	EMCI	EMC02325B	980217	2020/4/10	2021/4/9
3	Preamplifier	EMCI	EMC012645B	980267	2020/4/10	2021/4/9
4	Preamplifier	EMCI	EMC184045SE	980512	2020/6/1	2021/5/31
5	Test Cable	EMCI	EMC-SM-SM-1000	180809	2020/4/10	2021/4/9
6	Test Cable	EMCI	EMC104-SM-SM-3000	151205	2020/4/10	2021/4/9
7	Test Cable	EMCI	EMC-SM-SM-7000	180408	2020/4/10	2021/4/9
8	MXE EMI Receiver	Agilent	N9038A	MY554200087	2020/6/10	2021/6/9
9	Signal Analyzer	Agilent	N9010A	MY56480554	2020/8/25	2021/8/24
10	Loop Ant	Electro-Metrics	EMCI-LPA600	274	2020/6/16	2021/6/15
11	Horn Ant	SCHWARZBECK	BBHA 9120D	9120D-1342	2020/6/12	2021/6/11
12	Horn Ant	Schwarzbeck	BBHA 9170	BBHA 9170340	2020/7/9	2021/7/8
13	Trilog-Broadband Antenna	Schwarzbeck	VULB 9168	VULB 9168-352	2020/7/24	2021/7/23
14	5dB Attenuator	EMCI	EMCI-N-6-05	AT-N0625	2020/7/24	2021/7/23
15	Measurement Software	EZ	EZ EMC (Version NB-03A1-01)	N/A	N/A	N/A

Bandwidth						
Item	Kind of Equipment	Manufacturer	Type No.	Serial No.	Calibrated Date	Calibrated Until
1	Spectrum Analyzer	R&S	FSP 40	100129	2020/6/15	2021/6/14

Output Power						
Item	Kind of Equipment	Manufacturer	Type No.	Serial No.	Calibrated Date	Calibrated Until
1	Power Meter	Anritsu	ML2495A	1128008	2020/6/11	2021/6/10
2	Power Sensor	Anritsu	MA2411B	1126001	2020/6/11	2021/6/10

Power Spectral Density						
Item	Kind of Equipment	Manufacturer	Type No.	Serial No.	Calibrated Date	Calibrated Until
1	Spectrum Analyzer	R&S	FSP 40	100129	2020/6/15	2021/6/14
2	Spectrum Analyzer	R&S	FSV 7	103032	2020/9/9	2021/9/8

Remark: "N/A" denotes no model name, no serial no. or no calibration specified.
All calibration period of equipment list is one year.

9 EUT TEST PHOTO

Please refer to document Appendix No.: TP-2101T111-FCCP-1 (APPENDIX-TEST PHOTOS).

10 EUT PHOTOS

Please refer to document Appendix No.: EP-2101T111-1 (APPENDIX-EUT PHOTOS).

APPENDIX A AC POWER LINE CONDUCTED EMISSIONS

Test Mode	Normal	Tested Date	2021/3/12
Test Frequency	-	Phase	Line

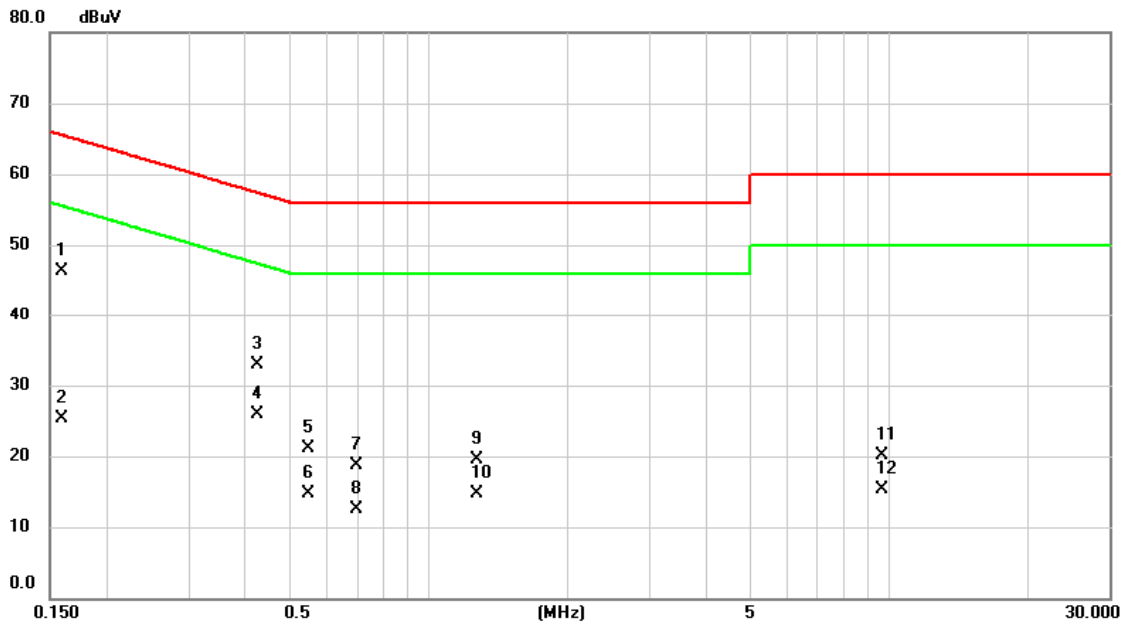

No.	Mk.	Freq. MHz	Reading Level dBuV	Correct Factor dB	Measure- ment dBuV	Limit dBuV	Over dB	Detector	Comment
1	*	0.1590	36.64	9.68	46.32	65.52	-19.20	QP	
2		0.1590	15.71	9.68	25.39	55.52	-30.13	AVG	
3		0.4267	23.24	9.68	32.92	57.32	-24.40	QP	
4		0.4267	16.18	9.68	25.86	47.32	-21.46	AVG	
5		0.5503	11.47	9.68	21.15	56.00	-34.85	QP	
6		0.5503	4.94	9.68	14.62	46.00	-31.38	AVG	
7		0.6967	8.94	9.68	18.62	56.00	-37.38	QP	
8		0.6967	2.81	9.68	12.49	46.00	-33.51	AVG	
9		1.2727	9.73	9.70	19.43	56.00	-36.57	QP	
10		1.2727	5.09	9.70	14.79	46.00	-31.21	AVG	
11		9.6315	10.18	9.92	20.10	60.00	-39.90	QP	
12		9.6315	5.34	9.92	15.26	50.00	-34.74	AVG	

REMARKS:

- (1) Measurement Value = Reading Level + Correct Factor.
- (2) Margin Level = Measurement Value - Limit Value.

Test Mode	Normal	Tested Date	2021/3/12
Test Frequency	-	Phase	Neutral

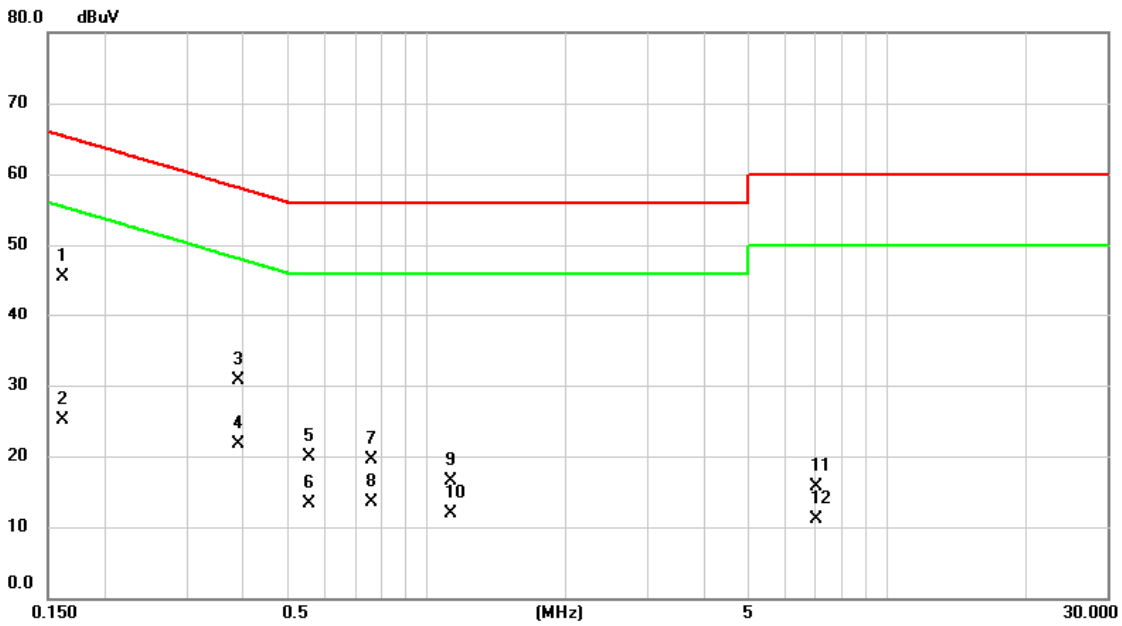

No.	Mk.	Freq. MHz	Reading Level dBuV	Correct Factor dB	Measure- ment dBuV	Limit dBuV	Over dB	Detector	Comment
1	*	0.1615	35.88	9.68	45.56	65.39	-19.83	QP	
2		0.1615	15.49	9.68	25.17	55.39	-30.22	AVG	
3		0.3907	21.03	9.68	30.71	58.05	-27.34	QP	
4		0.3907	11.98	9.68	21.66	48.05	-26.39	AVG	
5		0.5550	10.14	9.68	19.82	56.00	-36.18	QP	
6		0.5550	3.58	9.68	13.26	46.00	-32.74	AVG	
7		0.7575	9.72	9.69	19.41	56.00	-36.59	QP	
8		0.7575	3.83	9.69	13.52	46.00	-32.48	AVG	
9		1.1242	6.89	9.69	16.58	56.00	-39.42	QP	
10		1.1242	2.28	9.69	11.97	46.00	-34.03	AVG	
11		7.0238	5.90	9.87	15.77	60.00	-44.23	QP	
12		7.0238	1.32	9.87	11.19	50.00	-38.81	AVG	

REMARKS:

- (1) Measurement Value = Reading Level + Correct Factor.
- (2) Margin Level = Measurement Value - Limit Value.

Test Mode	Idle	Tested Date	2021/3/12
Test Frequency	-	Phase	Line

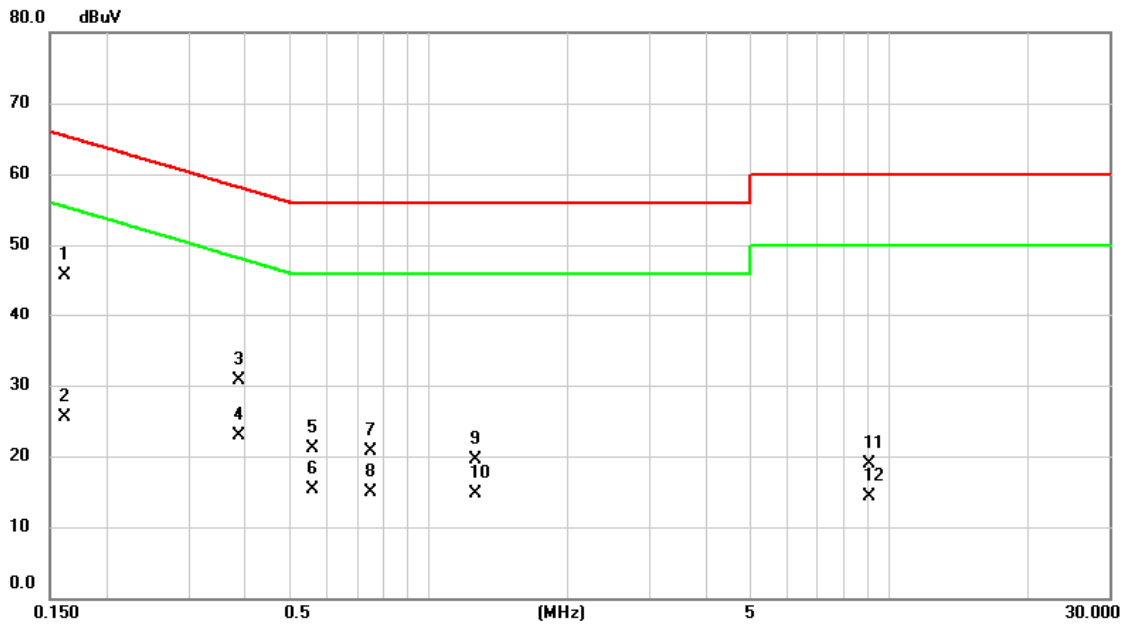

No.	Mk.	Freq. MHz	Reading Level dBuV	Correct Factor dB	Measure- ment dBuV	Limit dBuV	Over dB	Detector	Comment
1	*	0.1615	36.07	9.68	45.75	65.39	-19.64	QP	
2		0.1615	15.82	9.68	25.50	55.39	-29.89	AVG	
3		0.3885	21.12	9.68	30.80	58.10	-27.30	QP	
4		0.3885	13.22	9.68	22.90	48.10	-25.20	AVG	
5		0.5617	11.46	9.68	21.14	56.00	-34.86	QP	
6		0.5617	5.69	9.68	15.37	46.00	-30.63	AVG	
7		0.7507	10.99	9.69	20.68	56.00	-35.32	QP	
8		0.7507	5.28	9.69	14.97	46.00	-31.03	AVG	
9		1.2615	9.77	9.70	19.47	56.00	-36.53	QP	
10		1.2615	5.01	9.70	14.71	46.00	-31.29	AVG	
11		9.0330	9.05	9.91	18.96	60.00	-41.04	QP	
12		9.0330	4.32	9.91	14.23	50.00	-35.77	AVG	

REMARKS:

- (1) Measurement Value = Reading Level + Correct Factor.
- (2) Margin Level = Measurement Value - Limit Value.

Test Mode	Idle	Tested Date	2021/3/12
Test Frequency	-	Phase	Neutral

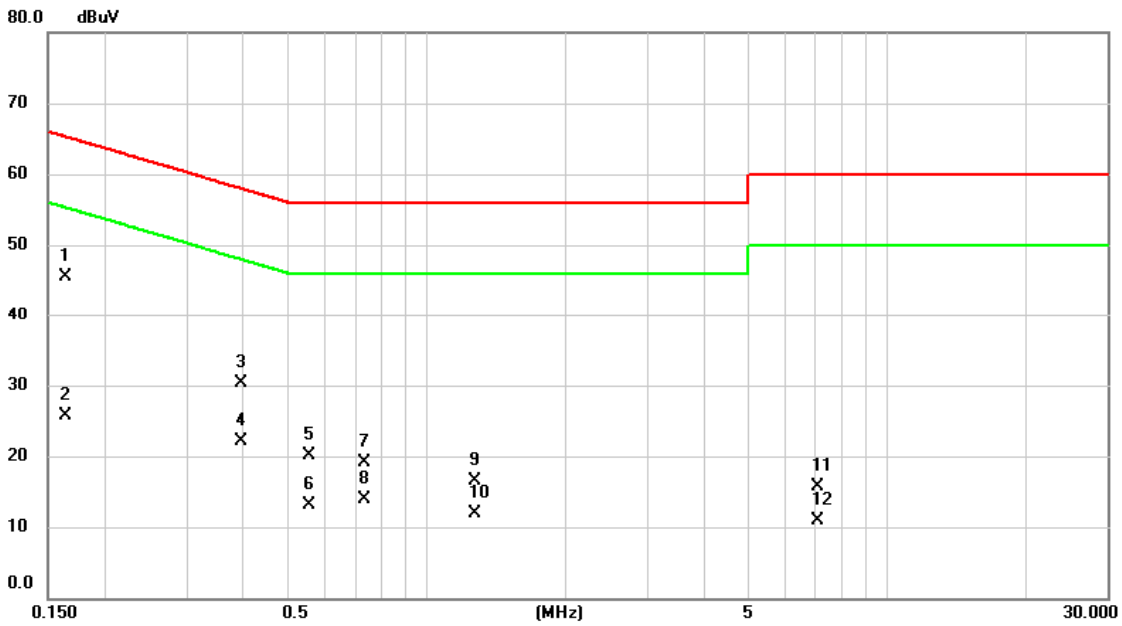

No.	Mk.	Freq. MHz	Reading Level dBuV	Correct Factor dB	Measure- ment dBuV	Limit dBuV	Over dB	Detector	Comment
1	*	0.1635	35.84	9.68	45.52	65.28	-19.76	QP	
2		0.1635	15.96	9.68	25.64	55.28	-29.64	AVG	
3		0.3952	20.63	9.68	30.31	57.95	-27.64	QP	
4		0.3952	12.42	9.68	22.10	47.95	-25.85	AVG	
5		0.5550	10.33	9.68	20.01	56.00	-35.99	QP	
6		0.5550	3.45	9.68	13.13	46.00	-32.87	AVG	
7		0.7350	9.49	9.68	19.17	56.00	-36.83	QP	
8		0.7350	4.16	9.68	13.84	46.00	-32.16	AVG	
9		1.2705	6.84	9.70	16.54	56.00	-39.46	QP	
10		1.2705	2.22	9.70	11.92	46.00	-34.08	AVG	
11		7.0530	5.92	9.87	15.79	60.00	-44.21	QP	
12		7.0530	1.10	9.87	10.97	50.00	-39.03	AVG	

REMARKS:

- (1) Measurement Value = Reading Level + Correct Factor.
- (2) Margin Level = Measurement Value - Limit Value.

APPENDIX B RADIATED EMISSIONS - 30 MHZ TO 1 GHZ

Test Mode	IEEE802.11a	Test Date	2021/3/8
Test Frequency	5180MHz	Polarization	Vertical
Temp	21°C	Hum.	68%

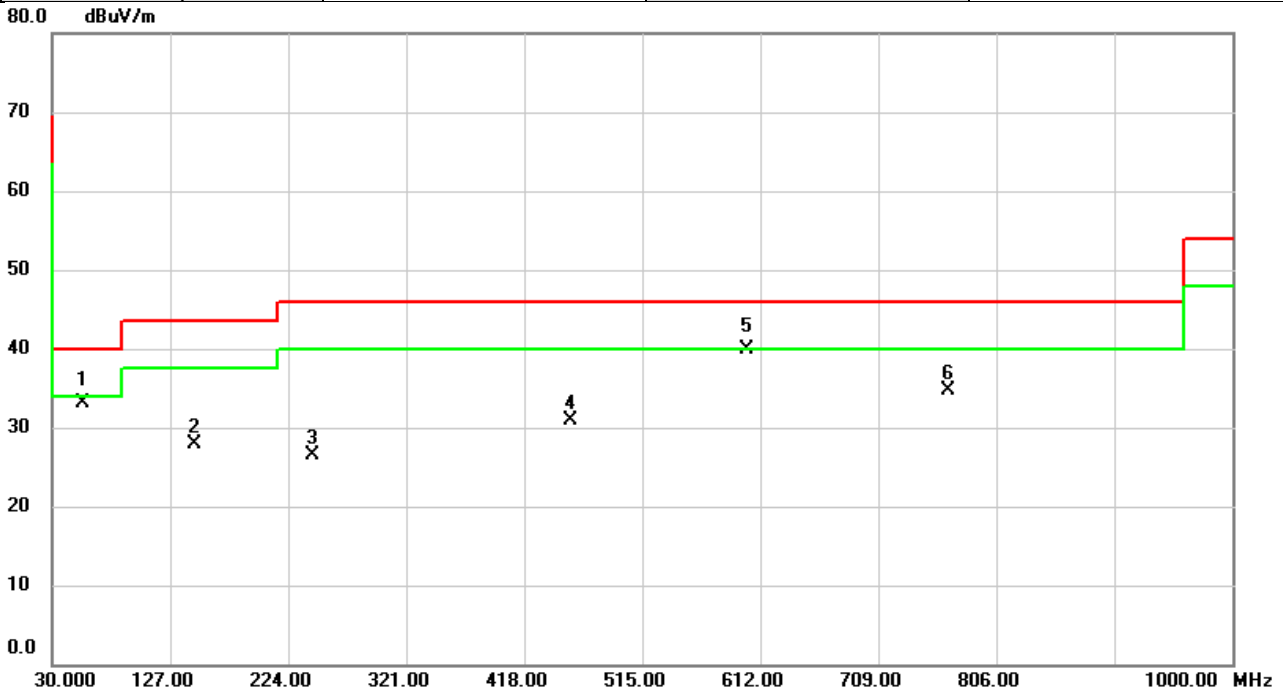

No.	Mk.	Freq. MHz	Reading Level dBuV	Correct Factor dB	Measure- ment dBuV/m	Limit dBuV/m	Over dB	Detector	Comment
1		55.2200	41.56	-8.36	33.20	40.00	-6.80	QP	
2		147.3700	36.40	-8.54	27.86	43.50	-15.64	peak	
3		244.3700	35.95	-9.50	26.45	46.00	-19.55	peak	
4		455.8300	34.52	-3.58	30.94	46.00	-15.06	peak	
5	*	600.3600	40.56	-0.63	39.93	46.00	-6.07	QP	
6		766.2300	32.51	2.14	34.65	46.00	-11.35	peak	

REMARKS:

- (1) Measurement Value = Reading Level + Correct Factor.
- (2) Margin Level = Measurement Value - Limit Value.

Test Mode	IEEE802.11a	Test Date	2021/3/8
Test Frequency	5180MHz	Polarization	Horizontal
Temp	21°C	Hum.	68%

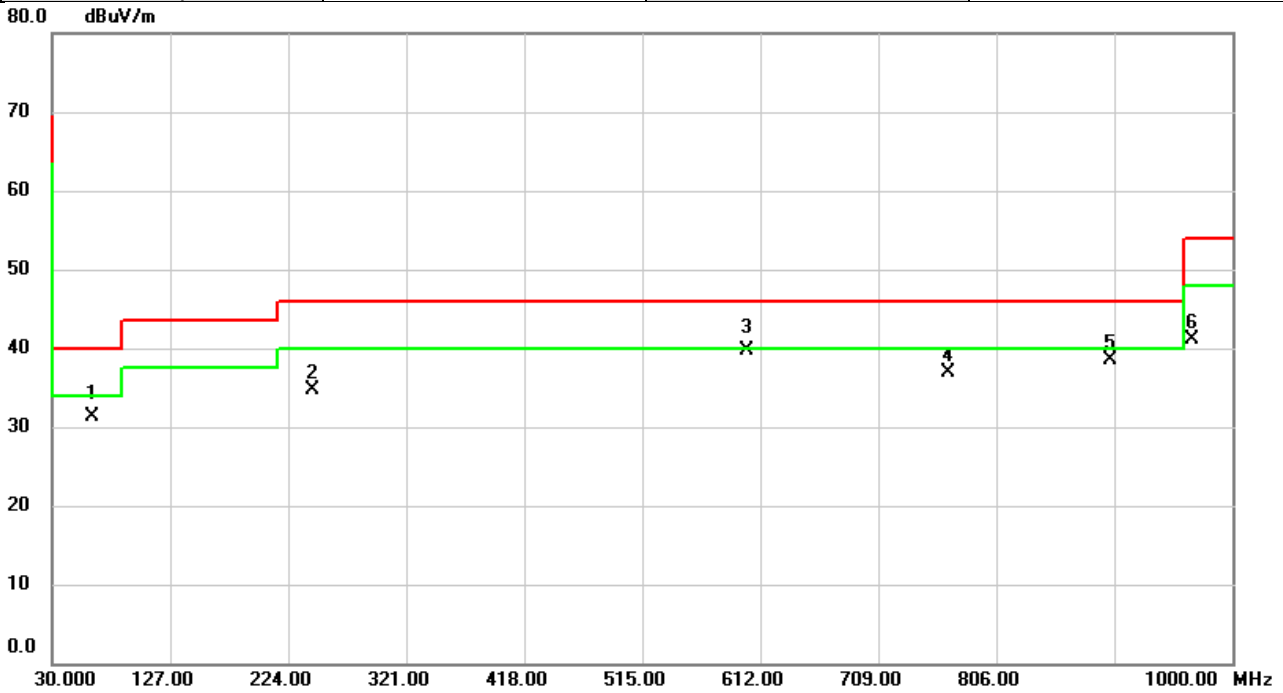

No.	Mk.	Freq. MHz	Reading Level dBuV	Correct Factor dB	Measure- ment dBuV/m	Limit dBuV/m	Over dB	Detector	Comment
1		62.9800	40.56	-9.27	31.29	40.00	-8.71	QP	
2		244.3700	44.21	-9.50	34.71	46.00	-11.29	peak	
3	*	600.3600	40.29	-0.63	39.66	46.00	-6.34	QP	
4		766.2300	34.71	2.14	36.85	46.00	-9.15	peak	
5		900.0900	34.29	4.15	38.44	46.00	-7.56	peak	
6		967.0200	35.89	5.30	41.19	54.00	-12.81	peak	

REMARKS:

- (1) Measurement Value = Reading Level + Correct Factor.
- (2) Margin Level = Measurement Value - Limit Value.

APPENDIX C RADIATED EMISSIONS - ABOVE 1 GHZ

Test Mode	IEEE802.11a	Test Date	2021/3/6
Test Frequency	5180MHz	Polarization	Vertical
Temp	22°C	Hum.	66%

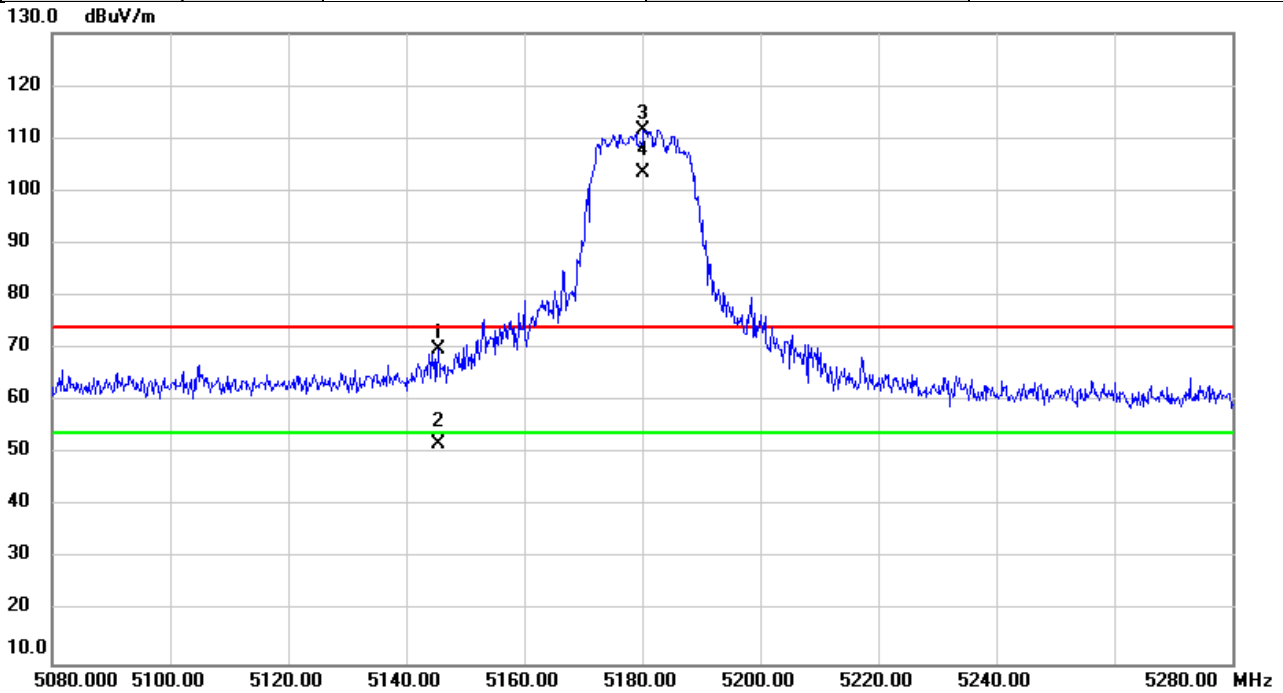

No.	Mk.	Freq.	Reading Level	Correct Factor	Measurement	Limit	Over	Detector	Comment
		MHz	dBuV	dB	dBuV/m	dBuV/m	dB		
1		5145.400	32.59	37.30	69.89	74.00	-4.11	peak	
2		5145.400	14.66	37.30	51.96	54.00	-2.04	AVG	
3	X	5180.000	74.33	37.33	111.66	74.00	37.66	peak	NoLimit
4	*	5180.000	66.03	37.33	103.36	54.00	49.36	AVG	NoLimit

REMARKS:

- (1) Measurement Value = Reading Level + Correct Factor.
- (2) Margin Level = Measurement Value - Limit Value.

Test Mode	IEEE802.11a	Test Date	2021/3/6
Test Frequency	5240MHz	Polarization	Vertical
Temp	22°C	Hum.	66%

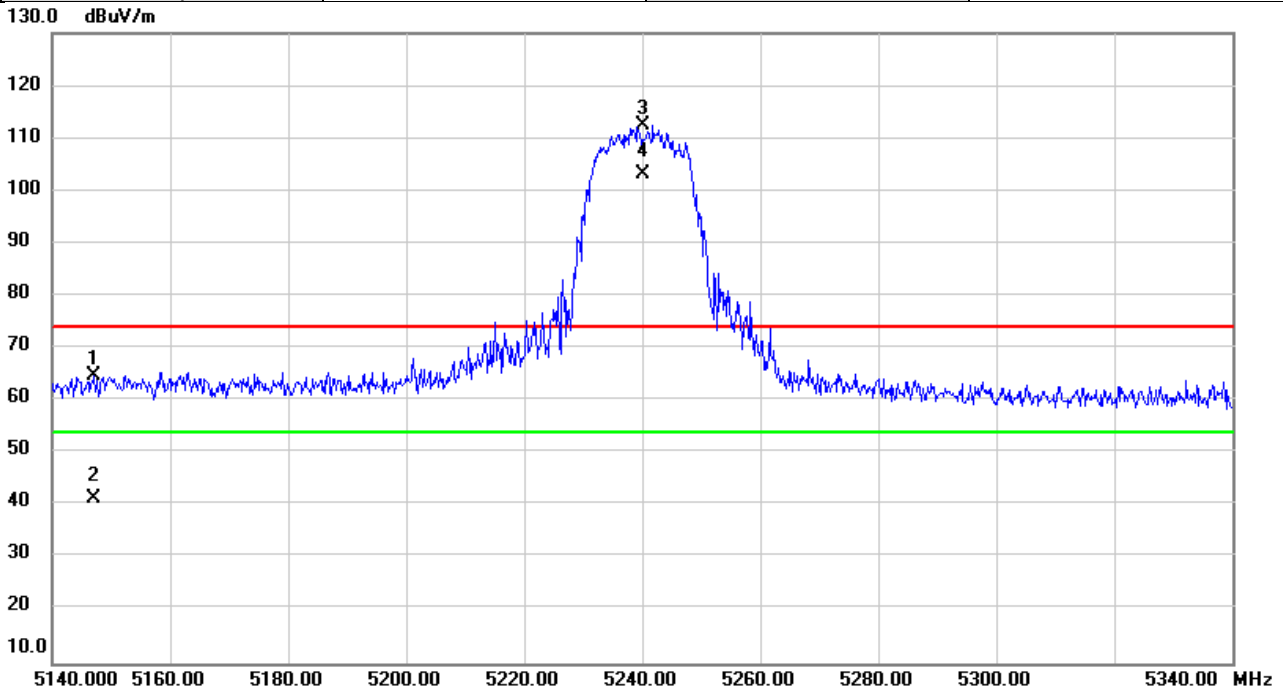

No.	Mk.	Freq.	Reading Level	Correct Factor	Measurement	Limit	Over	Detector	Comment
		MHz	dBuV	dB	dBuV/m	dBuV/m	dB		
1		5147.200	27.51	37.30	64.81	74.00	-9.19	peak	
2		5147.200	3.93	37.30	41.23	54.00	-12.77	AVG	
3	X	5240.000	75.03	37.38	112.41	74.00	38.41	peak	NoLimit
4	*	5240.000	65.83	37.38	103.21	54.00	49.21	AVG	NoLimit

REMARKS:

- (1) Measurement Value = Reading Level + Correct Factor.
- (2) Margin Level = Measurement Value - Limit Value.

Test Mode	IEEE802.11a	Test Date	2021/3/6
Test Frequency	5260MHz	Polarization	Vertical
Temp	22°C	Hum.	66%

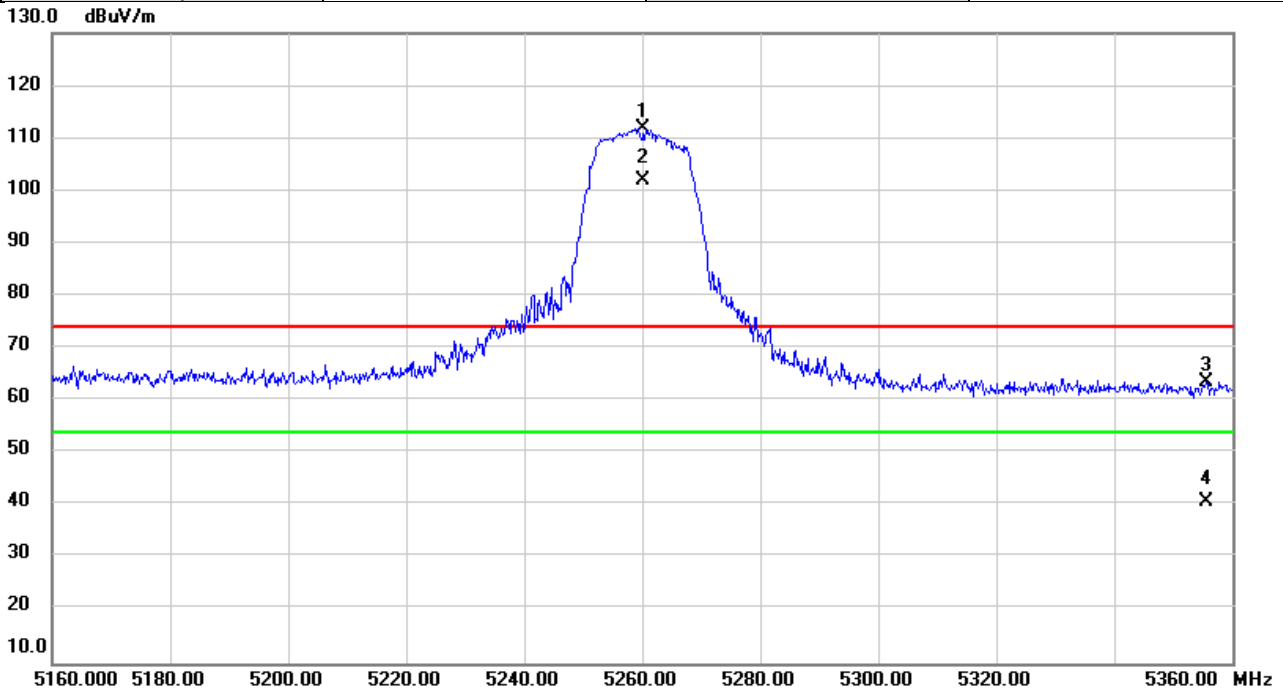

No.	Mk.	Freq.	Reading Level	Correct Factor	Measurement	Limit	Over	Detector	Comment
		MHz	dBuV	dB	dBuV/m	dBuV/m	dB		
1	X	5260.000	74.47	37.40	111.87	74.00	37.87	peak	NoLimit
2	*	5260.000	64.56	37.40	101.96	54.00	47.96	AVG	NoLimit
3		5355.600	26.20	37.48	63.68	74.00	-10.32	peak	
4		5355.600	3.25	37.48	40.73	54.00	-13.27	AVG	

REMARKS:

- (1) Measurement Value = Reading Level + Correct Factor.
- (2) Margin Level = Measurement Value - Limit Value.

Test Mode	IEEE802.11a	Test Date	2021/3/6
Test Frequency	5320MHz	Polarization	Vertical
Temp	22°C	Hum.	66%

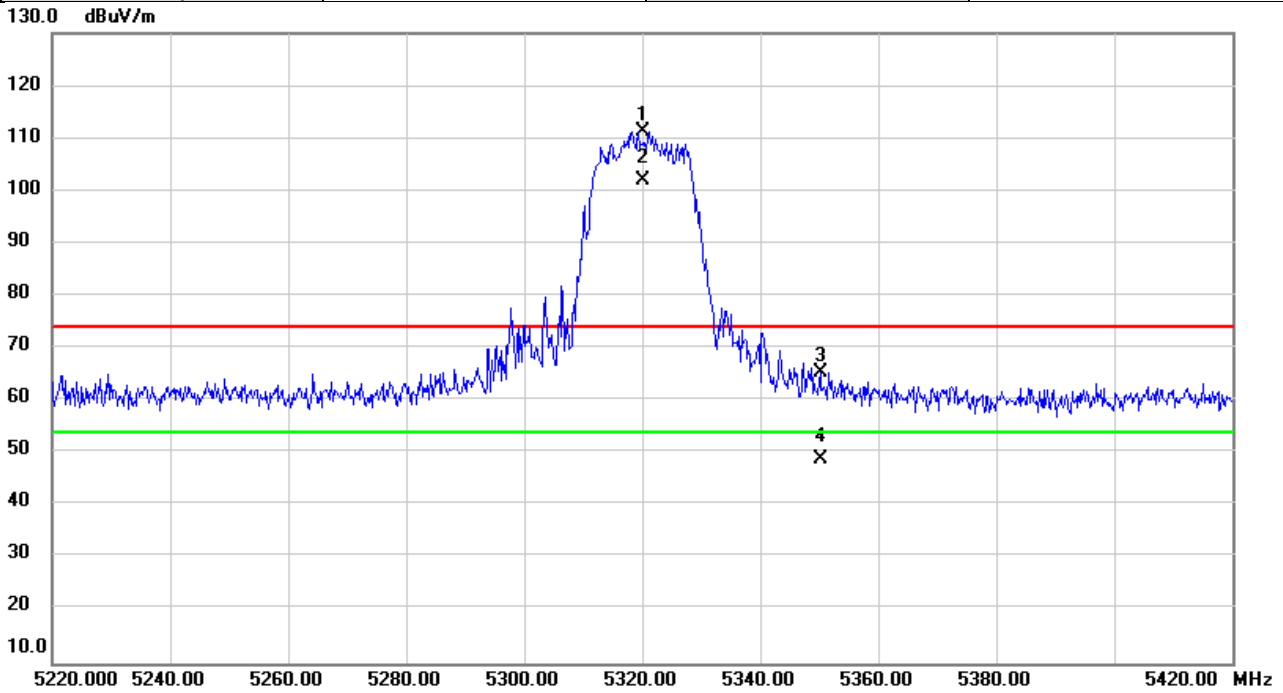

No.	Mk.	Freq.	Reading Level	Correct Factor	Measurement	Limit	Over	Detector	Comment
		MHz	dBuV	dB	dBuV/m	dBuV/m	dB		
1	X	5320.000	73.89	37.45	111.34	74.00	37.34	peak	NoLimit
2	*	5320.000	64.58	37.45	102.03	54.00	48.03	AVG	NoLimit
3		5350.200	27.89	37.48	65.37	74.00	-8.63	peak	
4		5350.200	11.41	37.48	48.89	54.00	-5.11	AVG	

REMARKS:

- (1) Measurement Value = Reading Level + Correct Factor.
- (2) Margin Level = Measurement Value - Limit Value.

Test Mode	IEEE802.11a	Test Date	2021/3/6
Test Frequency	5500MHz	Polarization	Vertical
Temp	22°C	Hum.	66%

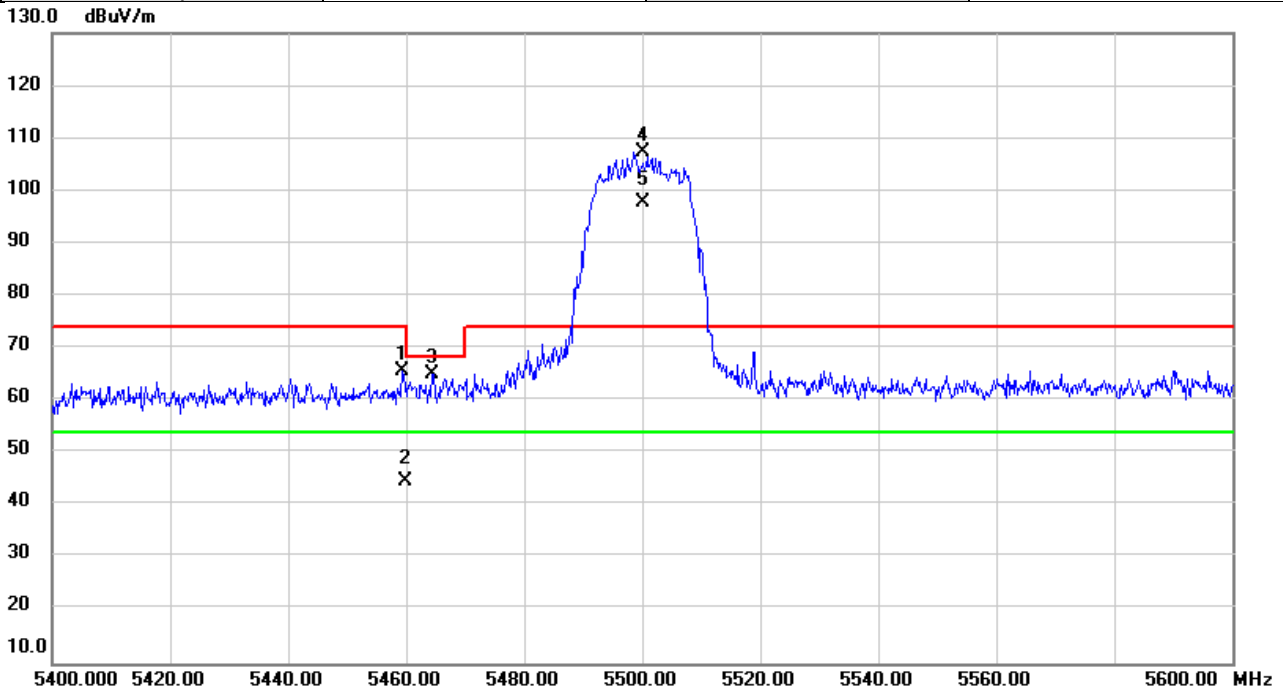

No.	Mk.	Freq.	Reading Level	Correct Factor	Measurement	Limit	Over	Detector	Comment
		MHz	dBuV	dB	dBuV/m	dBuV/m	dB		
1		5459.400	28.17	37.58	65.75	74.00	-8.25	peak	
2		5459.940	7.02	37.58	44.60	54.00	-9.40	AVG	
3		5464.400	27.50	37.58	65.08	68.20	-3.12	peak	
4	X	5500.000	69.69	37.61	107.30	74.00	33.30	peak	NoLimit
5	*	5500.000	60.23	37.61	97.84	54.00	43.84	AVG	NoLimit

REMARKS:

- (1) Measurement Value = Reading Level + Correct Factor.
- (2) Margin Level = Measurement Value - Limit Value.

Test Mode	IEEE802.11a	Test Date	2021/3/6
Test Frequency	5700MHz	Polarization	Vertical
Temp	22°C	Hum.	66%

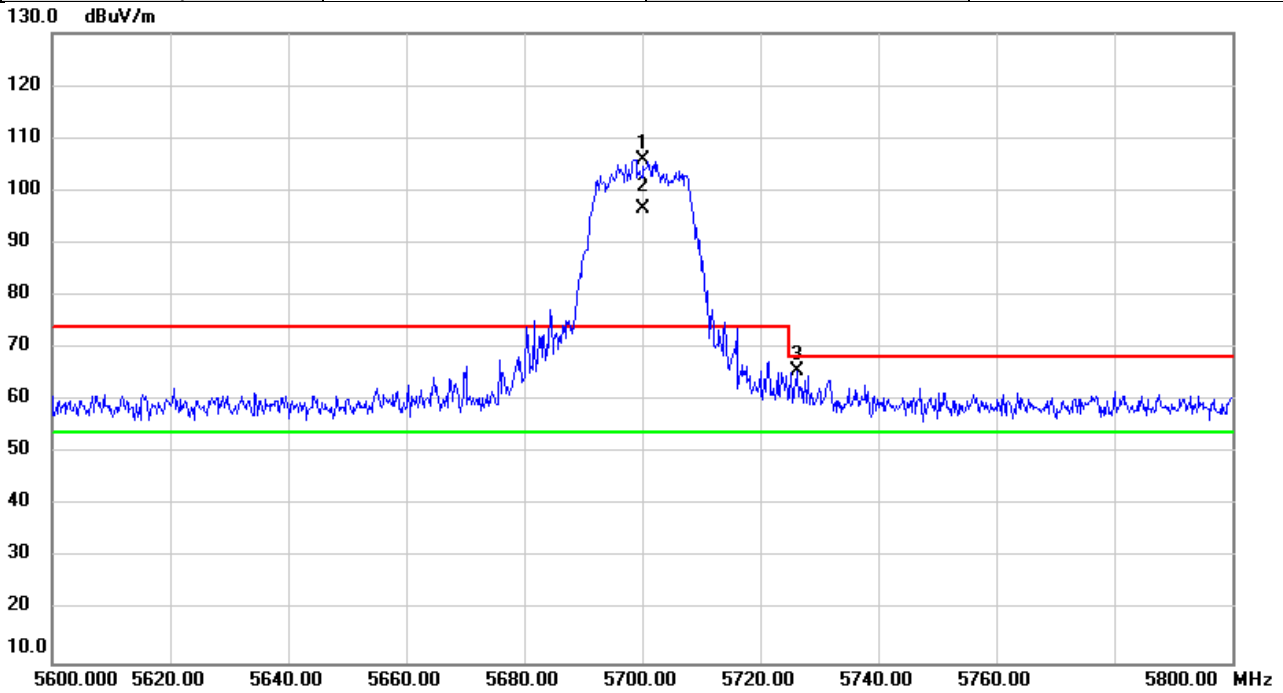

No.	Mk.	Freq.	Reading Level	Correct Factor	Measurement	Limit	Over	Detector	Comment
		MHz	dBuV	dB	dBuV/m	dBuV/m	dB		
1	X	5700.000	67.94	38.04	105.98	74.00	31.98	peak	NoLimit
2	*	5700.000	58.42	38.04	96.46	54.00	42.46	AVG	NoLimit
3		5726.200	27.66	38.09	65.75	68.20	-2.45	peak	

REMARKS:

- (1) Measurement Value = Reading Level + Correct Factor.
- (2) Margin Level = Measurement Value - Limit Value.

Test Mode	IEEE802.11a	Test Date	2021/3/6
Test Frequency	5745MHz	Polarization	Vertical
Temp	22°C	Hum.	66%

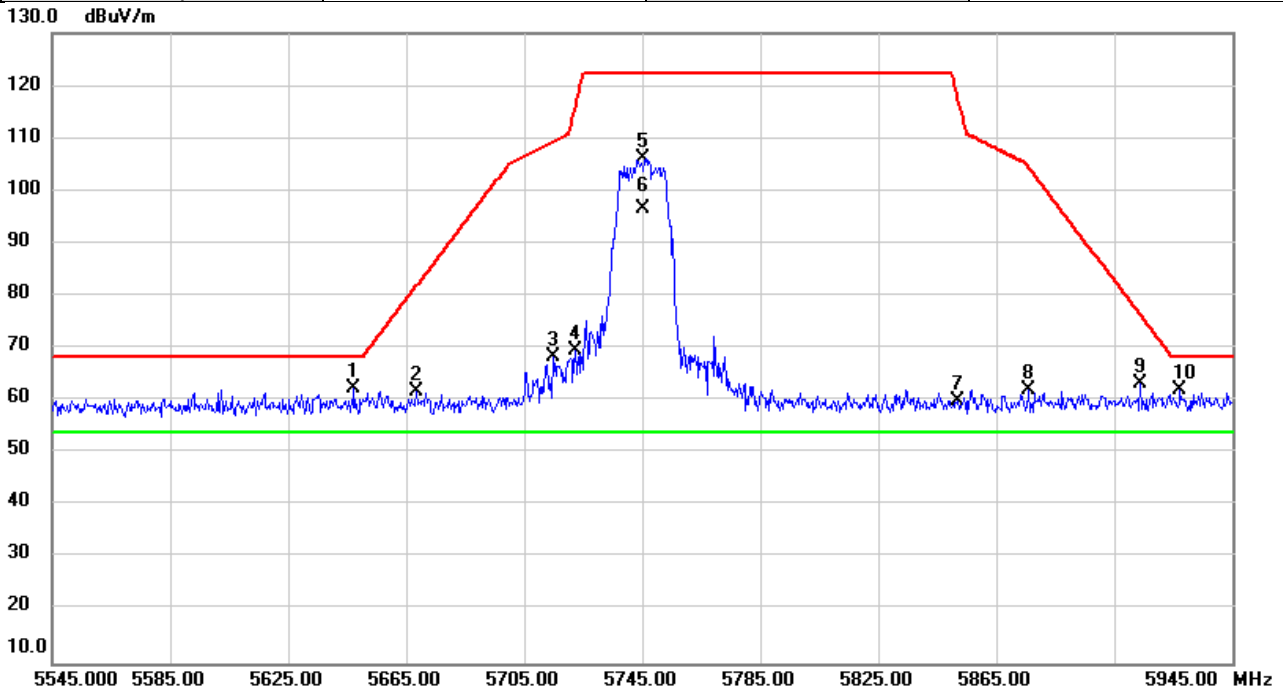

No.	Mk.	Freq.	Reading Level	Correct Factor	Measurement	Limit	Over	Detector	Comment
		MHz	dBuV	dB	dBuV/m	dBuV/m	dB		
1		5647.400	24.44	37.93	62.37	68.20	-5.83	peak	
2		5668.600	23.69	37.97	61.66	82.00	-20.34	peak	
3		5715.000	30.14	38.07	68.21	109.40	-41.19	peak	
4		5722.200	31.60	38.09	69.69	115.82	-46.13	peak	
5		5745.000	68.01	38.13	106.14	122.20	-16.06	peak	NoLimit
6	*	5745.000	58.57	38.13	96.70	54.00	42.70	AVG	NoLimit
7		5852.200	21.72	38.36	60.08	117.18	-57.10	peak	
8		5876.200	23.75	38.41	62.16	104.31	-42.15	peak	
9		5913.800	24.69	38.50	63.19	76.46	-13.27	peak	
10		5927.400	23.49	38.52	62.01	68.20	-6.19	peak	

REMARKS:

- (1) Measurement Value = Reading Level + Correct Factor.
- (2) Margin Level = Measurement Value - Limit Value.

Test Mode	IEEE802.11a	Test Date	2021/3/6
Test Frequency	5825MHz	Polarization	Vertical
Temp	22°C	Hum.	66%

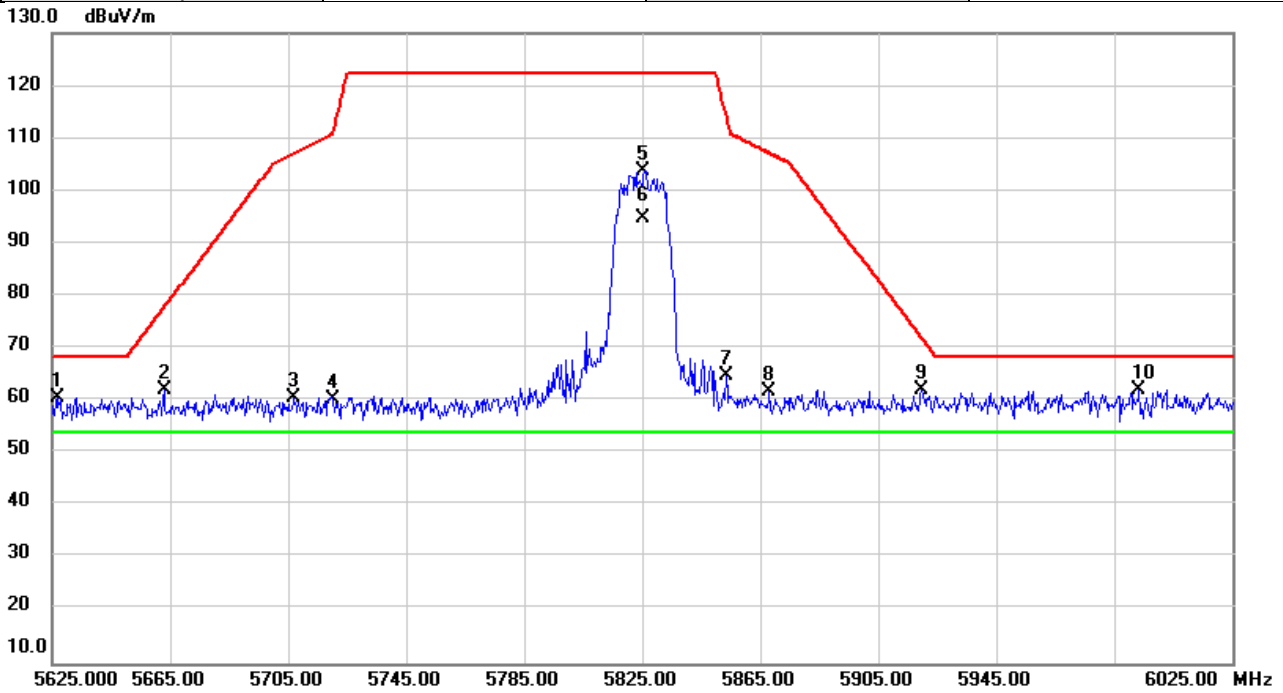

No.	Mk.	Freq. MHz	Reading Level dBuV	Correct Factor dB	Measure- ment dBuV/m	Limit dBuV/m	Over dB	Detector	Comment
1		5626.600	22.70	37.88	60.58	68.20	-7.62	peak	
2		5663.000	24.02	37.96	61.98	77.85	-15.87	peak	
3		5707.000	22.60	38.05	60.65	107.16	-46.51	peak	
4		5720.200	22.19	38.08	60.27	111.26	-50.99	peak	
5		5825.000	65.35	38.31	103.66	122.20	-18.54	peak	NoLimit
6	*	5825.000	56.51	38.31	94.82	54.00	40.82	AVG	NoLimit
7		5853.400	26.33	38.36	64.69	114.45	-49.76	peak	
8		5868.200	23.36	38.40	61.76	107.10	-45.34	peak	
9		5919.800	23.66	38.50	62.16	72.03	-9.87	peak	
10		5993.400	23.31	38.66	61.97	68.20	-6.23	peak	

REMARKS:

- (1) Measurement Value = Reading Level + Correct Factor.
- (2) Margin Level = Measurement Value - Limit Value.

Test Mode	IEEE802.11n (HT20)	Test Date	2021/3/6
Test Frequency	5180MHz	Polarization	Vertical
Temp	22°C	Hum.	66%

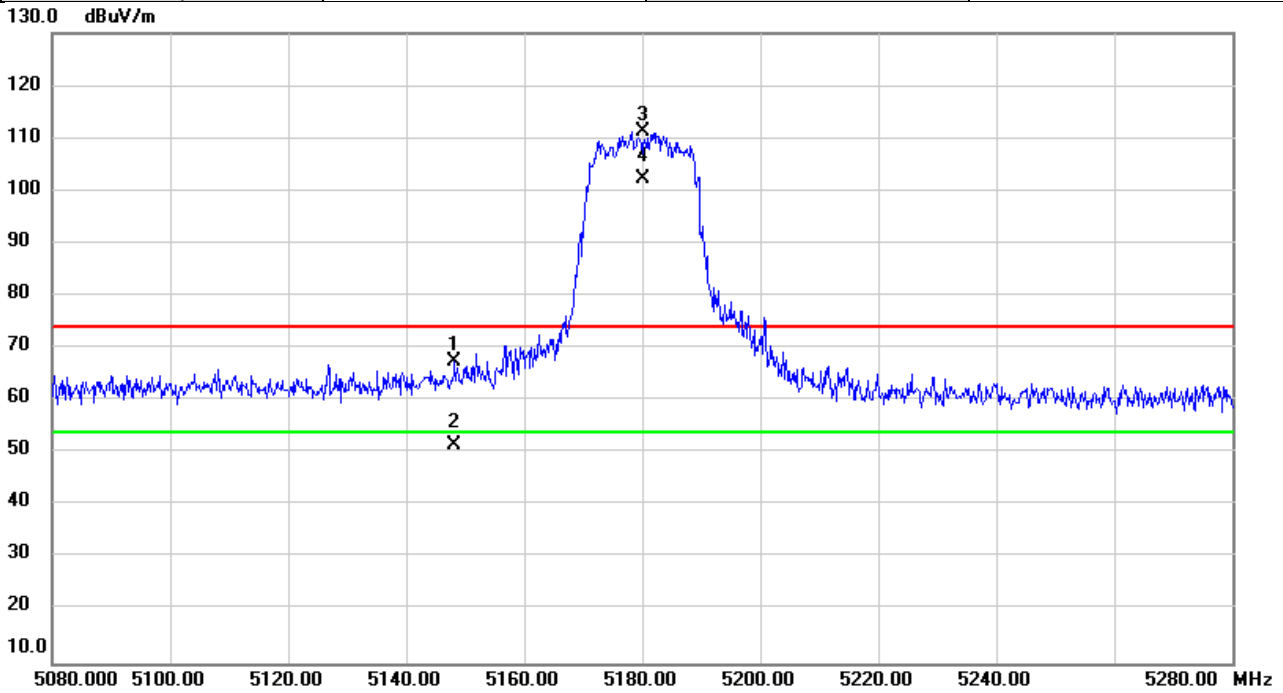

No.	Mk.	Freq.	Reading Level	Correct Factor	Measurement	Limit	Over	Detector	Comment
		MHz	dBuV	dB	dBuV/m	dBuV/m	dB		
1		5148.200	30.04	37.30	67.34	74.00	-6.66	peak	
2		5148.200	14.39	37.30	51.69	54.00	-2.31	AVG	
3	X	5180.000	74.01	37.33	111.34	74.00	37.34	peak	NoLimit
4	*	5180.000	64.84	37.33	102.17	54.00	48.17	AVG	NoLimit

REMARKS:

- (1) Measurement Value = Reading Level + Correct Factor.
- (2) Margin Level = Measurement Value - Limit Value.

Test Mode	IEEE802.11n (HT20)	Test Date	2021/3/6
Test Frequency	5240MHz	Polarization	Vertical
Temp	22°C	Hum.	66%

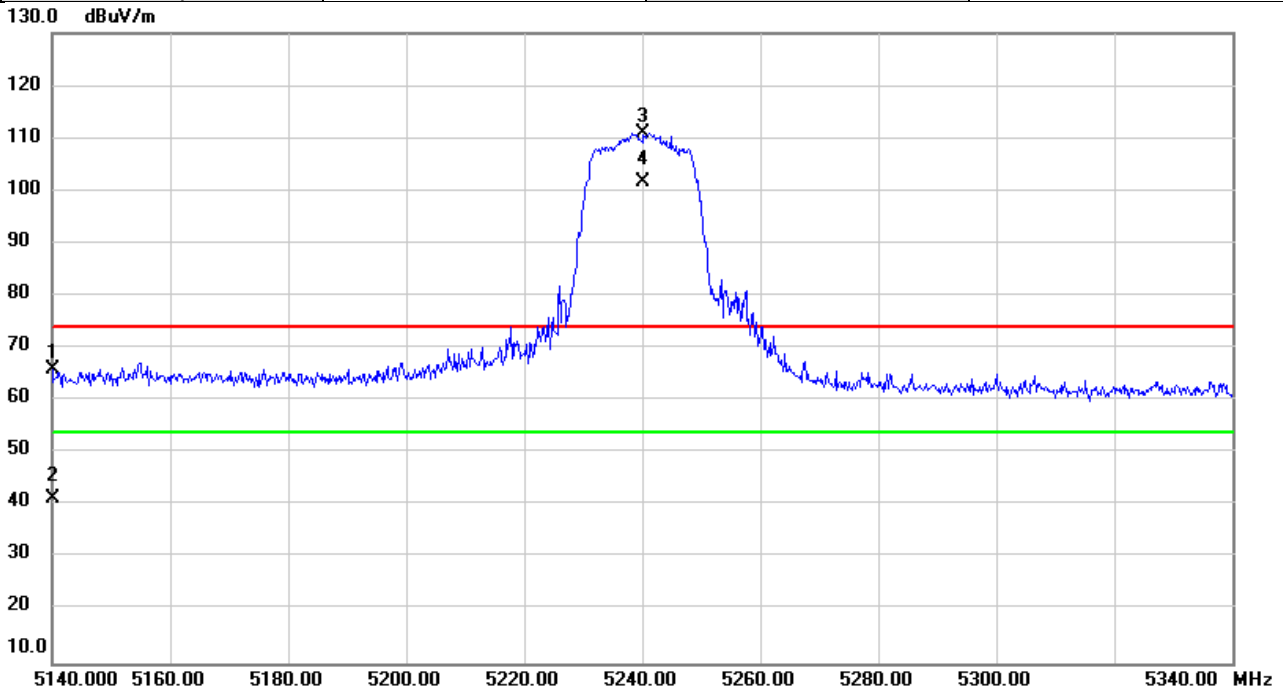

No.	Mk.	Freq.	Reading Level	Correct Factor	Measurement	Limit	Over	Detector	Comment
		MHz	dBuV	dB	dBuV/m	dBuV/m	dB		
1		5140.000	28.70	37.29	65.99	74.00	-8.01	peak	
2		5140.000	4.13	37.29	41.42	54.00	-12.58	AVG	
3	X	5240.000	73.64	37.38	111.02	74.00	37.02	peak	NoLimit
4	*	5240.000	64.23	37.38	101.61	54.00	47.61	AVG	NoLimit

REMARKS:

- (1) Measurement Value = Reading Level + Correct Factor.
- (2) Margin Level = Measurement Value - Limit Value.

Test Mode	IEEE802.11n (HT20)	Test Date	2021/3/6
Test Frequency	5260MHz	Polarization	Vertical
Temp	22°C	Hum.	66%

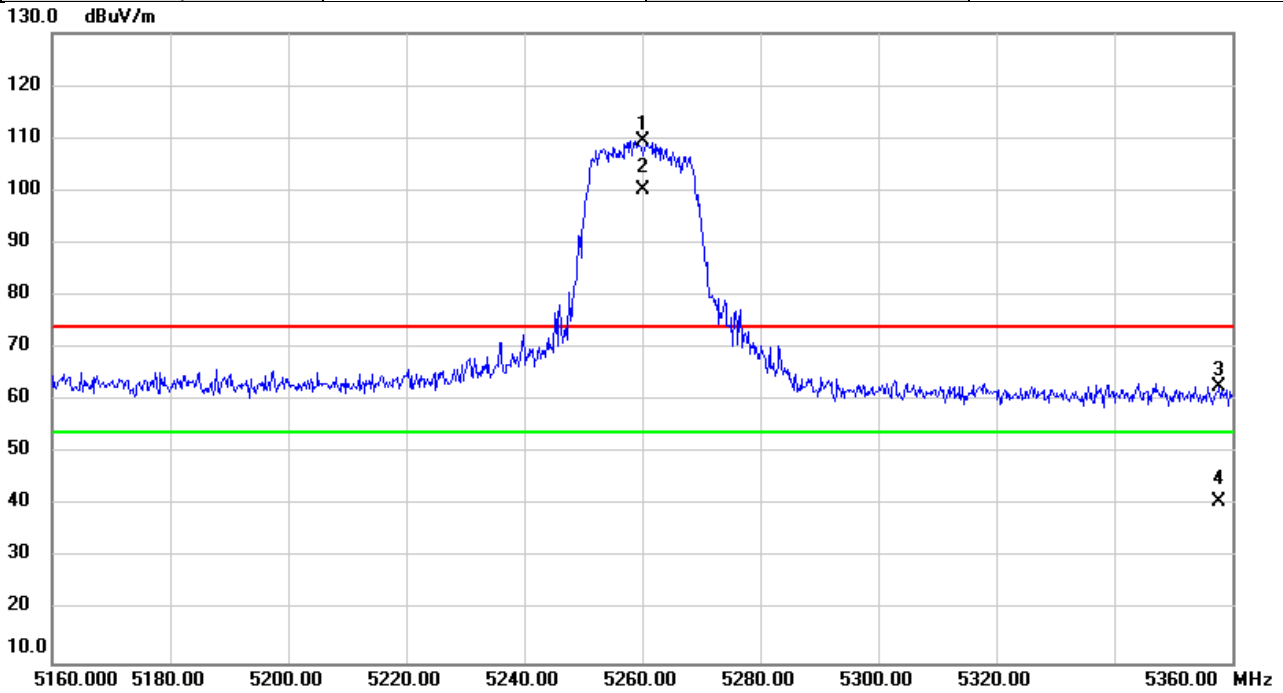

No.	Mk.	Freq.	Reading Level	Correct Factor	Measurement	Limit	Over	Detector	Comment
		MHz	dBuV	dB	dBuV/m	dBuV/m	dB		
1	X	5260.000	71.99	37.40	109.39	74.00	35.39	peak	NoLimit
2	*	5260.000	62.80	37.40	100.20	54.00	46.20	AVG	NoLimit
3		5357.800	25.14	37.48	62.62	74.00	-11.38	peak	
4		5357.800	3.20	37.48	40.68	54.00	-13.32	AVG	

REMARKS:

- (1) Measurement Value = Reading Level + Correct Factor.
- (2) Margin Level = Measurement Value - Limit Value.

Test Mode	IEEE802.11n (HT20)	Test Date	2021/3/6
Test Frequency	5320MHz	Polarization	Vertical
Temp	22°C	Hum.	66%

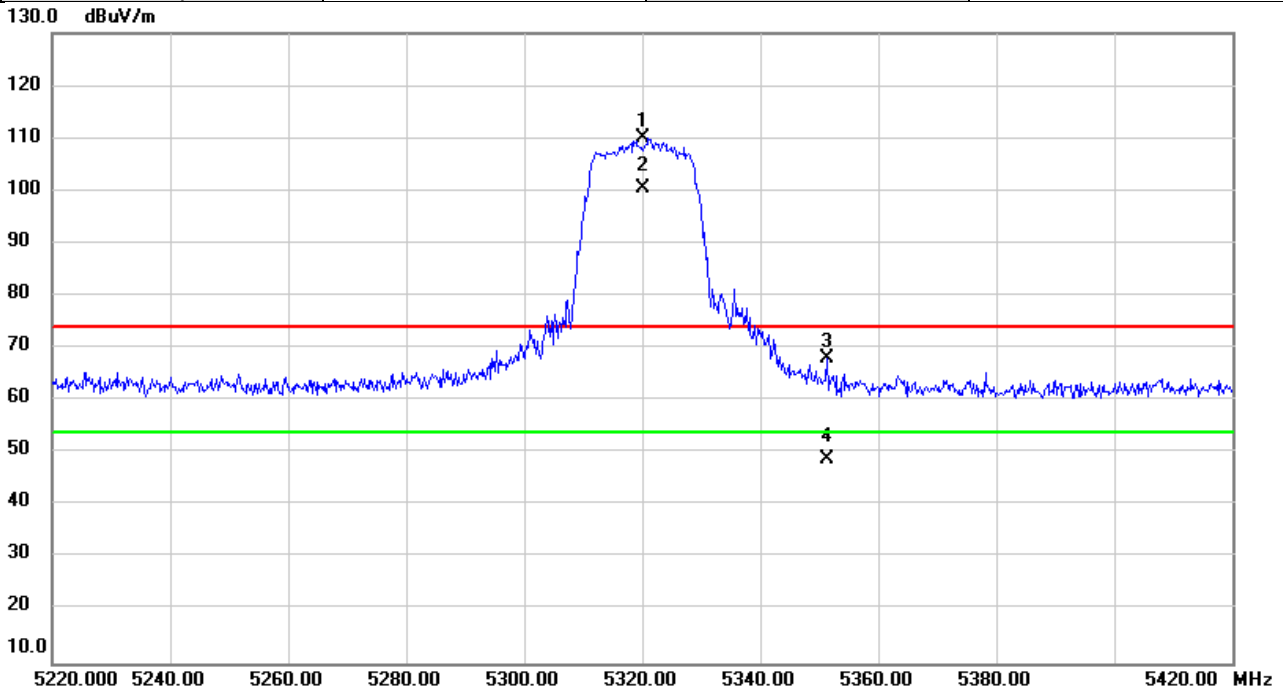

No.	Mk.	Freq.	Reading Level	Correct Factor	Measurement	Limit	Over	Detector	Comment
		MHz	dBuV	dB	dBuV/m	dBuV/m	dB		
1	X	5320.000	72.56	37.45	110.01	74.00	36.01	peak	NoLimit
2	*	5320.000	62.87	37.45	100.32	54.00	46.32	AVG	NoLimit
3		5351.400	30.56	37.48	68.04	74.00	-5.96	peak	
4		5351.400	11.27	37.48	48.75	54.00	-5.25	AVG	

REMARKS:

- (1) Measurement Value = Reading Level + Correct Factor.
- (2) Margin Level = Measurement Value - Limit Value.

Test Mode	IEEE802.11n (HT20)	Test Date	2021/3/6
Test Frequency	5500MHz	Polarization	Vertical
Temp	22°C	Hum.	66%

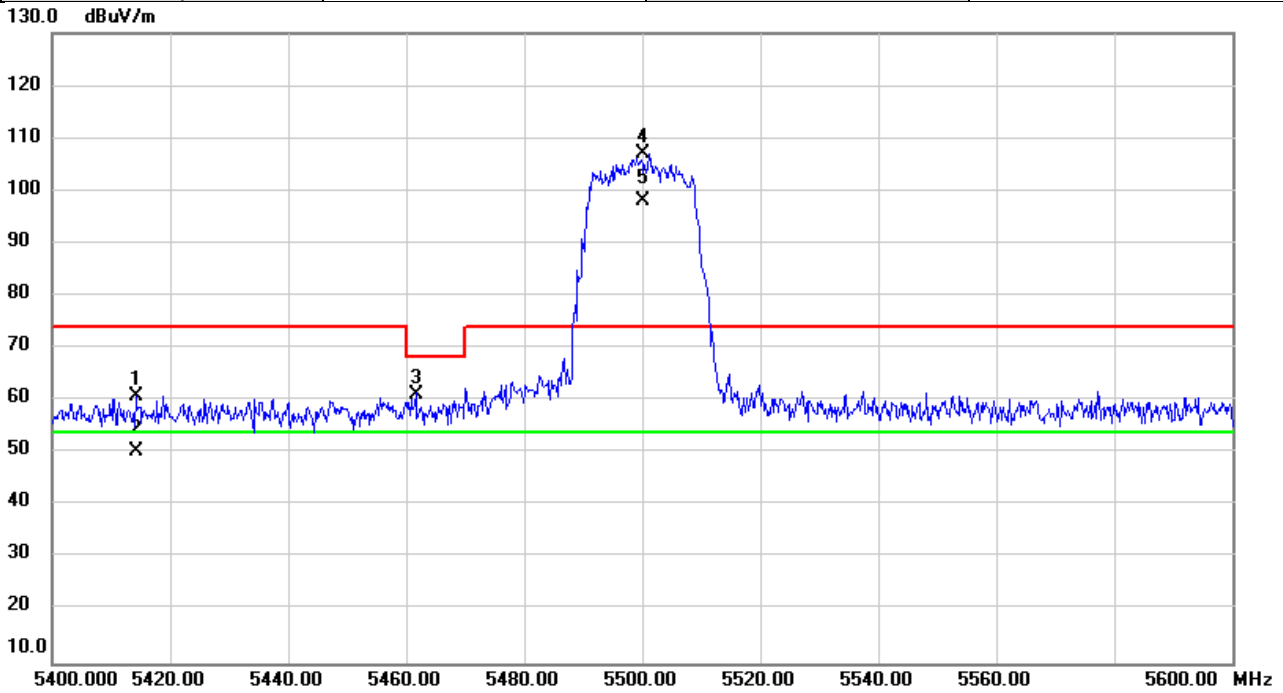

No.	Mk.	Freq.	Reading Level	Correct Factor	Measurement	Limit	Over	Detector	Comment
		MHz	dBuV	dB	dBuV/m	dBuV/m	dB		
1		5414.200	23.34	37.54	60.88	74.00	-13.12	peak	
2		5414.200	12.82	37.54	50.36	54.00	-3.64	AVG	
3		5461.600	23.72	37.58	61.30	68.20	-6.90	peak	
4	X	5500.000	69.42	37.61	107.03	74.00	33.03	peak	NoLimit
5	*	5500.000	60.58	37.61	98.19	54.00	44.19	AVG	NoLimit

REMARKS:

- (1) Measurement Value = Reading Level + Correct Factor.
- (2) Margin Level = Measurement Value - Limit Value.

Test Mode	IEEE802.11n (HT20)	Test Date	2021/3/6
Test Frequency	5700MHz	Polarization	Vertical
Temp	22°C	Hum.	66%

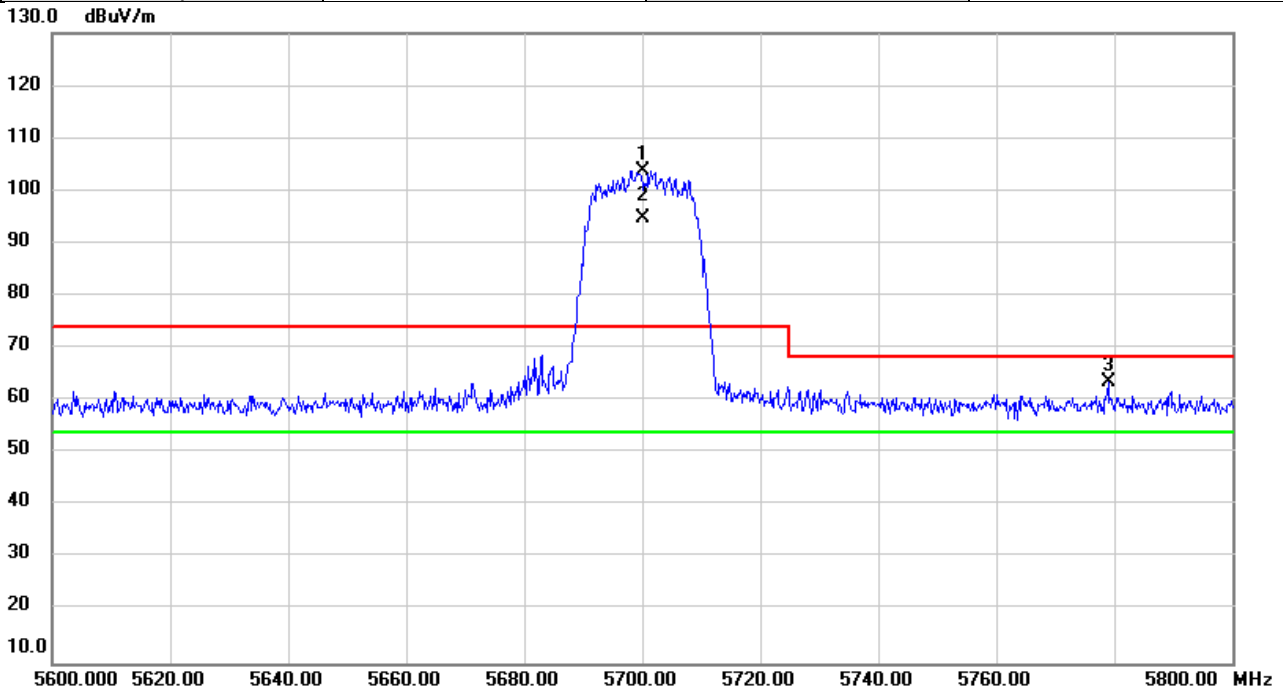

No.	Mk.	Freq.	Reading Level	Correct Factor	Measurement	Limit	Over	Detector	Comment
		MHz	dBuV	dB	dBuV/m	dBuV/m	dB		
1	X	5700.000	65.84	38.04	103.88	74.00	29.88	peak	NoLimit
2	*	5700.000	56.83	38.04	94.87	54.00	40.87	AVG	NoLimit
3		5779.000	25.46	38.20	63.66	68.20	-4.54	peak	

REMARKS:

- (1) Measurement Value = Reading Level + Correct Factor.
- (2) Margin Level = Measurement Value - Limit Value.

Test Mode	IEEE802.11n (HT20)	Test Date	2021/3/6
Test Frequency	5745MHz	Polarization	Vertical
Temp	22°C	Hum.	66%

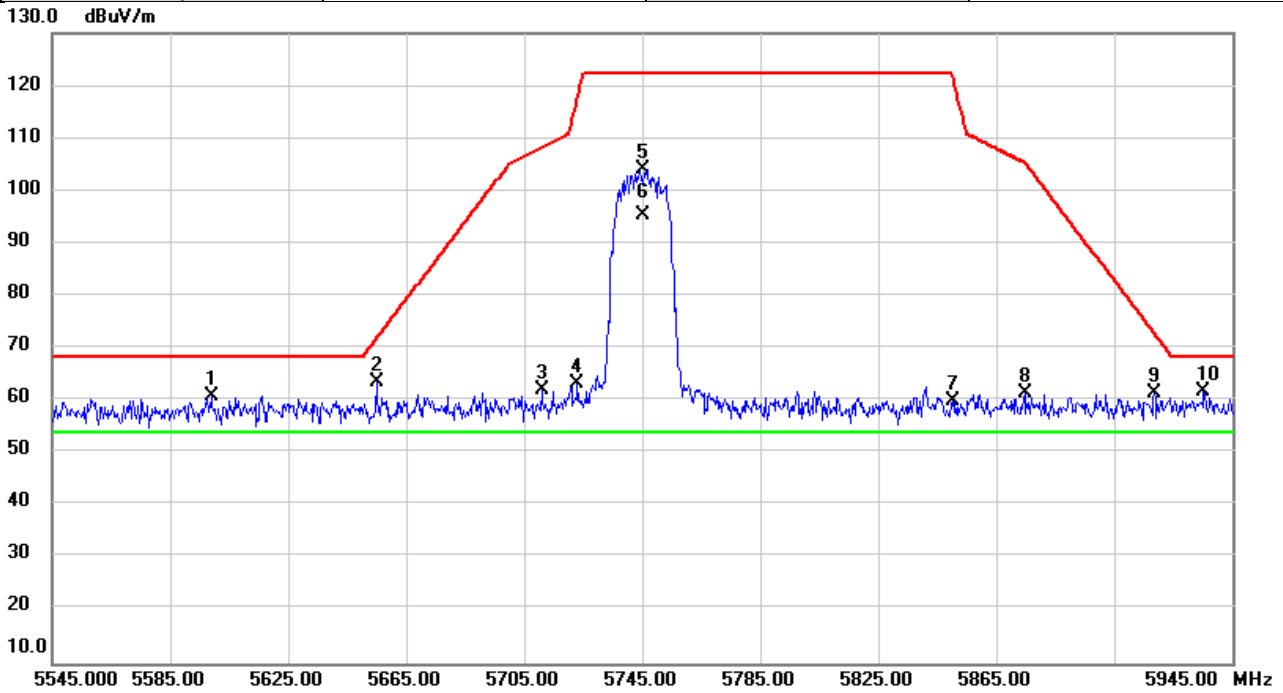

No.	Mk.	Freq.	Reading Level	Correct Factor	Measurement	Limit	Over	Detector	Comment
		MHz	dBuV	dB	dBuV/m	dBuV/m	dB		
1		5599.000	23.10	37.82	60.92	68.20	-7.28	peak	
2		5655.000	25.56	37.95	63.51	71.91	-8.40	peak	
3		5711.000	23.96	38.06	62.02	108.28	-46.26	peak	
4		5723.000	25.16	38.09	63.25	117.64	-54.39	peak	
5		5745.000	65.82	38.13	103.95	122.20	-18.25	peak	NoLimit
6	*	5745.000	57.25	38.13	95.38	54.00	41.38	AVG	NoLimit
7		5850.200	21.47	38.36	59.83	121.74	-61.91	peak	
8		5874.600	23.18	38.41	61.59	105.31	-43.72	peak	
9		5918.600	22.84	38.50	61.34	72.92	-11.58	peak	
10		5935.400	23.25	38.54	61.79	68.20	-6.41	peak	

REMARKS:

- (1) Measurement Value = Reading Level + Correct Factor.
- (2) Margin Level = Measurement Value - Limit Value.

Test Mode	IEEE802.11n (HT20)	Test Date	2021/3/6
Test Frequency	5825MHz	Polarization	Vertical
Temp	22°C	Hum.	66%

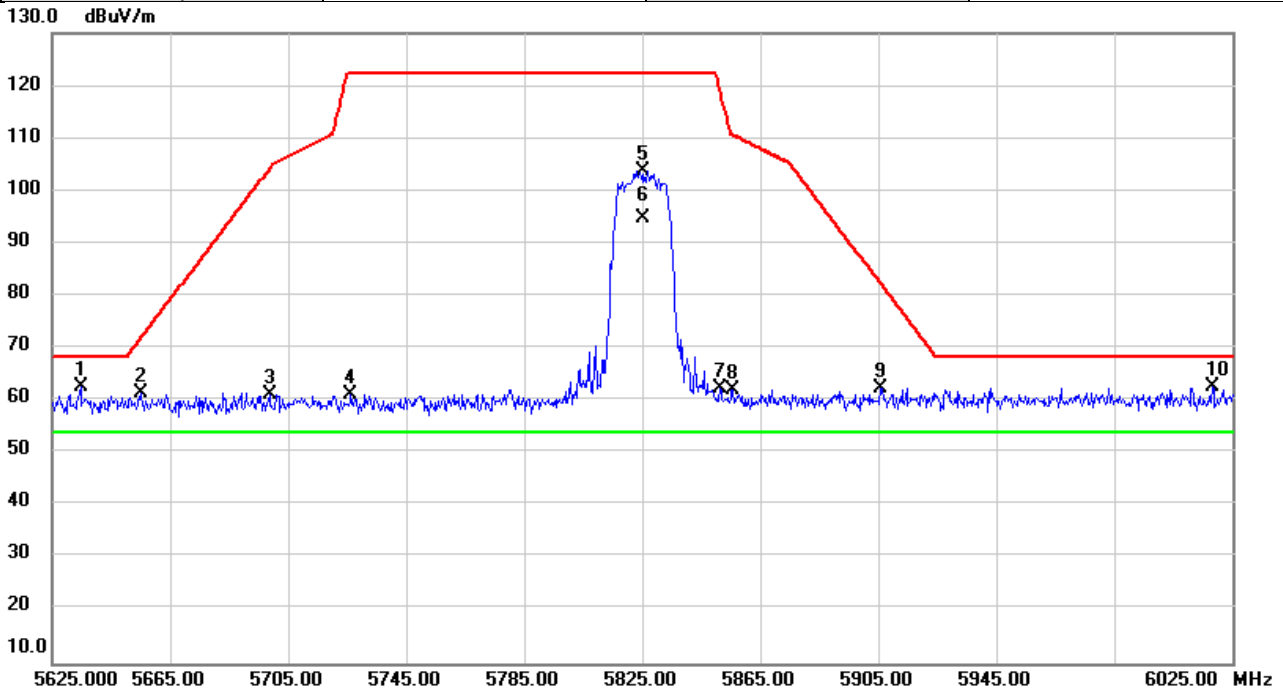

No.	Mk.	Freq. MHz	Reading Level dBuV	Correct Factor dB	Measure- ment dBuV/m	Limit dBuV/m	Over dB	Detector	Comment
1		5634.600	24.65	37.90	62.55	68.20	-5.65	peak	
2		5655.000	23.61	37.95	61.56	71.91	-10.35	peak	
3		5698.600	23.00	38.04	61.04	104.17	-43.13	peak	
4		5726.200	22.97	38.09	61.06	122.20	-61.14	peak	
5		5825.000	65.54	38.31	103.85	122.20	-18.35	peak	NoLimit
6	*	5825.000	56.34	38.31	94.65	54.00	40.65	AVG	NoLimit
7		5851.400	24.03	38.36	62.39	119.01	-56.62	peak	
8		5855.800	23.77	38.37	62.14	110.58	-48.44	peak	
9		5905.800	23.91	38.48	62.39	82.37	-19.98	peak	
10		6018.200	23.86	38.76	62.62	68.20	-5.58	peak	

REMARKS:

- (1) Measurement Value = Reading Level + Correct Factor.
- (2) Margin Level = Measurement Value - Limit Value.

Test Mode	IEEE802.11n (HT40)	Test Date	2021/3/6
Test Frequency	5190MHz	Polarization	Vertical
Temp	22°C	Hum.	66%

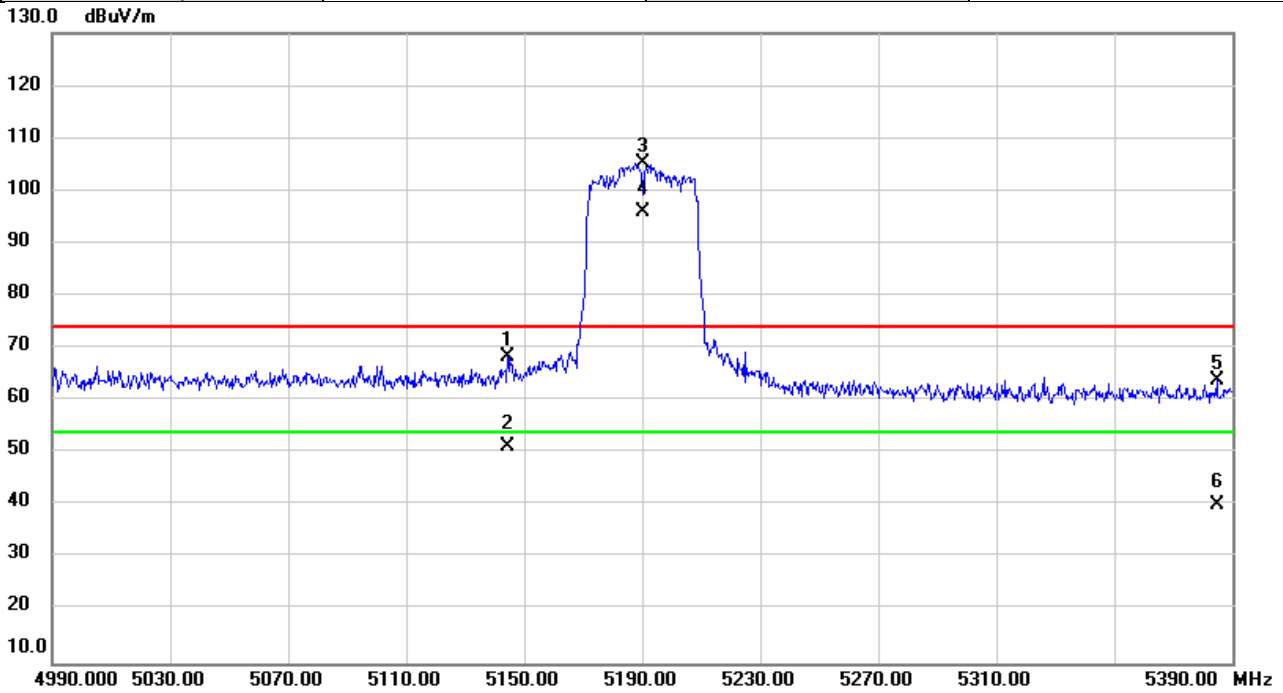

No.	Mk.	Freq.	Reading Level	Correct Factor	Measurement	Limit	Over	Detector	Comment
		MHz	dBuV	dB	dBuV/m	dBuV/m	dB		
1		5144.400	31.01	37.30	68.31	74.00	-5.69	peak	
2		5144.400	14.08	37.30	51.38	54.00	-2.62	AVG	
3	X	5190.000	67.85	37.33	105.18	74.00	31.18	peak	NoLimit
4	*	5190.000	58.75	37.33	96.08	54.00	42.08	AVG	NoLimit
5		5384.800	26.39	37.51	63.90	74.00	-10.10	peak	
6		5384.800	2.69	37.51	40.20	54.00	-13.80	AVG	

REMARKS:

- (1) Measurement Value = Reading Level + Correct Factor.
- (2) Margin Level = Measurement Value - Limit Value.

Test Mode	IEEE802.11n (HT40)	Test Date	2021/3/6
Test Frequency	5230MHz	Polarization	Vertical
Temp	22°C	Hum.	66%

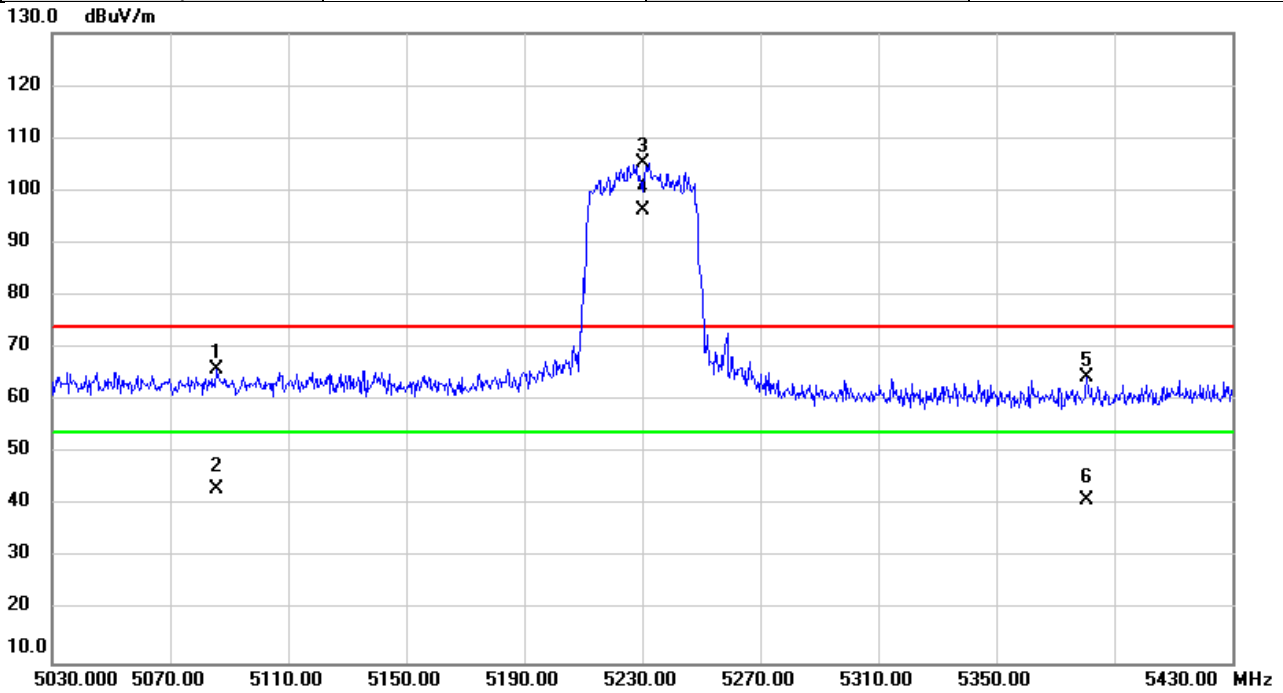

No.	Mk.	Freq.	Reading Level	Correct Factor	Measurement	Limit	Over	Detector	Comment
		MHz	dBuV	dB	dBuV/m	dBuV/m	dB		
1		5085.600	28.62	37.24	65.86	74.00	-8.14	peak	
2		5085.600	5.98	37.24	43.22	54.00	-10.78	AVG	
3	X	5230.000	67.93	37.37	105.30	74.00	31.30	peak	NoLimit
4	*	5230.000	58.97	37.37	96.34	54.00	42.34	AVG	NoLimit
5		5380.800	26.83	37.51	64.34	74.00	-9.66	peak	
6		5380.800	3.43	37.51	40.94	54.00	-13.06	AVG	

REMARKS:

- (1) Measurement Value = Reading Level + Correct Factor.
- (2) Margin Level = Measurement Value - Limit Value.

Test Mode	IEEE802.11n (HT40)	Test Date	2021/3/6
Test Frequency	5270MHz	Polarization	Vertical
Temp	22°C	Hum.	66%

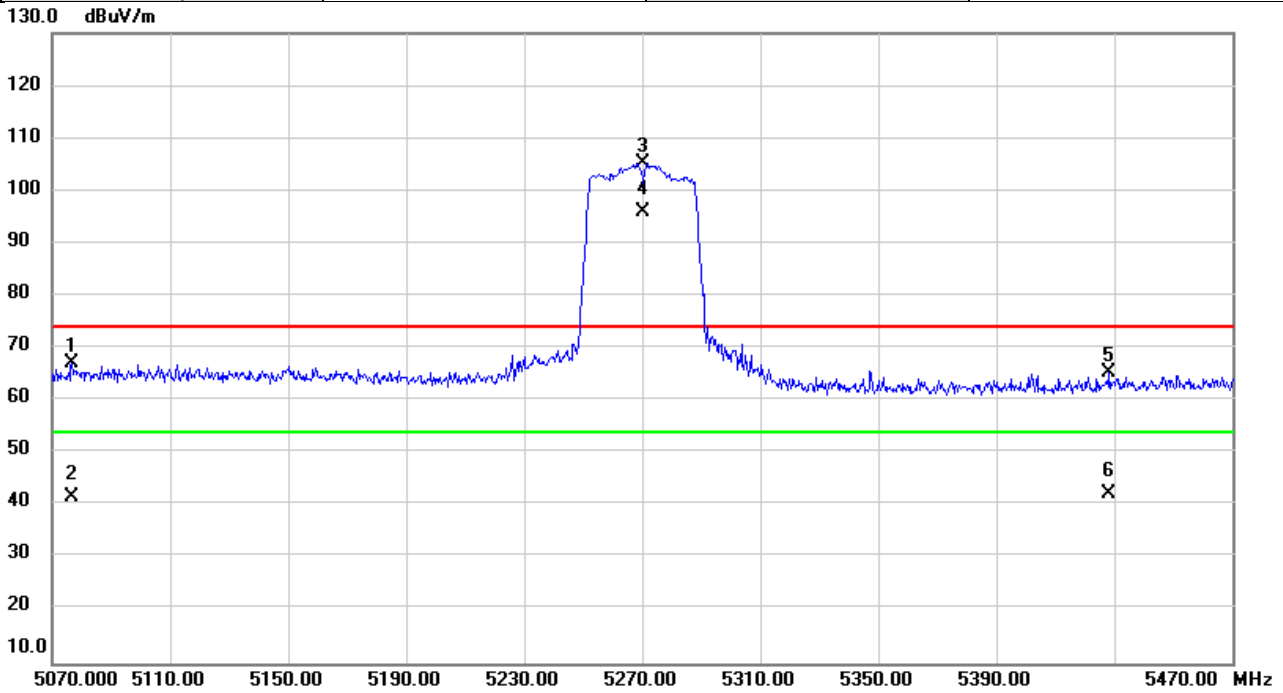

No.	Mk.	Freq.	Reading Level	Correct Factor	Measurement	Limit	Over	Detector	Comment
		MHz	dBuV	dB	dBuV/m	dBuV/m	dB		
1		5076.800	30.05	37.24	67.29	74.00	-6.71	peak	
2		5076.800	4.36	37.24	41.60	54.00	-12.40	AVG	
3	X	5270.000	67.79	37.41	105.20	74.00	31.20	peak	NoLimit
4	*	5270.000	58.54	37.41	95.95	54.00	41.95	AVG	NoLimit
5		5428.400	27.79	37.55	65.34	74.00	-8.66	peak	
6		5428.400	4.55	37.55	42.10	54.00	-11.90	AVG	

REMARKS:

- (1) Measurement Value = Reading Level + Correct Factor.
- (2) Margin Level = Measurement Value - Limit Value.

Test Mode	IEEE802.11n (HT40)	Test Date	2021/3/6
Test Frequency	5310MHz	Polarization	Vertical
Temp	22°C	Hum.	66%

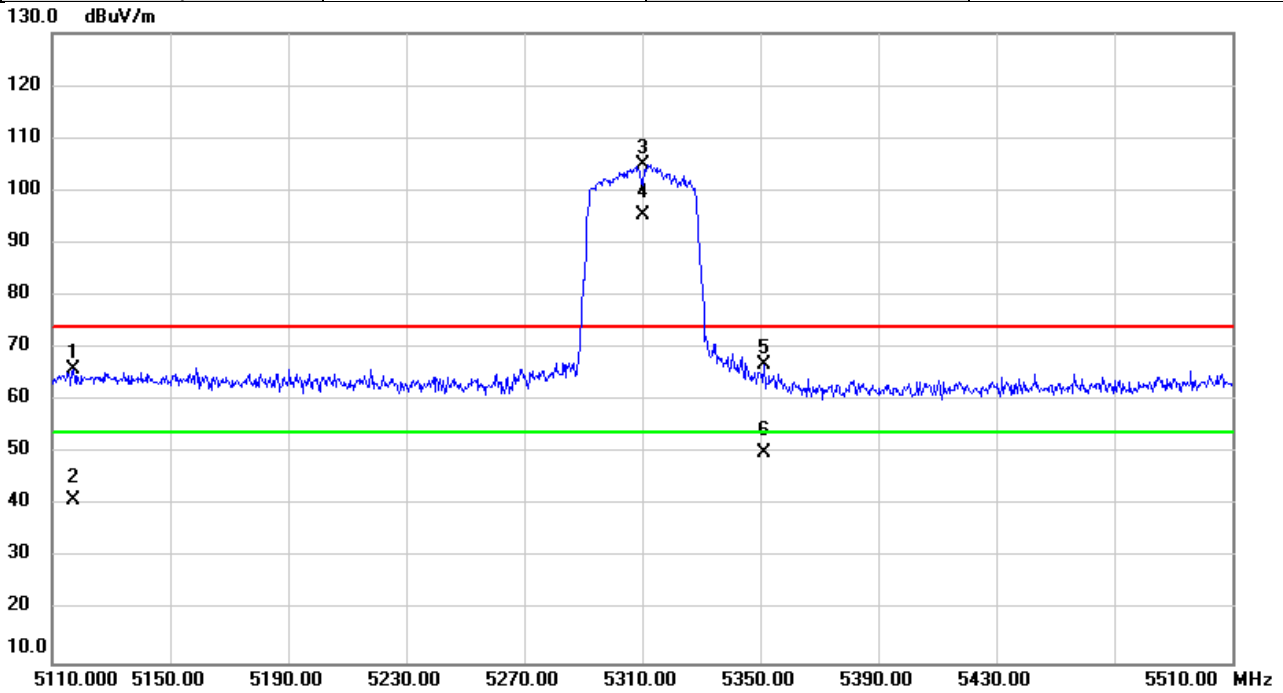

No.	Mk.	Freq.	Reading Level	Correct Factor	Measurement	Limit	Over	Detector	Comment
		MHz	dBuV	dB	dBuV/m	dBuV/m	dB		
1		5117.200	28.77	37.27	66.04	74.00	-7.96	peak	
2		5117.200	3.87	37.27	41.14	54.00	-12.86	AVG	
3	X	5310.000	67.58	37.45	105.03	74.00	31.03	peak	NoLimit
4	*	5310.000	57.86	37.45	95.31	54.00	41.31	AVG	NoLimit
5		5351.200	29.31	37.48	66.79	74.00	-7.21	peak	
6		5351.200	12.51	37.48	49.99	54.00	-4.01	AVG	

REMARKS:

- (1) Measurement Value = Reading Level + Correct Factor.
- (2) Margin Level = Measurement Value - Limit Value.

Test Mode	IEEE802.11n (HT40)	Test Date	2021/3/6
Test Frequency	5510MHz	Polarization	Vertical
Temp	22°C	Hum.	66%

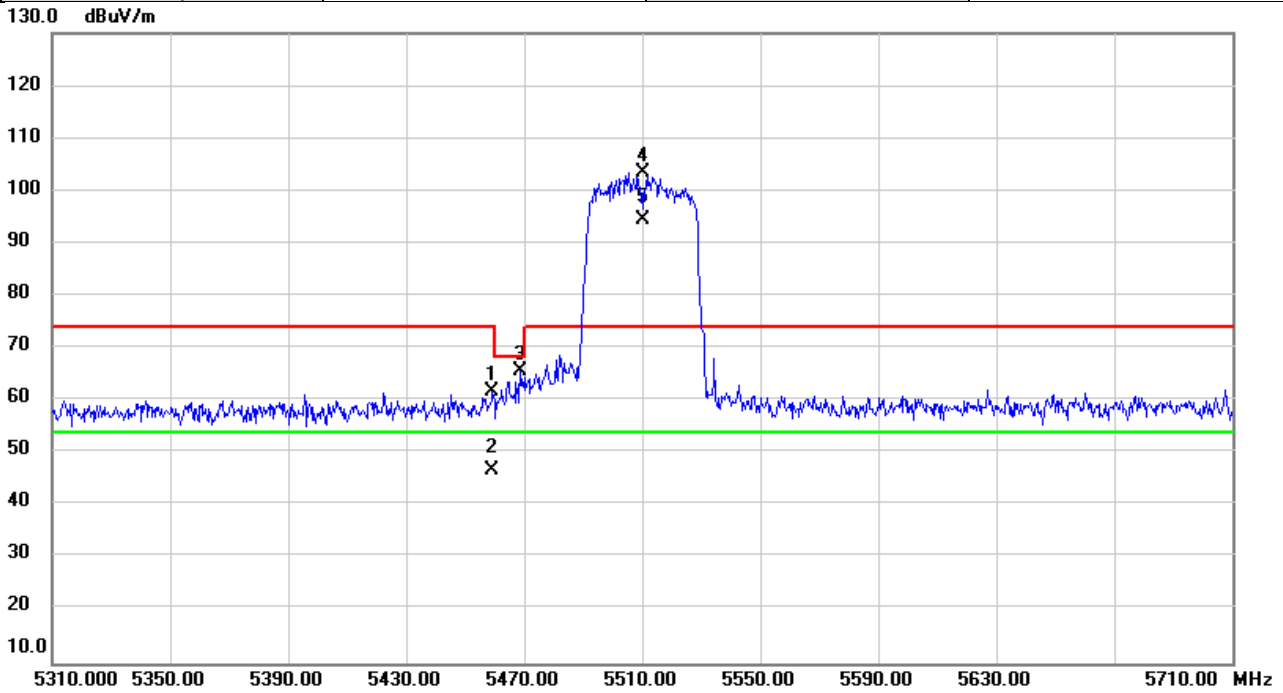

No.	Mk.	Freq.	Reading Level	Correct Factor	Measurement	Limit	Over	Detector	Comment
		MHz	dBuV	dB	dBuV/m	dBuV/m	dB		
1		5459.200	24.06	37.58	61.64	74.00	-12.36	peak	
2		5459.200	9.30	37.58	46.88	54.00	-7.12	AVG	
3		5468.800	28.05	37.58	65.63	68.20	-2.57	peak	
4	X	5510.000	65.80	37.63	103.43	74.00	29.43	peak	NoLimit
5	*	5510.000	56.69	37.63	94.32	54.00	40.32	AVG	NoLimit

REMARKS:

- (1) Measurement Value = Reading Level + Correct Factor.
- (2) Margin Level = Measurement Value - Limit Value.

Test Mode	IEEE802.11n (HT40)	Test Date	2021/3/6
Test Frequency	5670MHz	Polarization	Vertical
Temp	22°C	Hum.	66%

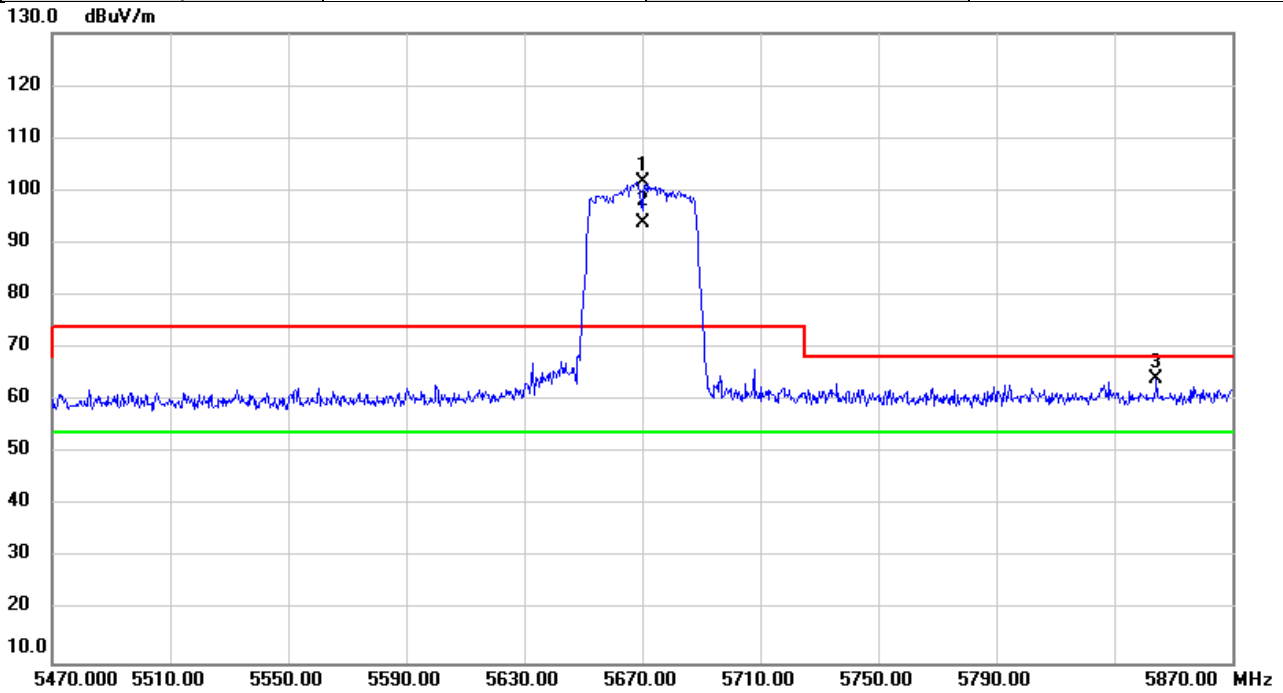

No.	Mk.	Freq.	Reading Level	Correct Factor	Measurement	Limit	Over	Detector	Comment
		MHz	dBuV	dB	dBuV/m	dBuV/m	dB		
1	X	5670.000	63.61	37.97	101.58	74.00	27.58	peak	NoLimit
2	*	5670.000	55.85	37.97	93.82	54.00	39.82	AVG	NoLimit
3		5844.400	25.87	38.34	64.21	68.20	-3.99	peak	

REMARKS:

- (1) Measurement Value = Reading Level + Correct Factor.
- (2) Margin Level = Measurement Value - Limit Value.

Test Mode	IEEE802.11n (HT40)	Test Date	2021/3/6
Test Frequency	5755MHz	Polarization	Vertical
Temp	22°C	Hum.	66%

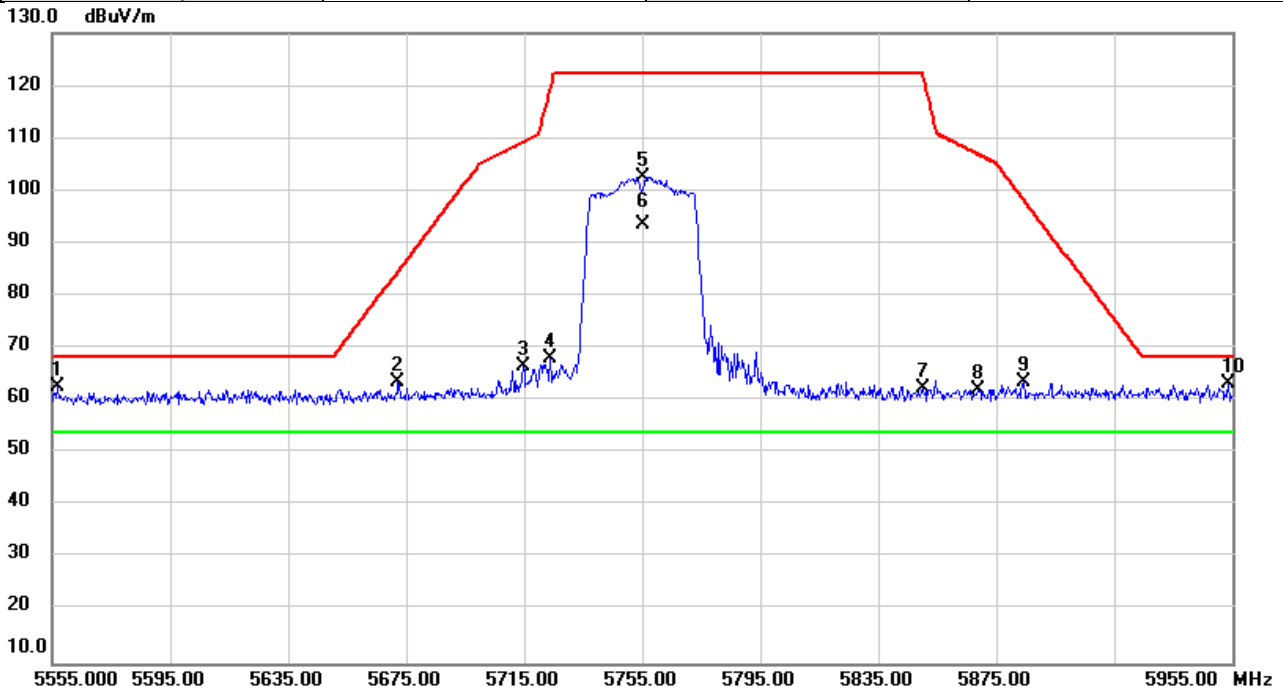

No.	Mk.	Freq. MHz	Reading Level dBuV	Correct Factor dB	Measure- ment dBuV/m	Limit dBuV/m	Over dB	Detector	Comment
1		5556.600	24.82	37.73	62.55	68.20	-5.65	peak	
2		5672.200	25.47	37.98	63.45	84.67	-21.22	peak	
3		5714.600	28.36	38.07	66.43	109.29	-42.86	peak	
4		5723.800	29.81	38.09	67.90	119.46	-51.56	peak	
5		5755.000	64.49	38.16	102.65	122.20	-19.55	peak	NoLimit
6	*	5755.000	55.28	38.16	93.44	54.00	39.44	AVG	NoLimit
7		5850.200	23.84	38.36	62.20	121.74	-59.54	peak	
8		5869.000	23.77	38.40	62.17	106.88	-44.71	peak	
9		5884.200	25.13	38.43	63.56	98.37	-34.81	peak	
10		5953.800	24.80	38.58	63.38	68.20	-4.82	peak	

REMARKS:

- (1) Measurement Value = Reading Level + Correct Factor.
- (2) Margin Level = Measurement Value - Limit Value.

Test Mode	IEEE802.11n (HT40)	Test Date	2021/3/6
Test Frequency	5795MHz	Polarization	Vertical
Temp	22°C	Hum.	66%

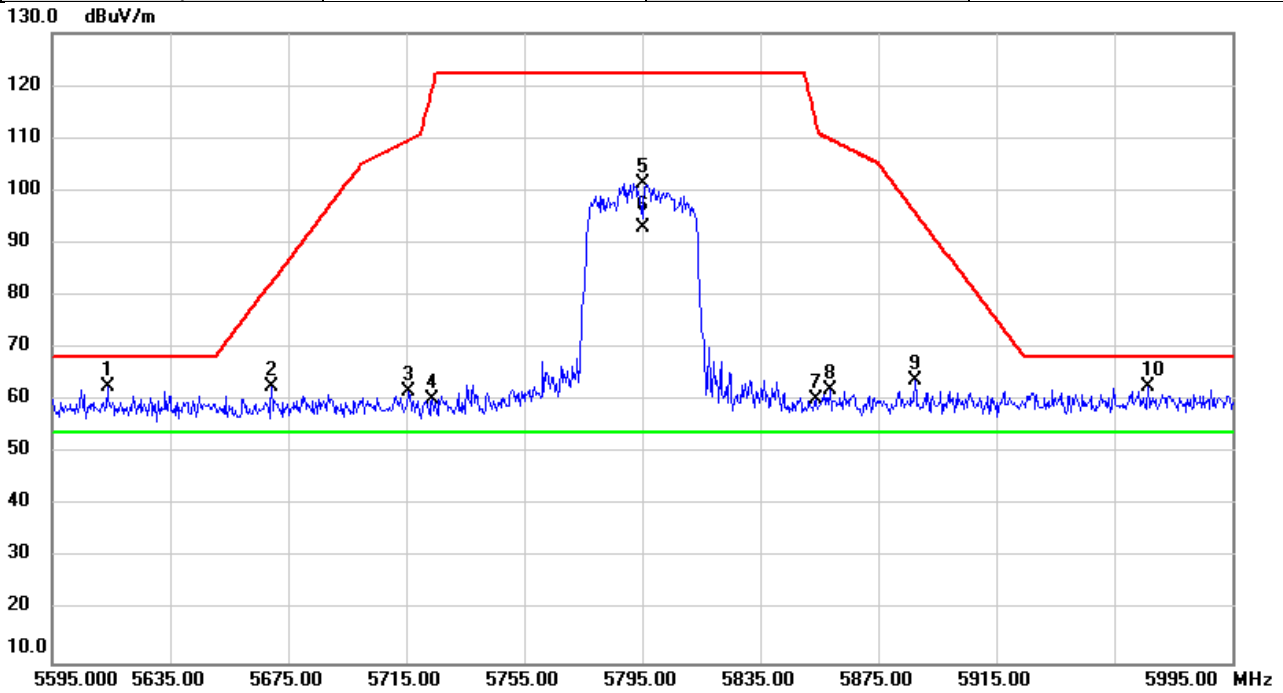

No.	Mk.	Freq.	Reading Level	Correct Factor	Measurement	Limit	Over	Detector	Comment
		MHz	dBuV	dB	dBuV/m	dBuV/m	dB		
1		5613.800	24.83	37.86	62.69	68.20	-5.51	peak	
2		5669.400	24.65	37.97	62.62	82.59	-19.97	peak	
3		5715.800	23.78	38.07	61.85	109.63	-47.78	peak	
4		5723.800	22.27	38.09	60.36	119.46	-59.10	peak	
5		5795.000	63.18	38.24	101.42	122.20	-20.78	peak	NoLimit
6	*	5795.000	54.81	38.24	93.05	54.00	39.05	AVG	NoLimit
7		5853.800	21.90	38.36	60.26	113.54	-53.28	peak	
8		5858.600	23.70	38.38	62.08	109.79	-47.71	peak	
9		5887.400	25.30	38.43	63.73	95.99	-32.26	peak	
10		5966.600	24.10	38.61	62.71	68.20	-5.49	peak	

REMARKS:

- (1) Measurement Value = Reading Level + Correct Factor.
- (2) Margin Level = Measurement Value - Limit Value.

Test Mode	IEEE802.11a	Test Date	2021/3/6
Test Frequency	5180MHz	Polarization	Vertical
Temp	22°C	Hum.	66%

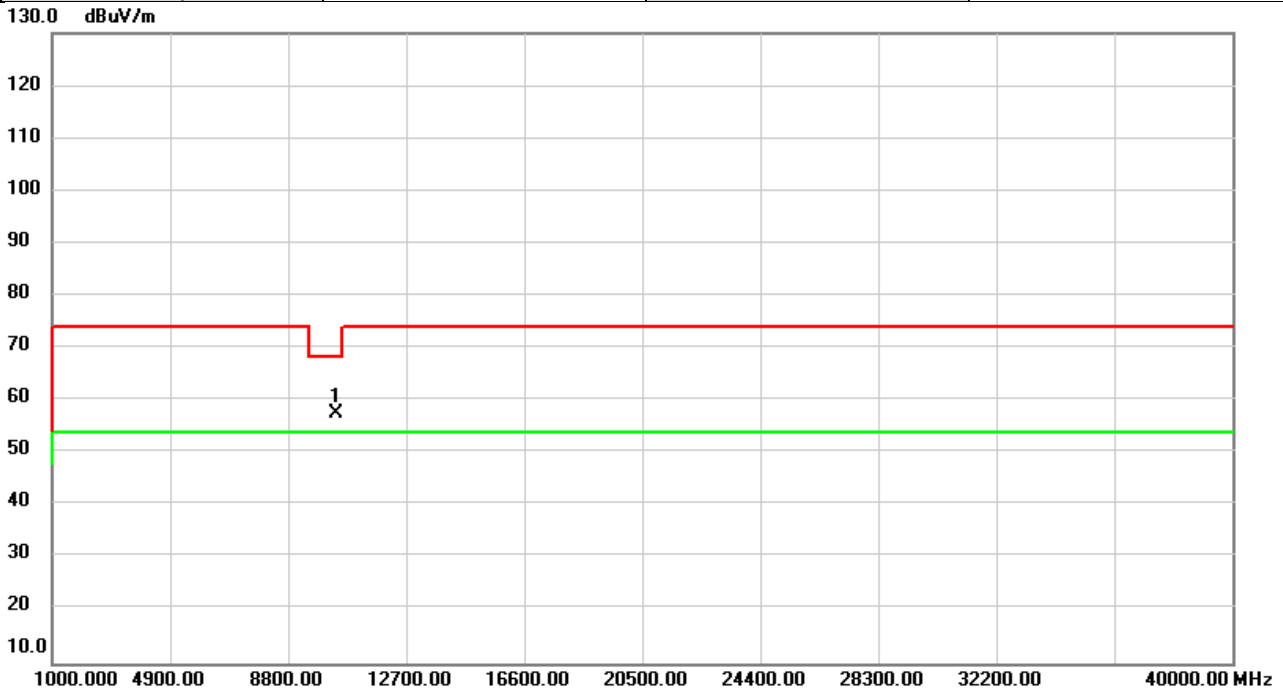

No.	Mk.	Freq.	Reading Level	Correct Factor	Measurement	Limit	Over	Detector	Comment
		MHz	dBuV	dB	dBuV/m	dBuV/m	dB		
1	*	10360.00	52.61	4.85	57.46	68.20	-10.74	peak	

REMARKS:

- (1) Measurement Value = Reading Level + Correct Factor.
- (2) Margin Level = Measurement Value - Limit Value.

Test Mode	IEEE802.11a	Test Date	2021/3/6
Test Frequency	5180MHz	Polarization	Horizontal
Temp	22°C	Hum.	66%

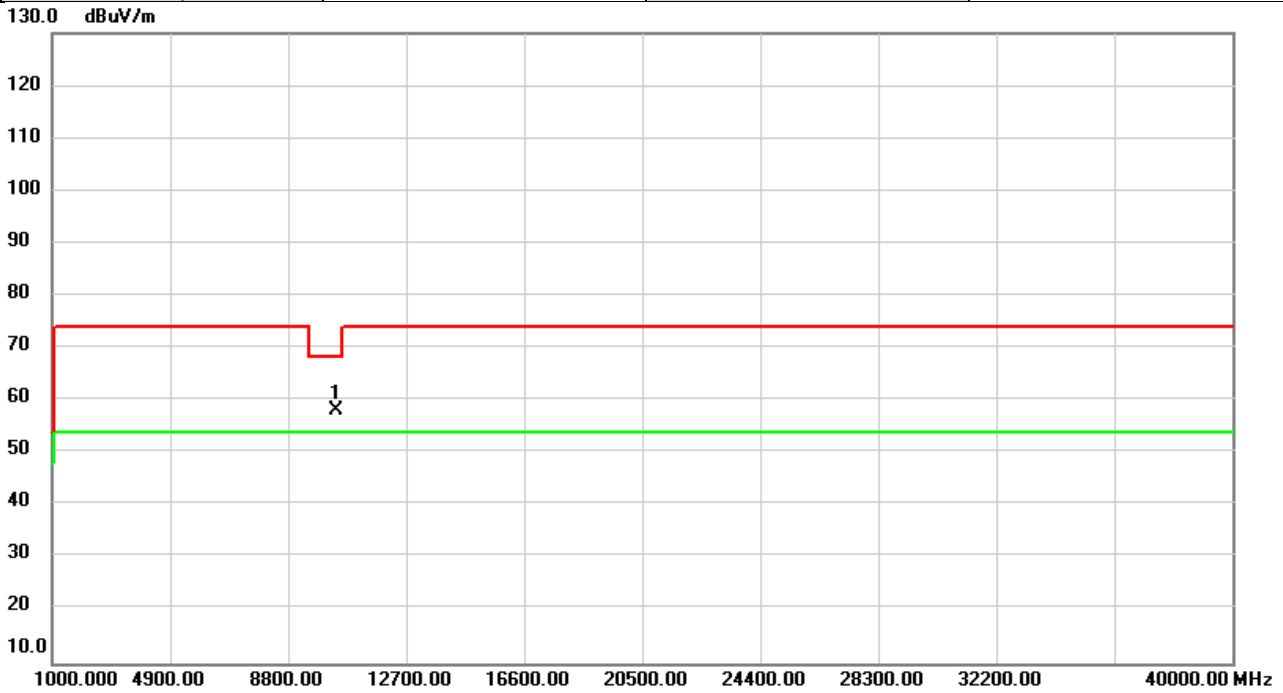

No.	Mk.	Freq.	Reading Level	Correct Factor	Measurement	Limit	Over	Detector	Comment
		MHz	dBuV	dB	dBuV/m	dBuV/m	dB		
1	*	10360.00	53.17	4.85	58.02	68.20	-10.18	peak	

REMARKS:

- (1) Measurement Value = Reading Level + Correct Factor.
- (2) Margin Level = Measurement Value - Limit Value.

Test Mode	IEEE802.11a	Test Date	2021/3/6
Test Frequency	5200MHz	Polarization	Vertical
Temp	22°C	Hum.	66%

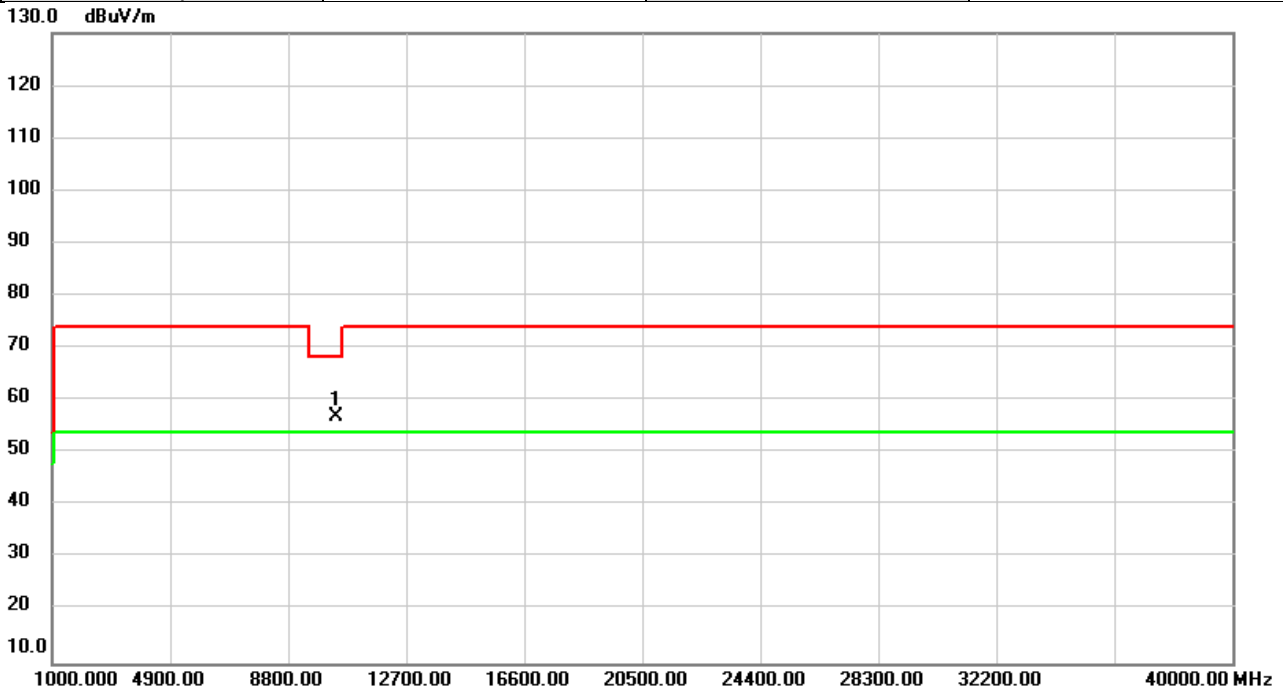

No.	Mk.	Freq.	Reading Level	Correct Factor	Measurement	Limit	Over	Detector	Comment
		MHz	dBuV	dB	dBuV/m	dBuV/m	dB		
1	*	10400.00	52.02	4.94	56.96	68.20	-11.24	peak	

REMARKS:

- (1) Measurement Value = Reading Level + Correct Factor.
- (2) Margin Level = Measurement Value - Limit Value.

Test Mode	IEEE802.11a	Test Date	2021/3/6
Test Frequency	5200MHz	Polarization	Horizontal
Temp	22°C	Hum.	66%

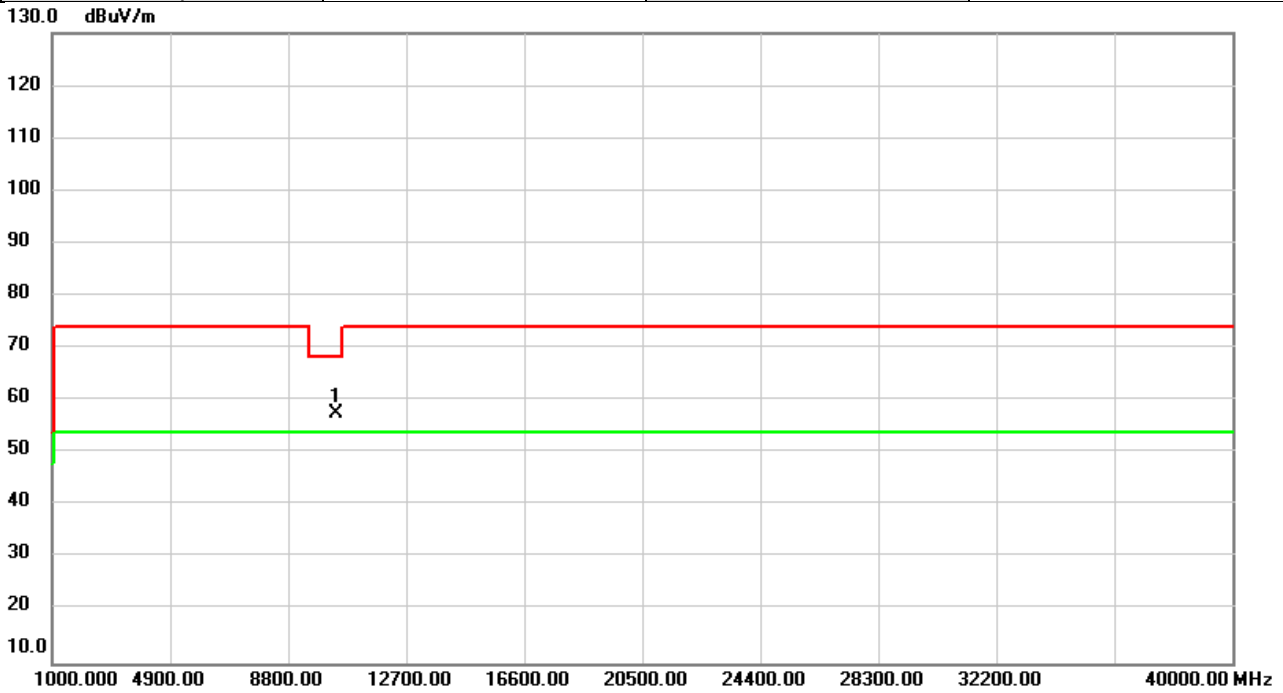

No.	Mk.	Freq.	Reading Level	Correct Factor	Measurement	Limit	Over	Detector	Comment
		MHz	dBuV	dB	dBuV/m	dBuV/m	dB		
1	*	10400.00	52.47	4.94	57.41	68.20	-10.79	peak	

REMARKS:

- (1) Measurement Value = Reading Level + Correct Factor.
- (2) Margin Level = Measurement Value - Limit Value.

Test Mode	IEEE802.11a	Test Date	2021/3/6
Test Frequency	5240MHz	Polarization	Vertical
Temp	22°C	Hum.	66%

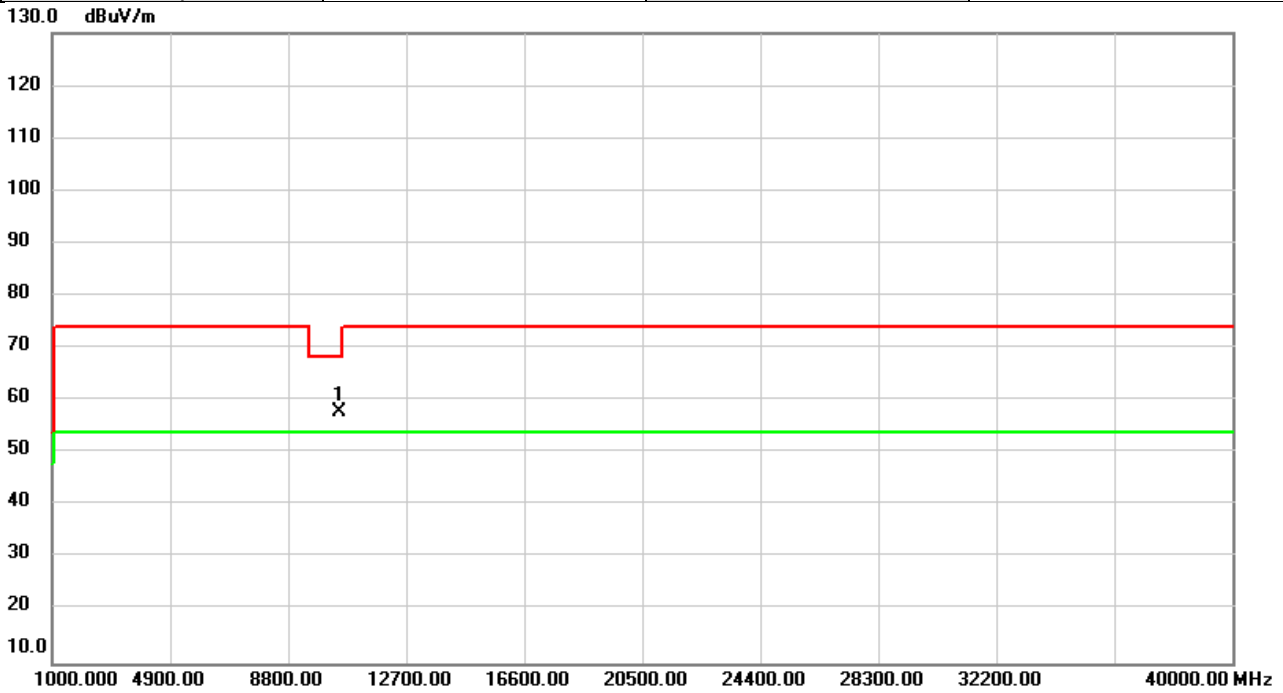

No.	Mk.	Freq.	Reading Level	Correct Factor	Measurement	Limit	Over	Detector	Comment
		MHz	dBuV	dB	dBuV/m	dBuV/m	dB		
1	*	10480.00	52.65	5.15	57.80	68.20	-10.40	peak	

REMARKS:

- (1) Measurement Value = Reading Level + Correct Factor.
- (2) Margin Level = Measurement Value - Limit Value.

Test Mode	IEEE802.11a	Test Date	2021/3/6
Test Frequency	5240MHz	Polarization	Horizontal
Temp	22°C	Hum.	66%

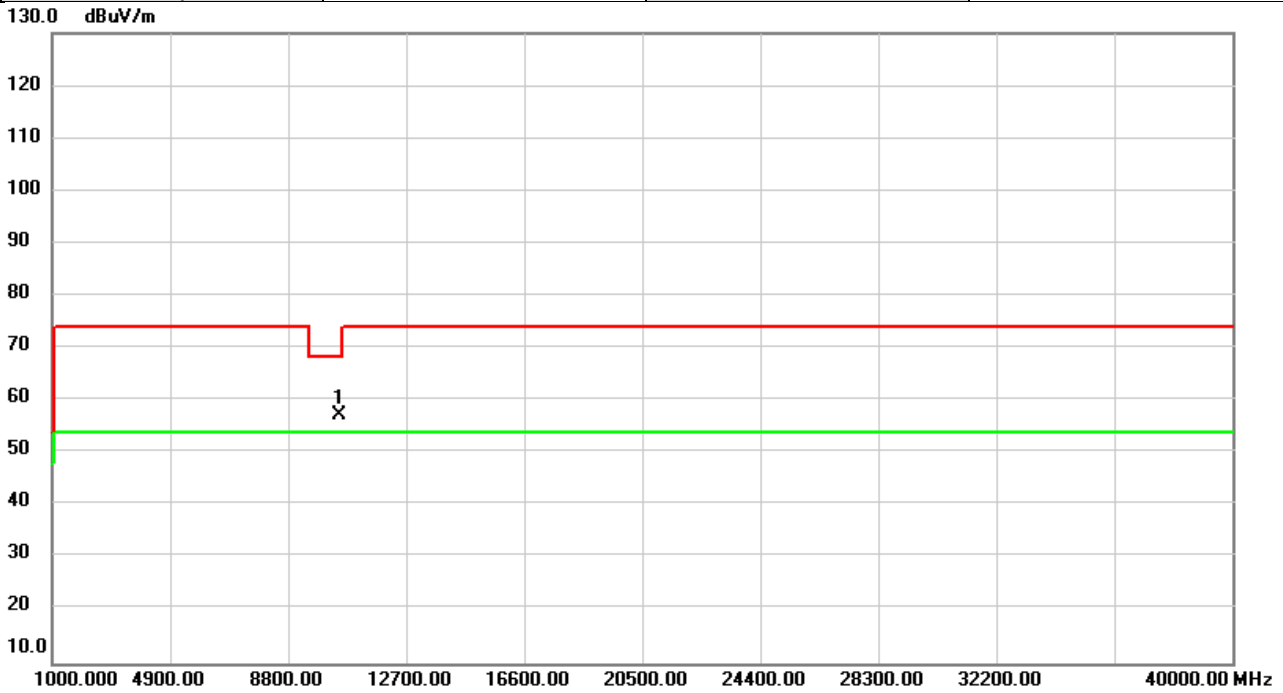

No.	Mk.	Freq.	Reading Level	Correct Factor	Measurement	Limit	Over	Detector	Comment
		MHz	dBuV	dB	dBuV/m	dBuV/m	dB		
1	*	10480.00	52.07	5.15	57.22	68.20	-10.98	peak	

REMARKS:

- (1) Measurement Value = Reading Level + Correct Factor.
- (2) Margin Level = Measurement Value - Limit Value.

Test Mode	IEEE802.11a	Test Date	2021/3/6
Test Frequency	5260MHz	Polarization	Vertical
Temp	22°C	Hum.	66%

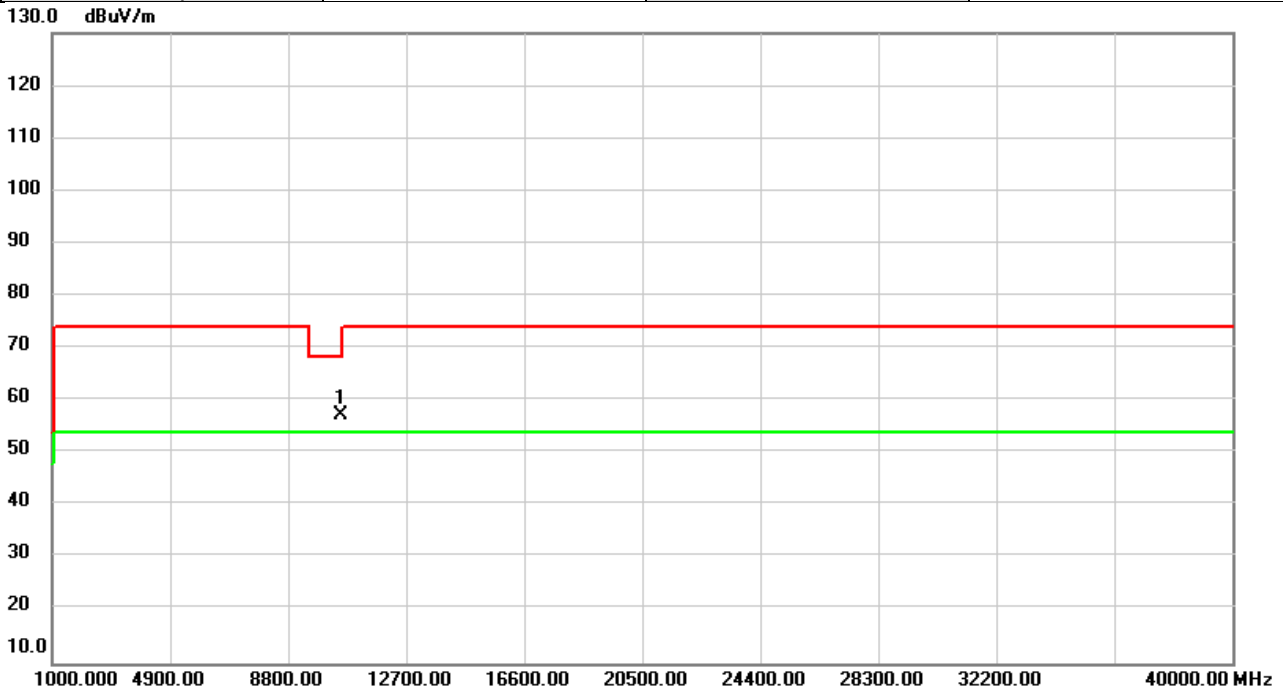

No.	Mk.	Freq.	Reading Level	Correct Factor	Measurement	Limit	Over	Detector	Comment
		MHz	dBuV	dB	dBuV/m	dBuV/m	dB		
1	*	10520.00	51.97	5.24	57.21	68.20	-10.99	peak	

REMARKS:

- (1) Measurement Value = Reading Level + Correct Factor.
- (2) Margin Level = Measurement Value - Limit Value.

Test Mode	IEEE802.11a	Test Date	2021/3/6
Test Frequency	5260MHz	Polarization	Horizontal
Temp	22°C	Hum.	66%

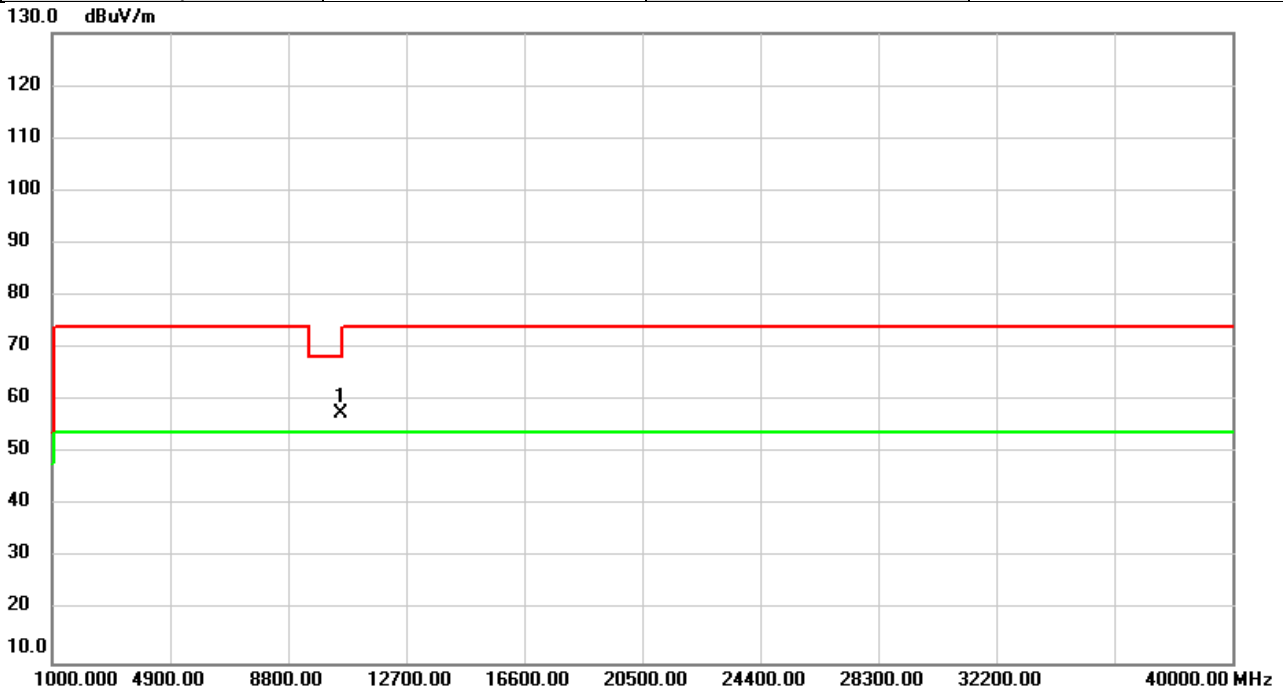

No.	Mk.	Freq.	Reading Level	Correct Factor	Measurement	Limit	Over	Detector	Comment
		MHz	dBuV	dB	dBuV/m	dBuV/m	dB		
1	*	10520.00	52.34	5.24	57.58	68.20	-10.62	peak	

REMARKS:

- (1) Measurement Value = Reading Level + Correct Factor.
- (2) Margin Level = Measurement Value - Limit Value.

Test Mode	IEEE802.11a	Test Date	2021/3/6
Test Frequency	5300MHz	Polarization	Vertical
Temp	22°C	Hum.	66%

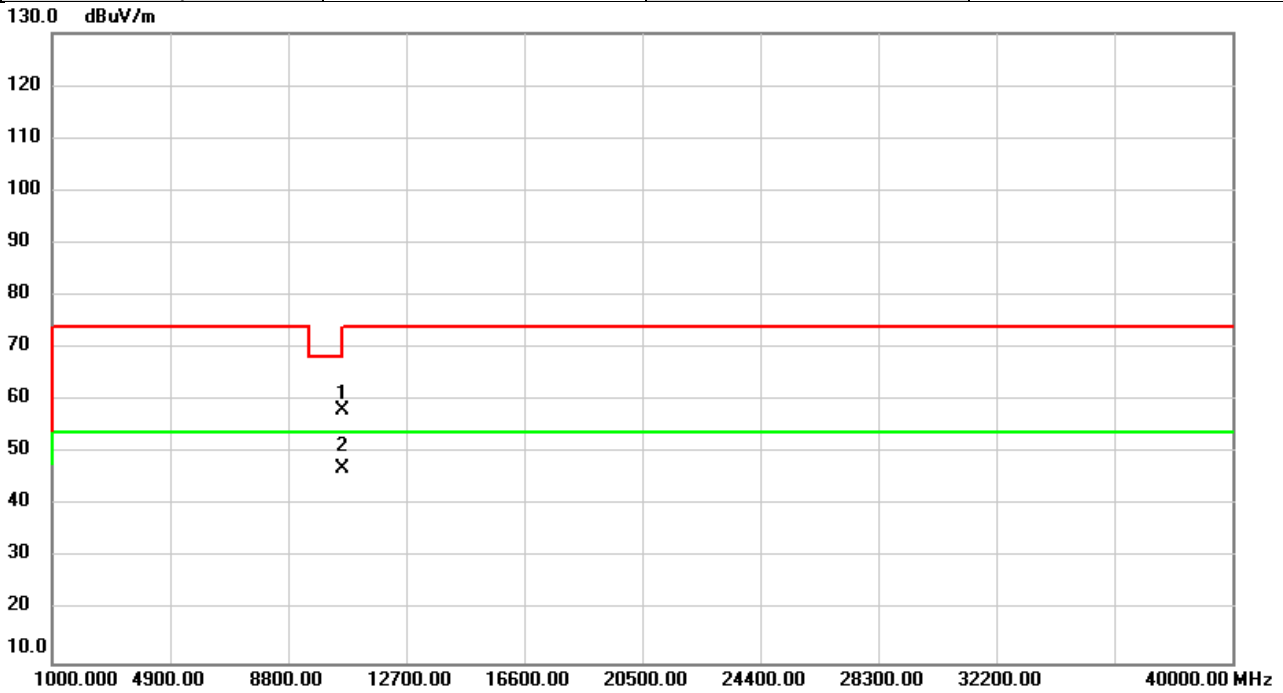

No.	Mk.	Freq.	Reading Level	Correct Factor	Measurement	Limit	Over	Detector	Comment
		MHz	dBuV	dB	dBuV/m	dBuV/m	dB		
1		10600.00	52.86	5.41	58.27	68.20	-9.93	peak	
2	*	10600.00	41.56	5.41	46.97	54.00	-7.03	AVG	

REMARKS:

- (1) Measurement Value = Reading Level + Correct Factor.
- (2) Margin Level = Measurement Value - Limit Value.

Test Mode	IEEE802.11a	Test Date	2021/3/6
Test Frequency	5300MHz	Polarization	Horizontal
Temp	22°C	Hum.	66%

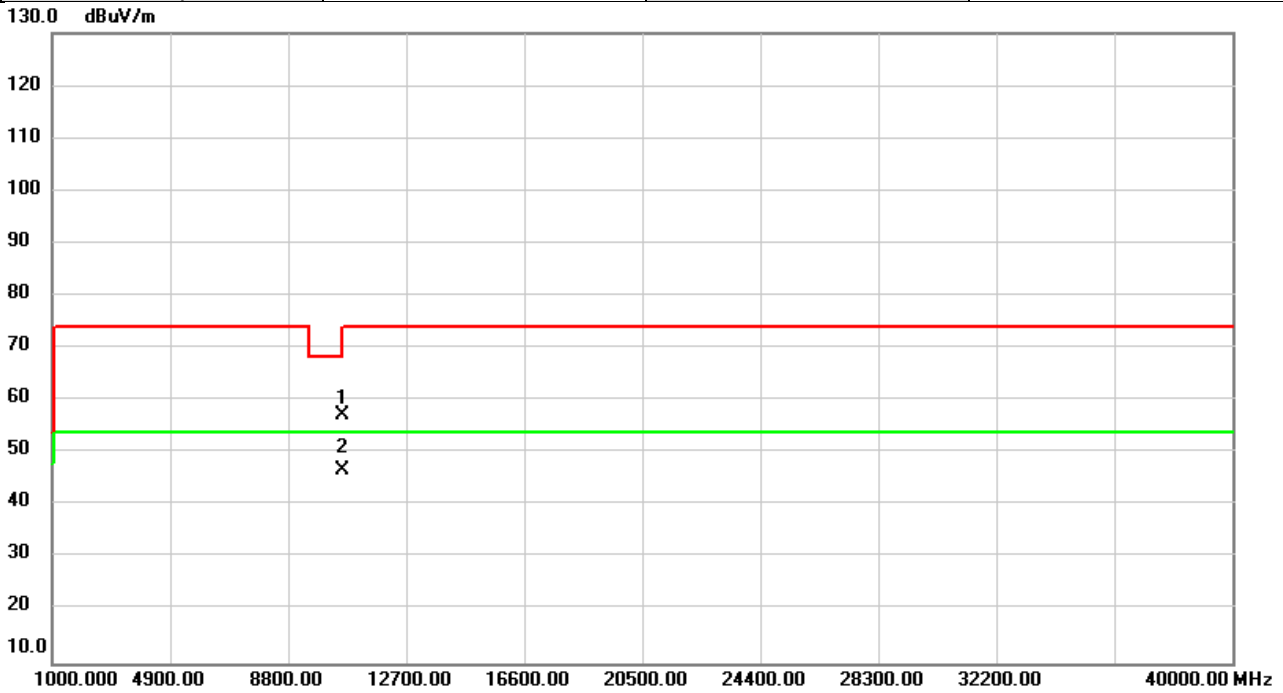

No.	Mk.	Freq.	Reading Level	Correct Factor	Measurement	Limit	Over	Detector	Comment
		MHz	dBuV	dB	dBuV/m	dBuV/m	dB		
1		10600.00	51.82	5.41	57.23	68.20	-10.97	peak	
2	*	10600.00	41.22	5.41	46.63	54.00	-7.37	AVG	

REMARKS:

- (1) Measurement Value = Reading Level + Correct Factor.
- (2) Margin Level = Measurement Value - Limit Value.

Test Mode	IEEE802.11a	Test Date	2021/3/6
Test Frequency	5320MHz	Polarization	Vertical
Temp	22°C	Hum.	66%

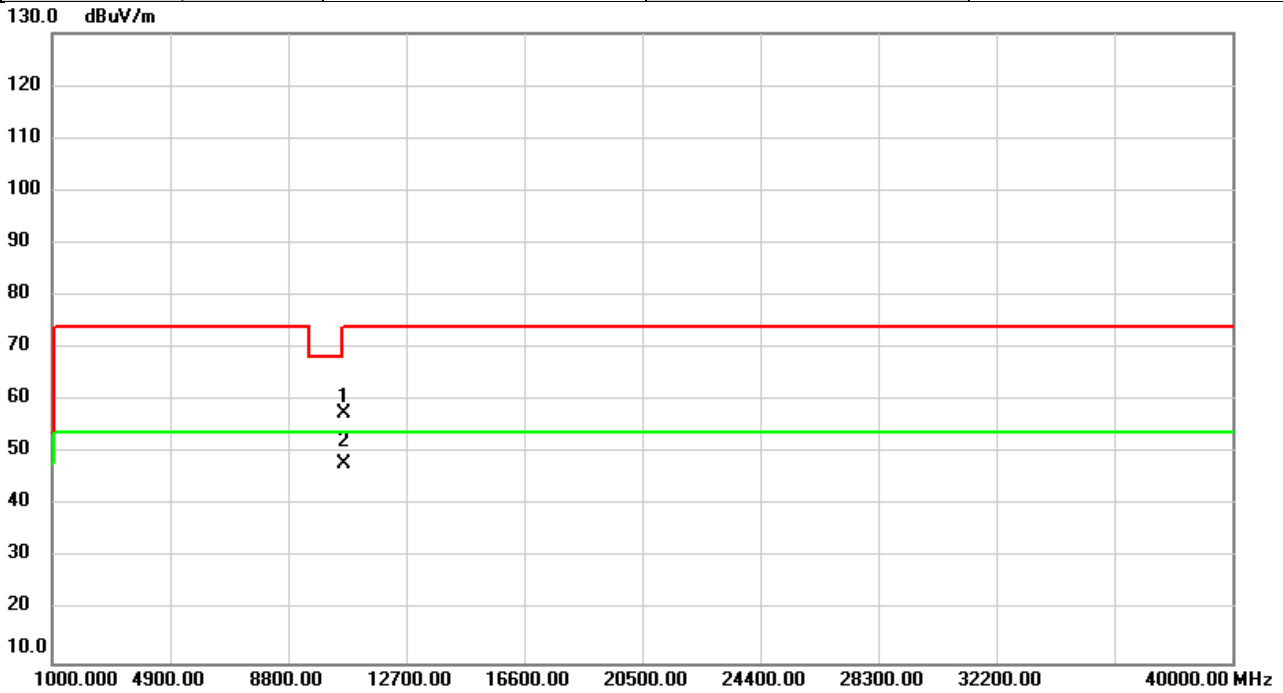

No.	Mk.	Freq.	Reading Level	Correct Factor	Measurement	Limit	Over	Detector	Comment
		MHz	dBuV	dB	dBuV/m	dBuV/m	dB		
1		10640.00	52.02	5.49	57.51	74.00	-16.49	peak	
2	*	10640.00	42.39	5.49	47.88	54.00	-6.12	AVG	

REMARKS:

- (1) Measurement Value = Reading Level + Correct Factor.
- (2) Margin Level = Measurement Value - Limit Value.

Test Mode	IEEE802.11a	Test Date	2021/3/6
Test Frequency	5320MHz	Polarization	Horizontal
Temp	22°C	Hum.	66%

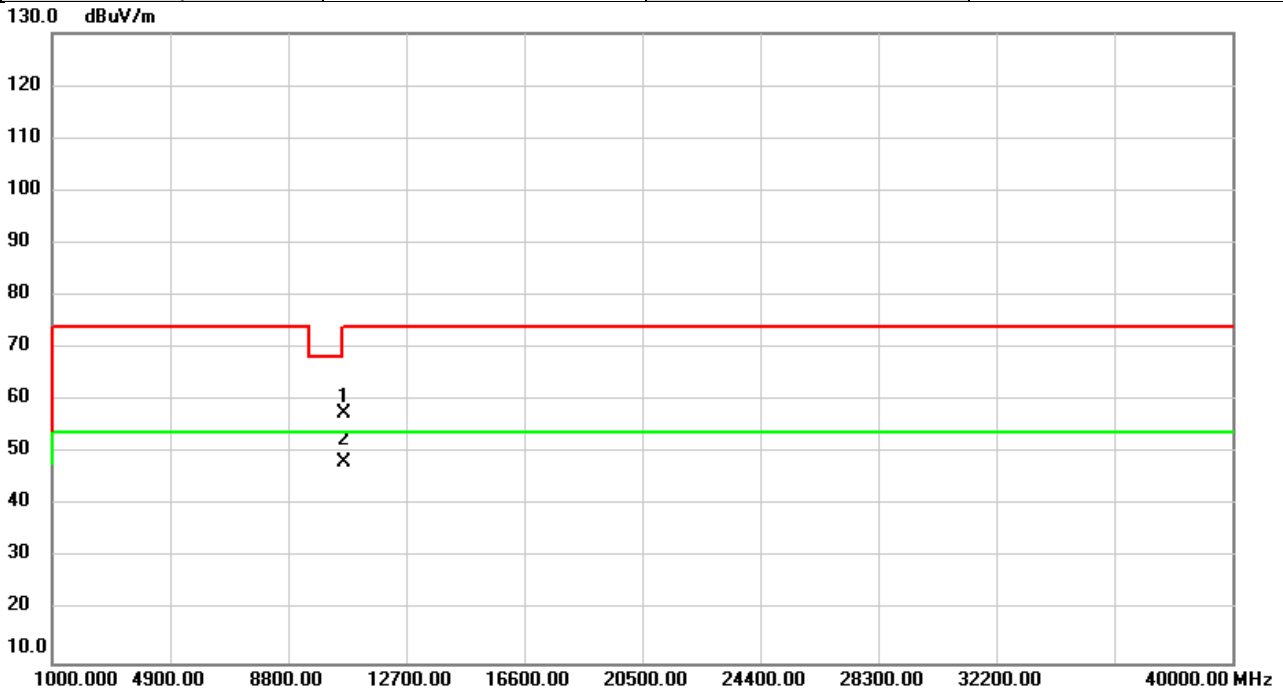

No.	Mk.	Freq.	Reading Level	Correct Factor	Measurement	Limit	Over	Detector	Comment
		MHz	dBuV	dB	dBuV/m	dBuV/m	dB		
1		10640.00	52.09	5.49	57.58	74.00	-16.42	peak	
2	*	10640.00	42.77	5.49	48.26	54.00	-5.74	AVG	

REMARKS:

- (1) Measurement Value = Reading Level + Correct Factor.
- (2) Margin Level = Measurement Value - Limit Value.

Test Mode	IEEE802.11a	Test Date	2021/3/6
Test Frequency	5500MHz	Polarization	Vertical
Temp	22°C	Hum.	66%

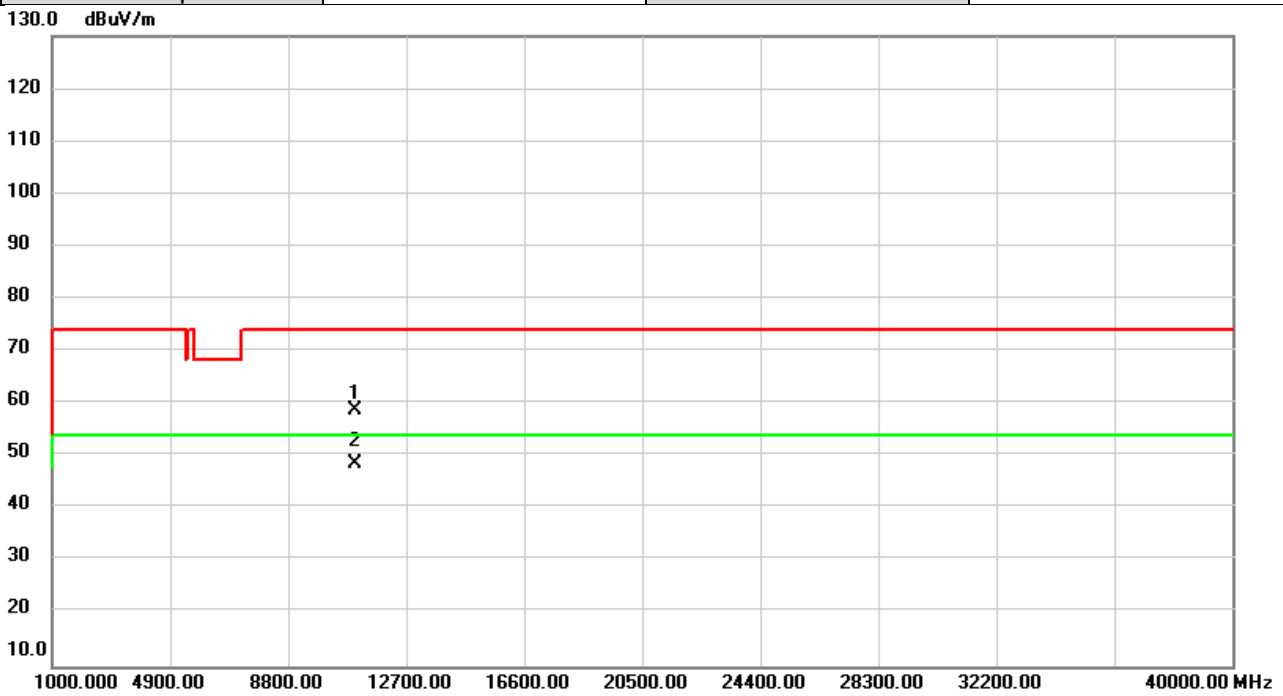

No.	Mk.	Freq.	Reading Level	Correct Factor	Measurement	Limit	Over	Detector	Comment
		MHz	dBuV	dB	dBuV/m	dBuV/m	dB		
1		11000.00	52.41	6.24	58.65	74.00	-15.35	peak	
2	*	11000.00	42.31	6.24	48.55	54.00	-5.45	AVG	

REMARKS:

- (1) Measurement Value = Reading Level + Correct Factor.
- (2) Margin Level = Measurement Value - Limit Value.

Test Mode	IEEE802.11a	Test Date	2021/3/6
Test Frequency	5500MHz	Polarization	Horizontal
Temp	22°C	Hum.	66%

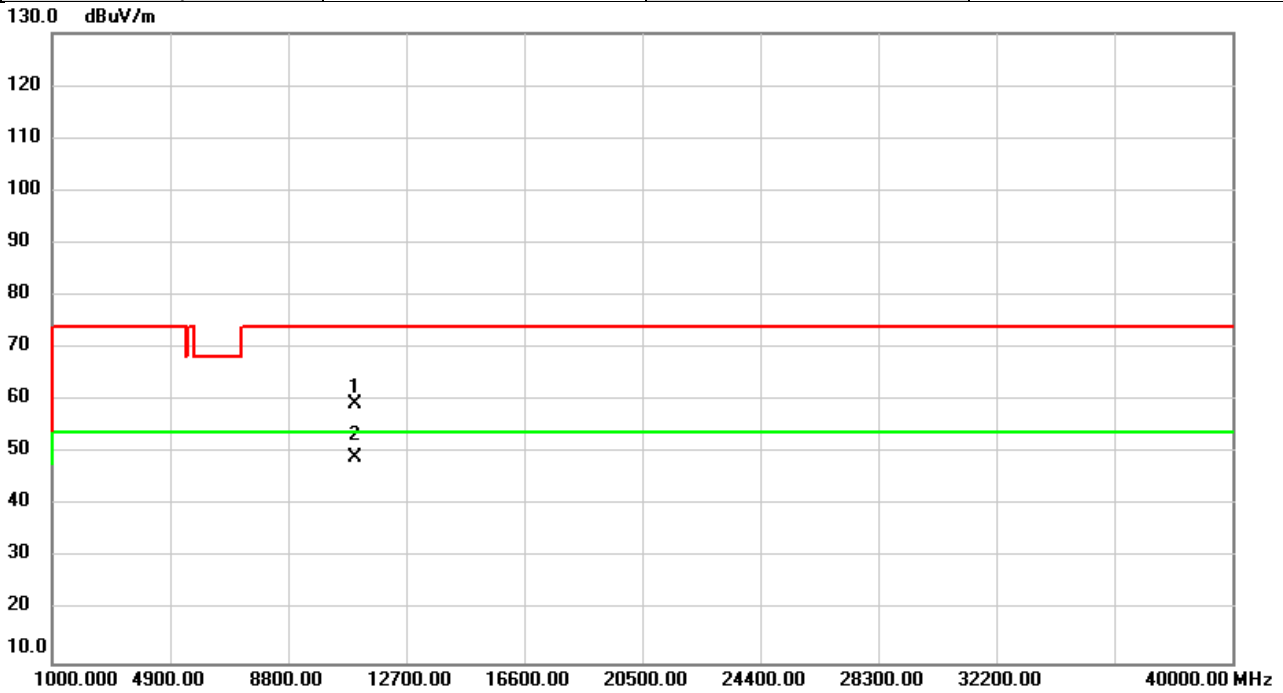

No.	Mk.	Freq.	Reading Level	Correct Factor	Measurement	Limit	Over	Detector	Comment
		MHz	dBuV	dB	dBuV/m	dBuV/m	dB		
1		11000.00	53.22	6.24	59.46	74.00	-14.54	peak	
2	*	11000.00	42.89	6.24	49.13	54.00	-4.87	AVG	

REMARKS:

- (1) Measurement Value = Reading Level + Correct Factor.
- (2) Margin Level = Measurement Value - Limit Value.

Test Mode	IEEE802.11a	Test Date	2021/3/6
Test Frequency	5580MHz	Polarization	Vertical
Temp	22°C	Hum.	66%

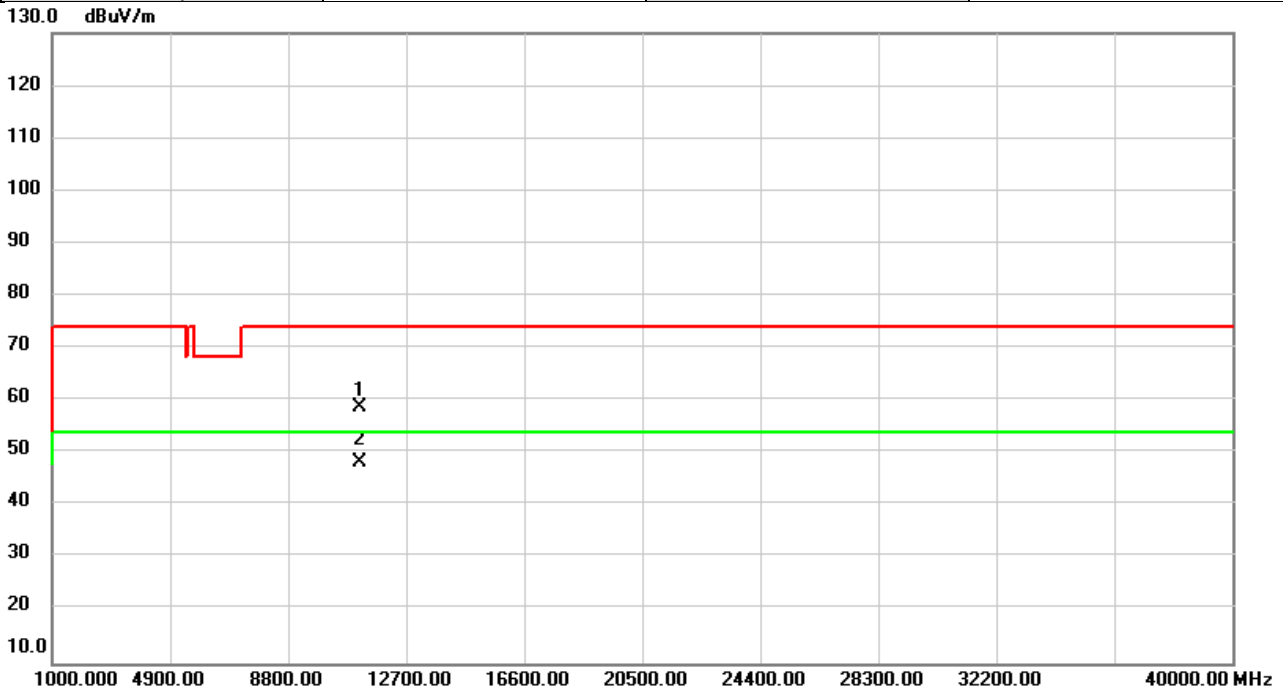

No.	Mk.	Freq.	Reading Level	Correct Factor	Measurement	Limit	Over	Detector	Comment
		MHz	dBuV	dB	dBuV/m	dBuV/m	dB		
1		11160.00	52.76	5.85	58.61	74.00	-15.39	peak	
2	*	11160.00	42.28	5.85	48.13	54.00	-5.87	AVG	

REMARKS:

- (1) Measurement Value = Reading Level + Correct Factor.
- (2) Margin Level = Measurement Value - Limit Value.

Test Mode	IEEE802.11a	Test Date	2021/3/6
Test Frequency	5580MHz	Polarization	Horizontal
Temp	22°C	Hum.	66%

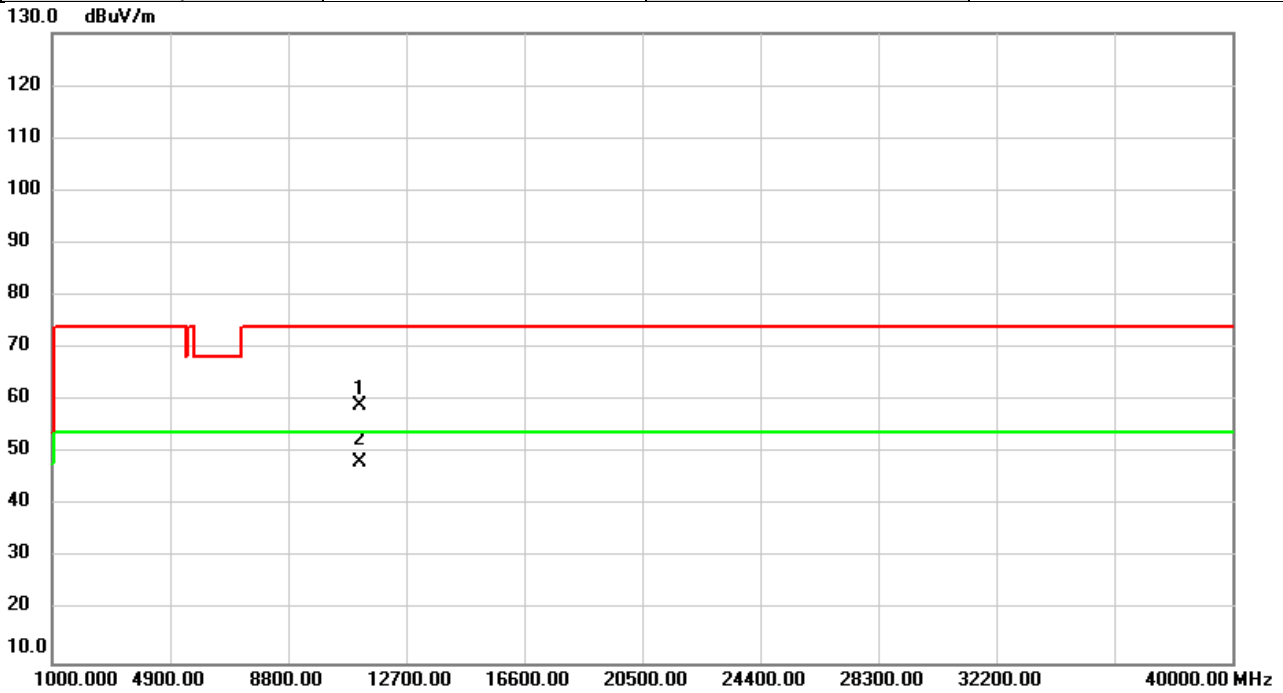

No.	Mk.	Freq.	Reading Level	Correct Factor	Measurement	Limit	Over	Detector	Comment
		MHz	dBuV	dB	dBuV/m	dBuV/m	dB		
1		11160.00	53.12	5.85	58.97	74.00	-15.03	peak	
2	*	11160.00	42.46	5.85	48.31	54.00	-5.69	AVG	

REMARKS:

- (1) Measurement Value = Reading Level + Correct Factor.
- (2) Margin Level = Measurement Value - Limit Value.

Test Mode	IEEE802.11a	Test Date	2021/3/6
Test Frequency	5700MHz	Polarization	Vertical
Temp	22°C	Hum.	66%

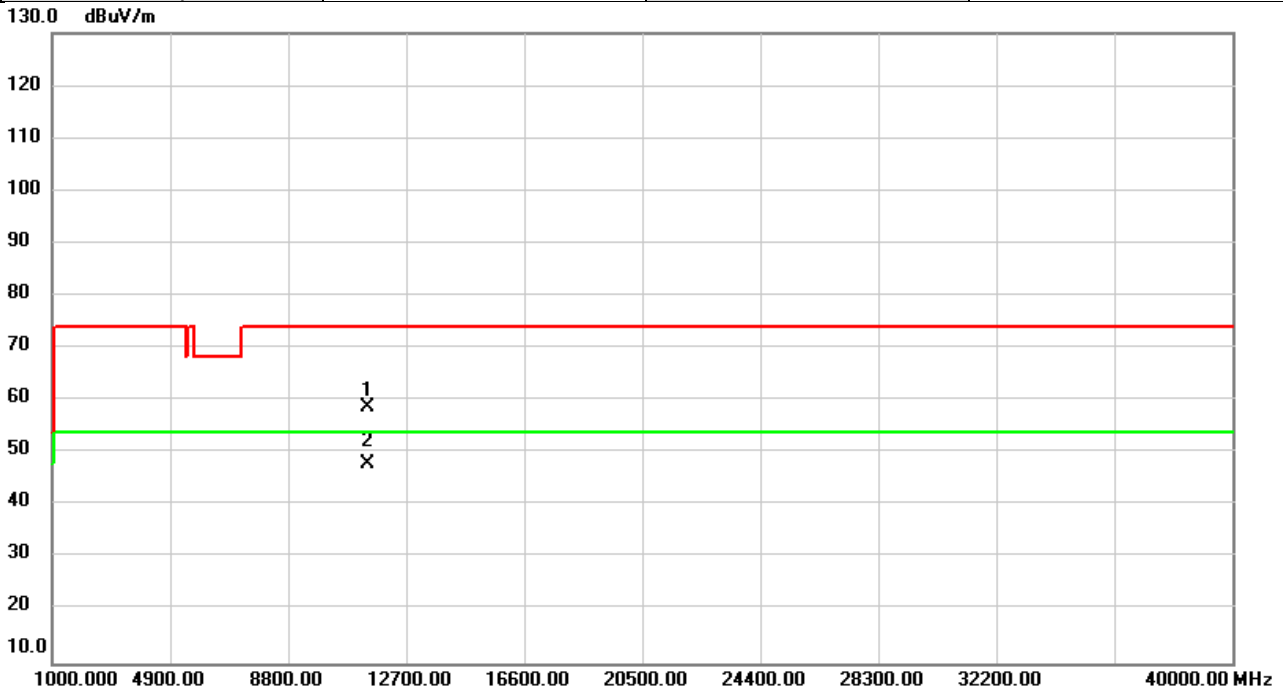

No.	Mk.	Freq.	Reading Level	Correct Factor	Measurement	Limit	Over	Detector	Comment
		MHz	dBuV	dB	dBuV/m	dBuV/m	dB		
1		11400.00	53.50	5.27	58.77	74.00	-15.23	peak	
2	*	11400.00	42.60	5.27	47.87	54.00	-6.13	AVG	

REMARKS:

- (1) Measurement Value = Reading Level + Correct Factor.
- (2) Margin Level = Measurement Value - Limit Value.

Test Mode	IEEE802.11a	Test Date	2021/3/6
Test Frequency	5700MHz	Polarization	Horizontal
Temp	22°C	Hum.	66%

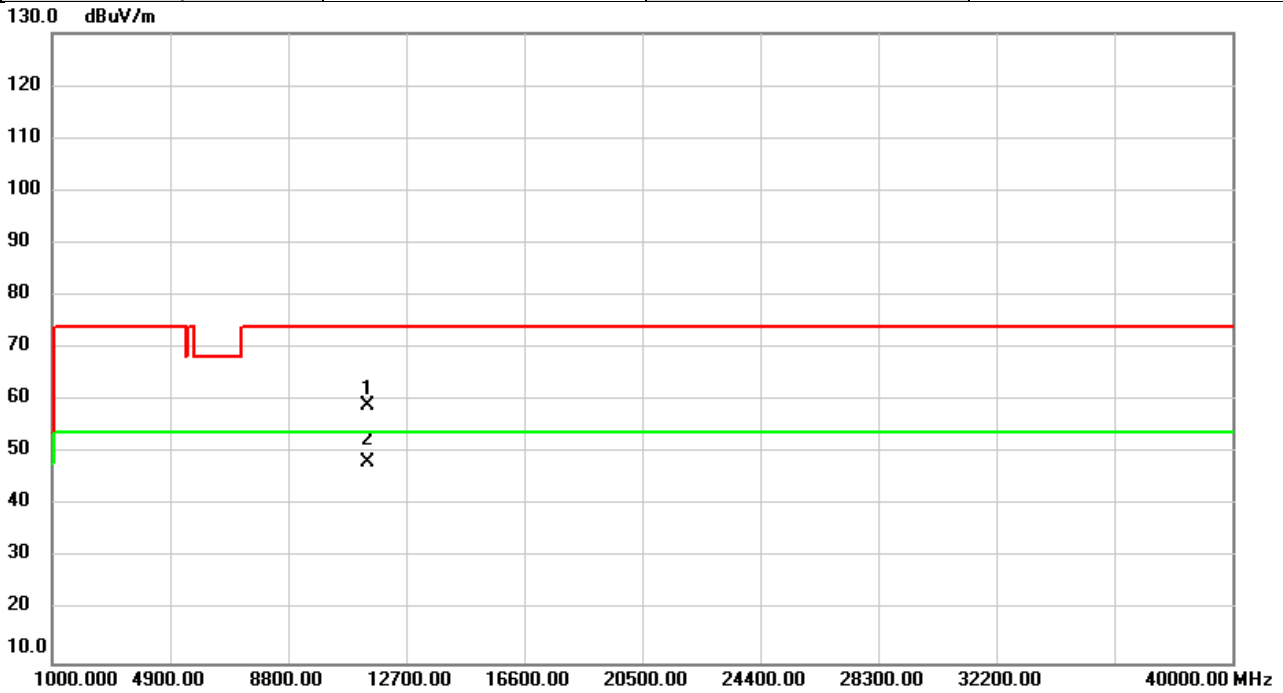

No.	Mk.	Freq.	Reading Level	Correct Factor	Measurement	Limit	Over	Detector	Comment
		MHz	dBuV	dB	dBuV/m	dBuV/m	dB		
1		11400.00	53.70	5.27	58.97	74.00	-15.03	peak	
2	*	11400.00	42.91	5.27	48.18	54.00	-5.82	AVG	

REMARKS:

- (1) Measurement Value = Reading Level + Correct Factor.
- (2) Margin Level = Measurement Value - Limit Value.

Test Mode	IEEE802.11a	Test Date	2021/3/6
Test Frequency	5745MHz	Polarization	Vertical
Temp	22°C	Hum.	66%

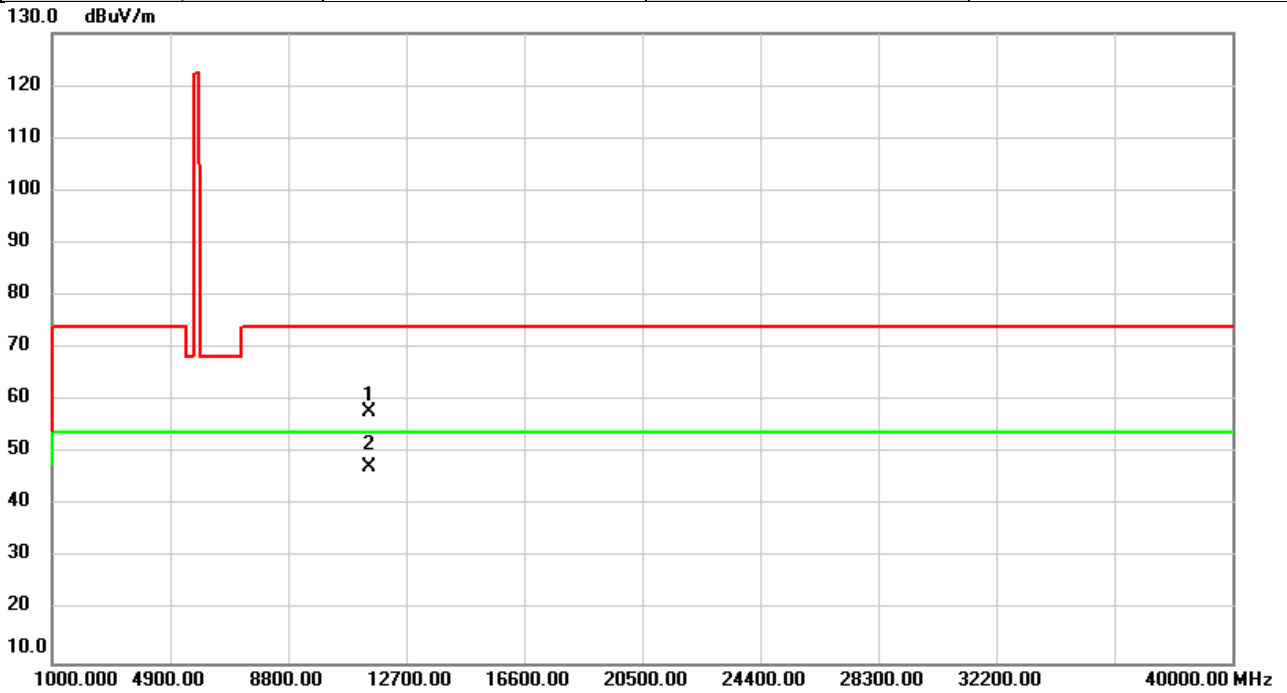

No.	Mk.	Freq.	Reading Level	Correct Factor	Measurement	Limit	Over	Detector	Comment
		MHz	dBuV	dB	dBuV/m	dBuV/m	dB		
1		11490.00	52.73	5.05	57.78	74.00	-16.22	peak	
2	*	11490.00	42.37	5.05	47.42	54.00	-6.58	AVG	

REMARKS:

- (1) Measurement Value = Reading Level + Correct Factor.
- (2) Margin Level = Measurement Value - Limit Value.

Test Mode	IEEE802.11a	Test Date	2021/3/6
Test Frequency	5745MHz	Polarization	Horizontal
Temp	22°C	Hum.	66%

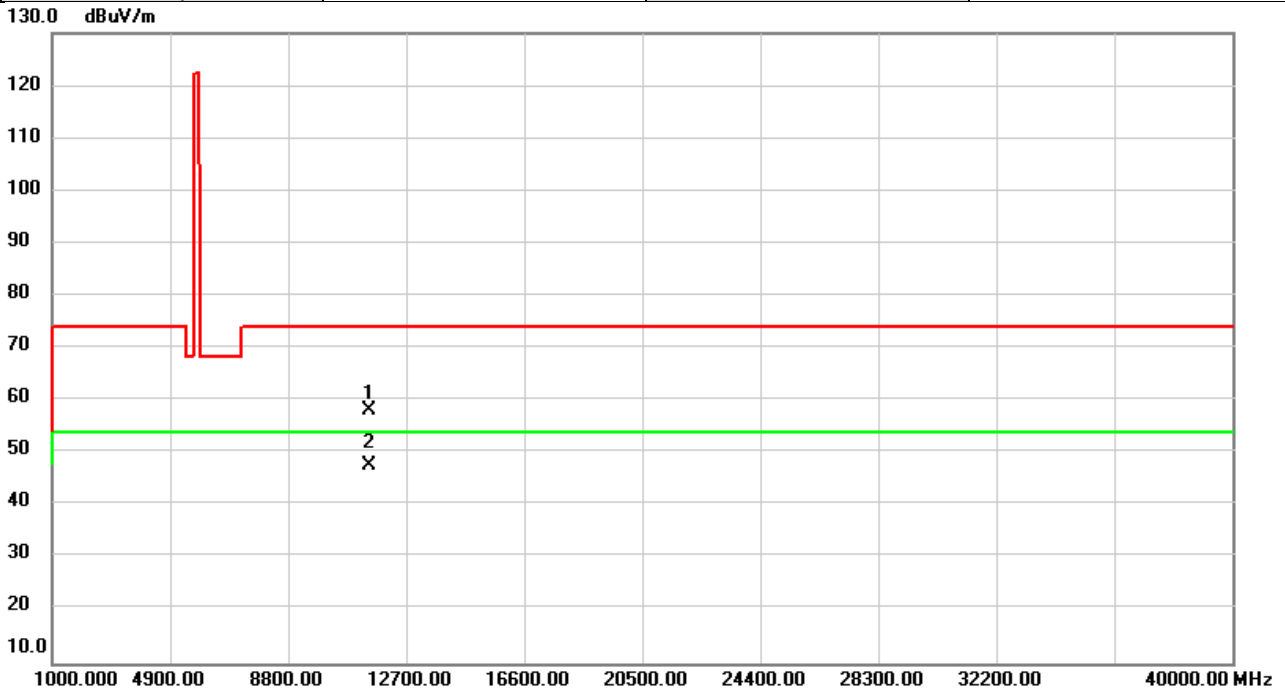

No.	Mk.	Freq.	Reading Level	Correct Factor	Measurement	Limit	Over	Detector	Comment
		MHz	dBuV	dB	dBuV/m	dBuV/m	dB		
1		11490.00	53.11	5.05	58.16	74.00	-15.84	peak	
2	*	11490.00	42.75	5.05	47.80	54.00	-6.20	AVG	

REMARKS:

- (1) Measurement Value = Reading Level + Correct Factor.
- (2) Margin Level = Measurement Value - Limit Value.

Test Mode	IEEE802.11a	Test Date	2021/3/6
Test Frequency	5785MHz	Polarization	Vertical
Temp	22°C	Hum.	66%

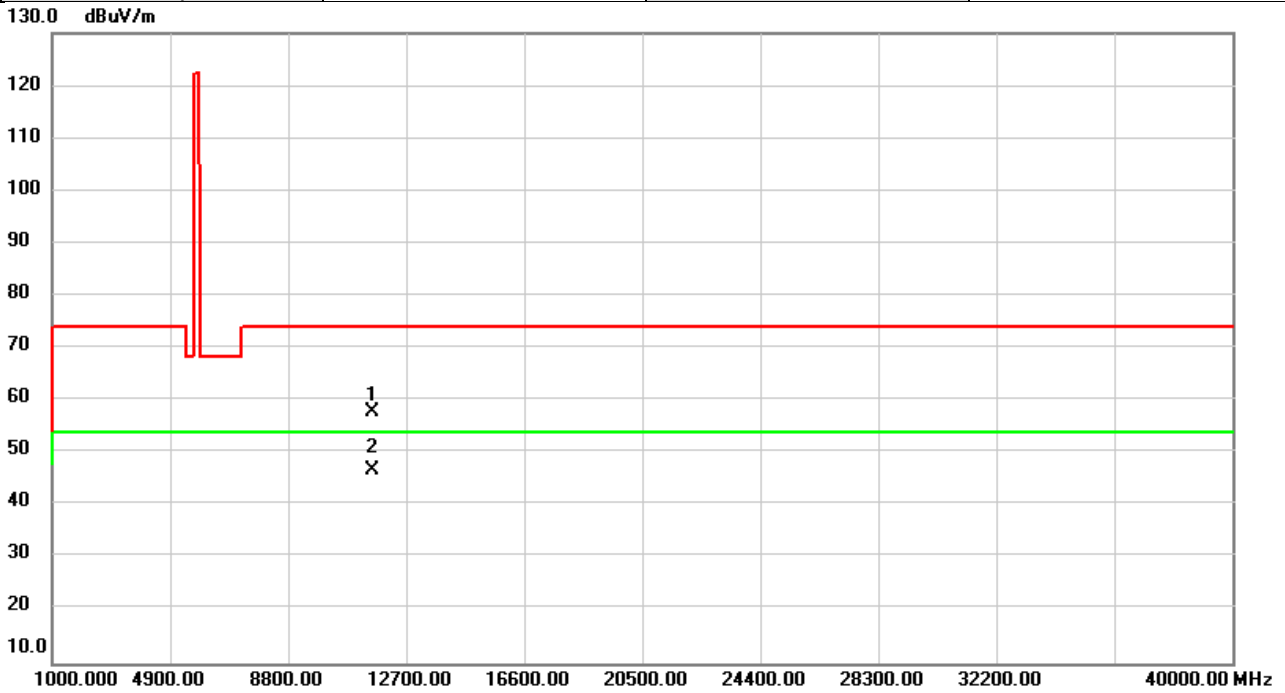

No.	Mk.	Freq.	Reading Level	Correct Factor	Measurement	Limit	Over	Detector	Comment
		MHz	dBuV	dB	dBuV/m	dBuV/m	dB		
1		11570.00	52.96	4.87	57.83	74.00	-16.17	peak	
2	*	11570.00	42.03	4.87	46.90	54.00	-7.10	AVG	

REMARKS:

- (1) Measurement Value = Reading Level + Correct Factor.
- (2) Margin Level = Measurement Value - Limit Value.

Test Mode	IEEE802.11a	Test Date	2021/3/6
Test Frequency	5785MHz	Polarization	Horizontal
Temp	22°C	Hum.	66%

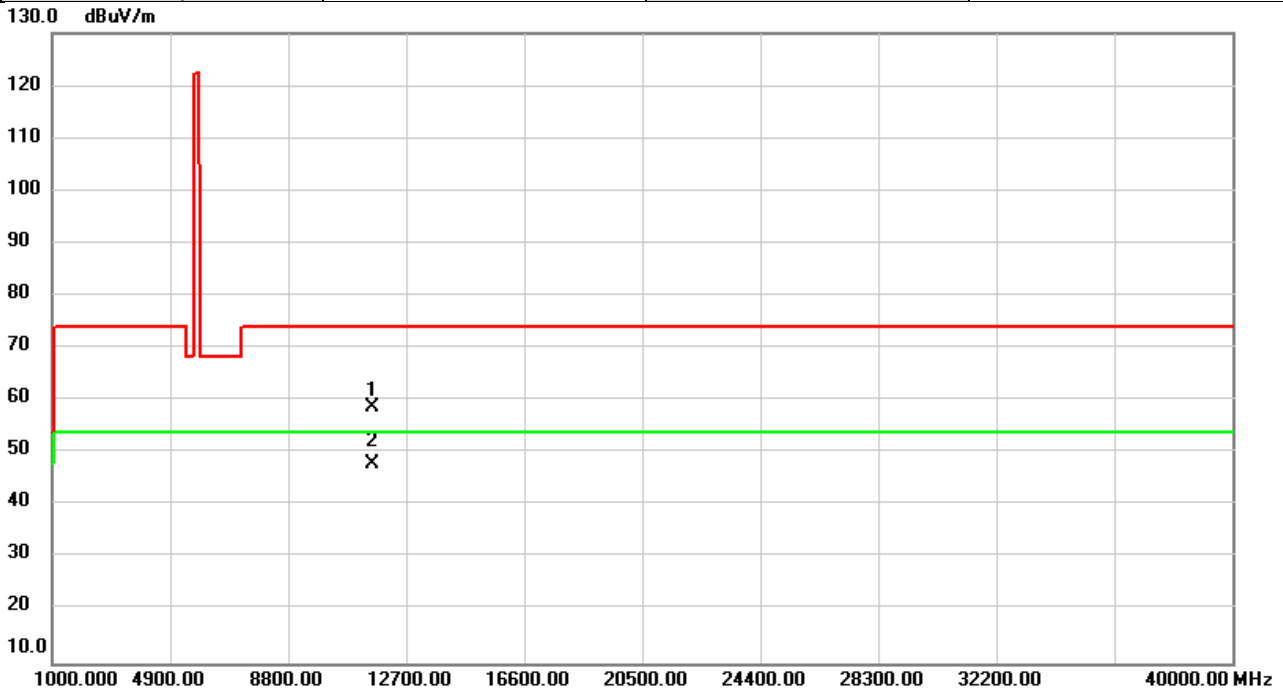

No.	Mk.	Freq.	Reading Level	Correct Factor	Measurement	Limit	Over	Detector	Comment
		MHz	dBuV	dB	dBuV/m	dBuV/m	dB		
1		11570.00	53.80	4.87	58.67	74.00	-15.33	peak	
2	*	11570.00	43.08	4.87	47.95	54.00	-6.05	AVG	

REMARKS:

- (1) Measurement Value = Reading Level + Correct Factor.
- (2) Margin Level = Measurement Value - Limit Value.

Test Mode	IEEE802.11a	Test Date	2021/3/6
Test Frequency	5825MHz	Polarization	Vertical
Temp	22°C	Hum.	66%

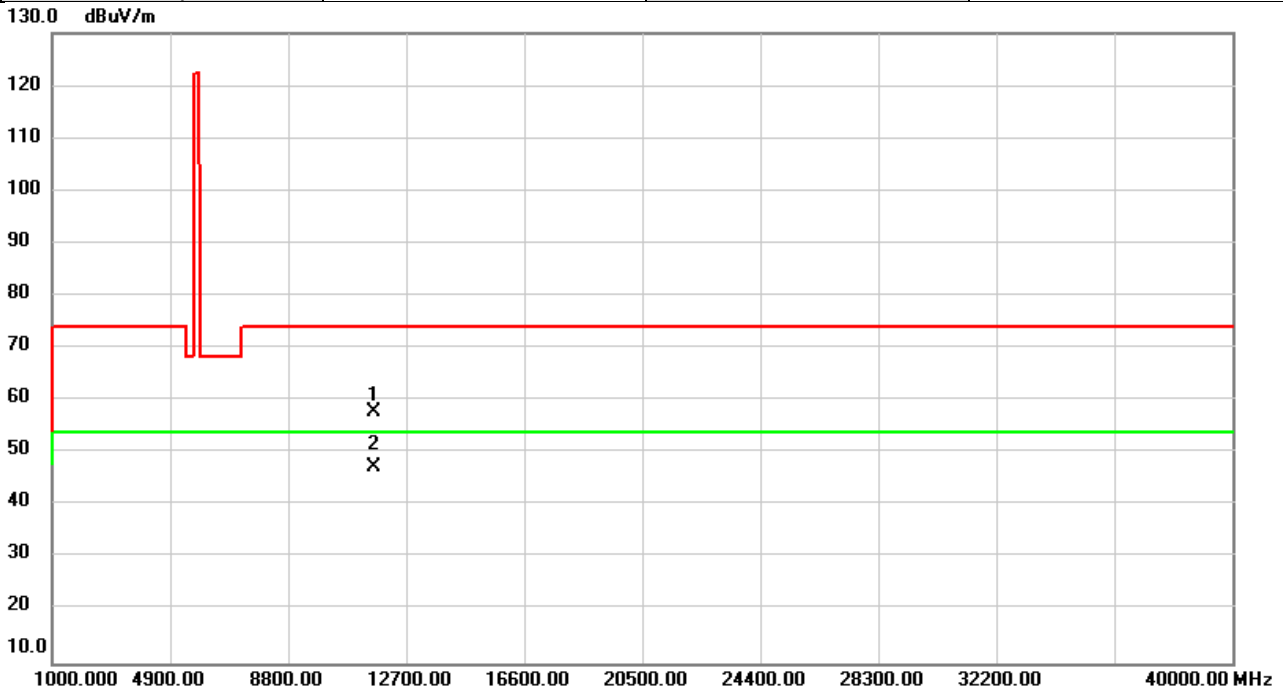

No.	Mk.	Freq.	Reading Level	Correct Factor	Measurement	Limit	Over	Detector	Comment
		MHz	dBuV	dB	dBuV/m	dBuV/m	dB		
1		11650.00	53.25	4.69	57.94	74.00	-16.06	peak	
2	*	11650.00	42.55	4.69	47.24	54.00	-6.76	AVG	

REMARKS:

- (1) Measurement Value = Reading Level + Correct Factor.
- (2) Margin Level = Measurement Value - Limit Value.

Test Mode	IEEE802.11a	Test Date	2021/3/6
Test Frequency	5825MHz	Polarization	Horizontal
Temp	22°C	Hum.	66%

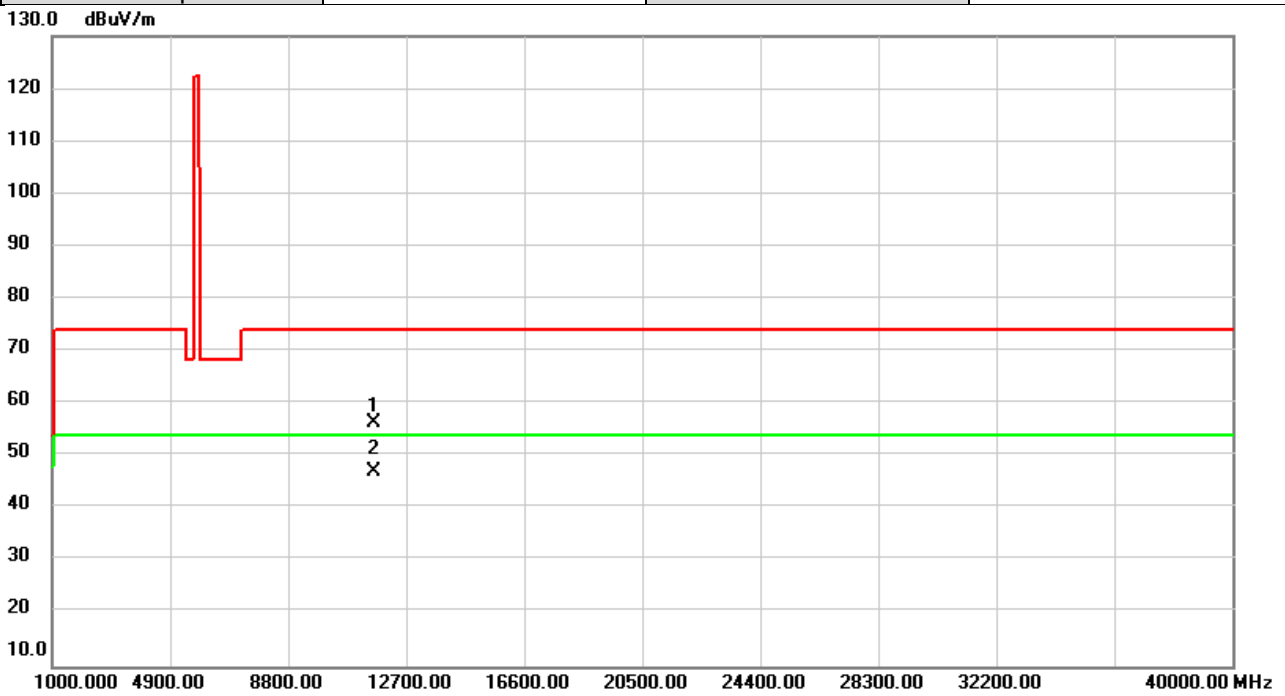

No.	Mk.	Freq.	Reading Level	Correct Factor	Measurement	Limit	Over	Detector	Comment
		MHz	dBuV	dB	dBuV/m	dBuV/m	dB		
1		11650.00	51.77	4.69	56.46	74.00	-17.54	peak	
2	*	11650.00	42.39	4.69	47.08	54.00	-6.92	AVG	

REMARKS:

- (1) Measurement Value = Reading Level + Correct Factor.
- (2) Margin Level = Measurement Value - Limit Value.

Test Mode	IEEE802.11n (HT20)	Test Date	2021/3/6
Test Frequency	5180MHz	Polarization	Vertical
Temp	22°C	Hum.	66%

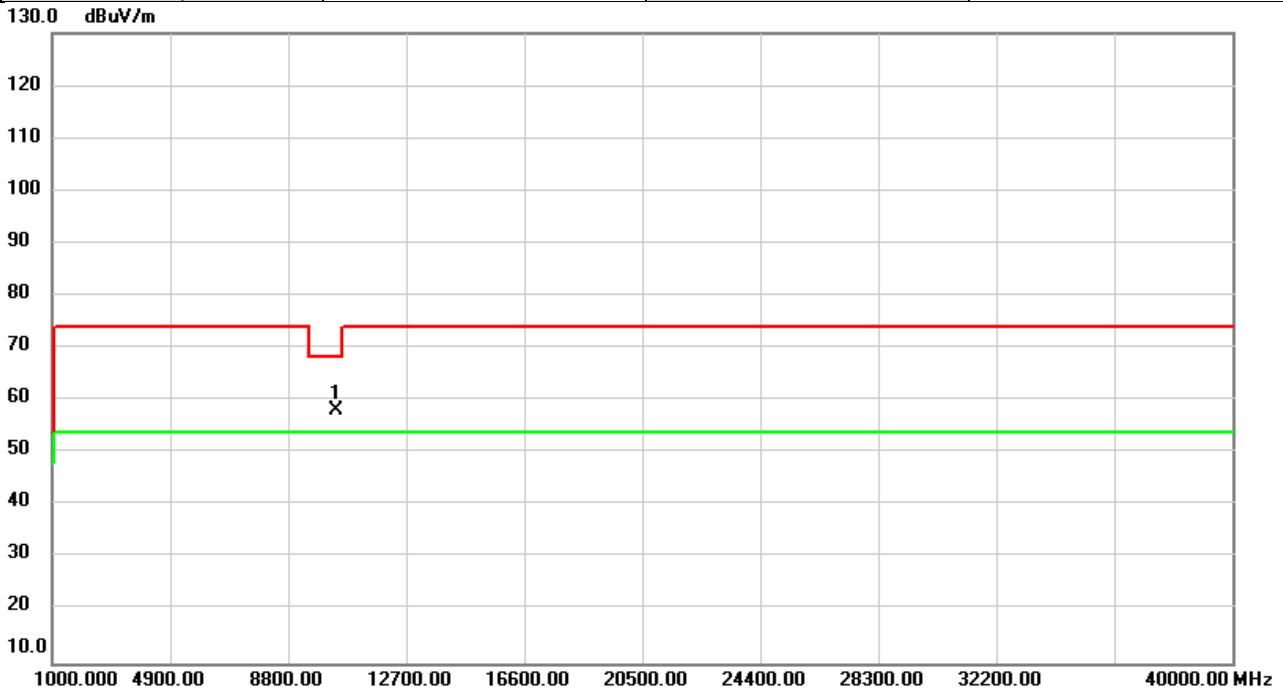

No.	Mk.	Freq.	Reading Level	Correct Factor	Measurement	Limit	Over	Detector	Comment
		MHz	dBuV	dB	dBuV/m	dBuV/m	dB		
1	*	10360.00	53.29	4.85	58.14	68.20	-10.06	peak	

REMARKS:

- (1) Measurement Value = Reading Level + Correct Factor.
- (2) Margin Level = Measurement Value - Limit Value.

Test Mode	IEEE802.11n (HT20)	Test Date	2021/3/6
Test Frequency	5180MHz	Polarization	Horizontal
Temp	22°C	Hum.	66%

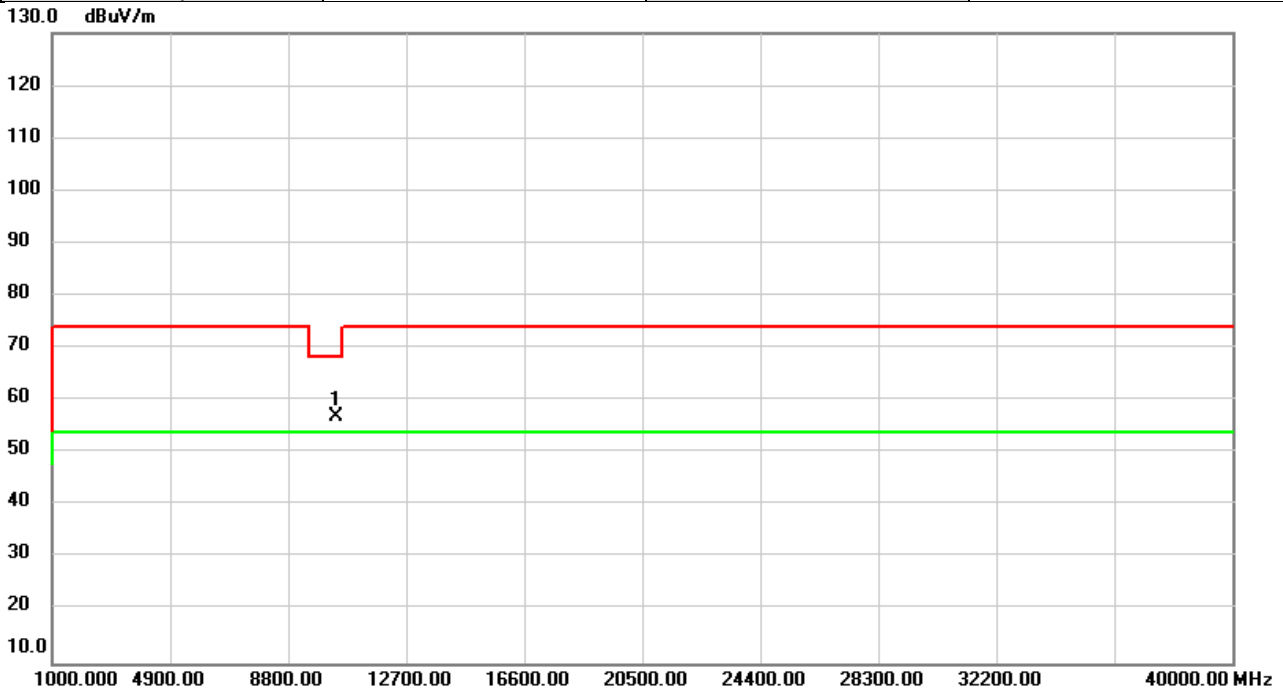

No.	Mk.	Freq.	Reading Level	Correct Factor	Measurement	Limit	Over	Detector	Comment
		MHz	dBuV	dB	dBuV/m	dBuV/m	dB		
1	*	10360.00	52.22	4.85	57.07	68.20	-11.13	peak	

REMARKS:

- (1) Measurement Value = Reading Level + Correct Factor.
- (2) Margin Level = Measurement Value - Limit Value.

Test Mode	IEEE802.11n (HT20)	Test Date	2021/3/6
Test Frequency	5200MHz	Polarization	Vertical
Temp	22°C	Hum.	66%

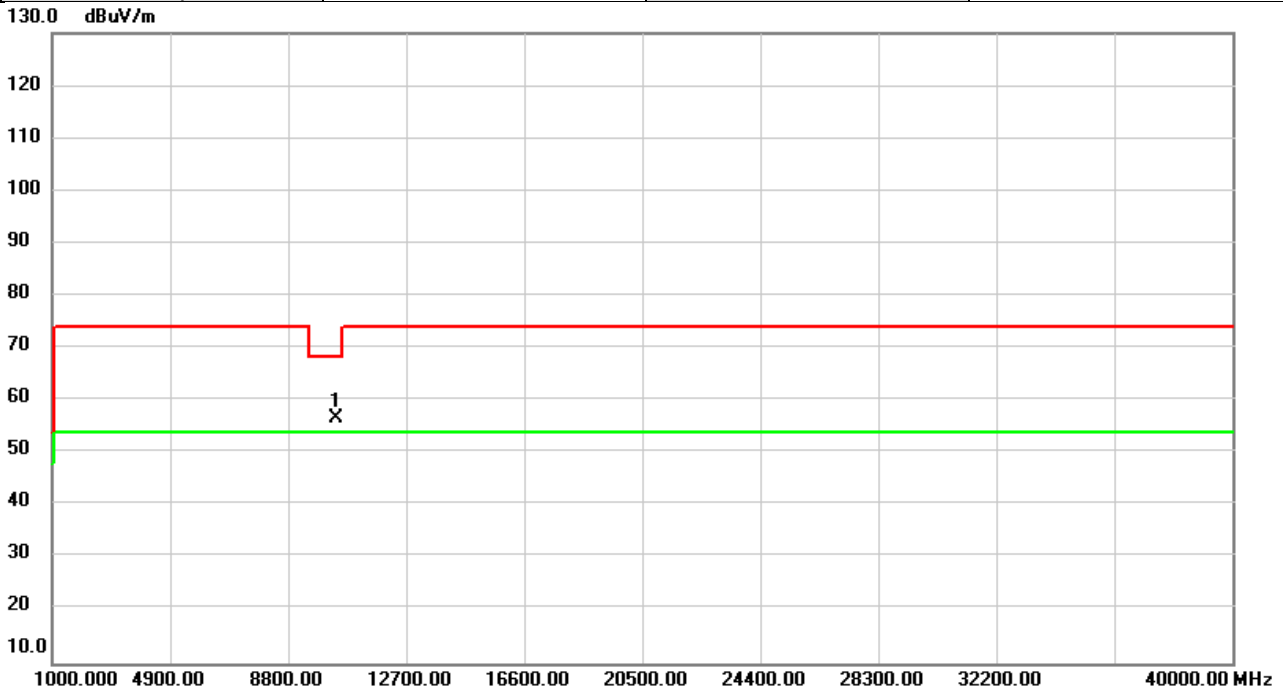

No.	Mk.	Freq.	Reading Level	Correct Factor	Measurement	Limit	Over	Detector	Comment
		MHz	dBuV	dB	dBuV/m	dBuV/m	dB		
1	*	10400.00	51.82	4.94	56.76	68.20	-11.44	peak	

REMARKS:

- (1) Measurement Value = Reading Level + Correct Factor.
- (2) Margin Level = Measurement Value - Limit Value.

Test Mode	IEEE802.11n (HT20)	Test Date	2021/3/6
Test Frequency	5200MHz	Polarization	Horizontal
Temp	22°C	Hum.	66%

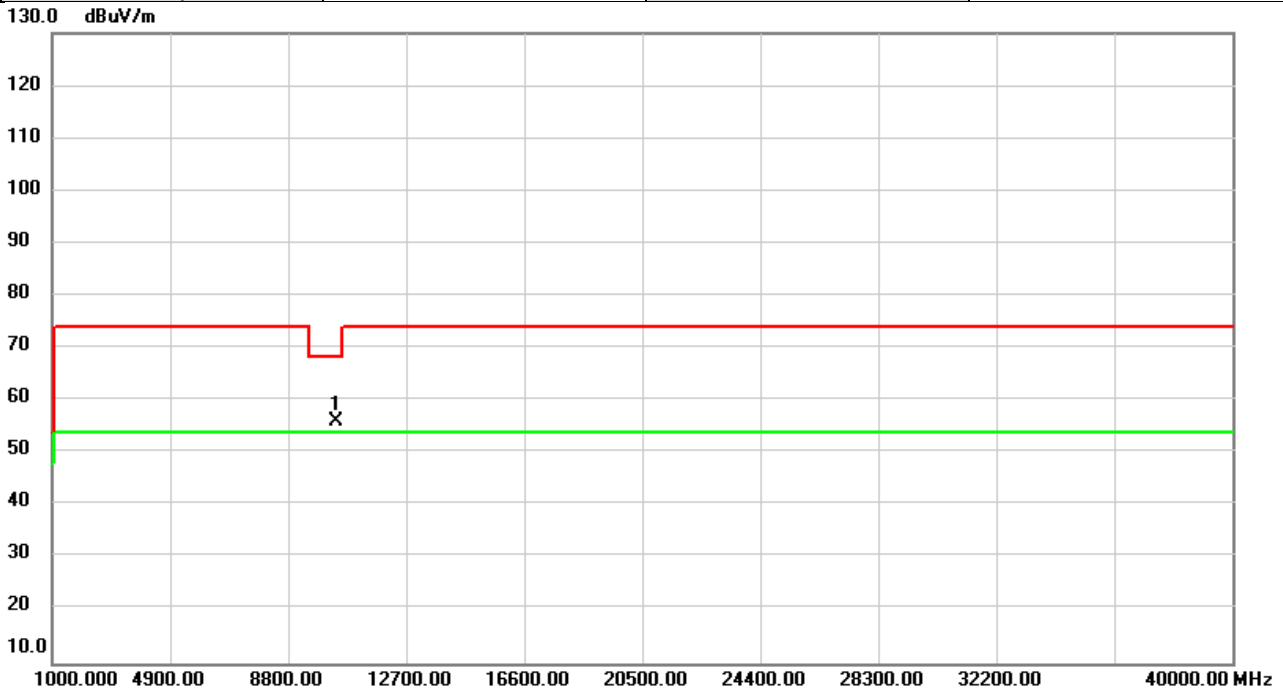

No.	Mk.	Freq.	Reading Level	Correct Factor	Measurement	Limit	Over	Detector	Comment
		MHz	dBuV	dB	dBuV/m	dBuV/m	dB		
1	*	10400.00	51.24	4.94	56.18	68.20	-12.02	peak	

REMARKS:

- (1) Measurement Value = Reading Level + Correct Factor.
- (2) Margin Level = Measurement Value - Limit Value.

Test Mode	IEEE802.11n (HT20)	Test Date	2021/3/6
Test Frequency	5240MHz	Polarization	Vertical
Temp	22°C	Hum.	66%

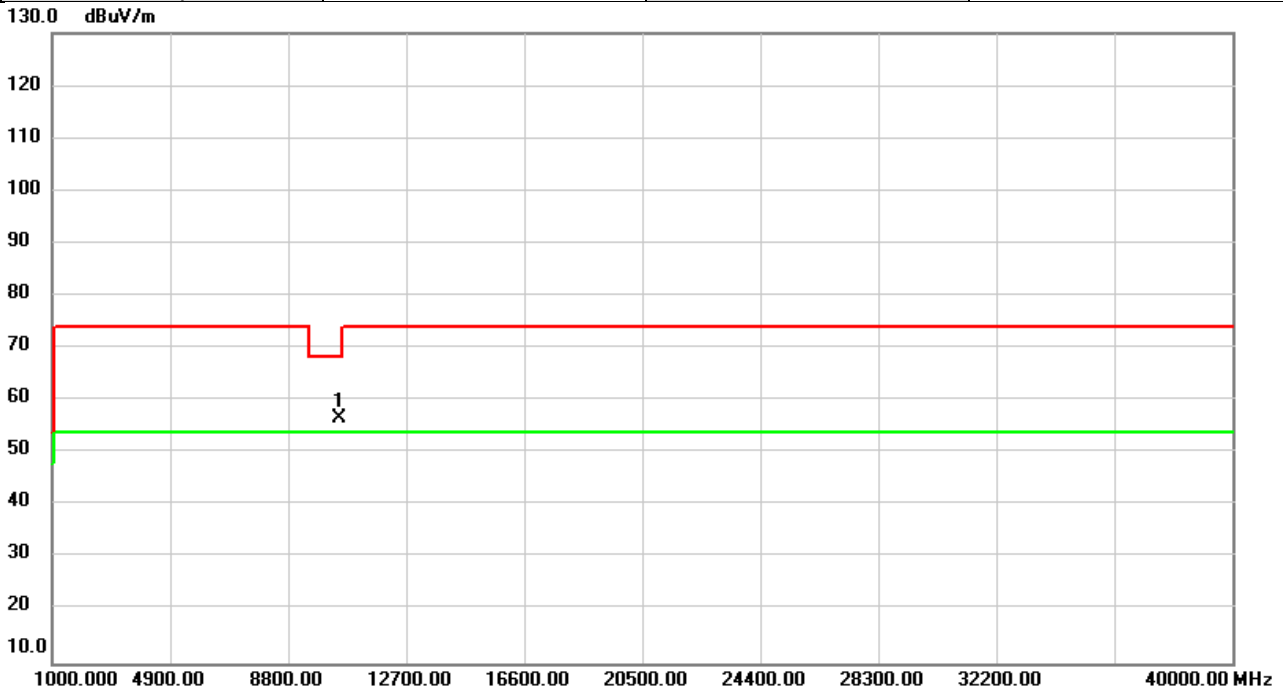

No.	Mk.	Freq.	Reading Level	Correct Factor	Measurement	Limit	Over	Detector	Comment
		MHz	dBuV	dB	dBuV/m	dBuV/m	dB		
1	*	10480.00	51.62	5.15	56.77	68.20	-11.43	peak	

REMARKS:

- (1) Measurement Value = Reading Level + Correct Factor.
- (2) Margin Level = Measurement Value - Limit Value.

Test Mode	IEEE802.11n (HT20)	Test Date	2021/3/6
Test Frequency	5240MHz	Polarization	Horizontal
Temp	22°C	Hum.	66%

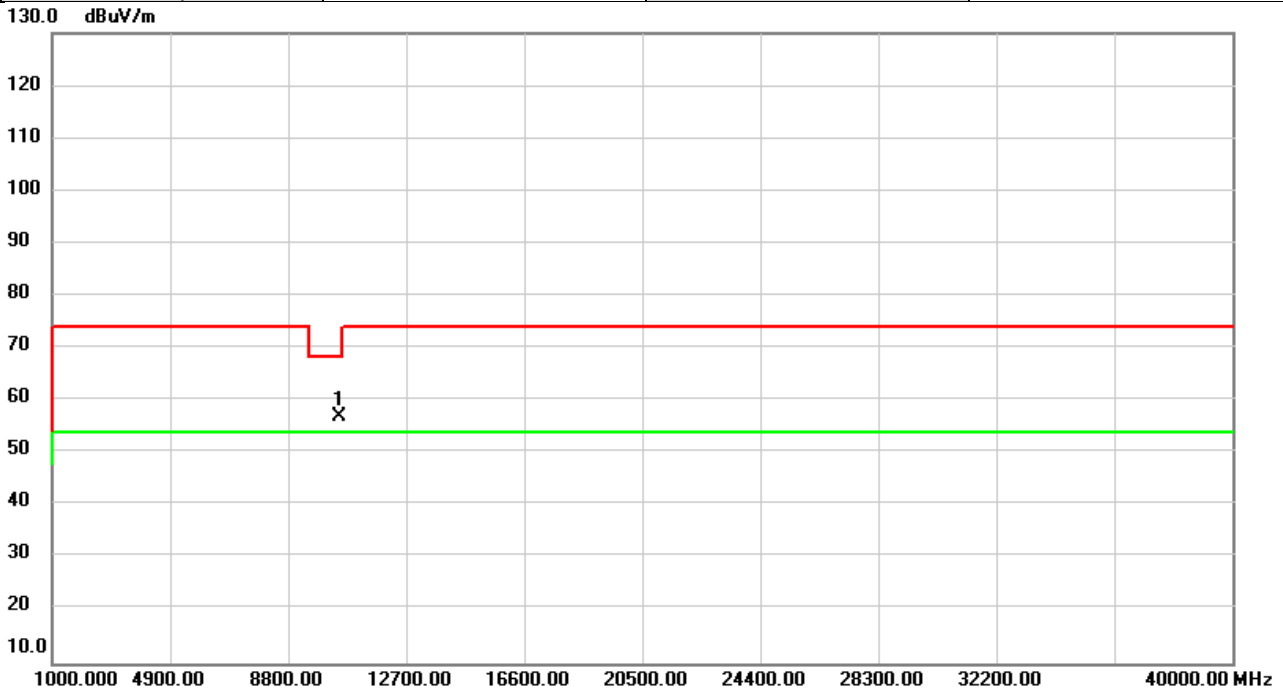

No.	Mk.	Freq.	Reading Level	Correct Factor	Measurement	Limit	Over	Detector	Comment
		MHz	dBuV	dB	dBuV/m	dBuV/m	dB		
1	*	10480.00	51.93	5.15	57.08	68.20	-11.12	peak	

REMARKS:

- (1) Measurement Value = Reading Level + Correct Factor.
- (2) Margin Level = Measurement Value - Limit Value.

Test Mode	IEEE802.11n (HT20)	Test Date	2021/3/6
Test Frequency	5260MHz	Polarization	Vertical
Temp	22°C	Hum.	66%

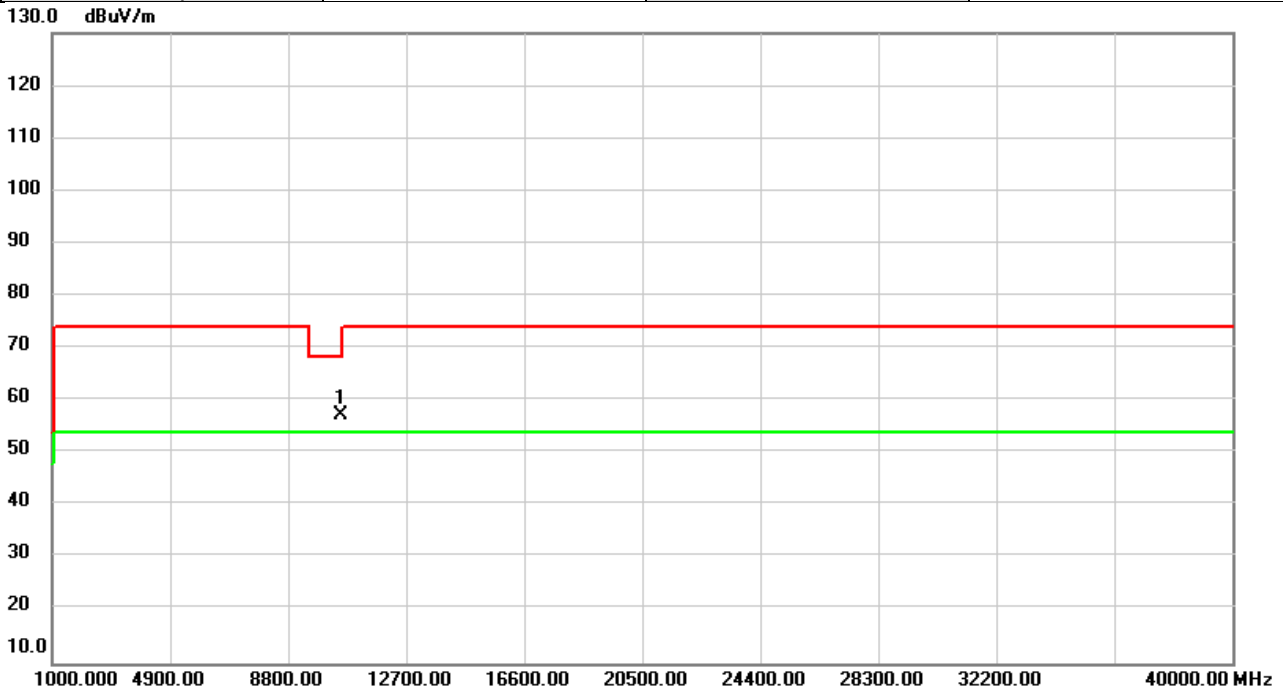

No.	Mk.	Freq.	Reading Level	Correct Factor	Measurement	Limit	Over	Detector	Comment
		MHz	dBuV	dB	dBuV/m	dBuV/m	dB		
1	*	10520.00	52.12	5.24	57.36	68.20	-10.84	peak	

REMARKS:

- (1) Measurement Value = Reading Level + Correct Factor.
- (2) Margin Level = Measurement Value - Limit Value.

Test Mode	IEEE802.11n (HT20)	Test Date	2021/3/6
Test Frequency	5260MHz	Polarization	Horizontal
Temp	22°C	Hum.	66%

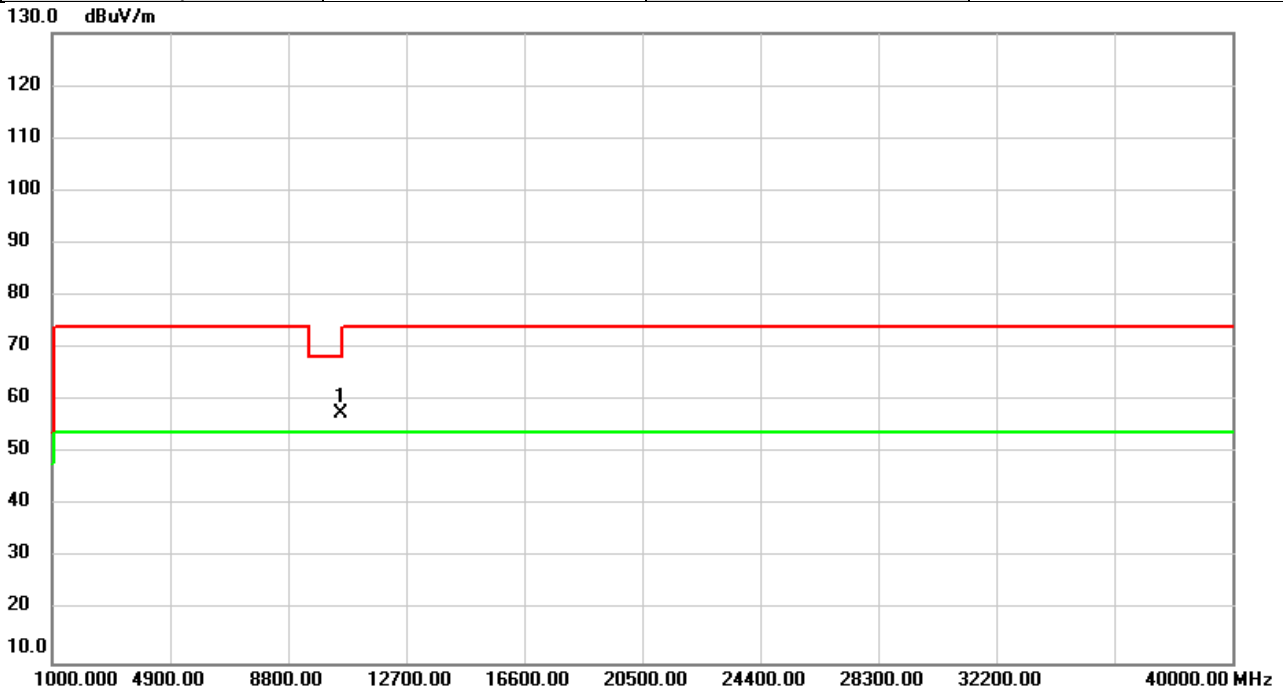

No.	Mk.	Freq.	Reading Level	Correct Factor	Measurement	Limit	Over	Detector	Comment
		MHz	dBuV	dB	dBuV/m	dBuV/m	dB		
1	*	10520.00	52.29	5.24	57.53	68.20	-10.67	peak	

REMARKS:

- (1) Measurement Value = Reading Level + Correct Factor.
- (2) Margin Level = Measurement Value - Limit Value.

Test Mode	IEEE802.11n (HT20)	Test Date	2021/3/6
Test Frequency	5300MHz	Polarization	Vertical
Temp	22°C	Hum.	66%

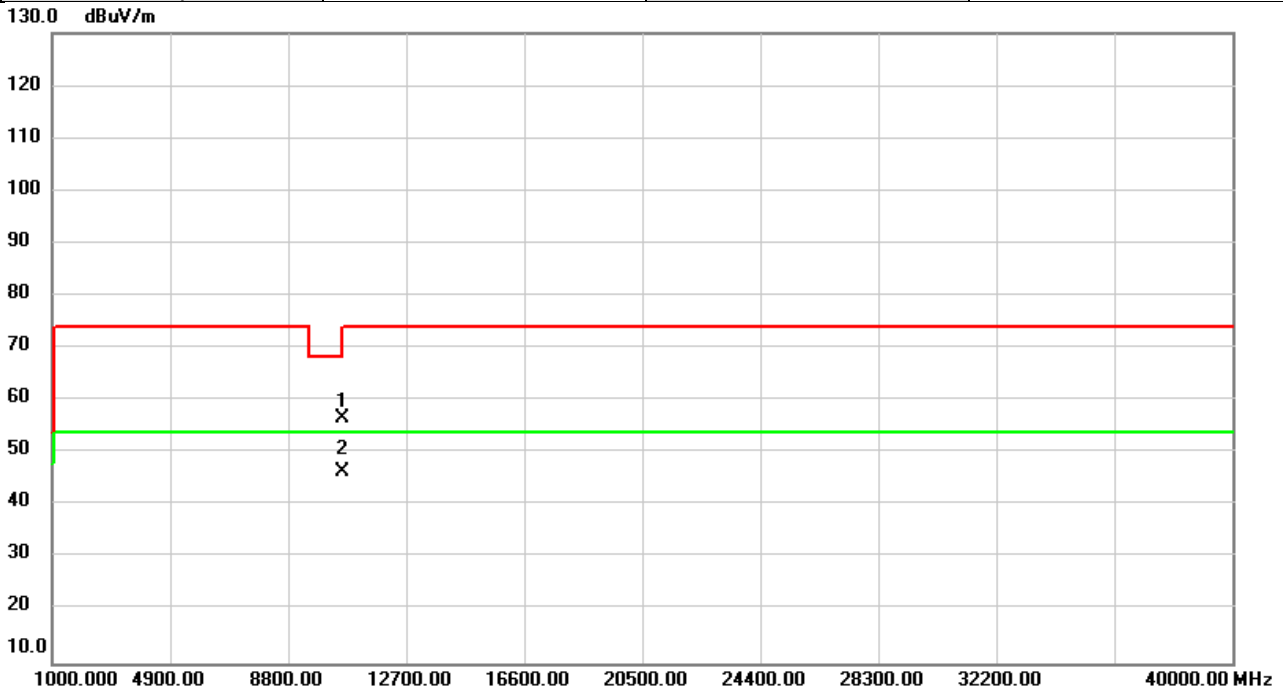

No.	Mk.	Freq.	Reading Level	Correct Factor	Measurement	Limit	Over	Detector	Comment
		MHz	dBuV	dB	dBuV/m	dBuV/m	dB		
1		10600.00	51.16	5.41	56.57	68.20	-11.63	peak	
2	*	10600.00	40.94	5.41	46.35	54.00	-7.65	AVG	

REMARKS:

- (1) Measurement Value = Reading Level + Correct Factor.
- (2) Margin Level = Measurement Value - Limit Value.

Test Mode	IEEE802.11n (HT20)	Test Date	2021/3/6
Test Frequency	5300MHz	Polarization	Horizontal
Temp	22°C	Hum.	66%

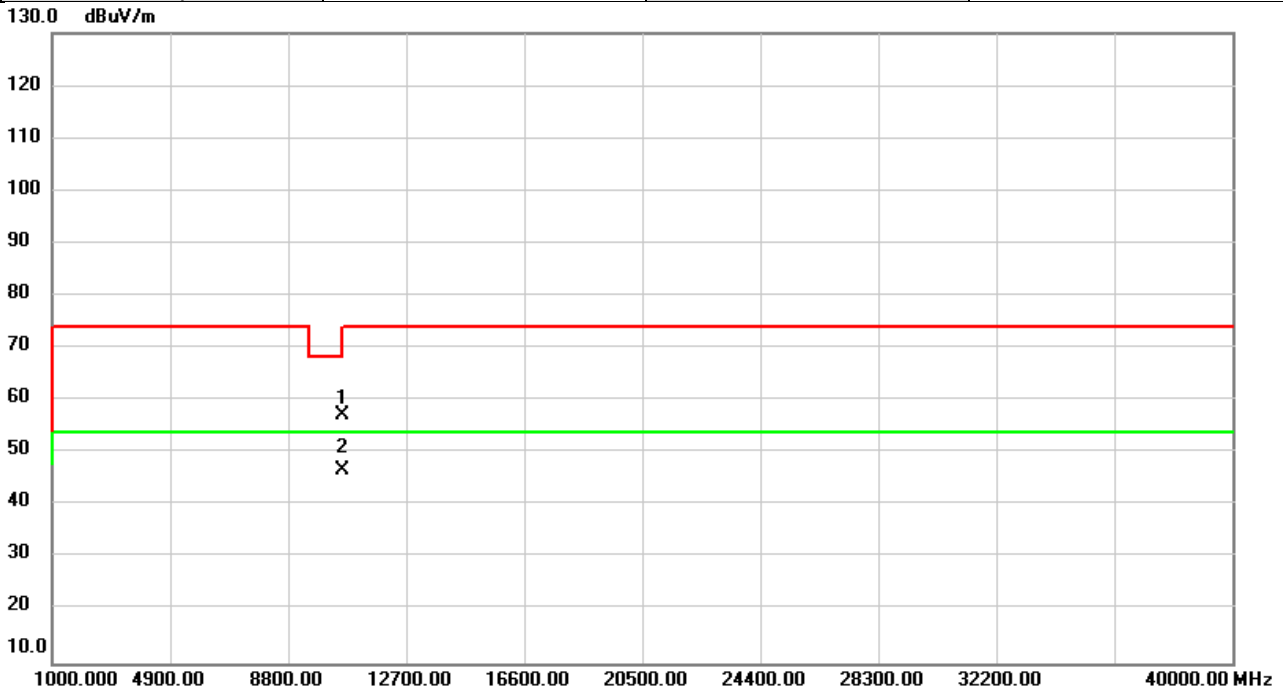

No.	Mk.	Freq.	Reading Level	Correct Factor	Measurement	Limit	Over	Detector	Comment
		MHz	dBuV	dB	dBuV/m	dBuV/m	dB		
1		10600.00	51.81	5.41	57.22	68.20	-10.98	peak	
2	*	10600.00	41.19	5.41	46.60	54.00	-7.40	AVG	

REMARKS:

- (1) Measurement Value = Reading Level + Correct Factor.
- (2) Margin Level = Measurement Value - Limit Value.

Test Mode	IEEE802.11n (HT20)	Test Date	2021/3/6
Test Frequency	5320MHz	Polarization	Vertical
Temp	22°C	Hum.	66%

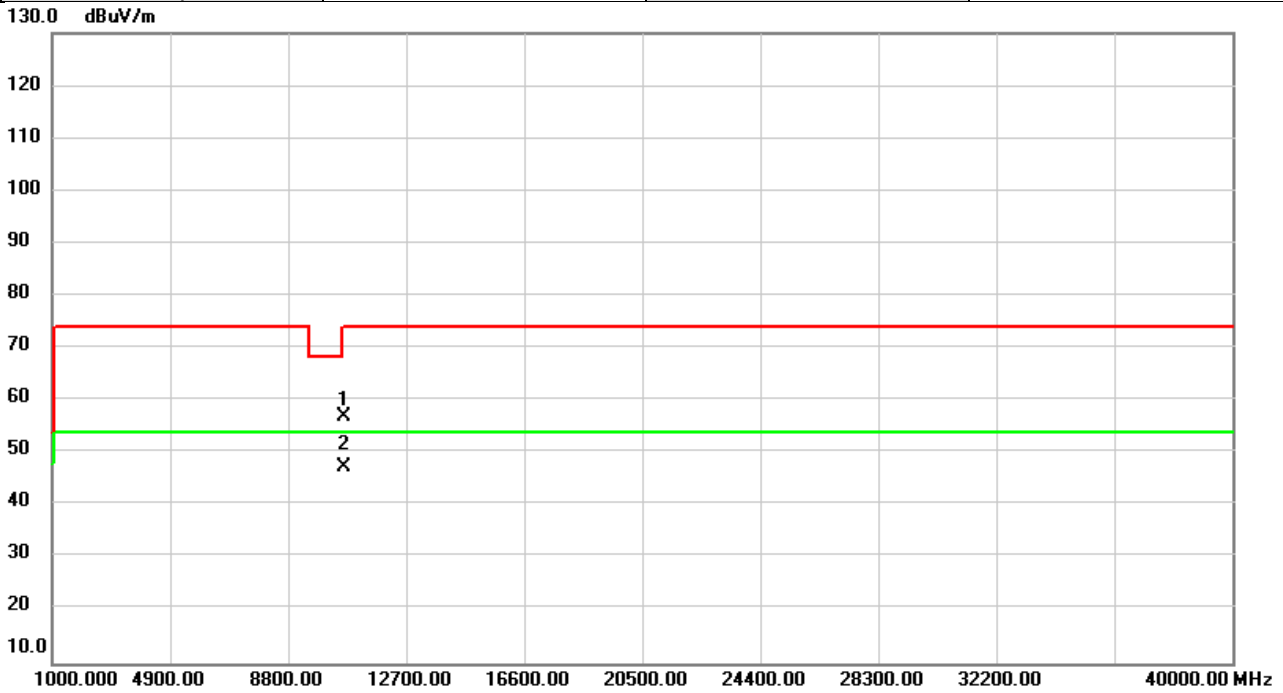

No.	Mk.	Freq.	Reading Level	Correct Factor	Measurement	Limit	Over	Detector	Comment
		MHz	dBuV	dB	dBuV/m	dBuV/m	dB		
1		10640.00	51.41	5.49	56.90	74.00	-17.10	peak	
2	*	10640.00	41.82	5.49	47.31	54.00	-6.69	AVG	

REMARKS:

- (1) Measurement Value = Reading Level + Correct Factor.
- (2) Margin Level = Measurement Value - Limit Value.

Test Mode	IEEE802.11n (HT20)	Test Date	2021/3/6
Test Frequency	5320MHz	Polarization	Horizontal
Temp	22°C	Hum.	66%

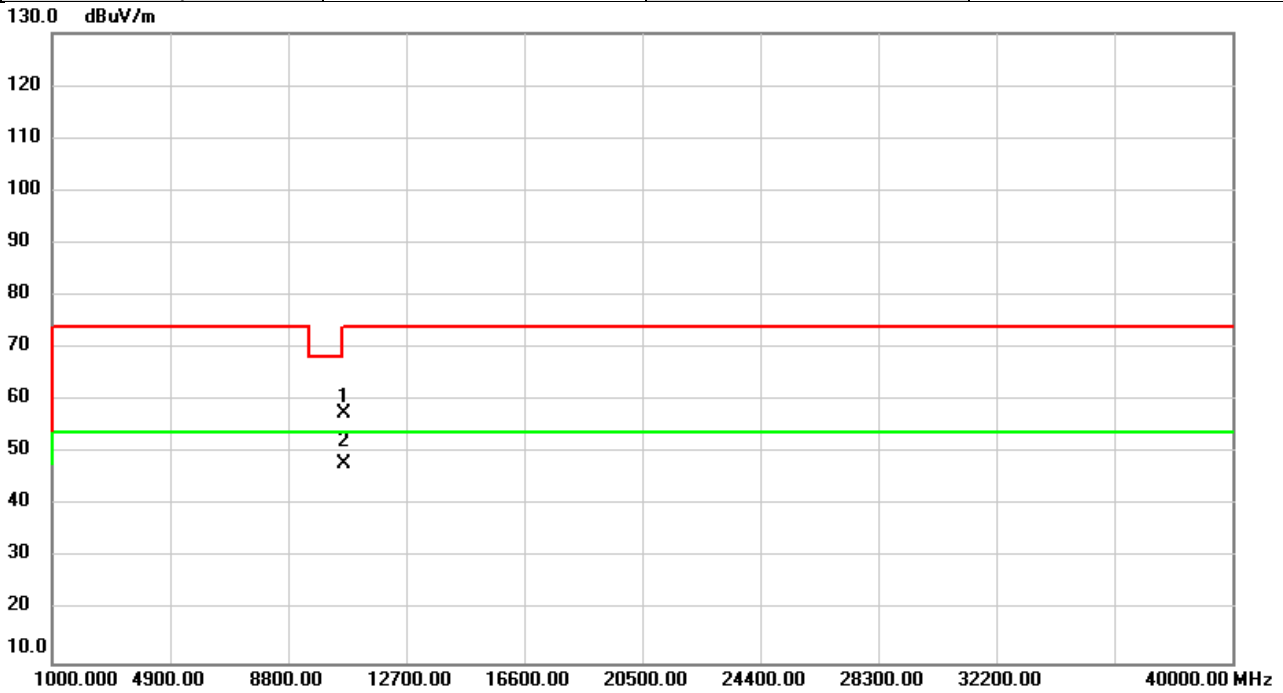

No.	Mk.	Freq.	Reading Level	Correct Factor	Measurement	Limit	Over	Detector	Comment
		MHz	dBuV	dB	dBuV/m	dBuV/m	dB		
1		10640.00	52.10	5.49	57.59	74.00	-16.41	peak	
2	*	10640.00	42.44	5.49	47.93	54.00	-6.07	AVG	

REMARKS:

- (1) Measurement Value = Reading Level + Correct Factor.
- (2) Margin Level = Measurement Value - Limit Value.

Test Mode	IEEE802.11n (HT20)	Test Date	2021/3/6
Test Frequency	5500MHz	Polarization	Vertical
Temp	22°C	Hum.	66%

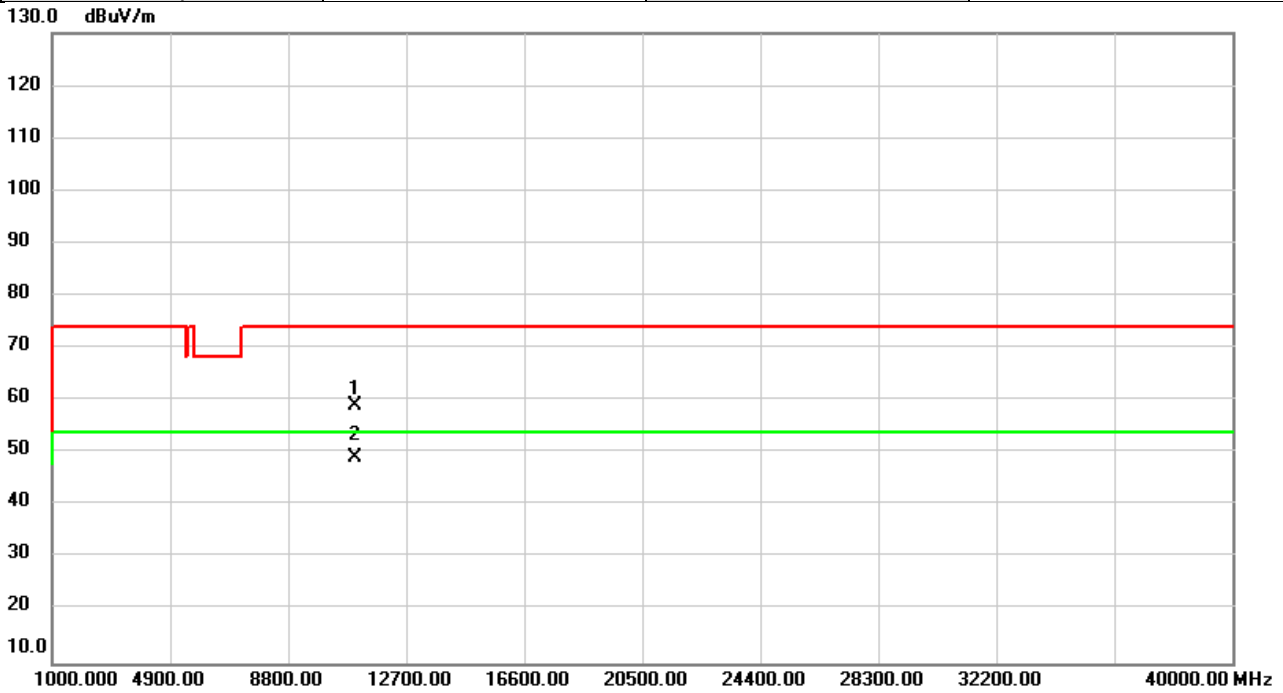

No.	Mk.	Freq.	Reading Level	Correct Factor	Measurement	Limit	Over	Detector	Comment
		MHz	dBuV	dB	dBuV/m	dBuV/m	dB		
1		11000.00	52.85	6.24	59.09	74.00	-14.91	peak	
2	*	11000.00	42.77	6.24	49.01	54.00	-4.99	AVG	

REMARKS:

- (1) Measurement Value = Reading Level + Correct Factor.
- (2) Margin Level = Measurement Value - Limit Value.

Test Mode	IEEE802.11n (HT20)	Test Date	2021/3/6
Test Frequency	5500MHz	Polarization	Horizontal
Temp	22°C	Hum.	66%

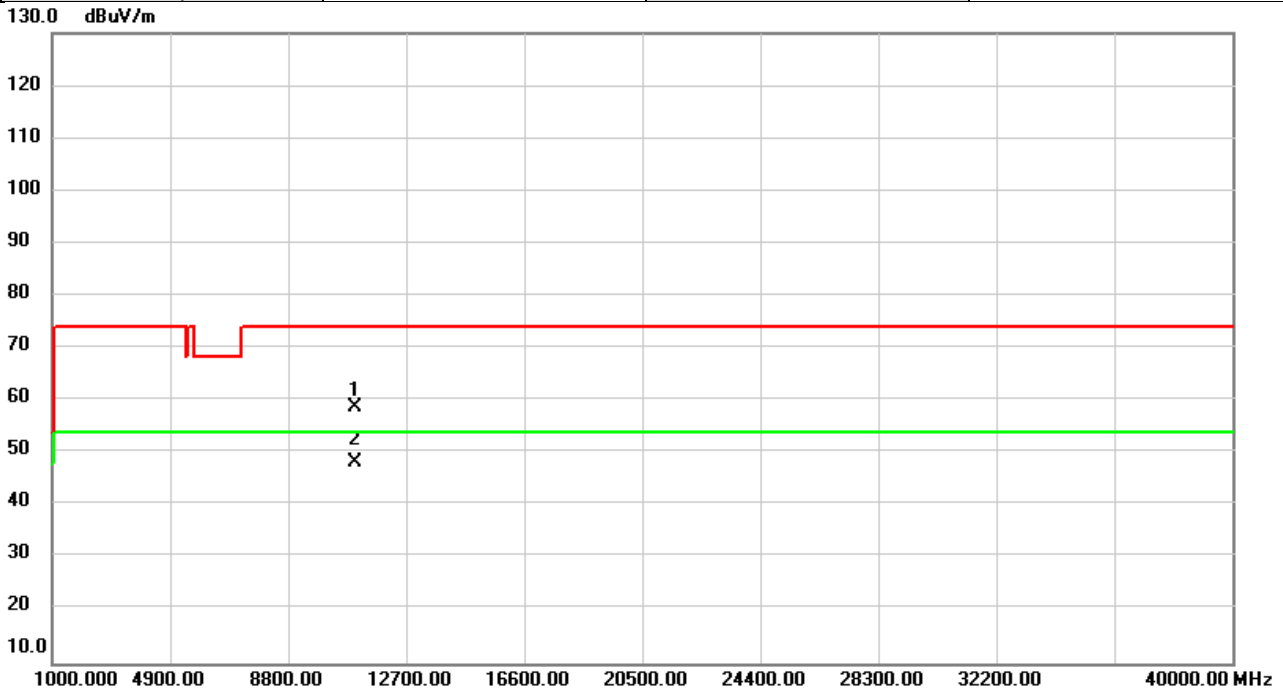

No.	Mk.	Freq.	Reading Level	Correct Factor	Measurement	Limit	Over	Detector	Comment
		MHz	dBuV	dB	dBuV/m	dBuV/m	dB		
1		11000.00	52.42	6.24	58.66	74.00	-15.34	peak	
2	*	11000.00	41.88	6.24	48.12	54.00	-5.88	AVG	

REMARKS:

- (1) Measurement Value = Reading Level + Correct Factor.
- (2) Margin Level = Measurement Value - Limit Value.

Test Mode	IEEE802.11n (HT20)	Test Date	2021/3/6
Test Frequency	5580MHz	Polarization	Vertical
Temp	22°C	Hum.	66%

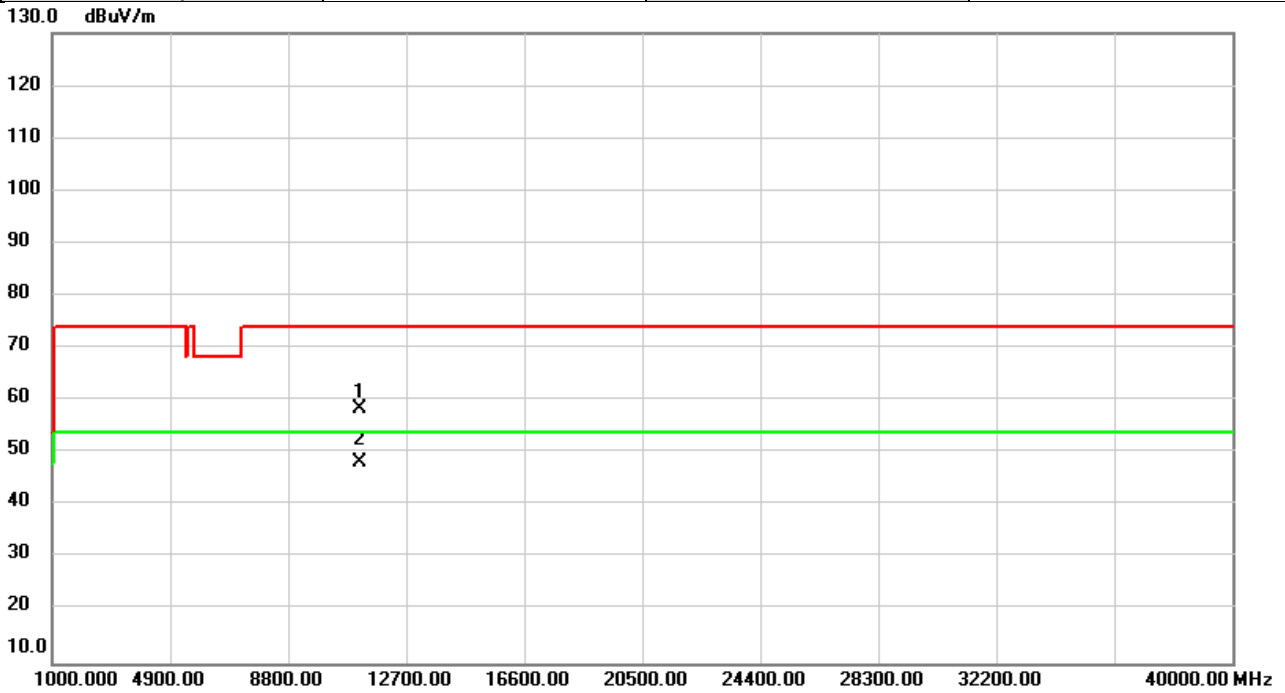

No.	Mk.	Freq.	Reading Level	Correct Factor	Measurement	Limit	Over	Detector	Comment
		MHz	dBuV	dB	dBuV/m	dBuV/m	dB		
1		11160.00	52.72	5.85	58.57	74.00	-15.43	peak	
2	*	11160.00	42.33	5.85	48.18	54.00	-5.82	AVG	

REMARKS:

- (1) Measurement Value = Reading Level + Correct Factor.
- (2) Margin Level = Measurement Value - Limit Value.

Test Mode	IEEE802.11n (HT20)	Test Date	2021/3/6
Test Frequency	5580MHz	Polarization	Horizontal
Temp	22°C	Hum.	66%

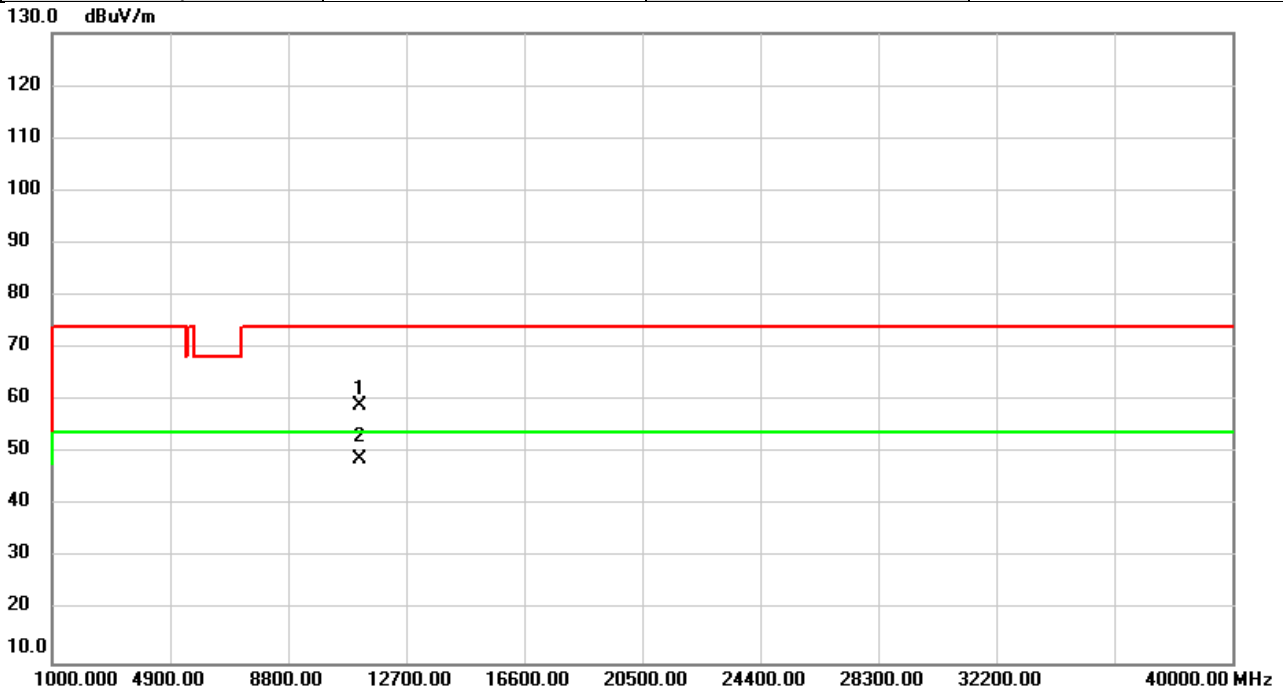

No.	Mk.	Freq.	Reading Level	Correct Factor	Measurement	Limit	Over	Detector	Comment
		MHz	dBuV	dB	dBuV/m	dBuV/m	dB		
1		11160.00	53.31	5.85	59.16	74.00	-14.84	peak	
2	*	11160.00	43.08	5.85	48.93	54.00	-5.07	AVG	

REMARKS:

- (1) Measurement Value = Reading Level + Correct Factor.
- (2) Margin Level = Measurement Value - Limit Value.

Test Mode	IEEE802.11n (HT20)	Test Date	2021/3/6
Test Frequency	5700MHz	Polarization	Vertical
Temp	22°C	Hum.	66%

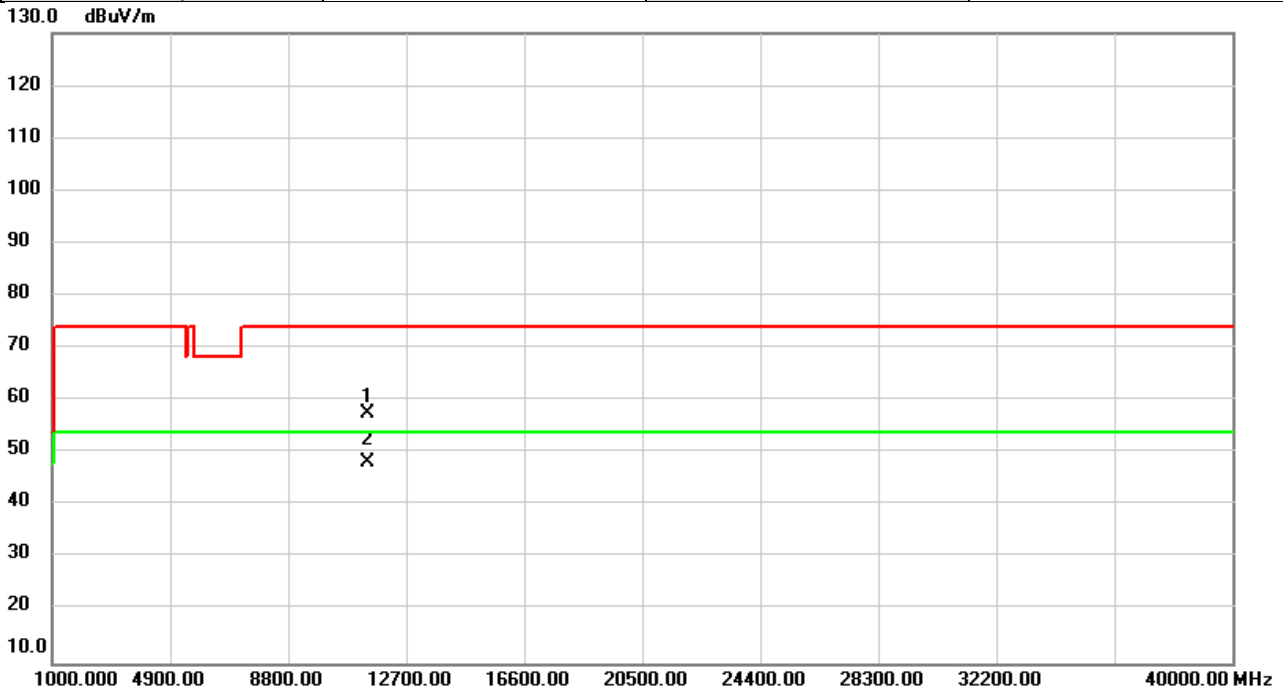

No.	Mk.	Freq.	Reading Level	Correct Factor	Measurement	Limit	Over	Detector	Comment
		MHz	dBuV	dB	dBuV/m	dBuV/m	dB		
1		11400.00	52.32	5.27	57.59	74.00	-16.41	peak	
2	*	11400.00	42.85	5.27	48.12	54.00	-5.88	AVG	

REMARKS:

- (1) Measurement Value = Reading Level + Correct Factor.
- (2) Margin Level = Measurement Value - Limit Value.

Test Mode	IEEE802.11n (HT20)	Test Date	2021/3/6
Test Frequency	5700MHz	Polarization	Horizontal
Temp	22°C	Hum.	66%

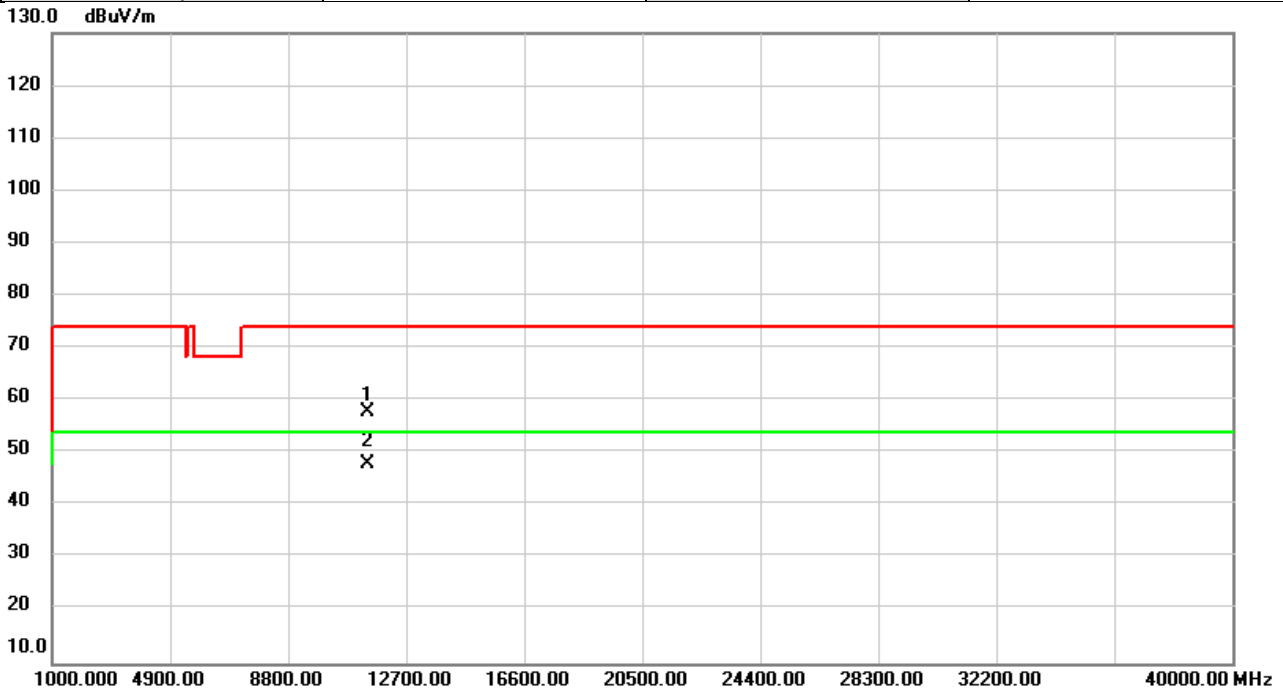

No.	Mk.	Freq.	Reading Level	Correct Factor	Measurement	Limit	Over	Detector	Comment
		MHz	dBuV	dB	dBuV/m	dBuV/m	dB		
1		11400.00	52.55	5.27	57.82	74.00	-16.18	peak	
2	*	11400.00	42.79	5.27	48.06	54.00	-5.94	AVG	

REMARKS:

- (1) Measurement Value = Reading Level + Correct Factor.
- (2) Margin Level = Measurement Value - Limit Value.

Test Mode	IEEE802.11n (HT20)	Test Date	2021/3/6
Test Frequency	5745MHz	Polarization	Vertical
Temp	22°C	Hum.	66%

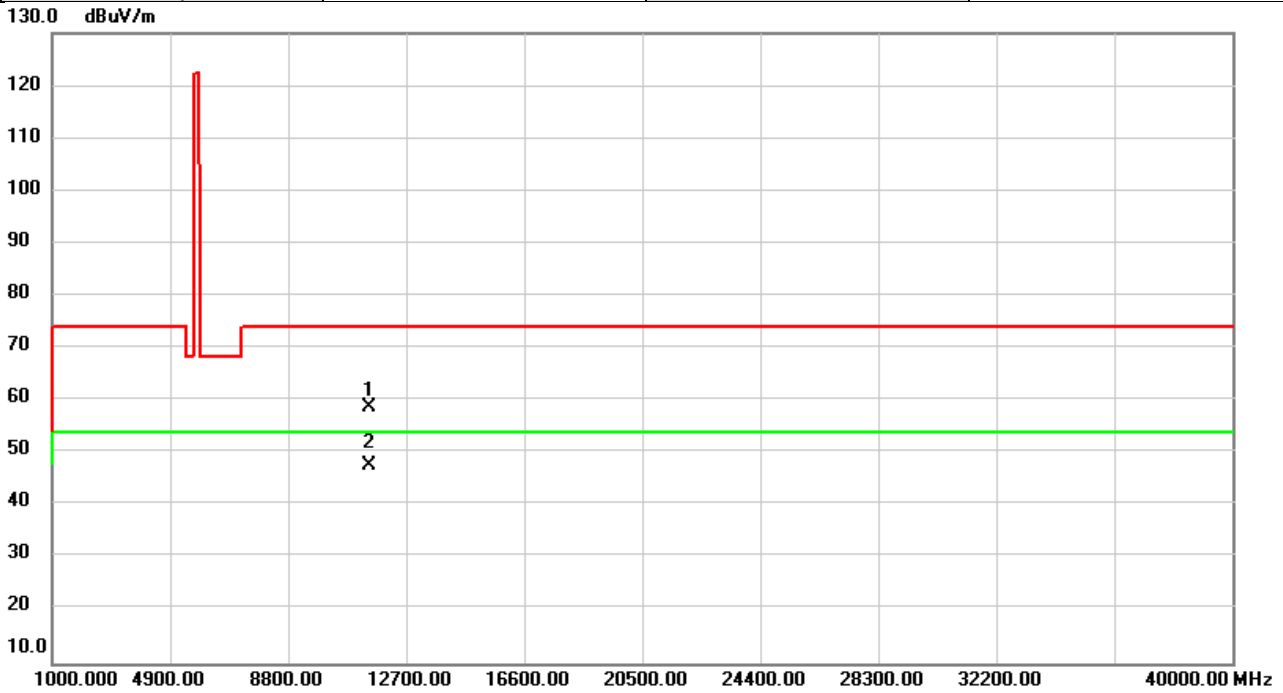

No.	Mk.	Freq.	Reading Level	Correct Factor	Measurement	Limit	Over	Detector	Comment
		MHz	dBuV	dB	dBuV/m	dBuV/m	dB		
1		11490.00	53.82	5.05	58.87	74.00	-15.13	peak	
2	*	11490.00	42.46	5.05	47.51	54.00	-6.49	AVG	

REMARKS:

- (1) Measurement Value = Reading Level + Correct Factor.
- (2) Margin Level = Measurement Value - Limit Value.

Test Mode	IEEE802.11n (HT20)	Test Date	2021/3/6
Test Frequency	5745MHz	Polarization	Horizontal
Temp	22°C	Hum.	66%

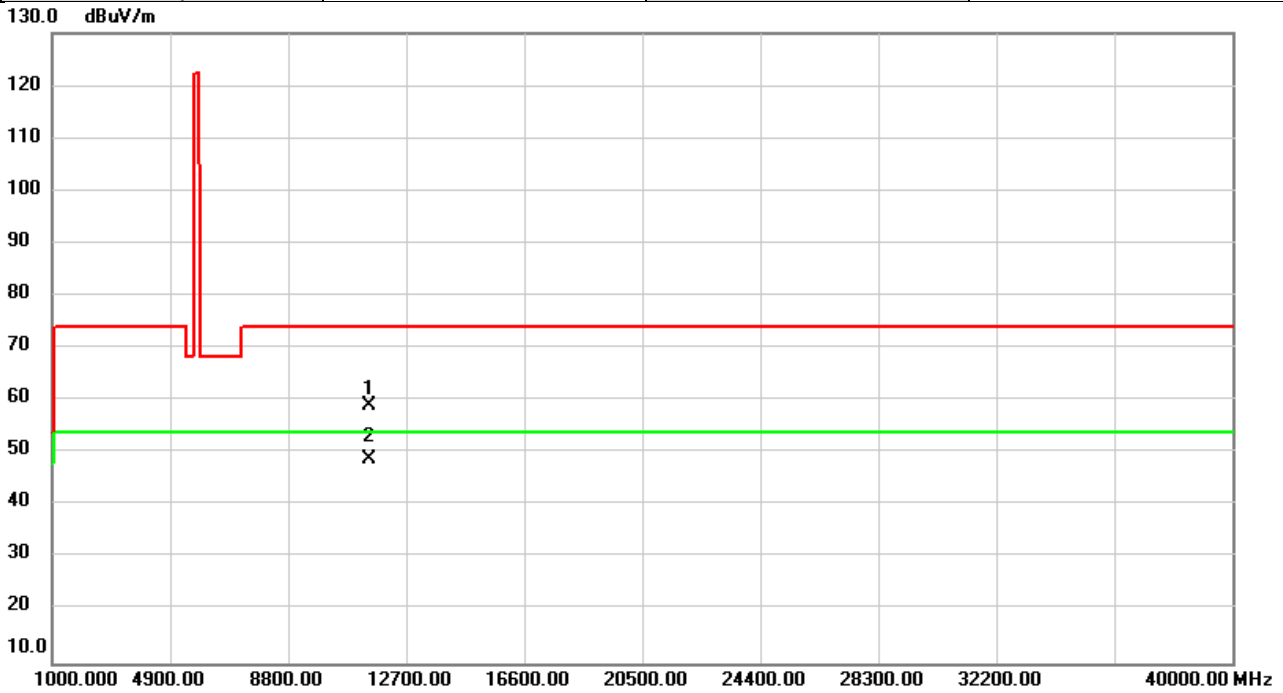

No.	Mk.	Freq.	Reading Level	Correct Factor	Measurement	Limit	Over	Detector	Comment
		MHz	dBuV	dB	dBuV/m	dBuV/m	dB		
1		11490.00	53.88	5.05	58.93	74.00	-15.07	peak	
2	*	11490.00	43.66	5.05	48.71	54.00	-5.29	AVG	

REMARKS:

- (1) Measurement Value = Reading Level + Correct Factor.
- (2) Margin Level = Measurement Value - Limit Value.

Test Mode	IEEE802.11n (HT20)	Test Date	2021/3/6
Test Frequency	5785MHz	Polarization	Vertical
Temp	22°C	Hum.	66%

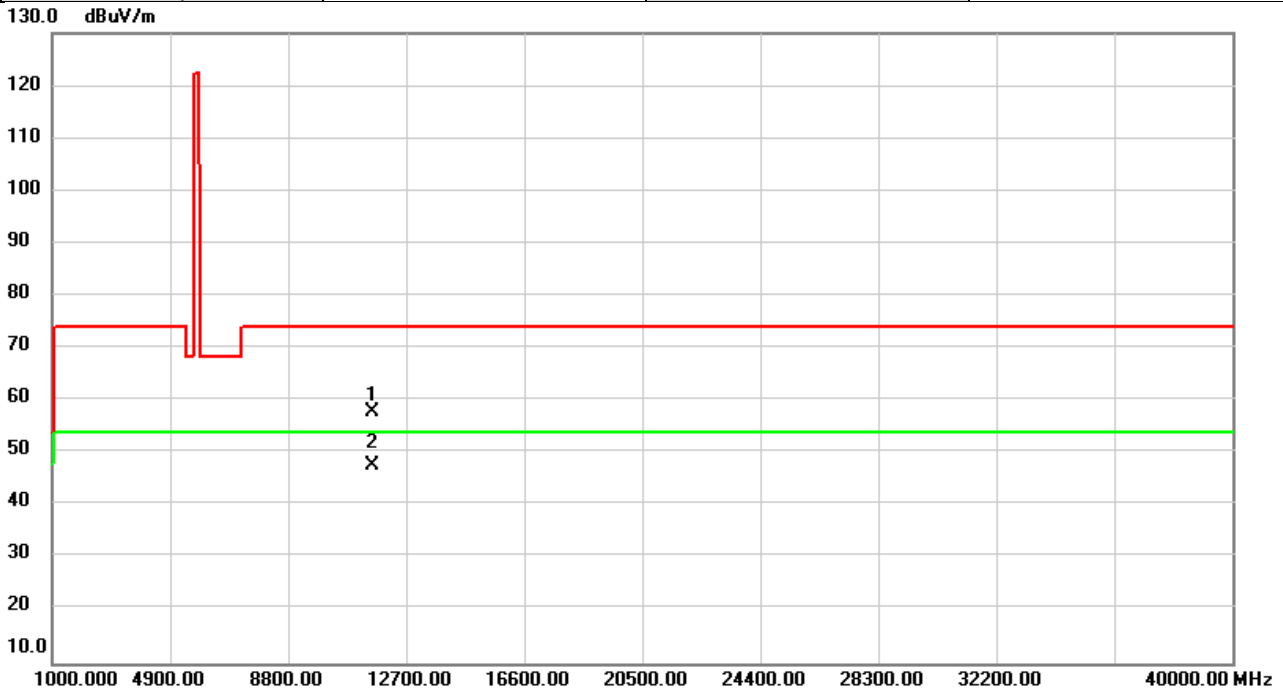

No.	Mk.	Freq.	Reading Level	Correct Factor	Measurement	Limit	Over	Detector	Comment
		MHz	dBuV	dB	dBuV/m	dBuV/m	dB		
1		11570.00	53.10	4.87	57.97	74.00	-16.03	peak	
2	*	11570.00	42.66	4.87	47.53	54.00	-6.47	AVG	

REMARKS:

- (1) Measurement Value = Reading Level + Correct Factor.
- (2) Margin Level = Measurement Value - Limit Value.

Test Mode	IEEE802.11n (HT20)	Test Date	2021/3/6
Test Frequency	5785MHz	Polarization	Horizontal
Temp	22°C	Hum.	66%

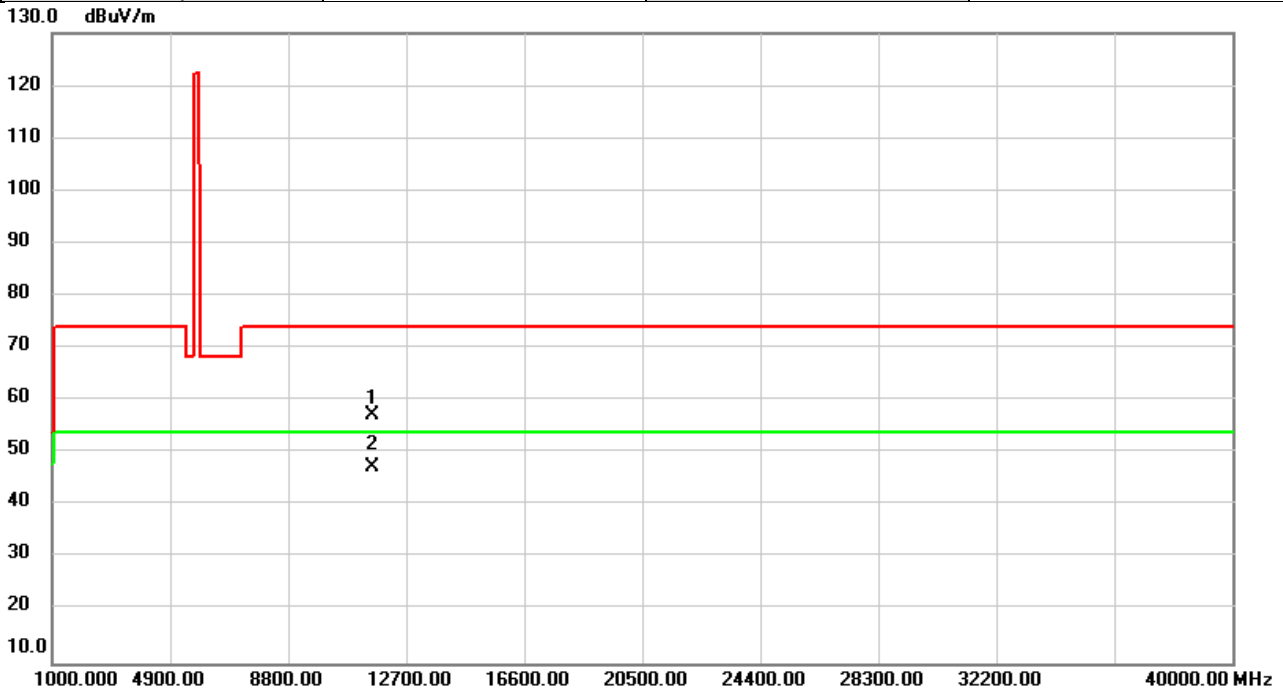

No.	Mk.	Freq.	Reading Level	Correct Factor	Measurement	Limit	Over	Detector	Comment
		MHz	dBuV	dB	dBuV/m	dBuV/m	dB		
1		11570.00	52.49	4.87	57.36	74.00	-16.64	peak	
2	*	11570.00	42.39	4.87	47.26	54.00	-6.74	AVG	

REMARKS:

- (1) Measurement Value = Reading Level + Correct Factor.
- (2) Margin Level = Measurement Value - Limit Value.

Test Mode	IEEE802.11n (HT20)	Test Date	2021/3/6
Test Frequency	5825MHz	Polarization	Vertical
Temp	22°C	Hum.	66%

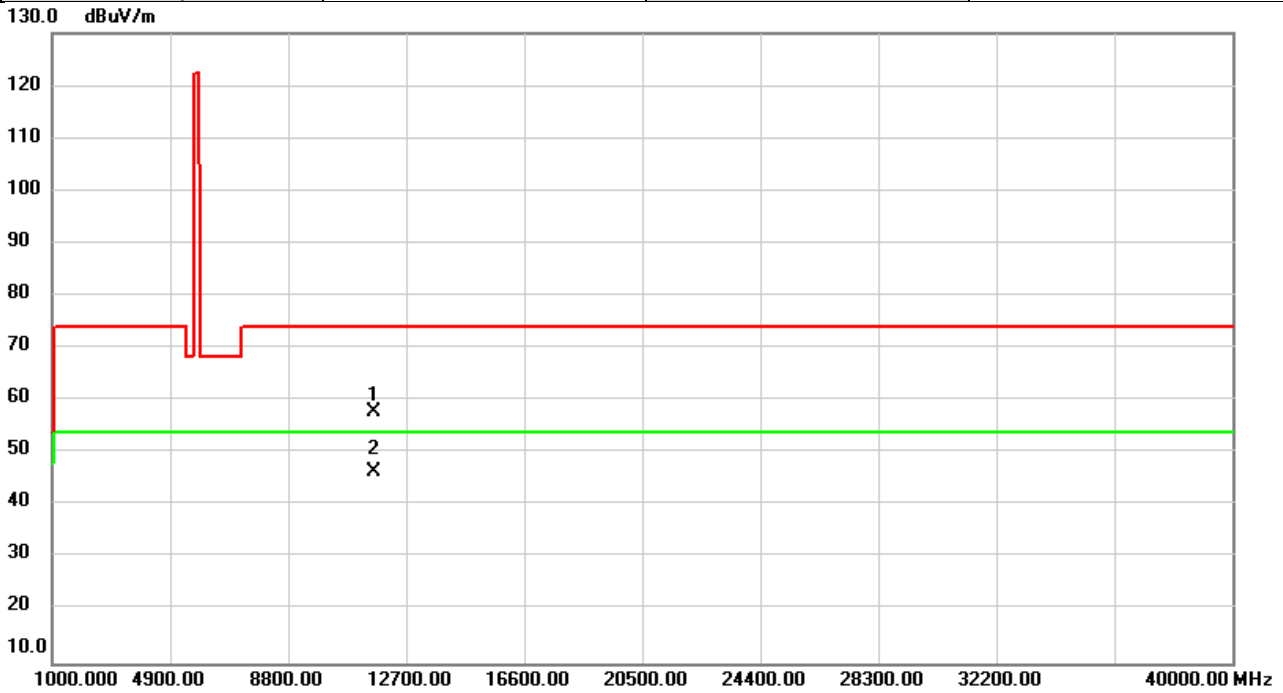

No.	Mk.	Freq.	Reading Level	Correct Factor	Measurement	Limit	Over	Detector	Comment
		MHz	dBuV	dB	dBuV/m	dBuV/m	dB		
1		11650.00	53.23	4.69	57.92	74.00	-16.08	peak	
2	*	11650.00	41.89	4.69	46.58	54.00	-7.42	AVG	

REMARKS:

- (1) Measurement Value = Reading Level + Correct Factor.
- (2) Margin Level = Measurement Value - Limit Value.

Test Mode	IEEE802.11n (HT20)	Test Date	2021/3/6
Test Frequency	5825MHz	Polarization	Horizontal
Temp	22°C	Hum.	66%

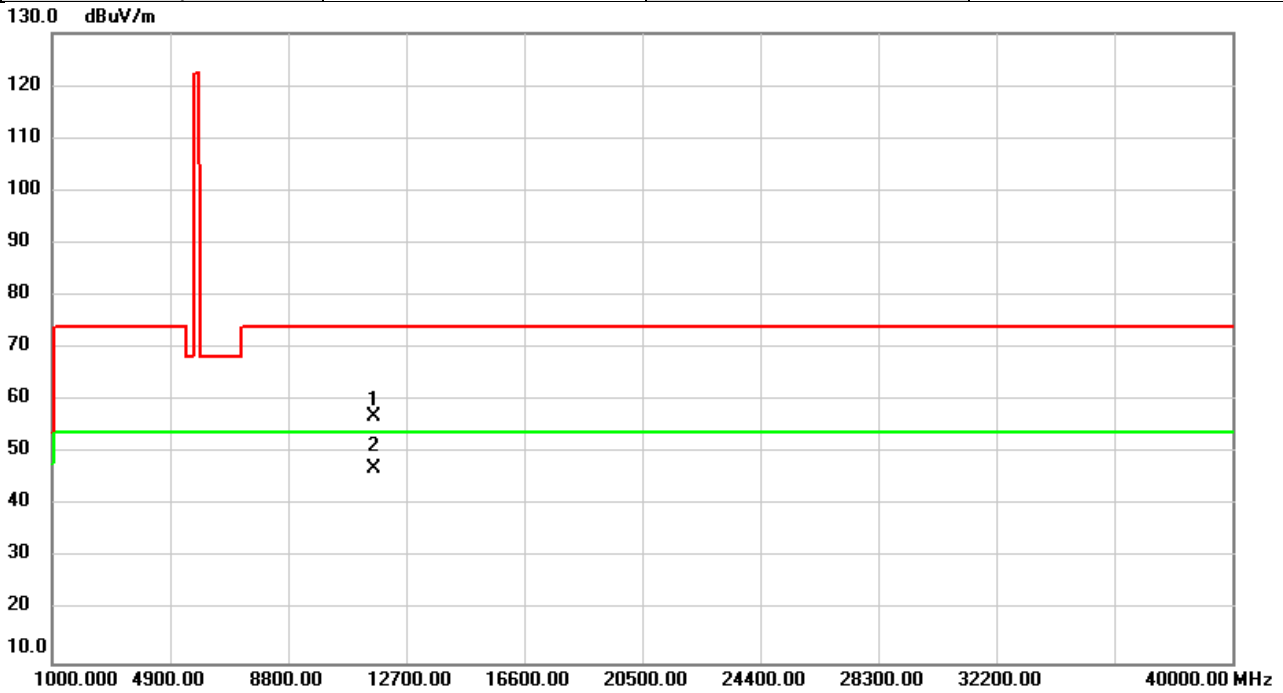

No.	Mk.	Freq.	Reading Level	Correct Factor	Measurement	Limit	Over	Detector	Comment
		MHz	dBuV	dB	dBuV/m	dBuV/m	dB		
1		11650.00	52.41	4.69	57.10	74.00	-16.90	peak	
2	*	11650.00	42.33	4.69	47.02	54.00	-6.98	AVG	

REMARKS:

- (1) Measurement Value = Reading Level + Correct Factor.
- (2) Margin Level = Measurement Value - Limit Value.

Test Mode	IEEE802.11n (HT40)	Test Date	2021/3/6
Test Frequency	5190MHz	Polarization	Vertical
Temp	22°C	Hum.	66%

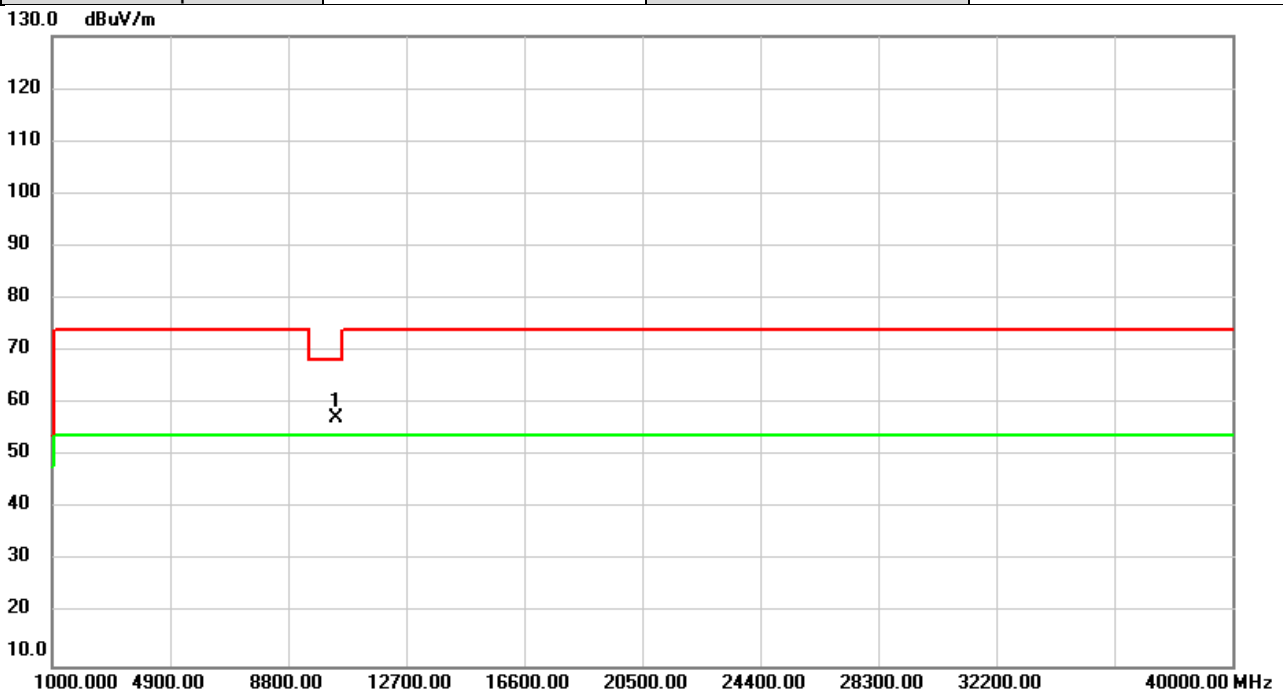

No.	Mk.	Freq.	Reading Level	Correct Factor	Measurement	Limit	Over	Detector	Comment
		MHz	dBuV	dB	dBuV/m	dBuV/m	dB		
1	*	10380.00	52.34	4.89	57.23	68.20	-10.97	peak	

REMARKS:

- (1) Measurement Value = Reading Level + Correct Factor.
- (2) Margin Level = Measurement Value - Limit Value.

Test Mode	IEEE802.11n (HT40)	Test Date	2021/3/6
Test Frequency	5190MHz	Polarization	Horizontal
Temp	22°C	Hum.	66%

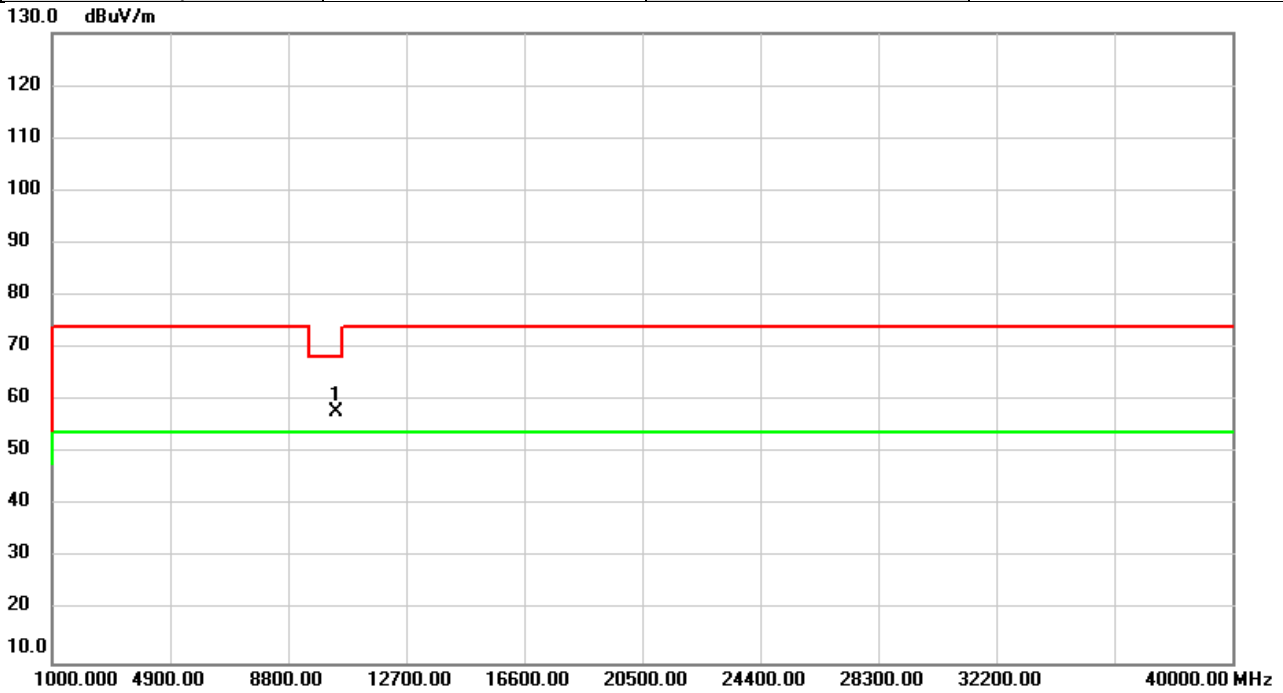

No.	Mk.	Freq.	Reading Level	Correct Factor	Measurement	Limit	Over	Detector	Comment
		MHz	dBuV	dB	dBuV/m	dBuV/m	dB		
1	*	10380.00	52.90	4.89	57.79	68.20	-10.41	peak	

REMARKS:

- (1) Measurement Value = Reading Level + Correct Factor.
- (2) Margin Level = Measurement Value - Limit Value.

Test Mode	IEEE802.11n (HT40)	Test Date	2021/3/6
Test Frequency	5230MHz	Polarization	Vertical
Temp	22°C	Hum.	66%

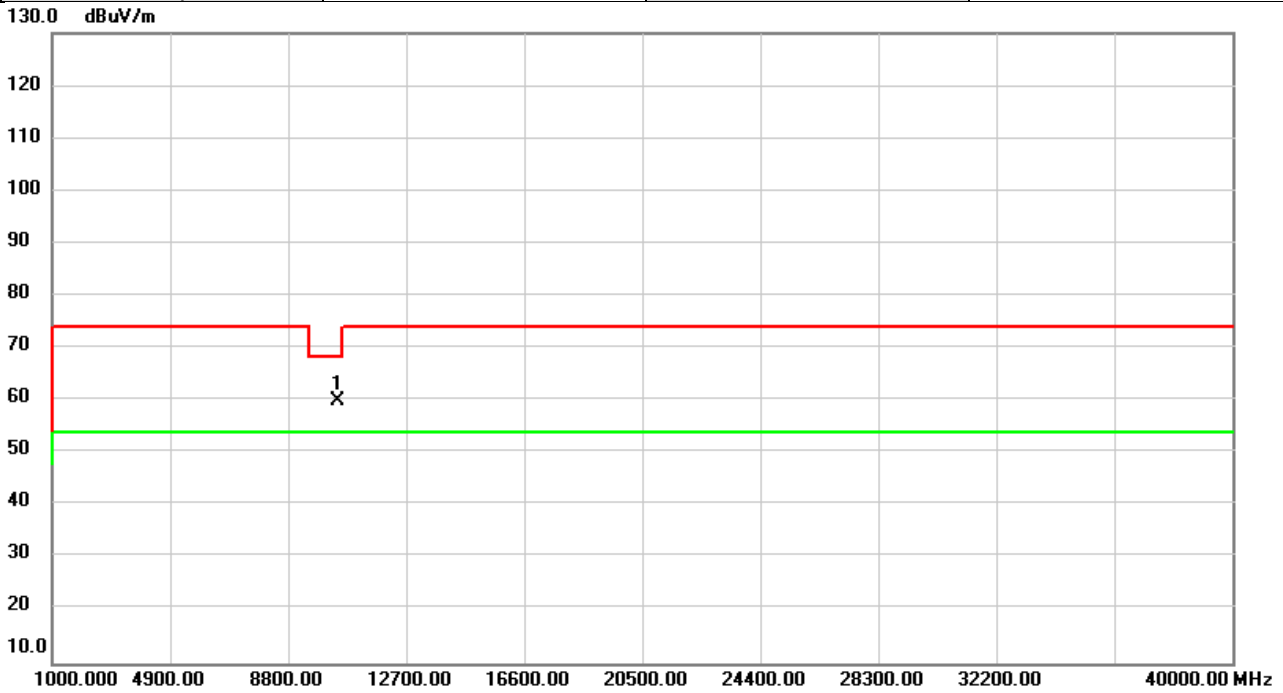

No.	Mk.	Freq.	Reading Level	Correct Factor	Measurement	Limit	Over	Detector	Comment
		MHz	dBuV	dB	dBuV/m	dBuV/m	dB		
1	*	10460.00	54.82	5.10	59.92	68.20	-8.28	peak	

REMARKS:

- (1) Measurement Value = Reading Level + Correct Factor.
- (2) Margin Level = Measurement Value - Limit Value.

Test Mode	IEEE802.11n (HT40)	Test Date	2021/3/6
Test Frequency	5230MHz	Polarization	Horizontal
Temp	22°C	Hum.	66%

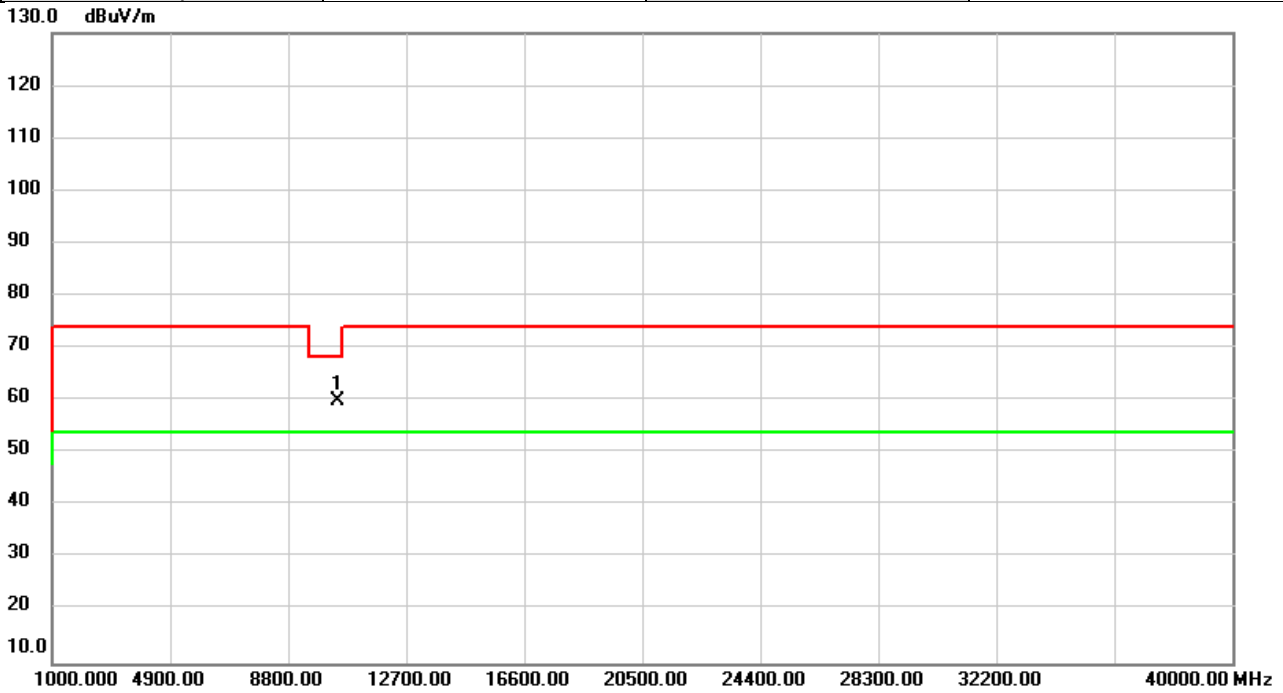

No.	Mk.	Freq.	Reading Level	Correct Factor	Measurement	Limit	Over	Detector	Comment
		MHz	dBuV	dB	dBuV/m	dBuV/m	dB		
1	*	10460.00	54.82	5.10	59.92	68.20	-8.28	peak	

REMARKS:

- (1) Measurement Value = Reading Level + Correct Factor.
- (2) Margin Level = Measurement Value - Limit Value.

Test Mode	IEEE802.11n (HT40)	Test Date	2021/3/6
Test Frequency	5270MHz	Polarization	Vertical
Temp	22°C	Hum.	66%

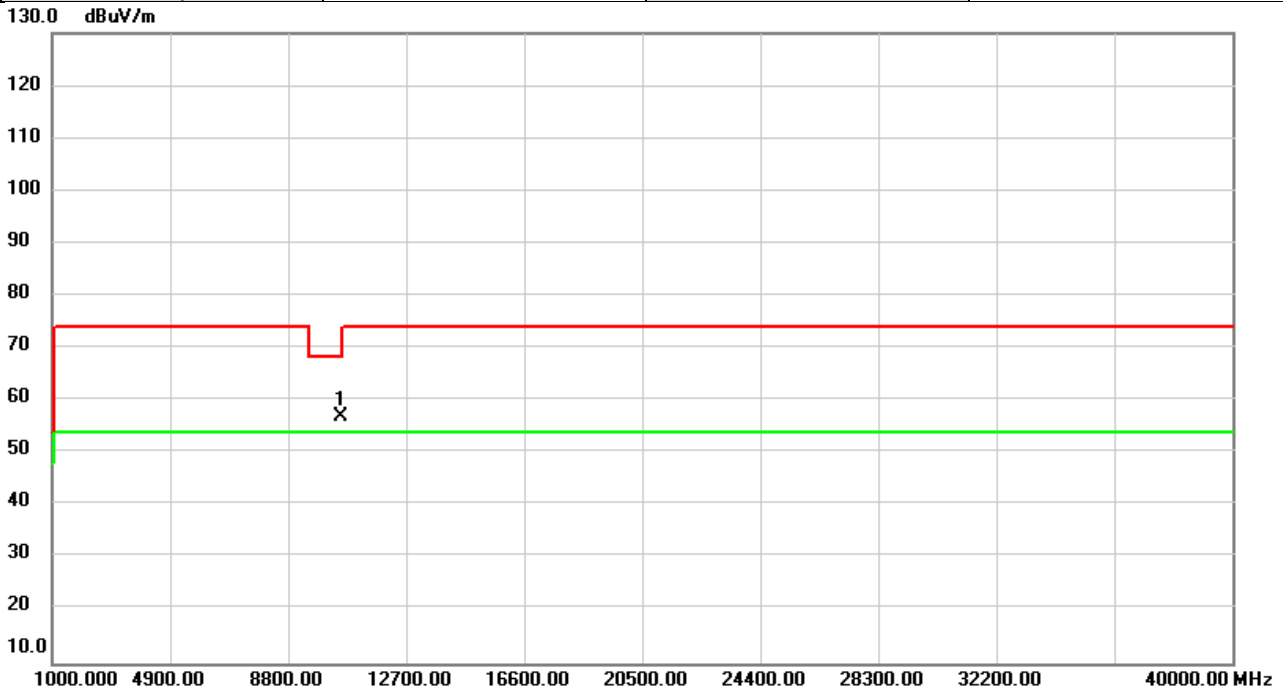

No.	Mk.	Freq.	Reading Level	Correct Factor	Measurement	Limit	Over	Detector	Comment
		MHz	dBuV	dB	dBuV/m	dBuV/m	dB		
1	*	10540.00	51.81	5.28	57.09	68.20	-11.11	peak	

REMARKS:

- (1) Measurement Value = Reading Level + Correct Factor.
- (2) Margin Level = Measurement Value - Limit Value.

Test Mode	IEEE802.11n (HT40)	Test Date	2021/3/6
Test Frequency	5270MHz	Polarization	Horizontal
Temp	22°C	Hum.	66%

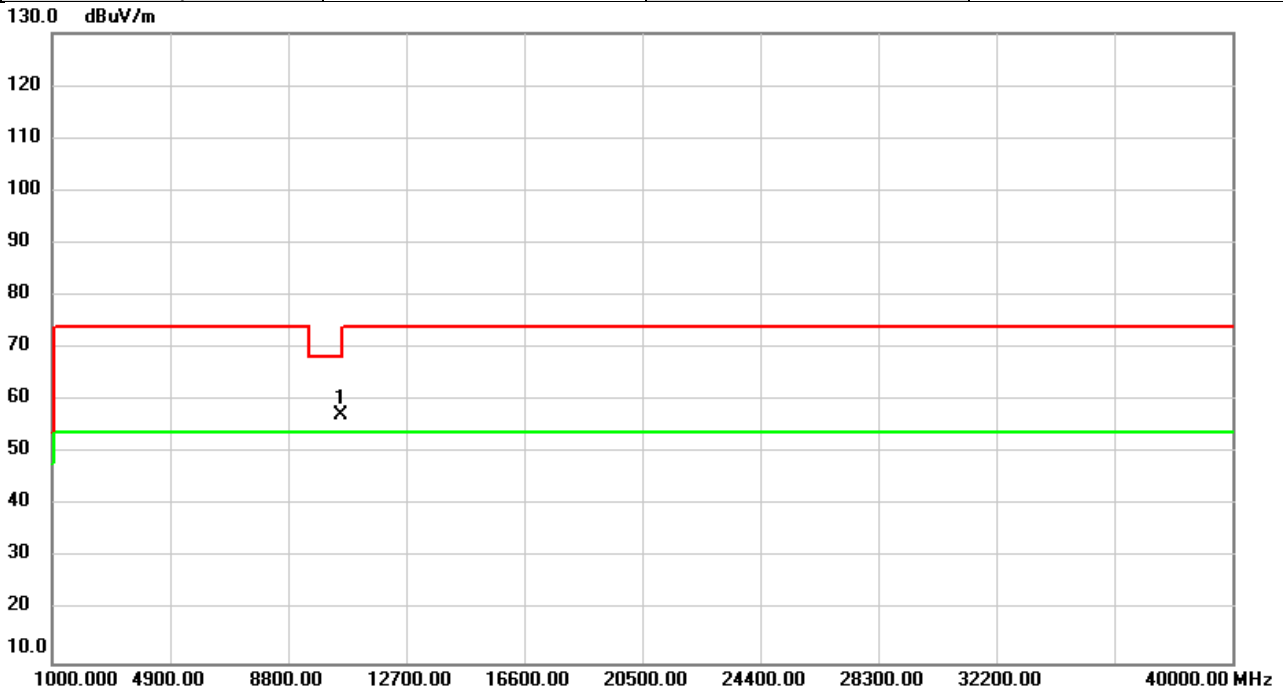

No.	Mk.	Freq.	Reading Level	Correct Factor	Measurement	Limit	Over	Detector	Comment
		MHz	dBuV	dB	dBuV/m	dBuV/m	dB		
1	*	10540.00	51.92	5.28	57.20	68.20	-11.00	peak	

REMARKS:

- (1) Measurement Value = Reading Level + Correct Factor.
- (2) Margin Level = Measurement Value - Limit Value.

Test Mode	IEEE802.11n (HT40)	Test Date	2021/3/6
Test Frequency	5310MHz	Polarization	Vertical
Temp	22°C	Hum.	66%

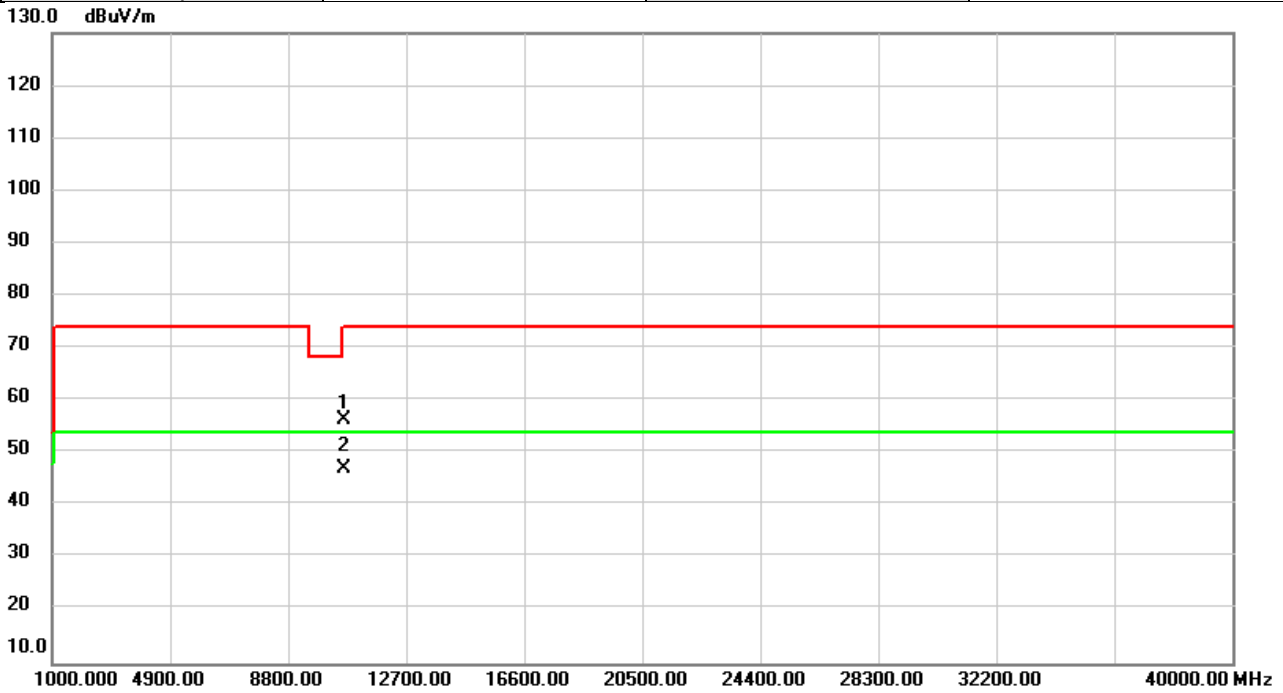

No.	Mk.	Freq.	Reading Level	Correct Factor	Measurement	Limit	Over	Detector	Comment
		MHz	dBuV	dB	dBuV/m	dBuV/m	dB		
1		10620.00	50.98	5.45	56.43	74.00	-17.57	peak	
2	*	10620.00	41.55	5.45	47.00	54.00	-7.00	AVG	

REMARKS:

- (1) Measurement Value = Reading Level + Correct Factor.
- (2) Margin Level = Measurement Value - Limit Value.

Test Mode	IEEE802.11n (HT40)	Test Date	2021/3/6
Test Frequency	5310MHz	Polarization	Horizontal
Temp	22°C	Hum.	66%

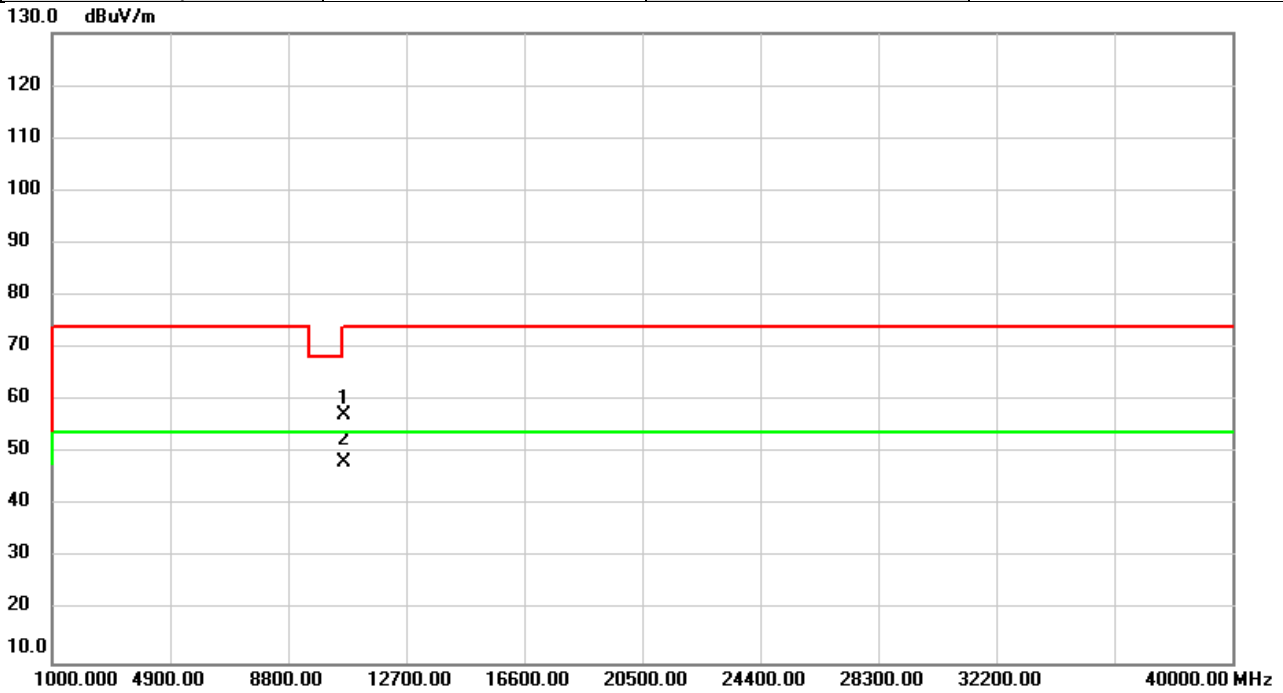

No.	Mk.	Freq.	Reading Level	Correct Factor	Measurement	Limit	Over	Detector	Comment
		MHz	dBuV	dB	dBuV/m	dBuV/m	dB		
1		10620.00	51.86	5.45	57.31	74.00	-16.69	peak	
2	*	10620.00	42.69	5.45	48.14	54.00	-5.86	AVG	

REMARKS:

- (1) Measurement Value = Reading Level + Correct Factor.
- (2) Margin Level = Measurement Value - Limit Value.

Test Mode	IEEE802.11n (HT40)	Test Date	2021/3/6
Test Frequency	5510MHz	Polarization	Vertical
Temp	22°C	Hum.	66%

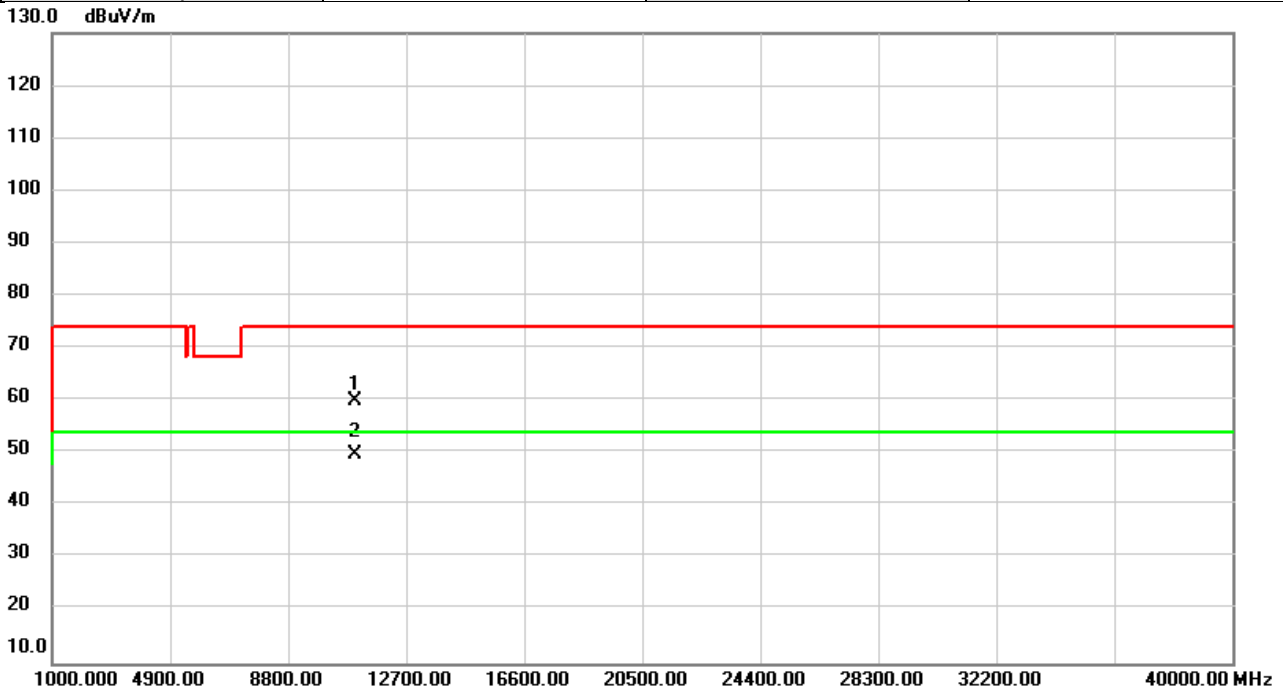

No.	Mk.	Freq.	Reading Level	Correct Factor	Measurement	Limit	Over	Detector	Comment
		MHz	dBuV	dB	dBuV/m	dBuV/m	dB		
1		11020.00	53.82	6.20	60.02	74.00	-13.98	peak	
2	*	11020.00	43.70	6.20	49.90	54.00	-4.10	AVG	

REMARKS:

- (1) Measurement Value = Reading Level + Correct Factor.
- (2) Margin Level = Measurement Value - Limit Value.

Test Mode	IEEE802.11n (HT40)	Test Date	2021/3/6
Test Frequency	5510MHz	Polarization	Horizontal
Temp	22°C	Hum.	66%

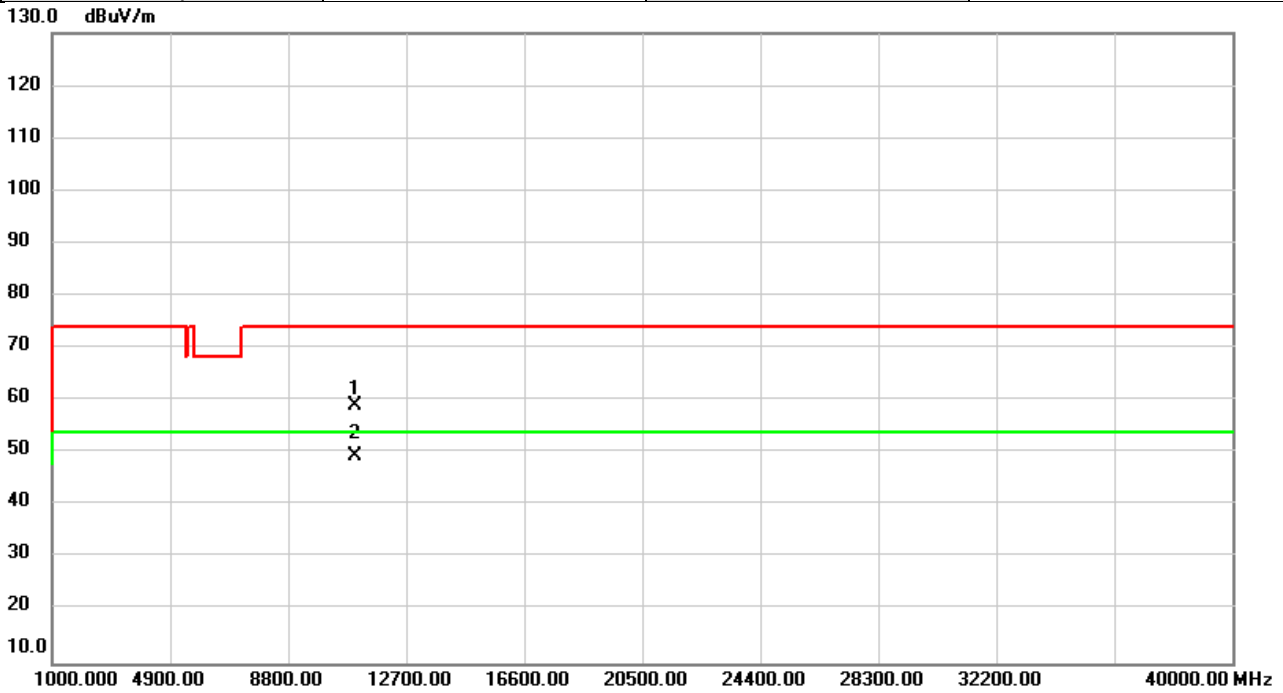

No.	Mk.	Freq.	Reading Level	Correct Factor	Measurement	Limit	Over	Detector	Comment
		MHz	dBuV	dB	dBuV/m	dBuV/m	dB		
1		11020.00	52.77	6.20	58.97	74.00	-15.03	peak	
2	*	11020.00	43.33	6.20	49.53	54.00	-4.47	AVG	

REMARKS:

- (1) Measurement Value = Reading Level + Correct Factor.
- (2) Margin Level = Measurement Value - Limit Value.

Test Mode	IEEE802.11n (HT40)	Test Date	2021/3/6
Test Frequency	5550MHz	Polarization	Vertical
Temp	22°C	Hum.	66%

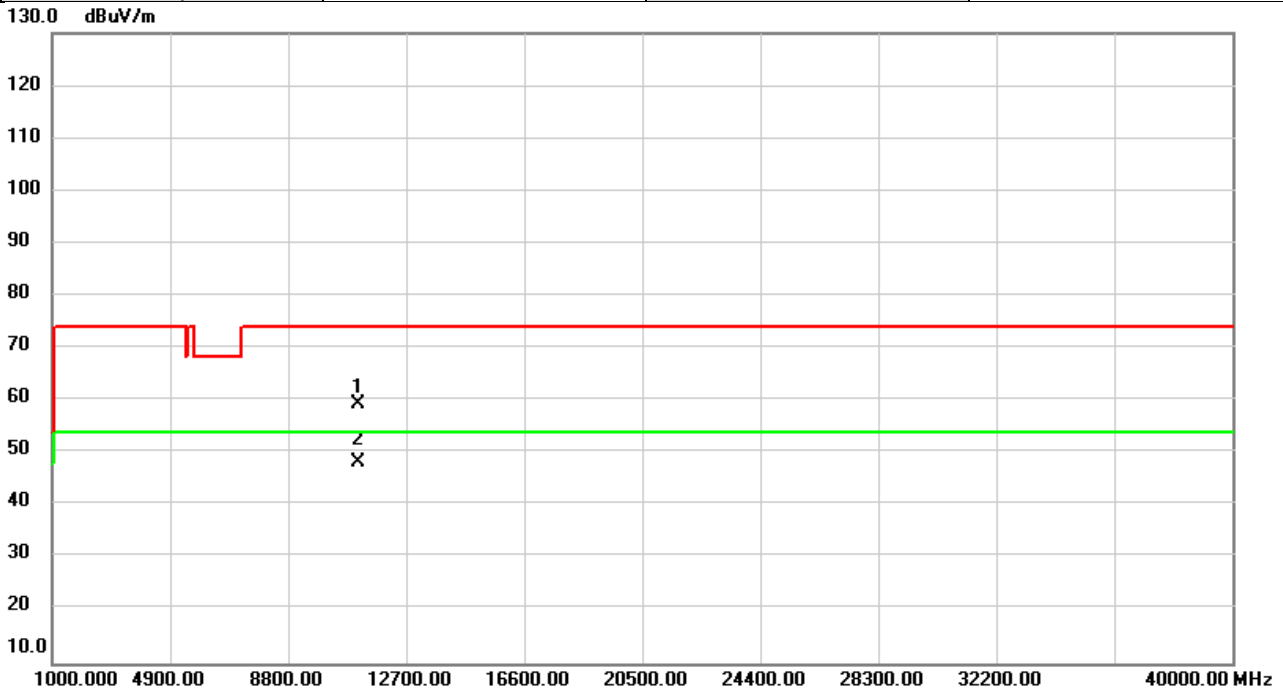

No.	Mk.	Freq.	Reading Level	Correct Factor	Measurement	Limit	Over	Detector	Comment
		MHz	dBuV	dB	dBuV/m	dBuV/m	dB		
1		11100.00	53.46	6.00	59.46	74.00	-14.54	peak	
2	*	11100.00	42.34	6.00	48.34	54.00	-5.66	AVG	

REMARKS:

- (1) Measurement Value = Reading Level + Correct Factor.
- (2) Margin Level = Measurement Value - Limit Value.

Test Mode	IEEE802.11n (HT40)	Test Date	2021/3/6
Test Frequency	5550MHz	Polarization	Horizontal
Temp	22°C	Hum.	66%

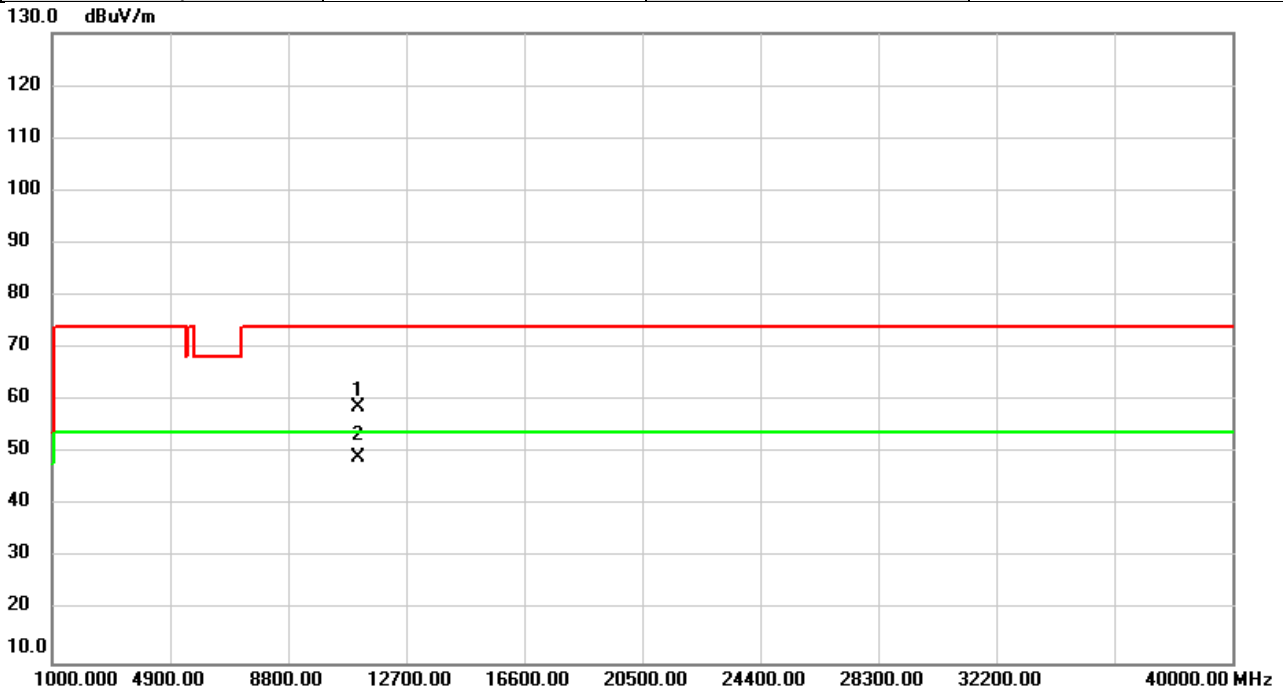

No.	Mk.	Freq.	Reading Level	Correct Factor	Measurement	Limit	Over	Detector	Comment
		MHz	dBuV	dB	dBuV/m	dBuV/m	dB		
1		11100.00	52.73	6.00	58.73	74.00	-15.27	peak	
2	*	11100.00	43.19	6.00	49.19	54.00	-4.81	AVG	

REMARKS:

- (1) Measurement Value = Reading Level + Correct Factor.
- (2) Margin Level = Measurement Value - Limit Value.

Test Mode	IEEE802.11n (HT40)	Test Date	2021/3/6
Test Frequency	5670MHz	Polarization	Vertical
Temp	22°C	Hum.	66%

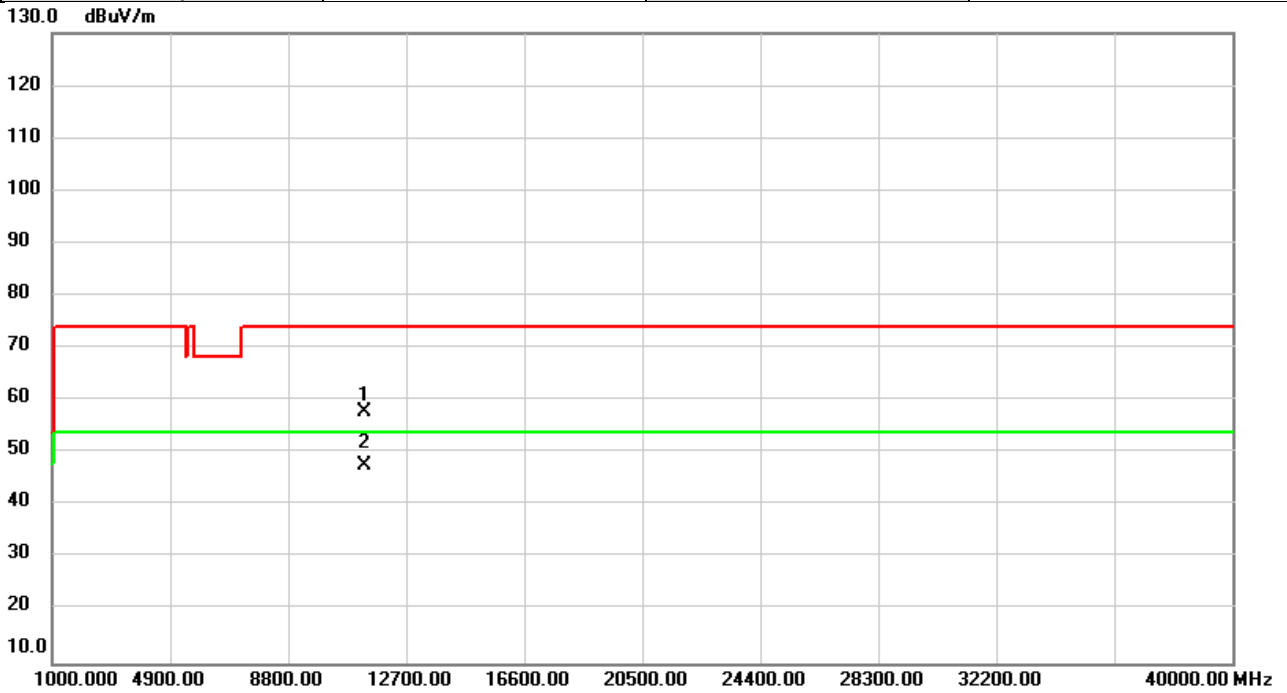

No.	Mk.	Freq.	Reading Level	Correct Factor	Measurement	Limit	Over	Detector	Comment
		MHz	dBuV	dB	dBuV/m	dBuV/m	dB		
1		11340.00	52.56	5.42	57.98	74.00	-16.02	peak	
2	*	11340.00	42.19	5.42	47.61	54.00	-6.39	AVG	

REMARKS:

- (1) Measurement Value = Reading Level + Correct Factor.
- (2) Margin Level = Measurement Value - Limit Value.

Test Mode	IEEE802.11n (HT40)	Test Date	2021/3/6
Test Frequency	5670MHz	Polarization	Horizontal
Temp	22°C	Hum.	66%

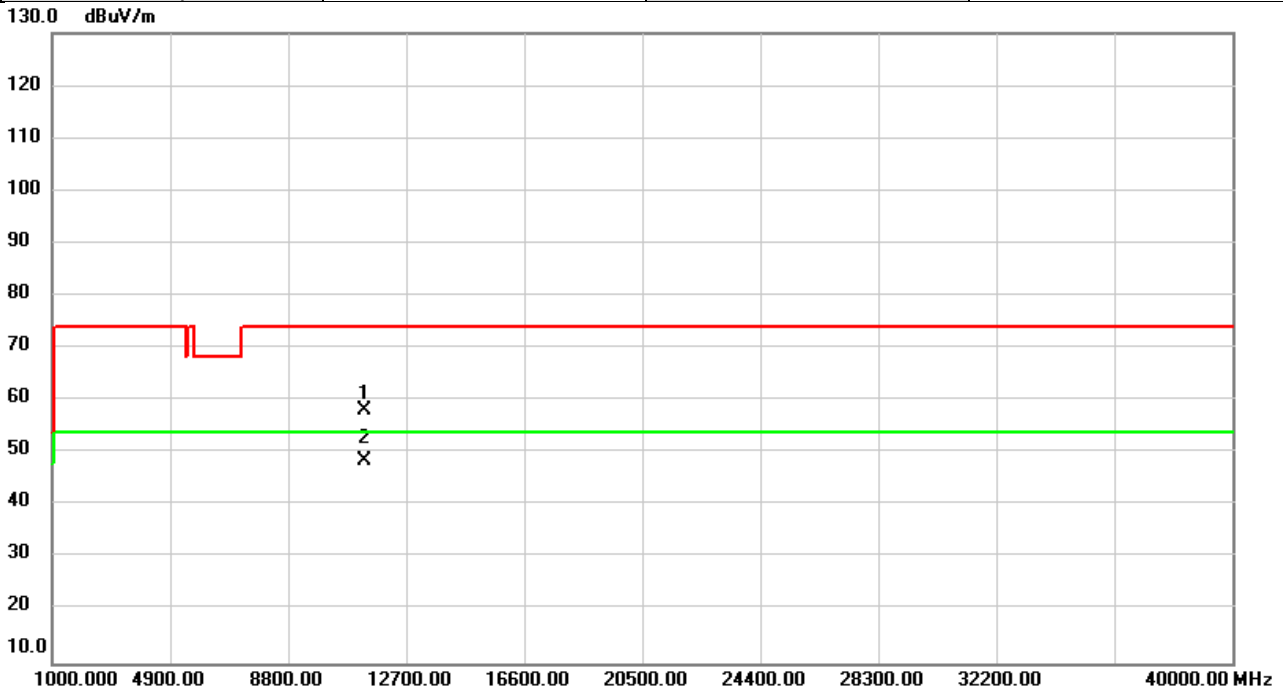

No.	Mk.	Freq.	Reading Level	Correct Factor	Measurement	Limit	Over	Detector	Comment
		MHz	dBuV	dB	dBuV/m	dBuV/m	dB		
1		11340.00	52.80	5.42	58.22	74.00	-15.78	peak	
2	*	11340.00	42.99	5.42	48.41	54.00	-5.59	AVG	

REMARKS:

- (1) Measurement Value = Reading Level + Correct Factor.
- (2) Margin Level = Measurement Value - Limit Value.

Test Mode	IEEE802.11n (HT40)	Test Date	2021/3/6
Test Frequency	5755MHz	Polarization	Vertical
Temp	22°C	Hum.	66%

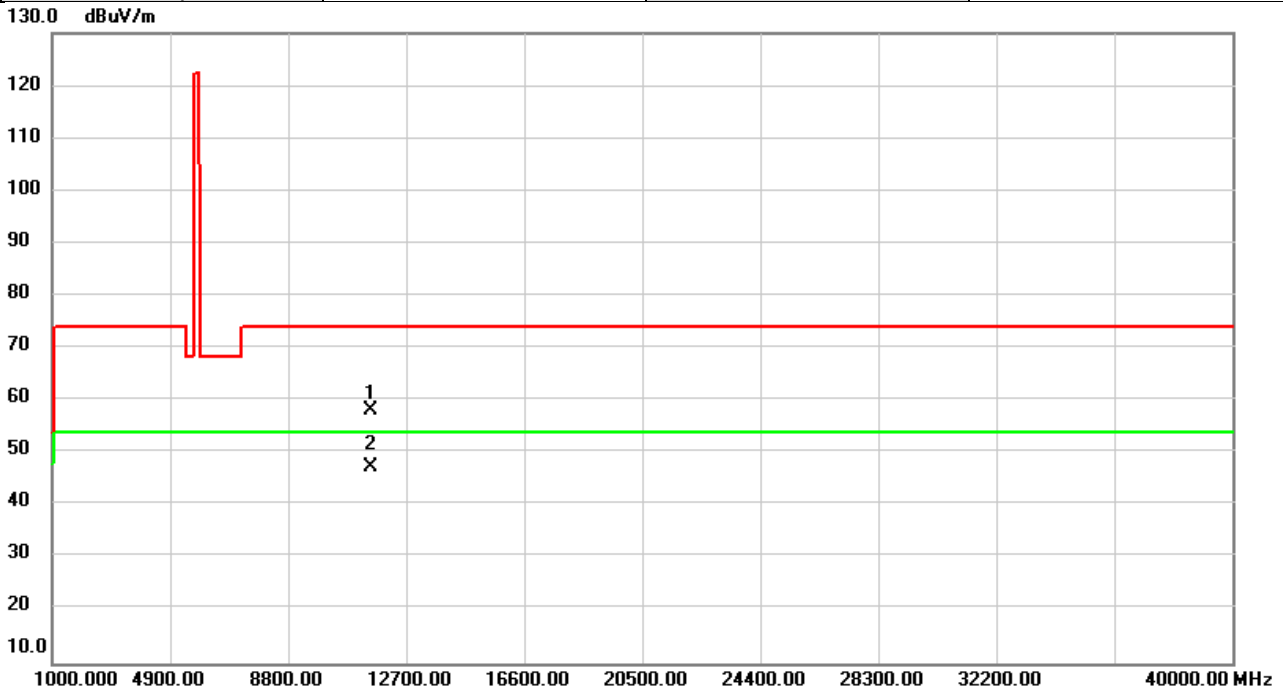

No.	Mk.	Freq.	Reading Level	Correct Factor	Measurement	Limit	Over	Detector	Comment
		MHz	dBuV	dB	dBuV/m	dBuV/m	dB		
1		11510.00	53.19	5.01	58.20	74.00	-15.80	peak	
2	*	11510.00	42.46	5.01	47.47	54.00	-6.53	AVG	

REMARKS:

- (1) Measurement Value = Reading Level + Correct Factor.
- (2) Margin Level = Measurement Value - Limit Value.

Test Mode	IEEE802.11n (HT40)	Test Date	2021/3/6
Test Frequency	5755MHz	Polarization	Horizontal
Temp	22°C	Hum.	66%

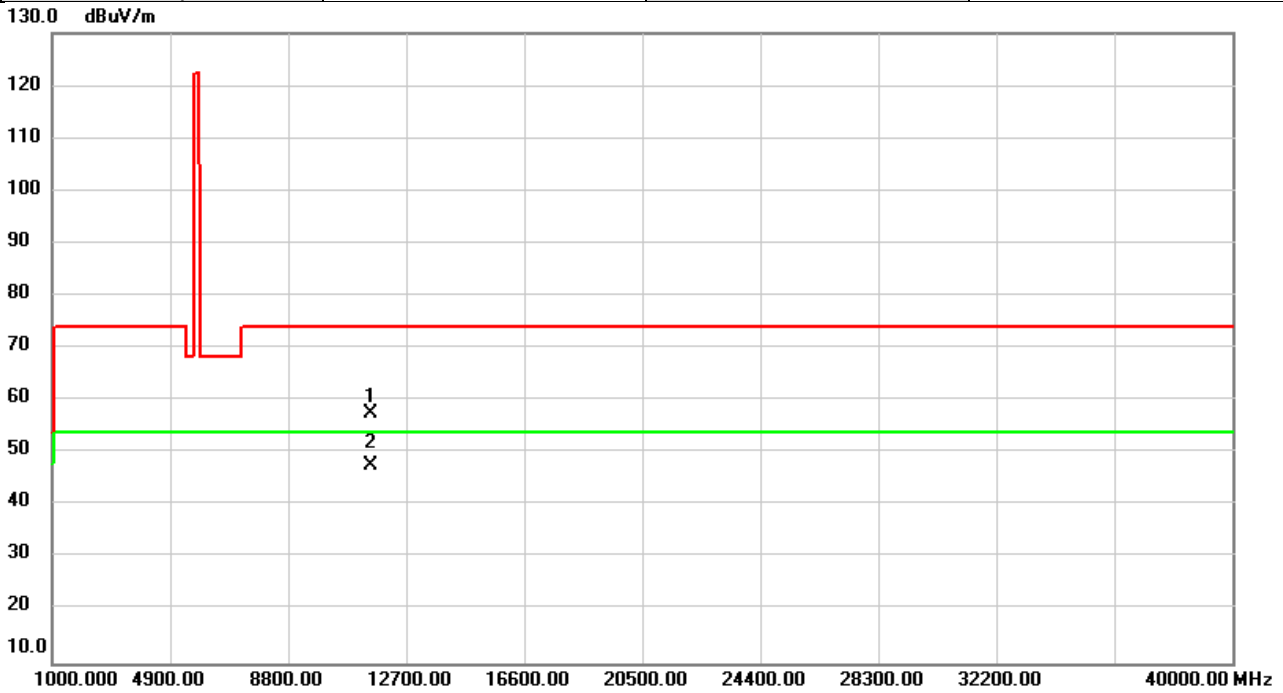

No.	Mk.	Freq.	Reading Level	Correct Factor	Measurement	Limit	Over	Detector	Comment
		MHz	dBuV	dB	dBuV/m	dBuV/m	dB		
1		11510.00	52.41	5.01	57.42	74.00	-16.58	peak	
2	*	11510.00	42.69	5.01	47.70	54.00	-6.30	AVG	

REMARKS:

- (1) Measurement Value = Reading Level + Correct Factor.
- (2) Margin Level = Measurement Value - Limit Value.

Test Mode	IEEE802.11n (HT40)	Test Date	2021/3/6
Test Frequency	5795MHz	Polarization	Vertical
Temp	22°C	Hum.	66%

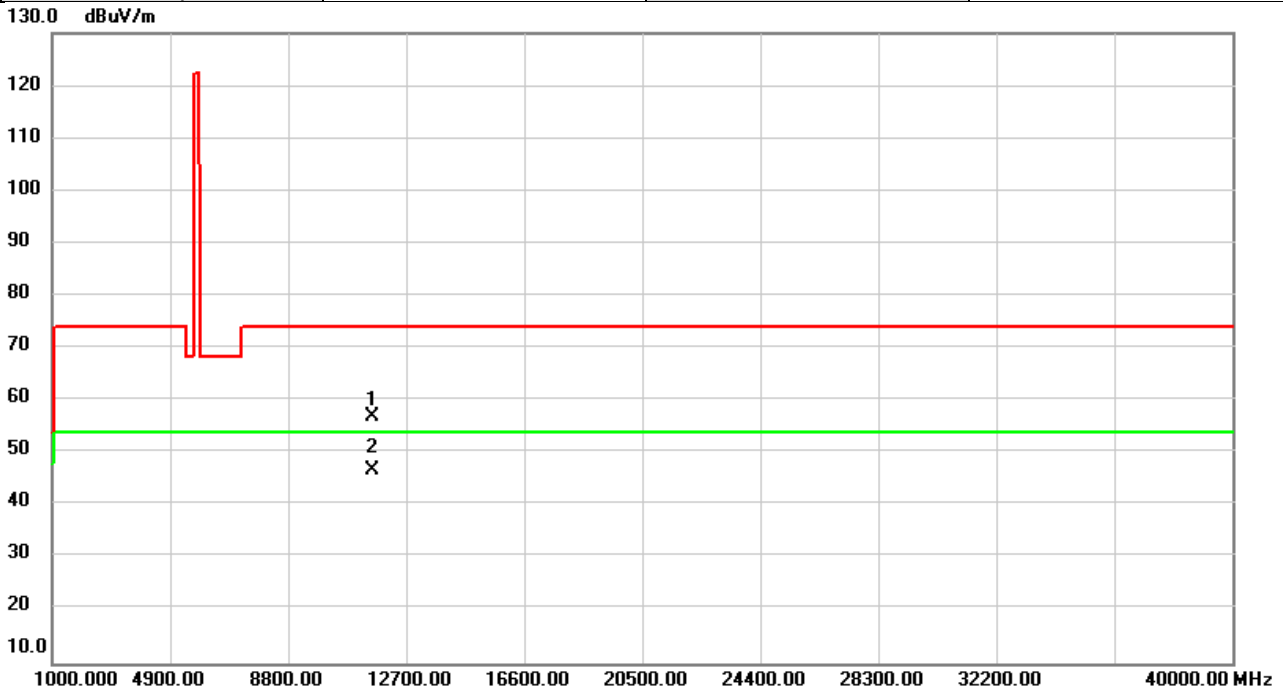

No.	Mk.	Freq.	Reading Level	Correct Factor	Measurement	Limit	Over	Detector	Comment
		MHz	dBuV	dB	dBuV/m	dBuV/m	dB		
1		11590.00	52.19	4.83	57.02	74.00	-16.98	peak	
2	*	11590.00	41.98	4.83	46.81	54.00	-7.19	AVG	

REMARKS:

- (1) Measurement Value = Reading Level + Correct Factor.
- (2) Margin Level = Measurement Value - Limit Value.

Test Mode	IEEE802.11n (HT40)	Test Date	2021/3/6
Test Frequency	5795MHz	Polarization	Horizontal
Temp	22°C	Hum.	66%

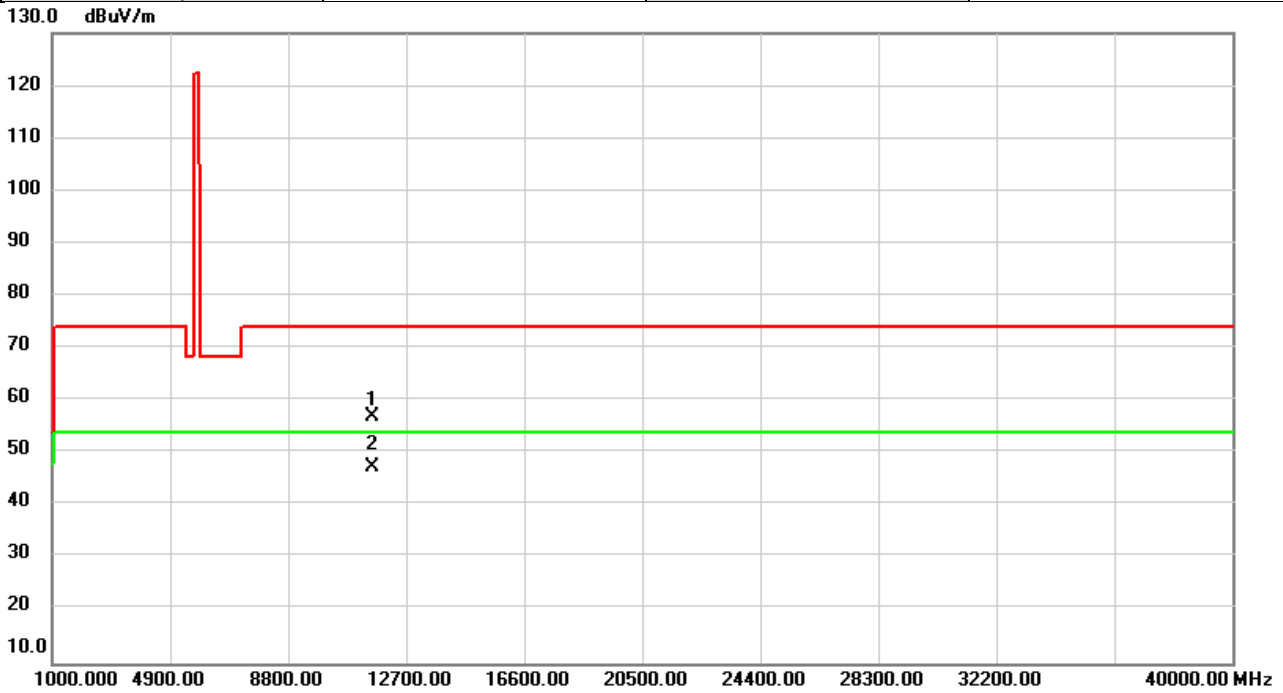

No.	Mk.	Freq.	Reading Level	Correct Factor	Measurement	Limit	Over	Detector	Comment
		MHz	dBuV	dB	dBuV/m	dBuV/m	dB		
1		11590.00	51.98	4.83	56.81	74.00	-17.19	peak	
2	*	11590.00	42.39	4.83	47.22	54.00	-6.78	AVG	

REMARKS:

- (1) Measurement Value = Reading Level + Correct Factor.
- (2) Margin Level = Measurement Value - Limit Value.

APPENDIX D BANDWIDTH

Test Mode	IEEE 802.11a
-----------	--------------

Test Frequency (MHz)	26 dB Bandwidth (MHz)	99 % Occupied Bandwidth (MHz)	Limit
5180	21.85	17.20	No limit
5200	21.59	17.10	No limit
5240	21.81	17.20	No limit

5180 MHz

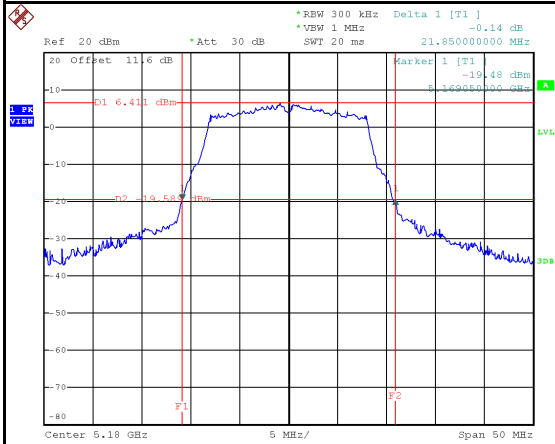

Date: 26.FEB.2021 17:34:42

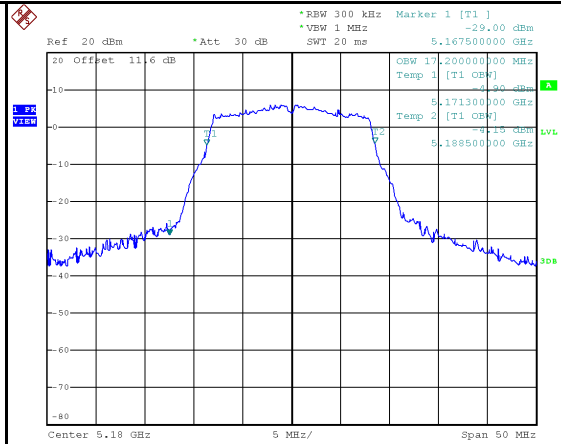

Date: 26.FEB.2021 17:34:13

5200 MHz

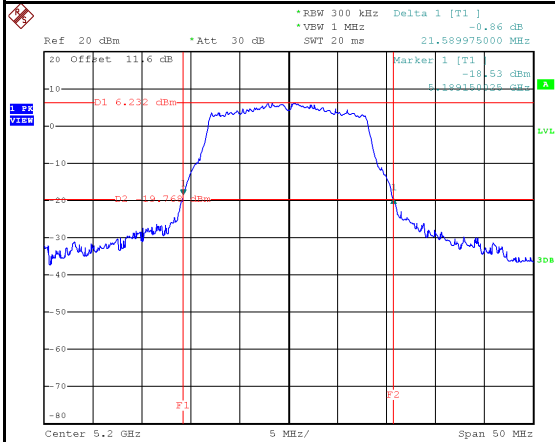

Date: 26.FEB.2021 17:35:45

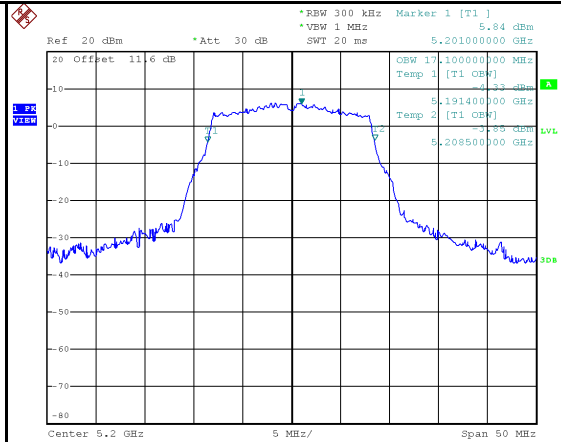

Date: 26.FEB.2021 17:35:14

5240 MHz

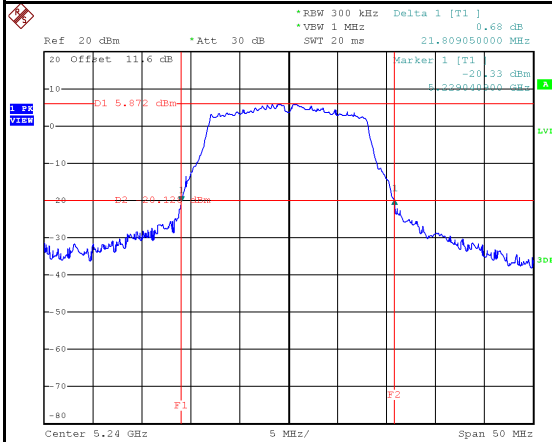

Date: 26.FEB.2021 17:36:43

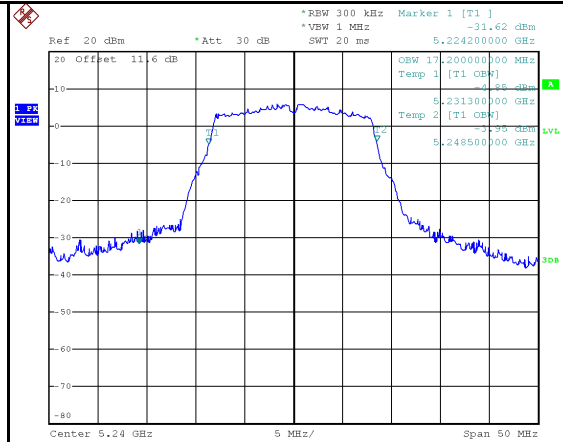

Date: 26.FEB.2021 17:36:14

Test Frequency (MHz)	26 dB Bandwidth (MHz)	99 % Occupied Bandwidth (MHz)	Limit
5260	21.80	17.20	No limit
5300	21.85	17.20	No limit
5320	21.85	17.20	No limit

5260 MHz

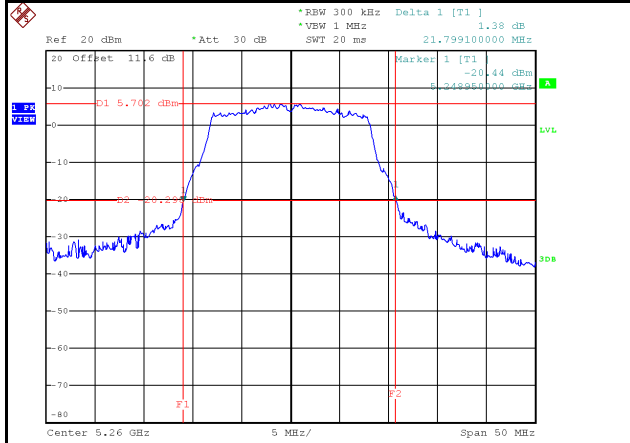

Date: 26.FEB.2021 17:37:42

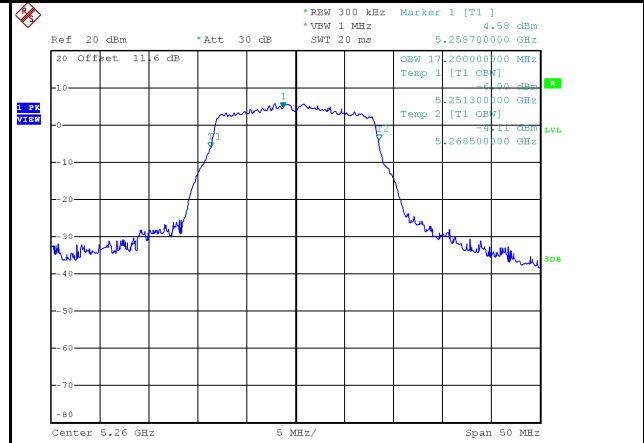

Date: 26.FEB.2021 17:37:13

5300 MHz

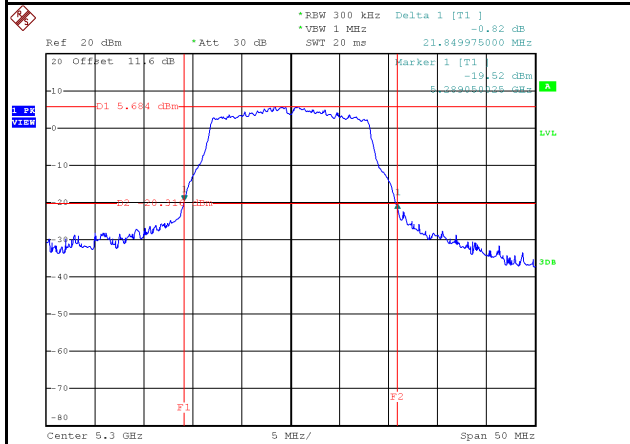

Date: 26.FEB.2021 17:38:40

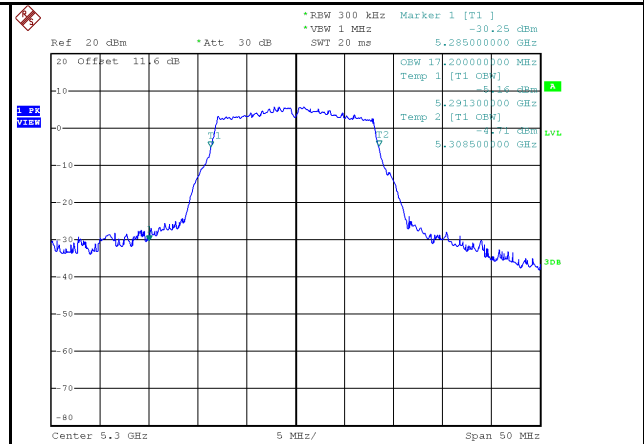

Date: 26.FEB.2021 17:38:11

5320 MHz

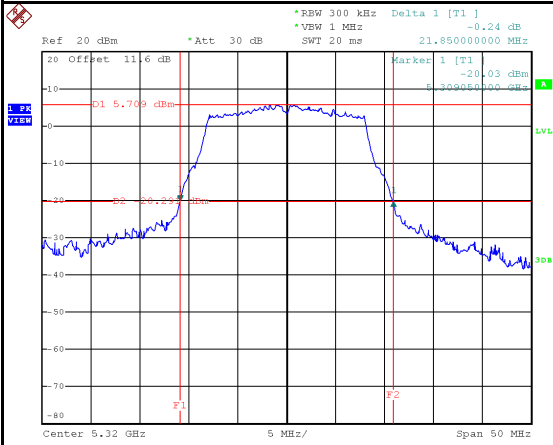

Date: 26.FEB.2021 17:39:38

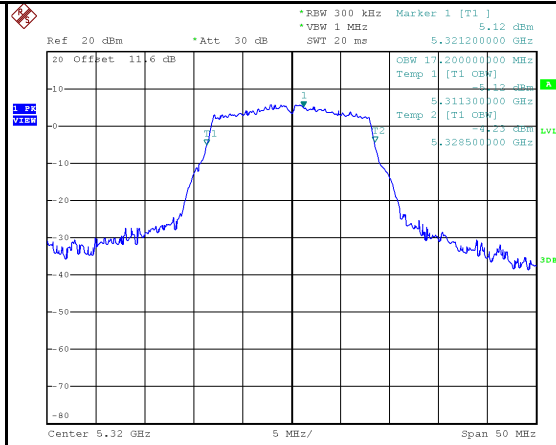

Date: 26.FEB.2021 17:39:09

Test Frequency (MHz)	26 dB Bandwidth (MHz)	99 % Occupied Bandwidth (MHz)	Limit
5500	21.79	17.20	No limit
5580	21.85	17.20	No limit
5700	21.89	17.20	No limit

5500 MHz

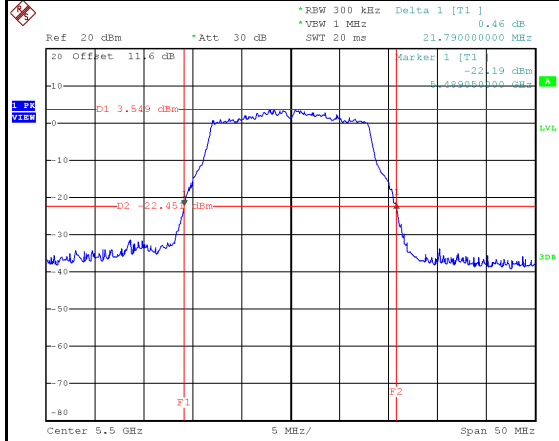

Date: 26.FEB.2021 17:40:37

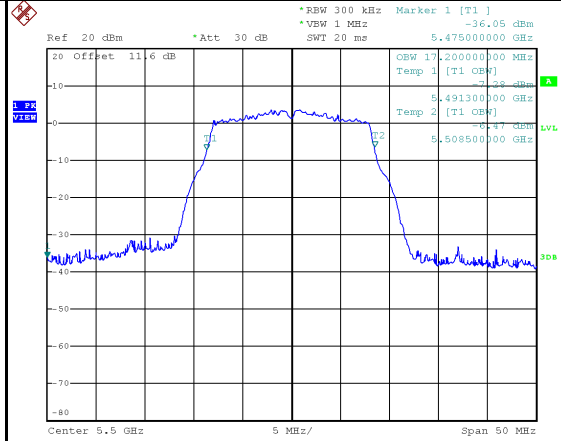

Date: 26.FEB.2021 17:40:08

5580 MHz

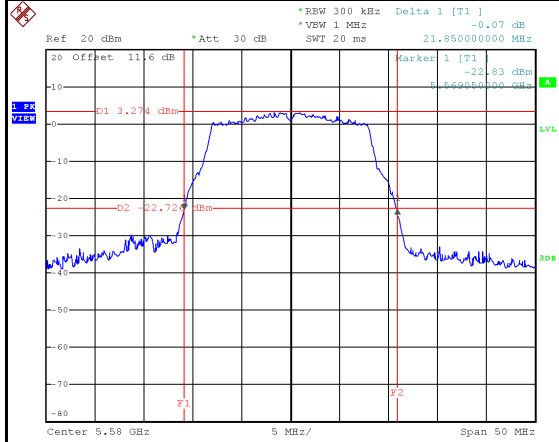

Date: 26.FEB.2021 17:41:33

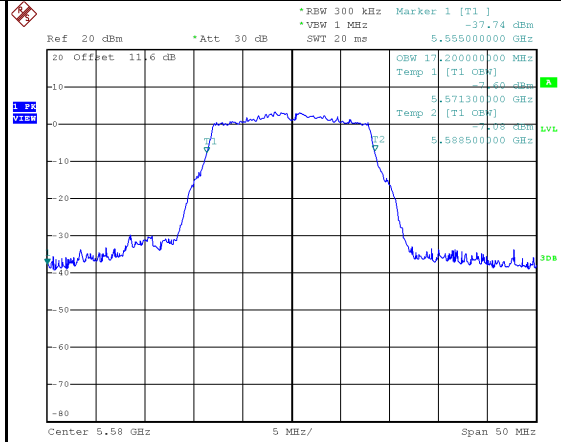

Date: 26.FEB.2021 17:41:05

5700 MHz

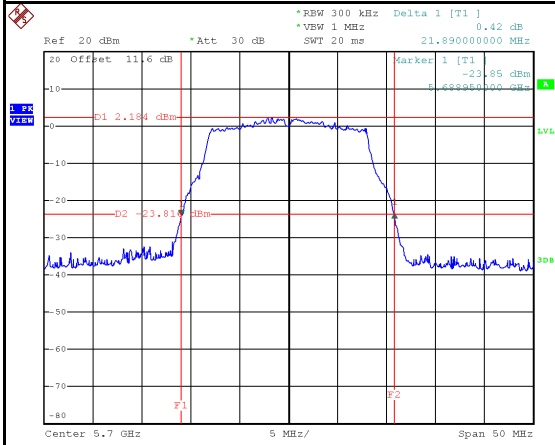

Date: 26.FEB.2021 17:42:30

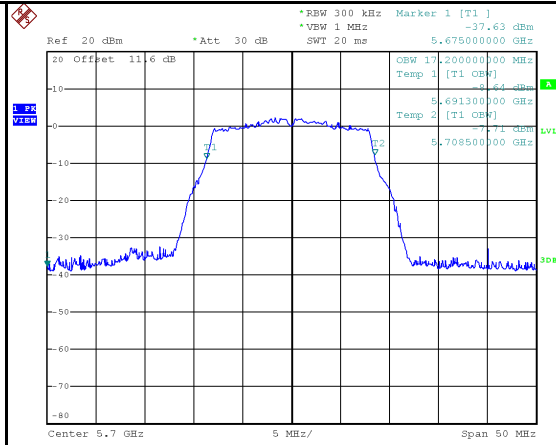

Date: 26.FEB.2021 17:42:01

Test Frequency (MHz)	6 dB Bandwidth (MHz)	99 % Occupied Bandwidth (MHz)	Minimum 6 dB Bandwidth Limit (kHz)	Result
5745	16.35	17.20	500	Pass
5785	16.35	17.20	500	Pass
5825	16.35	17.20	500	Pass

5745 MHz

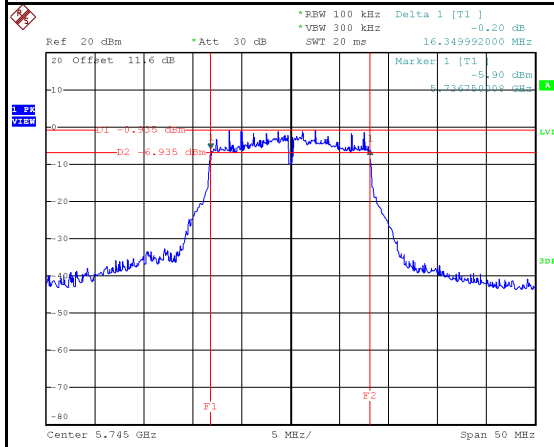

Date: 26.FEB.2021 17:43:45

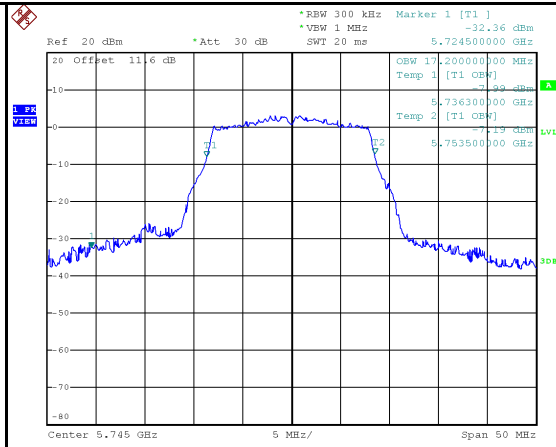

Date: 26.FEB.2021 17:43:11

5785 MHz

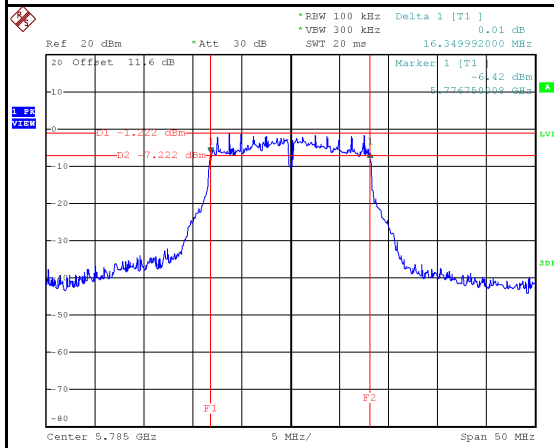

Date: 26.FEB.2021 17:44:48

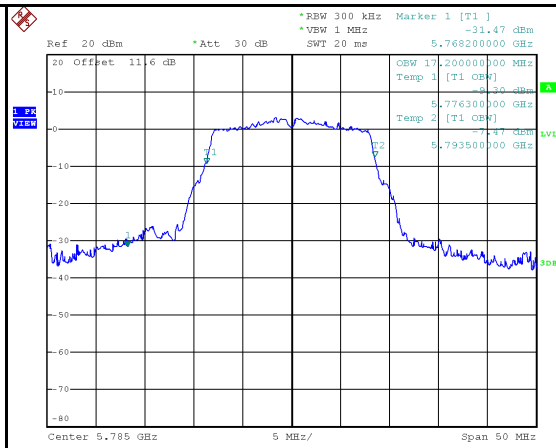

Date: 26.FEB.2021 17:44:15

5825 MHz

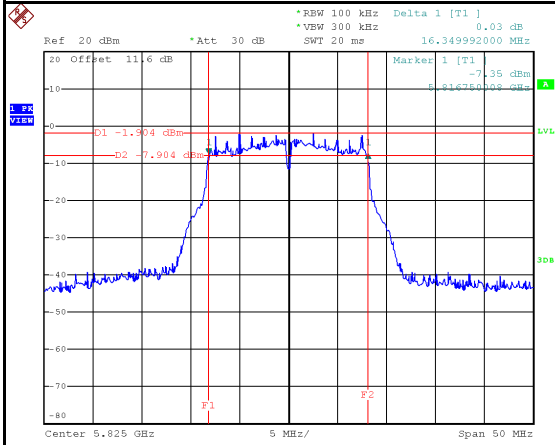

Date: 26.FEB.2021 17:46:11

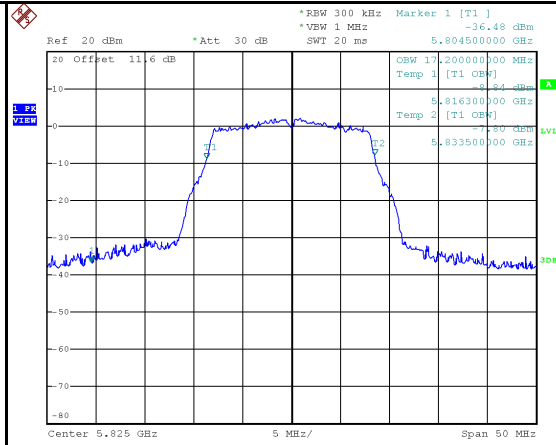

Date: 26.FEB.2021 17:45:37

Test Mode	IEEE 802.11n (HT20)
-----------	---------------------

Test Frequency (MHz)	26 dB Bandwidth (MHz)	99 % Occupied Bandwidth (MHz)	Limit
5180	21.91	18.30	No limit
5200	21.85	18.20	No limit
5240	21.95	18.30	No limit

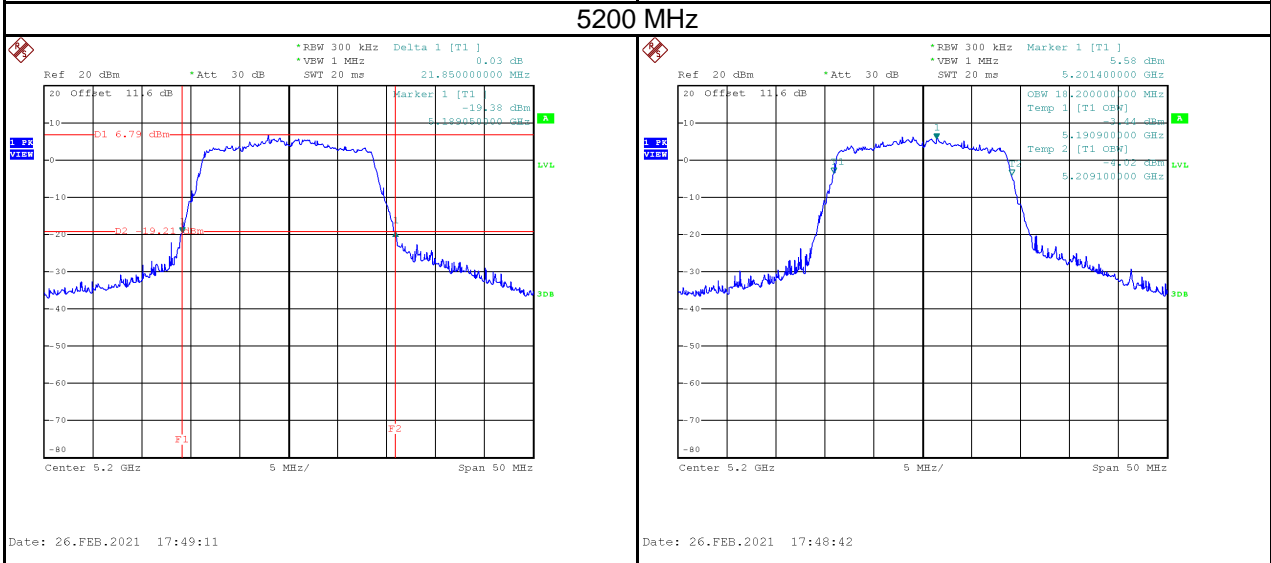
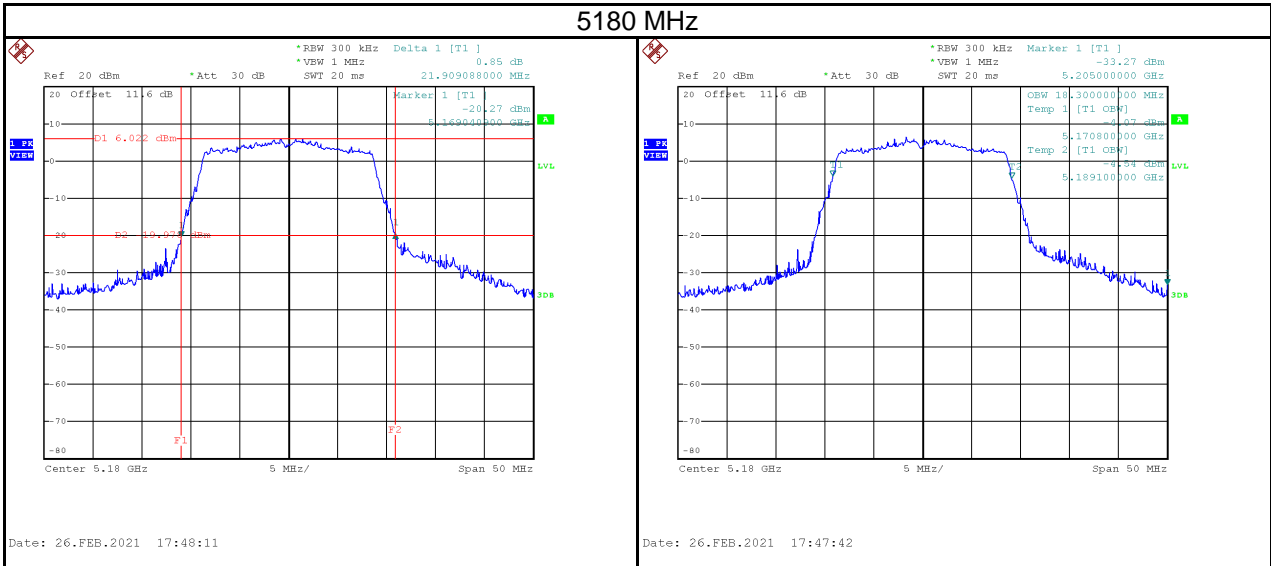

5240 MHz

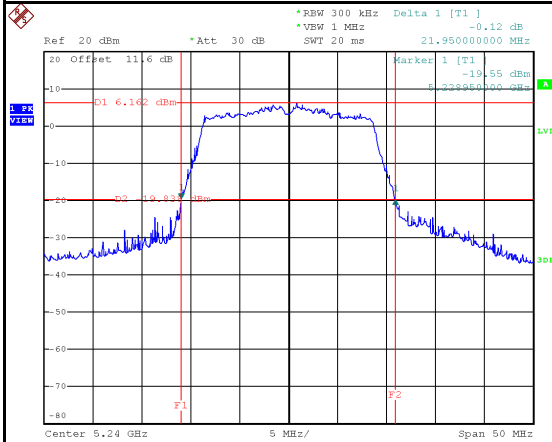

Date: 26.FEB.2021 17:50:07

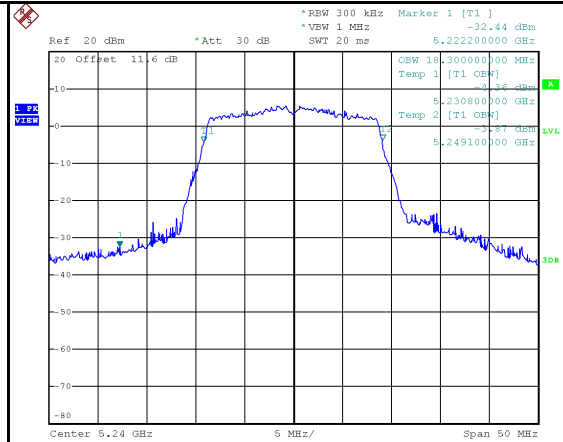

Date: 26.FEB.2021 17:49:39

Test Frequency (MHz)	26 dB Bandwidth (MHz)	99 % Occupied Bandwidth (MHz)	Limit
5260	21.89	18.30	No limit
5300	21.85	18.20	No limit
5320	22.00	18.30	No limit

5260 MHz

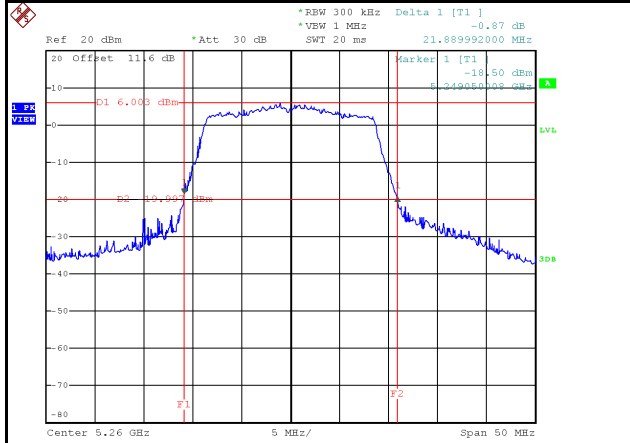

Date: 26.FEB.2021 17:51:18

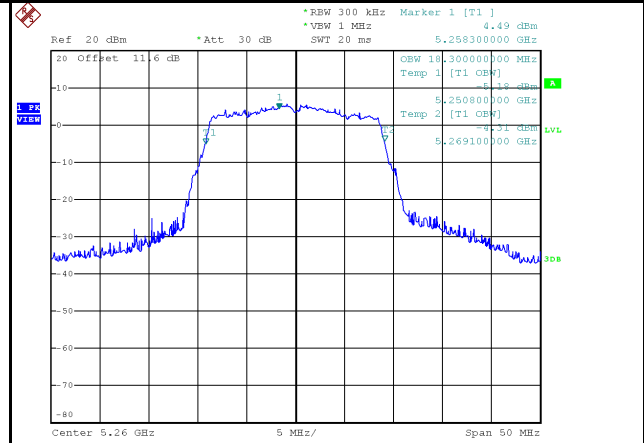

Date: 26.FEB.2021 17:50:49

5300 MHz

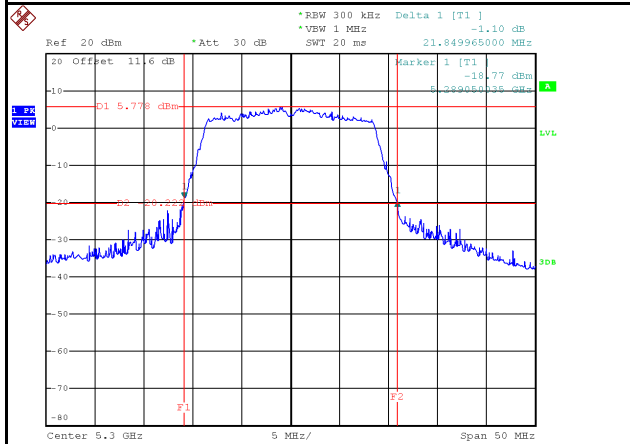

Date: 26.FEB.2021 17:52:20

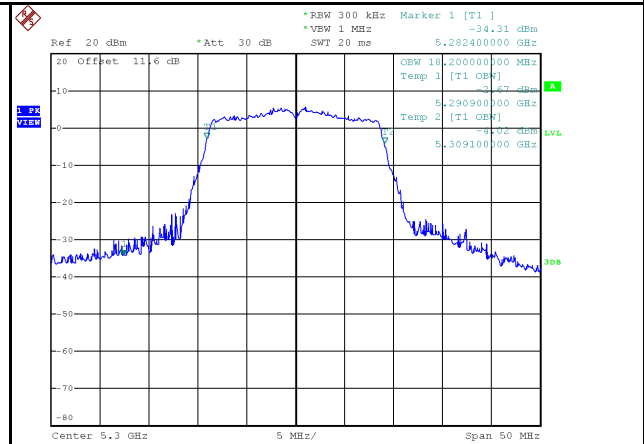

Date: 26.FEB.2021 17:51:52

5320 MHz

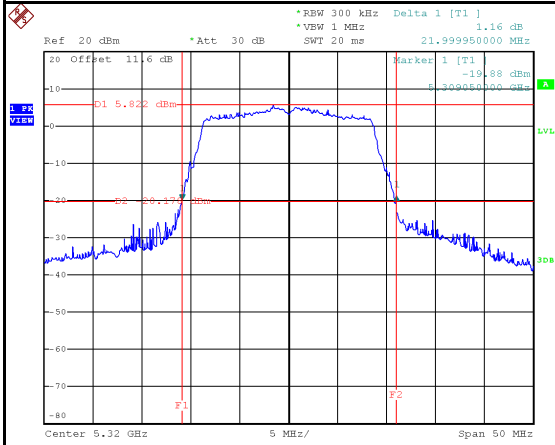

Date: 26.FEB.2021 17:53:18

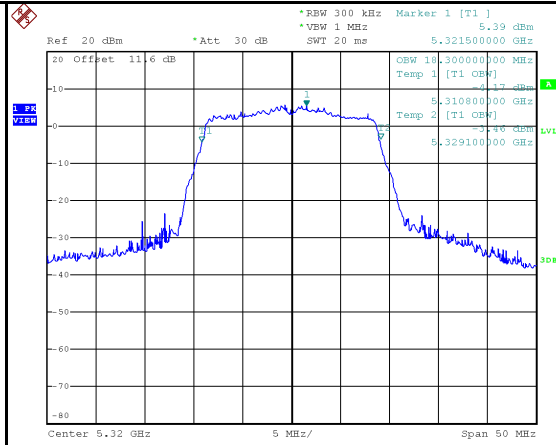

Date: 26.FEB.2021 17:52:50

Test Frequency (MHz)	26 dB Bandwidth (MHz)	99 % Occupied Bandwidth (MHz)	Limit
5500	21.91	18.30	No limit
5580	22.09	18.20	No limit
5700	21.85	18.30	No limit

5500 MHz

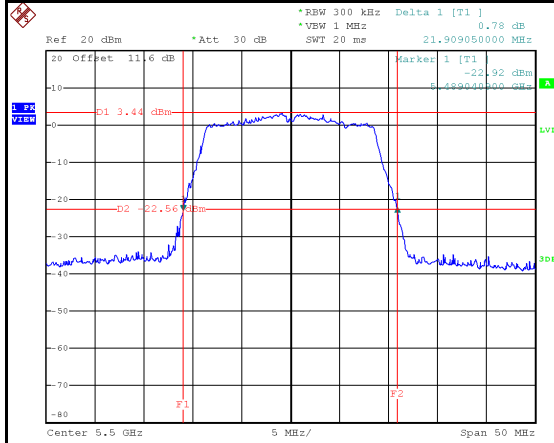

Date: 26.FEB.2021 17:54:25

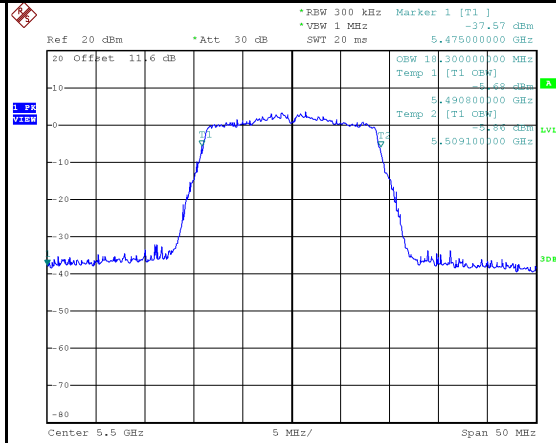

Date: 26.FEB.2021 17:53:57

5580 MHz

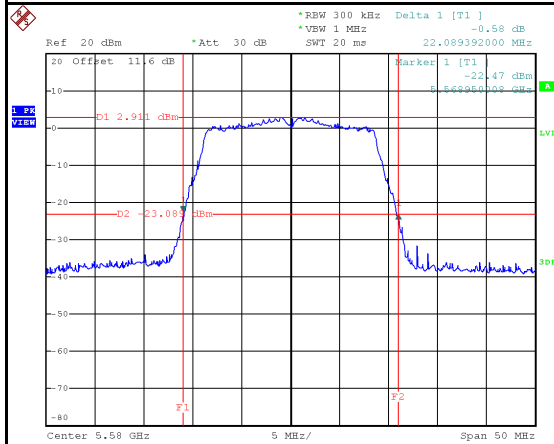

Date: 26.FEB.2021 17:55:26

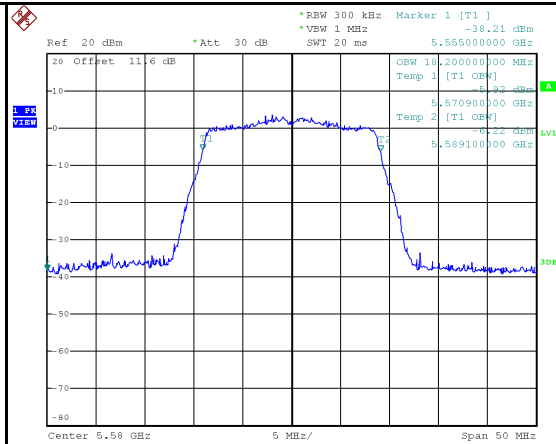

Date: 26.FEB.2021 17:54:58

5700 MHz

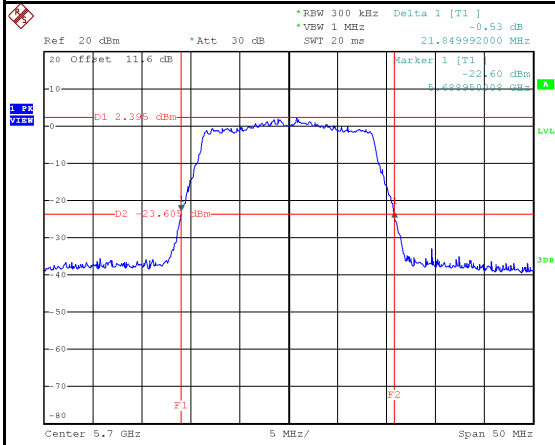

Date: 26.FEB.2021 17:56:46

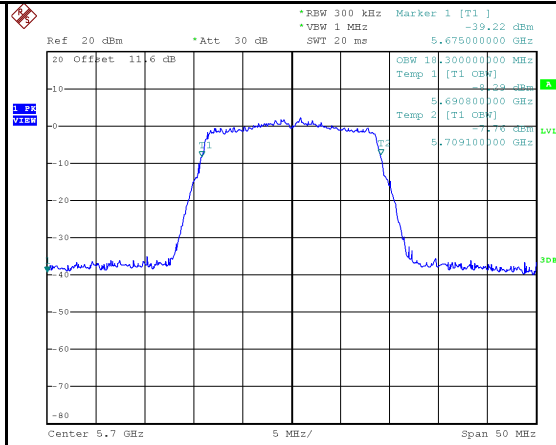

Date: 26.FEB.2021 17:56:17

Test Frequency (MHz)	6 dB Bandwidth (MHz)	99 % Occupied Bandwidth (MHz)	Minimum 6 dB Bandwidth Limit (kHz)	Result
5745	17.65	18.20	500	Pass
5785	17.65	18.20	500	Pass
5825	17.59	18.30	500	Pass

5745 MHz

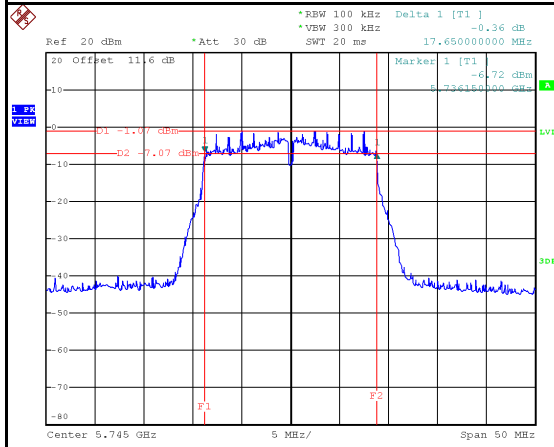

Date: 26.FEB.2021 17:59:31

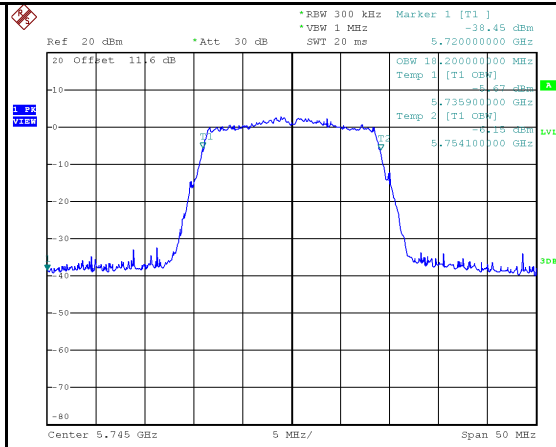

Date: 26.FEB.2021 17:59:00

5785 MHz

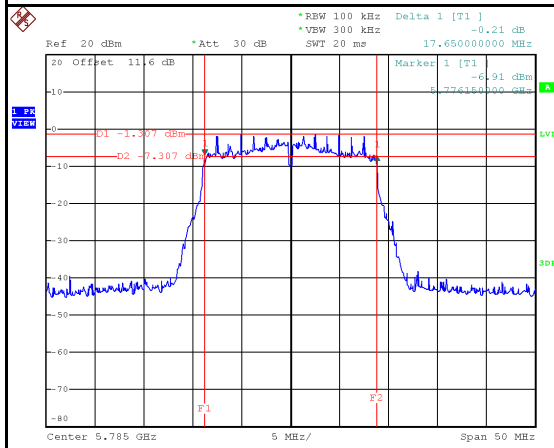

Date: 26.FEB.2021 18:00:43

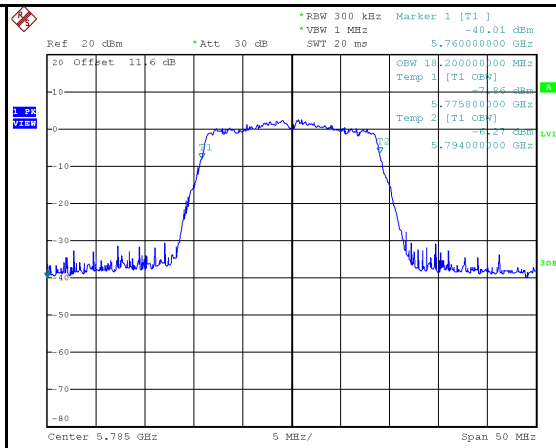

Date: 26.FEB.2021 18:00:12

5825 MHz

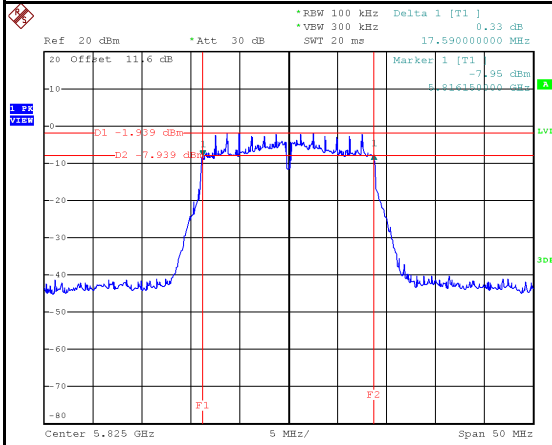

Date: 26.FEB.2021 18:01:59

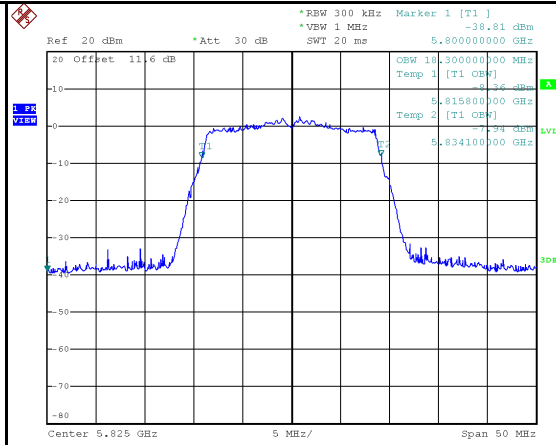

Date: 26.FEB.2021 18:01:27

Test Mode	IEEE 802.11n (HT40)
-----------	---------------------

Test Frequency (MHz)	26 dB Bandwidth (MHz)	99 % Occupied Bandwidth (MHz)	Limit
5190	39.70	36.80	No limit
5230	39.70	37.00	No limit

5190 MHz

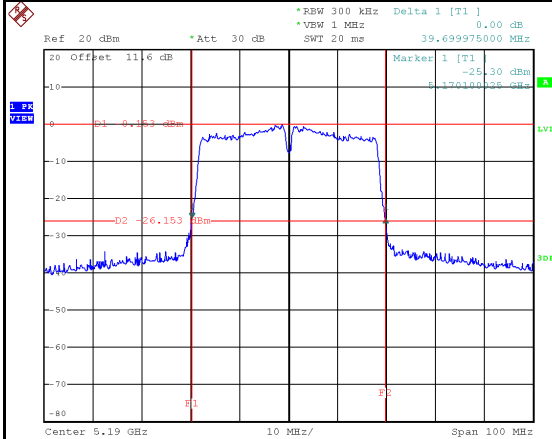

Date: 26.FEB.2021 18:29:36

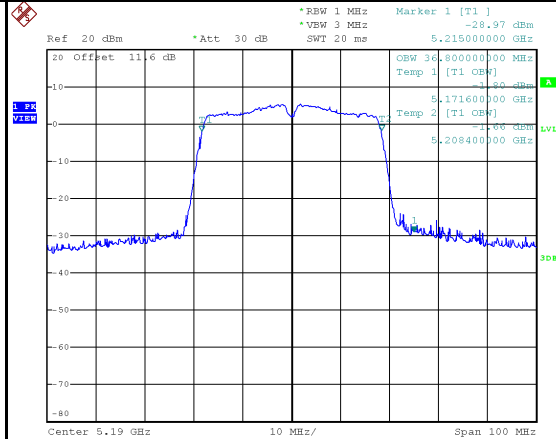

Date: 26.FEB.2021 18:28:49

5230 MHz

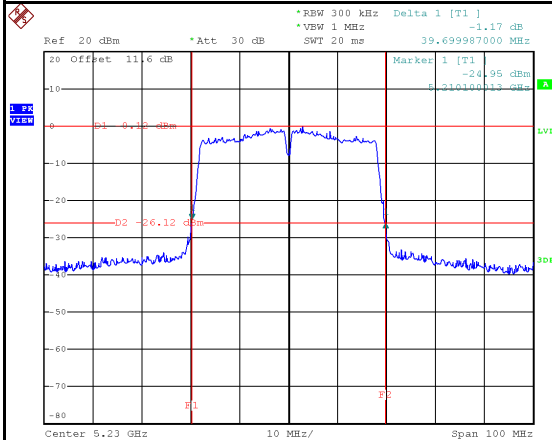

Date: 26.FEB.2021 18:30:57

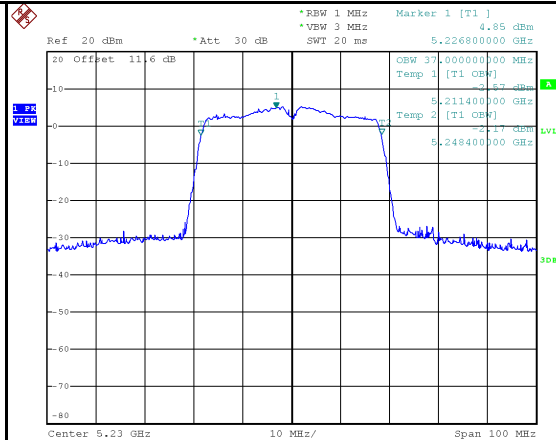

Date: 26.FEB.2021 18:30:13

Test Frequency (MHz)	26 dB Bandwidth (MHz)	99 % Occupied Bandwidth (MHz)	Limit
5270	39.42	36.80	No limit
5310	39.80	36.80	No limit

5270 MHz

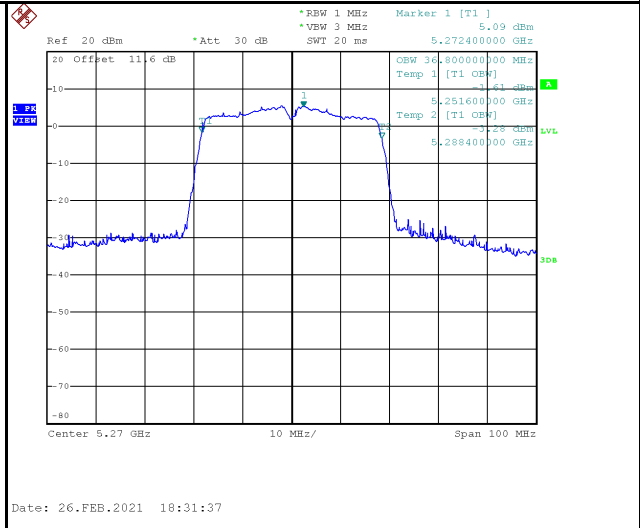
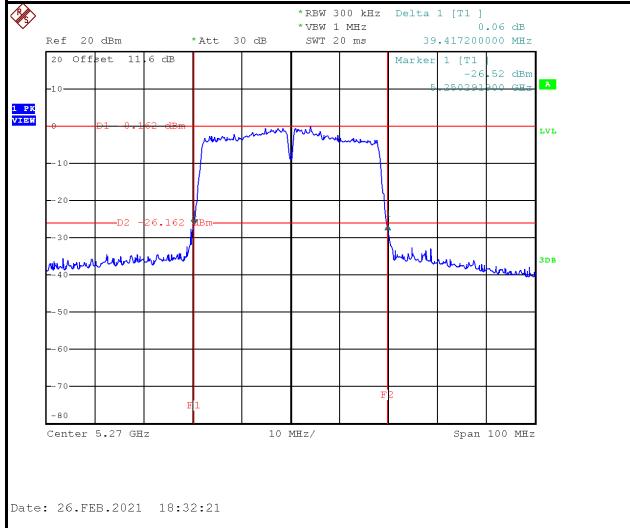

5310 MHz

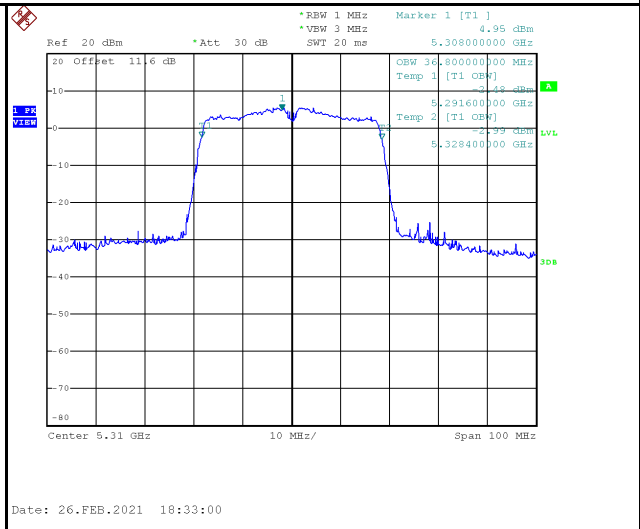
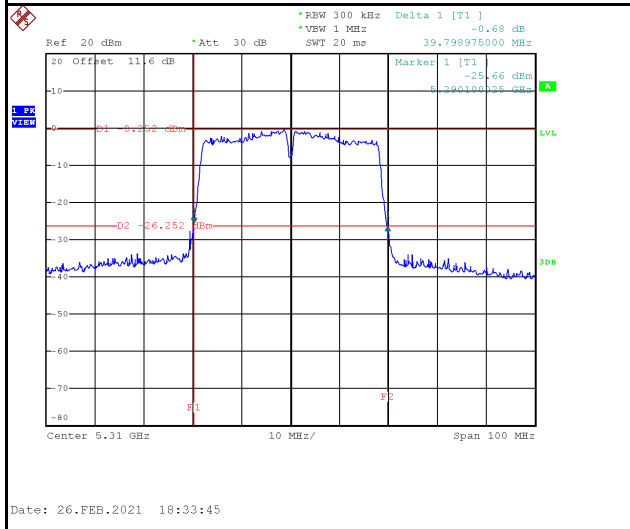

Test Frequency (MHz)	26 dB Bandwidth (MHz)	99 % Occupied Bandwidth (MHz)	Limit
5510	39.70	36.80	No limit
5550	39.62	36.80	No limit
5670	39.99	36.80	No limit

5510 MHz

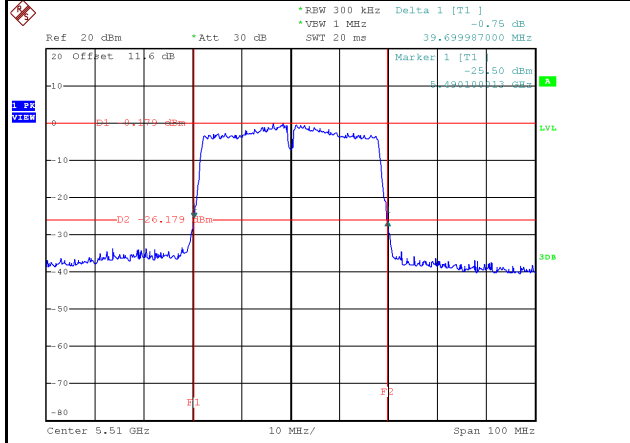

Date: 26.FEB.2021 18:39:59

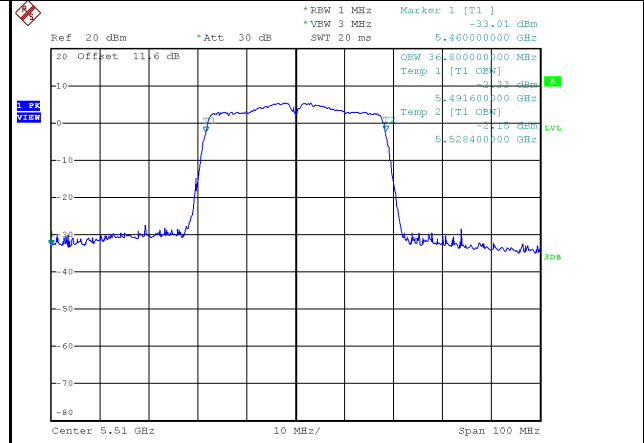

Date: 26.FEB.2021 18:39:13

5550 MHz

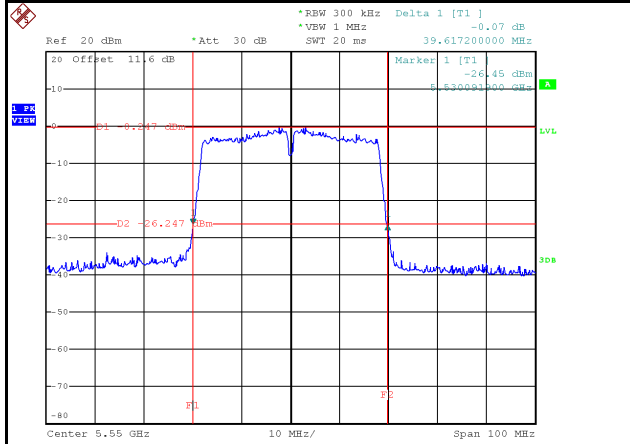

Date: 26.FEB.2021 18:44:07

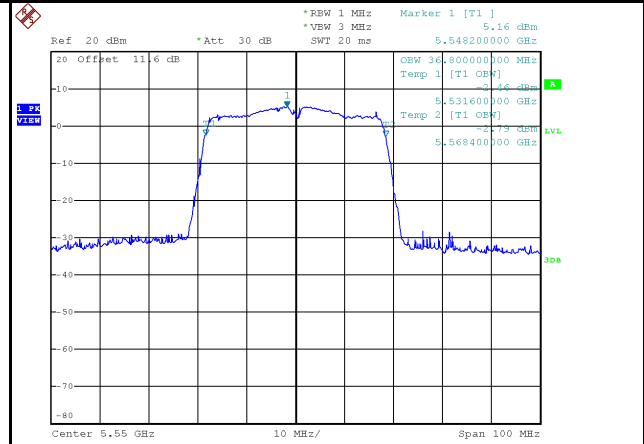

Date: 26.FEB.2021 18:43:23

5670 MHz

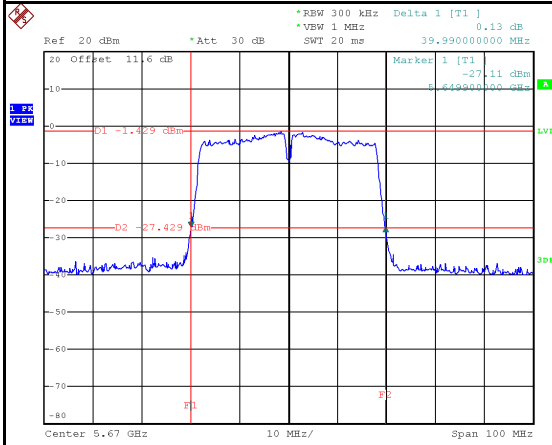

Date: 26.FEB.2021 18:45:28

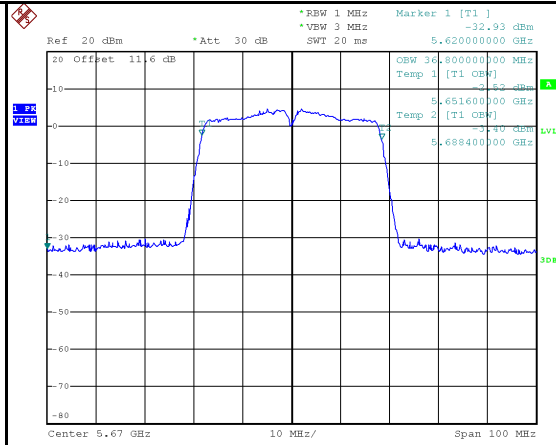

Date: 26.FEB.2021 18:44:44

Test Frequency (MHz)	6 dB Bandwidth (MHz)	99 % Occupied Bandwidth (MHz)	Minimum 6 dB Bandwidth Limit (kHz)	Result
5755	35.79	36.80	500	Pass
5795	36.50	36.80	500	Pass

5755 MHz

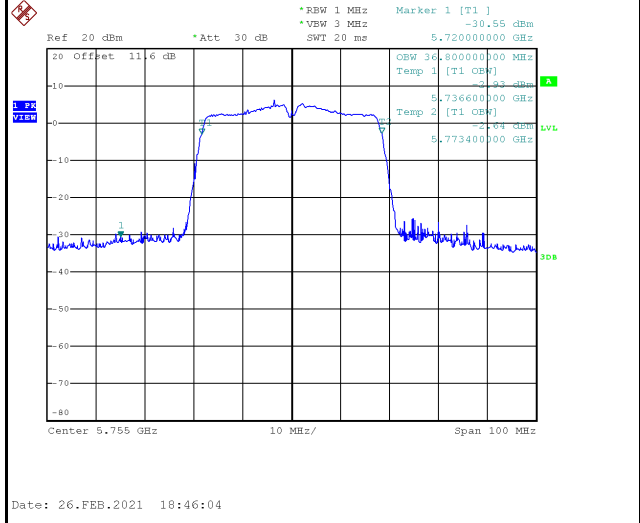
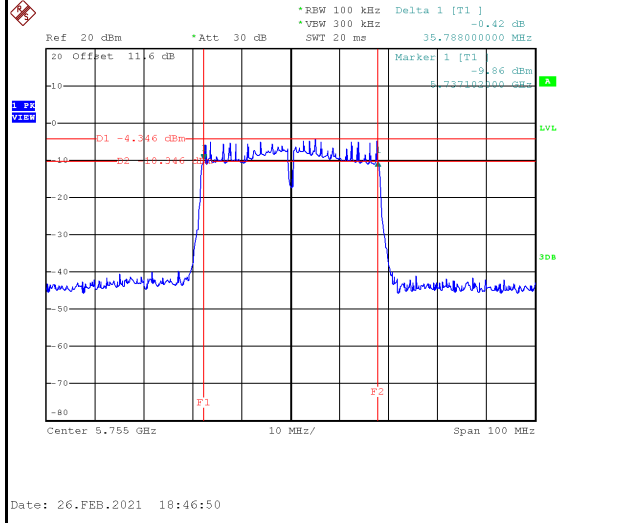

5795 MHz

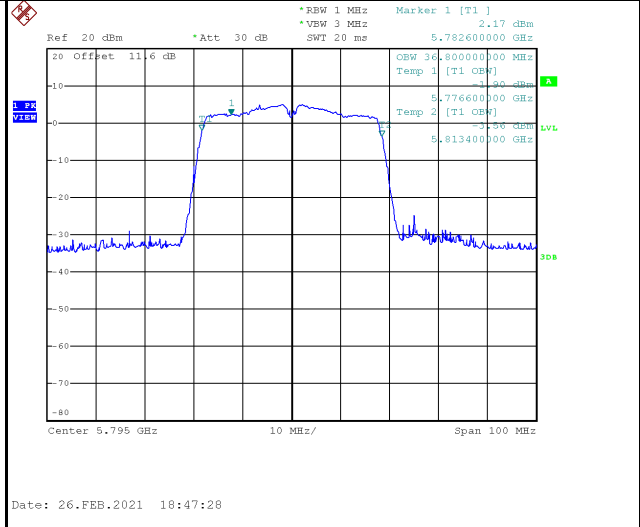
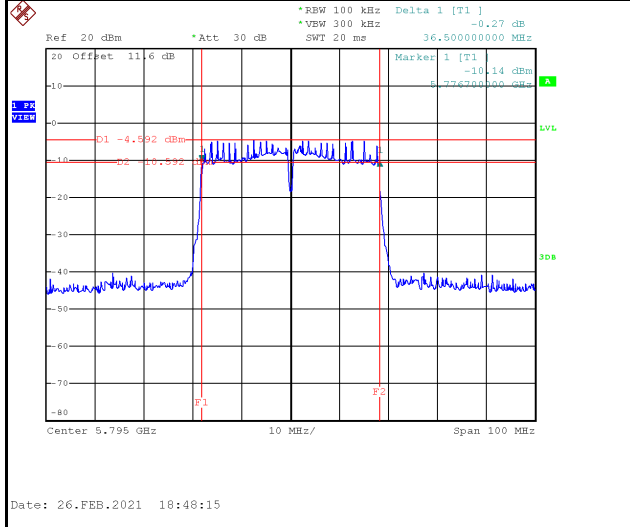

APPENDIX E CONDUCTED OUTPUT POWER

Test Mode	IEEE 802.11a	Tested Date	2021/2/26
-----------	--------------	-------------	-----------

Test Frequency (MHz)	Conducted Power (dBm)	Conducted Power (W)	Max. Limit (dBm)	Max. Limit (W)	Result
5180	13.16	0.0207	24.00	0.2500	Pass
5200	13.23	0.0210	24.00	0.2500	Pass
5240	13.30	0.0214	24.00	0.2500	Pass
5260	13.22	0.0210	24.00	0.2500	Pass
5300	13.20	0.0209	24.00	0.2500	Pass
5320	13.49	0.0223	24.00	0.2500	Pass
5500	10.53	0.0113	24.00	0.2500	Pass
5580	9.99	0.0100	24.00	0.2500	Pass
5700	9.14	0.0082	24.00	0.2500	Pass

Test Frequency (MHz)	Conducted Power (dBm)	Conducted Power (W)	Max. Limit (dBm)	Max. Limit (W)	Result
5745	10.22	0.0105	30.00	1.0000	Pass
5785	10.24	0.0106	30.00	1.0000	Pass
5825	9.51	0.0089	30.00	1.0000	Pass

Test Mode	IEEE 802.11n (HT20)	Tested Date	2021/2/26
-----------	---------------------	-------------	-----------

Test Frequency (MHz)	Conducted Power (dBm)	Conducted Power (W)	Max. Limit (dBm)	Max. Limit (W)	Result
5180	12.80	0.0191	24.00	0.2500	Pass
5200	13.07	0.0203	24.00	0.2500	Pass
5240	12.88	0.0194	24.00	0.2500	Pass
5260	12.82	0.0191	24.00	0.2500	Pass
5300	12.71	0.0187	24.00	0.2500	Pass
5320	12.85	0.0193	24.00	0.2500	Pass
5500	10.37	0.0109	24.00	0.2500	Pass
5580	9.60	0.0091	24.00	0.2500	Pass
5700	8.94	0.0078	24.00	0.2500	Pass

Test Frequency (MHz)	Conducted Power (dBm)	Conducted Power (W)	Max. Limit (dBm)	Max. Limit (W)	Result
5745	9.84	0.0096	30.00	1.0000	Pass
5785	10.17	0.0104	30.00	1.0000	Pass
5825	8.99	0.0079	30.00	1.0000	Pass

Test Mode	IEEE 802.11n (HT40)	Tested Date	2021/2/26
-----------	---------------------	-------------	-----------

Test Frequency (MHz)	Conducted Power (dBm)	Conducted Power (W)	Max. Limit (dBm)	Max. Limit (W)	Result
5190	9.90	0.0098	24.00	0.2500	Pass
5230	9.87	0.0097	24.00	0.2500	Pass
5270	10.10	0.0102	24.00	0.2500	Pass
5310	10.40	0.0110	24.00	0.2500	Pass
5510	9.74	0.0094	24.00	0.2500	Pass
5550	10.10	0.0102	24.00	0.2500	Pass
5670	9.55	0.0090	24.00	0.2500	Pass

Test Frequency (MHz)	Conducted Power (dBm)	Conducted Power (W)	Max. Limit (dBm)	Max. Limit (W)	Result
5755	10.07	0.0102	30.00	1.0000	Pass
5795	10.00	0.0100	30.00	1.0000	Pass

APPENDIX F POWER SPECTRAL DENSITY

Test Mode	IEEE 802.11a
-----------	--------------

Test Frequency (MHz)	Power Density (dBm/MHz)	Duty Factor (dB)	Calculated Power Density (dBm/MHz)	Maximum Limit (dBm/MHz)	Result
5180	3.44	0.21	3.65	17.00	Pass
5200	3.48	0.21	3.69	17.00	Pass
5240	3.29	0.21	3.50	17.00	Pass

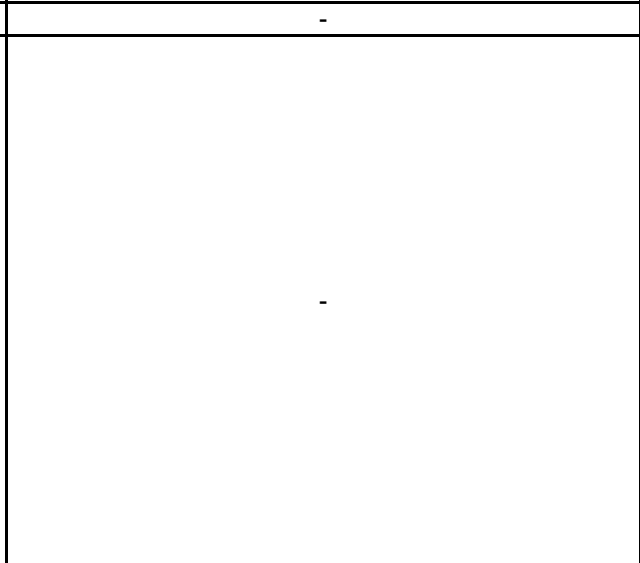
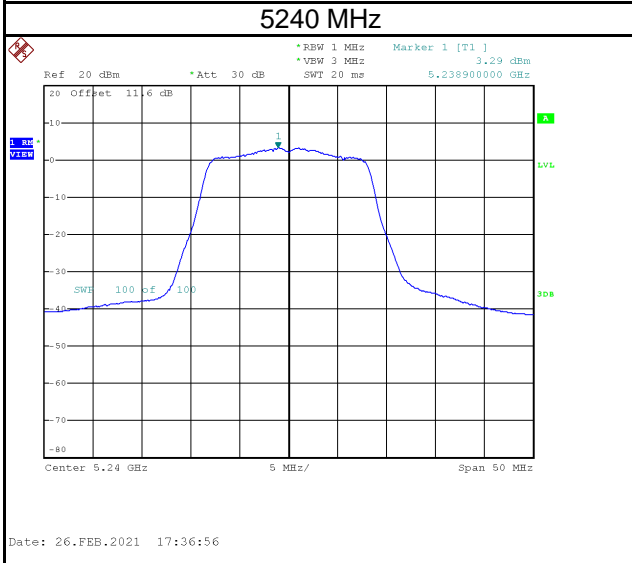
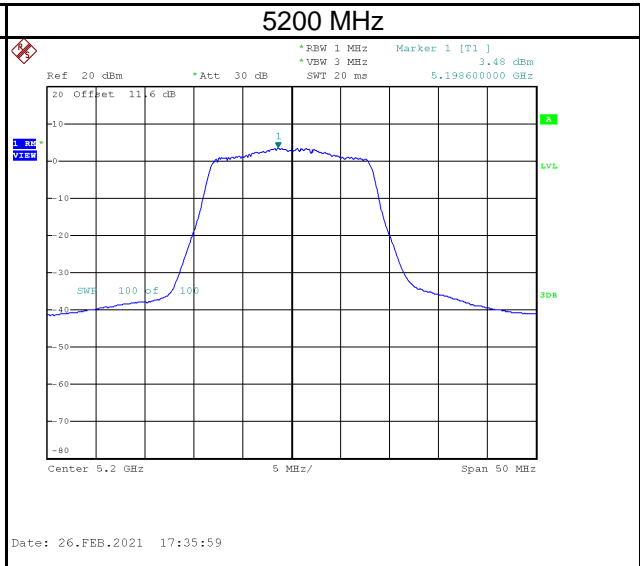
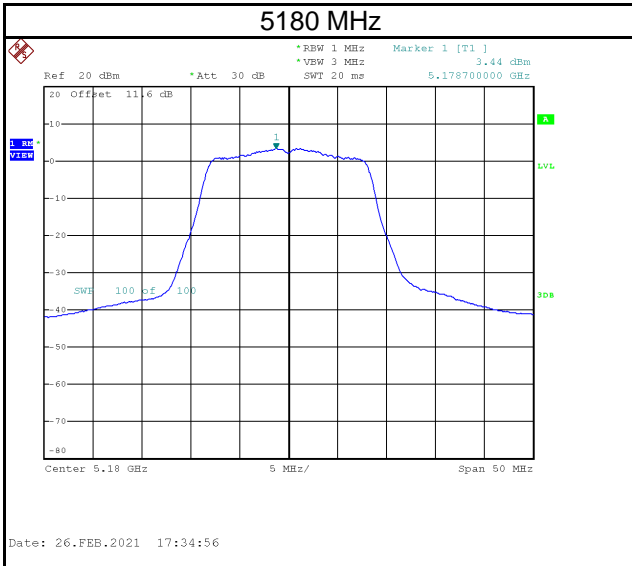

Test Frequency (MHz)	Power Density (dBm/MHz)	Duty Factor (dB)	Calculated Power Density (dBm/MHz)	Maximum Limit (dBm/MHz)	Result
5260	3.05	0.21	3.26	11.00	Pass
5300	3.08	0.21	3.29	11.00	Pass
5320	3.08	0.21	3.29	11.00	Pass

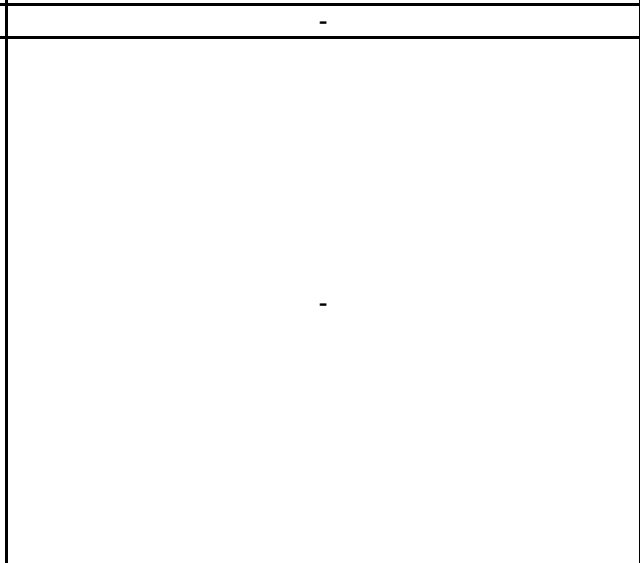
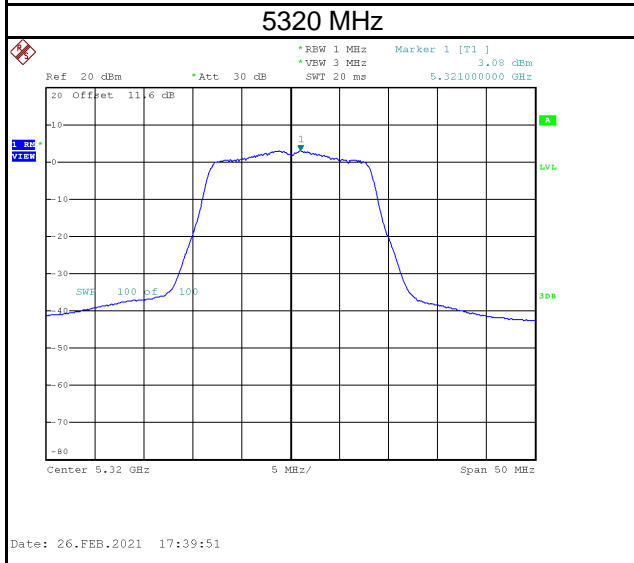
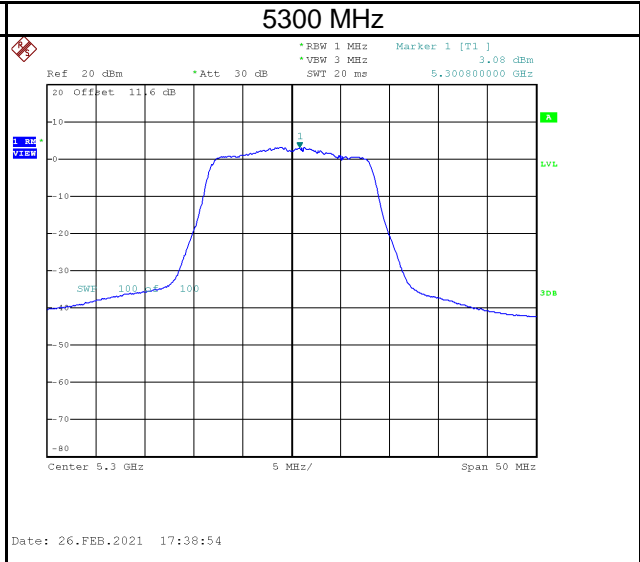
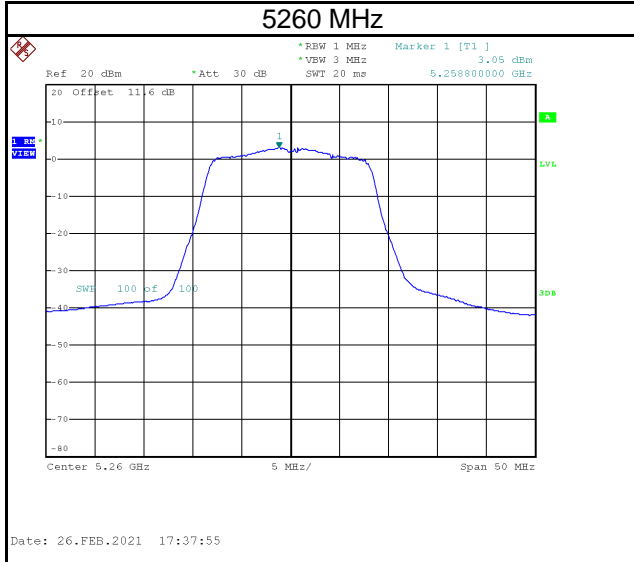

Test Frequency (MHz)	Power Density (dBm/MHz)	Duty Factor (dB)	Calculated Power Density (dBm/MHz)	Maximum Limit (dBm/MHz)	Result
5500	0.80	0.21	1.01	11.00	Pass
5580	0.53	0.21	0.74	11.00	Pass
5700	-0.61	0.21	-0.40	11.00	Pass

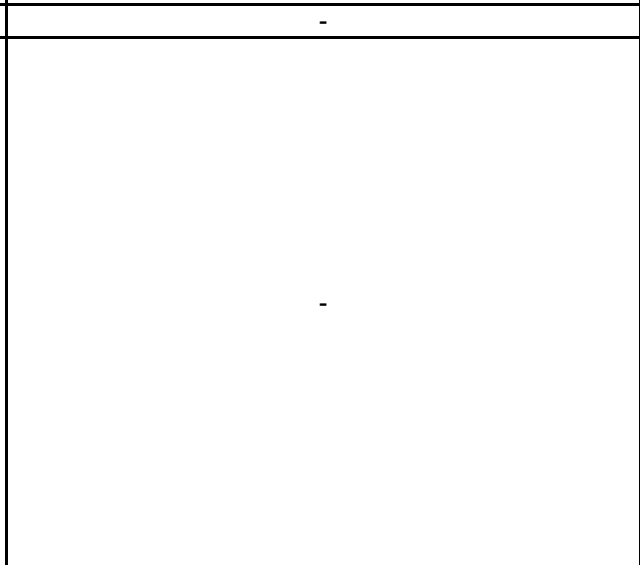
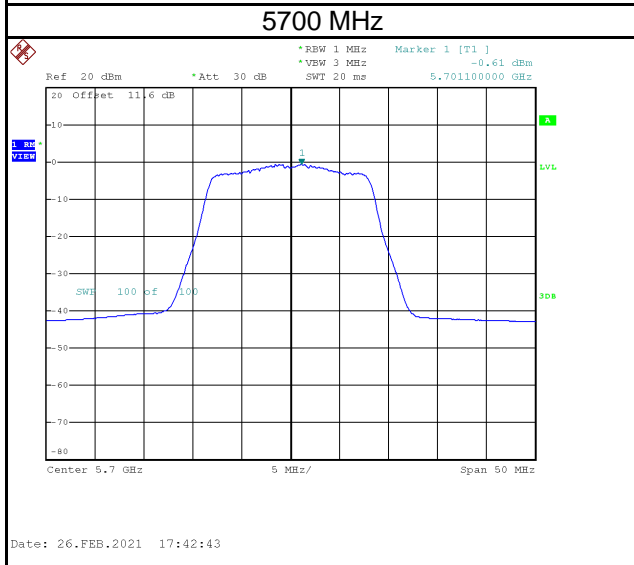
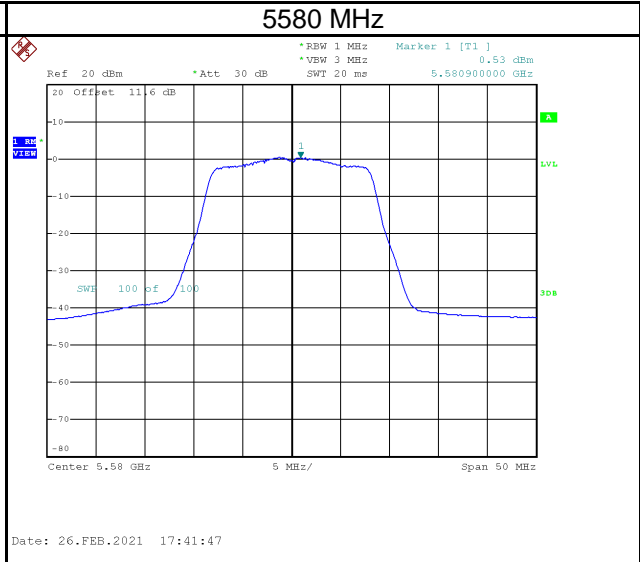
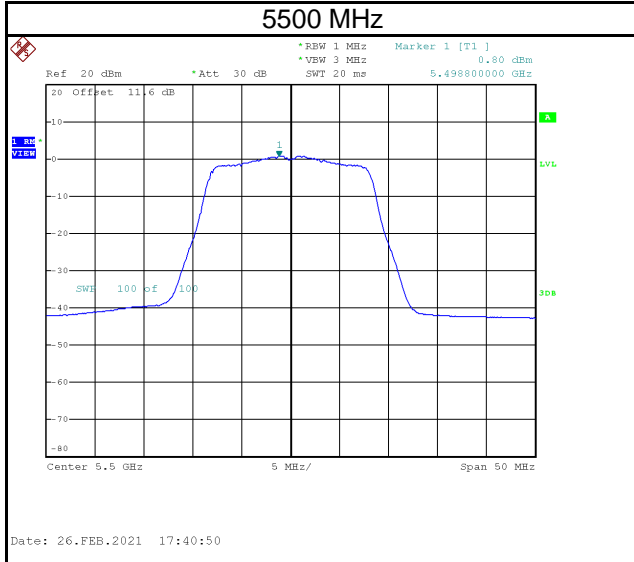

Test Frequency (MHz)	Power Density (dBm/100 kHz)	Power Density (dBm/500 kHz)	Duty Factor (dB)	Calculated Power Density (dBm/500 kHz)	Maximum Limit (dBm/500 kHz)	Result
5745	-1.72	5.27	0.21	5.48	30.00	Pass
5785	-2.01	4.98	0.21	5.19	30.00	Pass
5825	-3.02	3.97	0.21	4.18	30.00	Pass

NOTE: $PSD_{dBm/500\text{ kHz}} = PSD_{dBm/100\text{ kHz}} + 10 \times \log_{10}(500\text{ kHz} / 100\text{ kHz})$

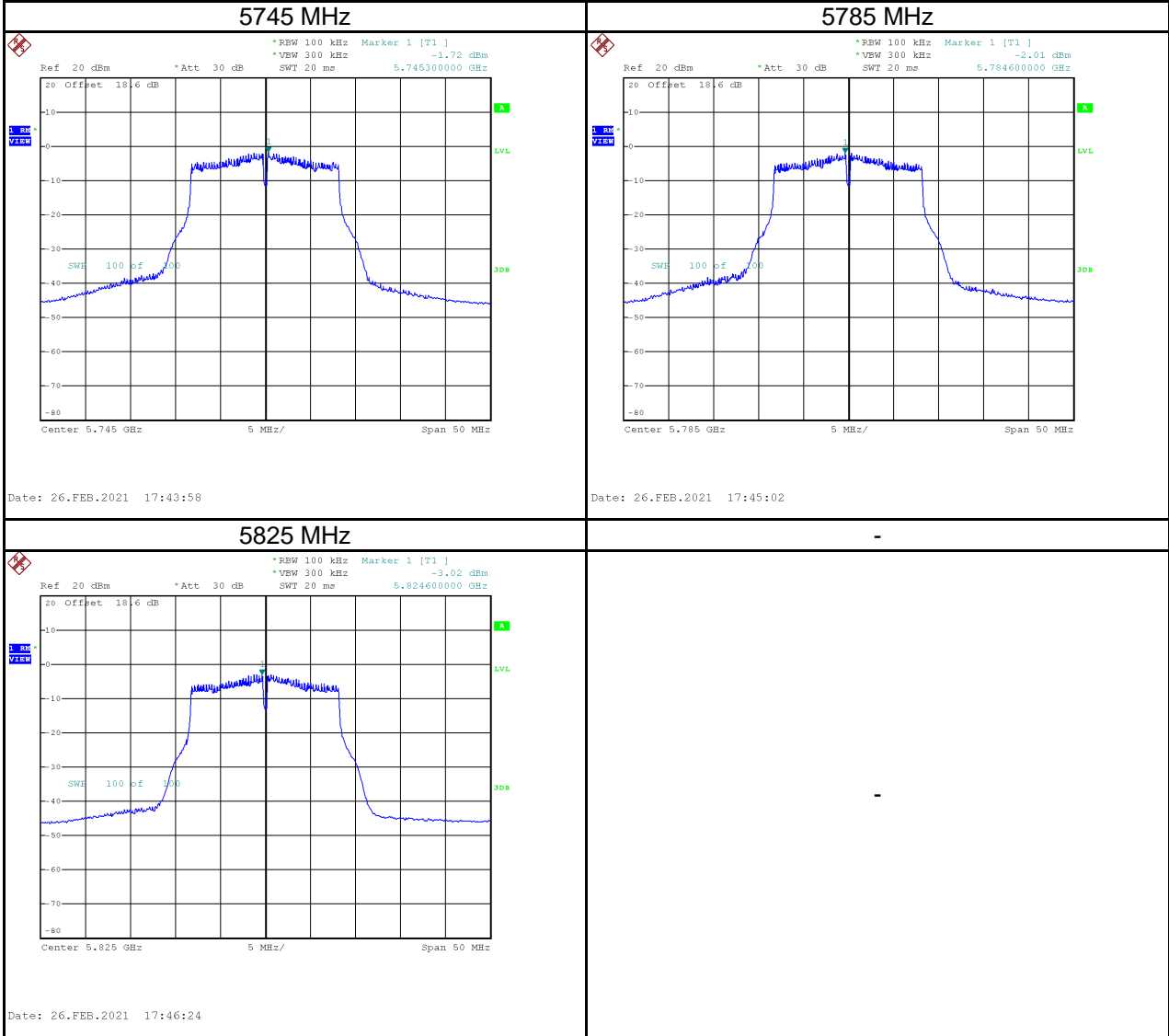

Test Mode	IEEE 802.11n (HT20)
-----------	---------------------

Test Frequency (MHz)	Power Density (dBm/MHz)	Duty Factor (dB)	Calculated Power Density (dBm/MHz)	Maximum Limit (dBm/MHz)	Result
5180	2.74	0.23	2.97	17.00	Pass
5200	2.84	0.23	3.07	17.00	Pass
5240	2.55	0.23	2.78	17.00	Pass

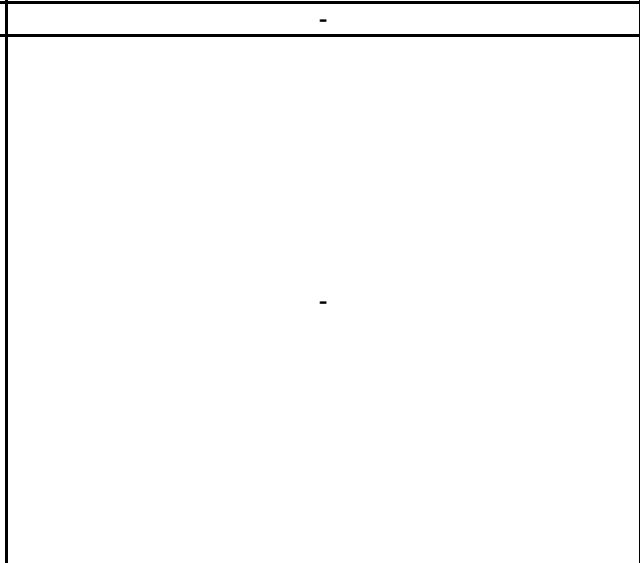
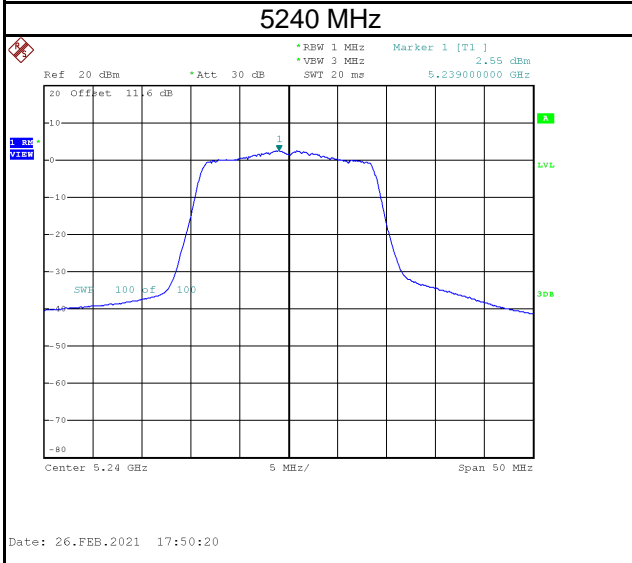
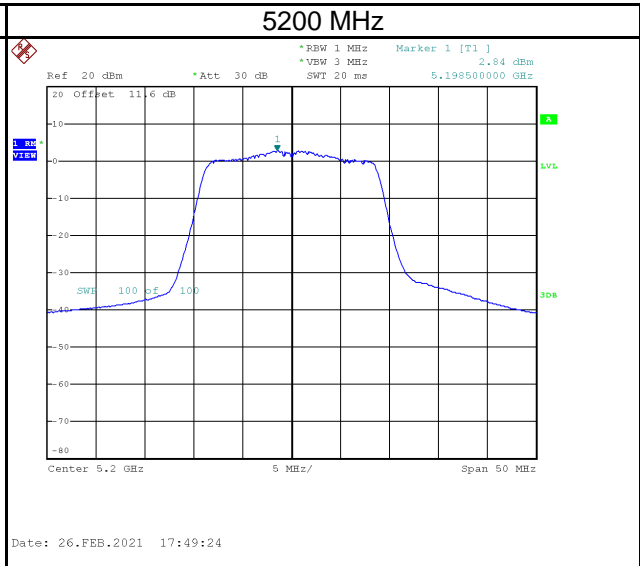
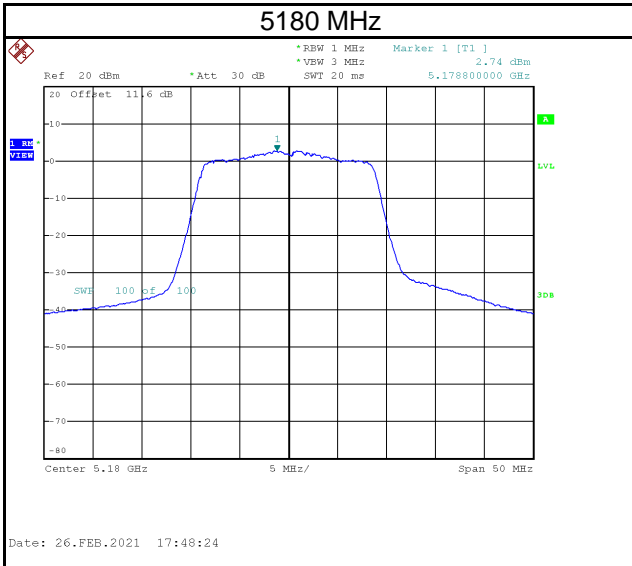

Test Frequency (MHz)	Power Density (dBm/MHz)	Duty Factor (dB)	Calculated Power Density (dBm/MHz)	Maximum Limit (dBm/MHz)	Result
5260	2.45	0.23	2.68	11.00	Pass
5300	2.35	0.23	2.58	11.00	Pass
5320	2.38	0.23	2.61	11.00	Pass

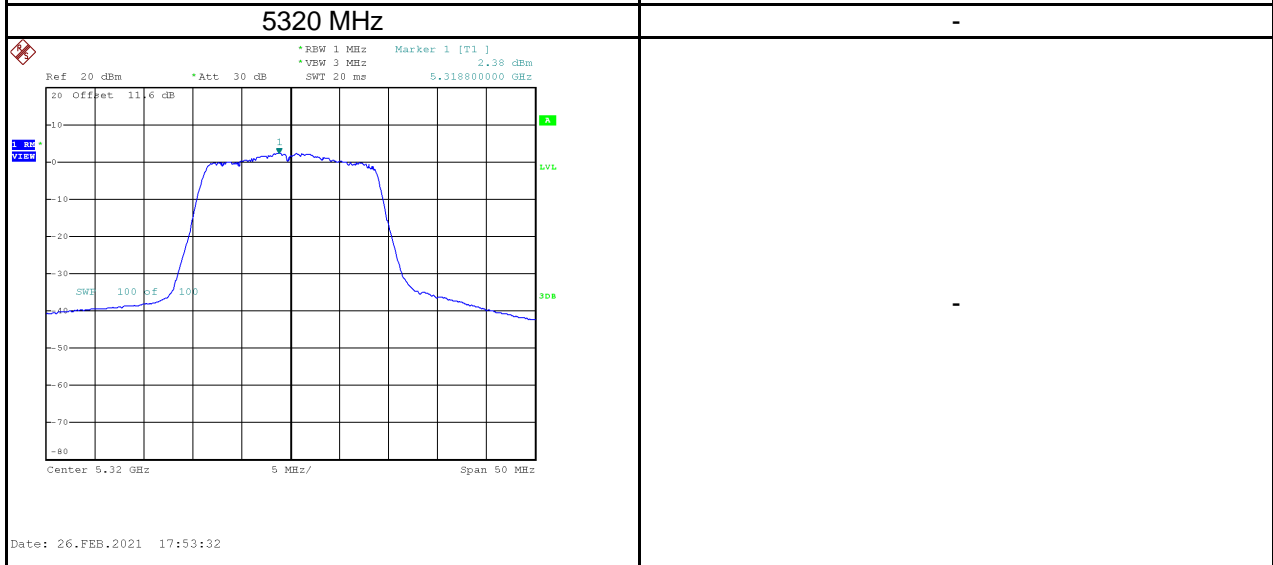
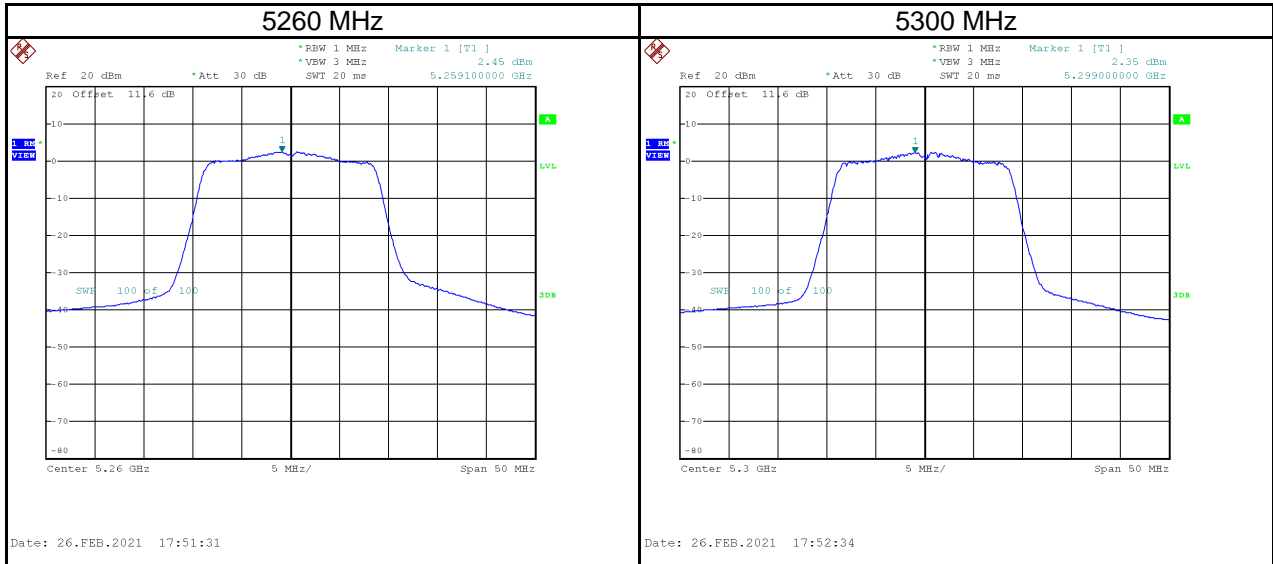

Test Frequency (MHz)	Power Density (dBm/MHz)	Duty Factor (dB)	Calculated Power Density (dBm/MHz)	Maximum Limit (dBm/MHz)	Result
5500	0.15	0.23	0.38	11.00	Pass
5580	-0.18	0.23	0.05	11.00	Pass
5700	-1.35	0.23	-1.12	11.00	Pass

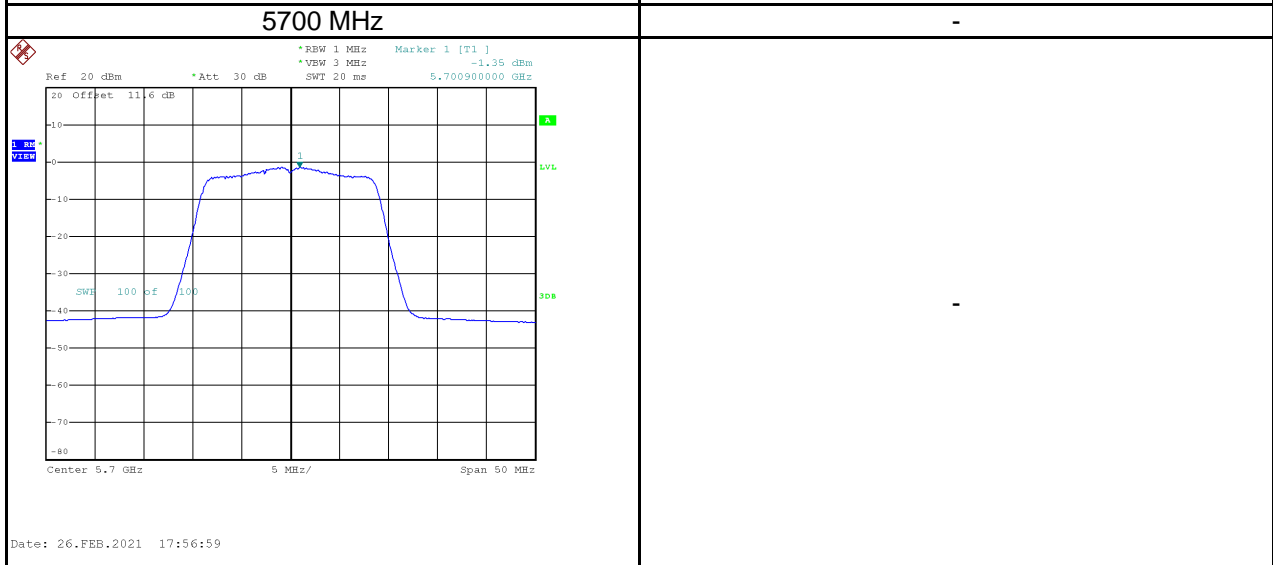
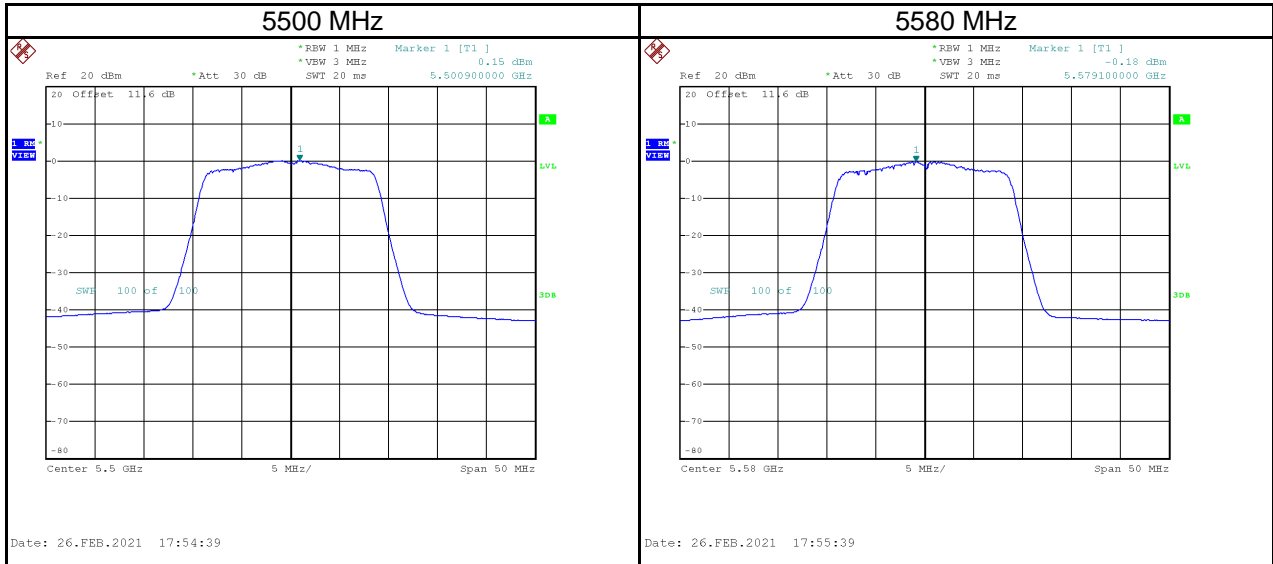

Test Frequency (MHz)	Power Density (dBm/100 kHz)	Power Density (dBm/500 kHz)	Duty Factor (dB)	Calculated Power Density (dBm/500 kHz)	Maximum Limit (dBm/500 kHz)	Result
5745	-2.39	4.60	0.23	4.83	30.00	Pass
5785	-2.73	4.26	0.23	4.49	30.00	Pass
5825	-3.70	3.29	0.23	3.52	30.00	Pass

NOTE: $PSD_{dBm/500\text{ kHz}} = PSD_{dBm/100\text{ kHz}} + 10 \times \log_{10}(500\text{ KHz} / 100\text{ kHz})$

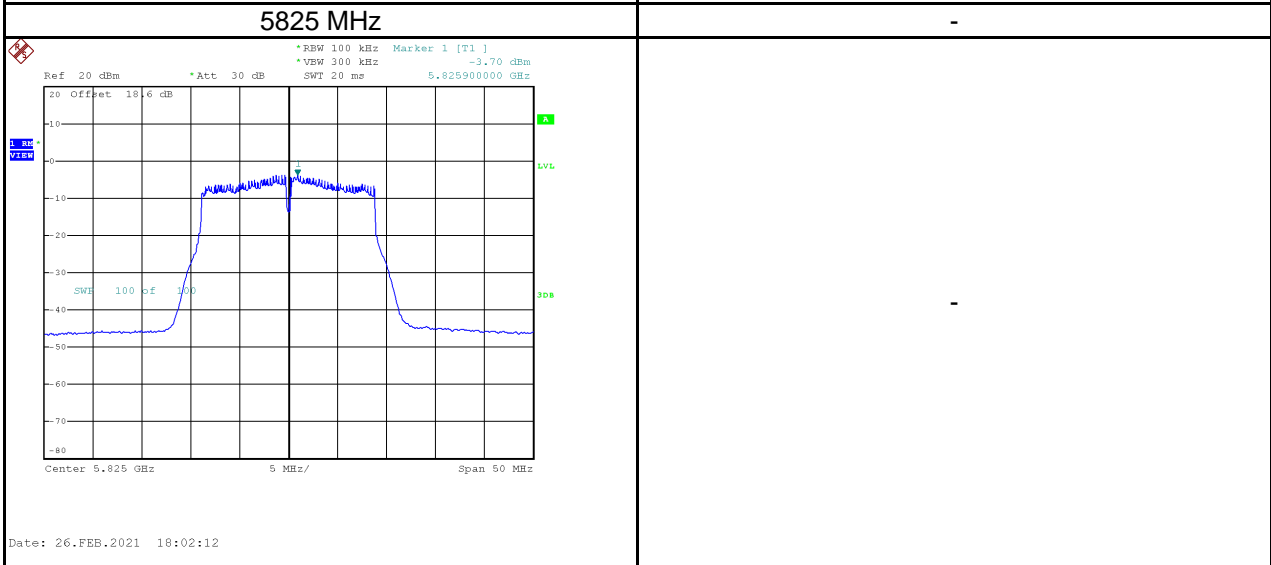
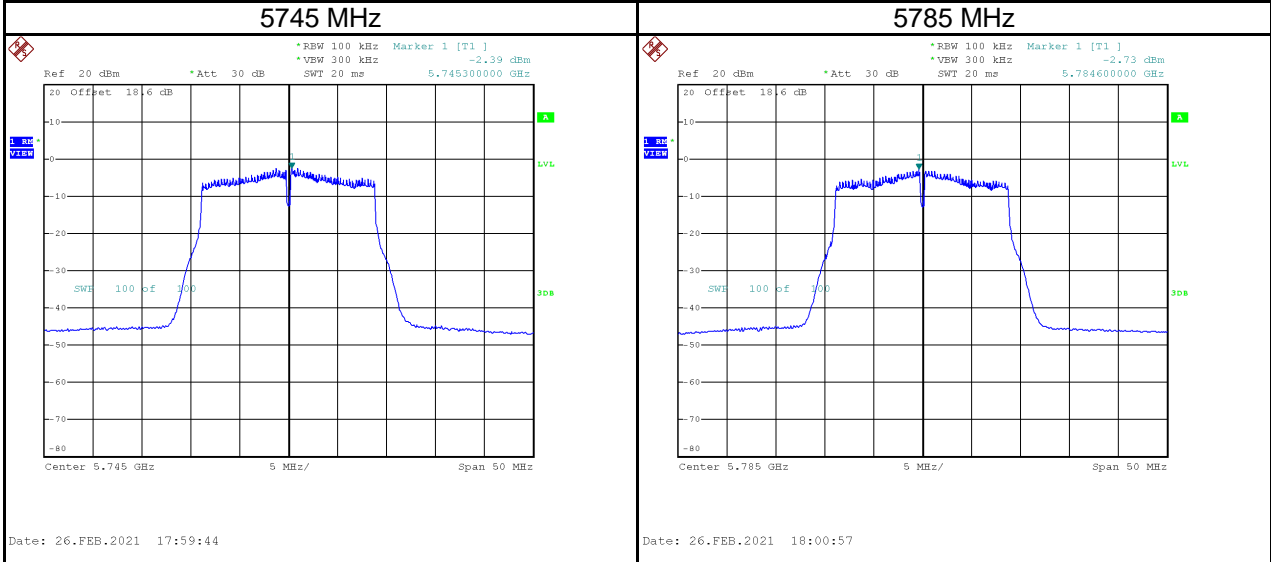

Test Mode	IEEE 802.11n (HT40)
-----------	---------------------

Test Frequency (MHz)	Power Density (dBm/MHz)	Duty Factor (dB)	Calculated Power Density (dBm/MHz)	Maximum Limit (dBm/MHz)	Result
5190	-3.77	0.50	-3.27	17.00	Pass
5230	-3.71	0.50	-3.21	17.00	Pass

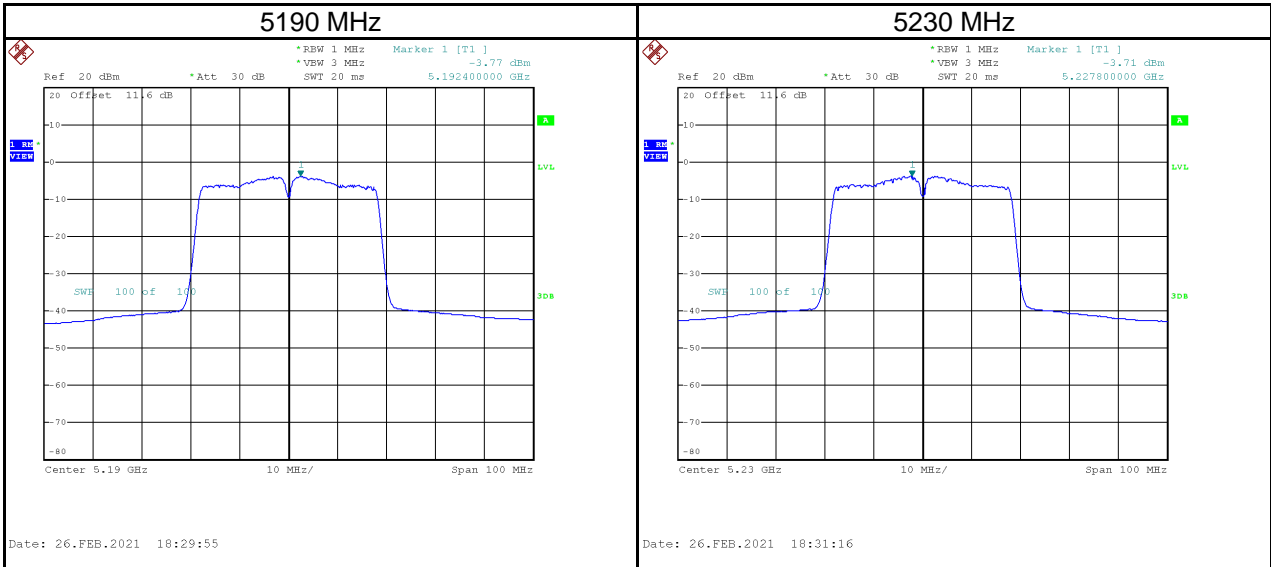

Test Frequency (MHz)	Power Density (dBm/MHz)	Duty Factor (dB)	Calculated Power Density (dBm/MHz)	Maximum Limit (dBm/MHz)	Result
5270	-3.77	0.50	-3.27	11.00	Pass
5310	-3.92	0.50	-3.42	11.00	Pass

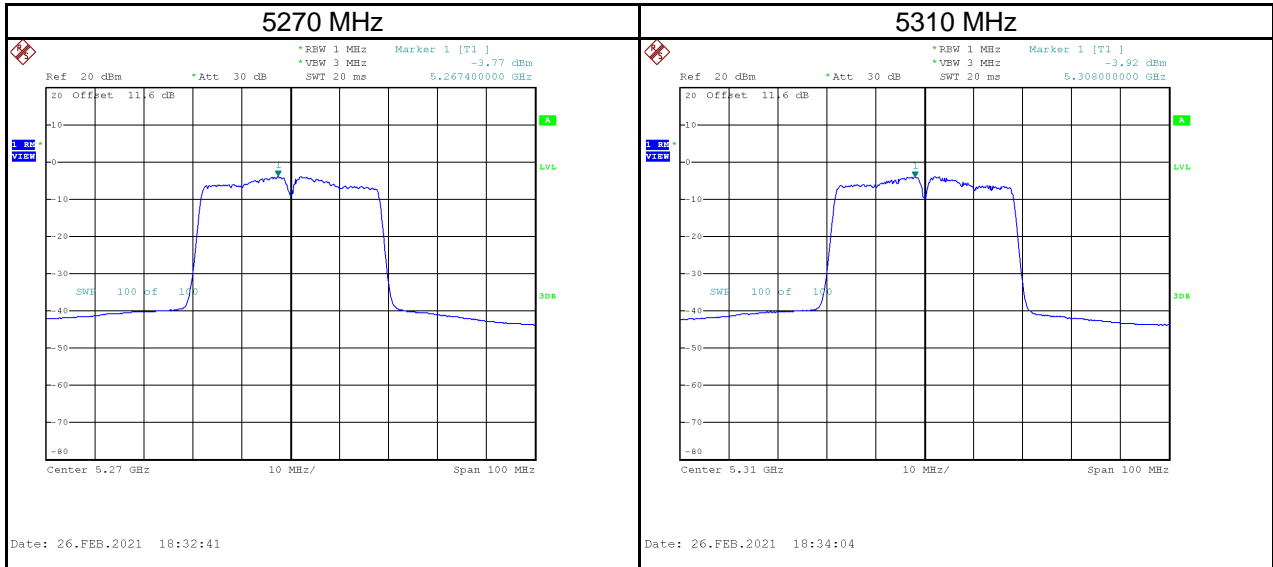

Test Frequency (MHz)	Power Density (dBm/MHz)	Duty Factor (dB)	Calculated Power Density (dBm/MHz)	Maximum Limit (dBm/MHz)	Result
5510	-3.72	0.50	-3.22	11.00	Pass
5550	-3.79	0.50	-3.29	11.00	Pass
5670	-4.71	0.50	-4.21	11.00	Pass

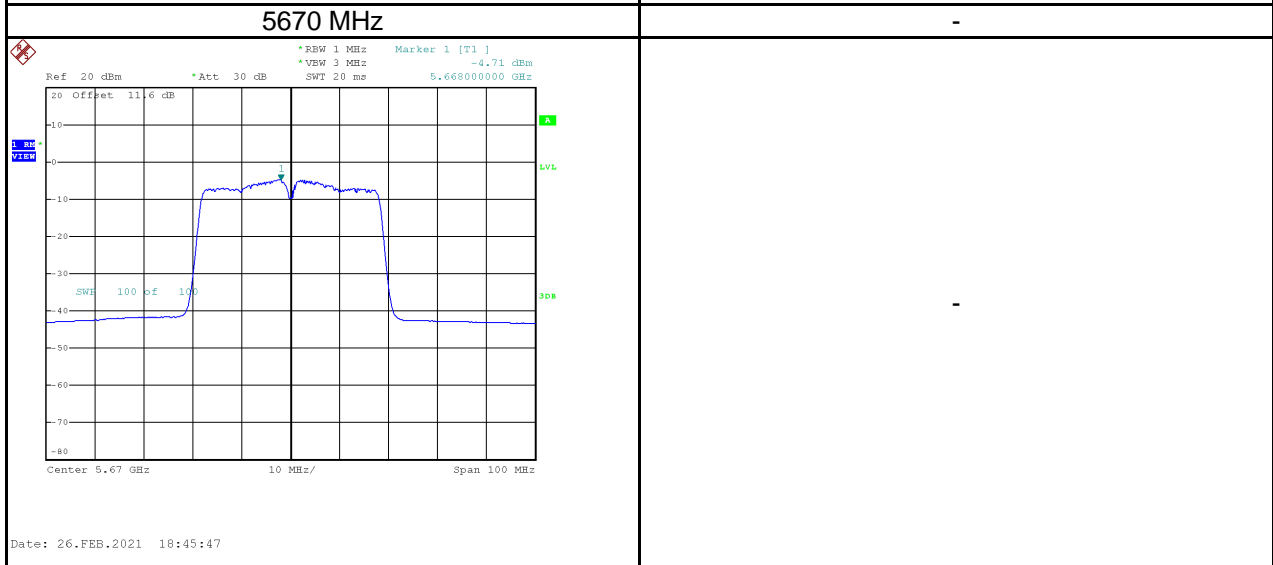
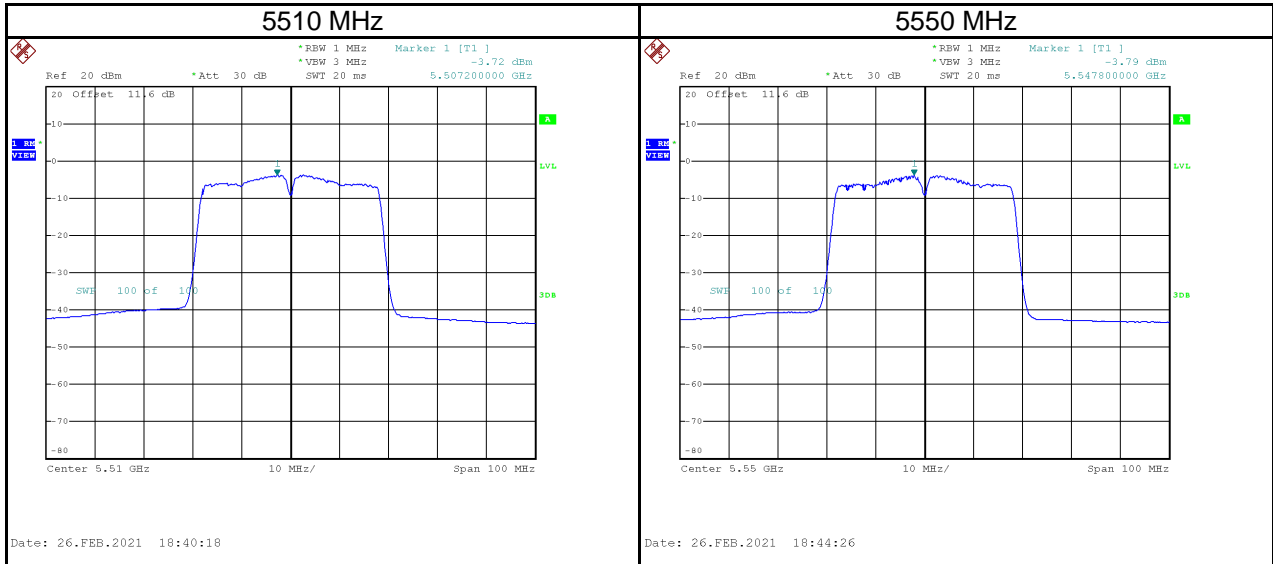

Test Frequency (MHz)	Power Density (dBm/100 kHz)	Power Density (dBm/500 kHz)	Duty Factor (dB)	Calculated Power Density (dBm/500 kHz)	Maximum Limit (dBm/500 kHz)	Result
5755	-7.07	-0.08	0.50	0.42	30.00	Pass
5795	-7.20	-0.21	0.50	0.29	30.00	Pass

NOTE: $PSD_{dBm/500\text{ kHz}} = PSD_{dBm/100\text{ kHz}} + 10 \times \log_{10}(500\text{ kHz} / 100\text{ kHz})$

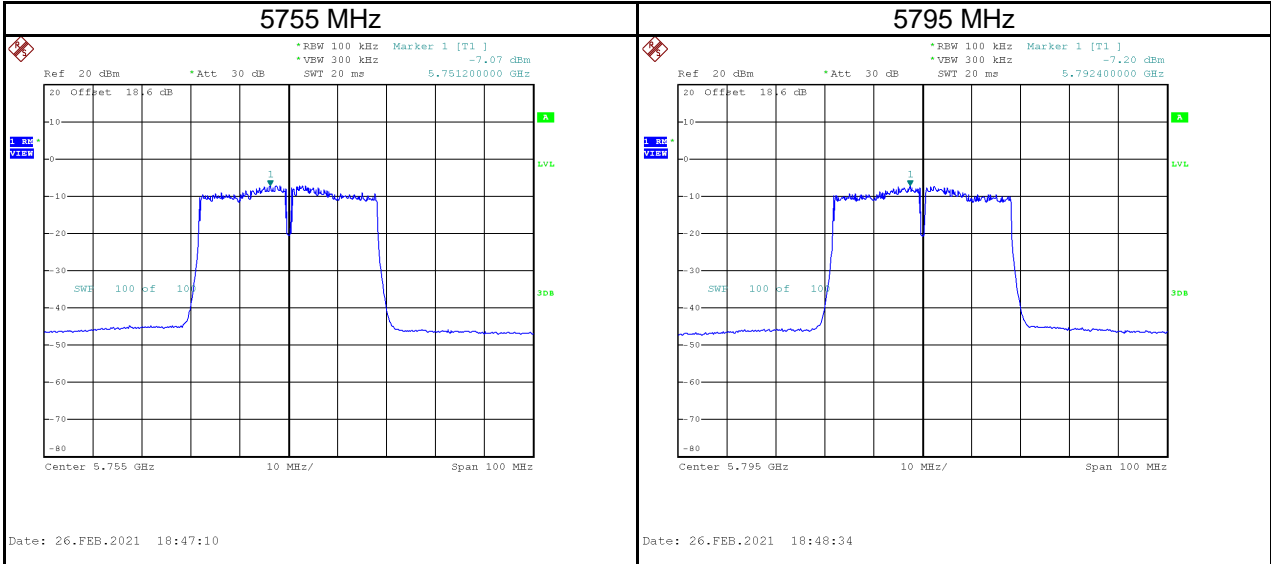

End of Test Report