

FCC Radio Test Report

FCC ID: 2ATYCHMX04

Report No. : BTL-FCCP-5-2101T111
Equipment : HIPCAM
Model Name : Outdoor Spotlight Camera Max
Brand Name : HIPCAM
Applicant : Hipcam Global LLC
Address : 112 Capitol Trail, Newark, Delaware, 19711 United States
Manufacturer : Goldtek Technology Co., Ltd.
Address : 16F., No.166, Jian 1st Rd., Zhonghe Dist., New Taipei City 235, Taiwan (R.O.C.)

Radio Function : RLAN 5 GHz (U-NII 2A, U-NII 2C)

FCC Rule Part(s) : FCC Part 15, Subpart E (15.407) / FCC 06-96
Measurement Procedure(s) : FCC KDB 789033 D02 General U-NII Test Procedures New Rules v02r01
FCC KDB 905462 D02 UNII DFS Compliance Procedures New Rules v02
FCC KDB 905462 D03 UNII Clients Without Radar Detection New Rules v01r02

Date of Receipt : 2021/2/2
Date of Test : 2021/2/2 ~ 2021/3/17
Issued Date : 2021/4/20

The above equipment has been tested and found in compliance with the requirement of the above standards by BTL Inc.

Prepared by : 
Peter Chen, Engineer



Approved by : 
Scott Hsu, Manager

BTL Inc.
No.18, Ln. 171, Sec. 2, Jiuzong Rd., Neihu Dist., Taipei City 114, Taiwan
Tel: +886-2-2657-3299 Fax: +886-2-2657-3331 Web: www.newbtl.com

Declaration

BTL represents to the client that testing is done in accordance with standard procedures as applicable and that test instruments used has been calibrated with standards traceable to international standard(s) and/or national standard(s).

BTL's reports apply only to the specific samples tested under conditions. It is manufacture's responsibility to ensure that additional production units of this model are manufactured with the identical electrical and mechanical components. **BTL** shall have no liability for any declarations, inferences or generalizations drawn by the client or others from **BTL** issued reports.

This report is the confidential property of the client. As a mutual protection to the clients, the public and ourselves, the test report shall not be reproduced, except in full, without our written approval.

BTL's laboratory quality assurance procedures are in compliance with the **ISO/IEC 17025** requirements, and accredited by the conformity assessment authorities listed in this test report.

BTL is not responsible for the sampling stage, so the results only apply to the sample as received.

The information, data and test plan are provided by manufacturer which may affect the validity of results, so it is manufacturer's responsibility to ensure that the apparatus meets the essential requirements of applied standards and in all the possible configurations as representative of its intended use.

Limitation

For the use of the authority's logo is limited unless the Test Standard(s)/Scope(s)/Item(s) mentioned in this test report is (are) included in the conformity assessment authorities acceptance respective.

Please note that the measurement uncertainty is provided for informational purpose only and are not use in determining the Pass/Fail results.

CONTENTS

REVISION HISTORY	4
1 EUT INFORMATION	5
1.1 EUT SPECIFICATION TABLE	5
1.2 EIRP POWER	6
2 U-NII DFS RULE REQUIREMENTS	7
2.1 WORKING MODES AND REQUIRED TEST ITEMS	7
2.2 TEST LIMITS AND RADAR SIGNAL PARAMETERS	8
3 DYNAMIC FREQUENCY SELECTION (DFS) TEST	12
3.1 DFS MEASUREMENT SYSTEM	12
3.2 CALIBRATION OF DFS DETECTION THRESHOLD LEVEL	15
3.3 DEVIATION FROM TEST STANDARD	15
4 LIST OF MEASURING EQUIPMENTS	16
5 TEST RESULTS	17
5.1 SUMMARY OF TEST RESULT	17
5.2 EST MODE: DEVICE OPERATING IN MASTER MODE.	17
5.3 CHANNEL CLOSING TRANSMISSION AND CHANNEL MOVE TIME WLAN TRAFFIC	18
5.4 NON- OCCUPANCY PERIOD	21
6 EUT TEST PHOTO	22
7 EUT PHOTOS	22

REVISION HISTORY

Report No.	Version	Description	Issued Date
BTL-FCCP-5-2101T111	R00	Original Report.	2021/4/9
BTL-FCCP-5-2101T111	R01	Revised report to address TCB's comments.	2021/4/20

1 EUT INFORMATION

1.1 EUT SPECIFICATION TABLE

Table 1: Specification of EUT

Equipment	HIPCAM
Model Name	Outdoor Spotlight Camera Max
Brand Name	HIPCAM
Model Difference	N/A
Power Source	DC Voltage supplied from AC/DC adapter.
Power Rating	I/P: 100-240V~ 50/60Hz 0.6A Max O/P: 12.0Vdc 2.0A 24.0W
Products Covered	1 * Adapter: SIMSUKIAN / SK03T-1200200Z 1 * Base
Operational Mode	<input type="checkbox"/> Master <input type="checkbox"/> Slave with radar detection <input checked="" type="checkbox"/> Slave without radar detection
Operation Band	UNII-2A: 5250 MHz to 5350 MHz UNII-2C: 5470 MHz to 5725 MHz
Operating Frequency	UNII-2A: 5260 MHz to 5320 MHz UNII-2C: 5500 MHz to 5700 MHz
Modulation	OFDM
Test Model	Outdoor Spotlight Camera Max
Sample Status	Engineering Sample
EUT Modification(s)	N/A

NOTE:

(1) For a more detailed features description, please refer to the manufacturer's specifications or the user's manual.

(2) Channel List:

IEEE 802.11a IEEE 802.11n (HT20)		IEEE 802.11n (HT40)	
UNII-2A		UNII-2A	
Channel	Frequency (MHz)	Channel	Frequency (MHz)
52	5260	54	5270
56	5280	62	5310
60	5300		
64	5320		

IEEE 802.11a IEEE 802.11n (HT20)		IEEE 802.11n (HT40)	
UNII-2C		UNII-2C	
Channel	Frequency (MHz)	Channel	Frequency (MHz)
100	5500	102	5510
104	5520	110	5550
108	5540	118	5590
112	5560	126	5630
116	5580	134	5670
120	5600		
124	5620		
128	5640		
132	5660		
136	5680		
140	5700		

(3) Table for Filed Antenna:

Ant.	Manufacture	Product	Type	Connector	Frequency Range (MHz)	Gain (dBi)
1	PSA	Wi-Fi Ant.	PCB	N/A	5250-5350	5.38
					5470-5725	5.23

1.2 EIRP POWER

Table 2: The Conducted Output Power and EIRP List

Test Mode	UNII-2A
-----------	---------

Frequency (MHz)	Maximum Conducted Power (dBm)	Antenna Gain (dBi)	Maximum EIRP Power (dBm)	Maximum EIRP Power (mW)	Remark
5260 to 5320	13.49	5.38	18.87	77.09	NOTE (1)

Test Mode	UNII-2C
-----------	---------

Frequency (MHz)	Maximum Conducted Power (dBm)	Antenna Gain (dBi)	Maximum EIRP Power (dBm)	Maximum EIRP Power (mW)	Remark
5500 to 5700	10.53	5.23	15.76	37.67	NOTE (1)

NOTE:

- (1) EIRP Power (dBm) = Conducted Power (dBm) + Antenna Gain (dBi).
 Power (mW) = $1 \text{ mW} * 10^{(\text{dBm} / 10)}$.

2 U-NII DFS RULE REQUIREMENTS

2.1 WORKING MODES AND REQUIRED TEST ITEMS

The manufacturer shall state whether the UUT is capable of operating as a Master and/or a Client. If the UUT is capable of operating in more than one operating mode then each operating mode shall be tested separately. See tables 3 and 4 for the applicability of DFS requirements for each of the operational modes.

Table 3: Applicability of DFS requirements prior to use a channel

Requirement	Operational Mode		
	Master	Client without radar detection	Client with radar detection
Non-Occupancy Period	✓	Not required	✓
DFS Detection Threshold	✓	Not required	✓
Channel Availability Check Time	✓	Not required	Not required
Uniform Spreading	✓	Not required	Not required
U-NII Detection Bandwidth	✓	Not required	✓

Table 4: Applicability of DFS requirements during normal operation.

Requirement	Operational Mode		
	Master	Client without radar detection	Client with radar detection
DFS Detection Threshold	✓	Not required	✓
Channel Closing Transmission Time	✓	✓	✓
Channel Move Time	✓	✓	✓
U-NII Detection Bandwidth	✓	Not required	✓

2.2 TEST LIMITS AND RADAR SIGNAL PARAMETERS

DETECTION THRESHOLD VALUES

Table 5: DFS Detection Thresholds for Master Devices and Client Devices With Radar Detection.

Maximum Transmit Power	Value (See Notes 1 and 2)
EIRP \geq 200 milliwatt	-64 dBm
EIRP < 200 milliwatt and Power spectral density < 10 dBm/MHz	-62 dBm
EIRP < 200 milliwatt that do not meet the power spectral density requirement	-64 dBm

Note 1: This is the level at the input of the receiver assuming a 0 dBi receive antenna.

Note 2: Throughout these test procedures an additional 1 dB has been added to the amplitude of the test transmission waveforms to account for variations in measurement equipment. This will ensure that the test signal is at or above the detection threshold level to trigger a DFS response.

Note3: EIRP is based on the highest antenna gain. For MIMO devices refer to KDB Publication 662911 D01.

Table 6: DFS Response Requirement Values

Parameter	Value
Non-occupancy period	Minimum 30 minutes
Channel Availability Check Time	60 seconds
Channel Move Time	10 seconds See Note 1.
Channel Closing Transmission Time	200 milliseconds + an aggregate of 60 milliseconds over remaining 10 second period. See Notes 1 and 2.
U-NII Detection Bandwidth	Minimum 100% of the UNII 99% transmission power bandwidth. See Note 3.

Note 1: Channel Move Time and the Channel Closing Transmission Time should be performed with Radar Type 0. The measurement timing begins at the end of the Radar Type 0 burst.

Note 2: The Channel Closing Transmission Time is comprised of 200 milliseconds starting at the beginning of the Channel Move Time plus any additional intermittent control signals required to facilitate a Channel move (an aggregate of 60 milliseconds) during the remainder of the 10 second period. The aggregate duration of control signals will not count quiet periods in between transmissions.

Note 3: During the U-NII Detection Bandwidth detection test, radar type 0 should be used. For each frequency step the minimum percentage of detection is 90 percent. Measurements are performed with no data traffic.

PARAMETERS OF DFS TEST SIGNALS

Step intervals of 0.1 microsecond for Pulse Width, 1 microsecond for PRI, 1 MHz for chirp width and 1 for the number of pulses will be utilized for the random determination of specific test waveforms.

Table 7: Short Pulse Radar Test Waveforms.

Radar Type	Pulse Width (μsec)	PRI (μsec)	Number of Pulses	Minimum Percentage of Successful Detection	Minimum Number of Trials
0	1	1428	18	See Note 1	See Note 1
1	1	Test A: 15 unique PRI values randomly selected from the list of 23 PRI values in Table 5a	Roundup $\left\{ \begin{matrix} \left(\frac{1}{360} \right) \cdot \\ \left(\frac{19 \cdot 10^6}{PRI_{\mu sec}} \right) \end{matrix} \right\}$	60%	30
		Test B: 15 unique PRI values randomly selected within the range of 518-3066 μsec, with a minimum increment of 1 μsec, excluding PRI values selected in Test A			
2	1-5	150-230	23-29	60%	30
3	6-10	200-500	16-18	60%	30
4	11-20	200-500	12-16	60%	30
Aggregate (Radar Types 1-4)				80%	120
Note 1: Short Pulse Radar Type 0 should be used for the detection bandwidth test, channel move time, and channel closing time tests.					

A minimum of 30 unique waveforms are required for each of the Short Pulse Radar Types 2 through 4. If more than 30 waveforms are used for Short Pulse Radar Types 2 through 4, then each additional waveform must also be unique and not repeated from the previous waveforms. If more than 30 waveforms are used for Short Pulse Radar Type 1, then each additional waveform is generated with Test B and must also be unique and not repeated from the previous waveforms in Tests A or B.

Table 8: Long Pulse Radar Test Waveform

Radar Type	Pulse Width (μsec)	Chirp Width (MHz)	PRI (μsec)	Number of Pulses per Burst	Number of Bursts	Minimum Percentage of Successful Detection	Minimum Number of Trials
5	50-100	5-20	1000-2000	1-3	8-20	80%	30

The parameters for this waveform are randomly chosen (The center frequency for each of the 30 trials of the Bin 5 radar shall be randomly selected within 80% of the Occupied Bandwidth.) Thirty unique waveforms are required for the Long Pulse Radar Type waveforms. If more than 30 waveforms are used for the Long Pulse Radar Type waveforms, then each additional waveform must also be unique and not repeated from the previous waveforms.

Table 9: Frequency Hopping Radar Test Waveform

Radar Type	Pulse Width (μsec)	Chirp Width (MHz)	PRI (μsec)	Number of Pulses per Burst	Number of Bursts	Minimum Percentage of Successful Detection	Minimum Number of Trials
6	1	333	9	0.333	300	70%	30

3 DYNAMIC FREQUENCY SELECTION (DFS) TEST

3.1 DFS MEASUREMENT SYSTEM

Test Procedure

1. Master device and client device are set up by conduction method as the following configuration.
2. The client device is connected to notebook and to access a IP address on wireless connection with the master device.
3. Then the master device is connected to another notebook to access a IP address.
4. Finally, let the two IP addresses run traffic with each other through the Run flow software "Lan test" to reach each 17% channel loading as below

Setup

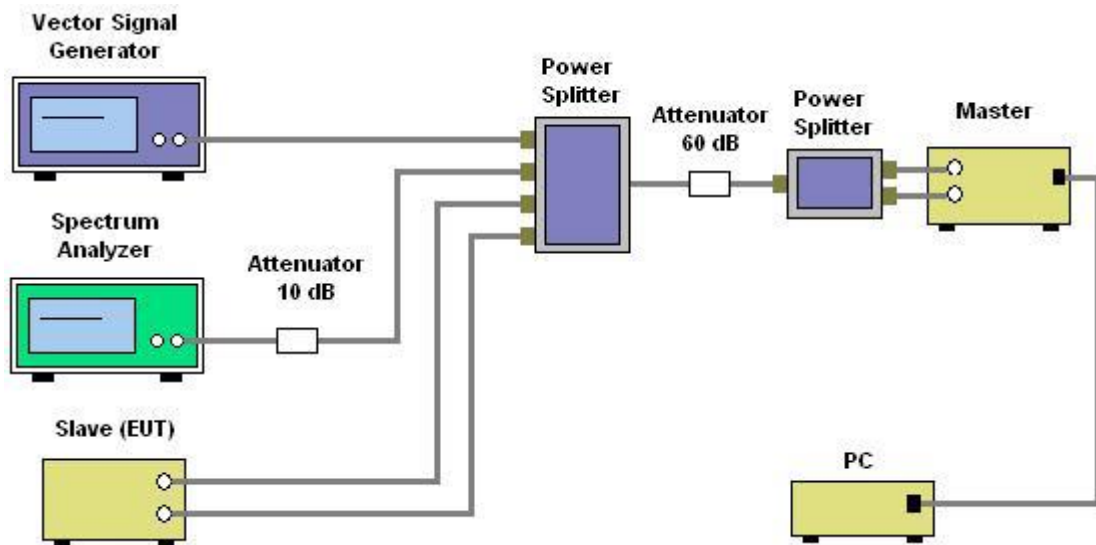

Channel Loading

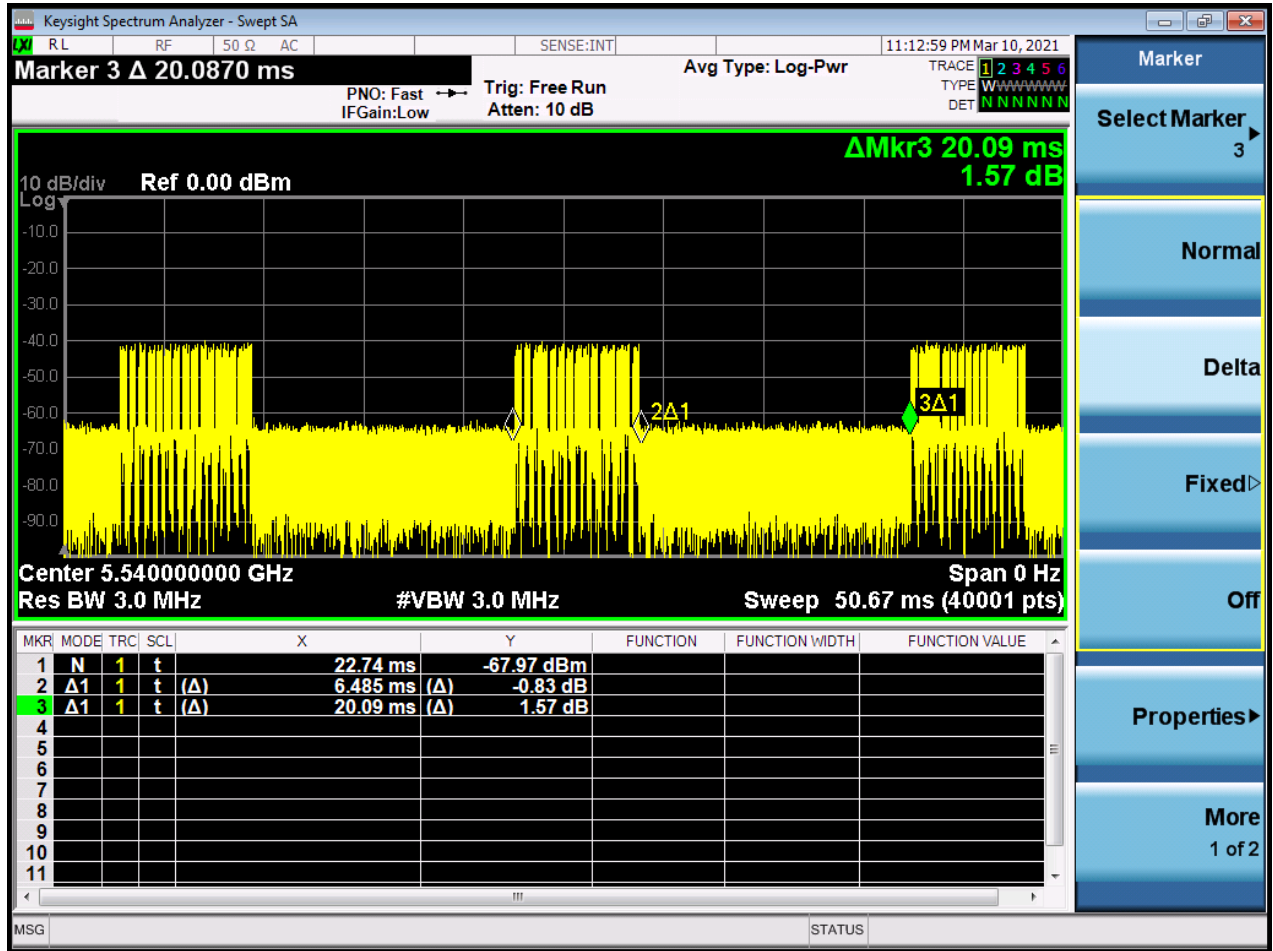

Test Band	ON (ms)	Numbers (ON)	On Time (ms)	Period (ON+OFF) (ms)	Channel Loading Ratio (%)	Required Ratio (%)
5.470 GHz to 5.725 GHz	6.4850	1	6.4850	20.09	32.28%	≥ 17%

The hopping type 6 pulse parameters are fixed while the hopping sequence is based on the August 2005 NTIA Hopping Frequency List. The initial starting point randomized at run-time and each subsequent starting point is incremented by 475. Each frequency in the 100-length segment is compared to the boundaries of the EUT Detection Bandwidth and the software creates a hopping burst pattern in accordance with Section 7.4.1.3 Method #2 Simulated Frequency Hopping Radar Waveform Generating Subsystem of FCC 06-96. The frequency of the signal generator is incremented in 1 MHz steps from FL to FH for each successive trial. This incremental sequence is repeated as required to generate a minimum of 30 total trials and to maintain a uniform frequency distribution over the entire Detection Bandwidth.

The signal monitoring equipment consists of a spectrum analyzer set to display 8001 bins on the horizontal axis. The time-domain resolution is 2 msec / bin with a 16 second sweep time, meeting the 10 second short pulse reporting criteria. The aggregate ON time is calculated by multiplying the number of bins above a threshold during a particular observation period by the dwell time per bin, with the analyzer set to peak detection and max hold.

Should multiple RF ports be utilized for the Master and/or Slave devices (for example, for diversity or MIMO implementations), additional combiner/dividers are inserted between the Master Combiner/Divider and the pad connected to the Master Device (and/or between the Slave Combiner/Divider and the pad connected to the Slave Device). Additional pads are utilized such that there is one pad at each RF port on each EUT.

3.2 CALIBRATION OF DFS DETECTION THRESHOLD LEVEL

A 50 ohm load is connected in place of the spectrum analyzer, and the spectrum analyzer is connected in place of the master device and the signal generator is set to CW mode. The amplitude of the signal generator is adjusted to yield a level of -62 dBm as measured on the spectrum analyzer.

Without changing any of the instrument settings, the spectrum analyzer is reconnected to the Common port of the Spectrum Analyzer Combiner/Divider. Measure the amplitude and calculate the difference from -62 dBm. Adjust the Reference Level Offset of the spectrum analyzer to this difference.

The spectrum analyzer displays the level of the signal generator as received at the antenna ports of the Master Device. The interference detection threshold may be varied from the calibrated value of -62 dBm and the spectrum analyzer will still indicate the level as received by the Master Device.

Set the signal generator to produce a radar waveform, trigger a burst manually and measure the level on the spectrum analyzer. Readjust the amplitude of the signal generator as required so that the peak level of the waveform is at a displayed level equal to the required or desired interference detection threshold. Separate signal generator amplitude settings are determined as required for each radar type.

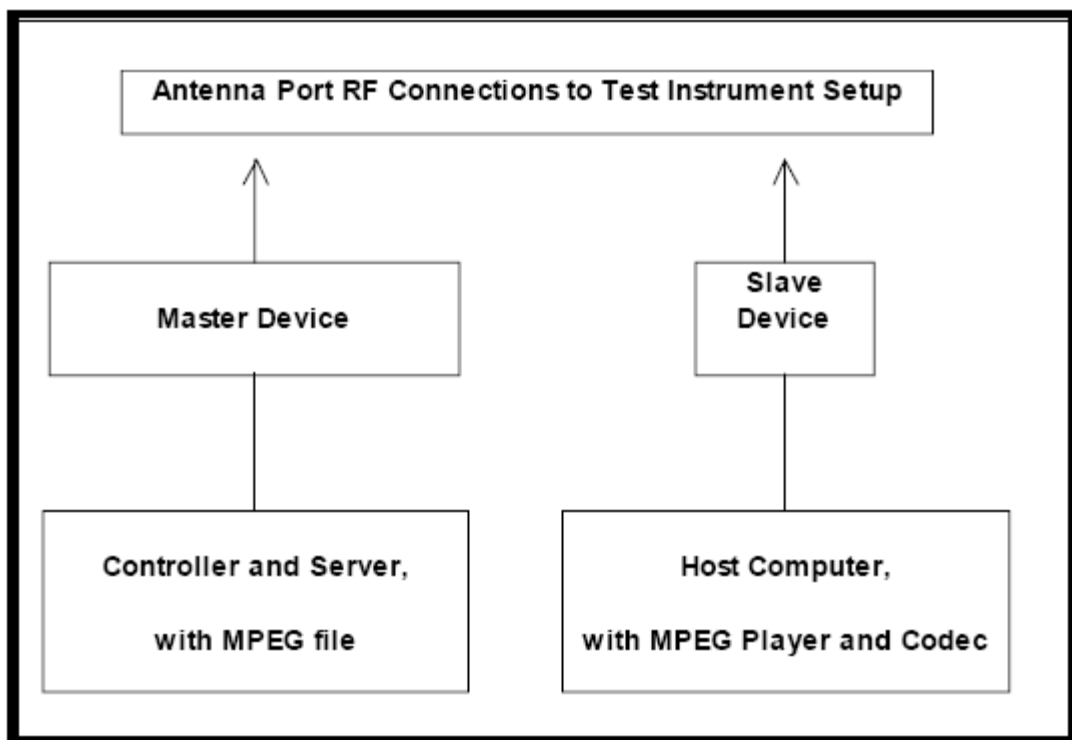

3.3 DEVIATION FROM TEST STANDARD

No deviation.

4 LIST OF MEASURING EQUIPMENTS

Dynamic Frequency Selection (DFS)						
Item	Kind of Equipment	Manufacturer	Type No.	Serial No.	Calibrated Date	Calibrated Until
1	Spectrum Analyzer	Keysight	N9010A	MY54200240	2020/6/11	2021/6/10
2	MXG Vector Signal Generator	Agilent	N5182B	MY51350711	2020/3/25	2021/3/24
3	10dB Attenuators	Mini-Circuits	VAT-10+	N/A	2020/5/14	2021/5/13
4	20dB Attenuators	Mini-Circuits	VAT-20+	N/A	2020/5/14	2021/5/13
5	30dB Attenuators	Mini-Circuits	VAT-30+	N/A	2020/5/14	2021/5/13
6	POWER SPLITTER	Mini-Circuits	ZFRSC-183-S+	N/A	2020/5/14	2021/5/13
7	POWER SPLITTER	Mini-Circuits	ZFRSC-123-S+	N/A	2020/5/14	2021/5/13

Master Device						
Item	Kind of Equipment	Manufacturer	Type No.	FCC ID	IC	Note
1	AP	Check Point	L-71W	YHI-NW121	9715A-NW121	-

Remark: "N/A" denotes no model name, no serial no. or no calibration specified.
 All calibration period of equipment list is one year.

5 TEST RESULTS

5.1 SUMMARY OF TEST RESULT

Clause	Test Parameter	Test Mode and Channel	Remarks	Pass/Fail
15.407	DFS Detection Threshold	-	No Applicable	N/A
15.407	Channel Availability Check Time	-	Not Applicable	N/A
15.407	Channel Move Time	11a 5540 MHz	Applicable	Pass
		11n (HT40) 5550 MHz		
15.407	Channel Closing Transmission Time	11a 5540 MHz	Applicable	Pass
		11n (HT40) 5550 MHz		
15.407	Non- Occupancy Period	11a 5540 MHz	Applicable	Pass
		11n (HT40) 5550 MHz		
15.407	Uniform Spreading	-	Not Applicable	N/A
15.407	U-NII Detection Bandwidth	-	Not Applicable	N/A

NOTE:

1. The report format version is TP.1.1.1.

5.2 EST MODE: DEVICE OPERATING IN MASTER MODE.

The EUT is slave equipment, it need a master device when testing.

Master with injection at the Master. (Radar Test Waveforms are injected into the Master)

5.3 CHANNEL CLOSING TRANSMISSION AND CHANNEL MOVE TIME WLAN TRAFFIC

TX (11a Mode)

Radar signal 0

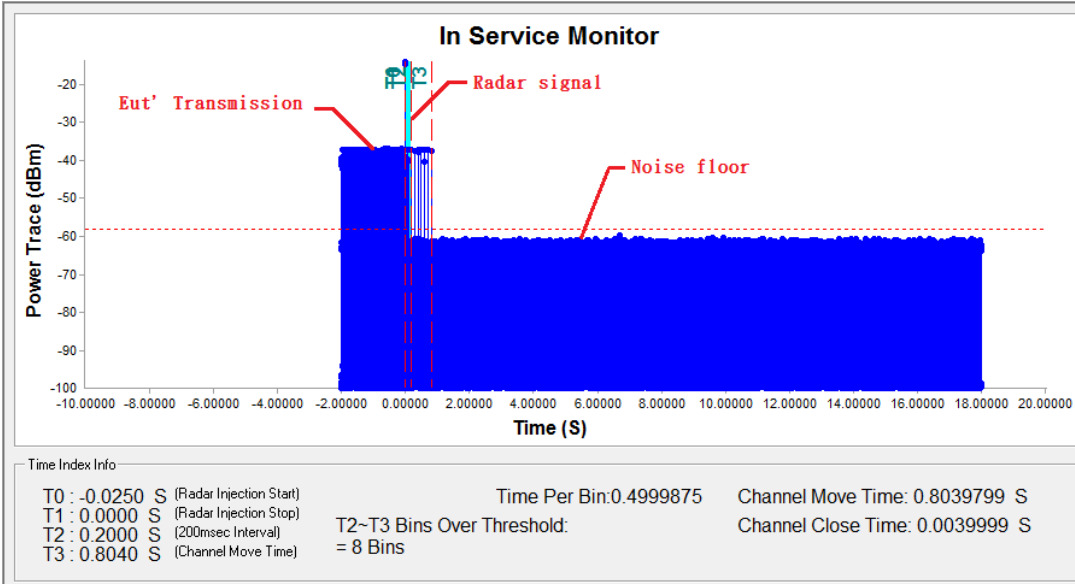

Note: T0 denotes the Radar Injection Start.
 T1 denotes the start of Channel Move Time upon the end of the last Radar burst.
 T2 denotes the data transmission time of 200ms from T1.
 T3 denotes the end of Channel Move Time.

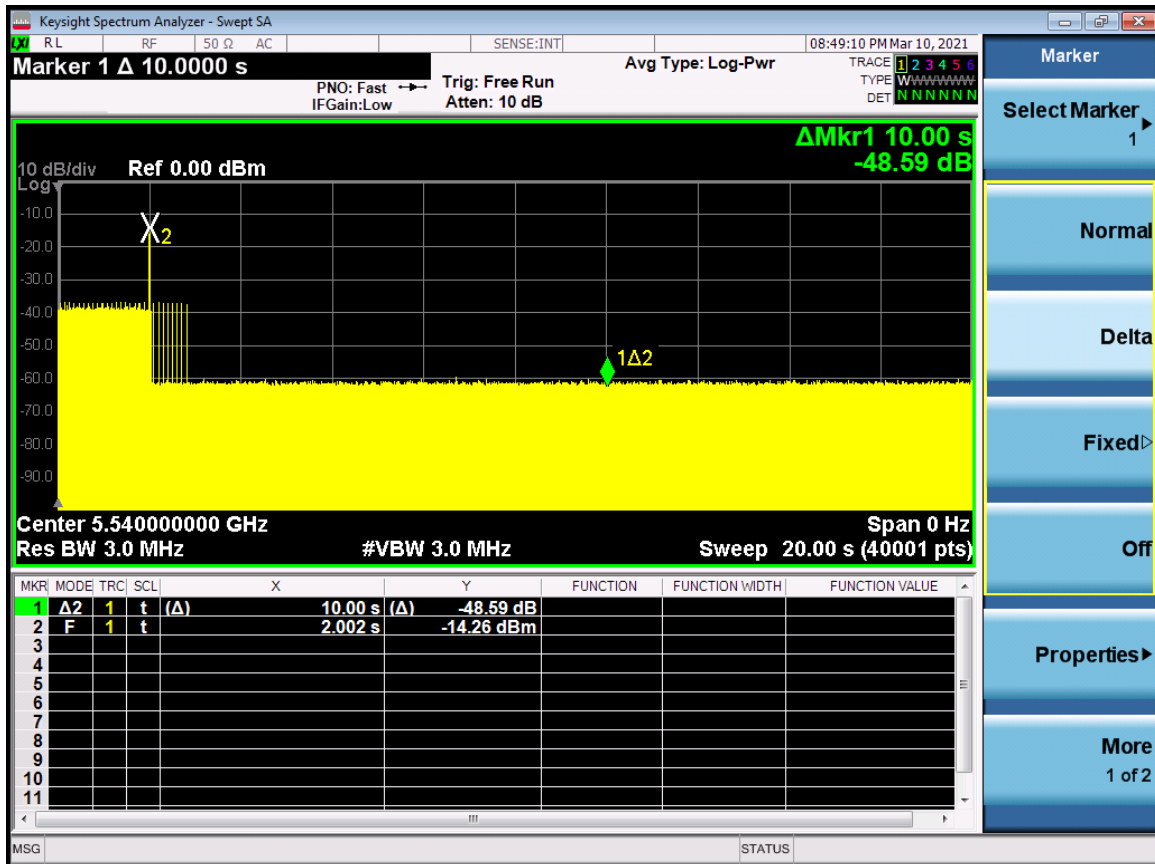

Note: An expanded plot for the device vacates the channel in the required 500ms

TX (11n (HT40) Mode)

Radar signal 0

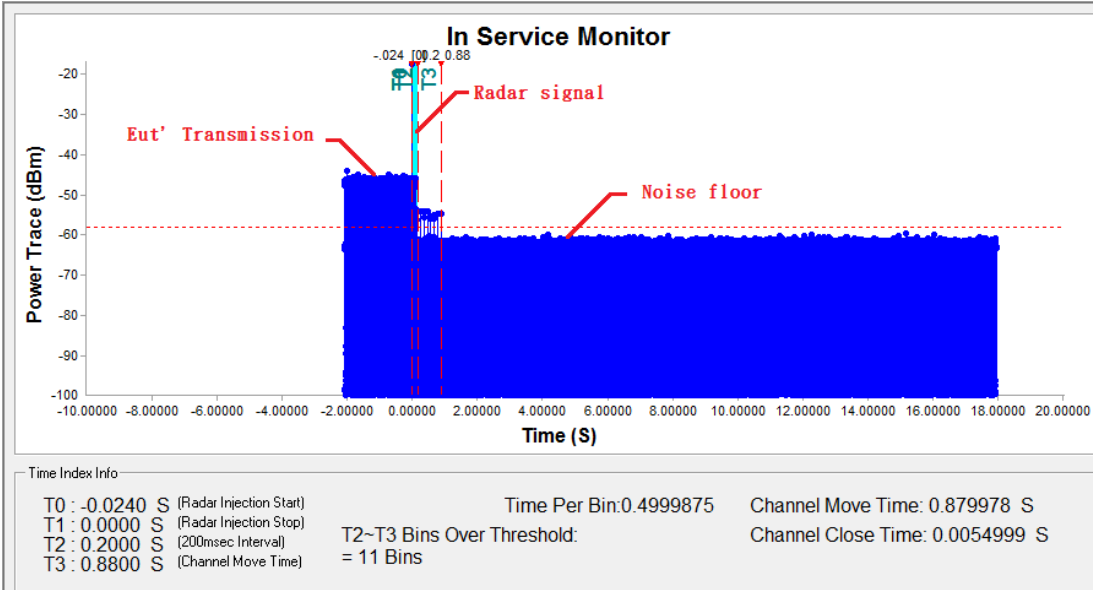

Note: T0 denotes the Radar Injection Start.
 T1 denotes the start of Channel Move Time upon the end of the last Radar burst.
 T2 denotes the data transmission time of 200ms from T1.
 T3 denotes the end of Channel Move Time.

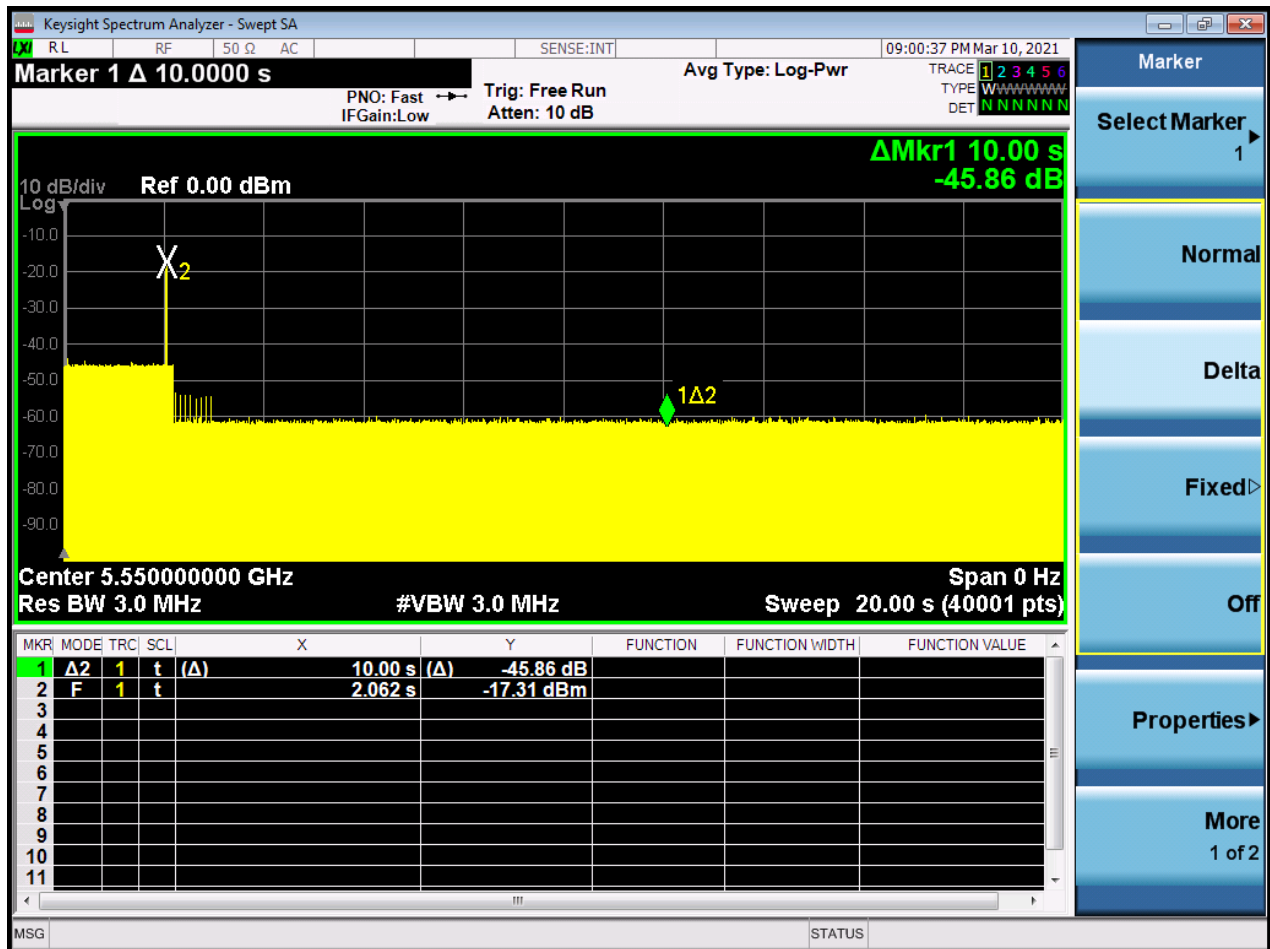

Note: An expanded plot for the device vacates the channel in the required 500ms

11a Mode		
Item	Measured Value(s)	Limit(s)
Channel Move Time	0.8039799	10
Channel Close Time	0.0039999	200 milliseconds + an aggregate of 60 milliseconds over remaining 10 second period

11n (HT40) Mode		
Item	Measured Value(s)	Limit(s)
Channel Move Time	0.879978	10
Channel Close Time	0.0054999	200 milliseconds + an aggregate of 60 milliseconds over remaining 10 second period

5.4 NON- OCCUPANCY PERIOD

TX (11a Mode 5540 MHz)



11n (HT40) Mode 5550 MHz



6 EUT TEST PHOTO

Please refer to document Appendix No.: TP-2101T111-FCCP-1 (APPENDIX-TEST PHOTOS).

7 EUT PHOTOS

Please refer to document Appendix No.: EP-2101T111-1 (APPENDIX-EUT PHOTOS).

End of Test Report