

FCC Radio Test Report

FCC ID: 2ATYCHMX04

Report No. : BTL-FCCP-2-2101T111
Equipment : HIPCAM
Model Name : Outdoor Spotlight Camera Max
Brand Name : HIPCAM
Applicant : Hipcam Global LLC
Address : 112 Capitol Trail, Newark, Delaware, 19711 United States
Manufacturer : Goldtek Technology Co., Ltd.
Address : 16F., No.166, Jian 1st Rd., Zhonghe Dist., New Taipei City 235, Taiwan (R.O.C.)

Radio Function : Bluetooth Low Energy (5.0)

FCC Rule Part(s) : FCC Part15, Subpart C (15.247)
Measurement Procedure(s) : ANSI C63.10-2013

Date of Receipt : 2021/2/2
Date of Test : 2021/2/2 ~ 2021/3/17
Issued Date : 2021/4/16

The above equipment has been tested and found in compliance with the requirement of the above standards by BTL Inc.

Prepared by :

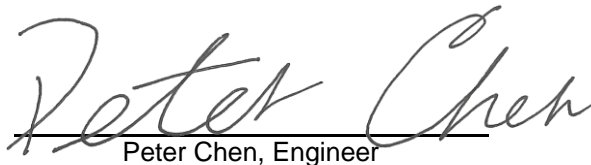
Peter Chen, Engineer



Approved by :

Scott Hsu, Manager

BTL Inc.

No.18, Ln. 171, Sec. 2, Jiuzong Rd., Neihu Dist., Taipei City 114, Taiwan

Tel: +886-2-2657-3299

Fax: +886-2-2657-3331

Web: www.newbtl.com

Declaration

BTL represents to the client that testing is done in accordance with standard procedures as applicable and that test instruments used has been calibrated with standards traceable to international standard(s) and/or national standard(s).

BTL's reports apply only to the specific samples tested under conditions. It is manufacture's responsibility to ensure that additional production units of this model are manufactured with the identical electrical and mechanical components. **BTL** shall have no liability for any declarations, inferences or generalizations drawn by the client or others from **BTL** issued reports.

This report is the confidential property of the client. As a mutual protection to the clients, the public and ourselves, the test report shall not be reproduced, except in full, without our written approval.

BTL's laboratory quality assurance procedures are in compliance with the **ISO/IEC 17025** requirements, and accredited by the conformity assessment authorities listed in this test report.

BTL is not responsible for the sampling stage, so the results only apply to the sample as received.

The information, data and test plan are provided by manufacturer which may affect the validity of results, so it is manufacturer's responsibility to ensure that the apparatus meets the essential requirements of applied standards and in all the possible configurations as representative of its intended use.

Limitation

For the use of the authority's logo is limited unless the Test Standard(s)/Scope(s)/Item(s) mentioned in this test report is (are) included in the conformity assessment authorities acceptance respective.

Please note that the measurement uncertainty is provided for informational purpose only and are not use in determining the Pass/Fail results.

CONTENTS

REVISION HISTORY	5
1 SUMMARY OF TEST RESULTS	6
1.1 TEST FACILITY	7
1.2 MEASUREMENT UNCERTAINTY	7
1.3 TEST ENVIRONMENT CONDITIONS	8
1.4 TABLE OF PARAMETERS OF TEXT SOFTWARE SETTING	8
1.5 DUTY CYCLE	8
2 GENERAL INFORMATION	9
2.1 DESCRIPTION OF EUT	9
2.2 TEST MODES	10
2.3 BLOCK DIAGRAM SHOWING THE CONFIGURATION OF SYSTEM TESTED	11
2.4 SUPPORT UNITS	12
3 AC POWER LINE CONDUCTED EMISSIONS TEST	13
3.1 LIMIT	13
3.2 TEST PROCEDURE	13
3.3 DEVIATION FROM TEST STANDARD	13
3.4 TEST SETUP	14
3.5 TEST RESULT	14
4 RADIATED EMISSIONS TEST	15
4.1 LIMIT	15
4.2 TEST PROCEDURE	16
4.3 DEVIATION FROM TEST STANDARD	16
4.4 TEST SETUP	17
4.5 EUT OPERATING CONDITIONS	18
4.6 TEST RESULT – 30 MHZ TO 1 GHZ	18
4.7 TEST RESULT – ABOVE 1 GHZ	18
5 BANDWIDTH TEST	19
5.1 APPLIED PROCEDURES / LIMIT	19
5.2 TEST PROCEDURE	19
5.3 DEVIATION FROM STANDARD	19
5.4 TEST SETUP	19
5.5 EUT OPERATION CONDITIONS	19
5.6 TEST RESULTS	19
6 OUTPUT POWER TEST	20
6.1 APPLIED PROCEDURES / LIMIT	20
6.2 TEST PROCEDURE	20
6.3 DEVIATION FROM STANDARD	20
6.4 TEST SETUP	20
6.5 EUT OPERATION CONDITIONS	20
6.6 TEST RESULTS	20
7 POWER SPECTRAL DENSITY TEST	21
7.1 APPLIED PROCEDURES / LIMIT	21
7.2 TEST PROCEDURE	21
7.3 DEVIATION FROM STANDARD	21
7.4 TEST SETUP	21
7.5 EUT OPERATION CONDITIONS	21
7.6 TEST RESULTS	21

8	ANTENNA CONDUCTED SPURIOUS EMISSION	22
8.1	APPLIED PROCEDURES / LIMIT	22
8.2	TEST PROCEDURE	22
8.3	DEVIATION FROM STANDARD	22
8.4	TEST SETUP	22
8.5	EUT OPERATION CONDITIONS	22
8.6	TEST RESULTS	22
9	LIST OF MEASURING EQUIPMENTS	23
10	EUT TEST PHOTO	25
11	EUT PHOTOS	25
APPENDIX A	AC POWER LINE CONDUCTED EMISSIONS	26
APPENDIX B	RADIATED EMISSIONS - 30 MHZ TO 1 GHZ	31
APPENDIX C	RADIATED EMISSIONS - ABOVE 1 GHZ	34
APPENDIX D	BANDWIDTH	51
APPENDIX E	OUTPUT POWER	54
APPENDIX F	POWER SPECTRAL DENSITY TEST	56
APPENDIX G	ANTENNA CONDUCTED SPURIOUS EMISSION	59

REVISION HISTORY

Report No.	Version	Description	Issued Date
BTL-FCCP-2-2101T111	R00	Original Report.	2021/4/9
BTL-FCCP-2-2101T111	R01	Revised report to address TCB's comments.	2021/4/16

1 SUMMARY OF TEST RESULTS

Test procedures according to the technical standards.

FCC Part 15, Subpart C (15.247)				
Standard(s) Section	Description	Test Result	Judgement	Remark
15.207	AC Power Line Conducted Emissions	APPENDIX A	Pass	-----
15.205 15.209 15.247(d)	Radiated Emissions	APPENDIX B APPENDIX C	Pass	-----
15.247(a)(2)	Bandwidth	APPENDIX D	Pass	-----
15.247(b)(3)	Output Power	APPENDIX E	Pass	-----
15.247(e)	Power Spectral Density	APPENDIX F	Pass	-----
15.247(d)	Antenna conducted Spurious Emission	APPENDIX G	Pass	-----
15.203	Antenna Requirement	-----	Pass	-----

NOTE:

- (1) "N/A" denotes test is not applicable in this Test Report.
- (2) The report format version is TP.1.1.1.

1.1 TEST FACILITY

The test facilities used to collect the test data in this report:

No. 68-1, Ln. 169, Sec. 2, Datong Rd., Xizhi Dist., New Taipei City 221, Taiwan

The test sites and facilities are covered under FCC RN: 674415 and DN: TW0659.

- C05 CB08 CB11 CB15 CB16
 SR05

1.2 MEASUREMENT UNCERTAINTY

The reported uncertainty of measurement $y \pm U$, where expanded uncertainty U is based on a standard uncertainty multiplied by a coverage factor of $k = 2$, providing a level of confidence of approximately **95 %**. The measurement instrumentation uncertainty considerations contained in CISPR 16-4-2. The BTL measurement uncertainty is less than the CISPR 16-4-2 U_{cispr} requirement.

A. AC power line conducted emissions test:

Test Site	Method	Measurement Frequency Range	U (dB)
C05	CISPR	150 kHz ~ 30MHz	3.44

B. Radiated emissions test :

Test Site	Measurement Frequency Range	U,(dB)
CB15	0.03 GHz ~ 0.2 GHz	4.17
	0.2 GHz ~ 1 GHz	4.72
	1 GHz ~ 6 GHz	5.21
	6 GHz ~ 18 GHz	5.51
	18 GHz ~ 26 GHz	3.69
	26 GHz ~ 40 GHz	4.23

C. Conducted test :

Test Item	U,(dB)
Bandwidth	1.13
Output power	1.06
Power Spectral Density	1.20
Conducted Spurious emissions	1.14
Conducted Band edges	1.13

NOTE:

Unless specifically mentioned, the uncertainty of measurement has not been taken into account to declare the compliance or non-compliance to the specification.

1.3 TEST ENVIRONMENT CONDITIONS

Test Item	Environment Condition	Test Voltage	Tested by
AC Power Line Conducted Emissions	21 °C, 70 %	AC 120V	Vincent Lee
Radiated emissions below 1 GHz	21 °C, 68 %	AC 120V	Jay Kao
Radiated emissions above 1 GHz	22 °C, 66 %	AC 120V	Jay Kao
Bandwidth	22 °C, 52 %	AC 120V	Nero Hsieh
Output Power	22 °C, 52 %	AC 120V	Nero Hsieh
Power Spectral Density	22 °C, 52 %	AC 120V	Nero Hsieh
Antenna conducted Spurious Emission	22 °C, 52 %	AC 120V	Nero Hsieh

1.4 TABLE OF PARAMETERS OF TEXT SOFTWARE SETTING

Test Software	Ampak RFTesTool V7.0			
Modulation Mode	2402 MHz	2440 MHz	2480 MHz	Data Rate
BLE 5.0	DEF	DEF	DEF	1 Mbps
BLE 5.0	DEF	DEF	DEF	2 Mbps

1.5 DUTY CYCLE

If duty cycle is $\geq 98\%$, duty factor is not required.
 If duty cycle is $< 98\%$, duty factor shall be considered.

Remark	Delta 1		Delta 2		On Time/Period	10 log(1/Duty Cycle)
Mode	ON (ms)	Numbers (ON)	On Time (B) (ms)	Period (ON+OFF) (ms)	Duty Cycle (%)	Duty Factor (dB)
BLE 5.0 (1 Mbps)	0.386	1	0.386	0.626	61.76%	2.09
BLE 5.0 (2 Mbps)	0.202	1	0.202	0.626	32.35%	4.90

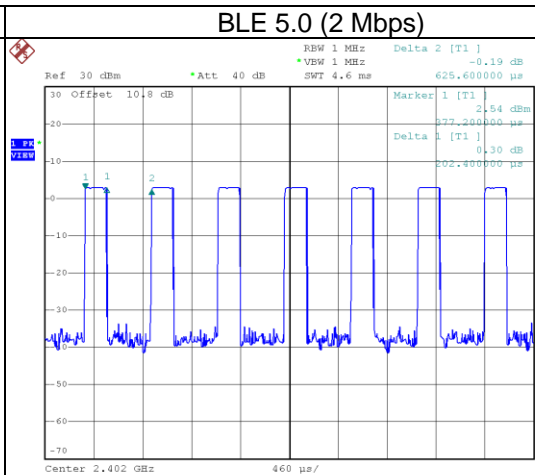
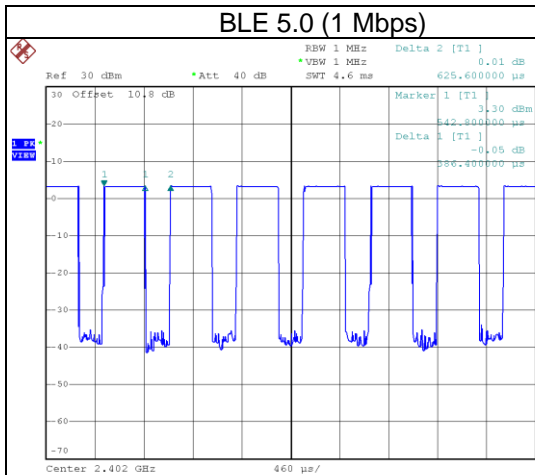

Date: 5.MAR.2021 16:48:20

Date: 5.MAR.2021 16:45:35

2 GENERAL INFORMATION

2.1 DESCRIPTION OF EUT

Equipment	HIPCAM
Model Name	Outdoor Spotlight Camera Max
Brand Name	HIPCAM
Model Difference	N/A
Power Source	DC Voltage supplied from AC/DC adapter.
Power Rating	I/P: 100-240V~ 50/60Hz 0.6A Max O/P: 12.0Vdc 2.0A 24.0W
Products Covered	1 * Adapter: SIMSUKIAN / SK03T-1200200Z 1 * Base
Operation Band	2400 MHz ~ 2483.5 MHz
Operation Frequency	2402 MHz ~ 2480 MHz
Modulation Technology	GFSK
Transfer Rate	1 Mbps, 2 Mbps
Output Power Max.	1 Mbps: 4.97 dBm (0.0031 W) 2 Mbps: 4.91 dBm (0.0031 W)
Test Model	Outdoor Spotlight Camera Max
Sample Status	Engineering Sample
EUT Modification(s)	N/A

NOTE:

- (1) For a more detailed features description, please refer to the manufacturer's specifications or the user's manual.
- (2) Channel List:

Channel	Frequency (MHz)	Channel	Frequency (MHz)
00	2402	20	2442
01	2404	21	2444
02	2406	22	2446
03	2408	23	2448
04	2410	24	2450
05	2412	25	2452
06	2414	26	2454
07	2416	27	2456
08	2418	28	2458
09	2420	29	2460
10	2422	30	2462
11	2424	31	2464
12	2426	32	2466
13	2428	33	2468
14	2430	34	2470
15	2432	35	2472
16	2434	36	2474
17	2436	37	2476
18	2438	38	2478
19	2440	39	2480

- (3) Table for Filed Antenna:

Ant.	Manufacture	Product	Type	Connector	Frequency Range (MHz)	Gain (dBi)
1		Wi-Fi Ant.	PCB	N/A	2400-2500	3.86

2.2 TEST MODES

Test Items	Test mode	Channel	Note
AC power line conducted emissions	Normal/Idle	-	-
Transmitter Radiated Emissions (below 1GHz)	2 Mbps	39	-
Transmitter Radiated Emissions (above 1GHz)	1/2 Mbps	00/39	Bandedge
	1/2 Mbps	00/19/39	Harmonic
Bandwidth	1/2 Mbps	00/19/39	-
Output Power	1/2 Mbps	00/19/39	-
Power Spectral Density	1/2 Mbps	00/19/39	-
Antenna conducted Spurious Emission	1/2 Mbps	00/19/39	-

NOTE:

- (1) The Radiated emissions test was verified based on the worst conducted power and Bandwidth test results reported in the original report.
- (2) For radiated emission band edge test, both Vertical and Horizontal are evaluated, but only the worst case (Vertical) is recorded.
- (3) All X, Y and Z axes are evaluated, but only the worst case (Y axis) is recorded.
- (4) There were no emissions found below 30 MHz within 20 dB of the limit.

2.3 BLOCK DIAGRAM SHOWING THE CONFIGURATION OF SYSTEM TESTED

Equipment letters and Cable numbers refer to item numbers described in the tables of clause 2.4.

AC power line conducted emissions

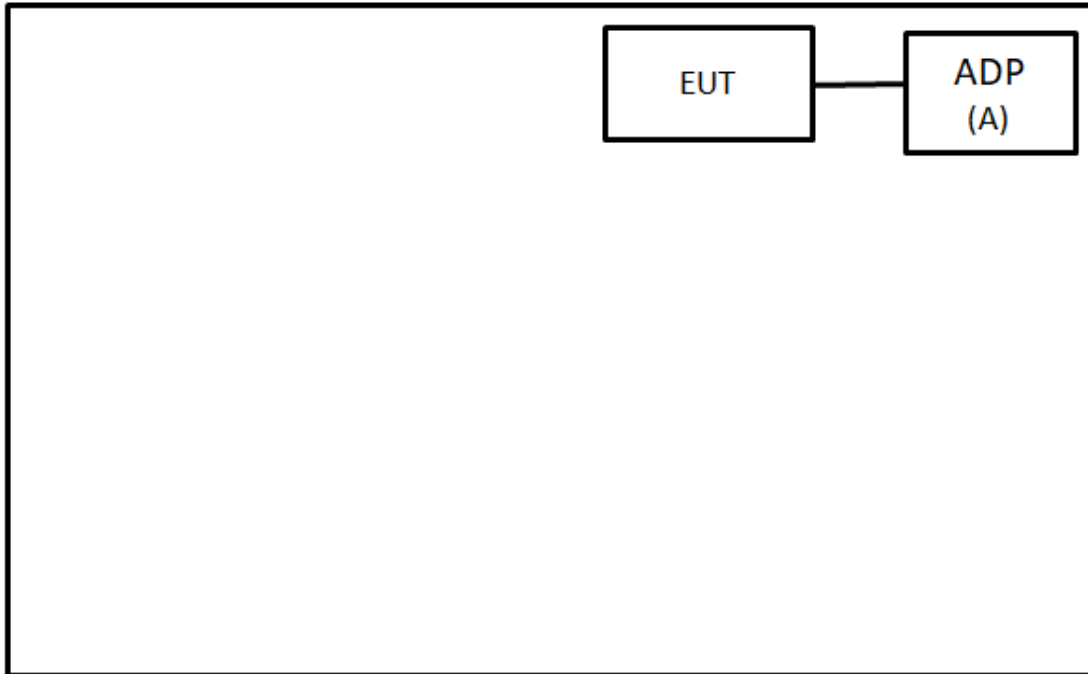

Radiated Emissions

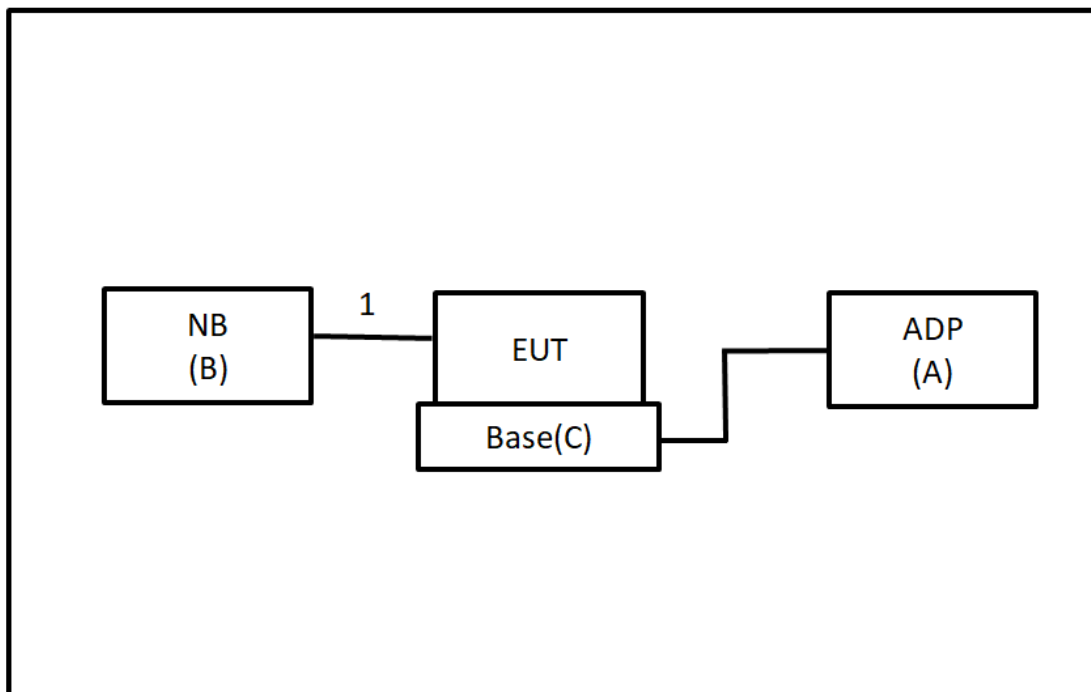

2.4 SUPPORT UNITS

Item	Equipment	Brand	Model No.	Series No.	Remarks
A	Adapter	SIMSUKIAN	SK03T-1200200Z	N/A	Supplied by test requester.
B	NB	hp	TPN-I119	N/A	Furnished by test lab.
C	Base	HIPCAM	N/A	N/A	Supplied by test requester.

Item	Shielded	Ferrite Core	Length	Cable Type	Remarks
1	N/A	N/A	1m	USB Cable	Furnished by test lab.

3 AC POWER LINE CONDUCTED EMISSIONS TEST

3.1 LIMIT

Frequency (MHz)	Limit (dB μ V)	
	Quasi-peak	Average
0.15 - 0.5	66 - 56 *	56 - 46 *
0.50 - 5.0	56	46
5.0 - 30.0	60	50

NOTE:

- (1) The tighter limit applies at the band edges.
- (2) The limit of " * " marked band means the limitation decreases linearly with the logarithm of the frequency in the range.
- (3) The test result calculated as following:
 Measurement Value = Reading Level + Correct Factor
 Correct Factor = Insertion Loss + Cable Loss + Attenuator Factor (if use)
 Margin Level = Measurement Value – Limit Value
 Calculation example:

Reading Level		Correct Factor		Measurement Value
38.22	+	3.45	=	41.67

Measurement Value		Limit Value		Margin Level
41.67	-	60	=	-18.33

The following table is the setting of the receiver.

Receiver Parameter	Setting
Attenuation	10 dB
Start Frequency	0.15 MHz
Stop Frequency	30 MHz
IF Bandwidth	9 KHz

3.2 TEST PROCEDURE

- a. The EUT was placed 0.8 m above the horizontal ground plane with the EUT being connected to the power mains through a line impedance stabilization network (LISN).
 All other support equipment were powered from an additional LISN(s).
 The LISN provides 50 Ohm/50uH of impedance for the measuring instrument.
- b. Interconnecting cables that hang closer than 40 cm to the ground plane shall be folded back and forth in the center forming a bundle to keep the cable above 40 cm.
- c. Excess I/O cables that are not connected to a peripheral shall be bundled in the center.
 The end of the cable will be terminated, using the correct terminating impedance.
 The overall length shall not exceed 1 m.
- d. The LISN is spaced at least 80 cm from the nearest part of the EUT chassis.
- e. For the actual test configuration, please refer to the related Item – EUT TEST PHOTO.

NOTE:

- (1) In the results, each reading is marked as Peak, QP or AVG per the detector used.
 BW=9 kHz (6 dB Bandwidth)
- (2) All readings are Peak unless otherwise stated QP or AVG in column of Note. Both the QP and the AVG readings must be less than the limit for compliance.

3.3 DEVIATION FROM TEST STANDARD

No deviation.

3.4 TEST SETUP

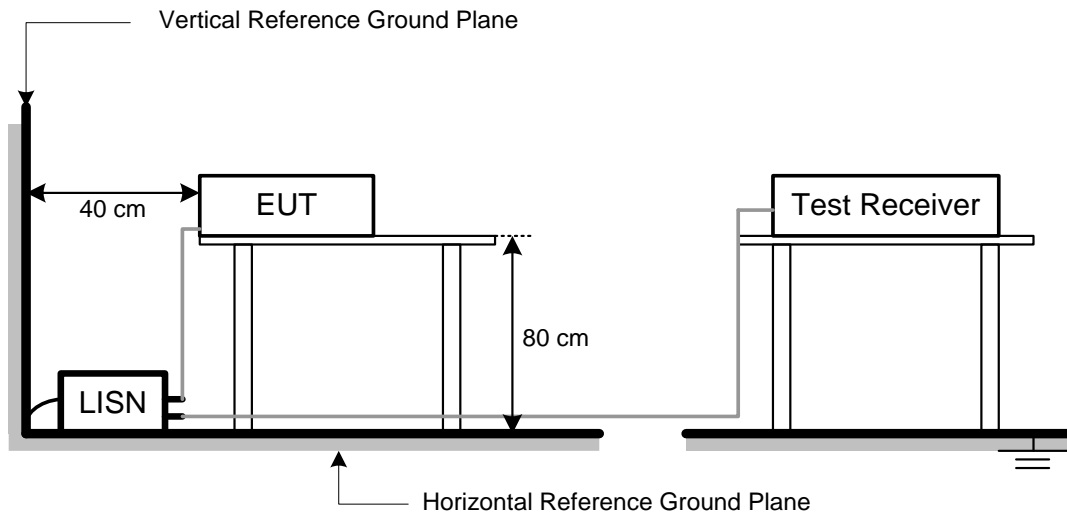

3.5 TEST RESULT

Please refer to the **APPENDIX A**.

4 RADIATED EMISSIONS TEST

4.1 LIMIT

In case the emission fall within the restricted band specified on 15.205, then the 15.209 limit in the table below has to be followed.

LIMITS OF RADIATED EMISSIONS MEASUREMENT (9 kHz to 1000 MHz)

Frequency (MHz)	Field Strength (microvolts/meter)	Measurement Distance (meters)
0.009~0.490	2400/F(KHz)	300
0.490~1.705	24000/F(KHz)	30
1.705~30.0	30	30
30~88	100	3
88~216	150	3
216~960	200	3
960~1000	500	3

LIMITS OF RADIATED EMISSIONS MEASUREMENT (Above 1000 MHz)

Frequency (MHz)	Radiated Emissions (dBuV/m)		Measurement Distance (meters)
	Peak	Average	
Above 1000	74	54	3

NOTE:

- (1) The limit for radiated test was performed according to FCC Part 15, Subpart C.
- (2) The tighter limit applies at the band edges.
- (3) Emission level (dBuV/m)=20log Emission level (uV/m).
- (4) The test result calculated as following:
 Measurement Value = Reading Level + Correct Factor
 Correct Factor = Antenna Factor + Cable Loss - Amplifier Gain(if use)
 Margin Level = Measurement Value - Limit Value
 Calculation example:

Reading Level		Correct Factor		Measurement Value
41.91	+	-8.36	=	33.55

Measurement Value		Limit Value		Margin Level
33.55	-	43.50	=	-9.95

Spectrum Parameter	Setting
Attenuation	Auto
Start Frequency	1000 MHz
Stop Frequency	10th carrier harmonic
RBW / VBW (Emission in restricted band)	1MHz / 3MHz for Peak, 1MHz / 1/T for Average

Spectrum Parameter	Setting
Attenuation	Auto
Start ~ Stop Frequency	9KHz~90KHz for PK/AVG detector
Start ~ Stop Frequency	90KHz~110KHz for QP detector
Start ~ Stop Frequency	110KHz~490KHz for PK/AVG detector
Start ~ Stop Frequency	490KHz~30MHz for QP detector
Start ~ Stop Frequency	30MHz~1000MHz for QP detector

4.2 TEST PROCEDURE

- a. The measuring distance of 3 m shall be used for measurements. The EUT was placed on the top of a rotating table 0.8 meter above the ground at a 3 meter semi-anechoic chamber. The table was rotated 360 degrees to determine the position of the highest radiation.(below 1GHz)
- b. The measuring distance of 3 m shall be used for measurements. The EUT was placed on the top of a rotating table 1.5 meter above the ground at a 3 meter semi-anechoic chamber. The table was rotated 360 degrees to determine the position of the highest radiation.(above 1GHz)
- c. The height of the equipment or of the substitution antenna shall be 0.8 m or 1.5 m, the height of the test antenna shall vary between 1 m to 4 m. Both horizontal and vertical polarizations of the antenna are set to make the measurement.
- d. For each suspected emission, the EUT was arranged to its worst case and then the antenna was tuned to heights find the maximum reading (used Bore sight function).
- e. The receiver system was set to peak and average detect function and specified bandwidth with maximum hold mode when the test frequency is above 1GHz.
- f. The initial step in collecting radiated emission data is a receiver peak detector mode pre-scanning the measurement frequency range. Significant peaks are then marked and then Quasi Peak detector mode re-measured.
- g. All readings are Peak unless otherwise stated QP in column of Note. Peak denotes that the Peak reading compliance with the QP Limits and then QP Mode measurement didn't perform. (below 1GHz)
- h. All readings are Peak Mode value unless otherwise stated AVG in column of Note. If the Peak Mode Measured value compliance with the Peak Limits and lower than AVG Limits, the EUT shall be deemed to meet both Peak & AVG Limits and then only Peak Mode was measured, but AVG Mode didn't perform. (above 1GHz)
- i. For the actual test configuration, please refer to the related Item – EUT TEST PHOTO.

4.3 DEVIATION FROM TEST STANDARD

No deviation.

4.4 TEST SETUP

30 MHz to 1 GHz

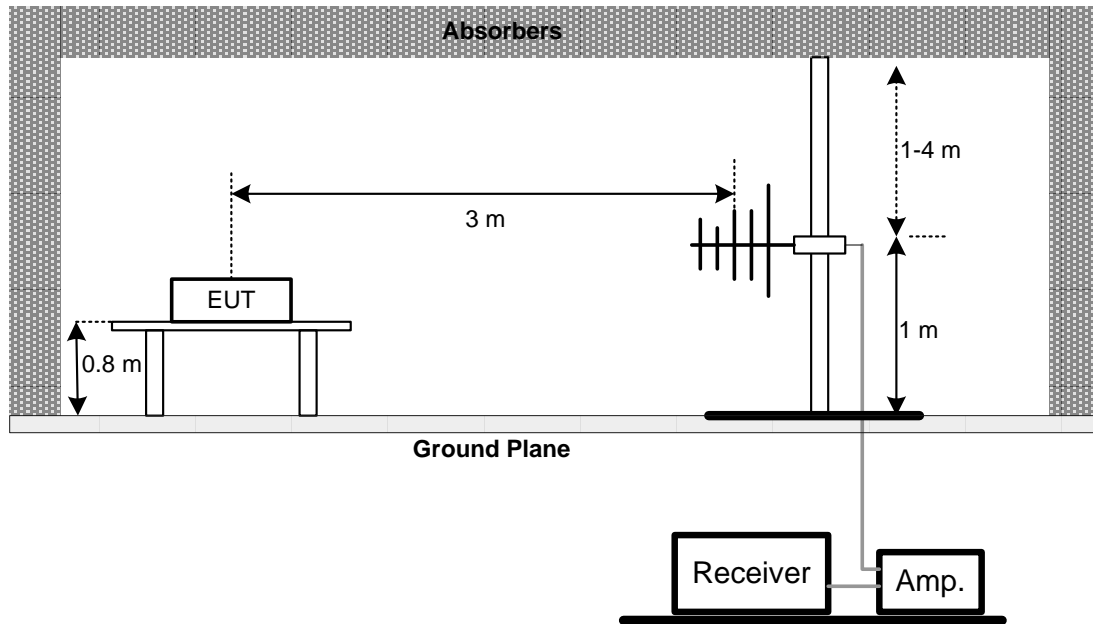

Above 1 GHz

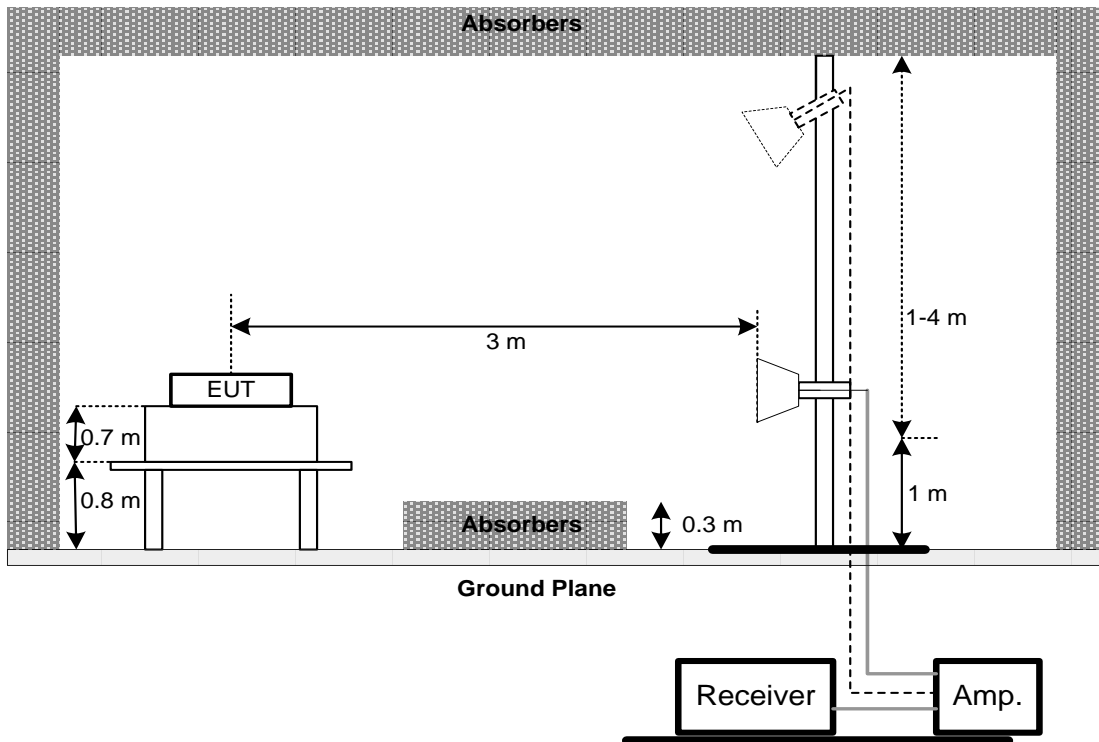

4.5 EUT OPERATING CONDITIONS

The EUT was programmed to be in continuously transmitting mode.

4.6 TEST RESULT – 30 MHZ TO 1 GHZ

Please refer to the APPENDIX B.

4.7 TEST RESULT – ABOVE 1 GHZ

Please refer to the APPENDIX C.

NOTE:

- (1) No limit: This is fundamental signal, the judgment is not applicable.
For fundamental signal judgment was referred to Peak output test.

5 BANDWIDTH TEST

5.1 APPLIED PROCEDURES / LIMIT

FCC Part15 (15.247) , Subpart C				
Section	Test Item	Limit	Frequency Range (MHz)	Result
15.247(a)(2)	Bandwidth	>= 500KHz (6dB bandwidth)	2400-2483.5	PASS

5.2 TEST PROCEDURE

- a. The EUT was directly connected to the spectrum analyzer and antenna output port as show in the block diagram below,
- b. Spectrum Setting : RBW= 100KHz, VBW=300KHz, Sweep time = 2.5 ms.

5.3 DEVIATION FROM STANDARD

No deviation.

5.4 TEST SETUP

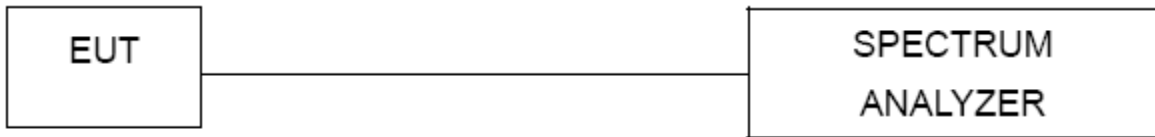

5.5 EUT OPERATION CONDITIONS

The EUT tested system was configured as the statements of 3.5 unless otherwise a special operating condition is specified in the follows during the testing.

5.6 TEST RESULTS

Please refer to the APPENDIX D.

6 OUTPUT POWER TEST

6.1 APPLIED PROCEDURES / LIMIT

FCC Part15 (15.247) , Subpart C				
Section	Test Item	Limit	Frequency Range (MHz)	Result
15.247(b)(3)	Maximum Output Power	1 watt or 30dBm	2400-2483.5	PASS

6.2 TEST PROCEDURE

- a. The EUT was directly connected to the power meter and antenna output port as show in the block diagram below,
- b. The maximum peak conducted output power was performed in accordance with method 9.1.2 of FCC KDB 558074 D01 DTS Meas Guidance.

6.3 DEVIATION FROM STANDARD

No deviation.

6.4 TEST SETUP

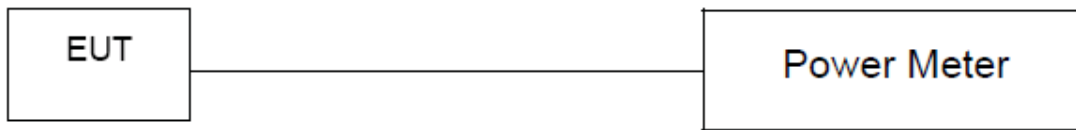

6.5 EUT OPERATION CONDITIONS

The EUT tested system was configured as the statements of 3.5 unless otherwise a special operating condition is specified in the follows during the testing.

6.6 TEST RESULTS

Please refer to the APPENDIX E.

7 POWER SPECTRAL DENSITY TEST

7.1 APPLIED PROCEDURES / LIMIT

FCC Part15 (15.247) , Subpart C				
Section	Test Item	Limit	Frequency Range (MHz)	Result
15.247(e)	Power Spectral Density	8 dBm (in any 3KHz)	2400-2483.5	PASS

7.2 TEST PROCEDURE

- a. The EUT was directly connected to the spectrum analyzer and antenna output port as show in the block diagram below,
- b. Spectrum Setting: RBW=3KHz, VBW=10 KHz, Sweep time = auto.

7.3 DEVIATION FROM STANDARD

No deviation.

7.4 TEST SETUP

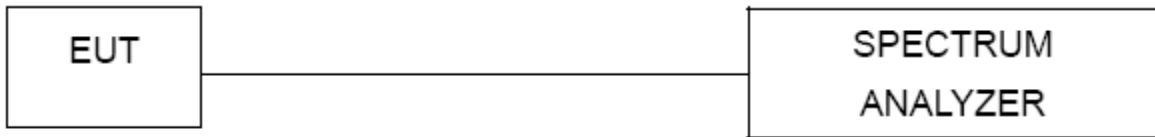

7.5 EUT OPERATION CONDITIONS

The EUT tested system was configured as the statements of 3.5 unless otherwise a special operating condition is specified in the follows during the testing.

7.6 TEST RESULTS

Please refer to the APPENDIX F.

8 ANTENNA CONDUCTED SPURIOUS EMISSION

8.1 APPLIED PROCEDURES / LIMIT

In any 100 kHz bandwidth outside the frequency band in which the spread spectrum or digitally modulated device is operating, the RF power that is produced shall be at least 20 dB below that in the 100 kHz bandwidth within the band that contains the highest level of the desired power, based on either an RF conducted or a radiated measurement, provided that the transmitter demonstrates compliance with the peak conducted power limits.

8.2 TEST PROCEDURE

- a. The EUT was directly connected to the spectrum analyzer and antenna output port as show in the block diagram below,
- b. Spectrum Setting : RBW= 100KHz, VBW=300KHz, Sweep time = 10 ms.

8.3 DEVIATION FROM STANDARD

No deviation.

8.4 TEST SETUP

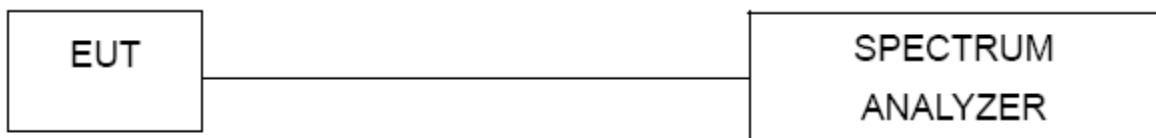

8.5 EUT OPERATION CONDITIONS

The EUT tested system was configured as the statements of 3.5 unless otherwise a special operating condition is specified in the follows during the testing.

8.6 TEST RESULTS

Please refer to the APPENDIX G.

9 LIST OF MEASURING EQUIPMENTS

AC Power Line Conducted Emissions						
Item	Kind of Equipment	Manufacturer	Type No.	Serial No.	Calibrated Date	Calibrated Until
1	TWO-LINE V-NETWORK	R&S	ENV216	101050	2020/6/11	2021/6/10
2	Test Cable	EMCI	EMC400-BM-BM-5000	170501	2020/6/8	2021/6/7
3	EMI Test Receiver	R&S	ESCI	100080	2020/6/15	2021/6/14
4	Measurement Software	EZ	EZ EMC (Version NB-03A1-01)	N/A	N/A	N/A

Radiated Emissions						
Item	Kind of Equipment	Manufacturer	Type No.	Serial No.	Calibrated Date	Calibrated Until
1	Preamplifier	EMCI	EMC001340	980555	2020/4/10	2021/4/9
2	Preamplifier	EMCI	EMC02325B	980217	2020/4/10	2021/4/9
3	Preamplifier	EMCI	EMC012645B	980267	2020/4/10	2021/4/9
4	Test Cable	EMCI	EMC-SM-SM-1000	180809	2020/4/10	2021/4/9
5	Test Cable	EMCI	EMC104-SM-SM-3000	151205	2020/4/10	2021/4/9
6	Test Cable	EMCI	EMC-SM-SM-7000	180408	2020/4/10	2021/4/9
7	MXE EMI Receiver	Agilent	N9038A	MY554200087	2020/6/10	2021/6/9
8	Signal Analyzer	Agilent	N9010A	MY56480554	2020/8/25	2021/8/24
9	Loop Ant	Electro-Metrics	EMCI-LPA600	274	2020/6/16	2021/6/15
10	Horn Ant	SCHWARZBECK	BBHA 9120D	9120D-1342	2020/6/12	2021/6/11
11	Horn Ant	Schwarzbeck	BBHA 9170	BBHA 9170340	2020/7/9	2021/7/8
12	Trilog-Broadband Antenna	Schwarzbeck	VULB 9168	VULB 9168-352	2020/7/24	2021/7/23
13	5dB Attenuator	EMCI	EMCI-N-6-05	AT-N0625	2020/7/24	2021/7/23
14	Measurement Software	EZ	EZ EMC (Version NB-03A1-01)	N/A	N/A	N/A

Bandwidth						
Item	Kind of Equipment	Manufacturer	Type No.	Serial No.	Calibrated Date	Calibrated Until
1	Spectrum Analyzer	R&S	FSP 40	100129	2020/6/15	2021/6/14

Output Power						
Item	Kind of Equipment	Manufacturer	Type No.	Serial No.	Calibrated Date	Calibrated Until
1	Power Meter	Anritsu	ML2495A	1128008	2020/6/11	2021/6/10
2	Power Sensor	Anritsu	MA2411B	1126001	2020/6/11	2021/6/10

Power Spectral Density						
Item	Kind of Equipment	Manufacturer	Type No.	Serial No.	Calibrated Date	Calibrated Until
1	Spectrum Analyzer	R&S	FSP 40	100129	2020/6/15	2021/6/14

Antenna conducted Spurious Emission

Item	Kind of Equipment	Manufacturer	Type No.	Serial No.	Calibrated Date	Calibrated Until
1	Spectrum Analyzer	R&S	FSP 40	100129	2020/6/15	2021/6/14

Remark: "N/A" denotes no model name, no serial no. or no calibration specified.
All calibration period of equipment list is one year.

10 EUT TEST PHOTO

Please refer to document Appendix No.: TP-2101T111-FCCP-1 (APPENDIX-TEST PHOTOS).

11 EUT PHOTOS

Please refer to document Appendix No.: EP-2101T111-1 (APPENDIX-EUT PHOTOS).

APPENDIX A AC POWER LINE CONDUCTED EMISSIONS

Test Mode	Normal	Tested Date	2021/3/12
Test Frequency	-	Phase	Line

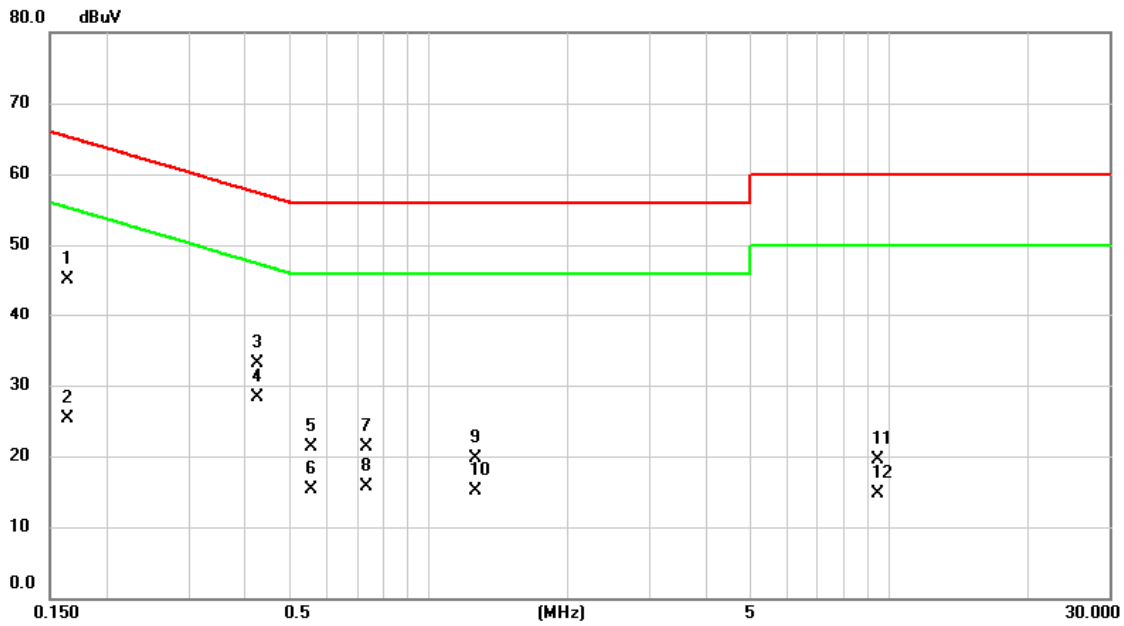

No.	Mk.	Freq. MHz	Reading Level dBuV	Correct Factor dB	Measure- ment dBuV	Limit dBuV	Over dB	Detector	Comment
1		0.1635	35.46	9.68	45.14	65.28	-20.14	QP	
2		0.1635	15.70	9.68	25.38	55.28	-29.90	AVG	
3		0.4267	23.49	9.68	33.17	57.32	-24.15	QP	
4	*	0.4267	18.63	9.68	28.31	47.32	-19.01	AVG	
5		0.5550	11.68	9.68	21.36	56.00	-34.64	QP	
6		0.5550	5.60	9.68	15.28	46.00	-30.72	AVG	
7		0.7350	11.55	9.68	21.23	56.00	-34.77	QP	
8		0.7350	6.02	9.68	15.70	46.00	-30.30	AVG	
9		1.2638	10.10	9.70	19.80	56.00	-36.20	QP	
10		1.2638	5.38	9.70	15.08	46.00	-30.92	AVG	
11		9.4380	9.66	9.92	19.58	60.00	-40.42	QP	
12		9.4380	4.74	9.92	14.66	50.00	-35.34	AVG	

REMARKS:

- (1) Measurement Value = Reading Level + Correct Factor.
- (2) Margin Level = Measurement Value - Limit Value.

Test Mode	Normal	Tested Date	2021/3/12
Test Frequency	-	Phase	Neutral

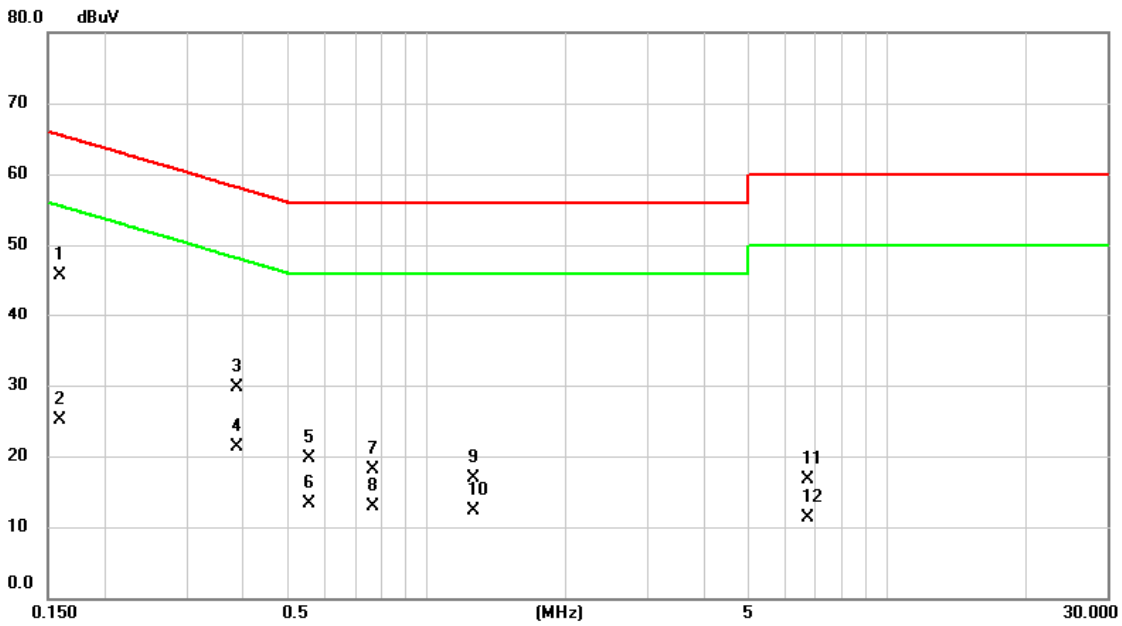

No.	Mk.	Freq. MHz	Reading Level dBuV	Correct Factor dB	Measure- ment dBuV	Limit dBuV	Over dB	Detector	Comment
1	*	0.1598	35.99	9.68	45.67	65.47	-19.80	QP	
2		0.1598	15.47	9.68	25.15	55.47	-30.32	AVG	
3		0.3885	20.10	9.68	29.78	58.10	-28.32	QP	
4		0.3885	11.55	9.68	21.23	48.10	-26.87	AVG	
5		0.5550	10.09	9.68	19.77	56.00	-36.23	QP	
6		0.5550	3.69	9.68	13.37	46.00	-32.63	AVG	
7		0.7642	8.35	9.69	18.04	56.00	-37.96	QP	
8		0.7642	3.16	9.69	12.85	46.00	-33.15	AVG	
9		1.2593	7.12	9.70	16.82	56.00	-39.18	QP	
10		1.2593	2.68	9.70	12.38	46.00	-33.62	AVG	
11		6.7470	6.75	9.86	16.61	60.00	-43.39	QP	
12		6.7470	1.39	9.86	11.25	50.00	-38.75	AVG	

REMARKS:

- (1) Measurement Value = Reading Level + Correct Factor.
- (2) Margin Level = Measurement Value - Limit Value.

Test Mode	Idle	Tested Date	2021/3/12
Test Frequency	-	Phase	Line

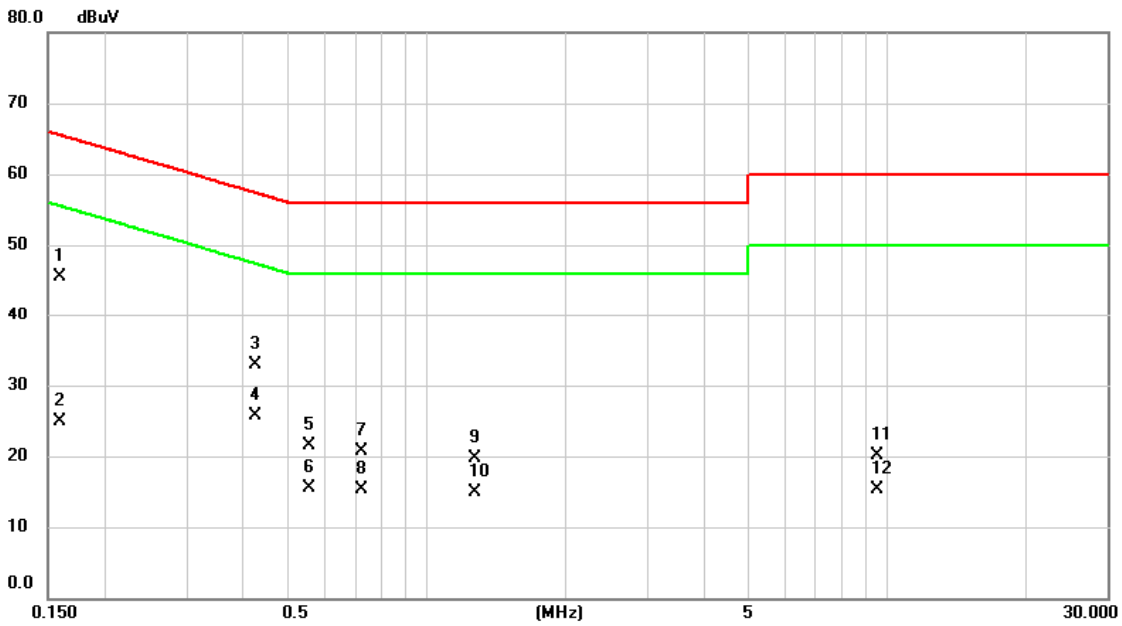

No.	Mk.	Freq. MHz	Reading Level dBuV	Correct Factor dB	Measure- ment dBuV	Limit dBuV	Over dB	Detector	Comment
1	*	0.1598	35.78	9.68	45.46	65.47	-20.01	QP	
2		0.1598	15.27	9.68	24.95	55.47	-30.52	AVG	
3		0.4244	23.25	9.68	32.93	57.36	-24.43	QP	
4		0.4244	16.01	9.68	25.69	47.36	-21.67	AVG	
5		0.5550	11.77	9.68	21.45	56.00	-34.55	QP	
6		0.5550	5.81	9.68	15.49	46.00	-30.51	AVG	
7		0.7214	11.07	9.68	20.75	56.00	-35.25	QP	
8		0.7214	5.57	9.68	15.25	46.00	-30.75	AVG	
9		1.2705	10.01	9.70	19.71	56.00	-36.29	QP	
10		1.2705	5.22	9.70	14.92	46.00	-31.08	AVG	
11		9.5325	10.11	9.92	20.03	60.00	-39.97	QP	
12		9.5325	5.35	9.92	15.27	50.00	-34.73	AVG	

REMARKS:

- (1) Measurement Value = Reading Level + Correct Factor.
- (2) Margin Level = Measurement Value - Limit Value.

Test Mode	Idle	Tested Date	2021/3/12
Test Frequency	-	Phase	Neutral

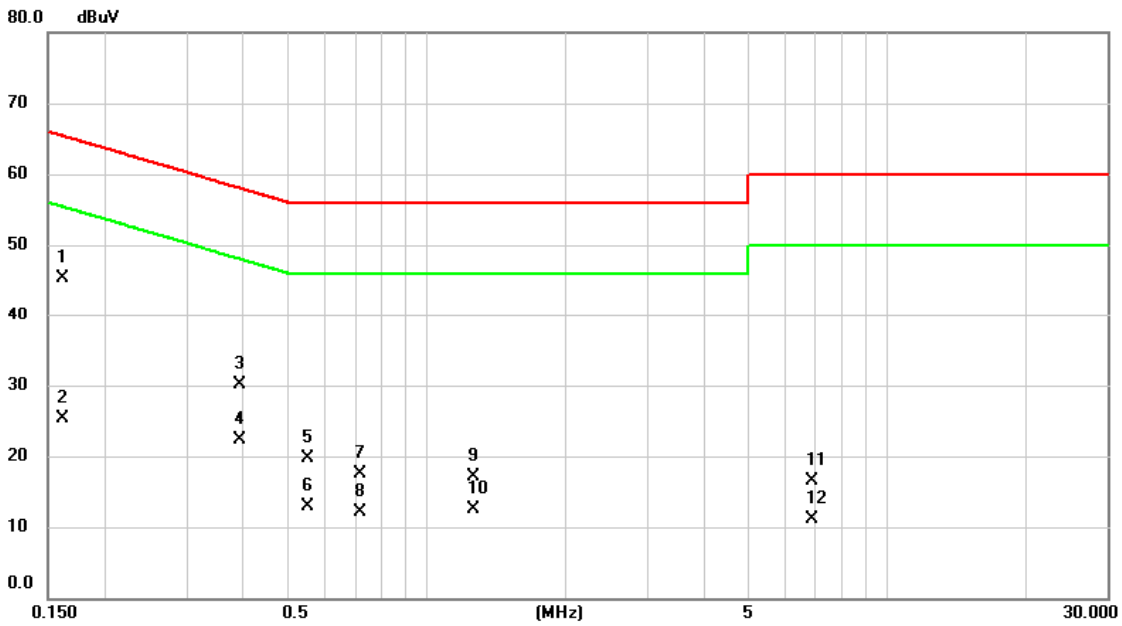

No.	Mk.	Freq. MHz	Reading Level dBuV	Correct Factor dB	Measure- ment dBuV	Limit dBuV	Over dB	Detector	Comment
1	*	0.1615	35.66	9.68	45.34	65.39	-20.05	QP	
2		0.1615	15.67	9.68	25.35	55.39	-30.04	AVG	
3		0.3930	20.52	9.68	30.20	58.00	-27.80	QP	
4		0.3930	12.57	9.68	22.25	48.00	-25.75	AVG	
5		0.5527	10.04	9.68	19.72	56.00	-36.28	QP	
6		0.5527	3.22	9.68	12.90	46.00	-33.10	AVG	
7		0.7170	7.74	9.68	17.42	56.00	-38.58	QP	
8		0.7170	2.38	9.68	12.06	46.00	-33.94	AVG	
9		1.2615	7.31	9.70	17.01	56.00	-38.99	QP	
10		1.2615	2.73	9.70	12.43	46.00	-33.57	AVG	
11		6.8865	6.55	9.87	16.42	60.00	-43.58	QP	
12		6.8865	1.20	9.87	11.07	50.00	-38.93	AVG	

REMARKS:

- (1) Measurement Value = Reading Level + Correct Factor.
- (2) Margin Level = Measurement Value - Limit Value.

APPENDIX B RADIATED EMISSIONS - 30 MHZ TO 1 GHZ

Test Mode	BLE5.0 (2Mbps)	Test Date	2021/3/8
Test Frequency	2480MHz	Polarization	Vertical
Temp	21°C	Hum.	68%

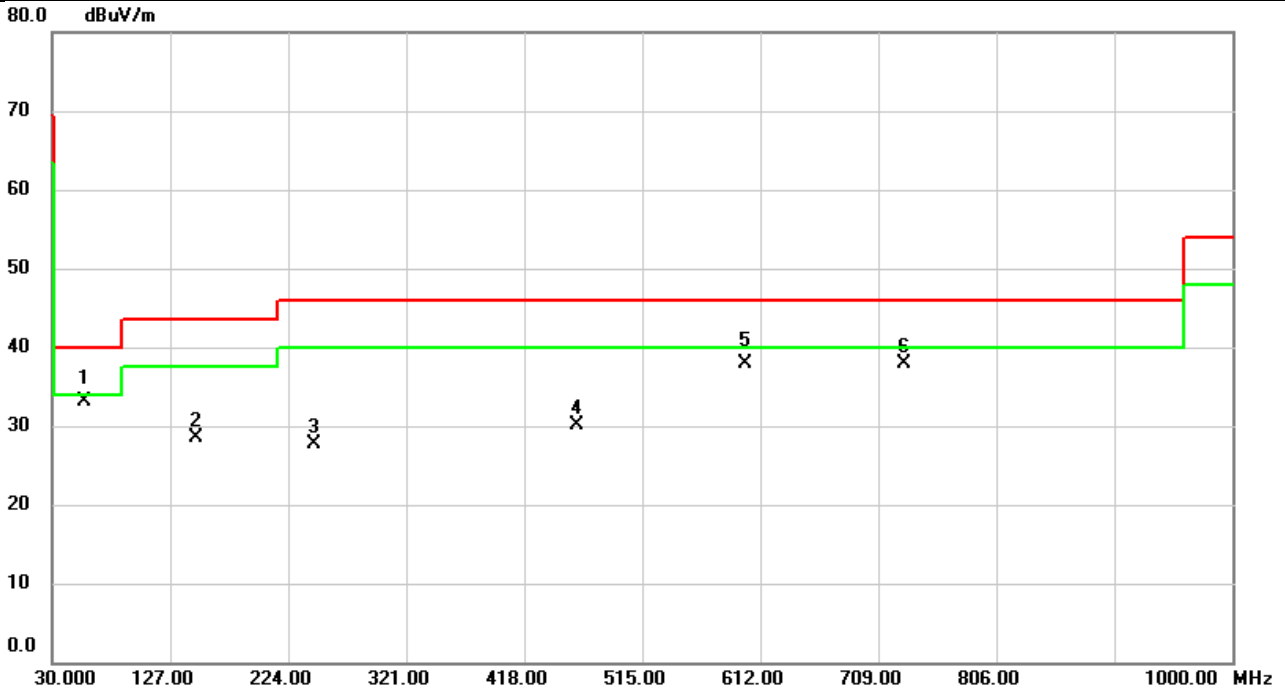

No.	Mk.	Freq.	Reading Level	Correct Factor	Measure-ment	Limit	Over	Detector	Comment
		MHz	dBuV	dB	dBuV/m	dBuV/m	dB		
1	*	56.7073	41.56	-8.47	33.09	40.00	-6.91	QP	
2		147.8873	37.00	-8.53	28.47	43.50	-15.03	peak	
3		245.7603	37.15	-9.44	27.71	46.00	-18.29	peak	
4		461.5206	33.66	-3.47	30.19	46.00	-15.81	peak	
5		599.9720	38.56	-0.63	37.93	46.00	-8.07	QP	
6		730.4370	36.38	1.50	37.88	46.00	-8.12	peak	

REMARKS:

- (1) Measurement Value = Reading Level + Correct Factor.
- (2) Margin Level = Measurement Value - Limit Value.

Test Mode	BLE5.0 (2Mbps)	Test Date	2021/3/8
Test Frequency	2480MHz	Polarization	Horizontal
Temp	21°C	Hum.	68%

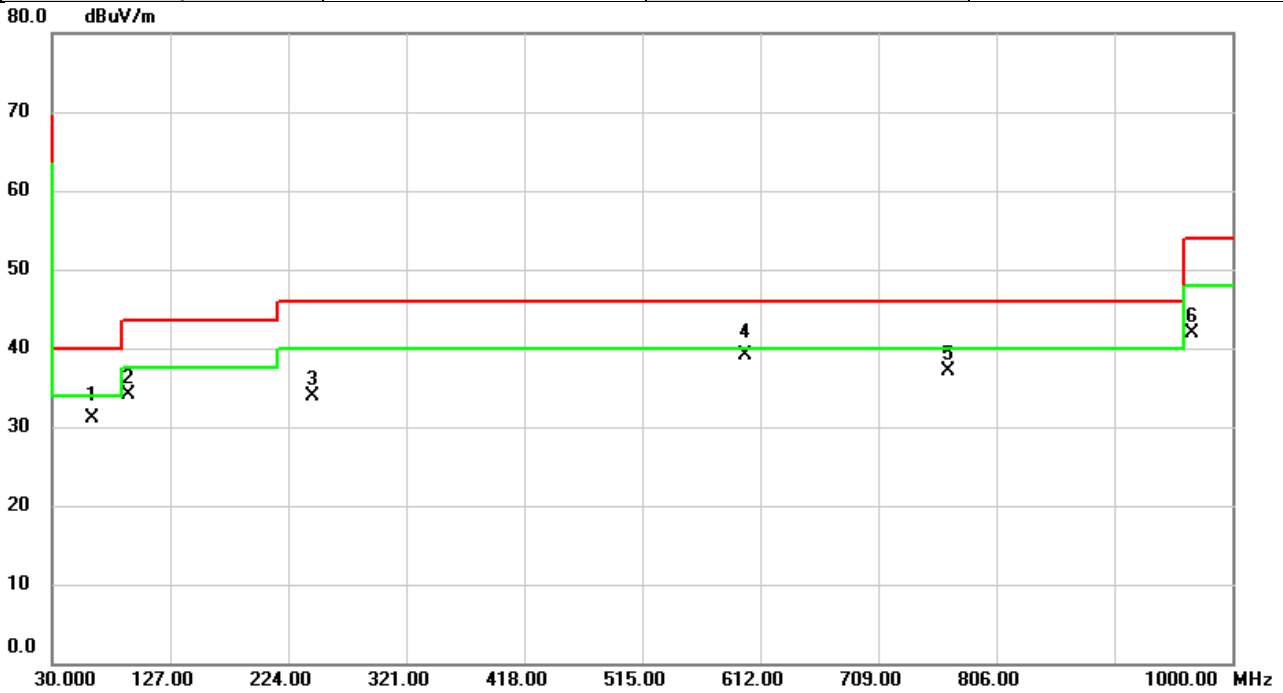

No.	Mk.	Freq.	Reading Level	Correct Factor	Measurement	Limit	Over	Detector	Comment
		MHz	dBuV	dB	dBuV/m	dBuV/m	dB		
1		62.5273	40.28	-9.18	31.10	40.00	-8.90	QP	
2		92.1446	48.66	-14.47	34.19	43.50	-9.31	peak	
3		244.0790	43.46	-9.51	33.95	46.00	-12.05	peak	
4	*	600.1660	39.66	-0.63	39.03	46.00	-6.97	QP	
5		766.6503	35.00	2.14	37.14	46.00	-8.86	peak	
6		966.6643	36.66	5.30	41.96	54.00	-12.04	peak	

REMARKS:

- (1) Measurement Value = Reading Level + Correct Factor.
- (2) Margin Level = Measurement Value - Limit Value.

APPENDIX C RADIATED EMISSIONS - ABOVE 1 GHZ

Test Mode	BLE5.0 (1Mbps)	Test Date	2021/3/5
Test Frequency	2402MHz	Polarization	Vertical
Temp	22°C	Hum.	66%

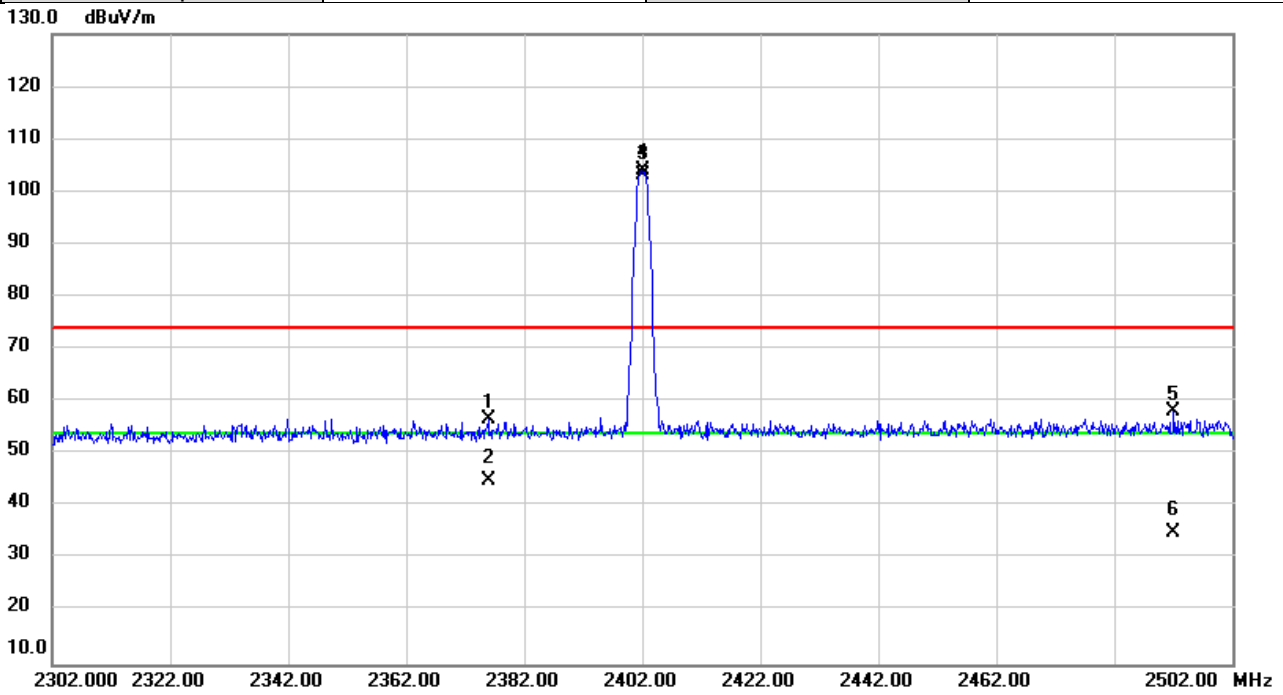

No.	Mk.	Freq.	Reading Level	Correct Factor	Measurement	Limit	Over	Detector	Comment
		MHz	dBuV	dB	dBuV/m	dBuV/m	dB		
1		2375.967	26.04	30.74	56.78	74.00	-17.22	peak	
2		2375.967	14.09	30.74	44.83	54.00	-9.17	AVG	
3	X	2402.000	73.13	30.84	103.97	74.00	29.97	peak	NoLimit
4	*	2402.000	72.42	30.84	103.26	54.00	49.26	AVG	NoLimit
5		2492.060	26.91	31.20	58.11	74.00	-15.89	peak	
6		2492.060	3.82	31.20	35.02	54.00	-18.98	AVG	

REMARKS:

- (1) Measurement Value = Reading Level + Correct Factor.
- (2) Margin Level = Measurement Value - Limit Value.

Test Mode	BLE5.0 (1Mbps)	Test Date	2021/3/5
Test Frequency	2480MHz	Polarization	Vertical
Temp	22°C	Hum.	66%

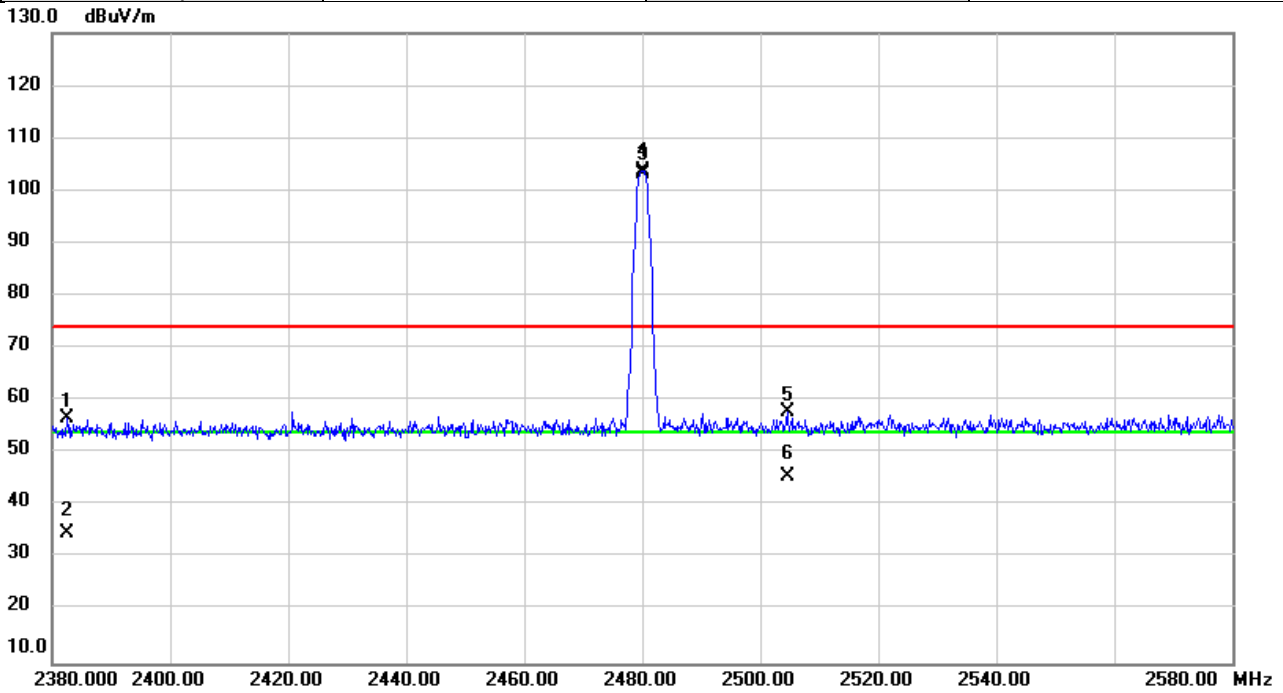

No.	Mk.	Freq.	Reading Level	Correct Factor	Measurement	Limit	Over	Detector	Comment
		MHz	dBuV	dB	dBuV/m	dBuV/m	dB		
1		2382.453	25.85	30.76	56.61	74.00	-17.39	peak	
2		2382.453	4.07	30.76	34.83	54.00	-19.17	AVG	
3	X	2480.000	72.72	31.15	103.87	74.00	29.87	peak	NoLimit
4	*	2480.000	72.14	31.15	103.29	54.00	49.29	AVG	NoLimit
5		2504.580	26.49	31.24	57.73	74.00	-16.27	peak	
6		2504.580	14.30	31.24	45.54	54.00	-8.46	AVG	

REMARKS:

- (1) Measurement Value = Reading Level + Correct Factor.
- (2) Margin Level = Measurement Value - Limit Value.

Test Mode	BLE5.0 (2Mbps)	Test Date	2021/3/5
Test Frequency	2402MHz	Polarization	Vertical
Temp	22°C	Hum.	66%

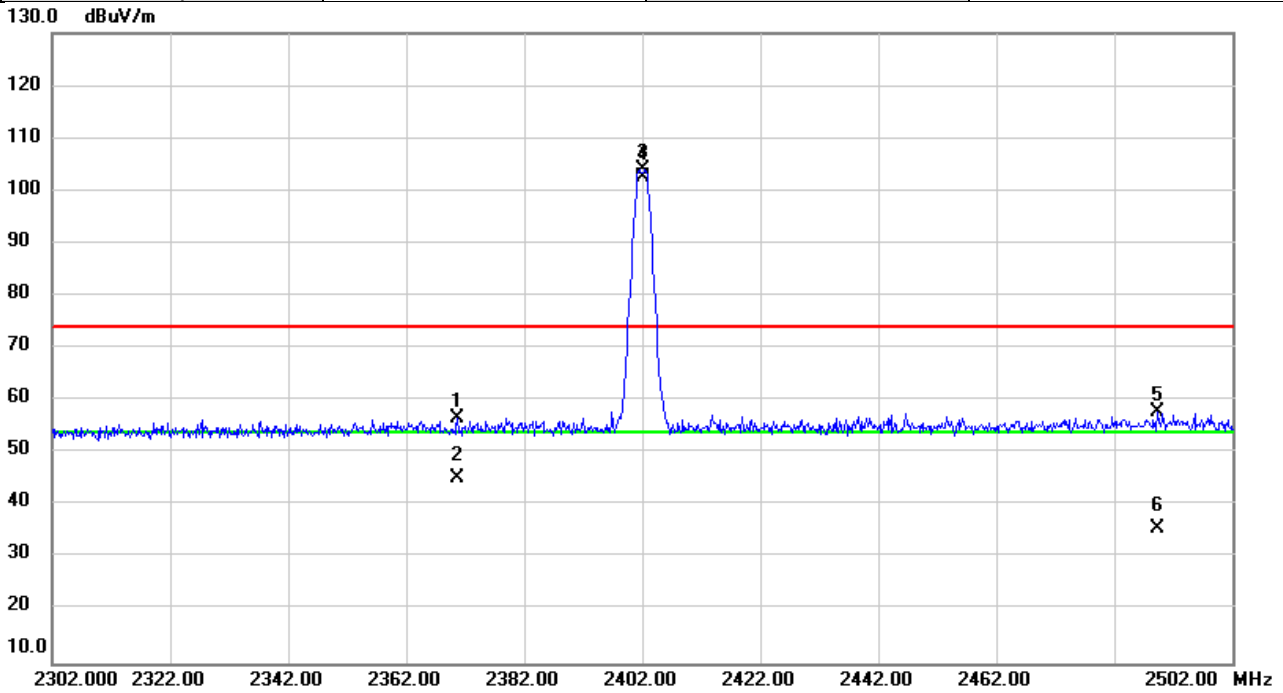

No.	Mk.	Freq.	Reading Level	Correct Factor	Measurement	Limit	Over	Detector	Comment
		MHz	dBuV	dB	dBuV/m	dBuV/m	dB		
1		2370.647	25.84	30.71	56.55	74.00	-17.45	peak	
2		2370.647	14.59	30.71	45.30	54.00	-8.70	AVG	
3	X	2402.000	73.12	30.84	103.96	74.00	29.96	peak	NoLimit
4	*	2402.000	71.57	30.84	102.41	54.00	48.41	AVG	NoLimit
5		2489.293	26.71	31.18	57.89	74.00	-16.11	peak	
6		2489.293	4.55	31.18	35.73	54.00	-18.27	AVG	

REMARKS:

- (1) Measurement Value = Reading Level + Correct Factor.
- (2) Margin Level = Measurement Value - Limit Value.

Test Mode	BLE5.0 (2Mbps)	Test Date	2021/3/5
Test Frequency	2480MHz	Polarization	Vertical
Temp	22°C	Hum.	66%

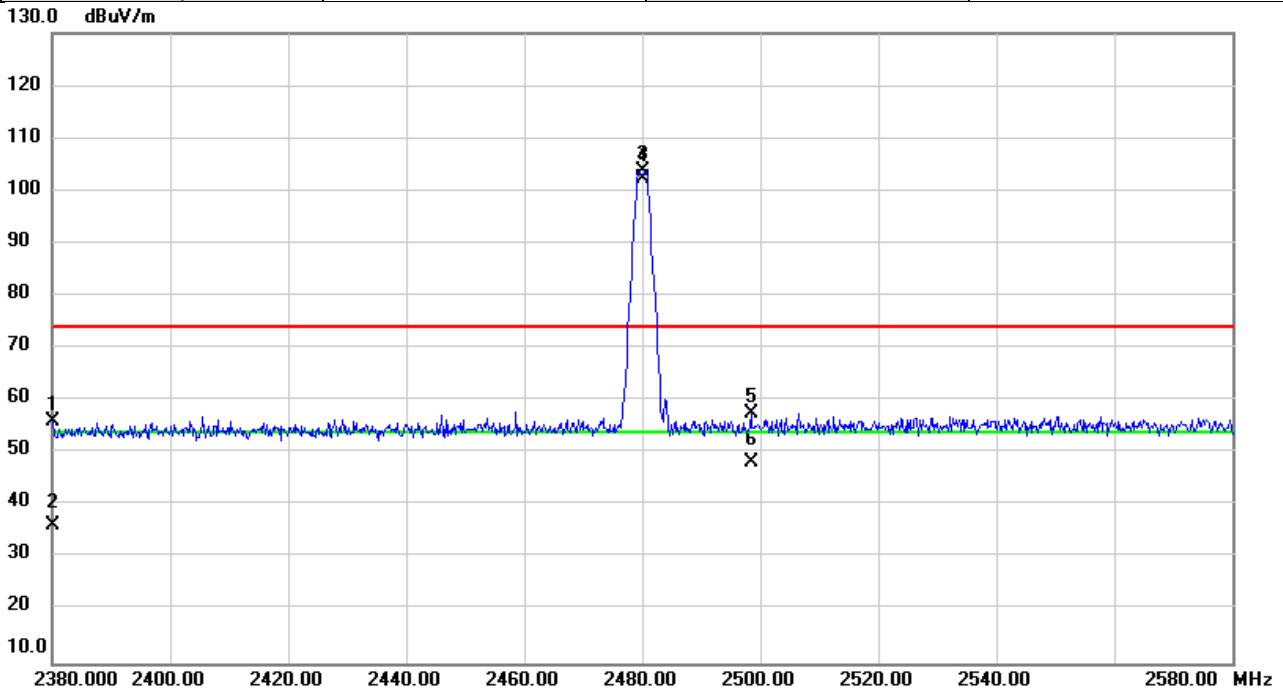

No.	Mk.	Freq.	Reading Level	Correct Factor	Measurement	Limit	Over	Detector	Comment
		MHz	dBuV	dB	dBuV/m	dBuV/m	dB		
1		2380.000	25.27	30.75	56.02	74.00	-17.98	peak	
2		2380.000	5.38	30.75	36.13	54.00	-17.87	AVG	
3	X	2480.000	72.54	31.15	103.69	74.00	29.69	peak	NoLimit
4	*	2480.000	71.04	31.15	102.19	54.00	48.19	AVG	NoLimit
5		2498.513	26.36	31.22	57.58	74.00	-16.42	peak	
6		2498.513	16.99	31.22	48.21	54.00	-5.79	AVG	

REMARKS:

- (1) Measurement Value = Reading Level + Correct Factor.
- (2) Margin Level = Measurement Value - Limit Value.

Test Mode	BLE5.0 (1Mbps)	Test Date	2021/3/5
Test Frequency	2402MHz	Polarization	Vertical
Temp	22°C	Hum.	66%

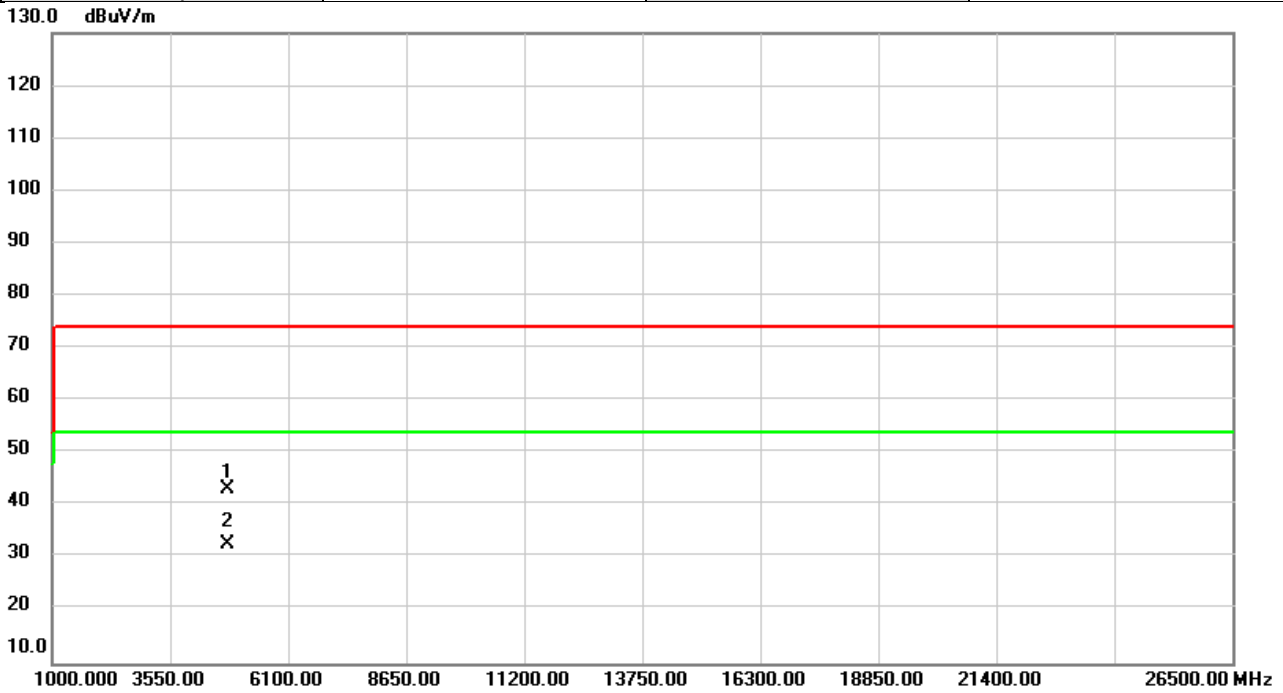

No.	Mk.	Freq. MHz	Reading Level dBuV	Correct Factor dB	Measure- ment dBuV/m	Limit dBuV/m	Over dB	Detector	Comment
1		4804.000	53.23	-10.03	43.20	74.00	-30.80	peak	
2	*	4804.000	42.54	-10.03	32.51	54.00	-21.49	AVG	

REMARKS:

- (1) Measurement Value = Reading Level + Correct Factor.
- (2) Margin Level = Measurement Value - Limit Value.

Test Mode	BLE5.0 (1Mbps)	Test Date	2021/3/5
Test Frequency	2402MHz	Polarization	Horizontal
Temp	22°C	Hum.	66%

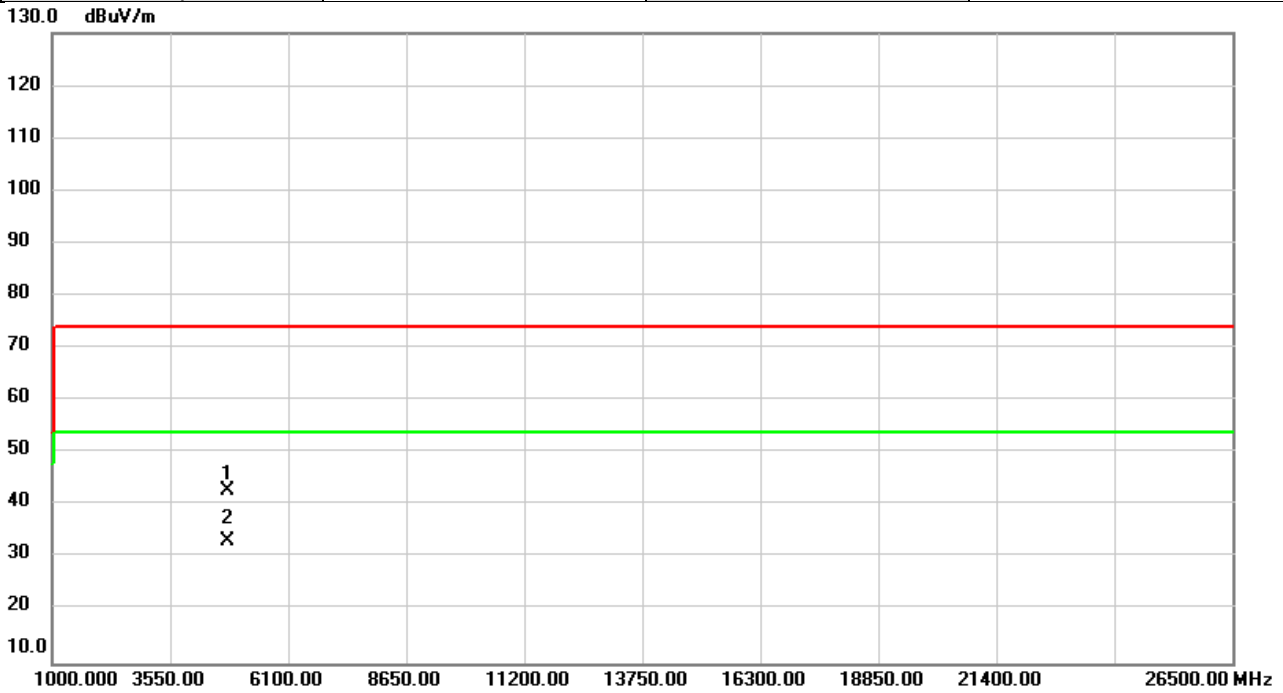

No.	Mk.	Freq.	Reading Level	Correct Factor	Measurement	Limit	Over	Detector	Comment
		MHz	dBuV	dB	dBuV/m	dBuV/m	dB		
1		4804.000	52.73	-10.03	42.70	74.00	-31.30	peak	
2	*	4804.000	43.39	-10.03	33.36	54.00	-20.64	AVG	

REMARKS:

- (1) Measurement Value = Reading Level + Correct Factor.
- (2) Margin Level = Measurement Value - Limit Value.

Test Mode	BLE5.0 (1Mbps)	Test Date	2021/3/5
Test Frequency	2440MHz	Polarization	Vertical
Temp	22°C	Hum.	66%

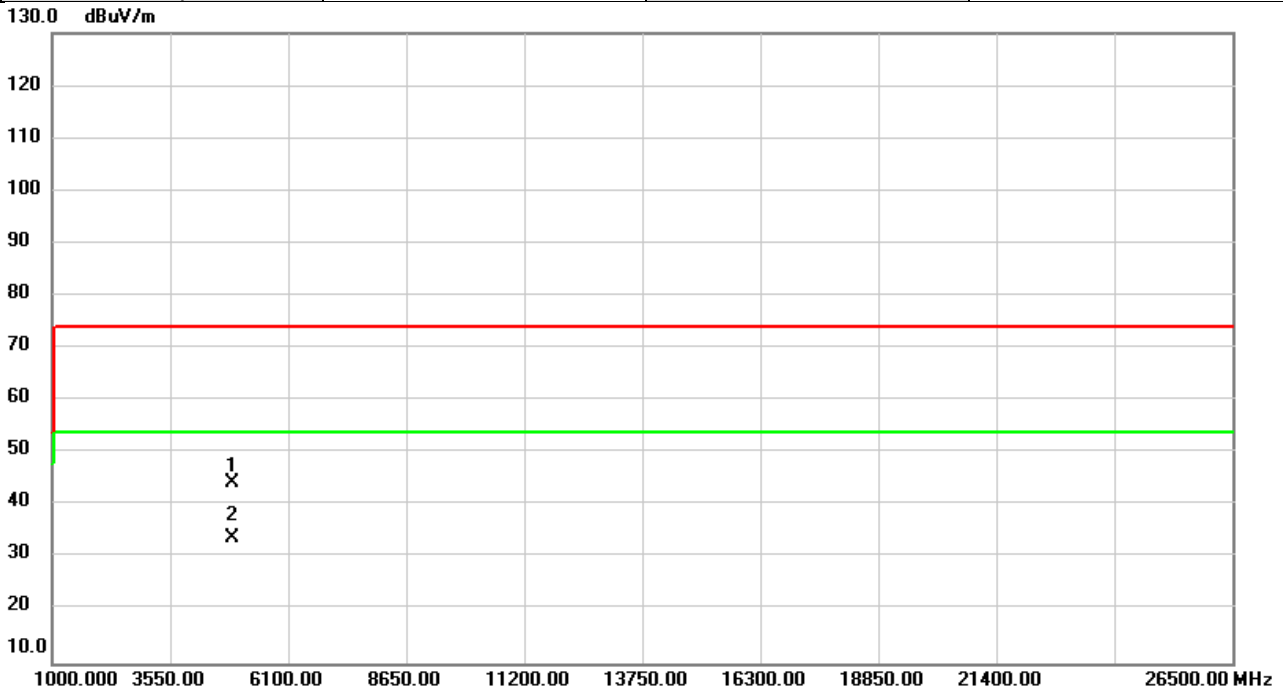

No.	Mk.	Freq.	Reading Level	Correct Factor	Measurement	Limit	Over	Detector	Comment
		MHz	dBuV	dB	dBuV/m	dBuV/m	dB		
1		4880.000	54.25	-9.77	44.48	74.00	-29.52	peak	
2	*	4880.000	43.77	-9.77	34.00	54.00	-20.00	AVG	

REMARKS:

- (1) Measurement Value = Reading Level + Correct Factor.
- (2) Margin Level = Measurement Value - Limit Value.

Test Mode	BLE5.0 (1Mbps)	Test Date	2021/3/5
Test Frequency	2440MHz	Polarization	Horizontal
Temp	22°C	Hum.	66%

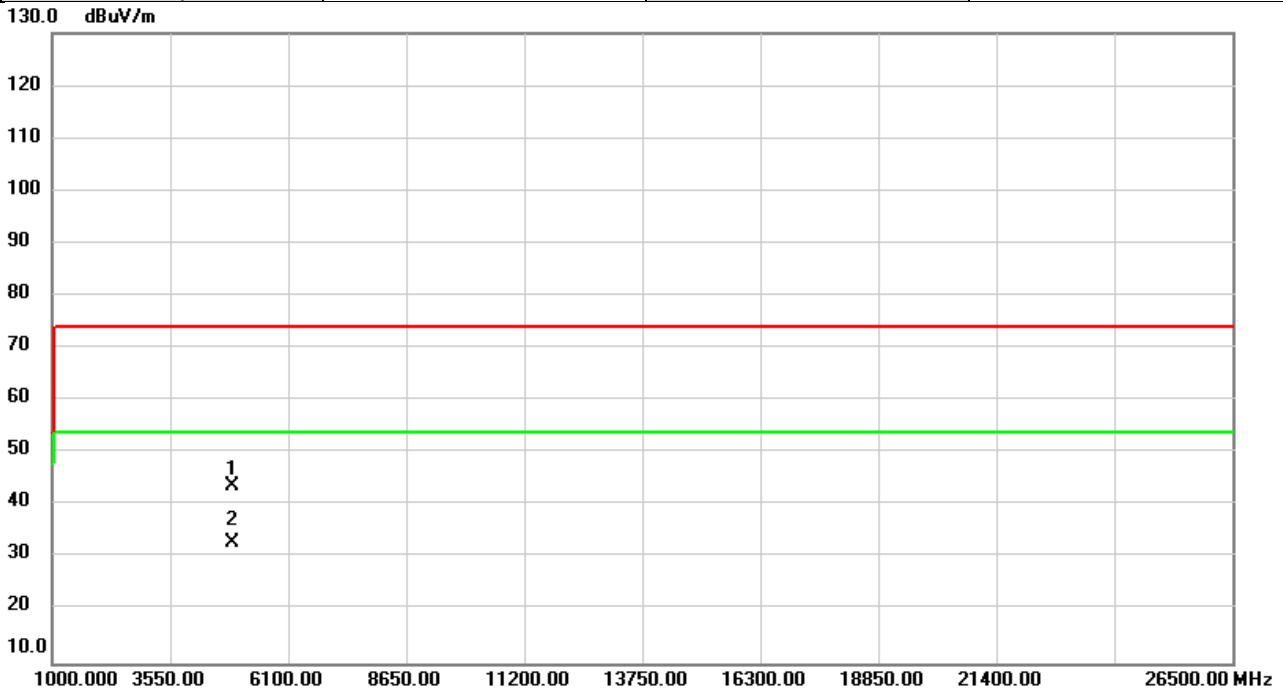

No.	Mk.	Freq.	Reading Level	Correct Factor	Measurement	Limit	Over	Detector	Comment
		MHz	dBuV	dB	dBuV/m	dBuV/m	dB		
1		4880.000	53.48	-9.77	43.71	74.00	-30.29	peak	
2	*	4880.000	42.75	-9.77	32.98	54.00	-21.02	AVG	

REMARKS:

- (1) Measurement Value = Reading Level + Correct Factor.
- (2) Margin Level = Measurement Value - Limit Value.

Test Mode	BLE5.0 (1Mbps)	Test Date	2021/3/5
Test Frequency	2480MHz	Polarization	Vertical
Temp	22°C	Hum.	66%

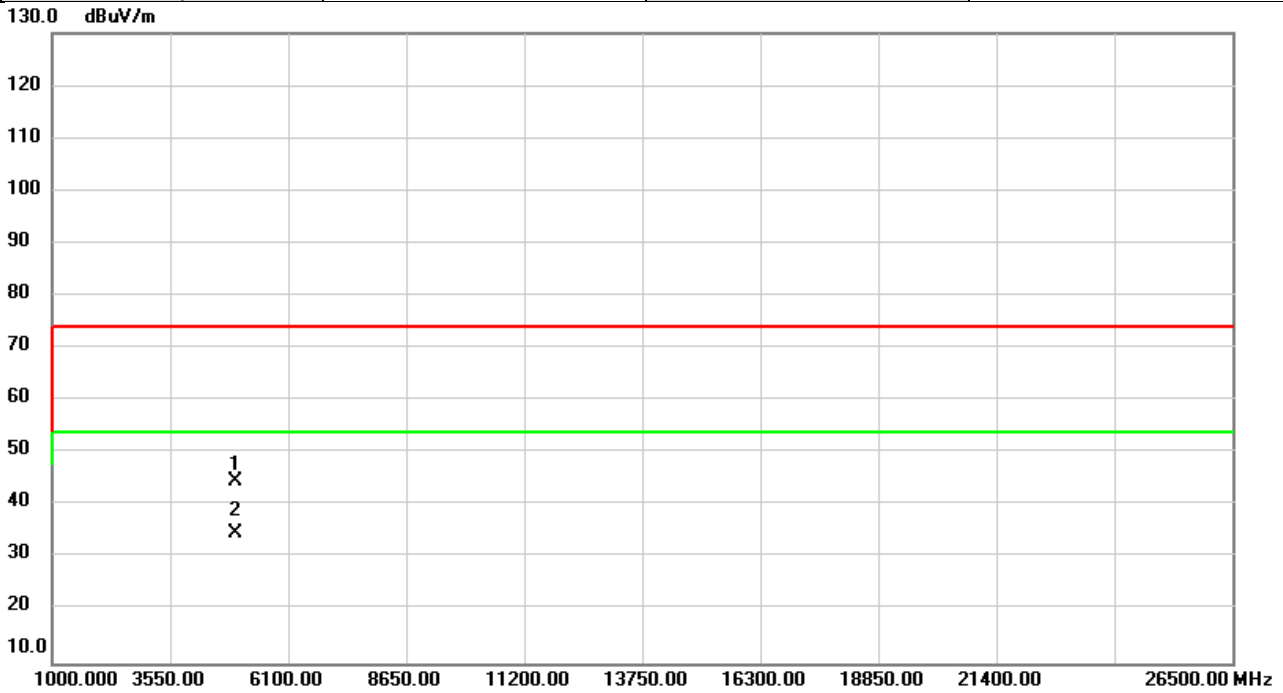

No.	Mk.	Freq.	Reading Level	Correct Factor	Measurement	Limit	Over	Detector	Comment
		MHz	dBuV	dB	dBuV/m	dBuV/m	dB		
1		4960.000	54.22	-9.49	44.73	74.00	-29.27	peak	
2	*	4960.000	44.32	-9.49	34.83	54.00	-19.17	AVG	

REMARKS:

- (1) Measurement Value = Reading Level + Correct Factor.
- (2) Margin Level = Measurement Value - Limit Value.

Test Mode	BLE5.0 (1Mbps)	Test Date	2021/3/5
Test Frequency	2480MHz	Polarization	Horizontal
Temp	22°C	Hum.	66%

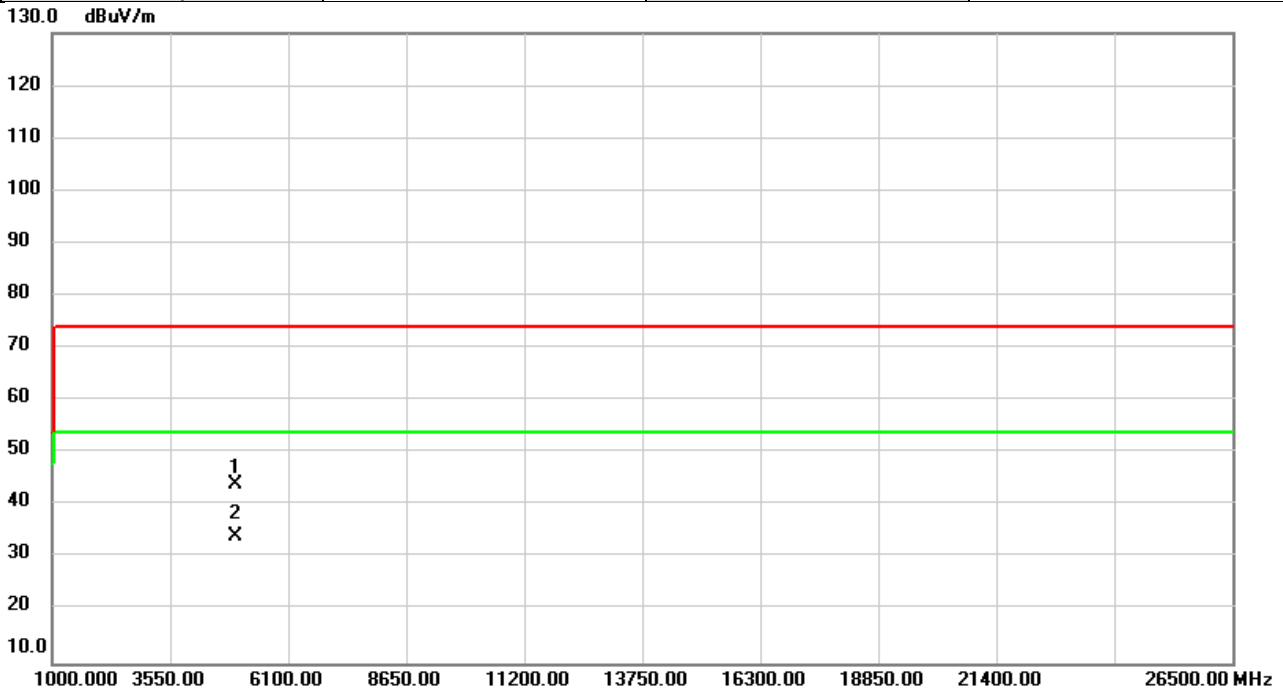

No.	Mk.	Freq.	Reading Level	Correct Factor	Measurement	Limit	Over	Detector	Comment
		MHz	dBuV	dB	dBuV/m	dBuV/m	dB		
1		4960.000	53.45	-9.49	43.96	74.00	-30.04	peak	
2	*	4960.000	43.77	-9.49	34.28	54.00	-19.72	AVG	

REMARKS:

- (1) Measurement Value = Reading Level + Correct Factor.
- (2) Margin Level = Measurement Value - Limit Value.

Test Mode	BLE5.0 (2Mbps)	Test Date	2021/3/5
Test Frequency	2402MHz	Polarization	Vertical
Temp	22°C	Hum.	66%

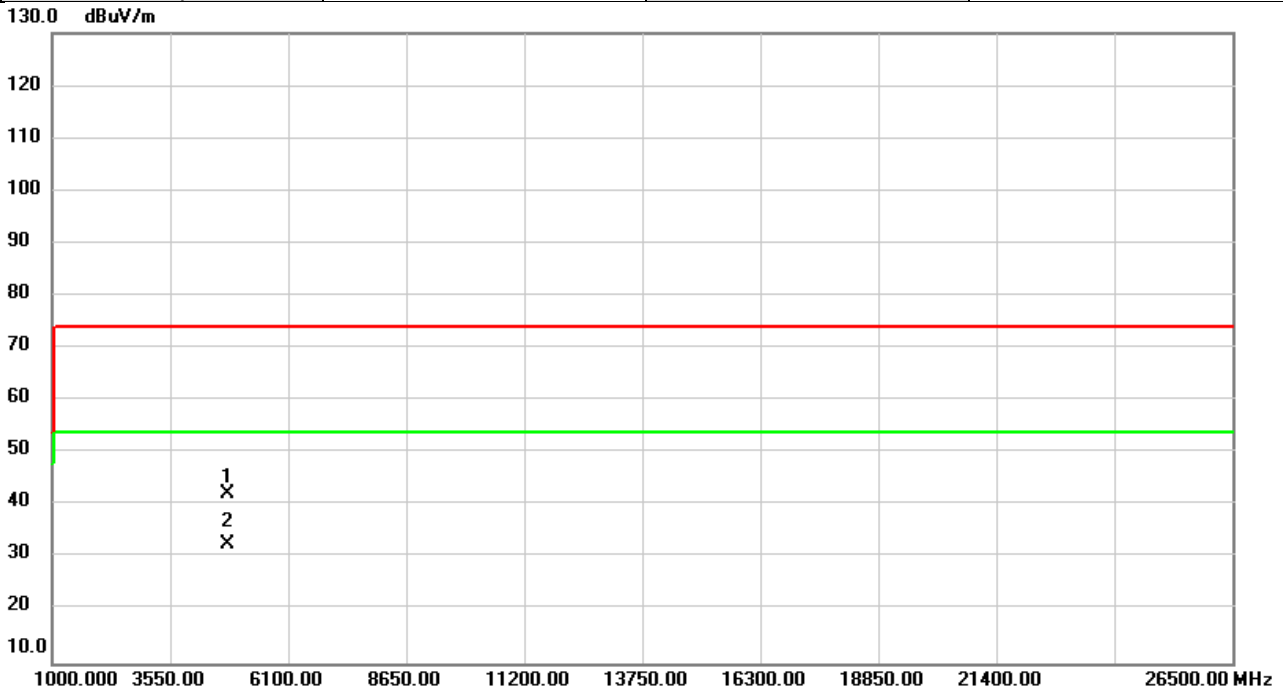

No.	Mk.	Freq.	Reading Level	Correct Factor	Measurement	Limit	Over	Detector	Comment
		MHz	dBuV	dB	dBuV/m	dBuV/m	dB		
1		4804.000	52.38	-10.03	42.35	74.00	-31.65	peak	
2	*	4804.000	42.57	-10.03	32.54	54.00	-21.46	AVG	

REMARKS:

- (1) Measurement Value = Reading Level + Correct Factor.
- (2) Margin Level = Measurement Value - Limit Value.

Test Mode	BLE5.0 (2Mbps)	Test Date	2021/3/5
Test Frequency	2402MHz	Polarization	Horizontal
Temp	22°C	Hum.	66%

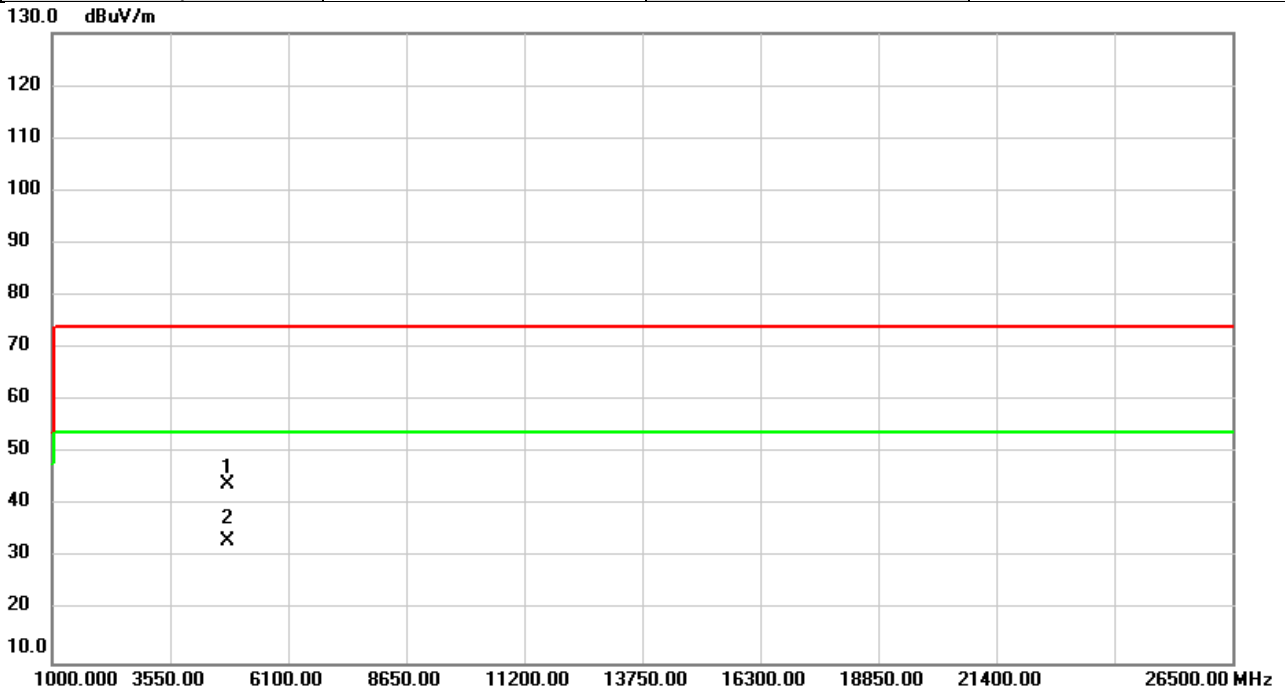

No.	Mk.	Freq.	Reading Level	Correct Factor	Measurement	Limit	Over	Detector	Comment
		MHz	dBuV	dB	dBuV/m	dBuV/m	dB		
1		4804.000	54.21	-10.03	44.18	74.00	-29.82	peak	
2	*	4804.000	43.25	-10.03	33.22	54.00	-20.78	AVG	

REMARKS:

- (1) Measurement Value = Reading Level + Correct Factor.
- (2) Margin Level = Measurement Value - Limit Value.

Test Mode	BLE5.0 (2Mbps)	Test Date	2021/3/5
Test Frequency	2440MHz	Polarization	Vertical
Temp	22°C	Hum.	66%

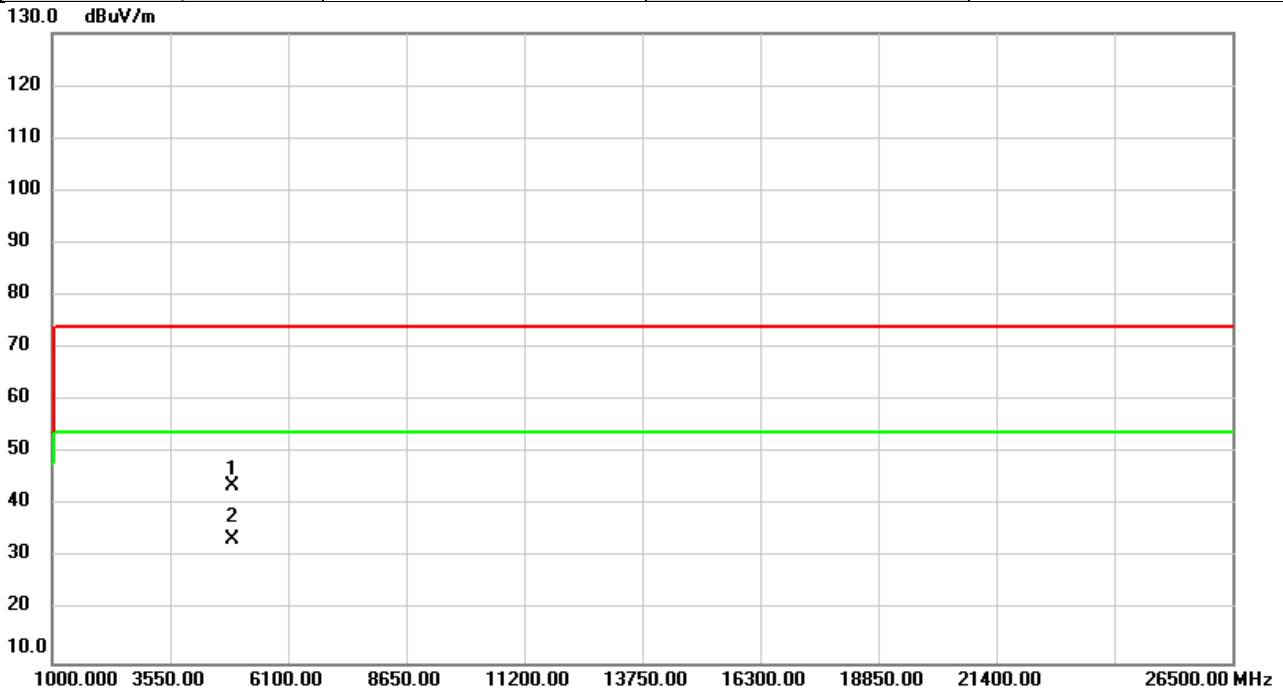

No.	Mk.	Freq.	Reading Level	Correct Factor	Measurement	Limit	Over	Detector	Comment
		MHz	dBuV	dB	dBuV/m	dBuV/m	dB		
1		4880.000	53.37	-9.77	43.60	74.00	-30.40	peak	
2	*	4880.000	43.39	-9.77	33.62	54.00	-20.38	AVG	

REMARKS:

- (1) Measurement Value = Reading Level + Correct Factor.
- (2) Margin Level = Measurement Value - Limit Value.

Test Mode	BLE5.0 (2Mbps)	Test Date	2021/3/5
Test Frequency	2440MHz	Polarization	Horizontal
Temp	22°C	Hum.	66%

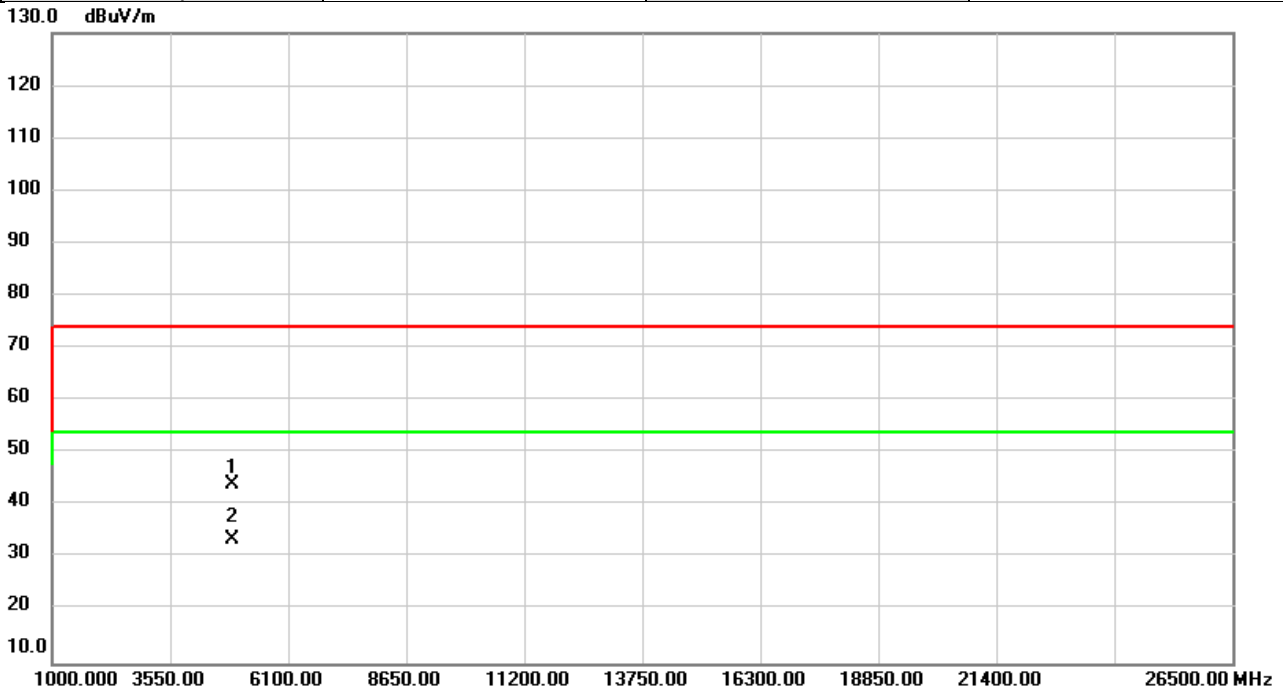

No.	Mk.	Freq.	Reading Level	Correct Factor	Measurement	Limit	Over	Detector	Comment
		MHz	dBuV	dB	dBuV/m	dBuV/m	dB		
1		4880.000	53.81	-9.77	44.04	74.00	-29.96	peak	
2	*	4880.000	43.19	-9.77	33.42	54.00	-20.58	AVG	

REMARKS:

- (1) Measurement Value = Reading Level + Correct Factor.
- (2) Margin Level = Measurement Value - Limit Value.

Test Mode	BLE5.0 (2Mbps)	Test Date	2021/3/5
Test Frequency	2480MHz	Polarization	Vertical
Temp	22°C	Hum.	66%

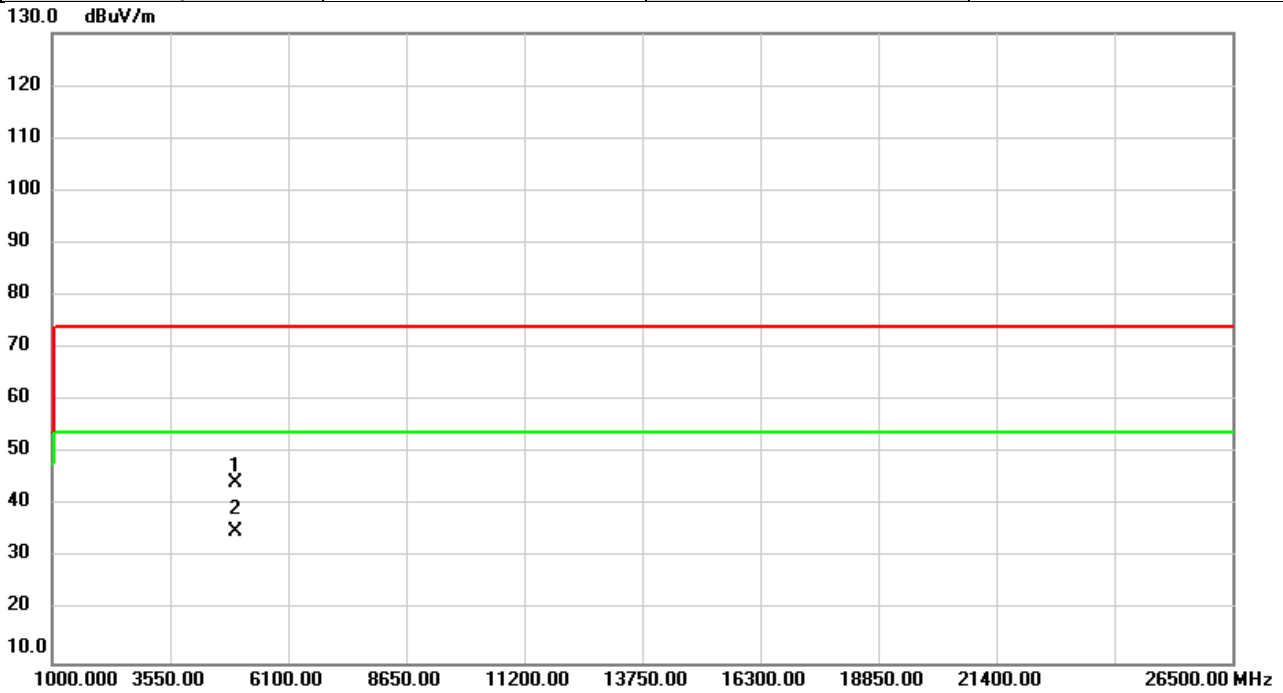

No.	Mk.	Freq. MHz	Reading Level dBuV	Correct Factor dB	Measure- ment dBuV/m	Limit dBuV/m	Over dB	Detector	Comment
1		4960.000	53.83	-9.49	44.34	74.00	-29.66	peak	
2	*	4960.000	44.64	-9.49	35.15	54.00	-18.85	AVG	

REMARKS:

- (1) Measurement Value = Reading Level + Correct Factor.
- (2) Margin Level = Measurement Value - Limit Value.

Test Mode	BLE5.0 (2Mbps)	Test Date	2021/3/5
Test Frequency	2480MHz	Polarization	Horizontal
Temp	22°C	Hum.	66%

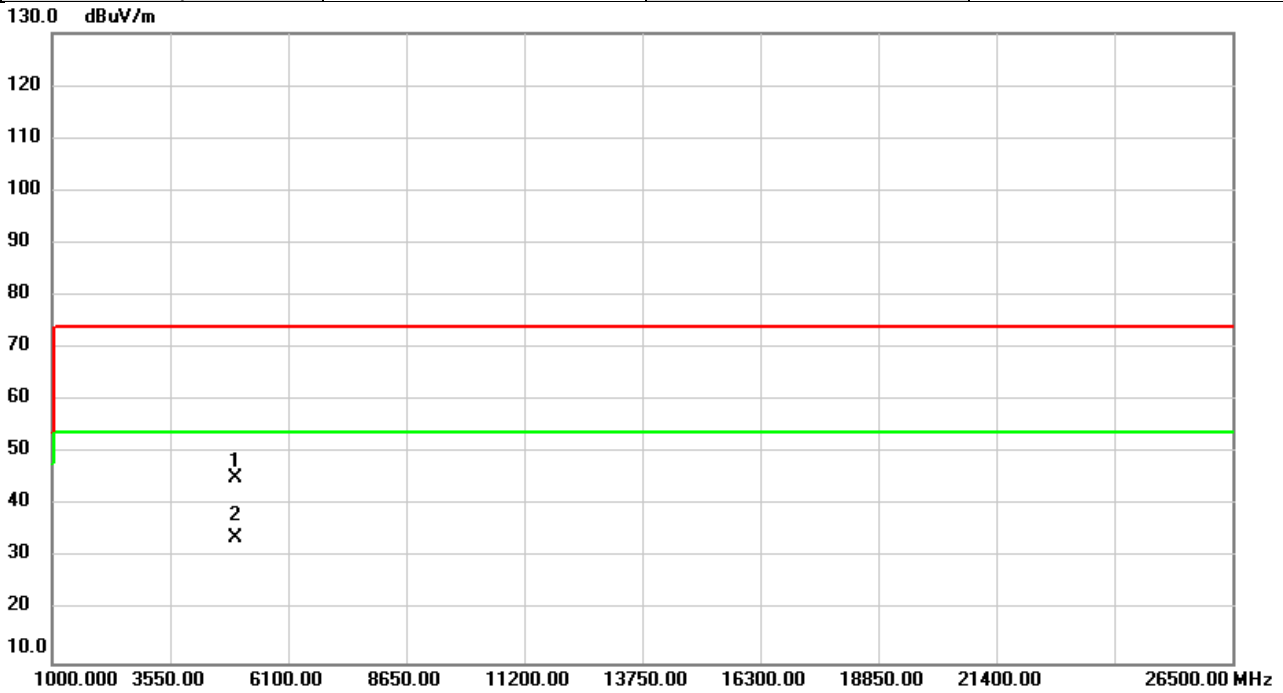

No.	Mk.	Freq.	Reading Level	Correct Factor	Measurement	Limit	Over	Detector	Comment
		MHz	dBuV	dB	dBuV/m	dBuV/m	dB		
1		4960.000	54.74	-9.49	45.25	74.00	-28.75	peak	
2	*	4960.000	43.37	-9.49	33.88	54.00	-20.12	AVG	

REMARKS:

- (1) Measurement Value = Reading Level + Correct Factor.
- (2) Margin Level = Measurement Value - Limit Value.

APPENDIX D BANDWIDTH

Test Mode:	1Mbps
------------	-------

Frequency (MHz)	6dB Bandwidth (MHz)	99% Occupied BW (MHz)	Min. Limit (kHz)	Test Result
2402	0.71	1.06	500	Pass
2440	0.70	1.06	500	Pass
2480	0.71	1.06	500	Pass

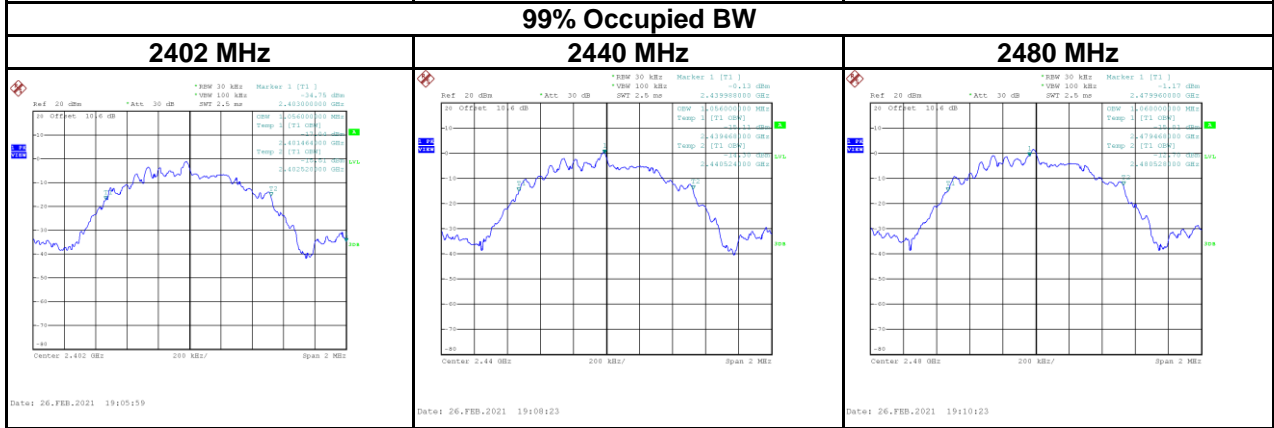
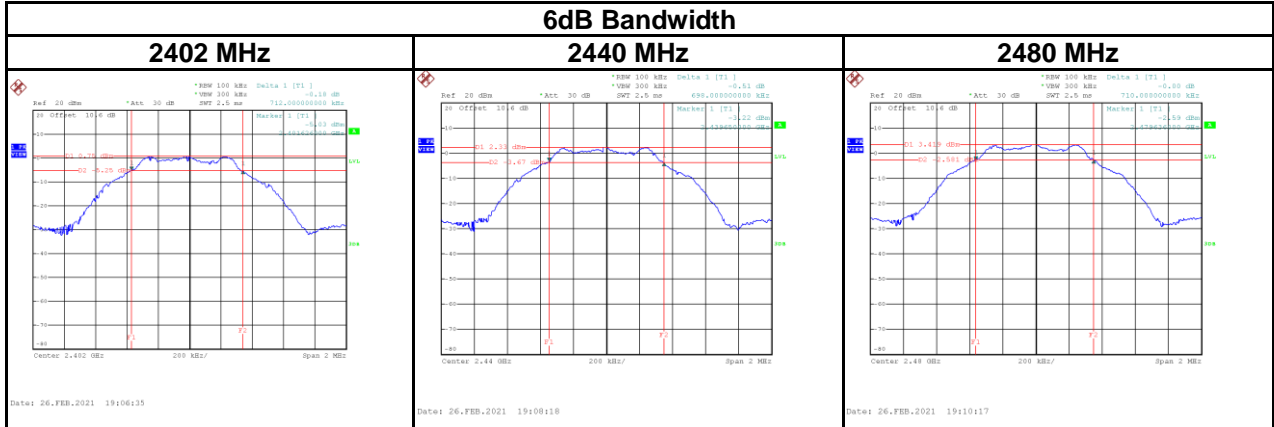

Test Mode:	2Mbps
------------	-------

Frequency (MHz)	6dB Bandwidth (MHz)	99% Occupied BW (MHz)	Min. Limit (kHz)	Test Result
2402	1.09	2.10	500	Pass
2440	1.11	2.08	500	Pass
2480	1.10	2.09	500	Pass

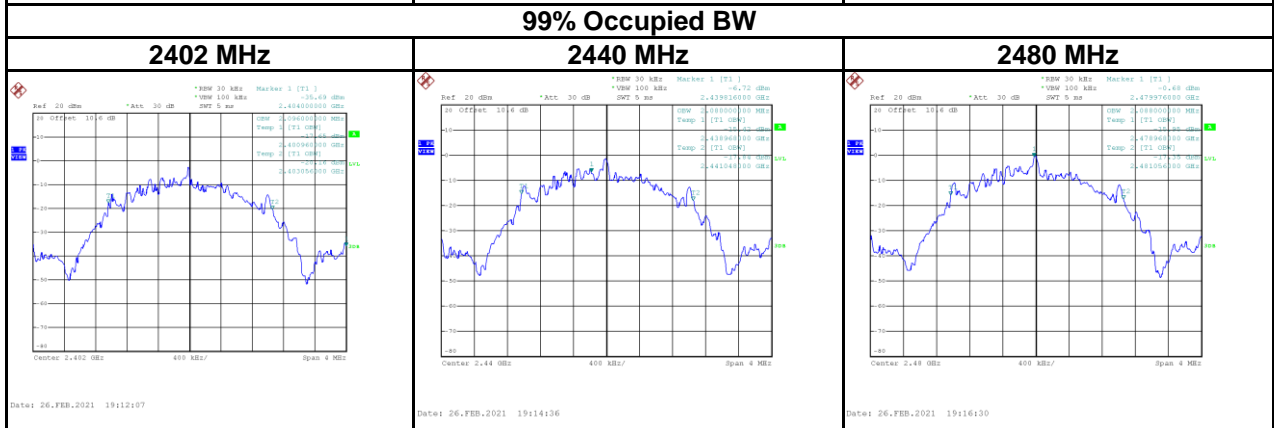
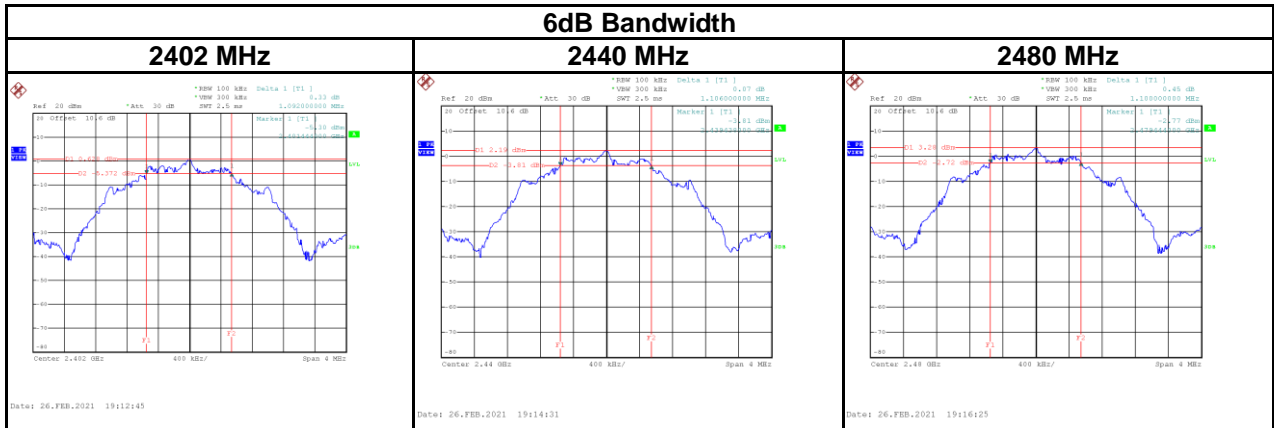

APPENDIX E OUTPUT POWER

Test Mode :	1Mbps	Tested Date	2021/2/24
-------------	-------	-------------	-----------

Frequency (MHz)	Conducted Power (dBm)	Conducted Power (W)	Max. Limit (dBm)	Max. Limit (W)	Test Result
2402	2.47	0.0018	30.00	1.0000	Pass
2440	4.09	0.0026	30.00	1.0000	Pass
2480	4.97	0.0031	30.00	1.0000	Pass

Test Mode :	2Mbps	Tested Date	2021/2/24
-------------	-------	-------------	-----------

Frequency (MHz)	Conducted Power (dBm)	Conducted Power (W)	Max. Limit (dBm)	Max. Limit (W)	Test Result
2402	2.45	0.0018	30.00	1.0000	Pass
2440	4.11	0.0026	30.00	1.0000	Pass
2480	4.91	0.0031	30.00	1.0000	Pass

APPENDIX F POWER SPECTRAL DENSITY TEST

Test Mode :	1Mbps
-------------	-------

Frequency (MHz)	Power Density (dBm/3kHz)	Max. Limit (dBm/3kHz)	Test Result
2402	-13.02	8	Pass
2440	-11.53	8	Pass
2480	-10.46	8	Pass

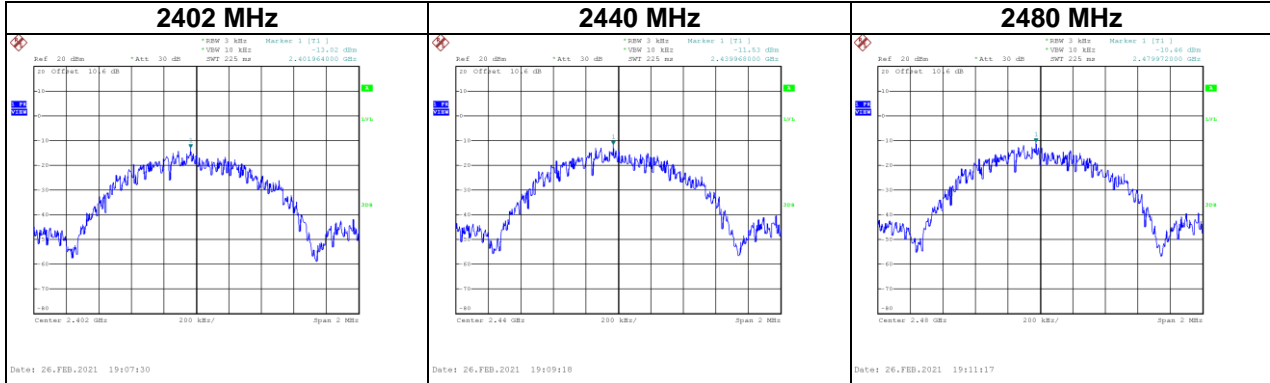

Test Mode :	2Mbps
-------------	-------

Frequency (MHz)	Power Density (dBm/3kHz)	Max. Limit (dBm/3kHz)	Test Result
2402	-15.61	8	Pass
2440	-14.51	8	Pass
2480	-13.02	8	Pass

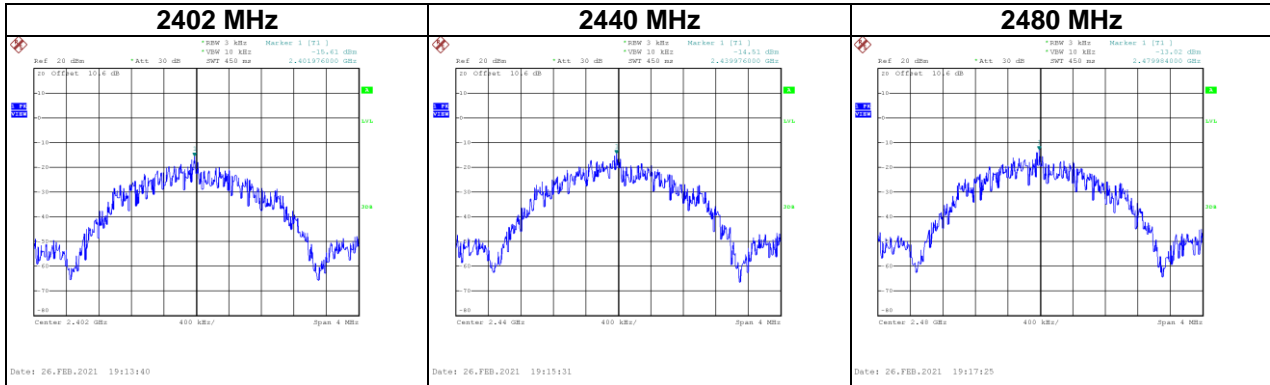

APPENDIX G ANTENNA CONDUCTED SPURIOUS EMISSION

Test Mode : 1Mbps

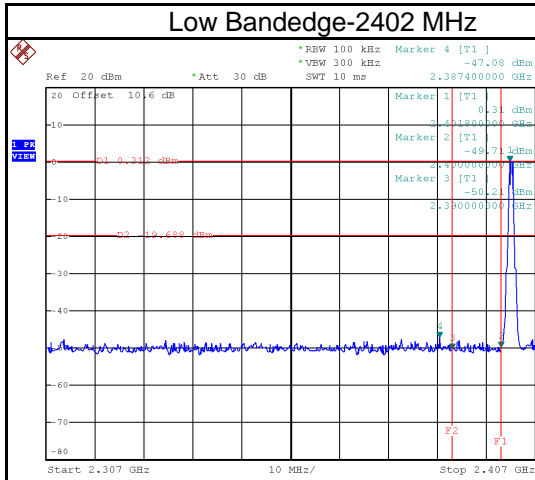

Date: 26.FEB.2021 19:06:59

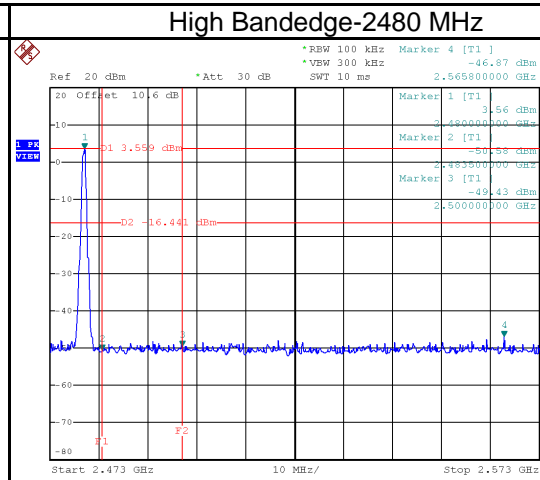

Date: 26.FEB.2021 19:10:46

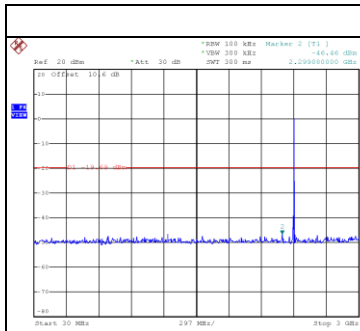

Date: 26.FEB.2021 19:07:11

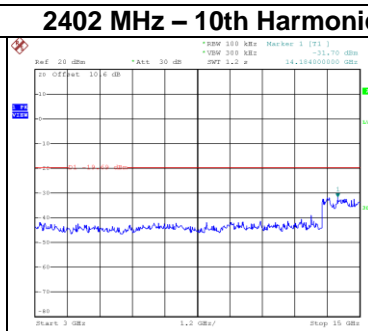

Date: 26.FEB.2021 19:07:10

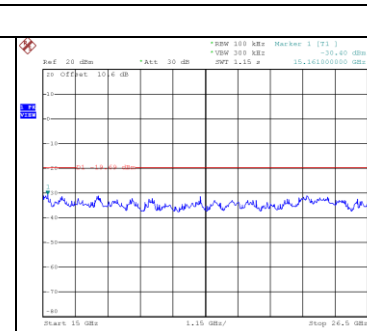

Date: 26.FEB.2021 19:07:25

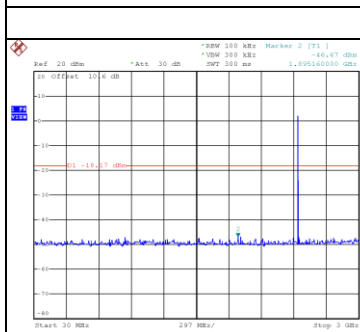

Date: 26.FEB.2021 19:09:00

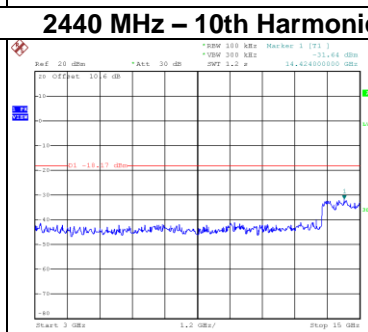

Date: 26.FEB.2021 19:09:06

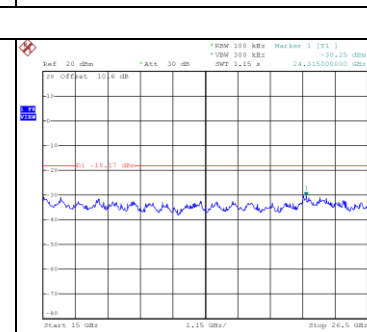

Date: 26.FEB.2021 19:09:13

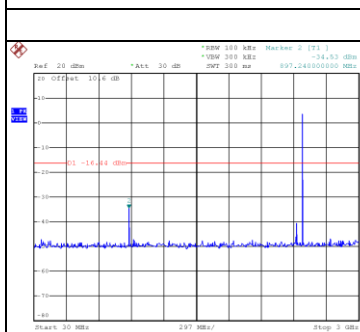

Date: 26.FEB.2021 19:10:59

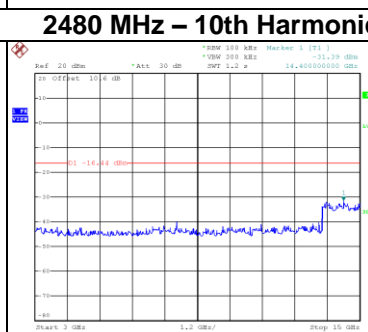

Date: 26.FEB.2021 19:11:05

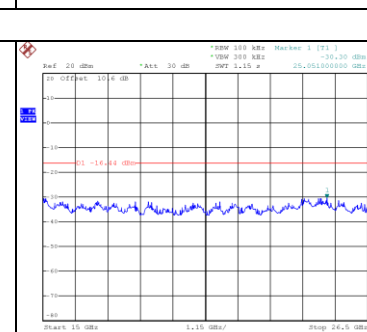

Date: 26.FEB.2021 19:11:12

Test Mode : 2Mbps

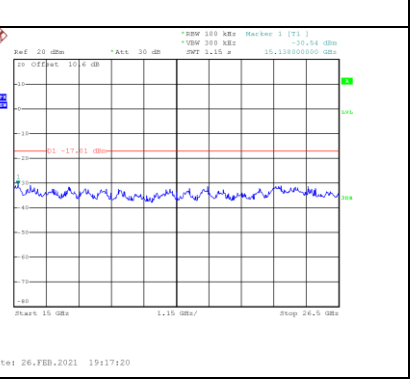
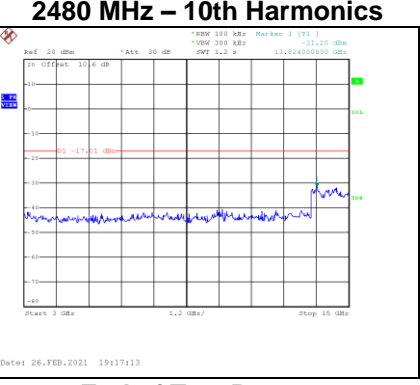
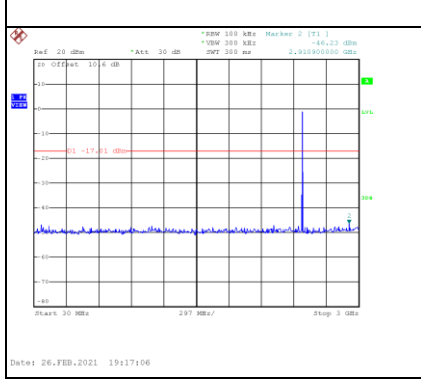
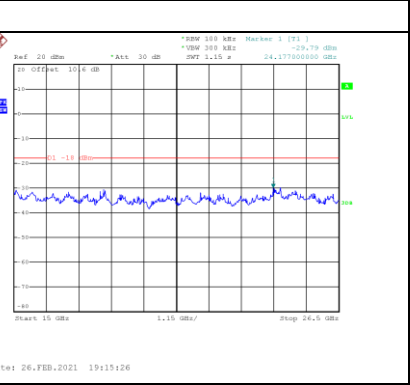
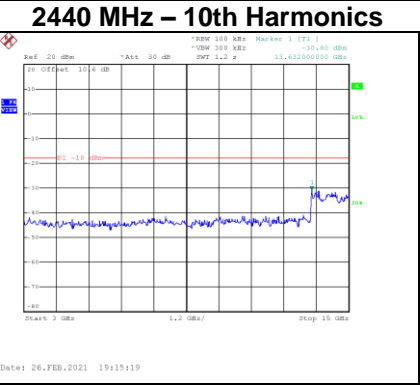
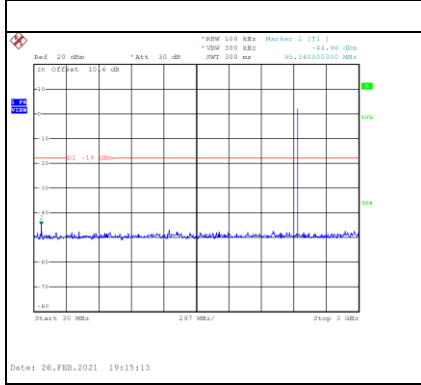
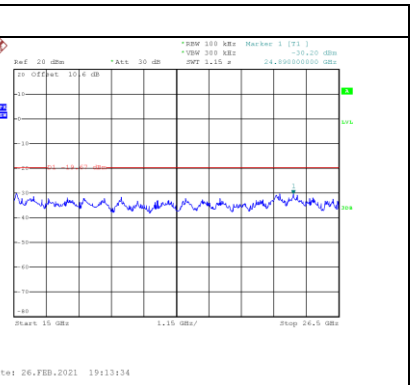
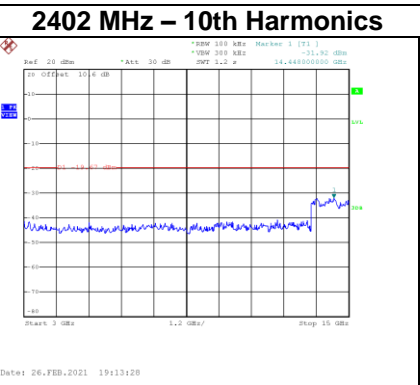
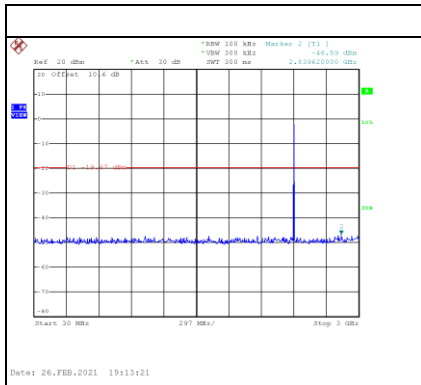
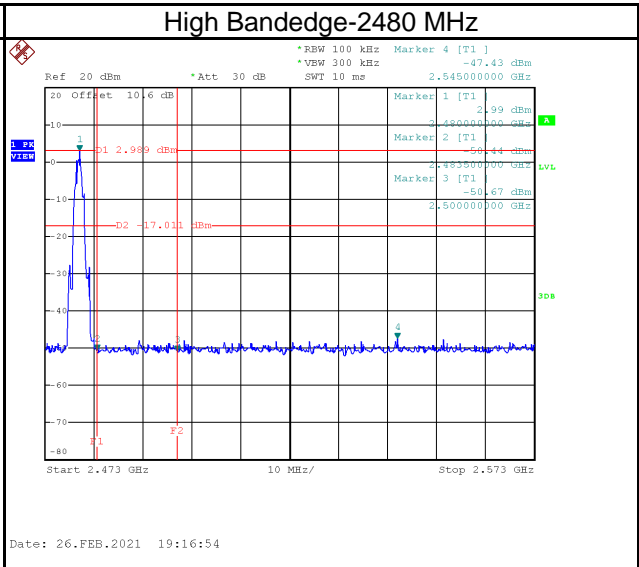
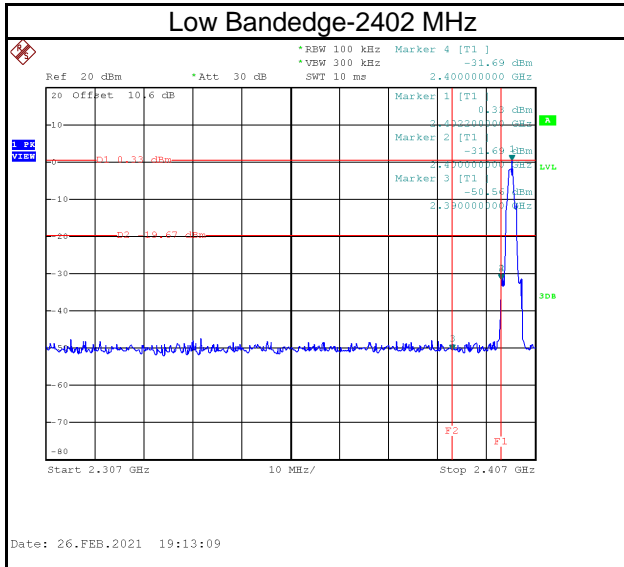

End of Test Report