

# MEASUREMENT REPORT

## FCC PART 15.247 & RSS-247 ZigBee

---

**FCC ID:** 2ATY4-C4220200  
**IC:** 25239-C4220200  
**APPLICANT:** SHANGHAI UNISPLENDOR LELIAN INTERNET OF THINGS TECHNOLOGY CO.,LTD.

**Application Type:** Certification  
**Product:** Smart metering socket  
**Model No.:** C4220200  
**FCC Classification:** Digital Transmission System (DTS)  
**FCC Rule Part(s):** Part 15 Subpart C (Section 15.247)  
**IC Rule(s):** RSS-247 Issue 2, RSS-GEN Issue 5  
**Test Procedure(s):** ANSI C63.10-2013, KDB 558074 D01v05r02  
**Test Date:** November 15 ~ 28, 2019

Reviewed By:   
( Kevin Guo )

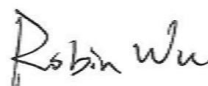
Approved By:   
( Robin Wu )



The test results relate only to the samples tested.

This equipment has been shown to be capable of compliance with the applicable technical standards as indicated in the measurement report and was tested in accordance with the measurement procedures specified in ANSI C63.10-2013. Test results reported herein relate only to the item(s) tested.

The test report shall not be reproduced except in full without the written approval of MRT Technology (Suzhou) Co., Ltd.

### Revision History

Report No.	Version	Description	Issue Date	Note
1911WSU008-U1	Rev. 01	Initial report	12-03-2019	Valid

---

## CONTENTS

Description	Page
<b>§2.1033 General Information .....</b>	<b>6</b>
<b>1. INTRODUCTION .....</b>	<b>7</b>
1.1. Scope .....	7
1.2. MRT Test Location .....	7
<b>2. PRODUCT INFORMATION .....</b>	<b>8</b>
2.1. Equipment Description.....	8
2.2. Operation Frequency / Channel List .....	8
2.3. Test Mode .....	8
2.4. Test Software .....	8
2.5. Device Capabilities .....	9
2.6. Test Configuration .....	10
2.7. EMI Suppression Device(s)/Modifications.....	10
2.8. Description of Test Software.....	10
2.9. Labeling Requirements.....	10
<b>3. DESCRIPTION OF TEST .....</b>	<b>11</b>
3.1. Evaluation Procedure .....	11
3.2. AC Line Conducted Emissions .....	11
3.3. Radiated Emissions.....	12
<b>4. ANTENNA REQUIREMENTS.....</b>	<b>13</b>
<b>5. TEST EQUIPMENT CALIBRATION DATE .....</b>	<b>14</b>
<b>6. MEASUREMENT UNCERTAINTY.....</b>	<b>16</b>
<b>7. TEST RESULT .....</b>	<b>17</b>
7.1. Summary .....	17
7.2. 99%Bandwidth Measurement.....	18
7.2.1. Test Limit .....	18
7.2.2. Test Procedure used.....	18
7.2.3. Test Setting.....	18
7.2.4. Test Setup.....	18
7.2.5. Test Result.....	19
7.3. 6dB Bandwidth Measurement.....	20
7.3.1. Test Limit .....	20
7.3.2. Test Procedure used.....	20

- 7.3.3. Test Setting ..... 20
- 7.3.4. Test Setup ..... 20
- 7.3.5. Test Result ..... 21
- 7.4. Output Power Measurement ..... 22
  - 7.4.1. Test Limit ..... 22
  - 7.4.2. Test Procedure Used ..... 22
  - 7.4.3. Test Setting ..... 22
  - 7.4.4. Test Setup ..... 22
  - 7.4.5. Test Result ..... 23
- 7.5. Power Spectral Density Measurement ..... 24
  - 7.5.1. Test Limit ..... 24
  - 7.5.2. Test Procedure Used ..... 24
  - 7.5.3. Test Setting ..... 24
  - 7.5.4. Test Setup ..... 24
  - 7.5.5. Test Result ..... 25
- 7.6. Conducted Band Edge and Out-of-Band Emissions ..... 26
  - 7.6.1. Test Limit ..... 26
  - 7.6.2. Test Procedure Used ..... 26
  - 7.6.3. Test Setting ..... 26
  - 7.6.4. Test Setup ..... 27
  - 7.6.5. Test Result ..... 28
- 7.7. Radiated Spurious Emission Measurement ..... 30
  - 7.7.1. Test Limit ..... 30
  - 7.7.2. Test Procedure Used ..... 30
  - 7.7.3. Test Setting ..... 31
  - 7.7.4. Test Setup ..... 32
  - 7.7.5. Test Result ..... 34
- 7.8. Radiated Restricted Band Edge Measurement ..... 39
  - 7.8.1. Test Limit ..... 39
  - 7.8.2. Test Procedure Used ..... 42
  - 7.8.3. Test Setting ..... 42
  - 7.8.4. Test Setup ..... 43
  - 7.8.5. Test Result ..... 44
- 7.1. AC Conducted Emissions Measurement ..... 52
  - 7.1.1. Test Limit ..... 52
  - 7.1.2. Test Setup ..... 52
  - 7.1.3. Test Result ..... 53

**8. CONCLUSION ..... 55**

**Appendix A - Test Setup Photograph ..... 56**  
**Appendix B - EUT Photograph..... 57**

## §2.1033 General Information

<b>Applicant:</b>	SHANGHAI UNISPLENDOR LELIAN INTERNET OF THINGS TECHNOLOGY CO.,LTD.
<b>Applicant Address:</b>	Building C, 888 huanhu west 2nd road, nanhui new town, pudong new area, Shanghai
<b>Manufacturer:</b>	HENAN ULTRAMODERN INTERNET OF THINGS TECHNOLOGIES COMPANY LIMITED
<b>Manufacturer Address:</b>	Building 3, no.67 dongqing street, high-tech industrial development zone, zhengzhou
<b>Test Site:</b>	MRT Technology (Suzhou) Co., Ltd
<b>Test Site Address:</b>	D8 Building, No.2 Tian'edang Rd., Wuzhong Economic Development Zone, Suzhou, China
<b>Test Device Serial No.:</b>	N/A <input type="checkbox"/> Production <input checked="" type="checkbox"/> Pre-Production <input type="checkbox"/> Engineering

### Test Facility / Accreditations

Measurements were performed at MRT Laboratory located in Tian'edang Rd., Suzhou, China.

- MRT facility is a FCC registered (MRT Reg. No. 893164) test facility with the site description report on file and has met all the requirements specified in ANSI C63.4-2014.
- MRT facility is an IC registered (MRT Reg. No. 11384A-1) test laboratory with the site description on file at Industry Canada.
- MRT facility is a VCCI registered (R-20025, G-20034, C-20020, T-20020) test laboratory with the site description on file at VCCI Council.
- MRT Lab is accredited to ISO 17025 by the American Association for Laboratory Accreditation (A2LA) under the American Association for Laboratory Accreditation Program (A2LA Cert. No. 3628.01) in EMC, Telecommunications, Radio and SAR testing.



# 1. INTRODUCTION

## 1.1. Scope

Measurement and determination of electromagnetic emissions (EMC) of radio frequency devices including intentional and/or unintentional radiators for compliance with the technical rules and regulations of the Federal Communications Commission and the Innovation, Science and Economic Development Canada and Certification and Engineering Bureau.

## 1.2. MRT Test Location

The map below shows the location of the MRT LABORATORY, its proximity to the Taihu Lake. These measurement tests were conducted at the MRT Technology (Suzhou) Co., Ltd. Facility located at D8 Building, No.2 Tian'edang Rd., Wuzhong Economic Development Zone, Suzhou, China. The measurement facility compliant with the test site requirements specified in ANSI C63.4-2014.



## 2. PRODUCT INFORMATION

### 2.1. Equipment Description

Product Name:	Smart metering socket
Model No.:	C4220200
Frequency Range:	802.15.4: 2405 ~ 2475 MHz
Type of Modulation:	O-QPSK
Data Rate:	250kbps
Type of Antenna:	PIFA Antenna
Antenna Gain:	2dBi

### 2.2. Operation Frequency / Channel List

Channel	Frequency	Channel	Frequency	Channel	Frequency
11	2405 MHz	12	2410 MHz	13	2415 MHz
14	2420 MHz	15	2425 MHz	16	2430 MHz
17	2435 MHz	18	2440 MHz	19	2445 MHz
20	2450 MHz	21	2455 MHz	22	2460 MHz
23	2465 MHz	24	2470 MHz	25	2475 MHz

### 2.3. Test Mode

Test Mode	Mode 1: Transmit by 802.15.4
-----------	------------------------------

### 2.4. Test Software

The test utility software used during testing was engineering directive ordered by applicant.



## 2.5. Device Capabilities

This device contains the following capabilities:

ZigBee

**Note:** ZigBee operation is possible in 5MHz channel bandwidth. The maximum achievable duty cycle was determined based on measurements performed on a spectrum analyzer in zero-span mode with RBW = 8MHz, VBW = 50MHz. The RBW and VBW were both greater than 50/T, where T is the minimum transmission duration, and the number of sweep points across T was greater than 100. The duty cycles are as follows:

Test Mode	Duty Cycle
802.15.4	100 %

## 2.6. Test Configuration

The device was tested per the guidance of ANSI C63.10-2013. ANSI C63.10-2013 was used to reference the appropriate EUT setup for radiated spurious emissions testing and AC line conducted testing.

## 2.7. EMI Suppression Device(s)/Modifications

No EMI suppression device(s) were added and/or no modifications were made during testing.

## 2.8. Description of Test Software

The test utility software used during testing was “teraterm”.

## 2.9. Labeling Requirements

Per 2.1074 & 15.19; Docket 95-19

The label shall be permanently affixed at a conspicuous location on the device; instruction manual or pamphlet supplied to the user and be readily visible to the purchaser at the time of purchase.

However, when the device is so small wherein placement of the label with specified statement is not practical, only the FCC ID must be displayed on the device per Section 15.19(a)(5). Please see attachment for FCC ID label and label location.

RSP-100 Issue 12

The manufacturer, importer or distributor shall meet the labeling requirements set out in this section for every unit:

- (i) prior to marketing in Canada, for products manufactured in Canada
- (ii) prior to importation into Canada, for imported products

For information regarding the e-labeling option, see Notice 2014-DRS1003. The label for the certified product represents the manufacturer’s or importer’s compliance with Innovation, Science and Economic Development Canada’s (ISED) regulatory requirements.

Please see attachment for IC label and label location.

### 3. DESCRIPTION OF TEST

#### 3.1. Evaluation Procedure

The measurement procedures described in the American National Standard for Testing Unlicensed Wireless Devices (ANSI C63.10-2013), and were used in the measurement of the device.

**Deviation from measurement procedure.....None**

#### 3.2. AC Line Conducted Emissions

The line-conducted facility is located inside an 8'x4'x4' shielded enclosure. A 1m x 2m wooden table 80cm high is placed 40cm away from the vertical wall and 80cm away from the sidewall of the shielded room. Two 10kHz-30MHz, 50Ω/50uH Line-Impedance Stabilization Networks (LISNs) are bonded to the shielded room floor. Power to the LISNs is filtered by external high-current high-insertion loss power line filters. These filters attenuate ambient signal noise from entering the measurement lines. These filters are also bonded to the shielded enclosure.

The EUT is powered from one LISN and the support equipment is powered from the second LISN. All interconnecting cables more than 1 meter were shortened to a 1 meter length by non-inductive bundling (serpentine fashion) and draped over the back edge of the test table. All cables were at least 40cm above the horizontal reference ground-plane. Power cables for support equipment were routed down to the second LISN while ensuring that that cables were not draped over the second LISN.

Sufficient time for the EUT, support equipment, and test equipment was allowed in order for them to warm up to their normal operating condition. The RF output of the LISN was connected to the receiver and exploratory measurements were made to determine the frequencies producing the maximum emission from the EUT. The receiver was scanned from 150kHz to 30MHz. The detector function was set to peak mode for exploratory measurements while the bandwidth of the analyzer was set to 9kHz. The EUT, support equipment, and interconnecting cables were arranged and manipulated to maximize each emission. Each emission was also maximized by varying: power lines, the mode of operation or data exchange speed, or support equipment whichever determined the worst-case emission. Once the worst case emissions have been identified, the one EUT cable configuration/arrangement and mode of operation that produced these emissions are used for final measurements on the same test site. The analyzer is set to CISPR quasi-peak and average detectors with a 9kHz resolution bandwidth for final measurements.

An extension cord was used to connect to a single LISN which powered by EUT. The extension cord was calibrated with LISN, the impedance and insertion loss are compliance with the requirements as stated in ANSI C63.10-2013.

### 3.3. Radiated Emissions

The radiated test facilities consisted of an indoor 3 meter semi-anechoic chamber used for final measurements and exploratory measurements, when necessary. The measurement area is contained within the semi-anechoic chamber which is shielded from any ambient interference. For measurements above 1GHz absorbers are arranged on the floor between the turn table and the antenna mast in such a way so as to maximize the reduction of reflections. For measurements below 1GHz, the absorbers are removed. A MF Model 210SS turntable is used for radiated measurement. It is a continuously rotatable, remote controlled, metallic turntable and 2 meters (6.56 ft.) in diameter. The turn table is flush with the raised floor of the chamber in order to maintain its function as a ground plane. An 80cm high PVC support structure is placed on top of the turntable.

For all measurements, the spectrum was scanned through all EUT azimuths and from 1 to 4 meter receive antenna height using a broadband antenna from 30MHz up to the upper frequency shown in 15.33(b)(1) depending on the highest frequency generated or used in the device or on which the device operates or tunes. For frequencies above 1GHz, linearly polarized double ridge horn antennas were used. For frequencies below 30MHz, a calibrated loop antenna was used. When exploratory measurements were necessary, they were performed at 1 meter test distance inside the semi-anechoic chamber using broadband antennas, broadband amplifiers, and spectrum analyzers to determine the frequencies and modes producing the maximum emissions. Sufficient time for the EUT, support equipment, and test equipment was allowed in order for them to warm up to their normal operating condition. The test set-up for frequencies below 1GHz was placed on top of the 0.8 meter high, 1 x 1.5 meter table; and test set-up for frequencies 1-25GHz was placed on top of the 1.5 meter high, 1 x 1.5 meter table. The EUT, support equipment, and interconnecting cables were arranged and manipulated to maximize each emission. Appropriate precaution was taken to ensure that all emissions from the EUT were maximized and investigated. The system configuration, clock speed, mode of operation or video resolution, if applicable, turntable azimuth, and receive antenna height was noted for each frequency found.

Final measurements were made in the semi-anechoic chamber using calibrated, linearly polarized broadband and horn antennas. The test setup was configured to the setup that produced the worst case emissions. The spectrum analyzer was set to investigate all frequencies required for testing to compare the highest radiated disturbances with respect to the specified limits. The turntable containing the EUT was rotated through 360 degrees and the height of the receive antenna was varied 1 to 4 meters and stopped at the azimuth and height producing the maximum emission. Each emission was maximized by changing the orientation of the EUT through three orthogonal planes and changing the polarity of the receive antenna, whichever produced the worst-case emissions. According to 3dB Beam-Width of horn antenna, the horn antenna should be always directed to the EUT when rising height.

## 4. ANTENNA REQUIREMENTS

### Excerpt from §15.203 of the FCC Rules/Regulations:

“An intentional radiator antenna shall be designed to ensure that no antenna other than that furnished by the responsible party can be used with the device. The use of a permanently attached antenna or of an antenna that uses a unique coupling to the intentional radiator shall be considered sufficient to comply with the provisions of this section.”

- The antenna of the device is **permanently attached**.
- There are no provisions for connection to an external antenna.

### **Conclusion:**

The device unit complies with the requirement of §15.203.

## 5. TEST EQUIPMENT CALIBRATION DATE

### Conducted Emissions - SR2

Instrument	Manufacturer	Type No.	Asset No.	Cali. Interval	Cali. Due Date
EMI Test Receiver	R&S	ESR3	MRTSUE06185	1 year	2020/04/15
Two-Line V-Network	R&S	ENV 216	MRTSUE06002	1 year	2020/06/13
Two-Line V-Network	R&S	ENV 216	MRTSUE06003	1 year	2020/06/13
Thermohygrometer	Testo	608-H1	MRTSUE06404	1 year	2020/08/08
Shielding Room	MIX-BEP	Chamber-SR2	MRTSUE06215	N/A	N/A

### Radiated Emissions - AC1

Instrument	Manufacturer	Type No.	Asset No.	Cali. Interval	Cali. Due Date
EMI Test Receiver	R&S	ESR7	MRTSUE06001	1 year	2020/08/01
PXA Signal Analyzer	Keysight	9030B	MRTSUE06395	1 year	2020/09/03
Loop Antenna	Schwarzbeck	FMZB 1519	MRTSUE06025	1 year	2020/11/10
Bilog Period Antenna	Schwarzbeck	VULB 9168	MRTSUE06172	1 year	2020/03/31
Broad Band Horn Antenna	Schwarzbeck	BBHA 9120D	MRTSUE06023	1 year	2020/10/13
Broad Band Horn Antenna	Schwarzbeck	BBHA 9170	MRTSUE06024	1 year	2019/12/17
Microwave System Amplifier	Agilent	83017A	MRTSUE06076	1 year	2020/11/15
Preamplifier	Schwarzbeck	BBV 9721	MRTSUE06121	1 year	2020/06/11
Thermohygrometer	Testo	608-H1	MRTSUE06403	1 year	2020/08/08
Anechoic Chamber	TDK	Chamber-AC1	MRTSUE06212	1 year	2020/04/30

### Radiated Emission - AC2

Instrument	Manufacturer	Type No.	Asset No.	Cali. Interval	Cali. Due Date
Spectrum Analyzer	Keysight	N9038A	MRTSUE06125	1 year	2020/08/01
Loop Antenna	Schwarzbeck	FMZB 1519	MRTSUE06025	1 year	2020/11/10
Bilog Period Antenna	Schwarzbeck	VULB 9162	MRTSUE06022	1 year	2020/10/13
Horn Antenna	Schwarzbeck	BBHA9120D	MRTSUE06171	1 year	2020/10/27
Broad Band Horn Antenna	Schwarzbeck	BBHA 9170	MRTSUE06024	1 year	2019/12/17
Broadband Coaxial Preamplifier	Schwarzbeck	BBV 9718	MRTSUE06176	1 year	2020/11/15
Preamplifier	Schwarzbeck	BBV 9721	MRTSUE06121	1 year	2020/06/11
Temperature/Humidity Meter	Minggao	ETH529	MRTSUE06170	1 year	2019/12/13
Anechoic Chamber	RIKEN	Chamber-AC2	MRTSUE06213	1 year	2020/04/30

## Conducted Test Equipment - TR3

Instrument	Manufacturer	Type No.	Asset No.	Cali. Interval	Cali. Due Date
EXA Signal Analyzer	Agilent	N9020A	MRTSUE06106	1 year	2020/04/15
EXA Signal Analyzer	Keysight	N9010B	MRTSUE06452	1 year	2020/07/11
Signal Analyzer	R&S	FSV40	MRTSUE06218	1 year	2020/04/15
Power Meter	Agilent	U2021XA	MRTSUE06030	1 year	2020/11/18
USB wideband power sensor	Keysight	U2021XA	MRTSUE06446	1 year	2020/06/30
USB wideband power sensor	Keysight	U2021XA	MRTSUE06447	1 year	2020/06/30
Bluetooth Test Set	Anritsu	MT8852B-042	MRTSUE06389	1 year	2020/06/13
Audio Analyzer	Agilent	U8903B	MRTSUE06143	1 year	2020/06/13
Modulation Analyzer	HP	8901A	MRTSUE06098	1 year	2020/10/10
Wideband Radio Communication Tester	R&S	CMW 500	MRTSUE06243	1 year	2020/11/07
DC Power Supply	GWINSTEK	DPS-3303C	MRTSUE06064	N/A	N/A
Temperature & Humidity Chamber	BAOYT	BYH-150CL	MRTSUE06051	1 year	2020/11/07
Thermohygrometer	testo	608-H1	MRTSUE06401	1 year	2020/08/08

Software	Version	Function
EMI Software	V3	EMI Test Software

## 6. MEASUREMENT UNCERTAINTY

Where relevant, the following test uncertainty levels have been estimated for tests performed on the EUT as specified in CISPR 16-4-2. This uncertainty represents an expanded uncertainty expressed at approximately the 95% confidence level using a coverage factor of  $k = 2$ .

Conducted Emission Measurement - SR2	
The maximum measurement uncertainty is evaluated as:	
9kHz~150kHz: 3.84dB	
150kHz~30MHz: 3.46dB	
Radiated Emission Measurement - AC1	
The maximum measurement uncertainty is evaluated as:	
Horizontal:	30MHz~300MHz: 4.07dB
	300MHz~1GHz: 3.63dB
	1GHz~18GHz: 4.16dB
Vertical:	30MHz~300MHz: 4.18dB
	300MHz~1GHz: 3.60dB
	1GHz~18GHz: 4.76dB
Radiated Emission Measurement - AC2	
The maximum measurement uncertainty is evaluated as:	
Horizontal:	30MHz~300MHz: 3.75dB
	300MHz~1GHz: 3.53dB
	1GHz~18GHz: 4.28dB
Vertical:	30MHz~300MHz: 3.86dB
	300MHz~1GHz: 3.53dB
	1GHz~18GHz: 4.33dB



## 7. TEST RESULT

### 7.1. Summary

FCC Part Section(s)	IC Section(s)	Test Description	Test Limit	Test Condition	Test Result	Reference
N/A	RSS-GEN [6.7]	99% Bandwidth	N/A	Conducted	Pass	Section7.2
15.247(a)(2)	RSS-247 [5.2]	6dB Bandwidth	$\geq 500\text{kHz}$		Pass	Section7.3
15.247(b)(3)	RSS-247 [5.4(d)]	Output Power	$\leq 1\text{Watt}$ & $\text{EIRP} \leq 4\text{Watt}$		Pass	Section 7.4
15.247(e)	RSS-247 [5.2]	Power Spectral Density	$\leq 8\text{dBm} / 3\text{kHz}$		Pass	Section 7.5
15.247(d)	RSS-247 [5.5]	Band Edge / Out-of-Band Emissions	$\geq 20\text{dBc(Peak)}$		Pass	Section 7.6
15.205 15.209	RSS-247 [5.5]	General Field Strength Limits(Restricted Bands and Radiated Emission Limits)	Emissions in restricted bands must meet the radiated limits detailed in15.209	Radiated	Pass	Section 7.7 Section7.8
15.207	RSS-Gen [8.8]	AC Conducted Emissions 150kHz - 30MHz	< FCC 15.207 limits>	Line Conducted	Pass	Section 7.9

#### Notes:

- 1) For radiated emission test, every axis (X, Y, Z) was also verified. The test results shown in the following sections represent the worst case emissions.
- 2) The analyzer plots shown in this section were all taken with a correction table loaded into the analyzer. The correction table was used to account for the losses of the cables and attenuators used as part of the system to connect the EUT to the analyzer at all frequencies of interest.

## 7.2. 99%Bandwidth Measurement

### 7.2.1.Test Limit

N/A

### 7.2.2.Test Procedure used

ANSI C63.10-2013 Section 6.9.3

### 7.2.3.Test Setting

1. Set center frequency to the nominal EUT channel center frequency.
2. Span = 1.5 times to 5.0 times the OBW.
3. RBW = 1 % to 5 % of the OBW.
4. VBW  $\geq 3 \times$  RBW.
5. Detector = Peak.
6. Trace mode = max hold.
7. Use the 99 % power bandwidth function of the instrument.

### 7.2.4.Test Setup

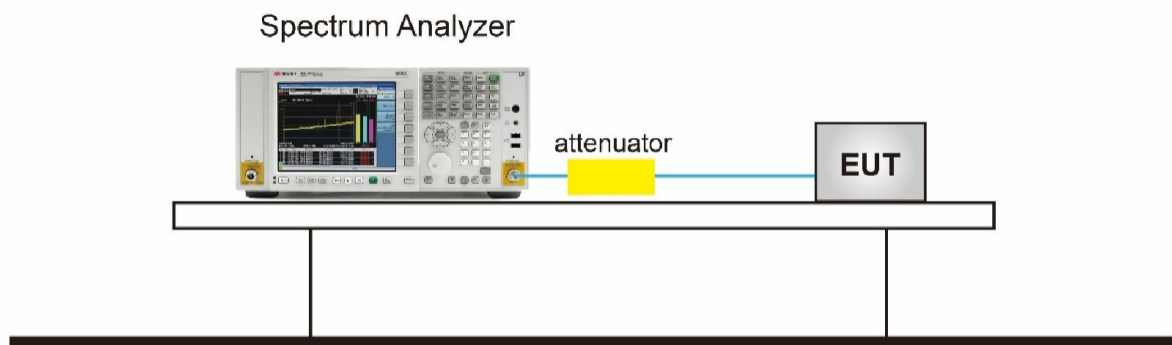

### 7.2.5. Test Result

Product	Smart metering socket	Temperature	25°C
Test Engineer	Yuri Li	Relative Humidity	52%
Test Site	TR3	Test Date	2019/11/28

Test Mode	Channel No.	Frequency (MHz)	99% Bandwidth (MHz)	Result
802.15.4	11	2405	2.27	Pass
802.15.4	18	2440	2.31	Pass
802.15.4	25	2475	2.32	Pass

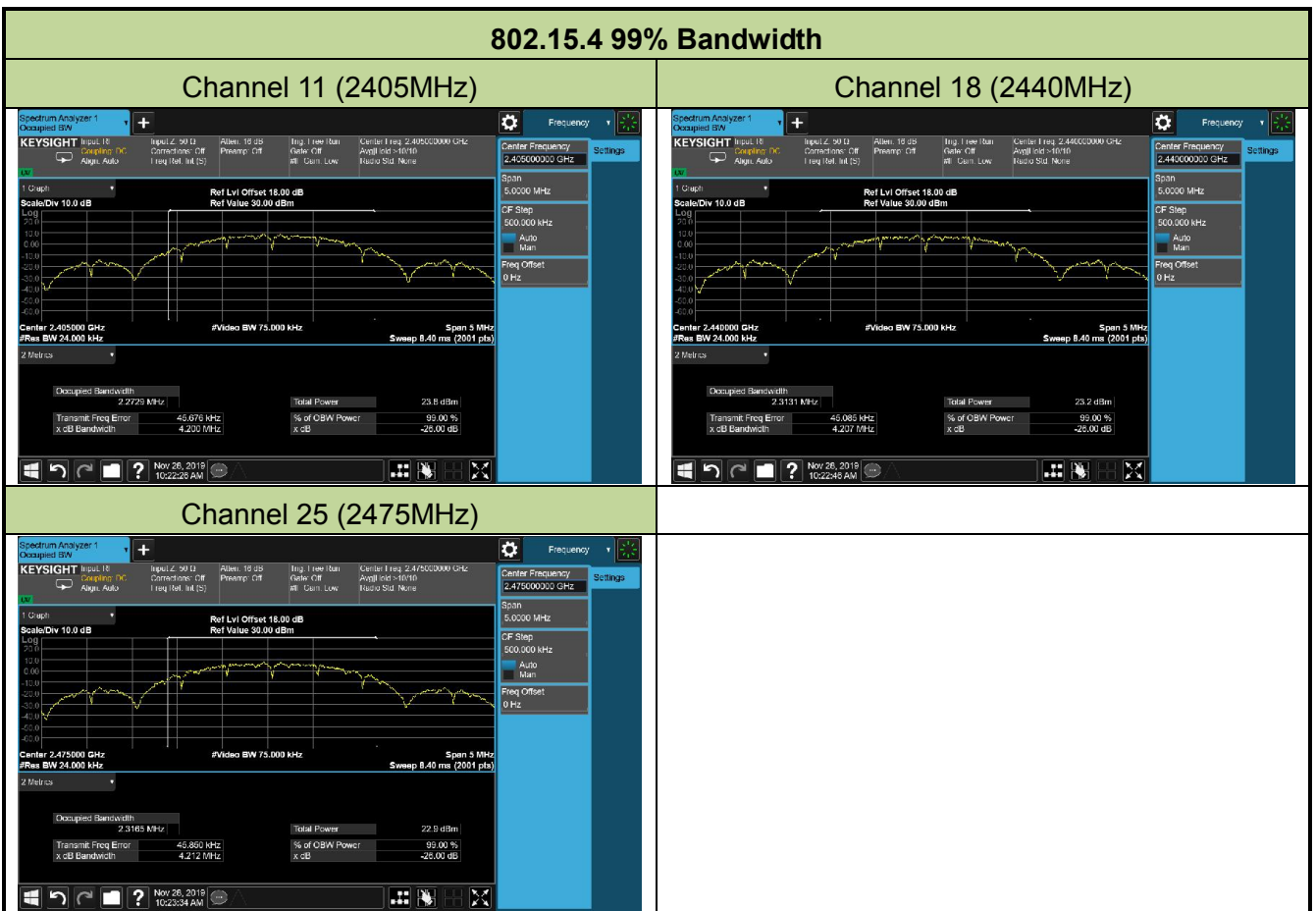

### 7.3. 6dB Bandwidth Measurement

#### 7.3.1. Test Limit

The minimum 6dB bandwidth shall be at least 500 kHz.

#### 7.3.2. Test Procedure used

ANSI C63.10-2013 - Section 11.8.2 Option 2

#### 7.3.3. Test Setting

1. The Spectrum's automatic bandwidth measurement capability was used to perform the 6dB bandwidth measurement. The "X" dB bandwidth parameter was set to  $X = 6$ . The bandwidth measurement was not influenced by any intermediate power nulls in the fundamental emission.
2. Set RBW = 100 kHz
3. VBW  $\geq 3 \times$  RBW
4. Detector = Peak
5. Trace mode = max hold
6. Sweep = auto couple
7. Allow the trace was allowed to stabilize

#### 7.3.4. Test Setup

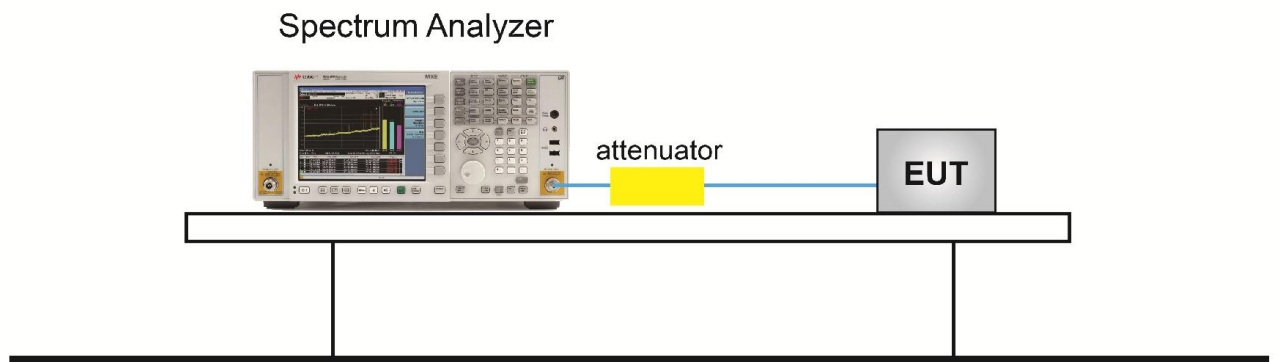

### 7.3.5. Test Result

Product	Smart metering socket	Temperature	25°C
Test Engineer	Yuri Li	Relative Humidity	52%
Test Site	TR3	Test Date	2019/11/28

Test Mode	Channel No.	Frequency (MHz)	6dB Bandwidth (MHz)	Limit (MHz)	Result
802.15.4	11	2405	1.56	≥ 0.5	Pass
802.15.4	18	2440	1.59	≥ 0.5	Pass
802.15.4	25	2475	1.59	≥ 0.5	Pass

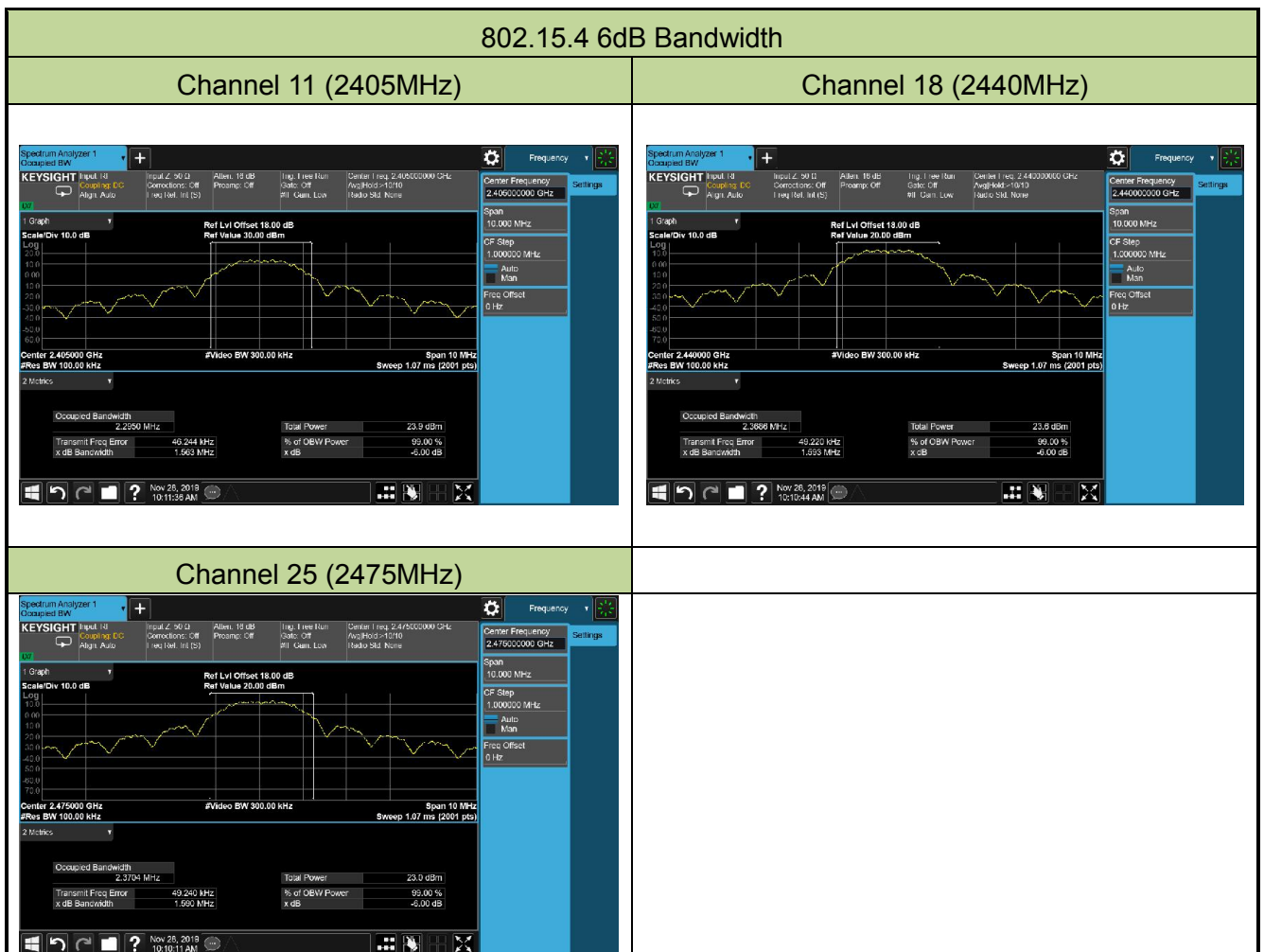

## 7.4. Output Power Measurement

### 7.4.1. Test Limit

The maximum output power shall be less 1 Watt (30dBm).

### 7.4.2. Test Procedure Used

ANSI C63.10-2013 - Section 11.9.1.3 PKPM1 Peak-reading power meter method

ANSI C63.10-2013 - Section 11.9.2.3.2 Method AVGPM-G

### 7.4.3. Test Setting

#### **Method PKPM1 (Peak Power Measurement)**

Peak power measurements were performed only when the EUT was transmitting at its maximum power control level using a broadband power meter with a pulse sensor. The pulse sensor employs a VBW = 50MHz so this method was only used for signals whose DTS bandwidth was less than or equal to 50MHz.

#### **Method AVGPM-G (Measurement using a gated RF average-reading power meter)**

Measurements may be performed using a wideband gated RF power meter provided that the gate parameters are adjusted such that the power is measured only when the EUT is transmitting at its maximum power control level. Since this measurement is made only during the ON time of the transmitter, no duty cycle correction is required.

### 7.4.4. Test Setup

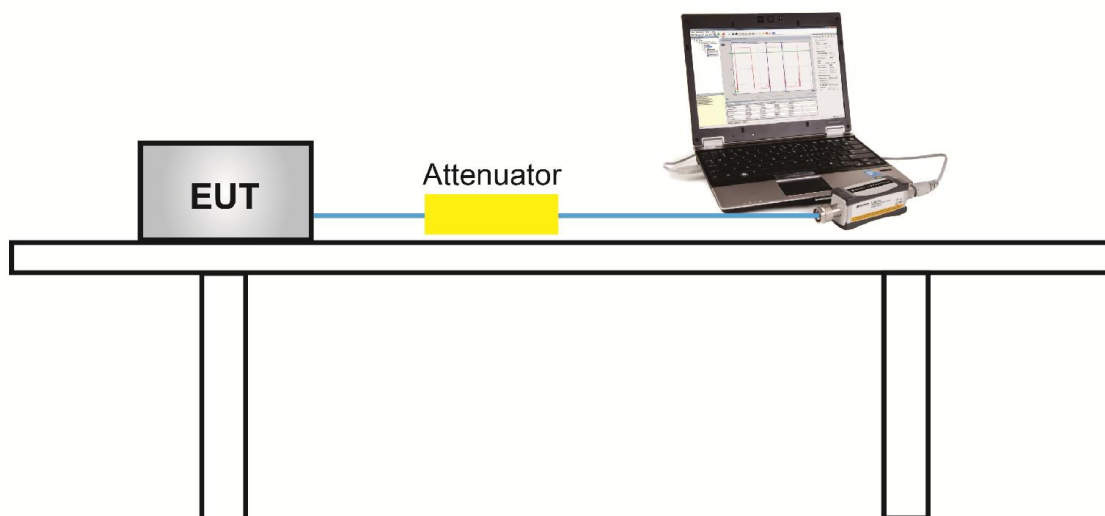

#### 7.4.5. Test Result

Product	Smart metering socket	Temperature	25°C
Test Engineer	Yuri Li	Relative Humidity	52%
Test Site	TR3	Test Date	2019/11/15

#### Test Result of Peak Output Power

Test Mode	Channel No.	Frequency (MHz)	Peak Power (dBm)	Limit (dBm)	E.I.R.P (dBm)	E.I.R.P Limit (dBm)	Result
802.15.4	11	2405	15.43	≤ 30	17.43	≤ 36.00	Pass
802.15.4	18	2440	14.87	≤ 30	16.87	≤ 36.00	Pass
802.15.4	25	2475	14.52	≤ 30	16.52	≤ 36.00	Pass

Note: EIRP (dBm) = Peak Power (dBm) + Antenna Gain (dBi), Antenna Gain = 2dBi.

#### Test Result of Average Output Power (Reporting Only)

Test Mode	Channel No.	Frequency (MHz)	Average Power (dBm)	Limit (dBm)	E.I.R.P (dBm)	E.I.R.P Limit (dBm)	Result
802.15.4	11	2405	15.36	≤ 30	17.36	≤ 36.00	Pass
802.15.4	18	2440	14.63	≤ 30	16.63	≤ 36.00	Pass
802.15.4	25	2475	14.17	≤ 30	16.17	≤ 36.00	Pass

Note: EIRP (dBm) = Average Power (dBm) + Antenna Gain (dBi), Antenna Gain = 2dBi.

## 7.5. Power Spectral Density Measurement

### 7.5.1. Test Limit

The maximum permissible power spectral density is 8dBm in any 3 kHz band.

### 7.5.2. Test Procedure Used

ANSI C63.10-2013 - Section 11.10.2.

### 7.5.3. Test Setting

1. Analyzer was set to the center frequency of the DTS channel under investigation
2. Span = 1.5 times the DTS channel bandwidth
3. RBW = 3kHz
4. VBW = 10kHz
5. Detector = peak
6. Sweep time = auto couple
7. Trace mode = max hold
8. Trace was allowed to stabilize

### 7.5.4. Test Setup

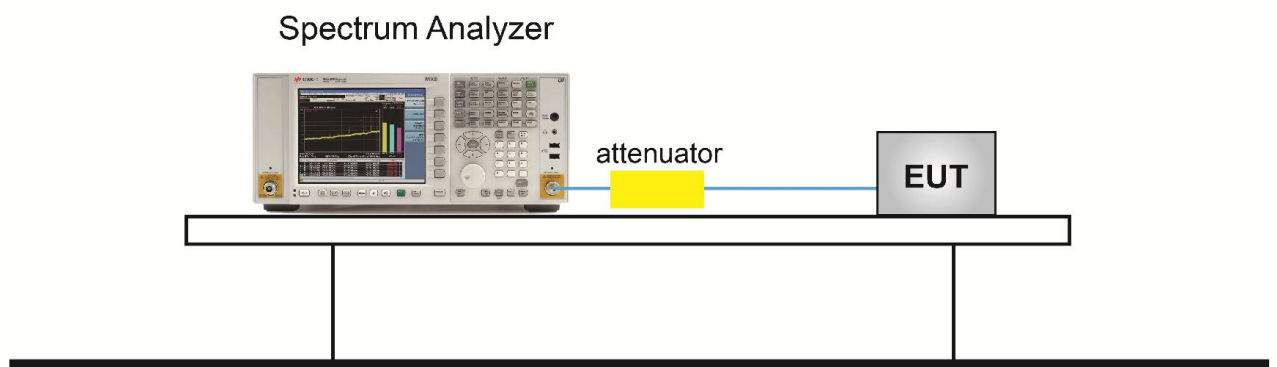



**7.5.5. Test Result**

Product	Smart metering socket	Temperature	25°C
Test Engineer	Yuri Li	Relative Humidity	52%
Test Site	TR3	Test Date	2019/11/15

Test Mode	Channel No.	Frequency (MHz)	Measured PSD (dBm / 3kHz)	Limit (dBm / 3kHz)	Result
802.15.4	11	2405	4.10	≤ 8	Pass
802.15.4	18	2440	7.45	≤ 8	Pass
802.15.4	25	2475	6.95	≤ 8	Pass

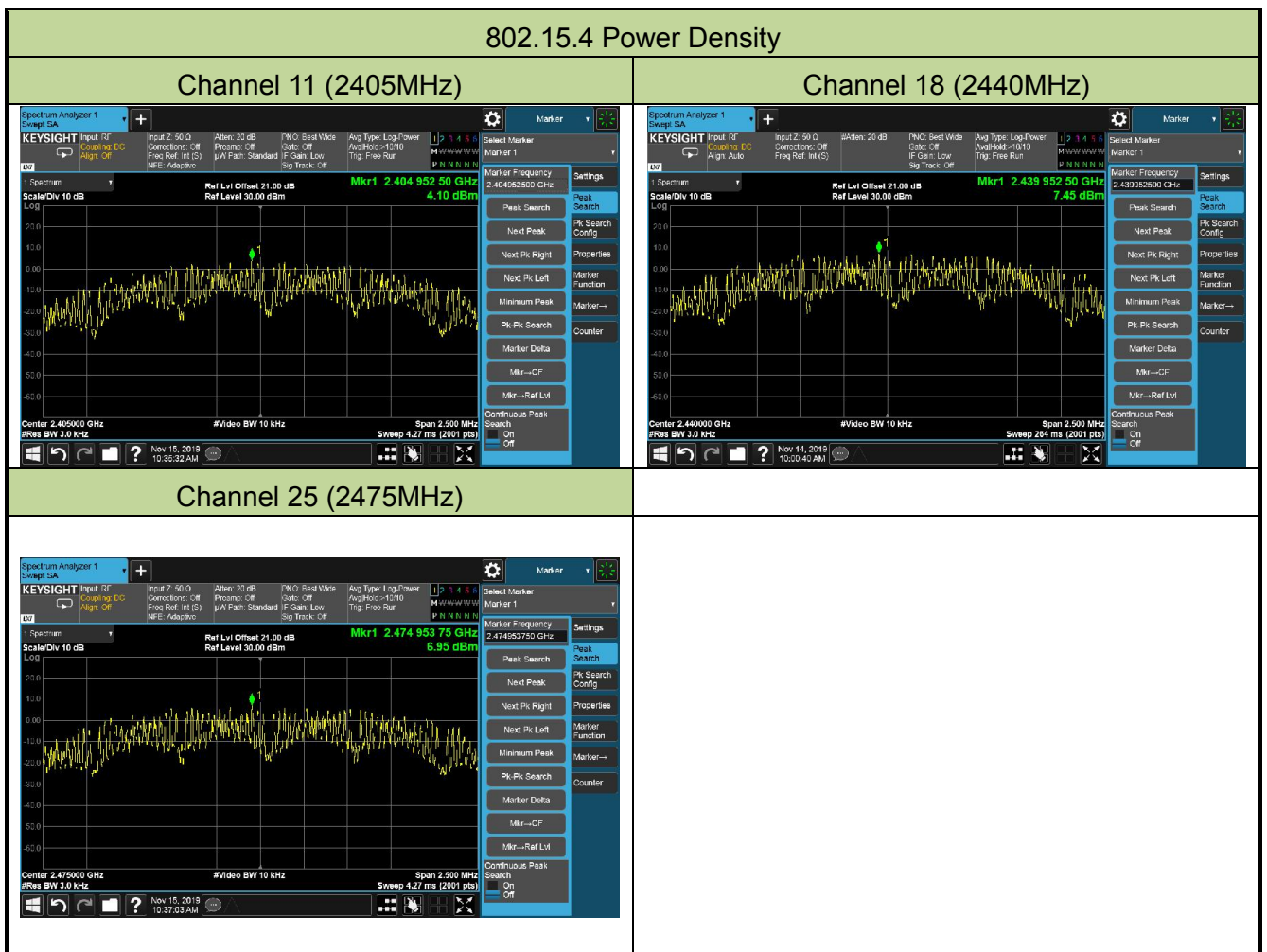

## **7.6. Conducted Band Edge and Out-of-Band Emissions**

### **7.6.1. Test Limit**

The limit for out-of-band spurious emissions at the band edge is 20dB below the fundamental emission level, as determined from the in-band power measurement of the DTS channel performed in a 100 kHz bandwidth per the PSD procedure.

### **7.6.2. Test Procedure Used**

ANSI C63.10-2013 - Section 11.11.2 & 11.11.3.

### **7.6.3. Test Setting**

#### **Reference level measurement**

1. Set instrument center frequency to DTS channel center frequency
2. Set the span to  $\geq 1.5$  times the DTS bandwidth
3. Set the RBW = 100 kHz
4. Set the VBW  $\geq 3 \times$  RBW
5. Detector = peak
6. Sweep time = auto couple
7. Trace mode = max hold
8. Allow trace to fully stabilize

#### **Emission level measurement**

1. Set the center frequency and span to encompass frequency range to be measured
2. RBW = 1.3MHz
3. VBW = 4MHz
4. Detector = Peak
5. Trace mode = max hold
6. Sweep time = auto couple
7. The trace was allowed to stabilize

### Test Notes

1. RBW was set to 1.3MHz rather than 100 kHz in order to increase the measurement speed.
2. The display line shown in the following plots denotes the limit at 20dB below the fundamental emission level measured in a 100 kHz bandwidth. However, since the traces in the following plots are measured with a 1.3MHz RBW, the display line may not necessarily appear to be 30dB below the level of the fundamental in a 1.3MHz bandwidth.
3. For plots showing conducted spurious emissions near the limit, the frequencies were investigated with a reduced RBW to ensure that no emissions were present.

### 7.6.4. Test Setup

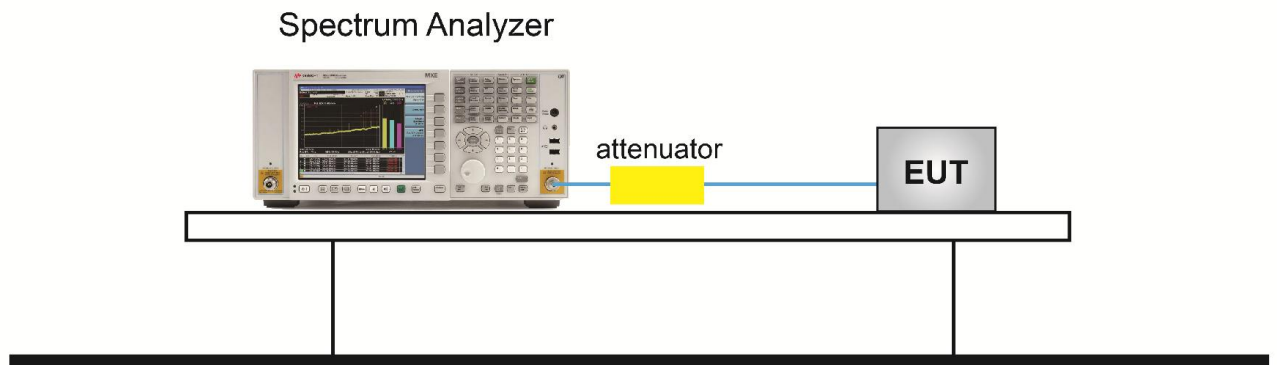

### 7.6.5. Test Result

Product	Smart metering socket	Temperature	25°C
Test Engineer	Yuri Li	Relative Humidity	55%
Test Site	TR3	Test Date	2019/11/28

Test Mode	Channel No.	Frequency (MHz)	Limit	Result
802.15.4	11	2405	20dBc	Pass
802.15.4	18	2440	20dBc	Pass
802.15.4	25	2475	20dBc	Pass

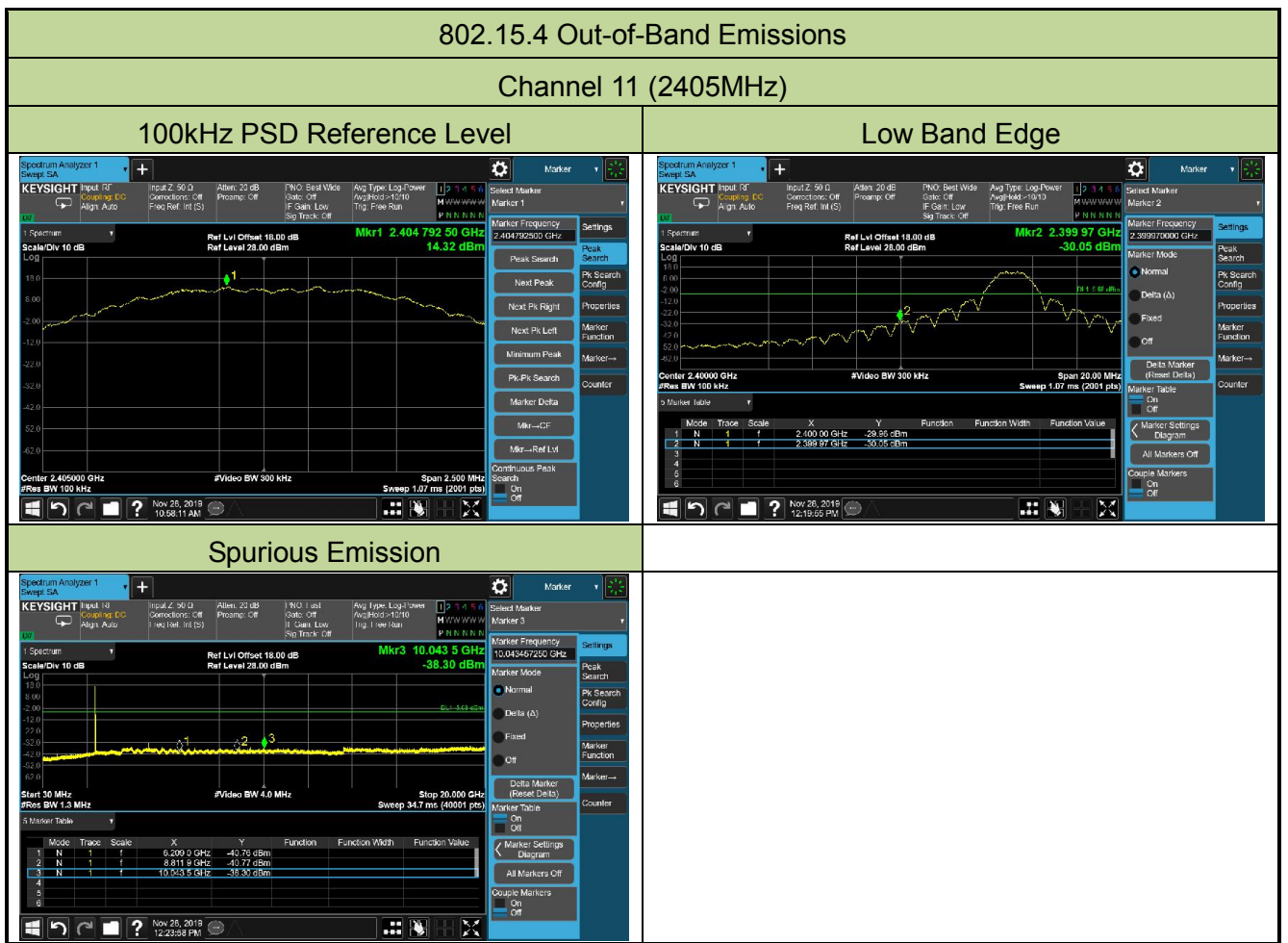

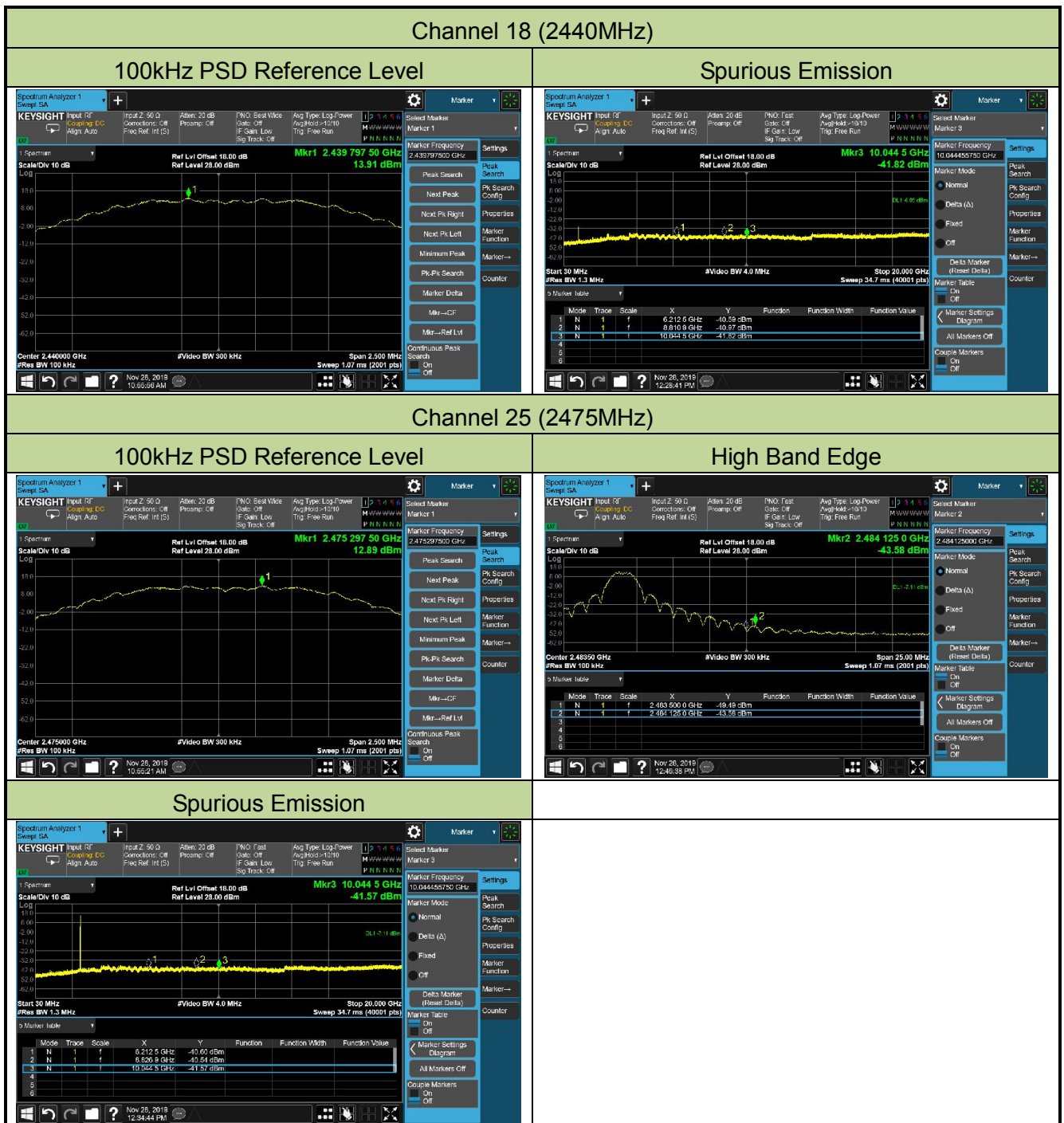

## 7.7. Radiated Spurious Emission Measurement

### 7.7.1. Test Limit

All out of band emissions appearing in a restricted band as specified in Section 15.205 of the Title 47 CFR must not exceed the limits shown in Table per Section 15.209.

FCC Part 15 Subpart C Paragraph 15.209		
Frequency (MHz)	Field Strength ( $\mu\text{V/m}$ )	Measured Distance (m)
0.009 - 0.490	2400/F (kHz)	300
0.490 - 1.705	24000/F (kHz)	30
1.705 - 30	30	30
30 - 88	100	3
88 - 216	150	3
216 - 960	200	3
Above 960	500	3

All out of band emissions appearing in a restricted band as specified in Section 8.10 of the RSS-Gen must not exceed the limits shown in Table per Section 8.9.

RSS-Gen Section 8.9		
Frequency [MHz]	Field Strength [ $\mu\text{V/m}$ ]	Measured Distance [Meters]
0.009 - 0.490	2400/F (kHz)	300
0.490 - 1.705	24000/F (kHz)	30
1.705 - 30	30	30
30 - 88	100	3
88 - 216	150	3
216 - 960	200	3
Above 960	500	3

### 7.7.2. Test Procedure Used

ANSI C63.10 Section 6.3 (General Requirements)

ANSI C63.10 Section 6.4 (Standard test method below 30MHz)

ANSI C63.10 Section 6.5 (Standard test method above 30MHz to 1GHz)

ANSI C63.10 Section 6.6 (Standard test method above 1GHz)

### 7.7.3. Test Setting

**Table 1 - RBW as a function of frequency**

Frequency	RBW
9 ~ 150 kHz	200 ~ 300 Hz
0.15 ~ 30 MHz	9 ~ 10 kHz
30 ~ 1000 MHz	100 ~ 120 kHz
> 1000 MHz	1 MHz

#### **Quasi-Peak Measurements below 1GHz**

1. Analyzer center frequency was set to the frequency of the radiated spurious emission of interest
2. Span was set greater than 1MHz
3. RBW = as specified in Table 1
4. Detector = CISPR quasi-peak
5. Sweep time = auto couple
6. Trace was allowed to stabilize

#### **Peak Measurements above 1GHz**

1. Analyzer center frequency was set to the frequency of the radiated spurious emission of interest
2. RBW = 1MHz
3. VBW = 3MHz
4. Detector = peak
5. Sweep time = auto couple
6. Trace mode = max hold
7. Trace was allowed to stabilize

### Average Measurements above 1GHz (Method VB)

1. Analyzer center frequency was set to the frequency of the radiated spurious emission of interest
2. RBW = 1MHz
3. VBW; If the EUT is configured to transmit with duty cycle  $\geq 98\%$ , set VBW = 10 Hz.
4. If the EUT duty cycle is  $< 98\%$ , set VBW  $\geq 1/T$ . T is the minimum transmission duration.
5. Detector = Peak
6. Sweep time = auto
7. Trace mode = max hold
8. Trace was allowed to stabilize

#### **7.7.4.Test Setup**

Below 1GHz Test Setup:

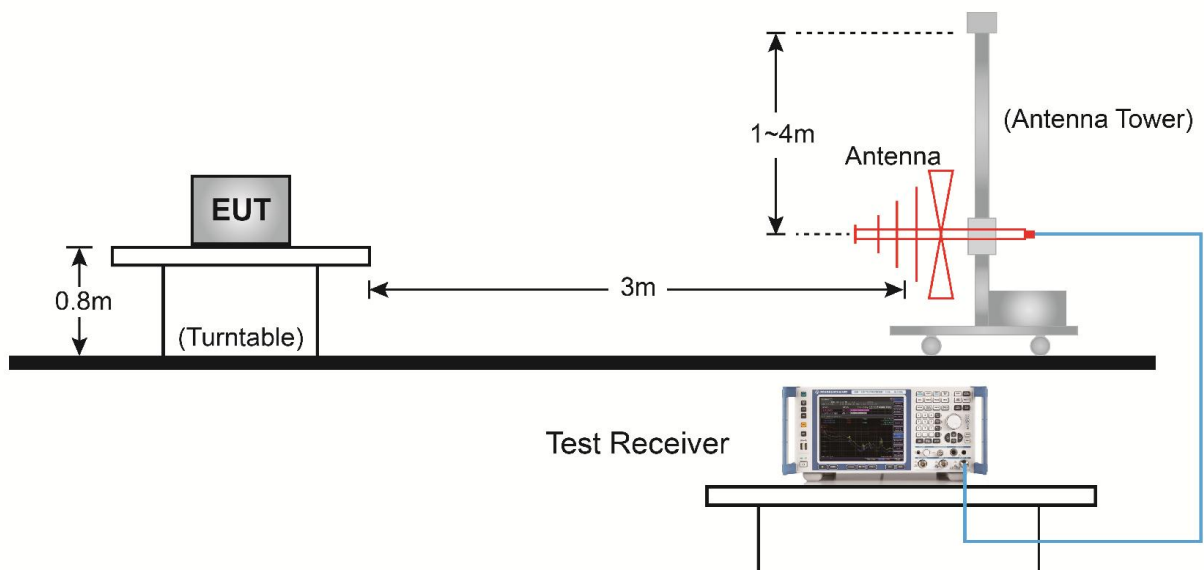



Above 1GHz Test Setup:

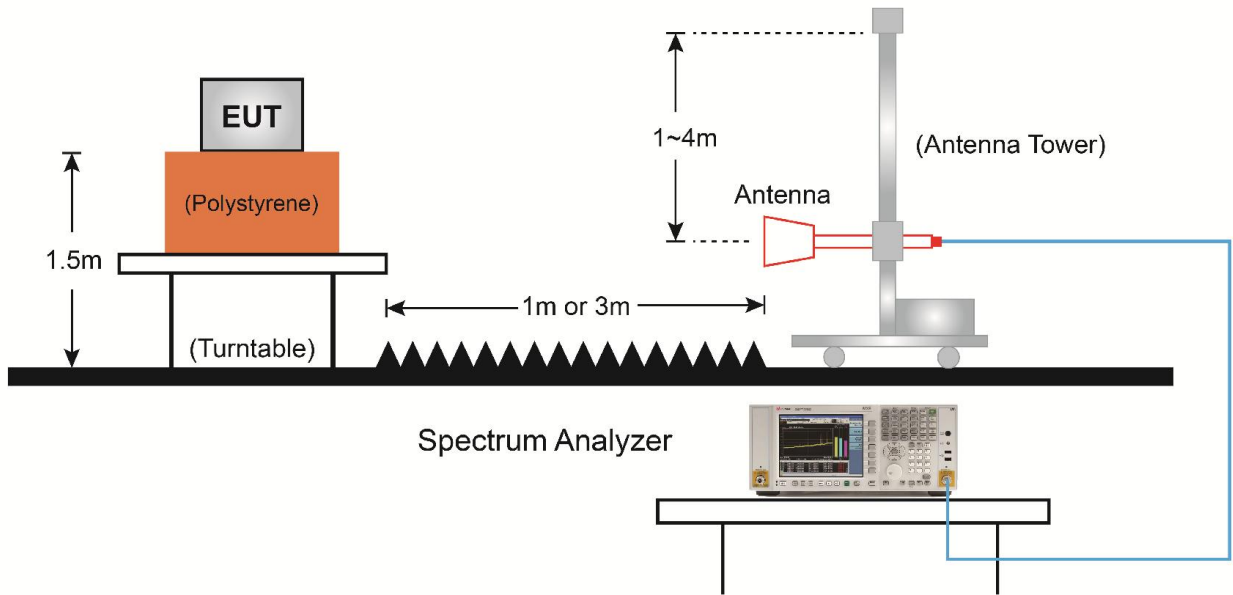

### 7.7.5. Test Result

Product	Smart metering socket	Temperature	25°C
Test Engineer	Jason Gao	Relative Humidity	58%
Test Site	AC2	Test Date	2019/11/15
Test Mode:	802.15.4	Test Channel:	11
Remark:	1. Average measurement was not performed if peak level lower than average limit. 2. Other frequency was 20dB below limit line within 1-18GHz, there is not show in the report.		

Mark	Frequency (MHz)	Reading Level (dBμV)	Factor (dB)	Measure Level (dBμV/m)	Limit (dBμV/m)	Margin (dB)	Detector	Polarization
	4187.5	39.2	1.3	40.5	74.0	-33.5	Peak	Horizontal
	4808.0	45.8	3.5	49.3	74.0	-24.7	Peak	Horizontal
*	6542.0	35.8	8.5	44.3	89.3	-45.0	Peak	Horizontal
*	6907.5	35.5	9.8	45.3	89.3	-44.0	Peak	Horizontal
	3992.0	38.6	0.3	38.9	74.0	-35.1	Peak	Vertical
	4808.0	39.7	3.5	43.2	74.0	-30.8	Peak	Vertical
*	5216.0	37.3	3.8	41.1	89.3	-48.2	Peak	Vertical
*	6108.5	36.1	6.3	42.4	89.3	-46.9	Peak	Vertical

Note 1: "\*" is not in restricted band, its limit is 20dBc of the fundamental emission level (109.3dBμV/m) or FCC 15.209 which is higher.

Note 2: Measure Level (dBμV/m) = Reading Level (dBμV) + Factor (dB)

Factor (dB) = Cable Loss (dB) + Antenna Factor (dB/m) - Pre\_Amplifier Gain (dB)

Product	Smart metering socket	Temperature	25°C
Test Engineer	Jason Gao	Relative Humidity	58%
Test Site	AC2	Test Date	2019/11/15
Test Mode:	802.15.4	Test Channel:	18
Remark:	1. Average measurement was not performed if peak level lower than average limit. 2. Other frequency was 20dB below limit line within 1-18GHz, there is not show in the report.		

Mark	Frequency (MHz)	Reading Level (dBμV)	Factor (dB)	Measure Level (dBμV/m)	Limit (dBμV/m)	Margin (dB)	Detector	Polarization
	3975.0	39.4	0.2	39.6	74.0	-34.4	Peak	Horizontal
	4884.5	47.8	3.5	51.3	74.0	-22.7	Peak	Horizontal
*	6083.0	36.8	6.1	42.9	89.0	-46.1	Peak	Horizontal
*	7043.5	35.2	10.7	45.9	89.0	-43.1	Peak	Horizontal
	4102.5	37.4	0.9	38.3	74.0	-35.7	Peak	Vertical
	4876.0	40.4	3.6	44.0	74.0	-30.0	Peak	Vertical
*	6193.5	36.2	6.7	42.9	89.0	-45.1	Peak	Vertical
*	6950.0	34.8	10.0	44.8	89.0	-44.2	Peak	Vertical

Note 1: "\*" is not in restricted band, its limit is 20dBc of the fundamental emission level (109.0dBμV/m) or FCC 15.209 which is higher.

Note 2: Measure Level (dBμV/m) = Reading Level (dBμV) + Factor (dB)

Factor (dB) = Cable Loss (dB) + Antenna Factor (dB/m) - Pre\_Amplifier Gain (dB)

Product	Smart metering socket	Temperature	25°C
Test Engineer	Jason Gao	Relative Humidity	58%
Test Site	AC2	Test Date	2019/11/15
Test Mode:	802.15.4	Test Channel:	25
Remark:	1. Average measurement was not performed if peak level lower than average limit. 2. Other frequency was 20dB below limit line within 1-18GHz, there is not show in the report.		

Mark	Frequency (MHz)	Reading Level (dB $\mu$ V)	Factor (dB)	Measure Level (dB $\mu$ V/m)	Limit (dB $\mu$ V/m)	Margin (dB)	Detector	Polarization
	3975.0	39.2	0.2	39.4	74.0	-34.6	Peak	Horizontal
	4952.5	44.9	3.5	48.4	74.0	-25.6	Peak	Horizontal
*	6720.5	35.4	8.6	44.0	93.3	-49.3	Peak	Horizontal
*	7978.5	34.3	11.6	45.9	93.3	-47.4	Peak	Horizontal
	3975.0	38.5	0.2	38.7	74.0	-35.3	Peak	Vertical
	4952.5	38.6	3.5	42.1	74.0	-31.9	Peak	Vertical
*	5845.0	35.5	6.2	41.7	93.3	-51.6	Peak	Vertical
*	6865.0	34.5	9.5	44.0	93.3	-49.3	Peak	Vertical

Note 1: "\*" is not in restricted band, its limit is 20dBc of the fundamental emission level (113.3dB $\mu$ V/m) or FCC 15.209 which is higher.

Note 2: Measure Level (dB $\mu$ V/m) = Reading Level (dB $\mu$ V) + Factor (dB)

Factor (dB) = Cable Loss (dB) + Antenna Factor (dB/m) - Pre\_Amplifier Gain (dB)

**The worst case of Radiated Emission below 1GHz:**

Site: AC2	Time: 2019/11/27 - 22:12
Limit: FCC_Part15.209_RE(3m)	Engineer: Tyler Yuan
Probe: AC2_VULB9162_0.03-7GHz	Polarity: Horizontal
EUT: Smart metering socket	Power: AC 120V/60Hz
<b>Worse Case Mode:</b> Transmit at Channel 2440MHz by 802.15.4	

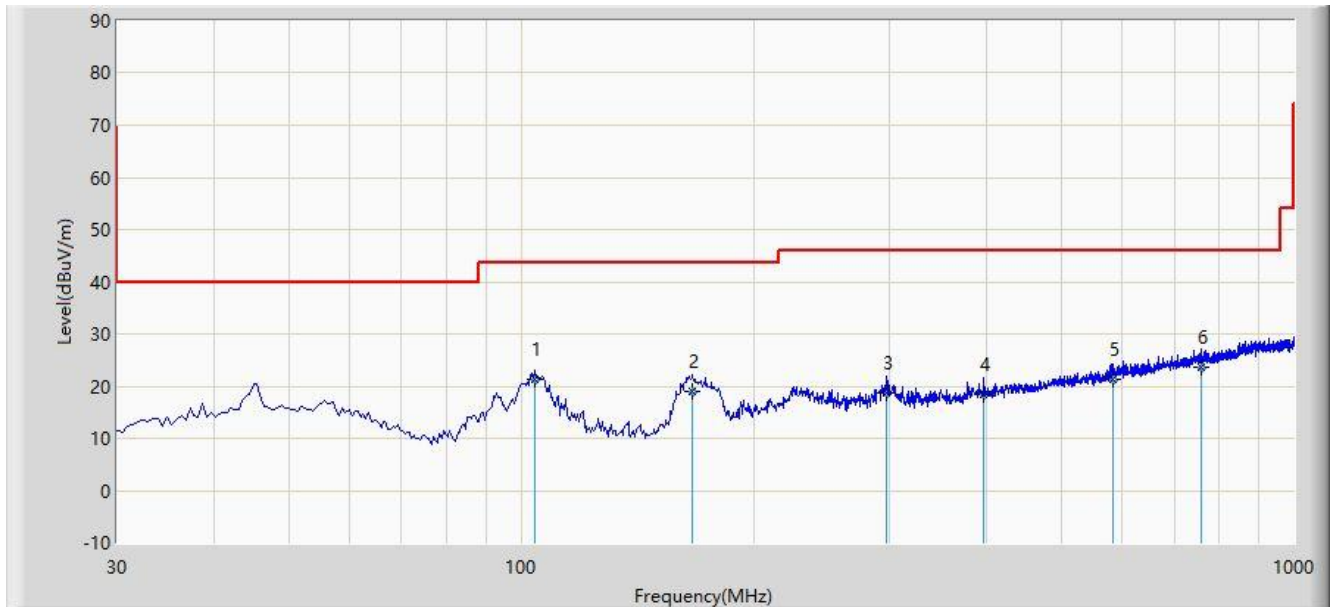

No	Flag	Mark	Frequency (MHz)	Measure Level (dBuV/m)	Reading Level (dBuV)	Margin (dB)	Limit (dBuV/m)	Factor (dB)	Type
1		*	104.210	21.278	8.871	-22.222	43.500	12.407	QP
2			166.720	18.959	8.992	-24.541	43.500	9.967	QP
3			297.200	18.678	3.898	-27.322	46.000	14.779	QP
4			397.080	18.344	1.001	-27.656	46.000	17.344	QP
5			584.300	21.295	0.228	-24.705	46.000	21.067	QP
6			757.900	23.708	0.191	-22.292	46.000	23.517	QP

Note 1: Measure Level (dB $\mu$ V/m) = Reading Level (dB $\mu$ V) + Factor (dB)

Factor (dB) = Cable Loss (dB) + Antenna Factor (dB/m)

Note 2: The test trace is same as the ambient noise and the amplitude of the emissions are attenuated more than 20dB below the permissible (the test frequency range: 9kHz ~ 30MHz, 18GHz ~ 25GHz), therefore no data appear in the report.

Site: AC2	Time: 2019/11/27 - 22:21
Limit: FCC_Part15.209_RE(3m)	Engineer: Tyler Yuan
Probe: AC2_VULB9162_0.03-7GHz	Polarity: Vertical
EUT: Smart metering socket	Power: AC 120V/60Hz
<b>Worse Case Mode:</b> Transmit at Channel 2440MHz by 802.15.4	

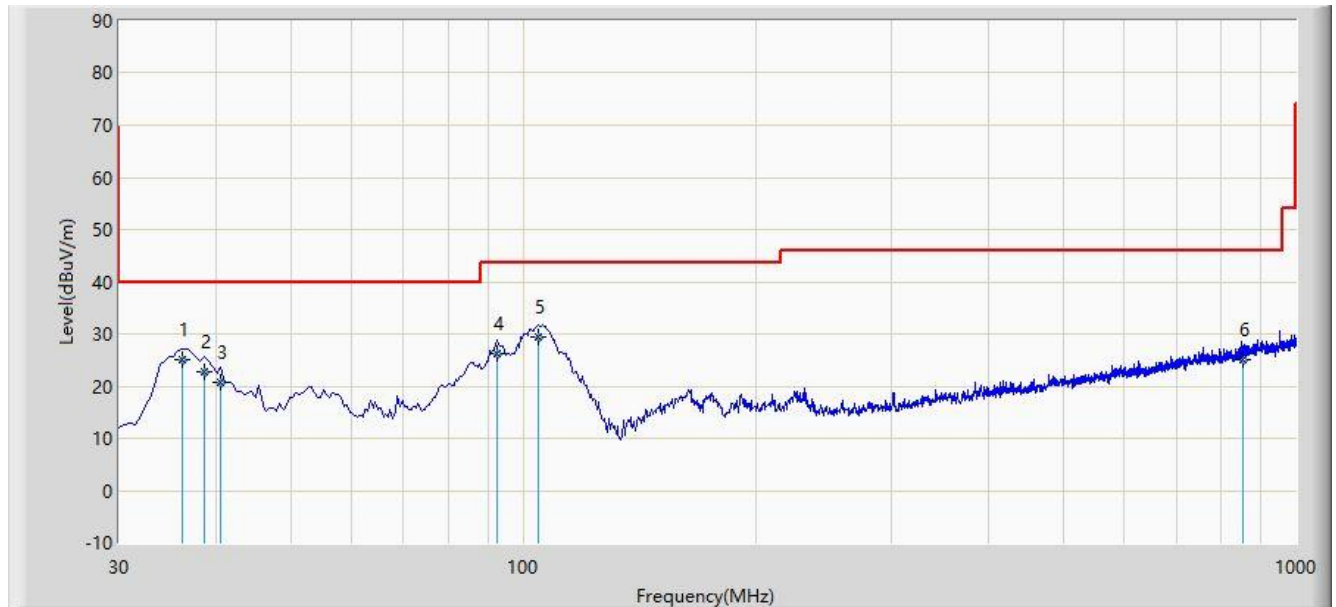

No	Flag	Mark	Frequency (MHz)	Measure Level (dBuV/m)	Reading Level (dBuV)	Margin (dB)	Limit (dBuV/m)	Factor (dB)	Type
1			36.280	24.979	12.776	-15.021	40.000	12.203	QP
2			38.680	22.817	9.928	-17.183	40.000	12.889	QP
3			40.610	20.738	7.261	-19.262	40.000	13.477	QP
4			92.700	26.138	14.821	-17.362	43.500	11.317	QP
5		*	104.610	29.401	17.002	-14.099	43.500	12.398	QP
6			852.160	24.966	0.010	-21.034	46.000	24.956	QP

Note 1: Measure Level (dB $\mu$ V/m) = Reading Level (dB $\mu$ V) + Factor (dB)

Factor (dB) = Cable Loss (dB) + Antenna Factor (dB/m)

Note 2: The test trace is same as the ambient noise and the amplitude of the emissions are attenuated more than 20dB below the permissible (the test frequency range: 9kHz ~ 30MHz, 18GHz ~ 25GHz), therefore no data appear in the report.

## 7.8. Radiated Restricted Band Edge Measurement

### 7.8.1. Test Limit

#### For 15.205 requirement:

Radiated emissions which fall in the restricted bands, as defined in Section 15.205(a) of FCC part 15, must also comply with the radiated emission limits specified in Section 15.209(a).

Frequency (MHz)	Frequency (MHz)	Frequency (MHz)	Frequency (GHz)
0.090 - 0.110	16.42 - 16.423	399.9 - 410	4.5 - 5.15
<sup>1</sup> 0.495 - 0.505	16.69475 - 16.69525	608 - 614	5.35 - 5.46
2.1735 - 2.1905	16.80425 - 16.80475	960 - 1240	7.25 - 7.75
4.125 - 4.128	25.5 - 25.67	1300 - 1427	8.025 - 8.5
4.17725 - 4.17775	37.5 - 38.25	1435 - 1626.5	9.0 - 9.2
4.20725 - 4.20775	73 - 74.6	1645.5 - 1646.5	9.3 - 9.5
6.215 - 6.218	74.8 - 75.2	1660 - 1710	10.6 - 12.7
6.26775 - 6.26825	108 - 121.94	1718.8 - 1722.2	13.25 - 13.4
6.31175 - 6.31225	123 - 138	2200 - 2300	14.47 - 14.5
8.291 - 8.294	149.9 - 150.05	2310 - 2390	15.35 - 16.2
8.362 - 8.366	156.52475 - 156.525	2483.5 - 2500	17.7 - 21.4
8.37625 - 8.38675	156.7 - 156.9	2690 - 2900	22.01 - 23.12
8.41425 - 8.41475	162.0125 - 167.17	3260 - 3267	23.6 - 24.0
12.29 - 12.293	167.72 - 173.2	3332 - 3339	31.2 - 31.8
12.51975 - 12.52025	240 - 285	3345.8 - 3358	36.43 - 36.5
12.57675 - 12.57725	322 - 335.4	3600 - 4400	( <sup>2</sup> )
13.36 - 13.41	--	--	--

All out of band emissions appearing in a restricted band as specified in Section 15.205 of the Title 47CFR must not exceed the limits shown in Table per Section 15.209.

<b>FCC Part 15 Subpart C Paragraph 15.209</b>		
Frequency [MHz]	Field Strength [uV/m]	Measured Distance [Meters]
0.009 - 0.490	2400/F (kHz)	300
0.490 - 1.705	24000/F (kHz)	30
1.705 - 30	30	30
30 - 88	100	3
88 - 216	150	3
216 - 960	200	3
Above 960	500	3



**For RSS-Gen Section 8.10 requirement:**

Radiated emissions which fall in the restricted bands, as defined in Section 8.10 of RSS-Gen, must also comply with the radiated emission limits specified in Section 8.9.

Frequency (MHz)	Frequency (MHz)	Frequency (GHz)
0.009 - 0.110	149.9 - 150.05	9.0 - 9.2
0.495 - 0.505	156.52475 - 156.525225	9.3 - 9.5
2.1735 - 2.1905	156.7 - 156.9	10.6 - 12.7
3.020 - 3.026	162.0125 - 167.17	13.25 - 13.4
4.125-4.128	167.72 - 173.2	14.47 - 14.5
4.17725-4.17775	240 - 285	15.35 - 16.2
4.20725-4.20775	322 - 335.4	17.7 - 21.4
5.677 - 5.683	399.9 - 410	22.01 - 23.12
6.215 - 6.218	608 - 614	23.6 - 24.0
6.26775 - 6.26825	960 - 1427	31.2 - 31.8
6.31175 - 6.31225	1435 - 1626.5	36.43 - 36.5
8.291 - 8.294	1645.5 - 1646.5	Above 38.6
8.362 - 8.366	1660 - 1710	--
8.37625 - 8.38675	1718.8 -1722.2	
8.41425 - 8.41475	2200 - 2300	
12.29 - 12.293	2310 -2390	
12.51975 - 12.52025	2483.5 -2500	
12.57675 - 12.57725	2655 - 2900	
13.36 -13.41	3260 - 3267	
16.42 - 16.423	3332 -3339	
16.69475 - 16.69525	3345.8 - 3358	
16.80425 - 16.80475	3500 - 4400	
25.5 - 25.67	4500 - 5150	
37.5 - 38.25	5350 - 5460	
73 - 74.6	7250 - 7750	
74.8 - 75.2	8025 - 8500	
108 - 138		

All out of band emissions appearing in a restricted band as specified in Section 8.10 of the RSS-Gen must not exceed the limits shown in Table per Section 8.9.

RSS-Gen Section 8.9		
Frequency [MHz]	Field Strength [uV/m]	Measured Distance [Meters]
0.009 - 0.490	2400/F (kHz)	300
0.490 - 1.705	24000/F (kHz)	30
1.705 - 30	30	30
30 - 88	100	3
88 - 216	150	3
216 - 960	200	3
Above 960	500	3

**7.8.2. Test Procedure Used**

ANSI C63.10 Section 6.3 (General Requirements)

ANSI C63.10 Section 6.6 (Standard test method above 1GHz)

**7.8.3. Test Setting**

**Peak Field Strength Measurements**

1. Analyzer center frequency was set to the frequency of the radiated spurious emission of interest
2. RBW = 1MHz
3. VBW = 3MHz
4. Detector = peak
5. Sweep time = auto couple
6. Trace mode = max hold
7. Trace was allowed to stabilize

### Average Measurements above 1GHz (Method VB)

1. Analyzer center frequency was set to the frequency of the radiated spurious emission of interest
2. RBW = 1MHz
3. VBW; If the EUT is configured to transmit with duty cycle  $\geq 98\%$ , set VBW = 10 Hz.  
If the EUT duty cycle is  $< 98\%$ , set VBW  $\geq 1/T$ . T is the minimum transmission duration.
4. Detector = Peak
5. Sweep time = auto
6. Trace mode = max hold
7. Trace was allowed to stabilize

#### 7.8.4. Test Setup

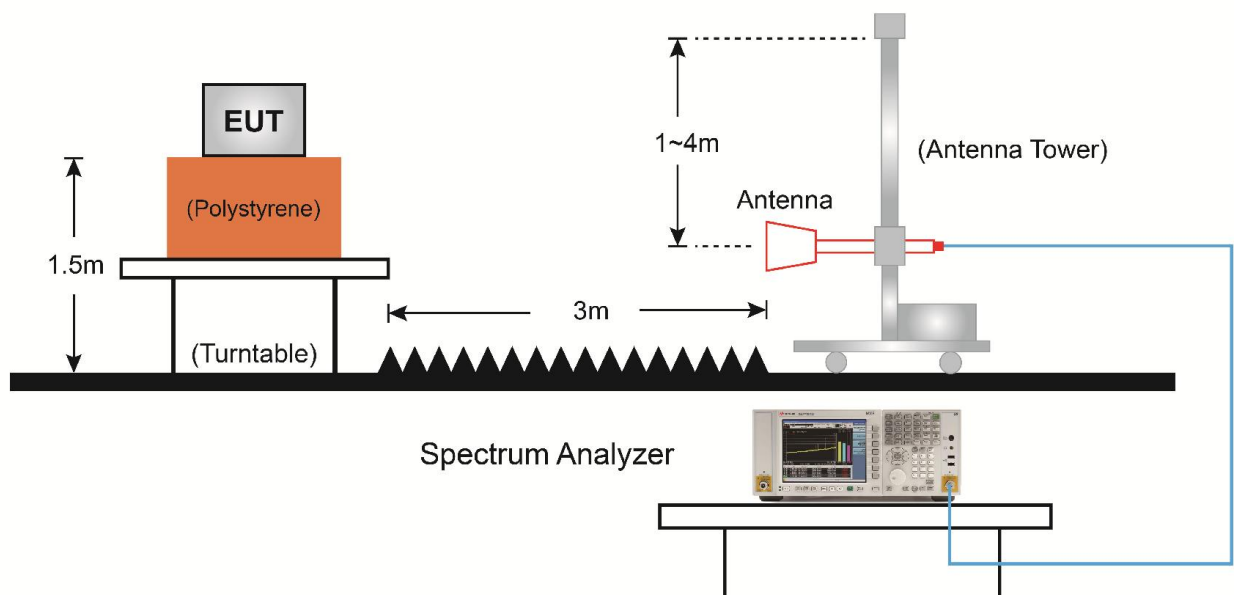

### 7.8.5. Test Result

Site: AC2	Time: 2019/11/14 - 23:28
Limit: FCC_Part15.209_RE(3m)	Engineer: Tyler Yuan
Probe: BBHA9120D_1-18GHz	Polarity: Horizontal
EUT: Smart metering socket	Power: By USB
Test Mode: Transmit by 802.15.4 at channel 2405MHz	

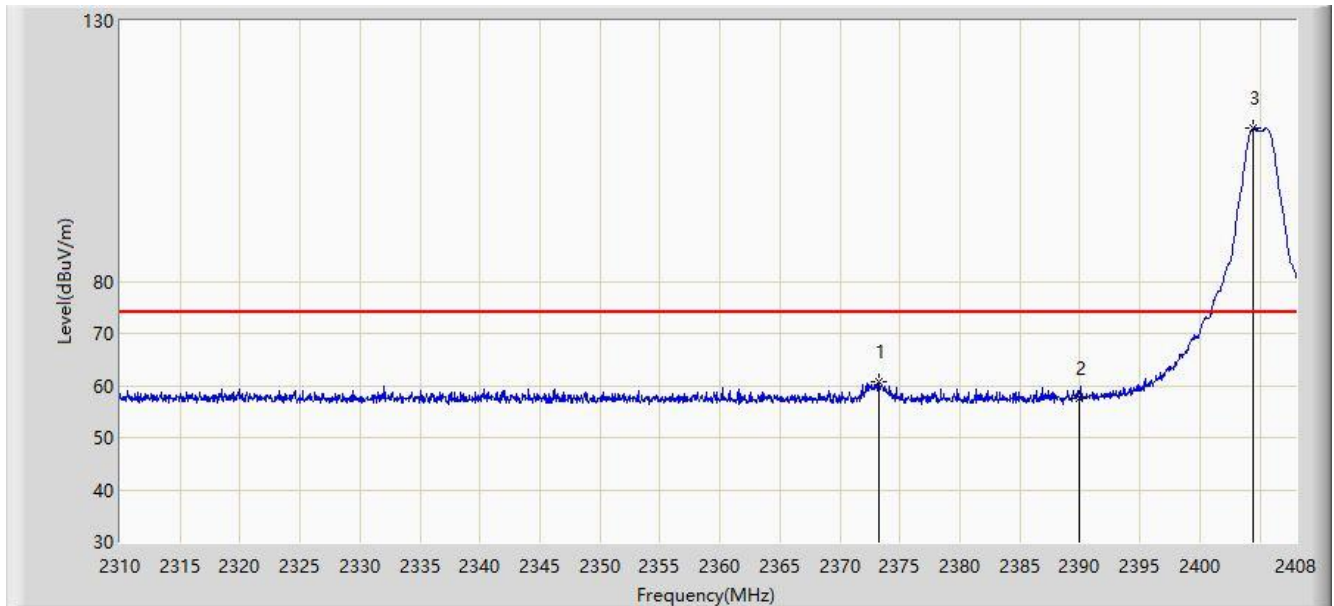

No	Flag	Mark	Frequency (MHz)	Measure Level (dBuV/m)	Reading Level (dBuV)	Margin (dB)	Limit (dBuV/m)	Factor (dB)	Type
1			2373.259	60.678	29.225	-13.322	74.000	31.452	PK
2			2390.000	57.475	26.026	-16.525	74.000	31.449	PK
3		*	2404.423	109.300	77.887	N/A	N/A	31.414	PK

Note: Measure Level (dBuV/m) = Reading Level (dBuV) + Factor (dB)

Factor (dB) = Cable Loss (dB) + Antenna Factor (dB/m).

Site: AC2	Time: 2019/11/14 - 23:30
Limit: FCC_Part15.209_RE(3m)	Engineer: Tyler Yuan
Probe: BBHA9120D_1-18GHz	Polarity: Horizontal
EUT: Smart metering socket	Power: By USB
Test Mode: Transmit by 802.15.4 at channel 2405MHz	

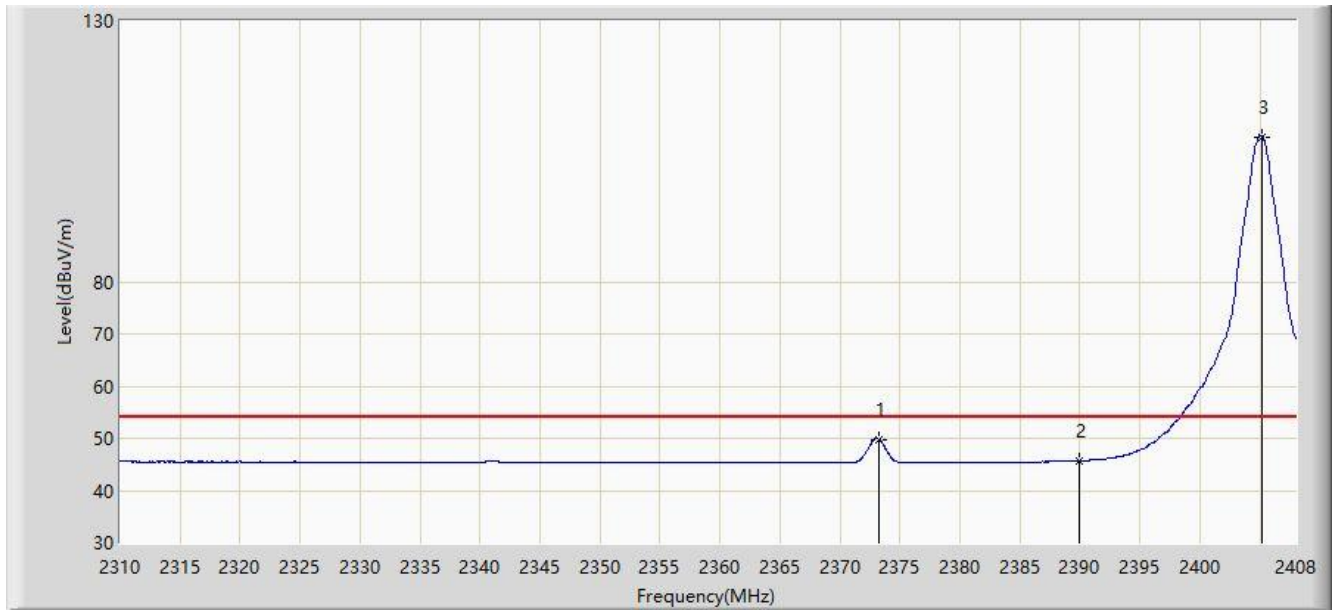

No	Flag	Mark	Frequency (MHz)	Measure Level (dBuV/m)	Reading Level (dBuV)	Margin (dB)	Limit (dBuV/m)	Factor (dB)	Type
1			2373.210	49.842	18.389	-4.158	54.000	31.452	AV
2			2390.000	45.723	14.274	-8.277	54.000	31.449	AV
3		*	2405.207	107.798	76.388	N/A	N/A	31.411	AV

Note: Measure Level (dBuV/m) = Reading Level (dBuV) + Factor (dB)

Factor (dB) = Cable Loss (dB) + Antenna Factor (dB/m).

Site: AC2	Time: 2019/11/14 - 23:33
Limit: FCC_Part15.209_RE(3m)	Engineer: Tyler Yuan
Probe: BBHA9120D_1-18GHz	Polarity: Vertical
EUT: Smart metering socket	Power: By USB
Test Mode: Transmit by 802.15.4 at channel 2405MHz	

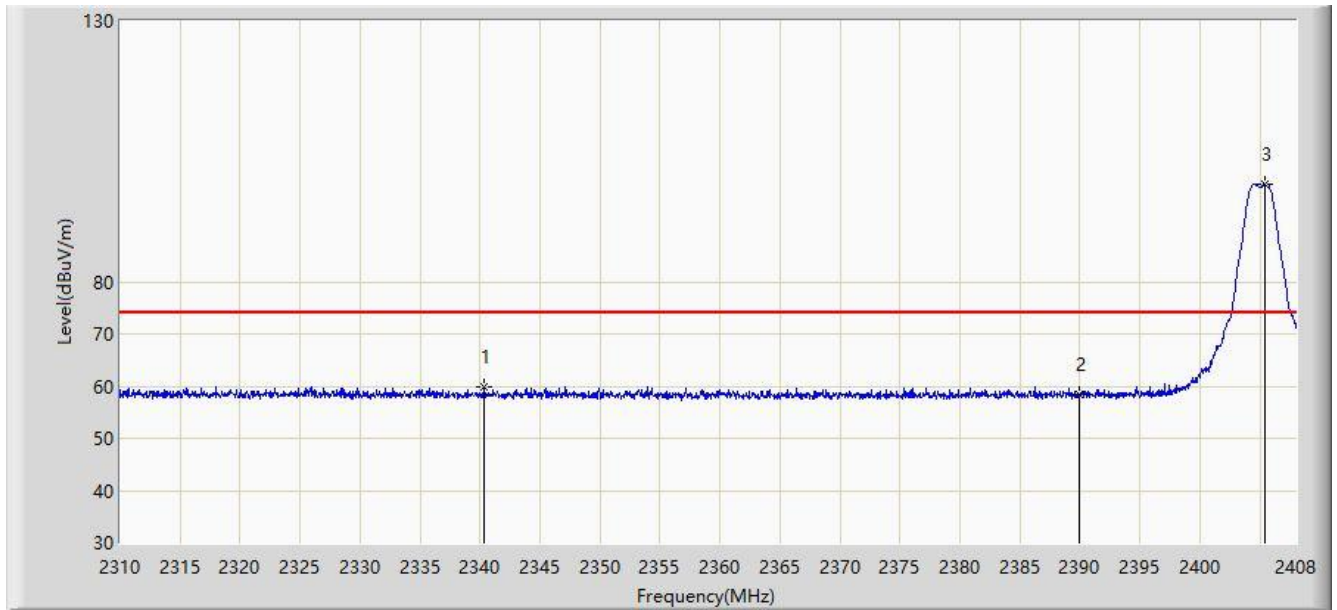

No	Flag	Mark	Frequency (MHz)	Measure Level (dBuV/m)	Reading Level (dBuV)	Margin (dB)	Limit (dBuV/m)	Factor (dB)	Type
1			2340.282	59.922	28.376	-14.078	74.000	31.546	PK
2			2390.000	58.377	26.928	-15.623	74.000	31.449	PK
3		*	2405.403	98.785	67.375	N/A	N/A	31.410	PK

Note: Measure Level (dB $\mu$ V/m) = Reading Level (dB $\mu$ V) + Factor (dB)

Factor (dB) = Cable Loss (dB) + Antenna Factor (dB/m).

Site: AC2	Time: 2019/11/14 - 23:35
Limit: FCC_Part15.209_RE(3m)	Engineer: Tyler Yuan
Probe: BBHA9120D_1-18GHz	Polarity: Vertical
EUT: Smart metering socket	Power: By USB
Test Mode: Transmit by 802.15.4 at channel 2405MHz	

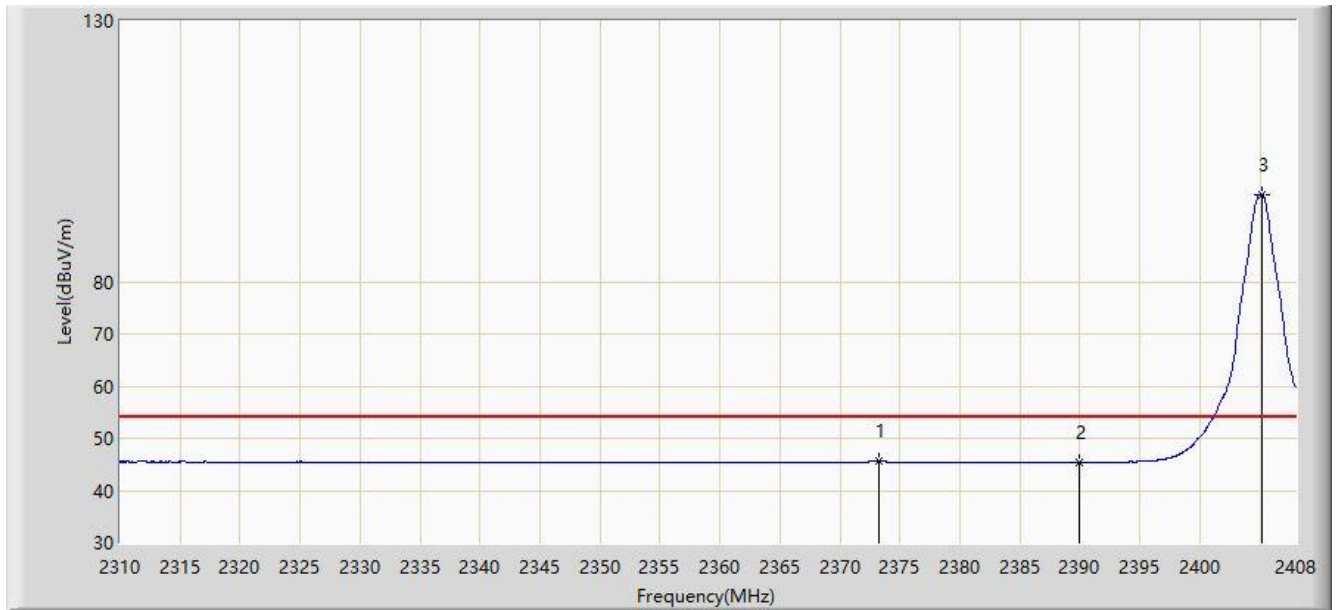

No	Flag	Mark	Frequency (MHz)	Measure Level (dBuV/m)	Reading Level (dBuV)	Margin (dB)	Limit (dBuV/m)	Factor (dB)	Type
1			2373.210	45.635	14.182	-8.365	54.000	31.452	AV
2			2390.000	45.387	13.938	-8.613	54.000	31.449	AV
3		*	2405.207	96.702	65.292	N/A	N/A	31.411	AV

Note: Measure Level (dB $\mu$ V/m) = Reading Level (dB $\mu$ V) + Factor (dB)

Factor (dB) = Cable Loss (dB) + Antenna Factor (dB/m).

Site: AC2	Time: 2019/11/15 - 00:07
Limit: FCC_Part15.209_RE(3m)	Engineer: Tyler Yuan
Probe: BBHA9120D_1-18GHz	Polarity: Horizontal
EUT: Smart metering socket	Power: By USB
Test Mode: Transmit by 802.15.4 at channel 2475MHz	

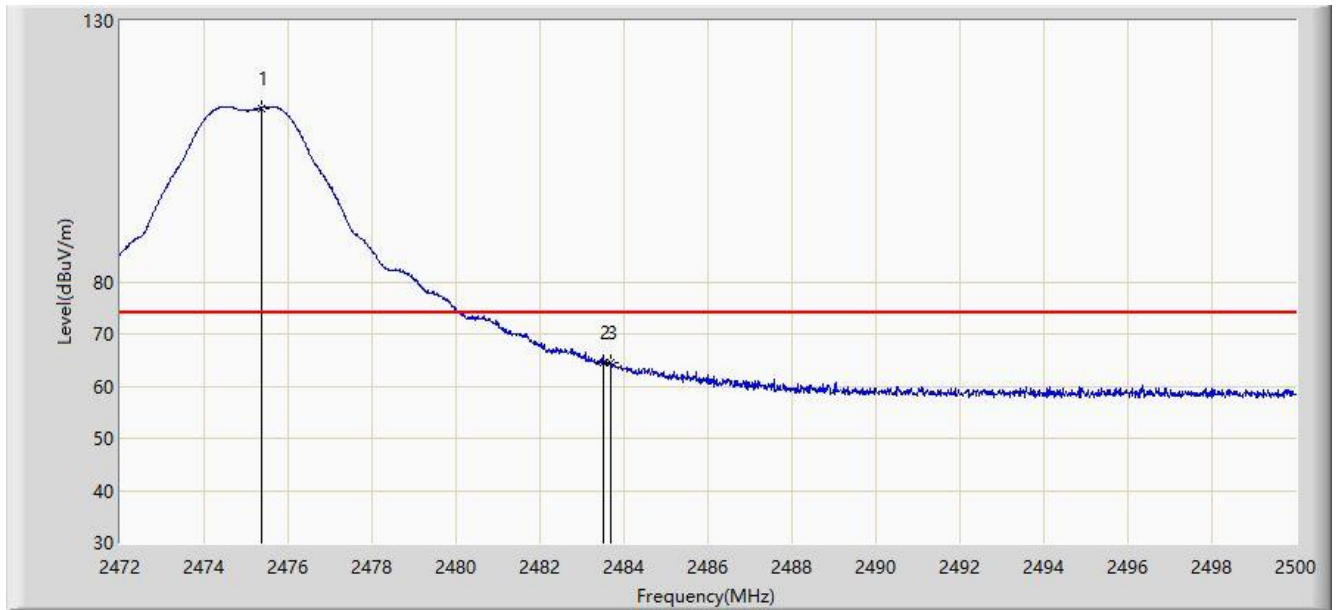

No	Flag	Mark	Frequency (MHz)	Measure Level (dBuV/m)	Reading Level (dBuV)	Margin (dB)	Limit (dBuV/m)	Factor (dB)	Type
1		*	2475.360	113.328	81.950	N/A	N/A	31.378	PK
2			2483.500	64.546	33.143	-9.454	74.000	31.403	PK
3			2483.690	64.626	33.223	-9.374	74.000	31.403	PK

Note: Measure Level (dB $\mu$ V/m) = Reading Level (dB $\mu$ V) + Factor (dB)

Factor (dB) = Cable Loss (dB) + Antenna Factor (dB/m).



Site: AC2	Time: 2019/11/15 - 00:11
Limit: FCC_Part15.209_RE(3m)	Engineer: Tyler Yuan
Probe: BBHA9120D_1-18GHz	Polarity: Horizontal
EUT: Smart metering socket	Power: By USB
Test Mode: Transmit by 802.15.4 at channel 2475MHz	

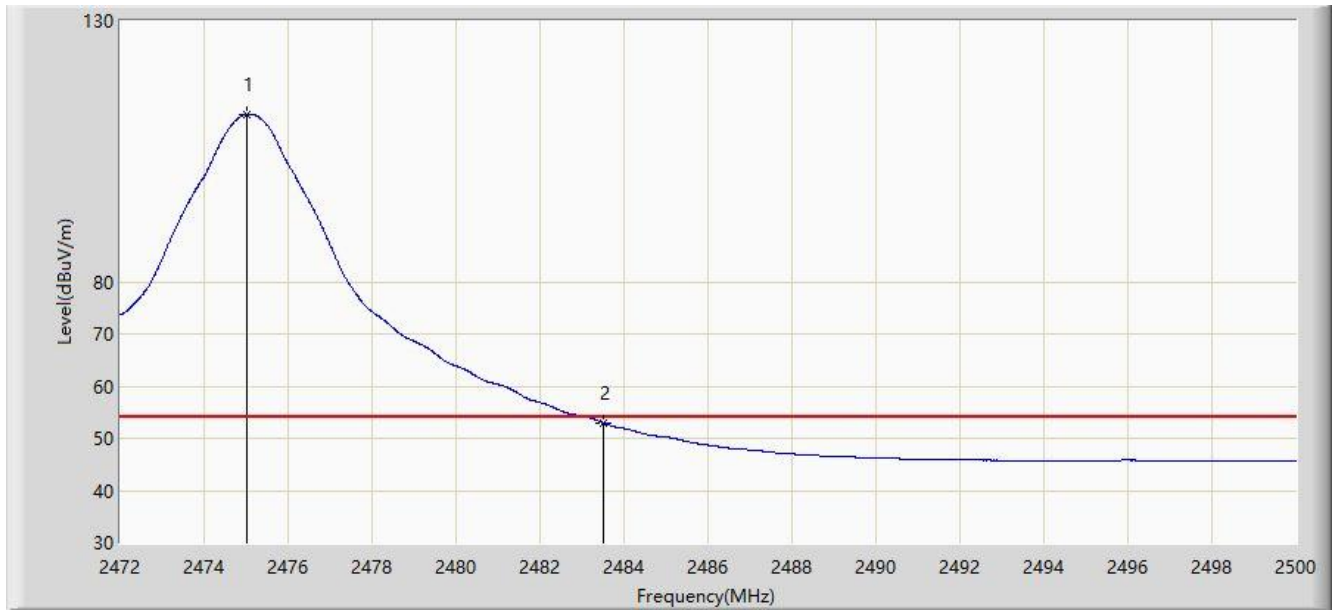

No	Flag	Mark	Frequency (MHz)	Measure Level (dBuV/m)	Reading Level (dBuV)	Margin (dB)	Limit (dBuV/m)	Factor (dB)	Type
1		*	2475.010	112.093	80.716	N/A	N/A	31.377	AV
2			2483.500	52.944	21.541	-1.056	54.000	31.403	AV

Note: Measure Level (dB $\mu$ V/m) = Reading Level (dB $\mu$ V) + Factor (dB)

Factor (dB) = Cable Loss (dB) + Antenna Factor (dB/m).

Site: AC2	Time: 2019/11/15 - 00:14
Limit: FCC_Part15.209_RE(3m)	Engineer: Tyler Yuan
Probe: BBHA9120D_1-18GHz	Polarity: Vertical
EUT: Smart metering socket	Power: By USB
Test Mode: Transmit by 802.15.4 at channel 2475MHz	

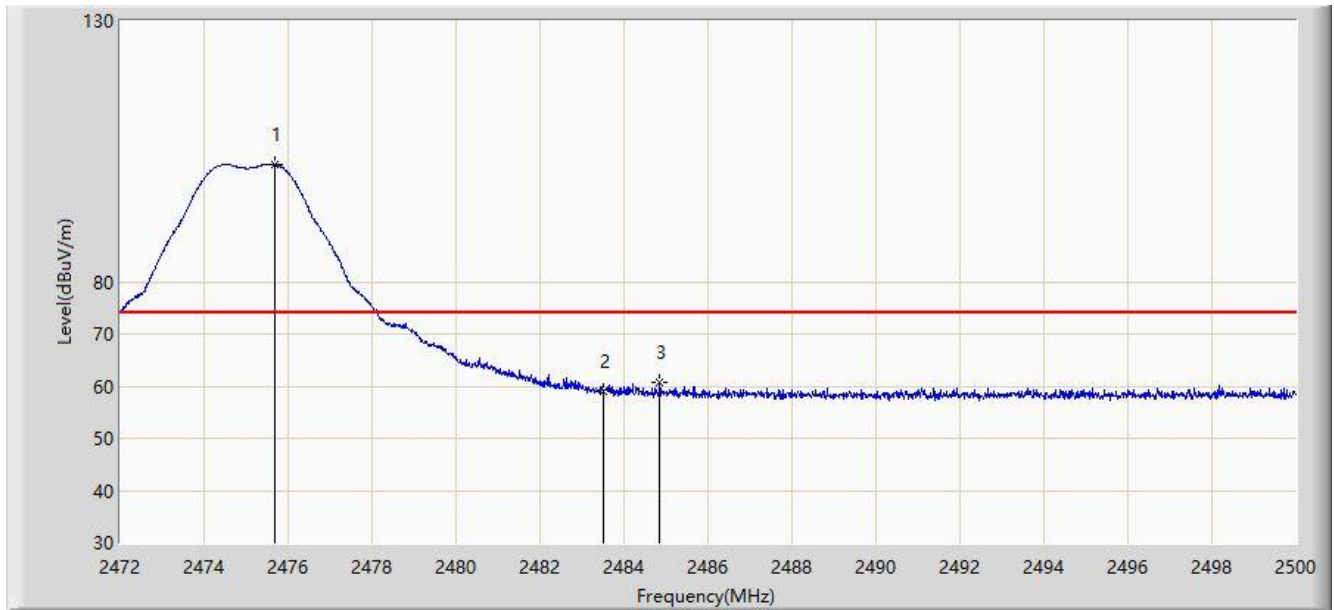

No	Flag	Mark	Frequency (MHz)	Measure Level (dBuV/m)	Reading Level (dBuV)	Margin (dB)	Limit (dBuV/m)	Factor (dB)	Type
1		*	2475.682	102.500	71.121	N/A	N/A	31.379	PK
2			2483.500	59.036	27.633	-14.964	74.000	31.403	PK
3			2484.852	60.755	29.348	-13.245	74.000	31.407	PK

Note: Measure Level (dB $\mu$ V/m) = Reading Level (dB $\mu$ V) + Factor (dB)

Factor (dB) = Cable Loss (dB) + Antenna Factor (dB/m).

Site: AC2	Time: 2019/11/15 - 00:16
Limit: FCC_Part15.209_RE(3m)	Engineer: Tyler Yuan
Probe: BBHA9120D_1-18GHz	Polarity: Vertical
EUT: Smart metering socket	Power: By USB
Test Mode: Transmit by 802.15.4 at channel 2475MHz	

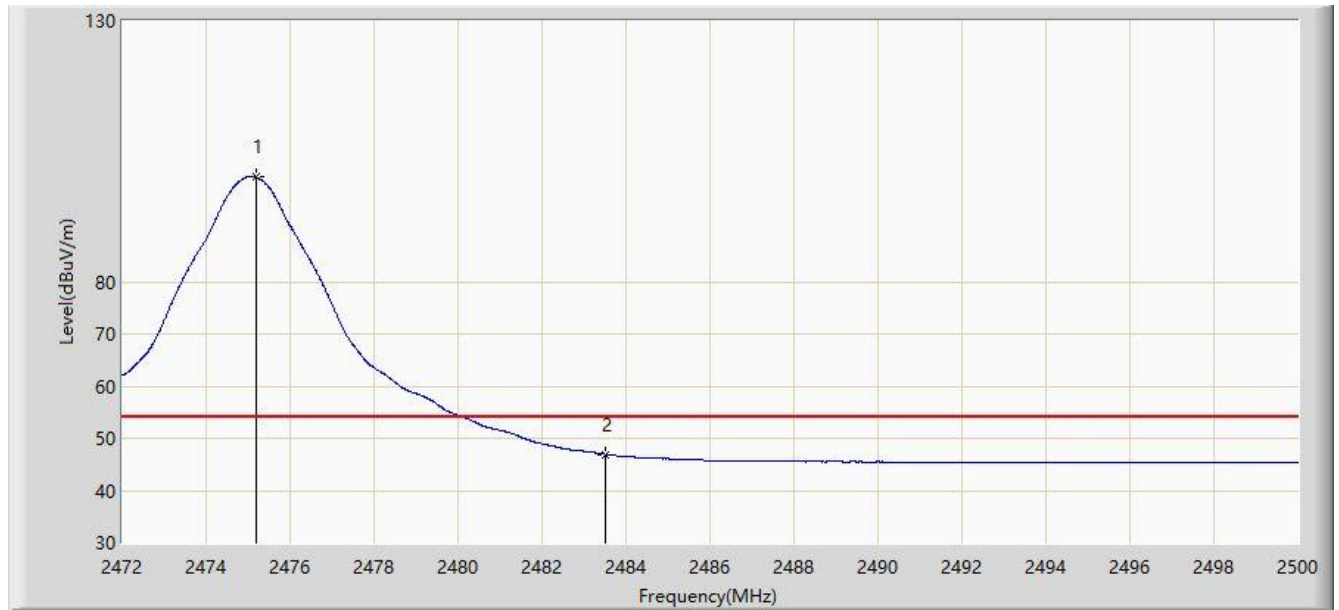

No	Flag	Mark	Frequency (MHz)	Measure Level (dBuV/m)	Reading Level (dBuV)	Margin (dB)	Limit (dBuV/m)	Factor (dB)	Type
1		*	2475.206	100.011	68.633	N/A	N/A	31.378	AV
2			2483.500	46.940	15.537	-7.060	54.000	31.403	AV

Note: Measure Level (dBμV/m) = Reading Level (dBμV) + Factor (dB)

Factor (dB) = Cable Loss (dB) + Antenna Factor (dB/m).

## 7.1. AC Conducted Emissions Measurement

### 7.1.1. Test Limit

FCC Part 15 Subpart C Paragraph 15.207 Limits		
Frequency (MHz)	QP (dBuV)	AV (dBuV)
0.15 - 0.50	66 - 56	56 - 46
0.50 - 5.0	56	46
5.0 - 30	60	50

Note 1: The lower limit shall apply at the transition frequencies.

Note 2: The limit decreases linearly with the logarithm of the frequency in the range 0.15MHz to 0.5MHz.

### 7.1.2. Test Setup

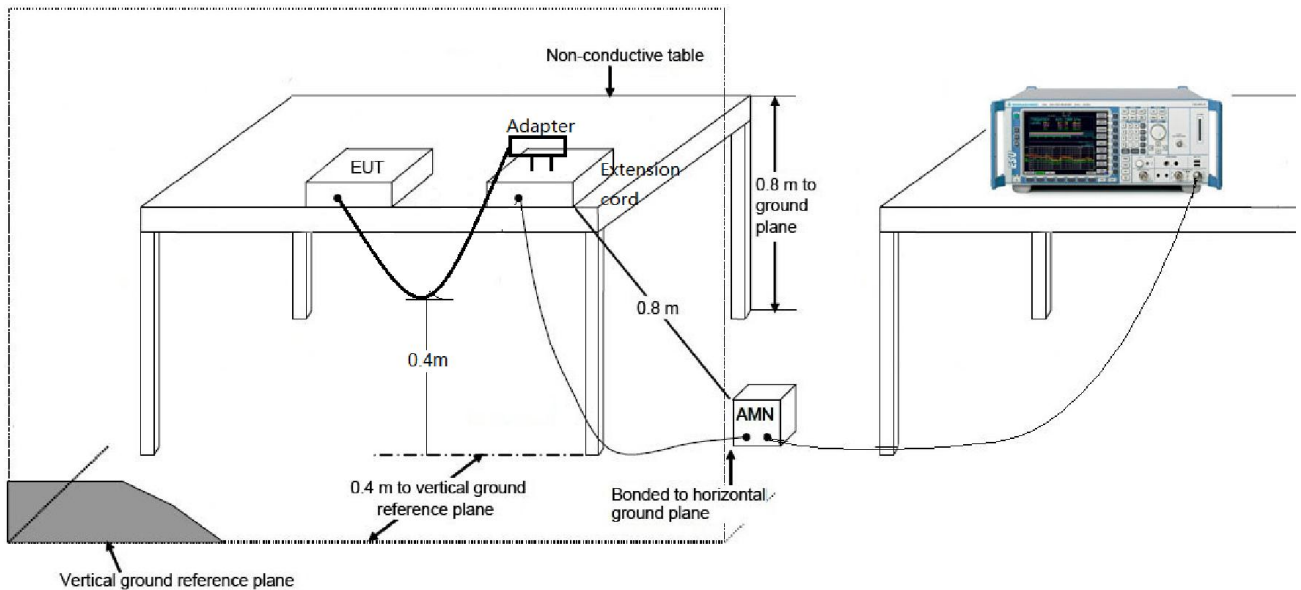

### 7.1.3. Test Result

Site: SR2	Time: 2019/11/26 - 20:08
Limit: FCC_Part15.207_CE_AC Power	Engineer: Liz Yuan
Probe: ENV216_101683_Filter On	Polarity: Line
EUT: Smart metering socket	Power: AC 120V/60Hz
Test Mode: Transmit by 802.15.4 at channel 2405MHz	

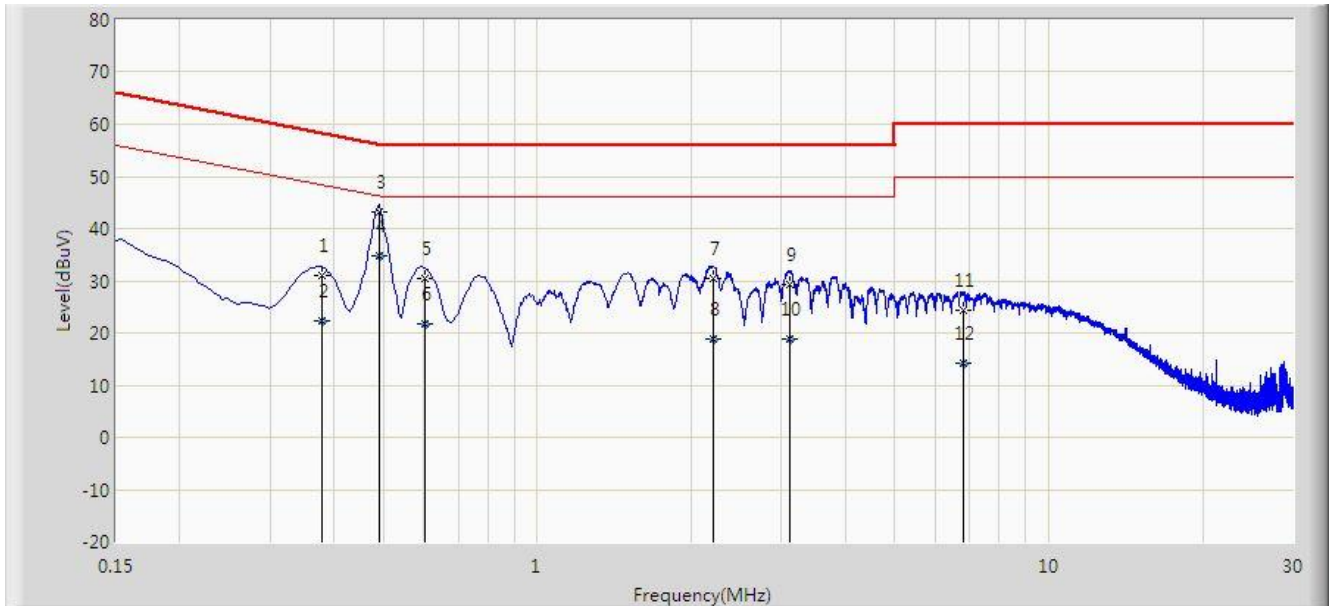

No	Flag	Mark	Frequency (MHz)	Measure Level (dBuV)	Reading Level (dBuV)	Margin (dB)	Limit (dBuV)	Factor (dB)	Type
1			0.378	31.075	21.008	-27.248	58.323	10.067	QP
2			0.378	22.231	12.163	-26.093	48.323	10.067	AV
3			0.490	43.093	32.935	-13.075	56.168	10.158	QP
4		*	0.490	34.834	24.676	-11.333	46.168	10.158	AV
5			0.602	30.444	20.330	-25.556	56.000	10.114	QP
6			0.602	21.608	11.494	-24.392	46.000	10.114	AV
7			2.214	30.308	20.442	-25.692	56.000	9.866	QP
8			2.214	18.918	9.052	-27.082	46.000	9.866	AV
9			3.122	29.176	19.318	-26.824	56.000	9.858	QP
10			3.122	18.704	8.846	-27.296	46.000	9.858	AV
11			6.818	24.440	14.290	-35.560	60.000	10.150	QP
12			6.818	14.130	3.980	-35.870	50.000	10.150	AV

Note: Measure Level (dB $\mu$ V) = Reading Level (dB $\mu$ V) + Factor (dB)

Factor (dB) = Cable Loss (dB) + LISN Factor (dB)

Site: SR2	Time: 2019/11/26 - 20:15
Limit: FCC_Part15.207_CE_AC Power	Engineer: Liz Yuan
Probe: ENV216_101683_Filter On	Polarity: Neutral
EUT: Smart metering socket	Power: AC 120V/60Hz
Test Mode: Transmit by 802.15.4 at channel 2405MHz	

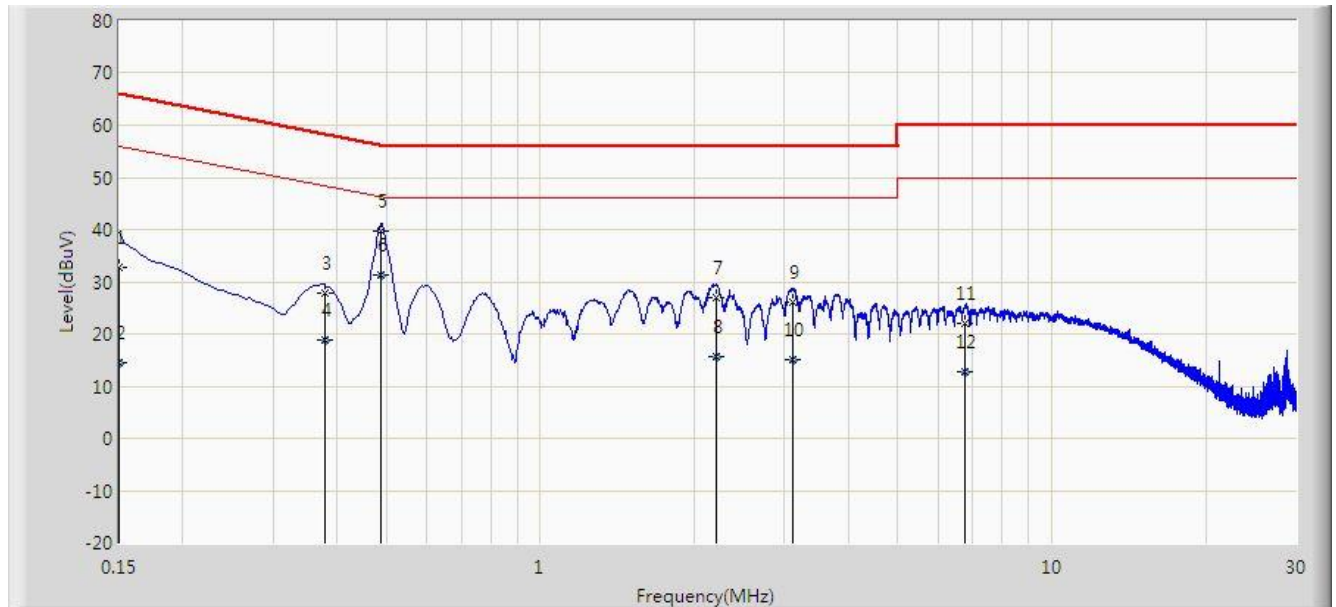

No	Flag	Mark	Frequency (MHz)	Measure Level (dBuV)	Reading Level (dBuV)	Margin (dB)	Limit (dBuV)	Factor (dB)	Type
1			0.150	32.662	21.520	-33.338	66.000	11.142	QP
2			0.150	14.606	3.464	-41.394	56.000	11.142	AV
3			0.378	27.733	17.637	-30.590	58.323	10.096	QP
4			0.378	18.954	8.858	-29.370	48.323	10.096	AV
5			0.486	39.749	29.573	-16.487	56.236	10.176	QP
6		*	0.486	31.442	21.266	-14.794	46.236	10.176	AV
7			2.214	26.899	17.030	-29.101	56.000	9.869	QP
8			2.214	15.713	5.845	-30.287	46.000	9.869	AV
9			3.106	26.153	16.289	-29.847	56.000	9.864	QP
10			3.106	15.159	5.295	-30.841	46.000	9.864	AV
11			6.774	22.105	11.943	-37.895	60.000	10.162	QP
12			6.774	12.685	2.523	-37.315	50.000	10.162	AV

Note: Measure Level (dBμV) = Reading Level (dBμV) + Factor (dB)

Factor (dB) = Cable Loss (dB) + LISN Factor (dB)

## 8. CONCLUSION

The data collected relate only the item(s) tested and show that the device is in compliance with Part 15C of the FCC Rules and ISED Rules.

————— The End —————

## **Appendix A - Test Setup Photograph**

Refer to "1911WSU008-UT" file.



## **Appendix B - EUT Photograph**

Refer to "1911WSU008-UE" file.