

FCC Test Report

Client Name : GCteq Wireless(shenzhen) Co., Ltd

Client Address : No. A402, Floor 4, Suojia Science park
Complex Building, Sanwei Community,
Hangcheng Street, Bao 'an District, Shenzhen
City, Guangdong Province China

Product Name : Embedded intelligent multi-functional
charger

Report Date : Aug. 23, 2022

Shenzhen Anbotek Compliance Laboratory Limited



Shenzhen Anbotek Compliance Laboratory Limited

Address: 1/F., Building D, Sogood Science and Technology Park, Sanwei Community,
Hangcheng Street, Bao'an District, Shenzhen, Guangdong, China.
Tel: (86) 0755-26066440 Fax: (86) 0755-26014772 Email: service@anbotek.com

Code: AB-RF-05-b



Hotline

400-003-0500

www.anbotek.com.cn



Contents

1. General Information	5
1.1. Client Information	5
1.2. Description of Device (EUT)	5
1.3. Auxiliary Equipment Used During Test	6
1.4. Description of Test Modes	6
1.5. Description Of Test Setup	8
1.6. Test Equipment List	9
1.7. Measurement Uncertainty	10
1.8. Description of Test Facility	10
2. Summary of Test Results	11
3. Conducted Emission Test	12
3.1. Test Standard and Limit	12
3.2. Test Setup	12
3.3. Test Procedure	12
3.4. Test Data	12
4. Radiation Spurious Emission	15
4.1. Test Standard and Limit	15
4.2. Test Setup	15
4.3. Test Procedure	16
4.4. Test Data	16
5. Antenna Requirement	21
5.1. Test Standard and Requirement	21
5.2. Antenna Connected Construction	21
APPENDIX I -- TEST SETUP PHOTOGRAPH	22
APPENDIX II -- EXTERNAL PHOTOGRAPH	22
APPENDIX III -- INTERNAL PHOTOGRAPH	22



TEST REPORT

Applicant : GCteq Wireless(shenzhen) Co., Ltd
Manufacturer : GCteq Wireless(shenzhen) Co., Ltd
Product Name : Embedded intelligent multi-functional charger
Model No. : GF-04 PRO
Trade Mark : GCteq
Rating(s) : Input: 24V==
WPT output: 15W Max
USB-A output: 18W Max
Type-C output: 65W Max
Test Standard(s) : FCC Part15 Subpart C, Paragraph 15.209
Test Method(s) : ANSI C63.10: 2020

The device described above is tested by Shenzhen Anbotek Compliance Laboratory Limited to determine the maximum emission levels emanating from the device and the severe levels of the device can endure and its performance criterion. The measurement results are contained in this test report and Shenzhen Anbotek Compliance Laboratory Limited is assumed full of responsibility for the accuracy and completeness of these measurements. Also, this report shows that the EUT (Equipment Under Test) is technically compliant with the FCC Part 15 Subpart C requirements.

This report applies to above tested sample only and shall not be reproduced in part without written approval of Shenzhen Anbotek Compliance Laboratory Limited.

Date of Receipt

Aug. 05, 2022

Date of Test

Aug. 05~Aug. 18, 2022

Prepared By

Tu Tu Hong

(TuTu Hong)

Approved & Authorized Signer

Kingkong Jin

(Kingkong Jin)



Revision History

Report Version	Description	Issued Date
R00	Original Issue.	Aug. 23, 2022



1. General Information

1.1. Client Information

Applicant	:	GCteq Wireless(shenzhen) Co., Ltd
Address	:	No. A402, Floor 4, Suojia Science park Complex Building, Sanwei Community, Hangcheng Street, Bao 'an District, Shenzhen City, Guangdong Province China
Manufacturer	:	GCteq Wireless(shenzhen) Co., Ltd
Address	:	No. A402, Floor 4, Suojia Science park Complex Building, Sanwei Community, Hangcheng Street, Bao 'an District, Shenzhen City, Guangdong Province China
Factory	:	TEN PAO EIECTRONICS(HUIZHOU) Co.,LTD.
Address	:	Dongjiang industrial Estate, shuikou Street, Huizhou City, Guangdong Province, P.R.C China

1.2. Description of Device (EUT)

Product Name	:	Embedded intelligent multi-functional charger
Model No.	:	GF-04 PRO
Trade Mark	:	GCteq
Test Power Supply	:	AC 120V, 60Hz for adapter
Test Sample No.	:	1-2-1(Normal Sample), 1-2-2(Engineering Sample)
Adapter	:	N/A
RF Specification		
Operation Frequency	:	115-205KHz
Modulation Type	:	FSK
Antenna Type	:	Inductive loop coil Antenna
Antenna Gain(Peak)	:	0 dBi (Provided by customer)
Remark: 1) For a more detailed features description, please refer to the manufacturer's specifications or the User's Manual.		



1.3. Auxiliary Equipment Used During Test

Description	Rating(s)
Adapter	M/N: DQS751-240300-2 Input: AC 100-240V, ~50-60Hz 0.2A Max Output: DC 24V 3A
Wireless charging load	Manufacturer: Shenzhen Ouju Technology Co., Ltd. M/N: CD2577 Power: 5W/7.5W/10W/15W Last Cal.: Oct. 26, 2020 Cal. Interval: 1 Year

1.4. Description of Test Modes

To investigate the maximum EMI emission characteristics generates from EUT, the test system was pre-scanning tested base on the consideration of following EUT operation mode or test configuration mode which possible have effect on EMI emission level. Each of these EUT operation mode(s) or test configuration mode(s) mentioned above was evaluated respectively.

Pretest Mode	Description
Mode 1	WPT Mode Mode
Mode 2	WPT + USB-A output Mode
Mode 3	WPT + Type-C output Mode
Mode 4	WPT + USB-A + Type-C output Mode

For Conducted Emission	
Final Test Mode	Description
Mode 1	WPT Mode Mode
Mode 2	WPT + USB-A output Mode
Mode 3	WPT + Type-C output Mode
Mode 4	WPT + USB-A + Type-C output Mode



For Radiated Emission	
Final Test Mode	Description
Mode 1	WPT Mode Mode
Mode 2	WPT + USB-A output Mode
Mode 3	WPT + Type-C output Mode
Mode 4	WPT + USB-A + Type-C output Mode

Note:

(1) Test channel is 0.1275MHz.

(2) All the situation(full load, half load and empty load) has been tested,only the worst situation (full load 15W (Mode 1)) was recorded in the report.



1.5. Description Of Test Setup

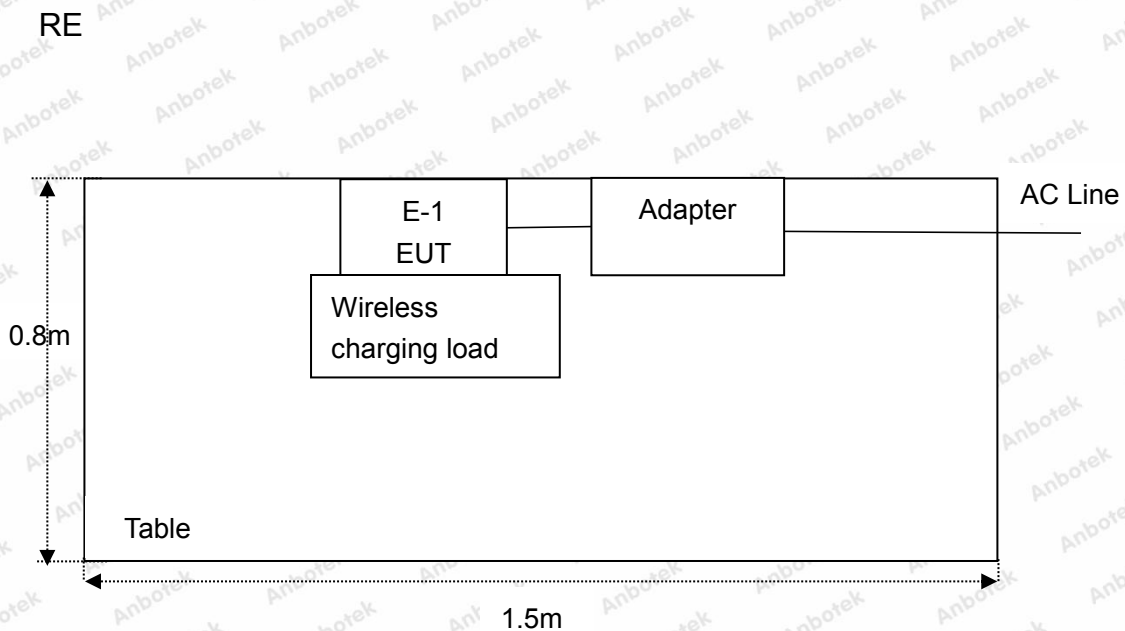
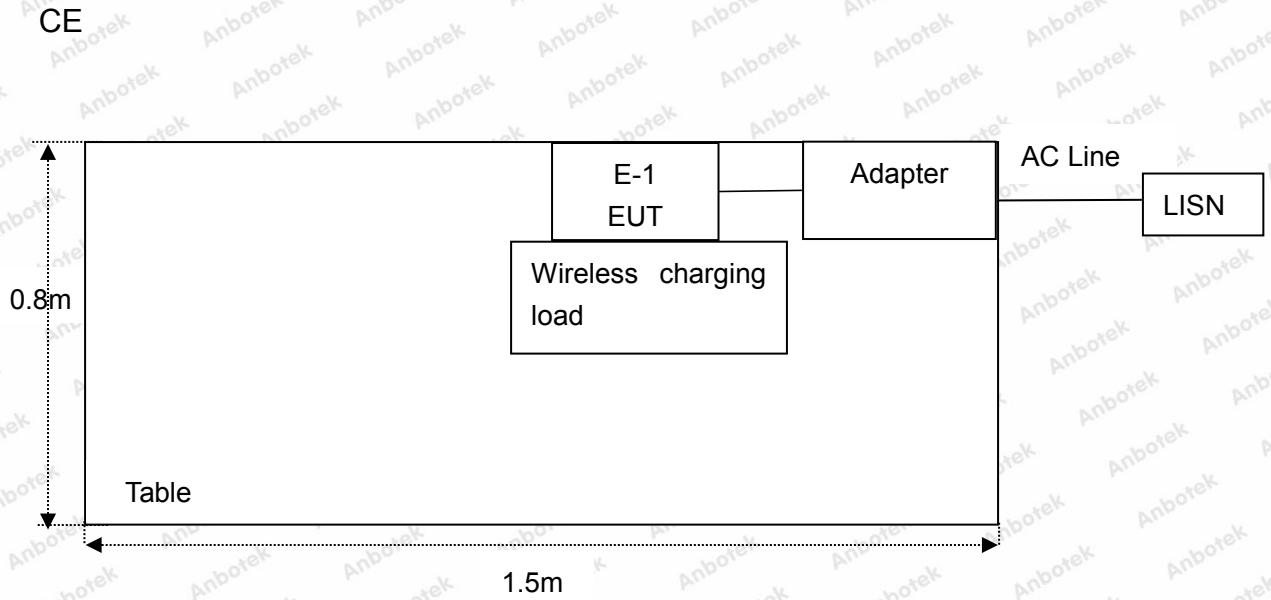

1.6. Test Equipment List

Item	Equipment	Manufacturer	Model No.	Serial No.	Last Cal.	Cal. Interval
1.	Three Phase V-type Artificial Power Network	CYBERTEK	EM5040DT	E215040DT001	Jul 05, 2022	1 Year
2.	EMI Test Receiver	Rohde & Schwarz	ESCI	100627	Oct. 22, 2021	1 Year
3.	EMI Test Receiver	Rohde & Schwarz	ESR26	101481	Oct. 22, 2021	1 Year
4.	RF Switching Unit	Compliance Direction	RSU-M2	38303	Oct. 22, 2021	1 Year
5.	MAX Spectrum Analysis	Agilent	N9020A	MY51170037	Oct. 22, 2021	1 Year
6.	Preamplifier	SKET Electronic	BK1G18G30 D	KD17503	Oct. 22, 2021	1 Year
7.	Double Ridged Horn Antenna	Instruments corporation	GTH-0118	351600	Oct. 22, 2021	2 Year
8.	Bilog Broadband Antenna	Schwarzbeck	VULB9163	VULB 9163-289	Oct. 22, 2021	2 Year
9.	Loop Antenna	Schwarzbeck	FMZB1519B	00053	Oct. 22, 2021	2 Year
10.	Horn Antenna	A-INFO	LB-180400-K F	J211060628	Oct. 22, 2021	2 Year
11.	Pre-amplifier	SONOMA	310N	186860	Oct. 22, 2021	1 Year
12.	EMI Test Software EZ-EMC	SHURPLE	N/A	N/A	N/A	N/A
13.	RF Test Control System	YIHENG	YH3000	2017430	Oct. 22, 2021	1 Year
14.	Power Sensor	DAER	RPR3006W	15I00041SN045	Oct. 22, 2021	1 Year
15.	Power Sensor	DAER	RPR3006W	15I00041SN046	Oct. 22, 2021	1 Year
16.	MXA Spectrum Analysis	KEYSIGHT	N9020A	MY53280032	Oct. 22, 2021	1 Year
17.	MXG RF Vector Signal Generator	Agilent	N5182A	MY48180656	Oct. 22, 2021	1 Year
18.	Signal Generator	Agilent	E4421B	MY41000743	Oct. 22, 2021	1 Year
19.	DC Power Supply	IVYTECH	IV3605	1804D360510	Oct. 22, 2021	1 Year
20.	Constant Temperature Humidity Chamber	ZHONGJIAN	ZJ-KHWS80 B	N/A	Oct. 22, 2021	1 Year



1.7. Measurement Uncertainty

Radiation Uncertainty	:	Ur = 3.9 dB (Horizontal)
	:	Ur = 3.8 dB (Vertical)
Conduction Uncertainty	:	Uc = 3.4 dB

1.8. Description of Test Facility

The test facility is recognized, certified, or accredited by the following organizations:

FCC-Registration No.: 184111

Shenzhen Anbotek Compliance Laboratory Limited, EMC Laboratory has been registered and fully described in a report filed with the (FCC) Federal Communications Commission. The acceptance letter from the FCC is maintained in our files. Registration No. 184111.

ISED-Registration No.: 8058A

Shenzhen Anbotek Compliance Laboratory Limited, EMC Laboratory has been registered and fully described in a report filed with the (ISED) Innovation, Science and Economic Development Canada. The acceptance letter from the ISED is maintained in our files. Registration 8058A.

Test Location

Shenzhen Anbotek Compliance Laboratory Limited.

1/F, Building D, Sogood Science and Technology Park, Sanwei community, Hangcheng Street, Bao'an District, Shenzhen, Guangdong, China.518102



2. Summary of Test Results

Standard Section	Test Item	Result
15.203	Antenna Requirement	PASS
15.207	Conducted Emission Test	PASS
15.205/15.209	Spurious Emission	PASS



3. Conducted Emission Test

3.1. Test Standard and Limit

Test Standard	FCC Part15 Section 15.207		
	Frequency	Maximum RF Line Voltage (dBuV)	
		Quasi-peak Level	Average Level
Test Limit	150kHz~500kHz	66 ~ 56 *	56 ~ 46 *
	500kHz~5MHz	56	46
	5MHz~30MHz	60	50

Remark: (1) *Decreasing linearly with logarithm of the frequency.
 (2) The lower limit shall apply at the transition frequency.

3.2. Test Setup

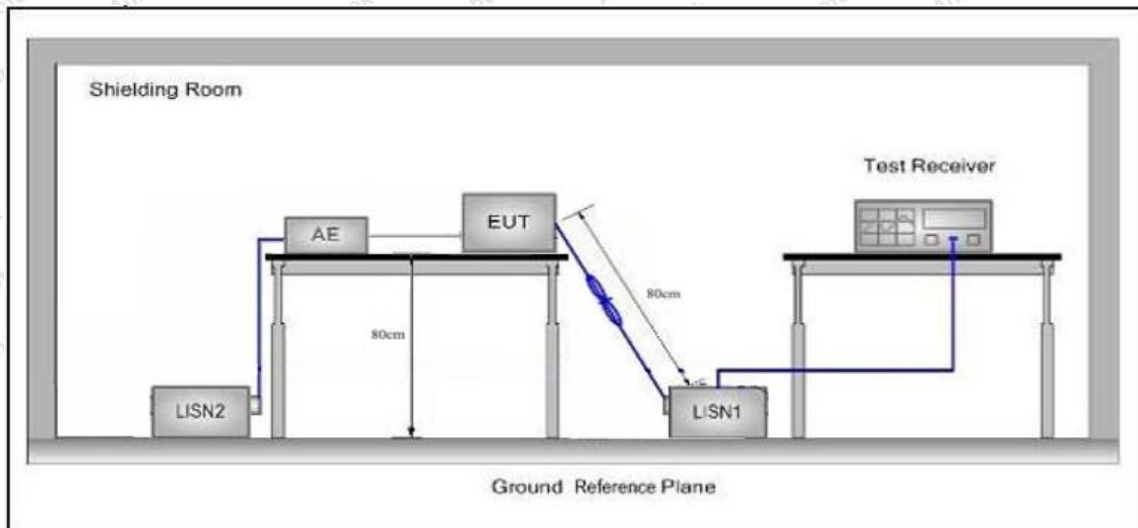

3.3. Test Procedure

The EUT system is connected to the power mains through a line impedance stabilization network (L.I.S.N.). This provides a 50ohm coupling impedance for the EUT system. Please refer the block diagram of the test setup and photographs. Both sides of AC line are checked to find out the maximum conducted emission. In order to find the maximum emission levels, the relative positions of equipment and all of the interface cables shall be changed according to FCC ANSI C63.10: 2020 on Conducted Emission Measurement.

The bandwidth of test receiver (ESCI) set at 9kHz.

The frequency range from 150kHz to 30MHz is checked.

3.4. Test Data

AC conducted emission pre-test at both at AC 120V/60Hz and AC 240V/60Hz modes, recorded worst case AC 120V/60Hz.

Only the worst case data was showed in the report, please to see the following pages.



Conducted Emission Test Data

Test Site: 1# Shielded Room
 Operating Condition: Mode 1
 Test Specification: AC 120V, 60Hz for adapter
 Comment: Live Line
 Temp.(°C)/Hum.(%RH): 22.1°C/52%RH

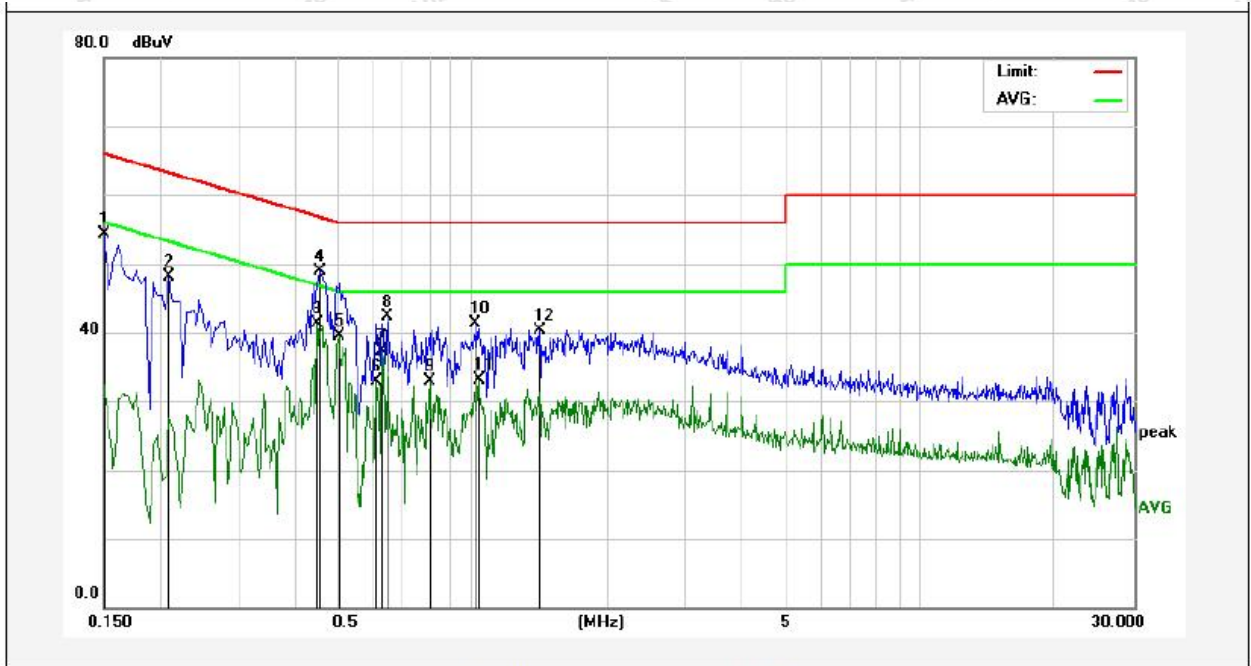

No.	Freq. (MHz)	Reading (dBuV)	Factor (dB)	Result (dBuV)	Limit (dBuV)	Over Limit (dB)	Detector	Remark
1	0.1500	44.65	9.69	54.34	65.99	-11.65	QP	
2	0.2100	38.30	9.71	48.01	63.20	-15.19	QP	
3	0.4500	31.55	9.74	41.29	46.87	-5.58	AVG	
4	0.4580	39.17	9.74	48.91	56.73	-7.82	QP	
5	0.5020	29.75	9.76	39.51	46.00	-6.49	AVG	
6	0.6100	23.23	9.76	32.99	46.00	-13.01	AVG	
7	0.6300	27.51	9.75	37.26	46.00	-8.74	AVG	
8	0.6460	32.50	9.75	42.25	56.00	-13.75	QP	
9	0.8020	23.08	9.75	32.83	46.00	-13.17	AVG	
10	1.0180	31.62	9.74	41.36	56.00	-14.64	QP	
11	1.0339	23.37	9.74	33.11	46.00	-12.89	AVG	
12	1.4140	30.67	9.73	40.40	56.00	-15.60	QP	



Conducted Emission Test Data

Test Site: 1# Shielded Room
 Operating Condition: Mode 1
 Test Specification: AC 120V, 60Hz for adapter
 Comment: Neutral Line
 Temp.(°C)/Hum.(%RH): 22.1°C/52%RH

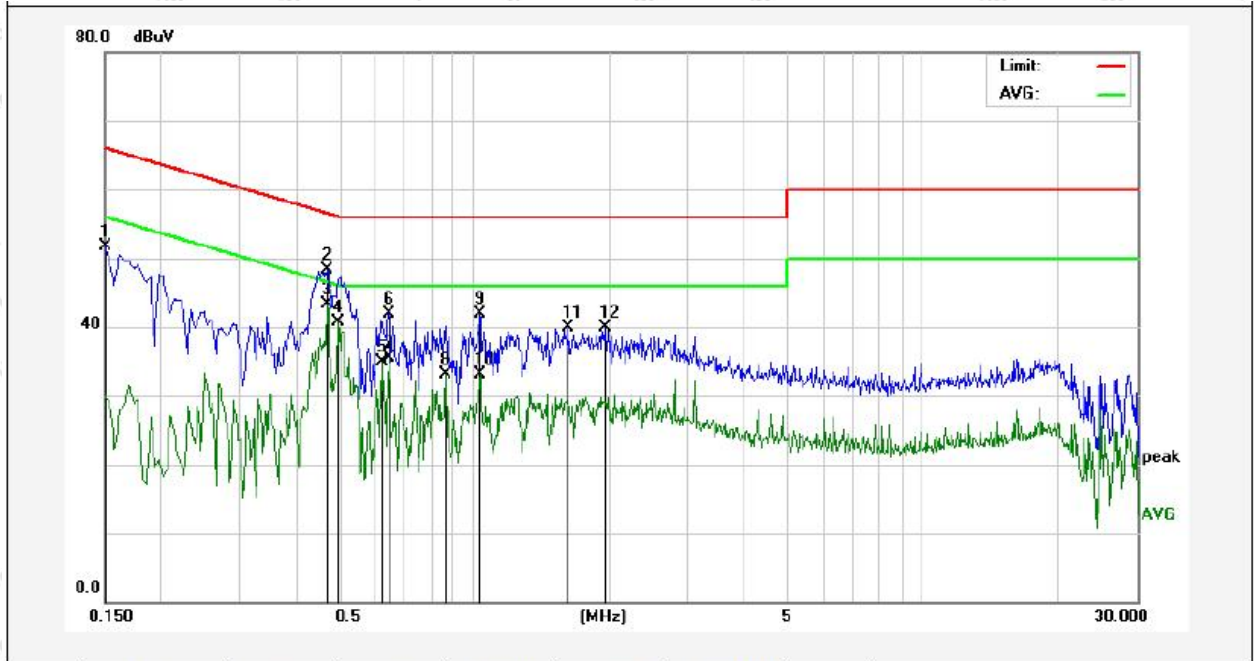

No.	Freq. (MHz)	Reading (dBuV)	Factor (dB)	Result (dBuV)	Limit (dBuV)	Over Limit (dB)	Detector	Remark
1	0.1500	42.10	9.69	51.79	65.99	-14.20	QP	
2	0.4700	38.55	9.75	48.30	56.51	-8.21	QP	
3	0.4700	33.57	9.75	43.32	46.51	-3.19	AVG	
4	0.4980	30.97	9.76	40.73	46.03	-5.30	AVG	
5	0.6260	25.21	9.75	34.96	46.00	-11.04	AVG	
6	0.6460	32.19	9.75	41.94	56.00	-14.06	QP	
7	0.6460	25.80	9.75	35.55	46.00	-10.45	AVG	
8	0.8620	23.27	9.75	33.02	46.00	-12.98	AVG	
9	1.0300	32.09	9.74	41.83	56.00	-14.17	QP	
10	1.0339	23.29	9.74	33.03	46.00	-12.97	AVG	
11	1.6220	30.24	9.73	39.97	56.00	-16.03	QP	
12	1.9540	30.21	9.72	39.93	56.00	-16.07	QP	



4. Radiation Spurious Emission

4.1. Test Standard and Limit

Test Standard	FCC Part15 C Section 15.209 and 15.205				
Test Limit	Frequency (MHz)	Field strength (microvolt/meter)	Limit (dBuV/m)	Remark	Measurement distance (m)
	0.009MHz~0.490MHz	2400/F(kHz)	-	-	300
	0.490MHz-1.705MHz	24000/F(kHz)	-	-	30
	1.705MHz-30MHz	30	-	-	30
	30MHz~88MHz	100	40.0	Quasi-peak	3
	88MHz~216MHz	150	43.5	Quasi-peak	3
	216MHz~960MHz	200	46.0	Quasi-peak	3
	960MHz~1000MHz	500	54.0	Quasi-peak	3
	Above 1000MHz	500	54.0	Average	3
-		-	74.0	Peak	3

Remark:

(1)The lower limit shall apply at the transition frequency.

(2) 15.35(b), Unless otherwise specified, the limit on peak radio frequency emissions is 20dB above the maximum permitted average emission limit applicable to the equipment under test. This peak limit applies to the total peak emission level radiated by the device.

4.2. Test Setup

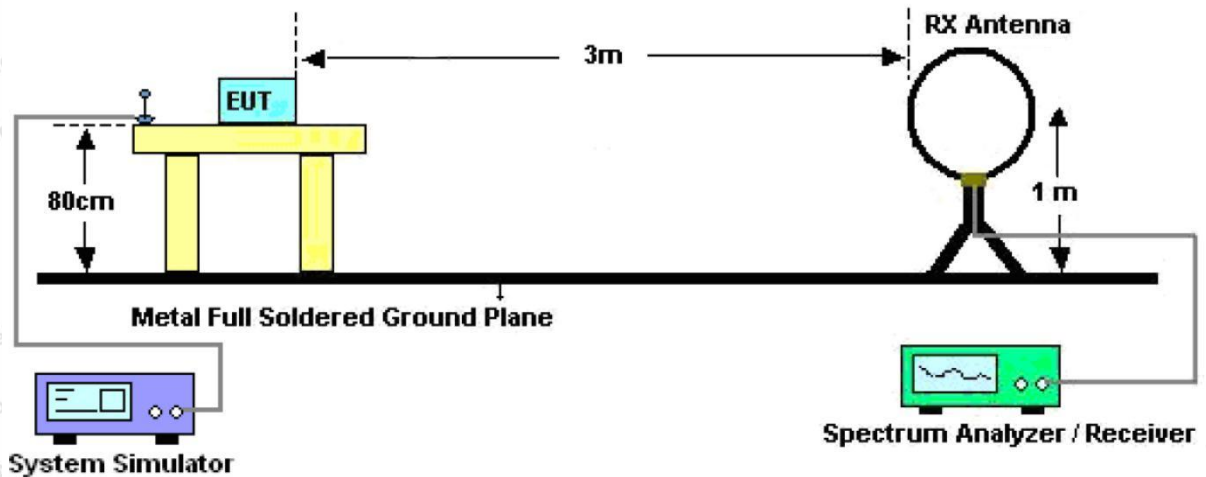

Figure 1. Below 30MHz



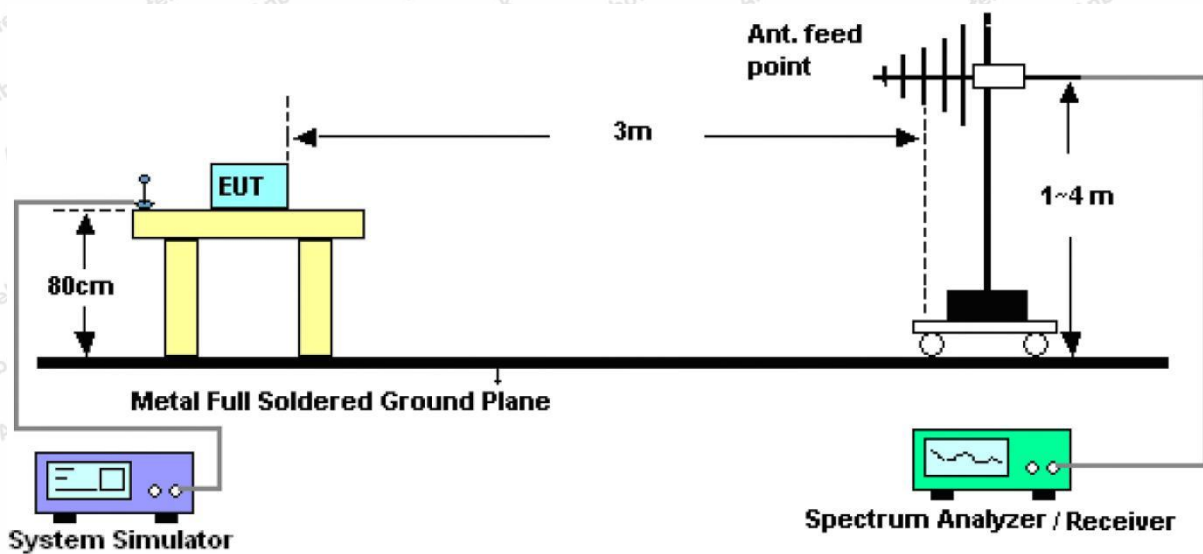

Figure 2. 30MHz to 1GHz

4.3. Test Procedure

For below 1GHz: The EUT is placed on a turntable, which is 0.8m above the ground plane.

The turn table can rotate 360 degrees to determine the position of the maximum emission level. The EUT is set 3 meters away from the receiving antenna which is mounted on a antenna tower. The antenna can be moved up and down from 1 to 4 meters to find out the maximum emission level. Rotated the EUT through three orthogonal axes to determine the maximum emissions, both horizontal and vertical polarization of the antenna are set on test. The EUT is tested in 9*6*6 Chamber. The device is evaluated in xyz orientation.

For 9kHz to 150kHz, Set the spectrum analyzer as:

RBW = 200Hz, VBW = 1kHz, Detector= Quasi-Peak, Trace mode= Max hold, Sweep- auto couple.

For 150kHz to 30MHz, Set the spectrum analyzer as:

RBW = 9KHz, VBW = 30kHz, Detector= Quasi-Peak, Trace mode= Max hold, Sweep- auto couple.

For 30MHz to 1000MHz, Set the spectrum analyzer as:

RBW = 100kHz, VBW = 300kHz, Detector= Quasi-Peak, Trace mode= Max hold, Sweep- auto couple.

4.4. Test Data

PASS

During the test, Pre-scan all kind of the place mode (X-axis, Y-axis, Z-axis), and found the X-axis is the worst case.



Test Results (Between 9KHz – 150KHz)

Test Mode: Mode 1
 Distance: 3m
 Power Source: AC 120V, 60Hz for adapter
 Temp.(°C)/Hum.(%RH): 22.5°C/50%RH

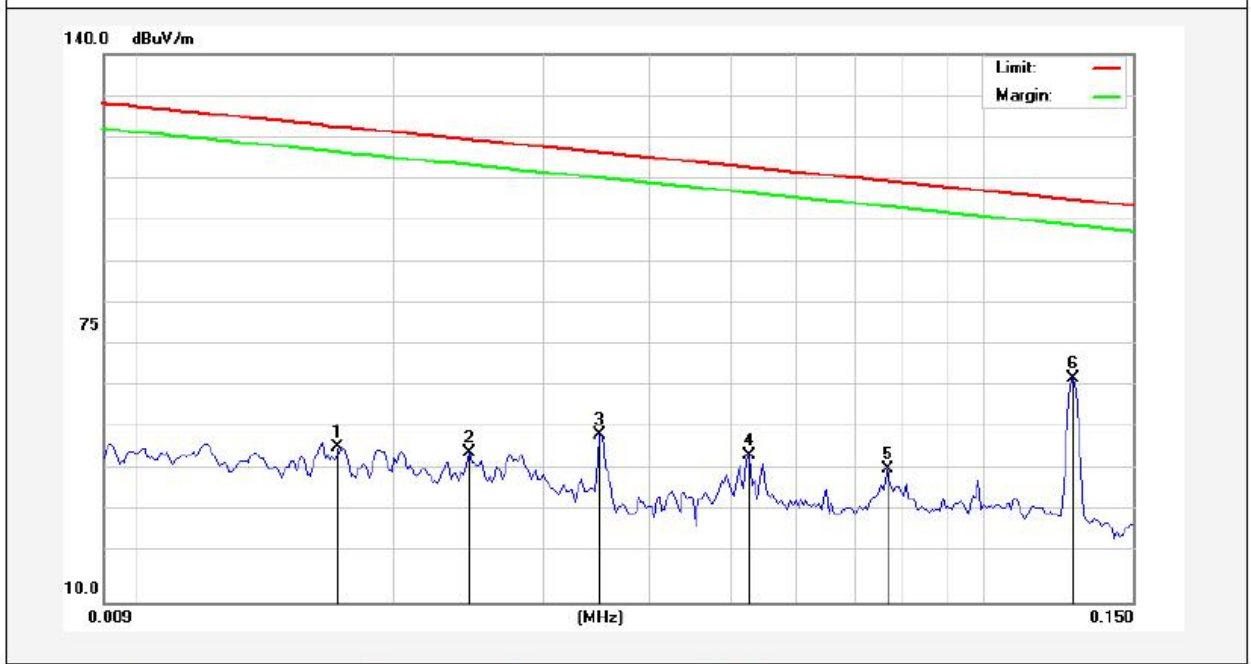

No.	Freq. (MHz)	Reading (dBuV)	Factor (dB/m)	Result (dBuV/m)	Limit (dBuV/m)	Over Limit (dB)	Detector	Height (cm)	degree (deg)	Remark
1	0.0171	26.91	20.14	47.05	122.77	-75.72	AV			
2	0.0244	25.23	20.38	45.61	119.70	-74.09	AV			
3	0.0350	29.20	20.49	49.69	116.58	-66.89	AV			
4	0.0526	24.46	20.38	44.84	113.07	-68.23	AV			
5	0.0767	21.34	20.37	41.71	109.81	-68.10	AV			
6	0.1275	42.89	20.34	63.23	105.42	-42.19	AV			



Test Results (Between 0.15MHz – 30MHz)

Test Mode: Mode 1
 Distance: 3m
 Power Source: AC 120V, 60Hz for adapter
 Temp.(°C)/Hum.(%RH): 22.5°C/50%RH

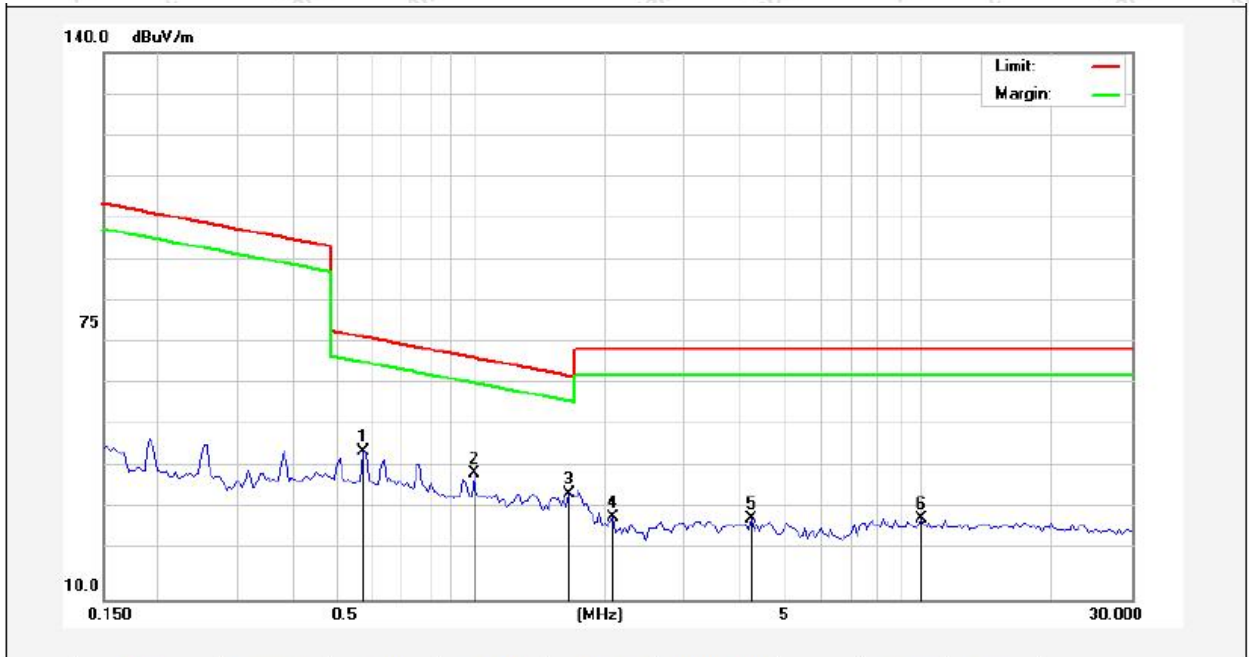

No.	Freq. (MHz)	Reading (dBuV)	Factor (dB/m)	Result (dBuV/m)	Limit (dBuV/m)	Over Limit (dB)	Detector	Height (cm)	degree (deg)	Remark
1	0.5715	25.06	20.28	45.34	72.47	-27.13	QP			
2	1.0100	19.92	20.25	40.17	67.53	-27.36	QP			
3	1.6491	14.95	20.27	35.22	63.29	-28.07	QP			
4	2.0659	9.40	20.28	29.68	69.50	-39.82	QP			
5	4.2240	8.89	20.38	29.27	69.50	-40.23	QP			
6	10.1254	8.98	20.51	29.49	69.50	-40.01	QP			

Remark: According to FCC PART 15.209 (d), the emission limits for the frequency bands 9–90 kHz, 110–490 kHz and above 1000 MHz, Radiated emission limits in these three bands are based on measurements employing an average detector.



Test Results (Between 30MHz –1000 MHz)

Test Mode: Mode 1
 Distance: 3m
 Power Source: AC 120V, 60Hz for adapter
 Polarization: Vertical
 Temp.(°C)/Hum.(%RH): 22.5°C/50%RH

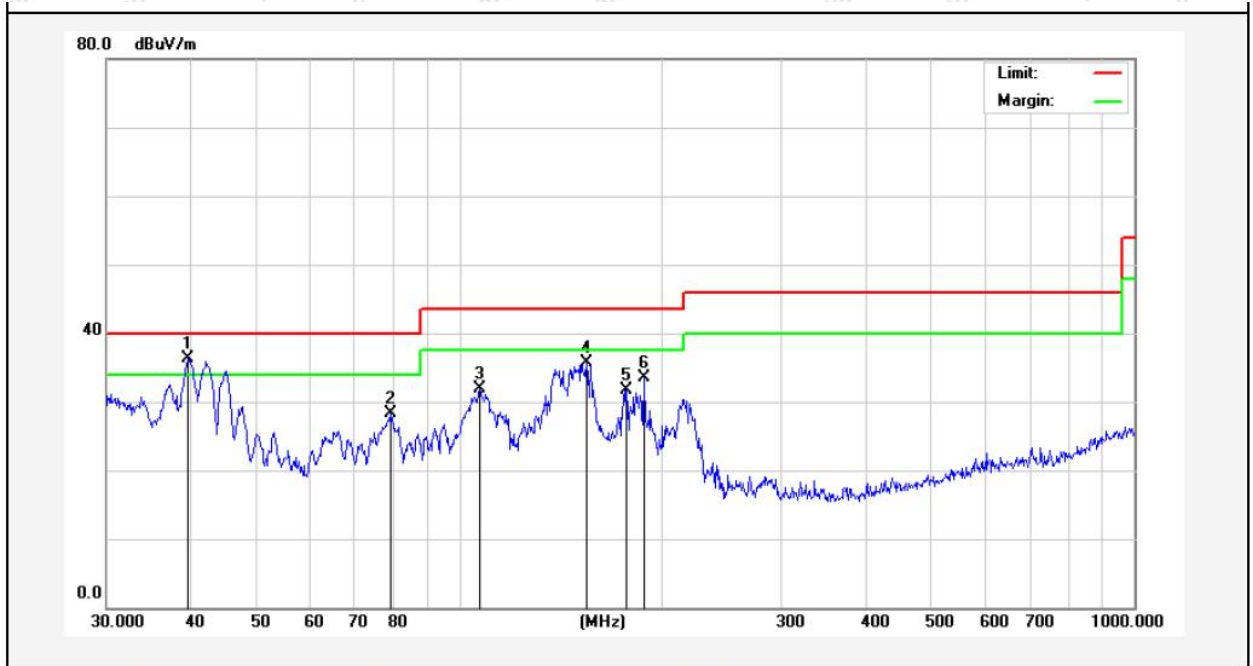

No.	Freq. (MHz)	Reading (dBuV)	Factor (dB/m)	Result (dBuV/m)	Limit (dBuV/m)	Over Limit (dB)	Detector	Height (cm)	degree (deg)	Remark
1	39.5757	51.06	-14.78	36.28	40.00	-3.72	QP			
2	78.9652	47.75	-19.43	28.32	40.00	-11.68	QP			
3	107.1337	49.66	-17.73	31.93	43.50	-11.57	QP			
4	154.2786	57.59	-21.90	35.69	43.50	-7.81	QP			
5	176.8878	52.44	-20.76	31.68	43.50	-11.82	QP			
6	187.7530	53.81	-20.24	33.57	43.50	-9.93	QP			



Test Mode: Mode 1
 Distance: 3m
 Power Source: AC 120V, 60Hz for adapter
 Polarization: Horizontal
 Temp.(°C)/Hum.(%RH): 22.5°C/50%RH



No.	Freq. (MHz)	Reading (dBuV)	Factor (dB/m)	Result (dBuV/m)	Limit (dBuV/m)	Over Limit (dB)	Detector	Height (cm)	degree (deg)	Remark
1	31.2893	49.04	-19.79	29.25	40.00	-10.75	QP			
2	42.8998	39.93	-15.55	24.38	40.00	-15.62	QP			
3	117.7725	50.50	-23.79	26.71	43.50	-16.79	QP			
4	144.3348	56.67	-22.97	33.70	43.50	-9.80	QP			
5	156.4578	56.31	-23.61	32.70	43.50	-10.80	QP			
6	179.3863	50.72	-23.20	27.52	43.50	-15.98	QP			



5. Antenna Requirement

5.1. Test Standard and Requirement

Test Standard	FCC Part15 Section 15.203
Requirement	1) 15.203 requirement: An intentional radiator shall be designed to ensure that no antenna other than that furnished by the responsible party shall be used with the device. The use of a permanently attached antenna or of an antenna that uses a unique coupling to the intentional radiator, the manufacturer may design the unit so that a broken antenna can be replaced by the user, but the use of a standard antenna jack or electrical connector is prohibited.

5.2. Antenna Connected Construction

The antenna is a Inductive loop coil Antenna which permanently attached, and the best case gain of the antenna is 0 dBi. It complies with the standard requirement.



APPENDIX I -- TEST SETUP PHOTOGRAPH

Please refer to separated files Appendix I -- Test Setup Photograph

APPENDIX II -- EXTERNAL PHOTOGRAPH

Please refer to separated files Appendix II -- External Photograph

APPENDIX III -- INTERNAL PHOTOGRAPH

Please refer to separated files Appendix III -- Internal Photograph

----- End of Report -----

