



# FCC TEST REPORT

**Test report  
On Behalf of  
Mei Shun He Electronic Limited  
For  
Multi-function 15W wireless charging 10000mAh power bank  
super charger  
Model No.: WI-061, WP10308, KP-super2, KP-super6**

**FCC ID: 2ATWU-WI061**

**Prepared for :** Mei Shun He Electronic Limited  
301,8th Building,No.69 Xikeng Road, Xikeng Community,Fucheng Street,  
Longhua District,518110, Shenzhen, China

**Prepared By :** Shenzhen HUAKE Testing Technology Co., Ltd.  
1F, B2 Building, Junfeng Zhongcheng Zhizao Innovation Park, Fuhai Street,  
Bao'an District, Shenzhen City, China

**Date of Test:** Sep. 28, 2020 ~ Oct. 13, 2020

**Date of Report:** Oct. 13, 2020

**Report Number:** HK2009272865-1E



### TEST RESULT CERTIFICATION

**Applicant's name** ..... : Mei Shun He Electronic Limited  
301,8th Building,No.69 Xikeng Road, Xikeng  
**Address** ..... : Community,Fucheng Street, Longhua District,518110, Shenzhen,  
China  
**Manufacture's Name**..... : Mei Shun He Electronic Limited  
301,8th Building,No.69 Xikeng Road, Xikeng  
**Address** ..... : Community,Fucheng Street, Longhua District,518110, Shenzhen,  
China

**Product description**

**Trade Mark:** N/A  
**Product name** ..... : Multi-function 15W wireless charging 10000mAh power bank  
super charger  
**Model and/or type reference** : WI-061, WP10308, KP-super2, KP-super6  
**Standards** ..... : FCC Rules and Regulations Part 15 Subpart C (Section 15.209),  
ANSI C63.10: 2013

This publication may be reproduced in whole or in part for non-commercial purposes as long as the Shenzhen HUAK Testing Technology Co., Ltd. is acknowledged as copyright owner and source of the material. Shenzhen HUAK Testing Technology Co., Ltd. takes no responsibility for and will not assume liability for damages resulting from the reader's interpretation of the reproduced material due to its placement and context.

**Date of Test** ..... :  
**Date (s) of performance of tests** ..... : **Sep. 28, 2020 ~ Oct. 13, 2020**  
**Date of Issue**..... : **Oct. 13, 2020**  
**Test Result**..... : **Pass**

Testing Engineer : Gary Qian  
(Gary Qian)

Technical Manager : Eden Hu  
(Eden Hu)

Authorized Signatory : Jason Zhou  
(Jason Zhou)



<b>Table of Contents</b>		<b>Page</b>
1 . TEST SUMMARY		5
1.1 TEST PROCEDURES AND RESULTS		5
1.2 TEST FACILITY		5
1.3 MEASUREMENT UNCERTAINTY		5
2. GENERAL INFORMATION		6
2.1 General Description of EUT		6
2.2. Carrier Frequency of Channels		7
2.3 Operation of EUT during testing		7
2.4 Description of Test Setup		7
2.5 Measurement Instruments List		8
3. CONDUCTED EMISSION TEST		9
3.1 Block Diagram of Test Setup		9
3.2 Conducted Power Line Emission Limit		9
3.3 Test Procedure		9
4. Occupied Bandwidth		12
4.1 Block Diagram of Test Setup		12
4.2 Rules and specifications		12
4.3 Test Procedure		12
4.4 Test Result		13
5. RADIA TED EMISSIONS		14
5.1 Block Diagram of Test Setup		14
5.2 Rules and specifications		15
5.3 Test Procedure		16
5.4 Test Result		16
6 ANTENNA REQUIREMENT		19
7. PHOTOGRAPH OF TEST		20
7.1 Radiated Emission		20
8 PHOTOS OF THE EUT		21



**\*\* Modified History \*\***

<b>Revision</b>	<b>Description</b>	<b>Issued Data</b>	<b>Remark</b>
Revision 1.0	Initial Test Report Release	Oct. 13, 2020	Jason Zhou



## 1. TEST SUMMARY

### 1.1 TEST PROCEDURES AND RESULTS

DESCRIPTION OF TEST	section number	RESULT
CONDUCTED EMISSIONS TEST	15.207	COMPLIANT
RADIATED EMISSION TEST	15.209	COMPLIANT
OCCUPIED BANDWIDTH MEASUREMENT	15.215	COMPLIANT
ANTENNA REQUIREMENT	15.203	COMPLIANT

**Note:**

1. PASS: Test item meets the requirement.
2. Fail: Test item does not meet the requirement.
3. N/A: Test case does not apply to the test object.
4. The test result judgment is decided by the limit of test standard.

### 1.2 TEST FACILITY

Test Firm : Shenzhen HUAKE Testing Technology Co., Ltd.

Address 1F, B2 Building, Junfeng Zhongcheng Zhizao Innovation Park, Fuhai Street, Bao'an District, Shenzhen City, China

### 1.3 MEASUREMENT UNCERTAINTY

Measurement Uncertainty	
Conducted Emission Expanded Uncertainty	= 2.23dB, k=2
Radiated emission expanded uncertainty(9kHz-30MHz)	= 3.08dB, k=2
Radiated emission expanded uncertainty(30MHz-1000MHz)	= 4.42dB, k=2
Radiated emission expanded uncertainty(Above 1GHz)	= 4.06dB, k=2



## 2. GENERAL INFORMATION

### 2.1 General Description of EUT

Equipment	Multi-function 15W wireless charging 10000mAh power bank super charger
Model Name	WI-061
Serial No.	WP10308, KP-super2, KP-super6
Model Difference	All model's the function, software and electric circuit are the same, only with a product model named different. Test sample model: WI-061
Trade Mark	N/A
FCC ID	<b>2ATWU-WI061</b>
Antenna Type	Coil Antenna
Antenna Gain	0dBi
Operation frequency	125KHz
Number of Channels	1
Modulation Type	ASK
Power Source	Input: 100-240V AC 50/60Hz 0.5A Input: Type-C PD 5V DC, 3A/ 9V DC, 2A/ 12V DC, 1.5A Charger mode Output: 5V DC, 3A (Total) Power bank Output: Type-C 5V DC, 3A/ 9V DC, 2.22A/ 12V DC, 1.67A (PD20W) 2*USB 5V DC, 2.4A/ 9V DC, 2A/ 12V DC, 1.5A (QC18W) Total 20W (max) 2150mAh Wireless output: 15W/ 10W/ 7.5W/ 5W Capacity: 3.64V DC, 36.4Wh, Min.: 9600mAh
Power Rating	Input: 100-240V AC 50/60Hz 0.5A Input: Type-C PD 5V DC, 3A/ 9V DC, 2A/ 12V DC, 1.5A Charger mode Output: 5V DC, 3A (Total) Power bank Output: Type-C 5V DC, 3A/ 9V DC, 2.22A/ 12V DC, 1.67A (PD20W) 2*USB 5V DC, 2.4A/ 9V DC, 2A/ 12V DC, 1.5A (QC18W) Total 20W (max) 2150mAh Wireless output: 15W/ 10W/ 7.5W/ 5W Capacity: 3.64V DC, 36.4Wh, Min.: 9600mAh



## 2.2. Carrier Frequency of Channels

Operation Frequency each of channel	
Channel	Frequency
1	125KHz

## 2.3 Operation of EUT during testing

Operating Mode

The mode is used: Transmitting mode

## 2.4 Description of Test Setup

Operation of EUT during testing:

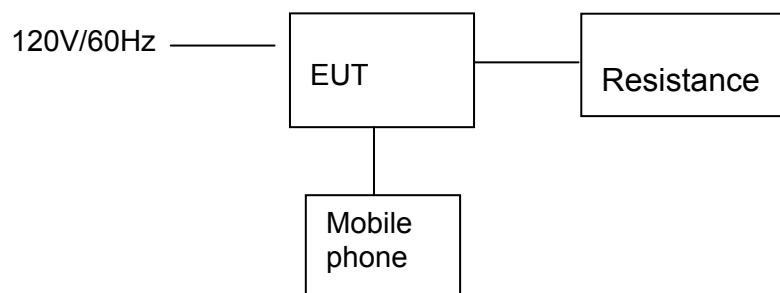

Mobile phones information

Model: S6

Input: 5VDC

Resistance information

Model: R99

Input: 50W 5Ω

The sample was placed (0.8m below 1GHz, 1.5m above 1GHz) above the ground plane of 3m chamber. Measurements in both horizontal and vertical polarities were performed. During the test, each emission was maximized by: having the EUT continuously working, investigated all operating modes, rotated about all 3 axis (X, Y & Z) and considered typical configuration to obtain worst position, manipulating interconnecting cables, rotating the turntable, varying antenna height from 1m to 4m in both horizontal and vertical polarizations. The emissions worst-case are shown in Test Results of the following pages. The worst case is X position



## 2.5 Measurement Instruments List

Item	Equipment	Manufacturer	Model No.	Serial No.	Last Cal.	Cal. Interval
1.	L.I.S.N. Artificial Mains Network	R&S	ENV216	HKE-002	Dec. 26, 2019	1 Year
2.	Receiver	R&S	ESCI 7	HKE-010	Dec. 26, 2019	1 Year
3.	RF automatic control unit	Tonscend	JS0806-2	HKE-060	Dec. 26, 2019	1 Year
4.	Spectrum analyzer	R&S	FSP40	HKE-025	Dec. 26, 2019	1 Year
5.	Spectrum analyzer	Agilent	N9020A	HKE-048	Dec. 26, 2019	1 Year
6.	Preamplifier	Schwarzbeck	BBV 9743	HKE-006	Dec. 26, 2019	1 Year
7.	EMI Test Receiver	Rohde & Schwarz	ESCI 7	HKE-010	Dec. 26, 2019	1 Year
8.	Bilog Broadband Antenna	Schwarzbeck	VULB9163	HKE-012	Dec. 26, 2019	1 Year
9.	Loop Antenna	Schwarzbeck	FMZB 1519 B	HKE-014	Dec. 26, 2019	1 Year
10.	Horn Antenna	Schwarzbeck	9120D	HKE-013	Dec. 26, 2019	1 Year
11.	Pre-amplifier	EMCI	EMC051845 SE	HKE-015	Dec. 26, 2019	1 Year
12.	Pre-amplifier	Agilent	83051A	HKE-016	Dec. 26, 2019	1 Year
13.	EMI Test Software EZ-EMC	Tonscend	JS1120-B Version	HKE-083	Dec. 26, 2019	N/A
14.	Power Sensor	Agilent	E9300A	HKE-086	Dec. 26, 2019	1 Year
15.	Spectrum analyzer	Agilent	N9020A	HKE-048	Dec. 26, 2019	1 Year
16.	Signal generator	Agilent	N5182A	HKE-029	Dec. 26, 2019	1 Year
17.	Signal Generator	Agilent	83630A	HKE-028	Dec. 26, 2019	1 Year
18.	Shielded room	Shiel Hong	4*3*3	HKE-039	Dec. 26, 2019	3 Year





### 3. CONDUCTED EMISSION TEST

#### 3.1 Block Diagram of Test Setup

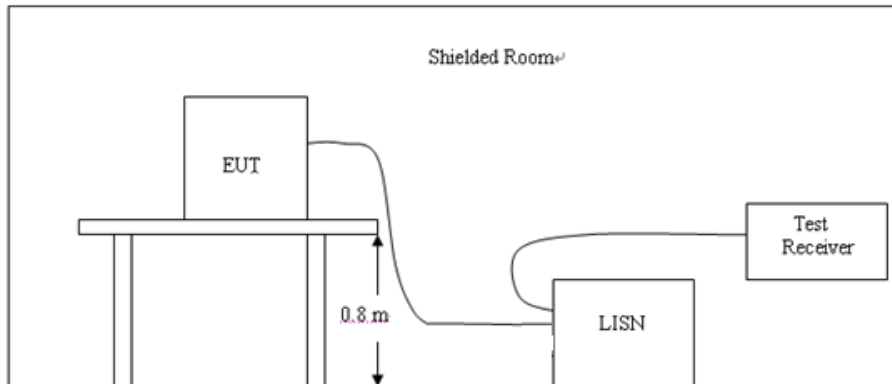

#### 3.2 Conducted Power Line Emission Limit

According to FCC Part 15.207(a)

Frequency (MHz)	Maximum RF Line Voltage (dB $\mu$ V)			
	CLASS A		CLASS B	
	Q.P.	Ave.	Q.P.	Ave.
0.15 - 0.50	79	66	66-56*	56-46*
0.50 - 5.00	73	60	56	46
5.00 - 30.0	73	60	60	50

\* Decreasing linearly with the logarithm of the frequency

For intentional device, according to §15.207 Line Conducted Emission Limit is same as above table.

#### 3.3 Test Procedure

- 1, The equipment was set up as per the test configuration to simulate typical actual usage per the user's manual. The EUT is a tabletop system, a wooden table with a height of 0.8 meters is used and is placed on the ground plane as per ANSI C63.10.
- 2, Support equipment, if needed, was placed as per ANSI C63.10.
- 3, All I/O cables were positioned to simulate typical actual usage as per ANSI C63.10.
- 4, If a EUT received DC power from the USB Port of Notebook PC, the PC's adapter received AC120V/60Hz power through a Line Impedance Stabilization Network (LISN) which supplied power source and was grounded to the ground plane.
- 5, All support equipments received AC power from a second LISN, if any.
- 6, The EUT test program was started. Emissions were measured on each current carrying line of the EUT using a spectrum Analyzer / Receiver connected to the LISN powering the EUT. The LISN has two monitoring points: Line 1 (Hot Side) and Line 2 (Neutral Side). Two scans were taken: one with Line 1 connected to Analyzer / Receiver and Line 2 connected to a 50 ohm load; the second scan had Line 1 connected to a 50 ohm load and Line 2 connected to the Analyzer / Receiver.
- 7, Analyzer / Receiver scanned from 150 KHz to 30MHz for emissions in each of the test modes



### 3.4 Test Result

PASS

All the test modes completed for test. only the worst result was reported as below:

Test Specification: Line

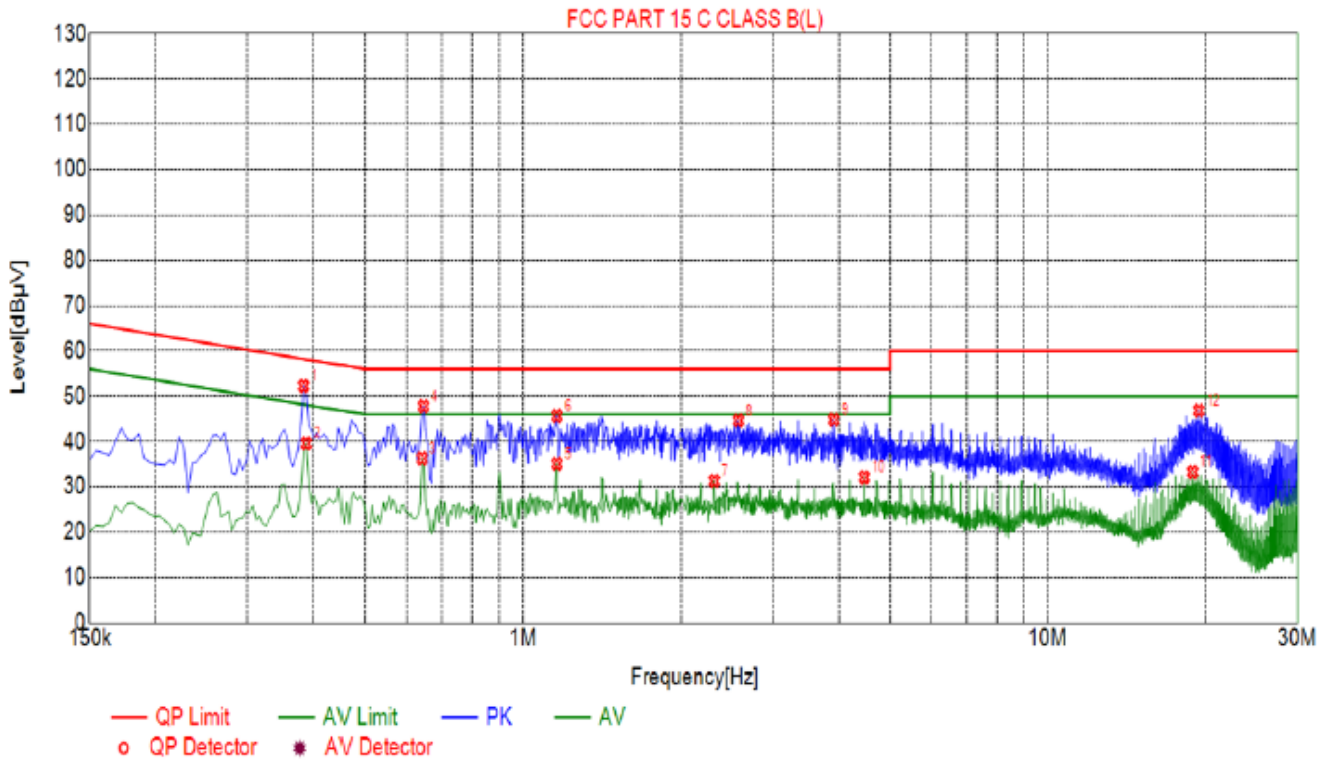

Suspected List								
NO.	Freq. [MHz]	Level [dBµV]	Factor [dB]	Limit [dBµV]	Margin [dB]	Reading [dBµV]	Detector	Type
1	0.3840	52.28	20.04	58.19	5.91	32.24	PK	L
2	0.3885	39.60	20.04	48.10	8.50	19.56	AV	L
3	0.6405	36.28	20.05	46.00	9.72	16.23	AV	L
4	0.6450	47.80	20.05	56.00	8.20	27.75	PK	L
5	1.1580	35.12	20.09	46.00	10.88	15.03	AV	L
6	1.1580	45.68	20.09	56.00	10.32	25.59	PK	L
7	2.3145	31.31	20.18	46.00	14.69	11.13	AV	L
8	2.5710	44.68	20.20	56.00	11.32	24.48	PK	L
9	3.9120	44.85	20.25	56.00	11.15	24.60	PK	L
10	4.4700	32.12	20.25	46.00	13.88	11.87	AV	L
11	18.9195	33.27	20.06	50.00	16.73	13.21	AV	L
12	19.4460	46.86	20.08	60.00	13.14	26.78	PK	L

Remark: Margin = Limit - Level

Correction factor = Cable lose + LISN insertion loss

Level=Test receiver reading + correction factor



Test Specification: Neutral

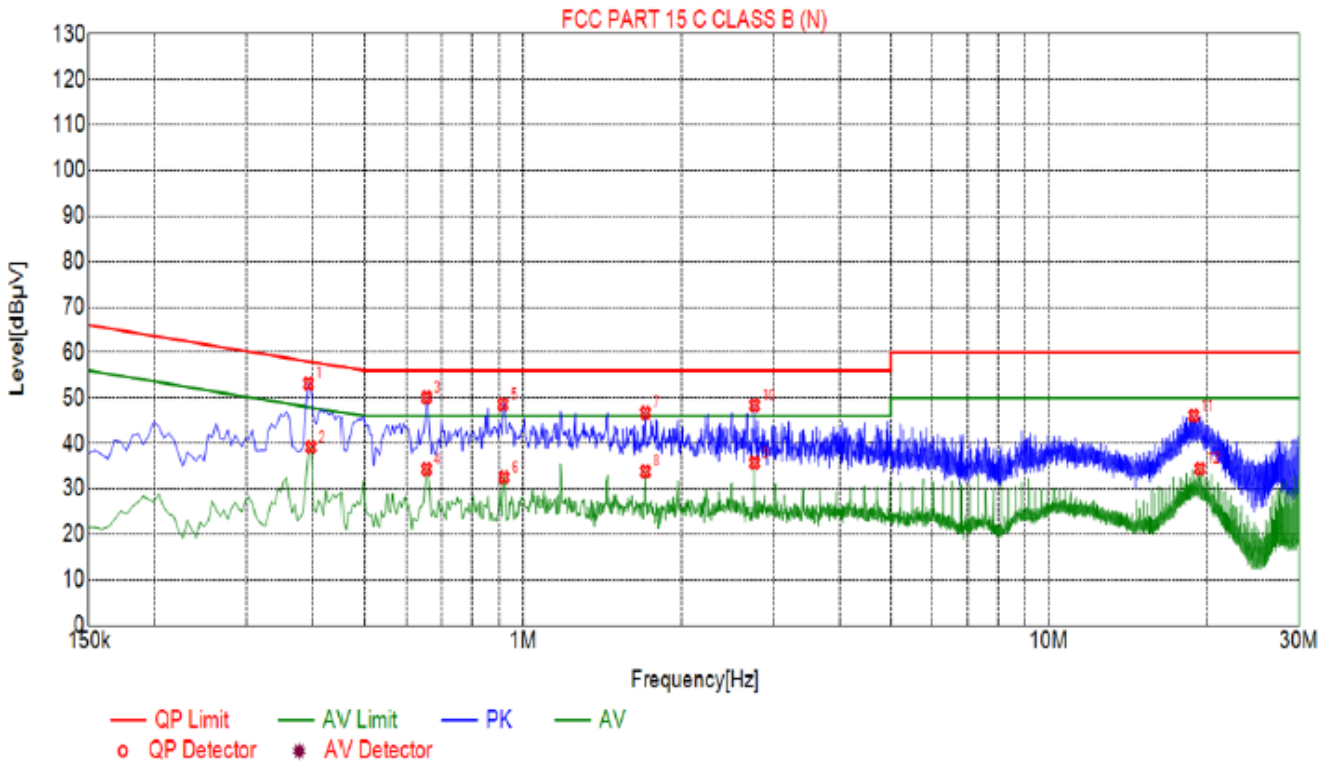

Suspected List								
NO.	Freq. [MHz]	Level [dBµV]	Factor [dB]	Limit [dBµV]	Margin [dB]	Reading [dBµV]	Detector	Type
1	0.3930	53.15	20.04	58.00	4.85	33.11	PK	N
2	0.3975	39.19	20.04	47.91	8.72	19.15	AV	N
3	0.6540	50.09	20.05	56.00	5.91	30.04	PK	N
4	0.6540	34.35	20.05	46.00	11.65	14.30	AV	N
5	0.9150	48.64	20.06	56.00	7.36	28.58	PK	N
6	0.9195	32.55	20.06	46.00	13.45	12.49	AV	N
7	1.7070	46.76	20.13	56.00	9.24	26.63	PK	N
8	1.7070	33.82	20.13	46.00	12.18	13.69	AV	N
9	2.7555	35.73	20.21	46.00	10.27	15.52	AV	N
10	2.7555	48.41	20.21	56.00	7.59	28.20	PK	N
11	18.8970	46.14	20.06	60.00	13.86	26.08	PK	N
12	19.4235	34.43	20.08	50.00	15.57	14.35	AV	N

Remark: Margin = Limit - Level

Correction factor = Cable lose + LISN insertion loss

Level=Test receiver reading + correction factor

## 4. Occupied Bandwidth

### 4.1 Block Diagram of Test Setup

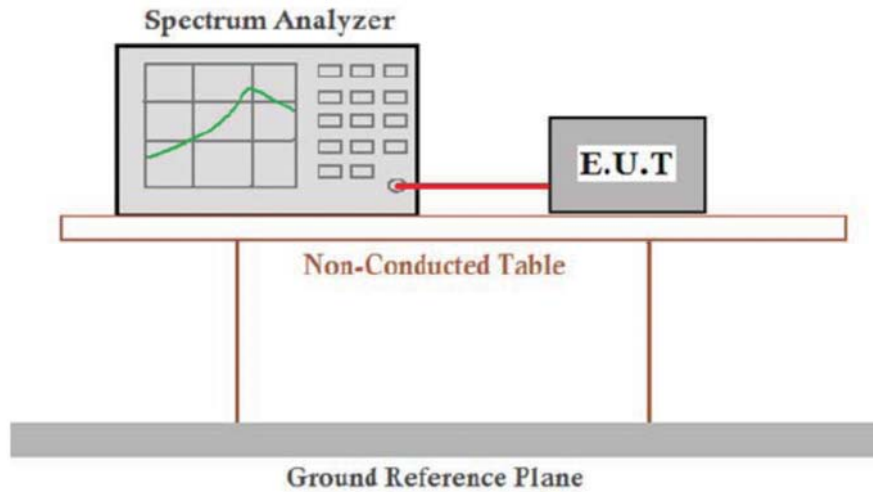

### 4.2 Rules and specifications

CFR 47 Part 15.215(c)

ANSI C63.10-2013

### 4.3 Test Procedure

Intentional radiators operating under the alternative provisions to the general emission limits, as contained in §§15.217 through 15.257 and in subpart E of this part, must be designed to ensure that 20dB bandwidth of the emission, or whatever bandwidth may otherwise be specified in the specific rule section under which the equip compliance with the 20dB attenuation specification may base on measurement at the intentional radiator's antenna output terminal unless the intentional radiator uses a permanently attached antenna, in which case compliance shall be demonstrated by measuring the radiated emissions.



4.4 Test Result  
PASS

Mode	Freq (KHz)	20dB Bandwidth (KHz)	Limit (kHz)	Conclusion
Tx Mode	125	2.853	/	PASS

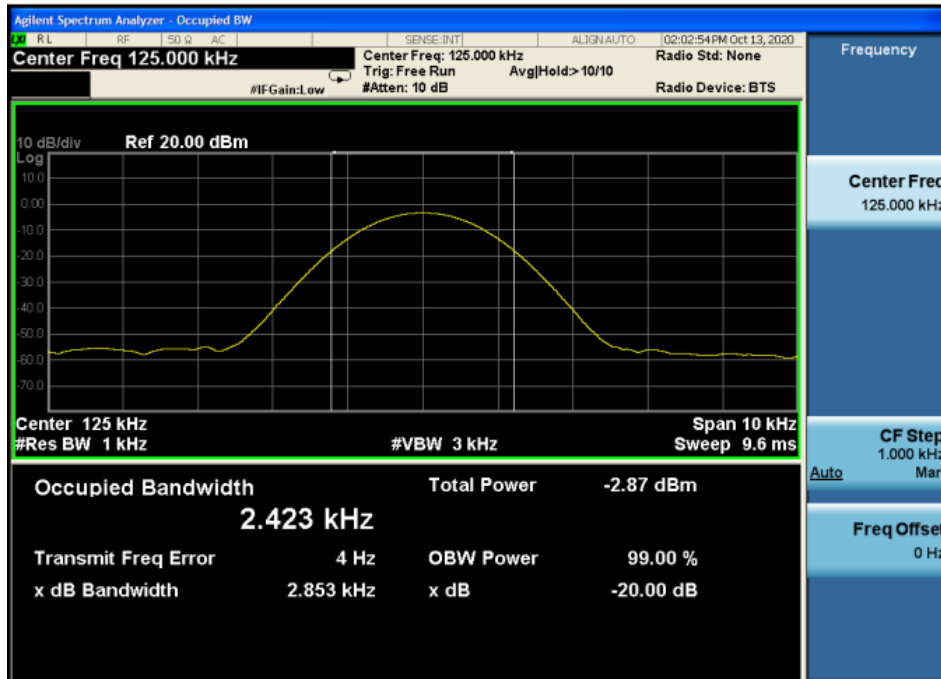

## 5. RADIA TED EMISSIONS

### 5.1 Block Diagram of Test Setup

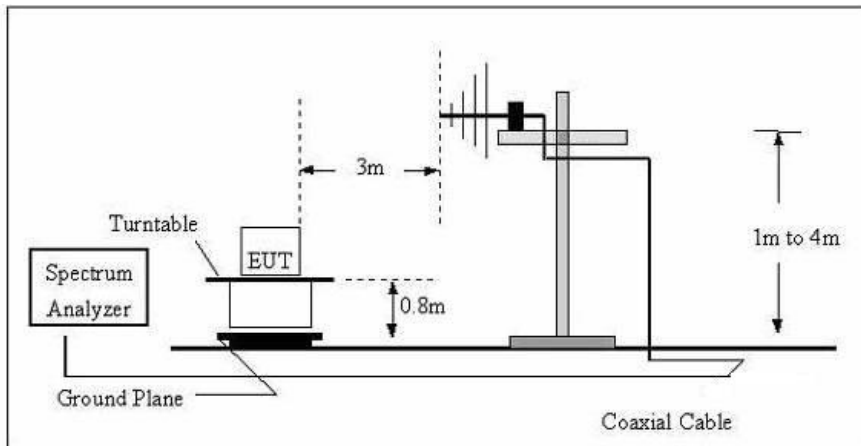
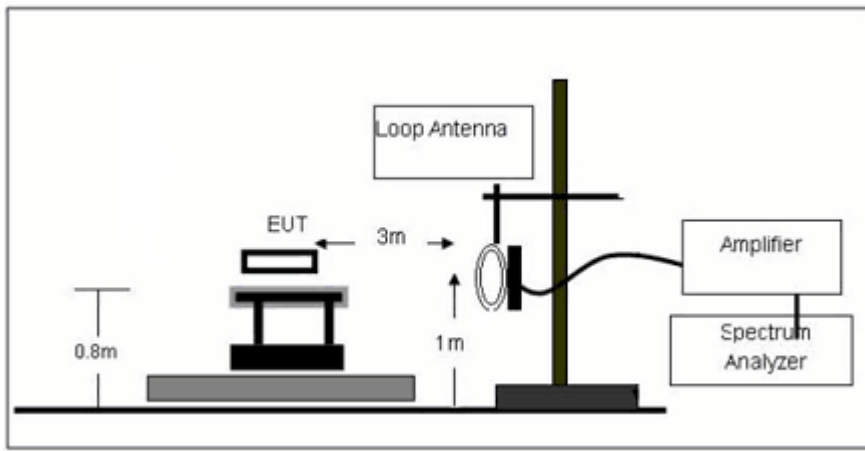



### 5.2 Rules and specifications

CFR 47 Part 15, section 15.205

Only spurious emissions are permitted in any of the frequency bands listed the tables in these sections.

MHz	MHz	MHz	GHz
0.090-0.110	16.42-16.423	399.9-410	4.5-5.15
1\ 0.495-0.505	16.69475-16.69525	608-614	5.35-5.46
2.1735-2.1905	16.80425-16.80475	960-1240	7.25-7.75
4.125-4.128	25.5-25.67	1300-1427	8.025-8.5
4.17725-4.17775	37.5-38.25	1435-1626.5	9.0-9.2
4.20725-4.20775	73-74.6	1645.5-1646.5	9.3-9.5
6.215-6.218	74.8-75.2	1660-1710	10.6-12.7
6.26775-6.26825	108-121.94	1718.8-1722.2	13.25-13.4
6.31175-6.31225	123-138	2200-2300	14.47-14.5
8.291-8.294	149.9-150.05	2310-2390	15.35-16.2
8.362-8.366	156.52475-156.52525	2483.5-2500	17.7-21.4
8.37625-8.38675	156.7-156.9	2690-2900	22.01-23.12
8.41425-8.41475	162.0125-167.17	3260-3267	23.6-24.0
12.29-12.293	167.72-173.2	3332-3339	31.2-31.8
12.51975-12.52025	240-285	3345.8-3358	36.43-36.5
12.57675-12.57725	322-335.4	3600-4400	(2)
13.36-13.41			

CFR 47 Part 15, section 15.209

The emissions from an intentional radiator shall not exceed the limits in the tables in these sections using an average detector

Frequency (MHz)	Field strength (microvolts/meter)	Measurement distance (meters)
0.009–0.490	2400/F (kHz)	300
0.490–1.705	24000/F (kHz)	30
1.705–30.0	30	30
30–88	100**	3
88–216	150**	3
216–960	200**	3
Above 960	500	3

Limit calculation and transfer to 3m distance as showed in the following table:

Frequency (MHz)	Limit (dBuV/m)	Distance (m)
0.009-0.490	$20\log(2400/F(KHz))+40\log(300/3)$	3
0.490-1.705	$20\log(24000/F(KHz))+40\log(30/3)$	3
1.705-30.0	69.5	3
30-88	40.0	3
88-216	43.5	3
216-960	46.0	3
Above 960	54.0	3

CFR 47 Part 15, section 15.35

When average radiated emission measurements are specified, the limit on the peak level of the radio Frequency emission is 20dB above the maximum permitted average emission limit.

Transmitter Spurious Emissions 9KHz-30MHz			
	9-150KHz	150-490KHz	490KHz-30MHz
Resolution Bandwidth	200Hz	9KHz	9KHz
Video Bandwidth	600Hz	30KHz	30KHz
Detector	Peak	Peak	Peak
Trace Mode	Max Hold	Max Hold	Max Hold
Sweep Time	Auto	Auto	Auto



### 5.3 Test Procedure

Measurement distance 3m

For the measurement range up to 30MHz in the following plots the field strength result from 3m Distance measurement are extrapolated to 300m and 30m distance respectively, by 40dB/decade, According to part 15.31(f)(2), per antenna factor scaling.

Measurements below 1000MHz are performed with a peak detector and compared to average limits, Measurements with an average detector are not required.

Note:

For battery operated equipment, the equipment tests shall be performed using a new battery.

### 5.4 Test Result

PASS

Note: this EUT was tested for all models and the worst case model (DC9V) data was reported.

For 9KHz-30MHz

Freq. (MHz)	Detector Mode (PK/QP/AV)	Reading (dBuV)	Factor (dB)	Actual FS (dBuV/m)	Limits 3m (dBuV/m)	Margin (dBuV/m)
0.110	AV	22.52	24.8	47.32	106.66	59.34
0.125	AV	45.13	24.8	69.93	105.51	35.58
0.486	AV	26.23	25.03	51.26	93.46	42.2
0.500	Peak	27.42	25.03	52.45	73.32	20.87





For 30MHz-1GHz

Antenna polarity: H

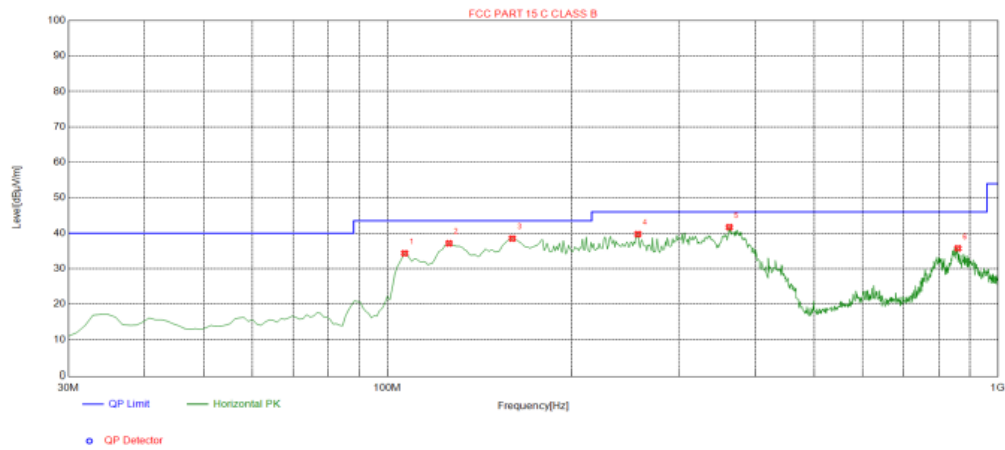

Suspected List									
NO.	Freq. [MHz]	Factor [dB]	Reading [dBµV/m]	Level [dBµV/m]	Limit [dBµV/m]	Margin [dB]	Height [cm]	Angle [°]	Polarity
1	106.7067	-15.42	49.75	34.33	43.50	9.17	100	186	Horizontal
2	126.1261	-18.00	55.14	37.14	43.50	6.36	100	359	Horizontal
3	160.1101	-18.21	56.71	38.50	43.50	5.00	100	12	Horizontal
4	257.2072	-13.49	53.24	39.75	46.00	6.25	100	47	Horizontal
5	363.0430	-11.24	52.94	41.70	46.00	4.30	100	238	Horizontal
6	860.1802	-2.46	38.20	35.74	46.00	10.26	100	309	Horizontal

Remark: Factor = Cable loss + Antenna factor – Preamplifier; Level = Reading + Factor; Margin = Limit – Level;



Antenna polarity: V

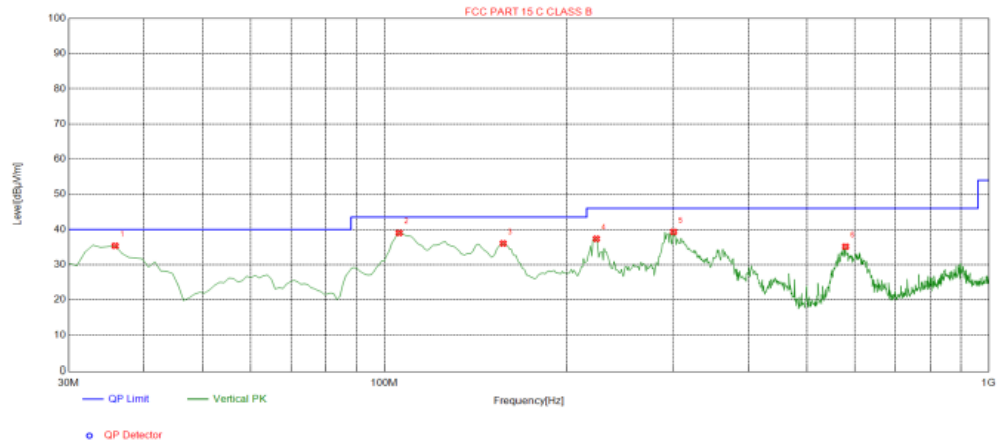

Suspected List									
NO.	Freq. [MHz]	Factor [dB]	Reading [dBµV/m]	Level [dBµV/m]	Limit [dBµV/m]	Margin [dB]	Height [cm]	Angle [°]	Polarity
1	35.8258	-15.88	51.24	35.36	40.00	4.64	100	2	Vertical
2	105.7357	-15.42	54.43	39.01	43.50	4.49	100	251	Vertical
3	157.1972	-18.42	54.45	36.03	43.50	7.47	100	264	Vertical
4	224.1942	-14.46	51.82	37.36	46.00	8.64	100	306	Vertical
5	300.9009	-12.72	52.06	39.34	46.00	6.66	100	348	Vertical
6	579.5696	-6.58	41.71	35.13	46.00	10.87	100	22	Vertical

Remark: Factor = Cable loss + Antenna factor – Pre-amplifier; Level = Reading + Factor; Margin = Limit – Level;

## 6 ANTENNA REQUIREMENT

### Standard Applicable

For intentional device, according to FCC 47 CFR Section 15.203, an intentional radiator shall be designed to ensure that no antenna other than that furnished by the responsible party shall be used with the device.

### Refer to statement below for compliance.

The manufacturer may design the unit so that the user can replace a broken antenna, but the use of a standard antenna jack or electrical connector is prohibited. Further, this requirement does not apply to intentional radiators that must be professionally installed.

### Antenna Connected Construction

The antenna used in this product is a Coil Antenna which permanently attached. It conforms to the standard requirements. The directional gains of antenna used for transmitting is 0dBi.

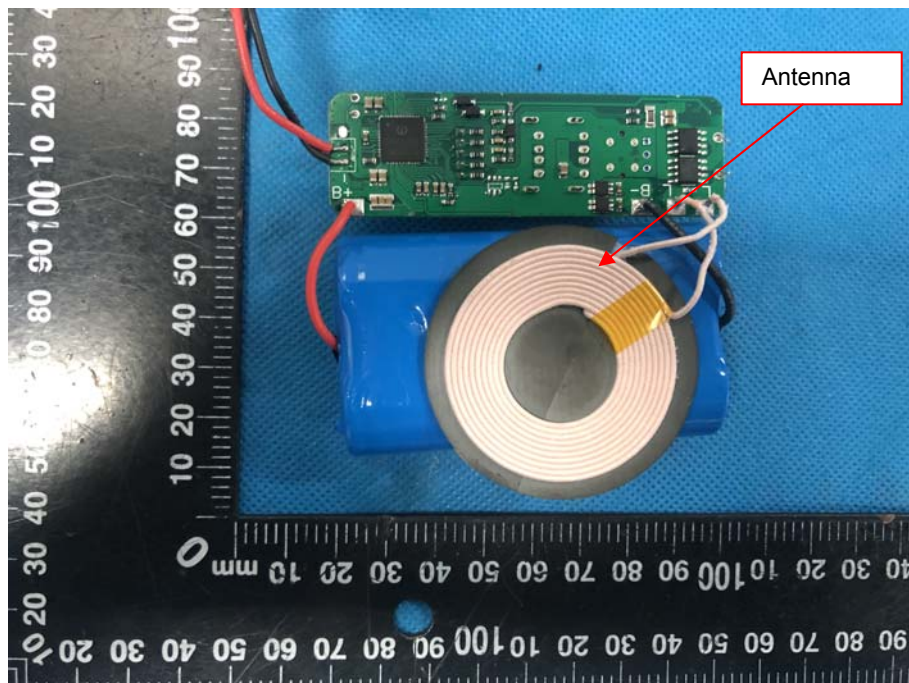

## 7. PHOTOGRAPH OF TEST

### 7.1 Radiated Emission





## 8 PHOTOS OF THE EUT

Reference to the reporter : ANNEX A of external photos and ANNEX B of internal photos

-----End of test report-----