

FCC TEST REPORT

Report No. : NTC-ER2209013
Applicant's name : Shanghai Laisi Information technology Co.,Ltd.
Address : 901,21A No.1158 Zhongxin Road, Songjiang district
Shanghai China

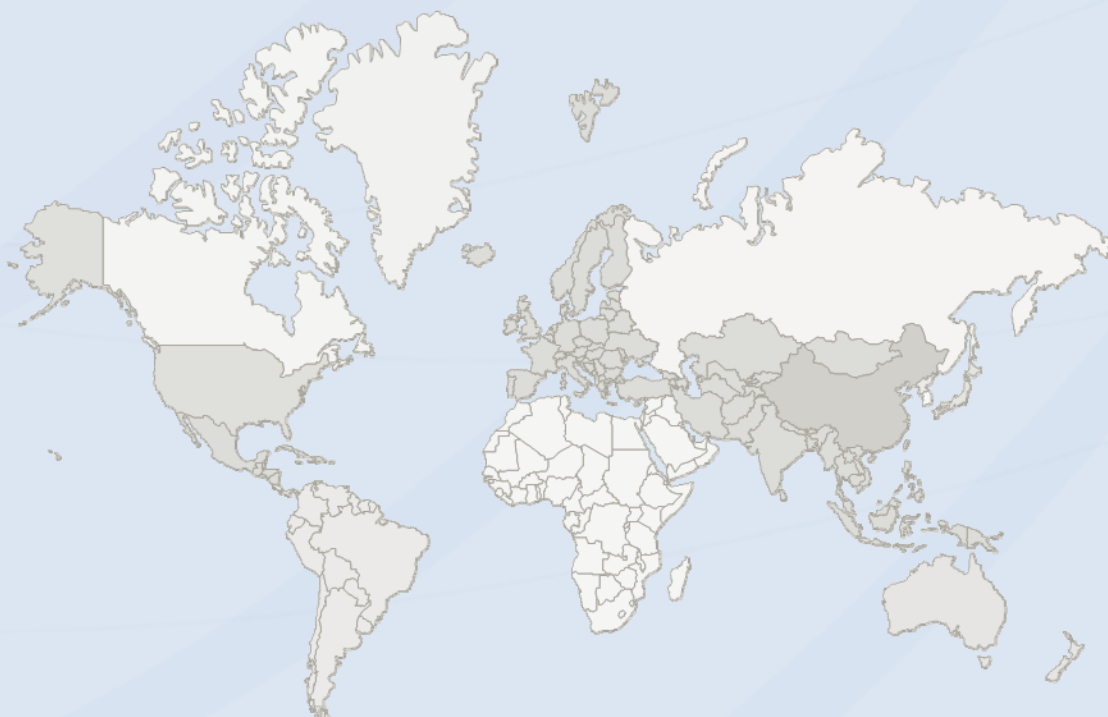

DONGGUAN NEW TESTING CENTRE CO., LTD

©Address: 1F & 3F, No. 1 the 1st North Industry Road Songshan Lake Science & Technology Park Dongguan, People's Republic of China 523808

☎Tel: +86-769-22212079

🌐Web: <http://www.ntc-cert.com>

✉E-mail: dave@ntc-cert.com

TABLE OF CONTENTS

| | |
|---|----|
| Test Report Declare | 3 |
| 1. Summary Of Test Results | 4 |
| 2. General Test Information..... | 4 |
| 2.1. Description of EUT | 4 |
| 2.2. Assistant equipment used for test..... | 6 |
| 2.3. Block diagram EUT configuration for test | 6 |
| 2.4. Test environment conditions | 7 |
| 2.5. Measurement uncertainty..... | 8 |
| 3. Power Line Conducted Emission Test | 9 |
| 3.1. Test equipment | 9 |
| 3.2. Block diagram of test setup..... | 9 |
| 3.3. Power line conducted emission limits (class B) | 9 |
| 3.4. Test procedure | 10 |
| 3.5. Test result | 10 |
| 4. Radiated Emission Test..... | 13 |
| 4.1. Test equipment | 13 |
| 4.2. Block diagram of test setup..... | 14 |
| 4.3. Limit | 16 |
| 4.4. Test procedure | 17 |
| 4.5. Test result | 17 |
| 5. Maximum Peak Output Power | 24 |
| 5.1. Applied procedures / limit | 24 |
| 5.2. Test procedure | 24 |
| 5.3. Deviation from standard..... | 24 |
| 5.4. Test setup | 24 |
| 5.5. Test Results..... | 24 |
| 6. -6dB Bandwidth Test..... | 27 |
| 6.1. Applied procedures / limit | 27 |
| 6.2. Test procedure | 27 |
| 6.3. Deviation from standard..... | 27 |
| 6.4. Test setup | 27 |
| 6.5. Test results | 27 |
| 7. Power Spectral Density | 30 |

| | | |
|-------|-----------------------------------|----|
| 7.1. | Applied procedures / limit | 30 |
| 7.2. | Test procedure | 30 |
| 7.3. | Deviation from standard..... | 30 |
| 7.4. | Test setup | 30 |
| 7.5. | Test results | 30 |
| 8. | Band Edge | 33 |
| 8.1. | Applied procedures / limit | 33 |
| 8.2. | Test procedure | 33 |
| 8.3. | Deviation from standard..... | 33 |
| 8.4. | Test setup | 33 |
| 8.5. | Test results | 33 |
| 9. | Conducted Spurious Emissions..... | 36 |
| 9.1. | Applied procedures / limit | 36 |
| 9.2. | Test procedure | 36 |
| 9.3. | Deviation from standard..... | 36 |
| 9.4. | Test setup | 36 |
| 9.5. | Test results | 36 |
| 10. | Antenna Requirement..... | 39 |
| 10.1. | Standard requirement | 39 |
| 10.2. | EUT Antenna | 39 |
| 11. | Test setup photograph | 40 |
| 12. | Photos of the EUT | 42 |

TEST REPORT DECLARE

| | | |
|-----------------------------|---|---|
| FCC ID | : | 2ATWS2022AV |
| Equipment under Test | : | Smart Rope |
| Model /Type | : | LS-F20L |
| Listed Models | : | N/A |
| Trade Mark | : | 75PAI |
| Applicant | : | Shanghai Laisi Information technology Co.,Ltd. |
| Address | : | 901,21A No.1158 Zhongxin Road, Songjiang district Shanghai China |
| Manufacturer | : | Shanghai Laisi Information technology Co.,Ltd. |
| Address | : | 901,21A No.1158 Zhongxin Road, Songjiang district Shanghai China |
| Test Laboratory | : | Dongguan New Testing Centre Co., Ltd |
| Address | : | 1F & 3F, No. 1 the 1st North Industry Road Songshan Lake Science & Technology Park Dongguan, People' s Republic of China 523808 |

Test Standard Used:

FCC Part 15.247: Operation within the bands 902-928 MHz, 2400-2483.5 MHz and 5725-5850 MHz. ANSI C63.10:2020.

We Declare:

The equipment described above is tested by Dongguan New Testing Centre Co., Ltd and in the configuration tested the equipment complied with the standards specified above. The test results are contained in this test report and Dongguan New Testing Centre Co., Ltd is assumed of full responsibility for the accuracy and completeness of these tests.

After test and evaluation, our opinion is that the equipment provided for test compliance with the requirement of the above FCC standards.

| | | | |
|----------------------|------------------------------|-------------------------|--------------|
| Report No.: | NTC-ER2209013 | | |
| Date of Test: | Sep.09, 2022 to Sep.19, 2022 | Date of Report.: | Sep.19, 2022 |

Prepared By:



Jack Liu/Engineer



Dave Gao/LAB Manager

Note: This report applies to above tested sample only. This report shall not be reproduced in parts without written approval of Dongguan New Testing Centre Co., Ltd

1. Summary Of Test Results

| Description of Test Item | Standard | Results |
|---------------------------|----------------------|---------|
| Antenna Requirement | Section 15.247(c) | PASS |
| Conduction Emissions | Section 15.207(a) | PASS |
| Radiated Emissions | Section 15.247(d) | PASS |
| Maximum Peak Output Power | Section 15.247(b) | PASS |
| Band Edge Emissions | Section 15.247(d) | PASS |
| Power Spectral Density | Section 15.247(e) | PASS |
| 6dB Bandwidth | Section 15.247(a)(2) | PASS |
| RF Exposure | Section 15.247(i) | PASS |

Note: N/A is an abbreviation for Not Applicable, and means this item is not applicable for this device.

2. General Test Information

2.1. Description of EUT

| | |
|-----------------------|------------------------|
| Product Name: | : Smart Rope |
| Model/Type reference: | : LS-F20L |
| Power supply: | : DC 3.7V |
| Hardware Version: | : V1.0 |
| Software Version: | : V1.0 |
| BLE | |
| Supported type: | : Bluetooth Low Energy |
| Modulation: | : GFSK |
| Operation frequency: | : 2402MHz to 2480MHz |
| Channel number: | : 40 |
| Channel separation: | : 2 MHz |
| Antenna type: | : Internal Antenna |
| Antenna gain: | : -1.63dBi |

Note1: For more details, please refer to the user's manual of the EUT.

Note2: Antenna gain provided by the applicant.

Model list:

| Model | Input | Note |
|---------|---------|------|
| LS-F20L | DC 3.7V | N/A |

2.2. Description of Test Modes and Test Frequency

The Applicant provides communication tools software to control the EUT for staying in continuous transmitting (Duty Cycle more than 98%) and receiving mode for testing.

There are 40 channels provided to the EUT and Channel 00/19/39 were selected for BLE test.

Operation Frequency List :

| Channel | Frequency (MHz) |
|-----------|-----------------|
| 00 | 2402 |
| 02 | 2404 |
| 03 | 2406 |
| ⋮ | ⋮ |
| 19 | 2440 |
| ⋮ | ⋮ |
| 37 | 2476 |
| 38 | 2478 |
| 39 | 2480 |

Note: The line display in grey were the channel selected for testing

2.3. Assistant equipment used for test

| Assistant equipment | Manufacturer | Model number | Description | Other |
|---------------------|--------------|---------------|-------------|-------|
| Laptop | Lenovo | ThinkPad E450 | FCC SDOC | / |
| Adapter | Millet | JYS-002 | FCC SDOC | / |

2.4. Block diagram EUT configuration for test

1. Block diagram of EUT configuration(TX Mode)

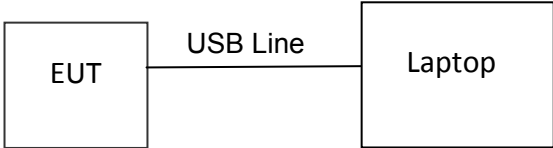

```

graph LR
    EUT[EUT] --- USB[USB Line] --- Laptop[Laptop]
  
```

Note:

- 1.Connect the EUT as above block diagram of configuration, Run the software, set the transmit serial port/power/channel/packet type/data type/hopping or not, send configuration, than EUT enter the TX mode.
- 2.Set EUT in continuous transmission signal mode.
- 3.Using the laptop and the transform board to control the fixed transmitting frequency and other test mode. After finishing the test setting, the notebook and the transform board will be removed during measurements.

2.5. Test environment conditions

During the measurement the environmental conditions were within the listed ranges:

(1) E.U.T. test conditions:

15.31(e): For intentional radiators, measurements of the variation of the input power or the radiated signal level of the fundamental frequency component of the emission, as appropriate, shall be performed with the supply voltage varied between 85% and 115% of the nominal rated supply voltage. For battery operated equipment, the equipment tests shall be performed using a new battery.

(2) Test frequencies:

According to the 15.31(m) Measurements on intentional radiators or receivers, other than TV broadcast receivers, shall be performed and. If required reported for each band in which the device can be operated with the device operating at the number of frequencies in each band specified in the following table:

| Frequency range over which device operates | Number of frequencies | Location in the range of operation |
|--|-----------------------|---|
| 1 MHz or less | 1 | Middle |
| 1 to 10 MHz | 2 | 1 near top and 1 near bottom |
| More than 10 MHz | 3 | 1 near top, 1 near middle and 1 near bottom |

(3) Frequency range of radiated measurements:

According to the 15.33, the test range will be up to the tenth harmonic of the highest fundamental frequency.

(4) Pre-test the EUT in all transmitting mode at the lowest (2402 MHz), middle (2440 MHz) and highest (2480 MHz) channel with different data packet and conducted to determine the worst-case mode,

The radiation measurements are performed in X, Y, Z axis positioning. And found the X axis positioning which it is worse case, only the test worst case mode is recorded in the report.

2.6. Measurement uncertainty

| Test Item | Uncertainty |
|---|------------------------|
| Uncertainty For Conduction Emission Test | 2.44dB |
| Uncertainty For Radiation Emission Test (30MHz – 1GHz) | 3.14 dB (Polarize: V) |
| | 3.16 dB (Polarize: H) |
| Uncertainty For Radiation Emission Test (1GHz – 18GHz) | 4.27 dB (Polarize: V) |
| | 4.51 dB (Polarize: H) |
| Uncertainty For Conducted RF Power | 0.63dB |
| Stop Transmitting Time Test | ±0.5% |
| Uncertainty For Frequency Error | 5.8 x 10 ⁻⁸ |

Note: This uncertainty represents an expanded uncertainty expressed at approximately the 95% confidence level using a coverage factor of k=2.

3. Power Line Conducted Emission Test

3.1. Test equipment

| Item | Equipment | Manufacturer | Model No. | Serial No. | Last Cal. | Cal. Interval |
|------|----------------------|--------------|---------------------|--------------|------------|---------------|
| 1 | Test Receiver | R&S | ESPI | 100146 | 2022-05-20 | 1 Year |
| 2 | LISN | R&S | ENV216 | 3650.6550.06 | 2022-05-20 | 1 Year |
| 3 | LISN | R&S | ENV4200 | 1107.2387.04 | 2022-05-20 | 1 Year |
| 4 | RF Cable | HUBER | SUCOFLEX100 | 30722/4E | 2021-05-21 | 2 Year |
| 5 | MEASUREMENT SOFTWARE | FARAD | EZ-EMC(VER:1.1.4.2) | N/A | N/A | N/A |

3.2. Block diagram of test setup

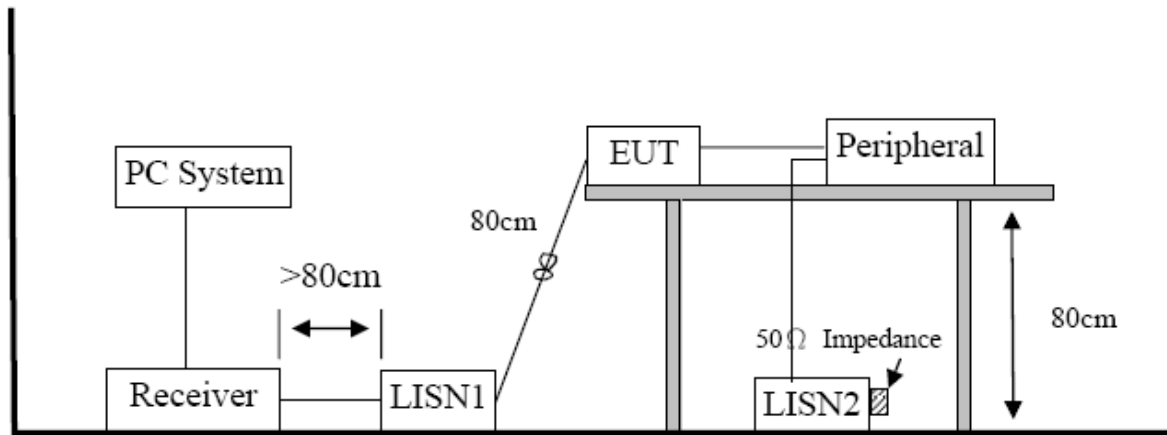

3.3. Power line conducted emission limits (class B)

| Frequency | Quasi-Peak Level dB(μV) | Average Level dB(μV) |
|-----------------|----------------------------|-------------------------|
| 150kHz ~ 500kHz | 66 ~ 56* | 56 ~ 46* |
| 500kHz ~ 5MHz | 56 | 46 |
| 5MHz ~ 30MHz | 60 | 50 |

Note 1: * Decreasing linearly with logarithm of frequency.

Note 2: The lower limit shall apply at the transition frequencies.

3.4. Test procedure

The EUT and Support equipment, if needed, were put placed on a non-metallic table, 80cm above the ground plane.

Configuration EUT to simulate typical usage as described in clause 2.3 and test equipment as described in clause 3.2 of this report.

All I/O cables were positioned to simulate typical actual usage as per ANSI C63.10.

All support equipment power received from a second LISN.

Emissions were measured on each current carrying line of the EUT using an EMI Test Receiver connected to the LISN powering the EUT.

The Receiver scanned from 150 kHz to 30MHz for emissions in each of the test modes.

During the above scans, the emissions were maximized by cable manipulation.

The test mode(s) described in clause 2.3 were scanned during the preliminary test.

After the preliminary scan, we found the test mode producing the highest emission level.

The EUT configuration and worse cable configuration of the above highest emission levels were recorded for reference of the final test.

EUT and support equipment were set up on the test bench as per the configuration with highest emission level in the preliminary test.

A scan was taken on both power lines, Neutral and Line, recording at least the six highest emissions. Emission frequency and amplitude were recorded into a computer in which correction factors were used to calculate the emission level and compare reading to the applicable limit.

The test data of the worst-case condition(s) was recorded.

The bandwidth of test receiver is set at 9 KHz.

3.5. Test result

4. PASS. (See below detailed test result)

Note1: All emissions not reported below are too low against the prescribed limits.

Note2: "-----" means Peak detection; "-----" means Average detection

Note3: Measurement = Reading Level + Factor, Margin= Measurement-Limit

Note4: All modes of GFSK, Pi/4 DQPSK, and 8DPSK were test at Low, Middle, and High channel; only the worst result of GFSK Middle Channel was reported as below:

Conducted Emission Test Result

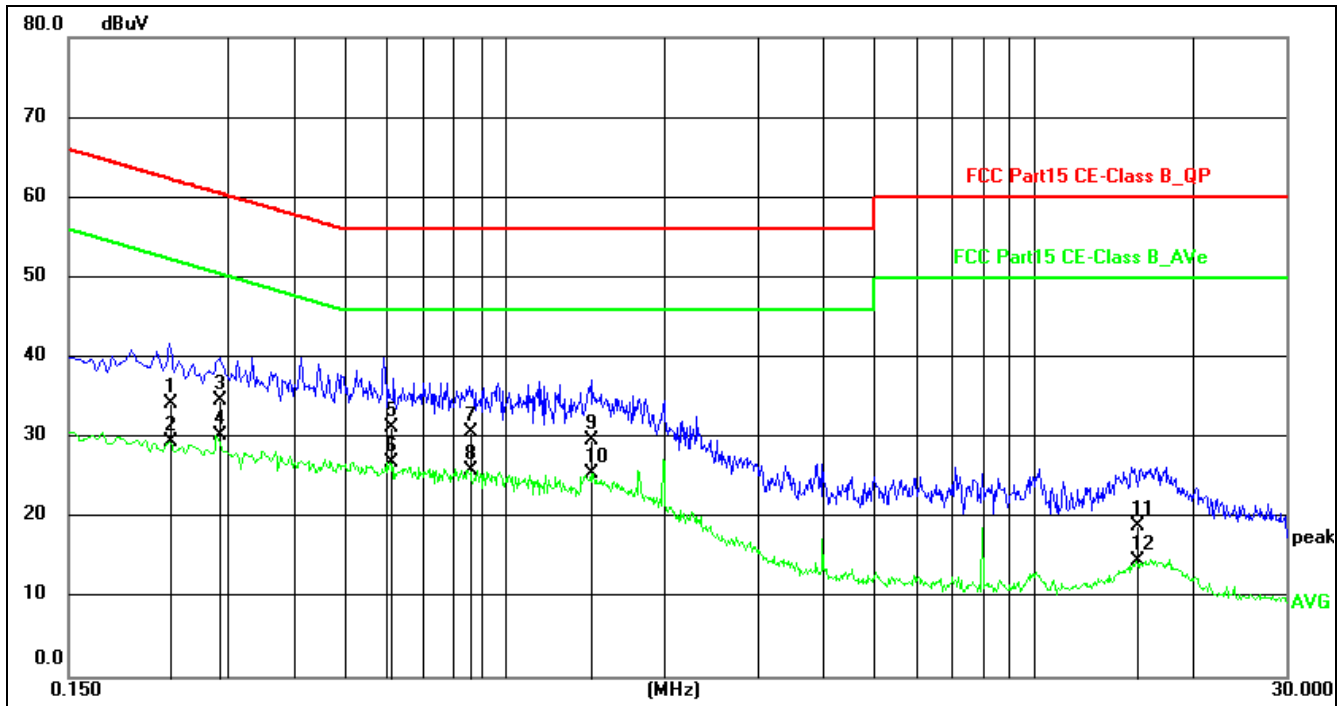

| | | | |
|---------------|--------------------------|-----------------------|----------------------|
| Site: | 844 LAB | Phase: L1 | Temperature(C):24(C) |
| Limit: | FCC Part15 CE-Class B_QP | | Humidity(%):63% |
| EUT: | Smart Rope | Test Time: | 2022/9/19 15:03:07 |
| M/N.: | LS-F20L | Power Rating: | DC 5V |
| Mode: | GFSK | Test Engineer: | Taylor Chen |
| Note: | | | |

| No. | Frequency (MHz) | Reading Level(dBuV) | Factor (dB) | Measurement(dBuV) | Limit (dBuV) | Margin (dB) | Detector | Comment |
|-----|-----------------|---------------------|-------------|-------------------|--------------|-------------|----------|---------|
| 1 | 0.2340 | 23.03 | 11.19 | 34.22 | 62.31 | -28.09 | QP | N/A |
| 2 | 0.2340 | 18.21 | 11.19 | 29.40 | 52.31 | -22.91 | AVG | N/A |
| 3 | 0.2900 | 23.39 | 11.23 | 34.62 | 60.52 | -25.90 | QP | N/A |
| 4 | 0.2900 | 18.98 | 11.23 | 30.21 | 50.52 | -20.31 | AVG | N/A |
| 5 | 0.6100 | 19.89 | 11.28 | 31.17 | 56.00 | -24.83 | QP | N/A |
| 6 * | 0.6100 | 15.71 | 11.28 | 26.99 | 46.00 | -19.01 | AVG | N/A |
| 7 | 0.8580 | 19.49 | 11.23 | 30.72 | 56.00 | -25.28 | QP | N/A |
| 8 | 0.8580 | 14.66 | 11.23 | 25.89 | 46.00 | -20.11 | AVG | N/A |
| 9 | 1.4580 | 18.44 | 11.22 | 29.66 | 56.00 | -26.34 | QP | N/A |
| 10 | 1.4580 | 14.38 | 11.22 | 25.60 | 46.00 | -20.40 | AVG | N/A |
| 11 | 15.6819 | 7.59 | 11.37 | 18.96 | 60.00 | -41.04 | QP | N/A |
| 12 | 15.6819 | 3.13 | 11.37 | 14.50 | 50.00 | -35.50 | AVG | N/A |

*:Maximum data x:Over limit !:over margin

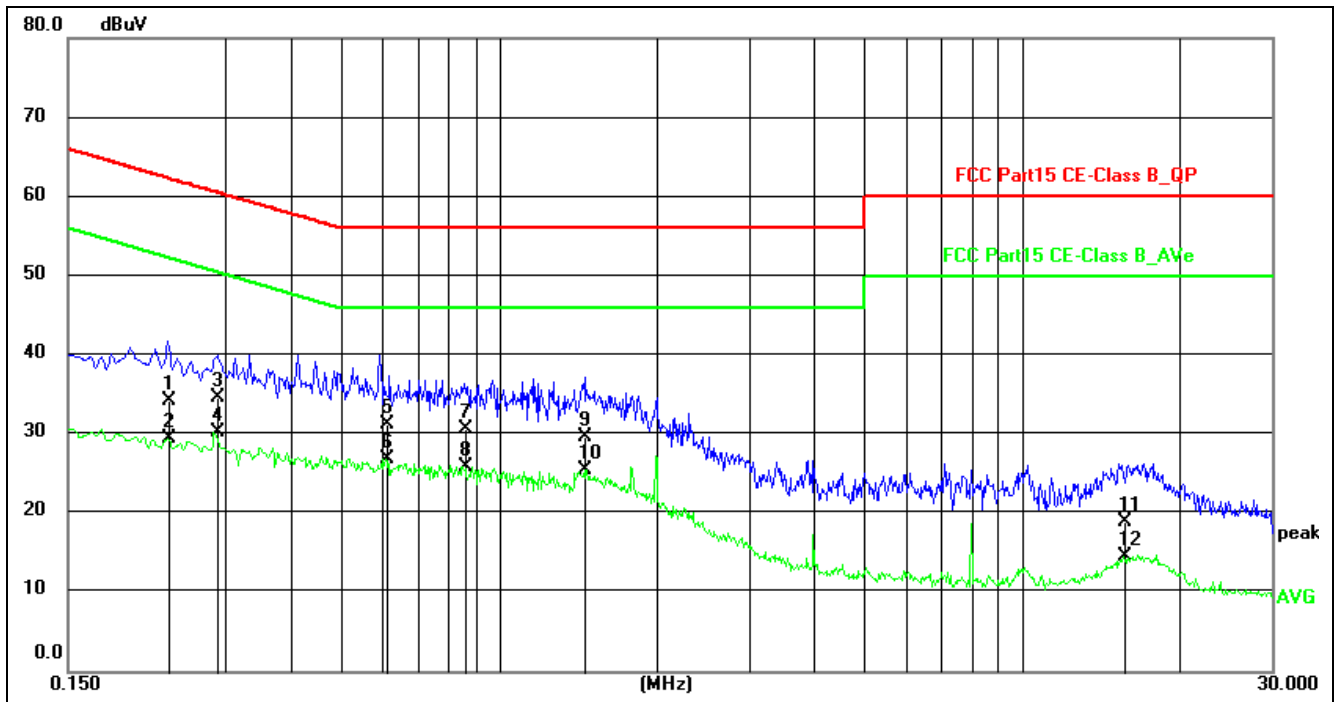

| | | | | | |
|---------------|---------------------------------|-----------------------|---------------------------|------------------------|--------------|
| Site: | 844 LAB | Phase: | N | Temperature(C): | 24(C) |
| Limit: | FCC Part15 CE-Class B_QP | | | Humidity(%): | 63% |
| EUT: | Smart Rope | Test Time: | 2022/9/19 14:59:29 | | |
| M/N.: | LS-F20L | Power Rating: | AC120/60Hz | | |
| Mode: | GFSK | Test Engineer: | Taylor Chen | | |
| Note: | | | | | |

| No. | Frequency (MHz) | Reading Level(dBuV) | Factor (dB) | Measurement(dBuV) | Limit (dBuV) | Margin (dB) | Detector | Comment |
|-----|-----------------|---------------------|-------------|-------------------|--------------|-------------|----------|---------|
| 1 | 0.2100 | 26.36 | 11.14 | 37.50 | 63.21 | -25.71 | QP | N/A |
| 2 | 0.2100 | 21.05 | 11.14 | 32.19 | 53.21 | -21.02 | AVG | N/A |
| 3 | 0.2860 | 26.13 | 11.16 | 37.29 | 60.64 | -23.35 | QP | N/A |
| 4 | 0.2860 | 20.65 | 11.16 | 31.81 | 50.64 | -18.83 | AVG | N/A |
| 5 | 0.3700 | 24.27 | 11.18 | 35.45 | 58.50 | -23.05 | QP | N/A |
| 6 | 0.3700 | 18.46 | 11.18 | 29.64 | 48.50 | -18.86 | AVG | N/A |
| 7 | 0.5940 | 23.01 | 11.22 | 34.23 | 56.00 | -21.77 | QP | N/A |
| 8 * | 0.5940 | 17.92 | 11.22 | 29.14 | 46.00 | -16.86 | AVG | N/A |
| 9 | 0.9220 | 22.10 | 11.23 | 33.33 | 56.00 | -22.67 | QP | N/A |
| 10 | 0.9220 | 17.53 | 11.23 | 28.76 | 46.00 | -17.24 | AVG | N/A |
| 11 | 1.5180 | 21.28 | 11.24 | 32.52 | 56.00 | -23.48 | QP | N/A |
| 12 | 1.5180 | 16.10 | 11.24 | 27.34 | 46.00 | -18.66 | AVG | N/A |

*:Maximum data x:Over limit !:over margin

5. Radiated Emission Test

5.1. Test equipment

| Item | Equipment | Manufacturer | Model No. | Serial No. | Last Cal. | Cal. Interval |
|------|----------------------------|--------------|-------------------------|--------------------------------|------------|---------------|
| 1 | EMI Test Receiver | R&S | ESR | 7250-30406 7528 | 2022-05-20 | 1 Year |
| 2 | Trilog Broadband Antenna | Schwarzbeck | VULB9168 | 00969 | 2021-06-16 | 2 Year |
| 3 | Pre-amplifier | R&S | 8447F | 3113A04553 | 2022-05-20 | 1 Year |
| 4 | Active Loop antenna | Schwarzbeck | FMZB-1519 | 1519-038 | 2022-05-20 | 1 Year |
| 5 | Horn antenna | Schwarzbeck | BBHA9120D | 453 | 2021-05-25 | 2 Year |
| 6 | Double Ridged Horn Antenna | A.H. System | SAS-574 | 584 | 2022-05-20 | 1 Year |
| 7 | Pre-amplifier | R&S | SCU18 | 105326 | 2022-05-20 | 1 Year |
| 8 | RF Cable | GORE | OSQ01Q010 78.7 | SN1545847 3 | 2022-05-20 | 1 Year |
| 9 | RF Cable | GORE | OSQ01Q010 78.7 | SN1545847 4 | 2022-05-20 | 1 Year |
| 10 | RF Cable | ESCO | ETS-LINGR EN | RFC-SMS-1 00-SMS-340 -IN | 2022-05-20 | 1 Year |
| 11 | Measurement software | Farad | EZ-EMC(VE R:1.1.4.2) | N/A | N/A | N/A |

5.2. Block diagram of test setup

In 3m Anechoic Chamber Test Setup Diagram for 9KHz to 30MHz:

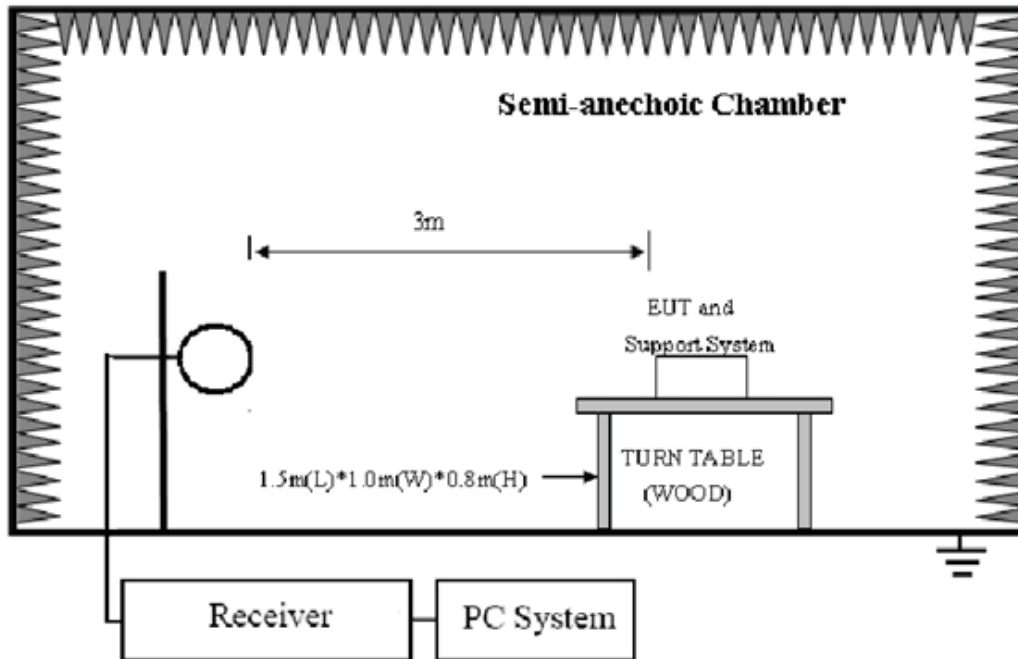

In 3m Anechoic Chamber Test Setup Diagram for 30MHz to 1GHz:

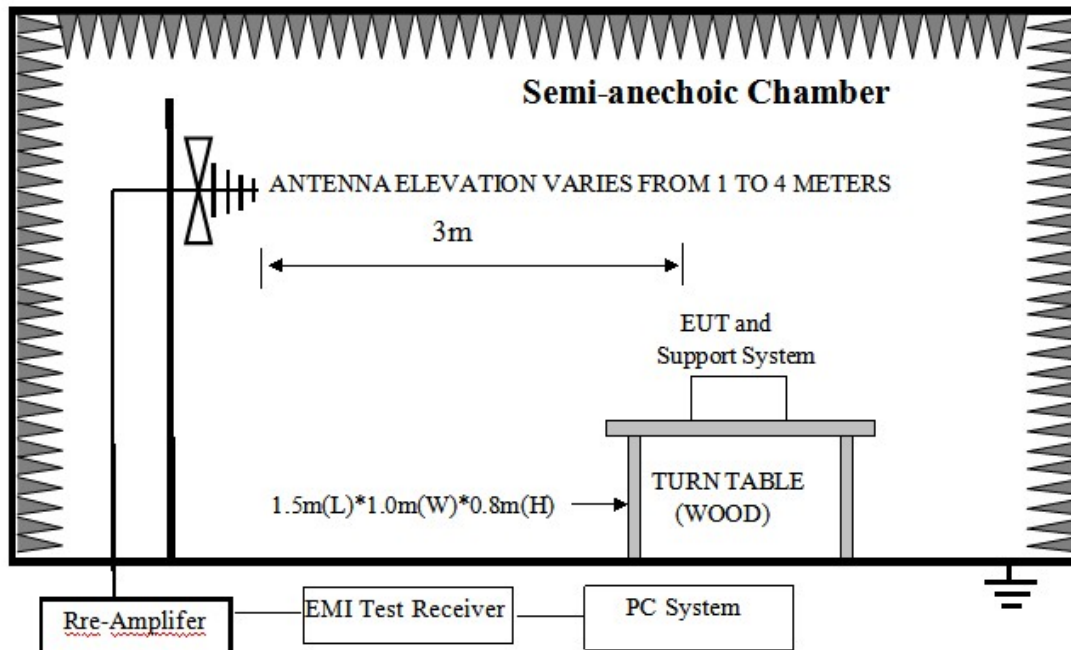

In 3m Anechoic Chamber Test Setup Diagram for frequency above 1GHz:

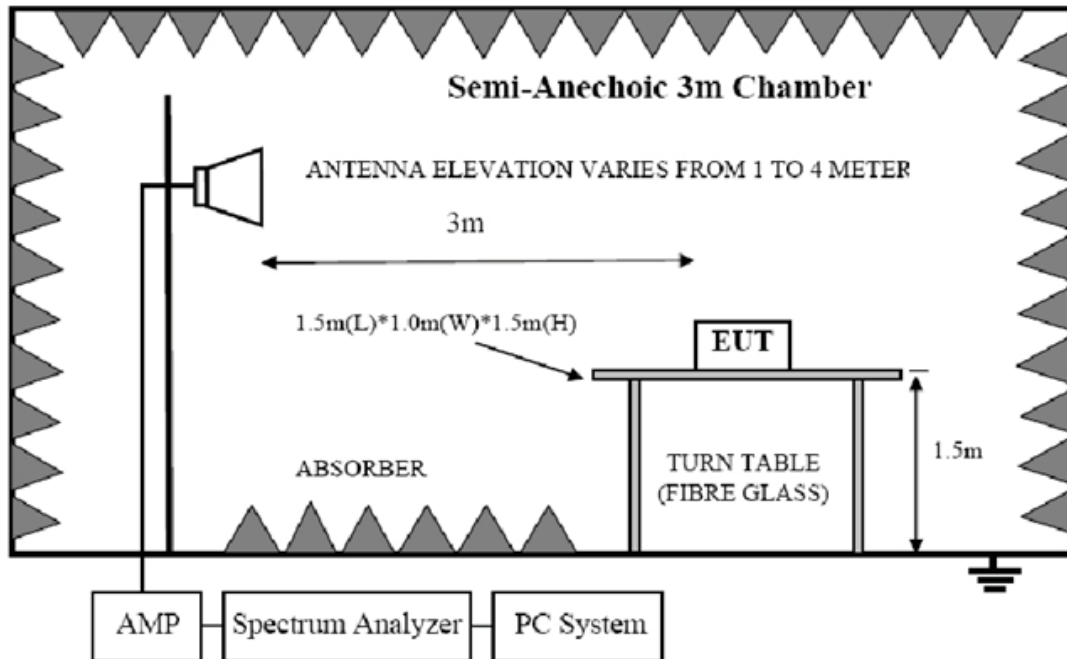

5.3. Limit

FCC 15.205 Restricted frequency band:

| MHz | MHz | MHz | GHz |
|----------------------------|-----------------------|-----------------|------------------|
| 0.090 - 0.110 | 16.42 - 16.423 | 399.9 - 410 | 4.5 - 5.15 |
| ¹ 0.495 - 0.505 | 16.69475 - 16.69525 | 608 - 614 | 5.35 - 5.46 |
| 2.1735 - 2.1905 | 16.80425 - 16.80475 | 960 - 1240 | 7.25 - 7.75 |
| 4.125 - 4.128 | 25.5 - 25.67 | 1300 - 1427 | 8.025 - 8.5 |
| 4.17725 - 4.17775 | 37.5 - 38.25 | 1435 - 1626.5 | 9.0 - 9.2 |
| 4.20725 - 4.20775 | 73 - 74.6 | 1645.5 - 1646.5 | 9.3 - 9.5 |
| 6.215 - 6.218 | 74.8 - 75.2 | 1660 - 1710 | 10.6 - 12.7 |
| 6.26775 - 6.26825 | 108 - 121.94 | 1718.8 - 1722.2 | 13.25 - 13.4 |
| 6.31175 - 6.31225 | 123 - 138 | 2200 - 2300 | 14.47 - 14.5 |
| 8.291 - 8.294 | 149.9 - 150.05 | 2310 - 2390 | 15.35 - 16.2 |
| 8.362 - 8.366 | 156.52475 - 156.52525 | 2483.5 - 2500 | 17.7 - 21.4 |
| 8.37625 - 8.38675 | 156.7 - 156.9 | 2690 - 2900 | 22.01 - 23.12 |
| 8.41425 - 8.41475 | 162.0125 - 167.17 | 3260 - 3267 | 23.6 - 24.0 |
| 12.29 - 12.293 | 167.72 - 173.2 | 3332 - 3339 | 31.2 - 31.8 |
| 12.51975 - 12.52025 | 240 - 285 | 3345.8 - 3358 | 36.43 - 36.5 |
| 12.57675 - 12.57725 | 322 - 335.4 | 3600 - 4400 | (²) |

FCC 15.109 Limit

| Frequency (MHz) | Distance (Meters) | Field Strengths Limits dB(μV)/m |
|-----------------|-------------------|---------------------------------|
| 30--88 | 3 | 40.0 |
| 88--216 | 3 | 43.5 |
| 216--960 | 3 | 46.0 |
| 960--1000 | 3 | 54.0 |
| Above 1GHz | 3 | Peak: 74.0 |
| | 3 | Average:54.0 |

Note: (1) The smaller limit shall apply at the cross point between two frequency bands.

(2)Distance is the distance in meters between the measuring instrument, antenna and the closest point of any part of the device or system.

(3)The emission limits shown in the above table are based on measurements employing a CISPR QP detector except for the frequency bands 9-90KHz, 110-490KHz and above 1000MHz.Radiated emissions limits in these three bands are based on measurements employing an average detector.

(4) At frequencies below 30MHz, measurement may be performed at a distance closer then that specified, and the limit at closer measurement distance can be extrapolated by below formula:

$$\text{Limit}_{3m}(\text{dBuV}/\text{m}) = \text{Limit}_{30m}(\text{dBuV}/\text{m}) + 40\text{Log}(30\text{m}/3\text{m})$$

(5)All the emissions appearing within 15.205 restricted frequency bands shall not exceed the limits shown in 15.109, all the other emissions shall be at least 20dB below the fundamental emissions, or comply with 15.109 limits.

5.4. Test procedure

Procedure of Preliminary Test

Configuration EUT to simulate typical usage as described in clause 2.3 and test equipment as described in clause 4.2 of this report.

Mains cables, telephone lines or other connections to auxiliary equipment located outside the test are shall drape to the floor, be fitted with ferrite clamps or ferrite tubes placed on the floor at the point where the cable reaches the floor and then routed to the place where they leave the turntable. No extension cords shall be used to mains receptacle.

EUT height should be 0.8m for below 1GHz and 1.5m for above 1GHz at ground with absorbers.

The antenna was placed at 3 meter away from the EUT as stated in ANSI C63.10. The antenna connected to the Spectrum Analyzer via a cable and at times a pre-amplifier would be used.

The Analyzer / Receiver quickly scanned from 30MHz to 18GHz. The EUT test program was started. Emissions were scanned and measured rotating the EUT to 360 degrees and positioning the antenna 1 to 4 meters above the ground plane, in both the vertical and the horizontal polarization, to maximize the emission reading level.

The X, Y, Z three axial are tested and the report only the worst case.

The emissions from 9KHz to 1GHz, QP or average values were measured with EMI receiver with below RBW:

| Frequency band | RBW |
|----------------|--------|
| 9KHz-150KHz | 200Hz |
| 150KHz-30MHz | 9KHz |
| 30MHz-1GHz | 120KHz |

For emissions above 1GHz, both Peak and Average level were measured with Spectrum Analyzer, and the RBW is set at 1MHz, VBW is set at 3MHz for Peak measure; RMS detector RBW 1MHz VBW 3MHz for Average measure.

5.5. Test result

PASS. (See below detailed test result)

All the emissions except fundamental emission from 9 KHz to 40GHz were comply with FCC PART 15.109 limits limit.

Note1: According exploratory test no any obvious emission were detected from 9KHz to 30MHz and 18GHz to 40GHz, so the final test was performed with frequency range from 30MHz to 18GHz and recorded in below.

Note2: For emissions above 1GHz. If peak results comply with AV limit, AV Result is deemed to comply with AV limit.

Note3: Level = Reading Level + Factor, Margin= Level-Limit

Radiated Emission Test Result

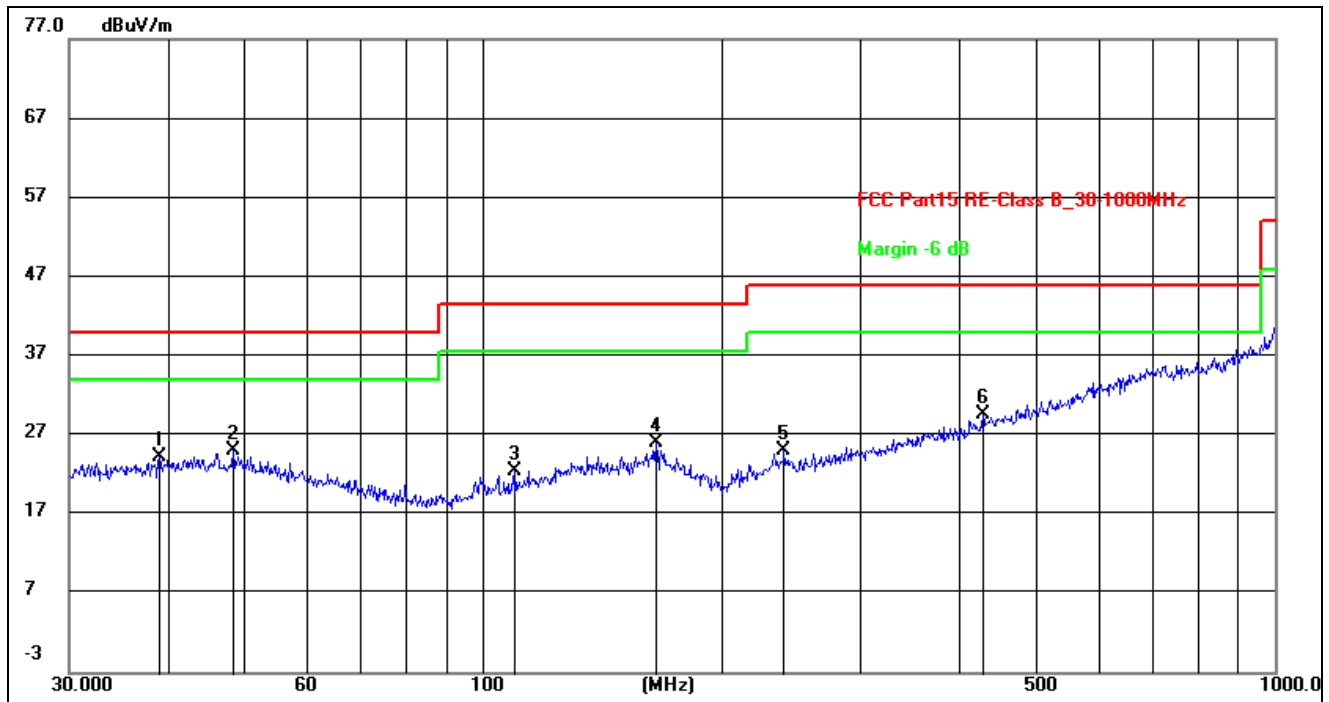

| | | | | | |
|---------------|----------------------------------|-----------------------|------------|------------------------|-------|
| Site: | 966 LAB | Antenna:: | Horizontal | Temperature(C): | 24(C) |
| Limit: | FCC Part15 RE-Class B_30-1000MHz | Test Time: | | Humidity(%): | 60% |
| EUT: | Smart Rope | Power Rating: | | DC 3.7V | |
| M/N.: | LS-F20L | Test Engineer: | | | |
| Mode: | GFSK | | | | |
| Note: | | | | | |

| No. | Frequency (MHz) | Reading (dBuV) | Factor (dB/m) | Level (dBuV/m) | Limit (dBuV/m) | Margin (dB) | Det. | Height (cm) | Azimuth (deg) | Remark |
|-----|-----------------|----------------|---------------|----------------|----------------|-------------|------|-------------|---------------|--------|
| 1 | 39.8542 | 10.56 | 14.21 | 24.77 | 40.00 | -15.23 | peak | 200 | 355 | N/A |
| 2 * | 51.1209 | 10.22 | 14.01 | 24.23 | 40.00 | -15.77 | peak | 100 | 147 | N/A |
| 3 | 99.1797 | 11.34 | 10.77 | 22.11 | 43.50 | -21.39 | peak | 100 | 353 | N/A |
| 4 | 160.3456 | 10.03 | 14.81 | 24.84 | 43.50 | -18.66 | peak | 200 | 355 | N/A |
| 5 | 243.3771 | 12.28 | 13.31 | 25.59 | 46.00 | -20.41 | peak | 200 | 207 | N/A |
| 6 | 452.7197 | 11.64 | 18.11 | 29.75 | 46.00 | -16.25 | peak | 200 | 47 | N/A |

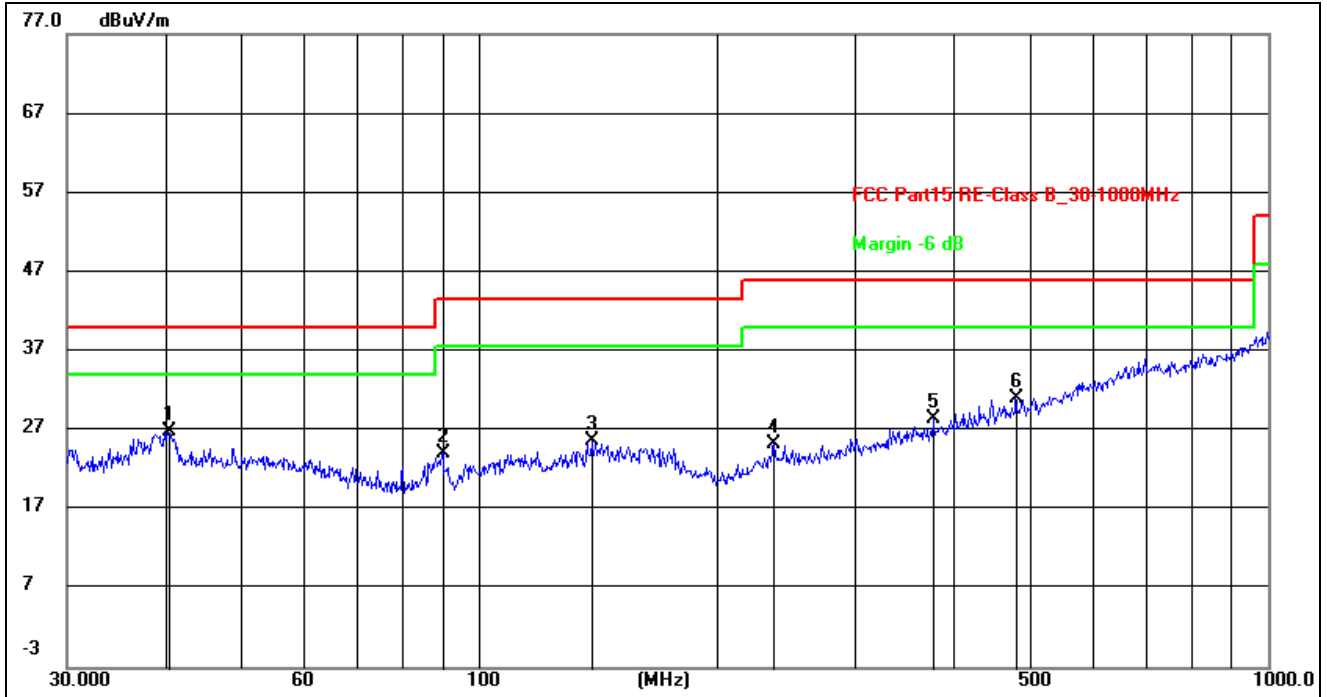

| | | | | | |
|--------|----------------------------------|----------------|----------|-----------------|-------|
| Site: | 966 LAB | Antenna:: | Vertical | Temperature(C): | 24(C) |
| Limit: | FCC Part15 RE-Class B_30-1000MHz | Test Time: | | Humidity(%): | 60% |
| EUT: | Smart Rope | Power Rating: | | DC | 3.7V |
| M/N.: | LS-F20L | Test Engineer: | | | |
| Mode: | GFSK | | | | |
| Note: | | | | | |

| No. | Frequency (MHz) | Reading (dBuV) | Factor (dB/m) | Level (dBuV/m) | Limit (dBuV/m) | Margin (dB) | Det. | Height (cm) | Azimuth (deg) | Remark |
|-----|-----------------|----------------|---------------|----------------|----------------|-------------|------|-------------|---------------|--------|
| 1 * | 40.2757 | 12.11 | 14.68 | 26.79 | 40.00 | -13.21 | peak | 100 | 355 | N/A |
| 2 | 89.9047 | 13.60 | 10.45 | 24.05 | 43.50 | -19.45 | peak | 200 | 124 | N/A |
| 3 | 138.8735 | 10.91 | 14.68 | 25.59 | 43.50 | -17.91 | peak | 200 | 211 | N/A |
| 4 | 236.6447 | 12.35 | 12.93 | 25.28 | 46.00 | -20.72 | peak | 200 | 7 | N/A |
| 5 | 375.9385 | 12.17 | 16.25 | 28.42 | 46.00 | -17.58 | peak | 100 | 15 | N/A |
| 6 | 478.8456 | 12.60 | 18.43 | 31.03 | 46.00 | -14.97 | peak | 200 | 318 | N/A |

For 1GHz to 25GHz

BLE Mode (above 1GHz)

| Frequency(MHz): | | | 2402 | | Polarity: | | | HORIZONTAL | |
|-----------------|-------------------------|----|----------------|-------------|------------------|-----------------------|-------------------|--------------------|--------------------------|
| Frequency (MHz) | Emission Level (dBuV/m) | | Limit (dBuV/m) | Margin (dB) | Raw Value (dBuV) | Antenna Factor (dB/m) | Cable Factor (dB) | Pre-amplifier (dB) | Correction Factor (dB/m) |
| 4804.00 | 51.82 | PK | 74.00 | 22.18 | 47.45 | 33.35 | 6.91 | 35.89 | 4.37 |
| 4804.00 | -- | AV | 54.00 | -- | -- | -- | -- | -- | -- |
| 5485.00 | 51.54 | PK | 74.00 | 22.46 | 44.35 | 34.36 | 7.10 | 34.27 | 7.19 |
| 5485.00 | -- | AV | 54.00 | -- | -- | -- | -- | -- | -- |
| 7206.00 | 48.25 | PK | 74.00 | 25.75 | 37.25 | 36.85 | 9.18 | 35.03 | 11.00 |
| 7206.00 | -- | AV | 54.00 | -- | -- | -- | -- | -- | -- |

| Frequency(MHz): | | | 2402 | | Polarity: | | | VERTICAL | |
|-----------------|-------------------------|----|----------------|-------------|------------------|-----------------------|-------------------|--------------------|--------------------------|
| Frequency (MHz) | Emission Level (dBuV/m) | | Limit (dBuV/m) | Margin (dB) | Raw Value (dBuV) | Antenna Factor (dB/m) | Cable Factor (dB) | Pre-amplifier (dB) | Correction Factor (dB/m) |
| 4804.00 | 49.85 | PK | 74.00 | 24.15 | 45.14 | 33.69 | 6.91 | 35.89 | 4.71 |
| 4804.00 | -- | AV | 54.00 | -- | -- | -- | -- | -- | -- |
| 5479.00 | 45.62 | PK | 74.00 | 28.38 | 38.00 | 34.75 | 7.23 | 34.36 | 7.62 |
| 5479.00 | -- | AV | 54.00 | -- | -- | -- | -- | -- | -- |
| 7206.00 | 46.69 | PK | 74.00 | 27.31 | 36.18 | 36.36 | 9.18 | 35.03 | 10.51 |
| 7206.00 | -- | AV | 54.00 | -- | -- | -- | -- | -- | -- |

| Frequency(MHz): | | | 2440 | | Polarity: | | | HORIZONTAL | |
|-----------------|-------------------------|----|----------------|-------------|------------------|-----------------------|-------------------|--------------------|--------------------------|
| Frequency (MHz) | Emission Level (dBuV/m) | | Limit (dBuV/m) | Margin (dB) | Raw Value (dBuV) | Antenna Factor (dB/m) | Cable Factor (dB) | Pre-amplifier (dB) | Correction Factor (dB/m) |
| 4880.00 | 52.78 | PK | 74.00 | 21.22 | 46.71 | 33.42 | 6.95 | 34.30 | 6.07 |
| 4880.00 | -- | AV | 54.00 | -- | -- | -- | -- | -- | -- |
| 5675.00 | 44.62 | PK | 74.00 | 29.38 | 37.20 | 34.36 | 7.16 | 34.10 | 7.42 |
| 5675.00 | -- | AV | 54.00 | -- | -- | -- | -- | -- | -- |
| 7320.00 | 47.69 | PK | 74.00 | 26.31 | 36.10 | 37.36 | 9.23 | 35.00 | 11.59 |
| 7320.00 | -- | AV | 54.00 | -- | -- | -- | -- | -- | -- |

| Frequency(MHz): | | | 2440 | | Polarity: | | | VERTICAL | |
|-----------------|-------------------------|----|----------------|-------------|------------------|-----------------------|-------------------|--------------------|--------------------------|
| Frequency (MHz) | Emission Level (dBuV/m) | | Limit (dBuV/m) | Margin (dB) | Raw Value (dBuV) | Antenna Factor (dB/m) | Cable Factor (dB) | Pre-amplifier (dB) | Correction Factor (dB/m) |
| 4880.00 | 51.63 | PK | 74.00 | 22.37 | 45.56 | 33.42 | 6.95 | 34.30 | 6.07 |
| 4880.00 | -- | AV | 54.00 | -- | -- | -- | -- | -- | -- |
| 5685.00 | 43.47 | PK | 74.00 | 30.53 | 36.05 | 34.36 | 7.16 | 34.10 | 7.42 |
| 5685.00 | -- | AV | 54.00 | -- | -- | -- | -- | -- | -- |
| 7320.00 | 47.62 | PK | 74.00 | 26.38 | 36.03 | 37.36 | 9.23 | 35.00 | 11.59 |
| 7320.00 | -- | AV | 54.00 | -- | -- | -- | -- | -- | -- |

| Frequency(MHz): | | | 2480 | | Polarity: | | | HORIZONTAL | |
|-----------------|-------------------------|----|----------------|-------------|------------------|-----------------------|-------------------|--------------------|--------------------------|
| Frequency (MHz) | Emission Level (dBuV/m) | | Limit (dBuV/m) | Margin (dB) | Raw Value (dBuV) | Antenna Factor (dB/m) | Cable Factor (dB) | Pre-amplifier (dB) | Correction Factor (dB/m) |
| 4960.00 | 52.62 | PK | 74.00 | 21.38 | 47.68 | 33.86 | 7.00 | 35.92 | 4.94 |
| 4960.00 | -- | AV | 54.00 | -- | -- | -- | -- | -- | -- |
| 5965.00 | 48.62 | PK | 74.00 | 25.38 | 41.33 | 34.42 | 7.22 | 34.35 | 7.29 |
| 5965.00 | -- | AV | 54.00 | -- | -- | -- | -- | -- | -- |
| 7440.00 | 47.62 | PK | 74.00 | 26.38 | 35.37 | 37.94 | 9.28 | 34.97 | 12.25 |
| 7440.00 | -- | AV | 54.00 | -- | -- | -- | -- | -- | -- |

| Frequency(MHz): | | | 2480 | | Polarity: | | | VERTICAL | |
|-----------------|-------------------------|----|----------------|-------------|------------------|-----------------------|-------------------|--------------------|--------------------------|
| Frequency (MHz) | Emission Level (dBuV/m) | | Limit (dBuV/m) | Margin (dB) | Raw Value (dBuV) | Antenna Factor (dB/m) | Cable Factor (dB) | Pre-amplifier (dB) | Correction Factor (dB/m) |
| 4960.00 | 53.62 | PK | 74.00 | 20.38 | 48.68 | 33.86 | 7.00 | 35.92 | 4.94 |
| 4960.00 | -- | AV | 54.00 | -- | -- | -- | -- | -- | -- |
| 5948.00 | 49.56 | PK | 74.00 | 24.44 | 42.27 | 34.42 | 7.22 | 34.35 | 7.29 |
| 5948.00 | -- | AV | 54.00 | -- | -- | -- | -- | -- | -- |
| 7440.00 | 48.36 | PK | 74.00 | 25.64 | 36.11 | 37.94 | 9.28 | 34.97 | 12.25 |
| 7440.00 | -- | AV | 54.00 | -- | -- | -- | -- | -- | -- |

REMARKS:

1. Emission level (dBuV/m) =Raw Value (dBuV)+Correction Factor (dB/m)
2. Correction Factor (dB/m) = Antenna Factor (dB/m)+Cable Factor (dB)-Pre-amplifier Factor
3. Margin value = Limit value- Emission level.
4. -- Mean the PK detector measured value is below average limit.
5. RBW1MHz VBW3MHz Peak detector is for PK value; RBW 1MHz VBW10Hz Peak detector is for AV value.
6. Other emissions are attenuated 20dB below the limits from 9kHz to 30MHz, so it does not recorded in report.

Results of Band Edges Test (Radiated)

| Frequency(MHz): | | | 2402 | | Polarity: | | | HORIZONTAL | |
|-----------------|-------------------------|----|----------------|-------------|------------------|-----------------------|-------------------|--------------------|--------------------------|
| Frequency (MHz) | Emission Level (dBuV/m) | | Limit (dBuV/m) | Margin (dB) | Raw Value (dBuV) | Antenna Factor (dB/m) | Cable Factor (dB) | Pre-amplifier (dB) | Correction Factor (dB/m) |
| 2402.00 | 101.85 | PK | -- | -- | 68.46 | 28.78 | 4.61 | 0.00 | 33.39 |
| 2402.00 | 92.62 | AV | -- | -- | 59.23 | 28.78 | 4.61 | 0.00 | 33.39 |
| 2381.00 | 46.62 | PK | 74.00 | 27.38 | 13.54 | 28.52 | 4.56 | 0.00 | 33.08 |
| 2381.00 | -- | AV | 54.00 | -- | -- | -- | -- | -- | -- |
| 2390.00 | 46.39 | PK | 74.00 | 27.61 | 13.07 | 28.72 | 4.60 | 0.00 | 33.32 |
| 2390.00 | -- | AV | 54.00 | -- | -- | -- | -- | -- | -- |
| 2400.00 | 36.00 | PK | -- | -- | 2.61 | 28.78 | 4.61 | 0.00 | 33.39 |
| 2400.00 | -- | AV | -- | -- | -- | -- | -- | -- | -- |

| Frequency(MHz): | | | 2402 | | Polarity: | | | VERTICAL | |
|-----------------|-------------------------|----|----------------|-------------|------------------|-----------------------|-------------------|--------------------|--------------------------|
| Frequency (MHz) | Emission Level (dBuV/m) | | Limit (dBuV/m) | Margin (dB) | Raw Value (dBuV) | Antenna Factor (dB/m) | Cable Factor (dB) | Pre-amplifier (dB) | Correction Factor (dB/m) |
| 2402.00 | 102.92 | PK | -- | -- | 69.89 | 28.42 | 4.61 | 0.00 | 33.03 |
| 2402.00 | 93.85 | AV | -- | -- | 60.56 | 28.68 | 4.61 | 0.00 | 33.29 |
| 2381.00 | 44.62 | PK | 74.00 | 29.38 | 11.61 | 28.45 | 4.56 | 0.00 | 33.01 |
| 2381.00 | -- | AV | 54.00 | -- | -- | -- | -- | -- | -- |
| 2390.00 | 50.62 | PK | 74.00 | 23.38 | 17.66 | 28.36 | 4.60 | 0.00 | 32.96 |
| 2390.00 | -- | AV | 54.00 | -- | -- | -- | -- | -- | -- |
| 2400.00 | 51.72 | PK | -- | -- | 18.33 | 28.78 | 4.61 | 0.00 | 33.39 |
| 2400.00 | -- | AV | -- | -- | -- | -- | -- | -- | -- |

| Frequency(MHz): | | | 2480 | | Polarity: | | | HORIZONTAL | |
|-----------------|-------------------------|----|----------------|-------------|------------------|-----------------------|-------------------|--------------------|--------------------------|
| Frequency (MHz) | Emission Level (dBuV/m) | | Limit (dBuV/m) | Margin (dB) | Raw Value (dBuV) | Antenna Factor (dB/m) | Cable Factor (dB) | Pre-amplifier (dB) | Correction Factor (dB/m) |
| 2480.00 | 100.95 | PK | -- | -- | 67.33 | 28.92 | 4.70 | 0.00 | 33.62 |
| 2480.00 | 91.26 | AV | -- | -- | 57.64 | 28.92 | 4.70 | 0.00 | 33.62 |
| 2483.50 | 52.62 | PK | 74.00 | 21.38 | 18.99 | 28.93 | 4.70 | 0.00 | 33.63 |
| 2483.50 | -- | AV | 54.00 | -- | -- | -- | -- | -- | -- |
| 2485.00 | 49.69 | PK | 74.00 | 24.31 | 16.03 | 28.95 | 4.71 | 0.00 | 33.66 |
| 2485.00 | -- | AV | 54.00 | -- | -- | -- | -- | -- | -- |
| 2500.00 | 47.15 | PK | 74.00 | 26.85 | 13.47 | 28.96 | 4.72 | 0.00 | 33.68 |
| 2500.00 | -- | AV | 54.00 | -- | -- | -- | -- | -- | -- |

| Frequency(MHz): | | | 2480 | | Polarity: | | | VERTICAL | |
|-----------------|-------------------------|----|----------------|-------------|------------------|-----------------------|-------------------|--------------------|--------------------------|
| Frequency (MHz) | Emission Level (dBuV/m) | | Limit (dBuV/m) | Margin (dB) | Raw Value (dBuV) | Antenna Factor (dB/m) | Cable Factor (dB) | Pre-amplifier (dB) | Correction Factor (dB/m) |
| 2480.00 | 100.95 | PK | -- | -- | 67.33 | 28.92 | 4.70 | 0.00 | 33.62 |
| 2480.00 | 91.86 | AV | -- | -- | 58.24 | 28.92 | 4.70 | 0.00 | 33.62 |
| 2483.50 | 51.62 | PK | 74.00 | 22.38 | 17.99 | 28.93 | 4.70 | 0.00 | 33.63 |
| 2483.50 | -- | AV | 54.00 | -- | -- | -- | -- | -- | -- |
| 2485.00 | 52.62 | PK | 74.00 | 21.38 | 18.96 | 28.95 | 4.71 | 0.00 | 33.66 |
| 2485.00 | -- | AV | 54.00 | -- | -- | -- | -- | -- | -- |
| 2500.00 | 49.62 | PK | 74.00 | 24.38 | 15.94 | 28.96 | 4.72 | 0.00 | 33.68 |
| 2500.00 | -- | AV | 54.00 | -- | -- | -- | -- | -- | -- |

REMARKS:

1. Emission level (dBuV/m) = Raw Value (dBuV) + Correction Factor (dB/m)
2. Correction Factor (dB/m) = Antenna Factor (dB/m) + Cable Factor (dB) - Pre-amplifier Factor
3. Margin value = Limit value - Emission level.
4. -- Mean the PK detector measured value is below average limit.
5. RBW 1MHz VBW 3MHz Peak detector is for PK value; RBW 1MHz VBW 10Hz Peak detector is for AV value.
6. For fundamental frequency, RBW 3MHz VBW 3MHz Peak detector is for PK Value; RMS detector is for AV value.
7. Other emissions are attenuated 20dB below the limits from 9kHz to 30MHz, so it does not recorded in report.

6. Maximum Peak Output Power

6.1. Applied procedures / limit

15.247(b) (3) For systems using digital modulation in the 902-928 MHz, 2400-2483.5 MHz, and 5725-5850 MHz bands: 1 Watt.

6.2. Test procedure

- (1) Connected the antenna port to the Spectrum Analyzer, set the Spectrum Analyzer as Span = approximately 5 times the 20 dB bandwidth, centered on a hopping channel
RBW > the 20 dB bandwidth of the emission being measured, VBW \geq RBW, Sweep = auto
Detector function = peak, Trace = max hold
- (2) The EUT should be transmitting at its maximum data rate. Allow the trace to stabilize. Use the marker-to-peak function to set the marker to the peak of the emission. The indicated level is the peak output power.
- (3) The above procedure shall be repeated at the lowest, the middle, and the highest frequency of the stated frequency range with modulated mode. Also shall be performed at different modes of operation.

6.3. Deviation from standard

No deviation.

6.4. Test setup

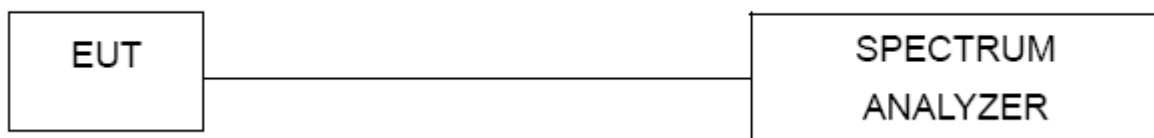

6.5. Test Results

| Condition | Mode | Frequency (MHz) | Antenna | Conducted Power (dBm) | Duty Factor (dB) | Total Power (dBm) | Limit (dBm) | Verdict |
|-----------|------|-----------------|---------|-----------------------|------------------|-------------------|-------------|---------|
| NVNT | BLE | 2402 | Ant 1 | 0.894 | 1.88 | 2.774 | 30 | Pass |
| NVNT | BLE | 2440 | Ant 1 | 0.417 | 1.88 | 2.297 | 30 | Pass |
| NVNT | BLE | 2480 | Ant 1 | 0.098 | 1.88 | 1.978 | 30 | Pass |

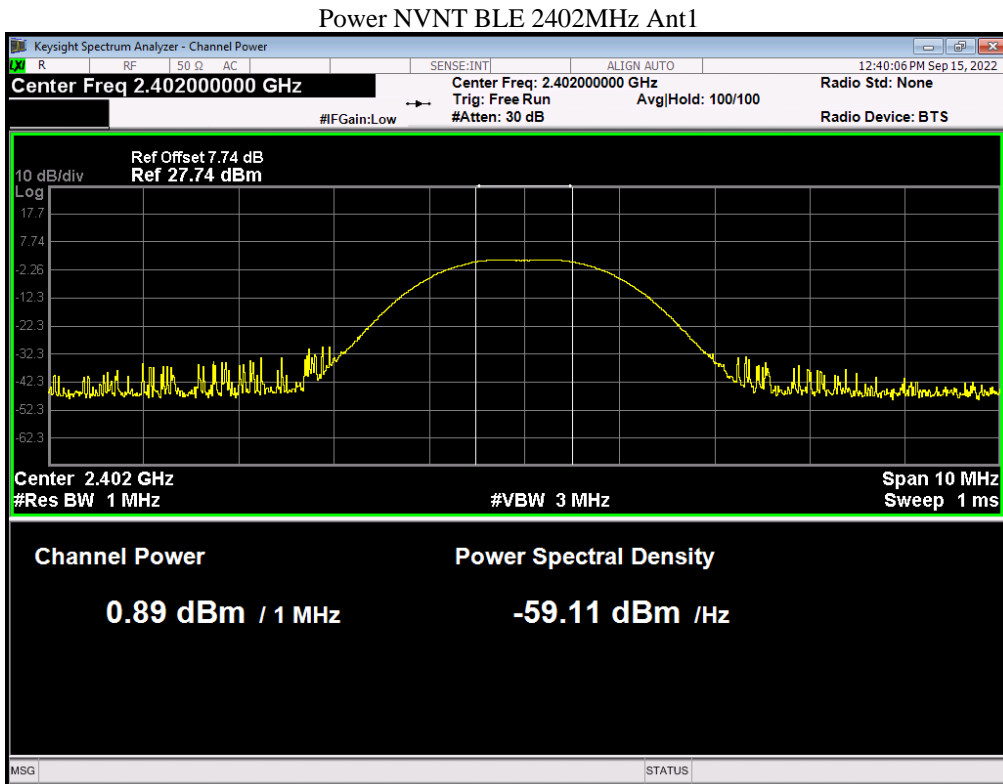

Power NVNT BLE 2440MHz Ant1

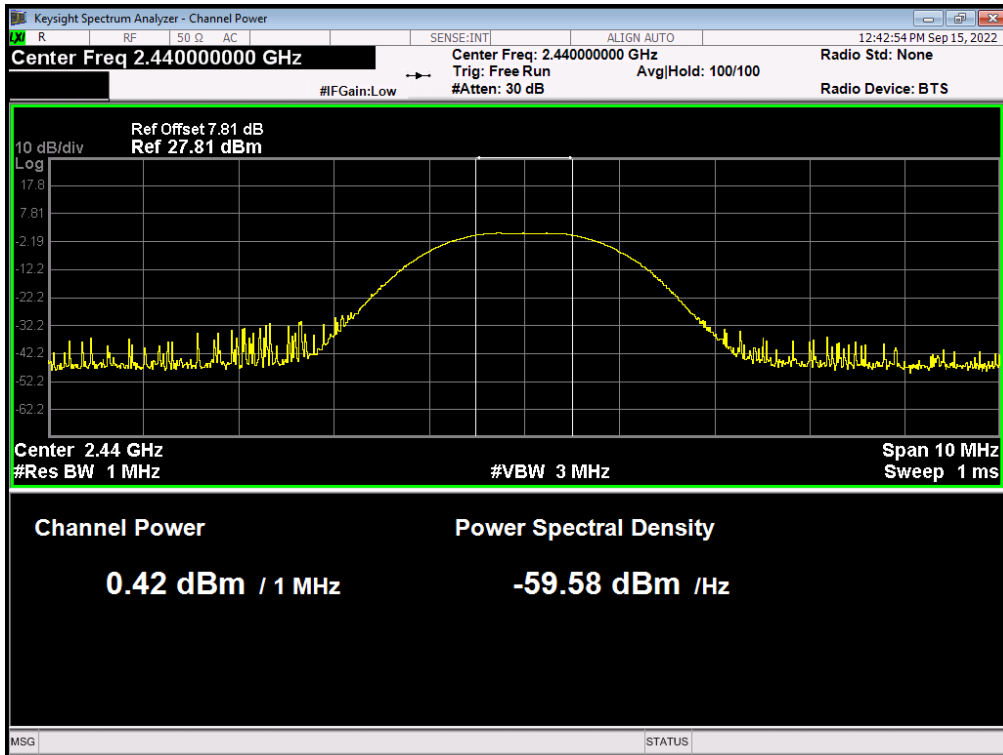

Power NVNT BLE 2480MHz Ant1

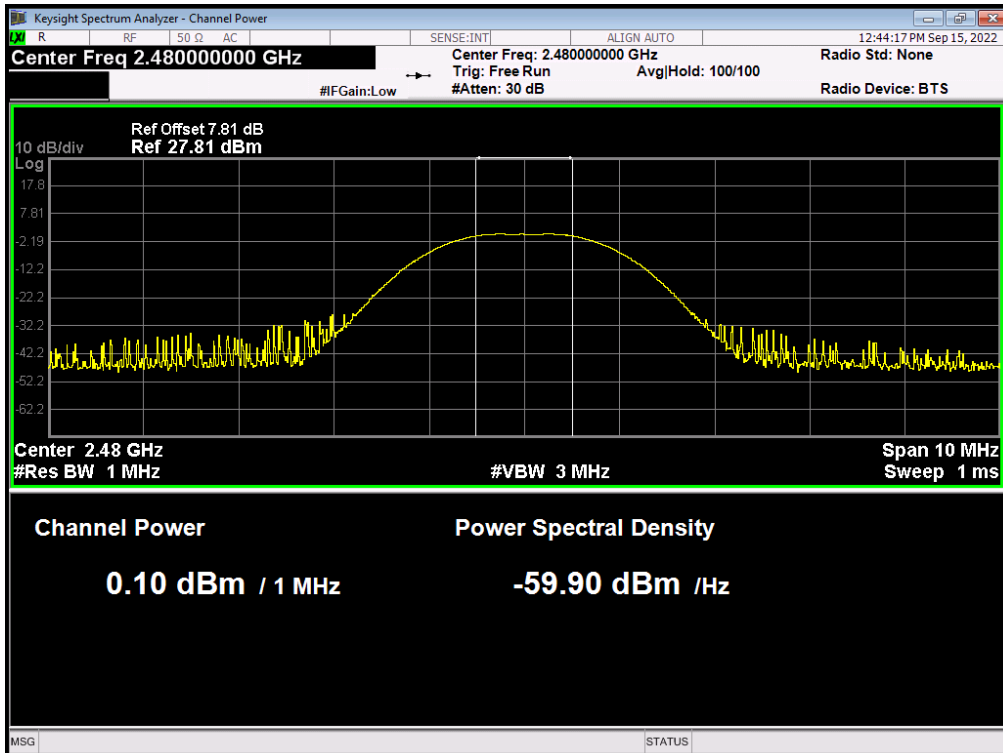

7. -6dB Bandwidth Test

7.1. Applied procedures / limit

Systems using digital modulation techniques may operate in the 902–928MHz, 2400–2483.5 MHz, and 5725–5850MHz bands. The minimum 6 dB bandwidth shall be at least 500 kHz.

7.2. Test procedure

- a. The EUT was directly connected to the spectrum analyzer and antenna output port as show in the block diagram below.
- b. Span = approximately 2 to 3 times the 20 dB bandwidth, centered on a hopping channel
RBW \geq 1% of the 20 dB bandwidth, VBW \geq RBW, Sweep = auto, Detector function = peak
Trace = max hold

7.3. Deviation from standard

No deviation.

7.4. Test setup

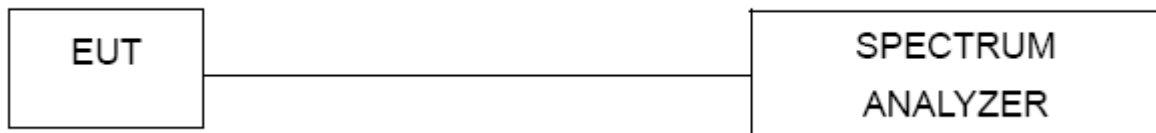

7.5. Test results

| Condition | Mode | Frequency (MHz) | Antenna | 99% OBW (MHz) | -6 dB Bandwidth (MHz) | Limit -6 dB Bandwidth (MHz) | Verdict |
|-----------|------|-----------------|---------|---------------|-----------------------|-----------------------------|---------|
| NVNT | BLE | 2402 | Ant 1 | 1.0718 | 0.712 | 0.5 | Pass |
| NVNT | BLE | 2440 | Ant 1 | 1.0898 | 0.6551 | 0.5 | Pass |
| NVNT | BLE | 2480 | Ant 1 | 1.056 | 0.6249 | 0.5 | Pass |

OBW NVNT BLE 2402MHz Ant1

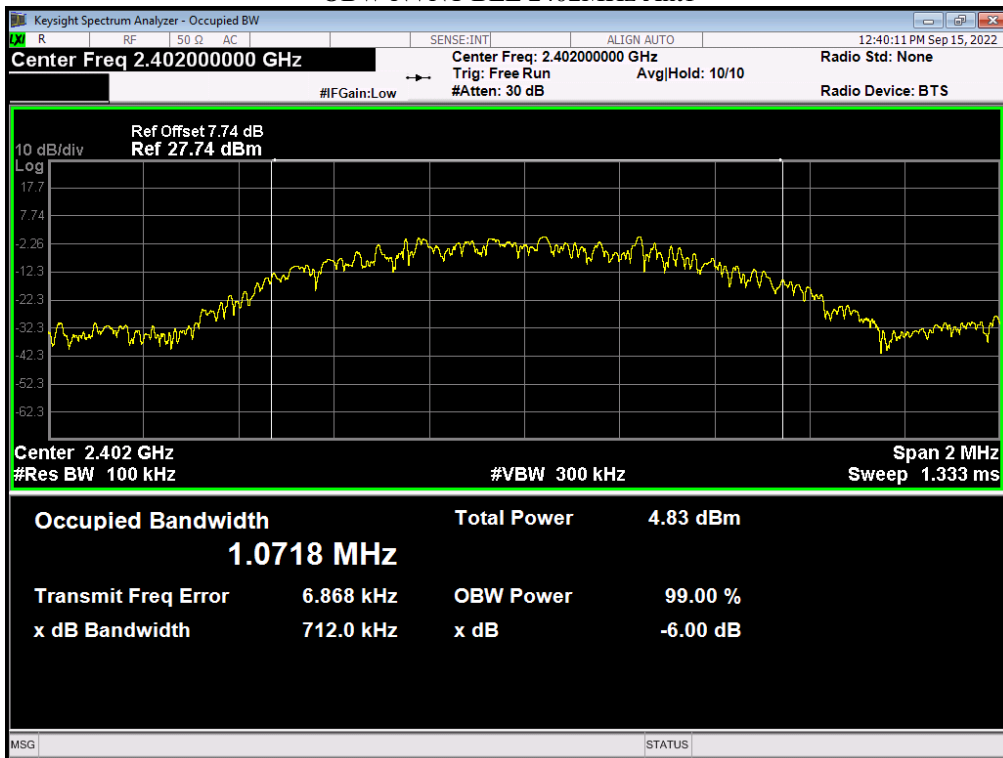

OBW NVNT BLE 2440MHz Ant1

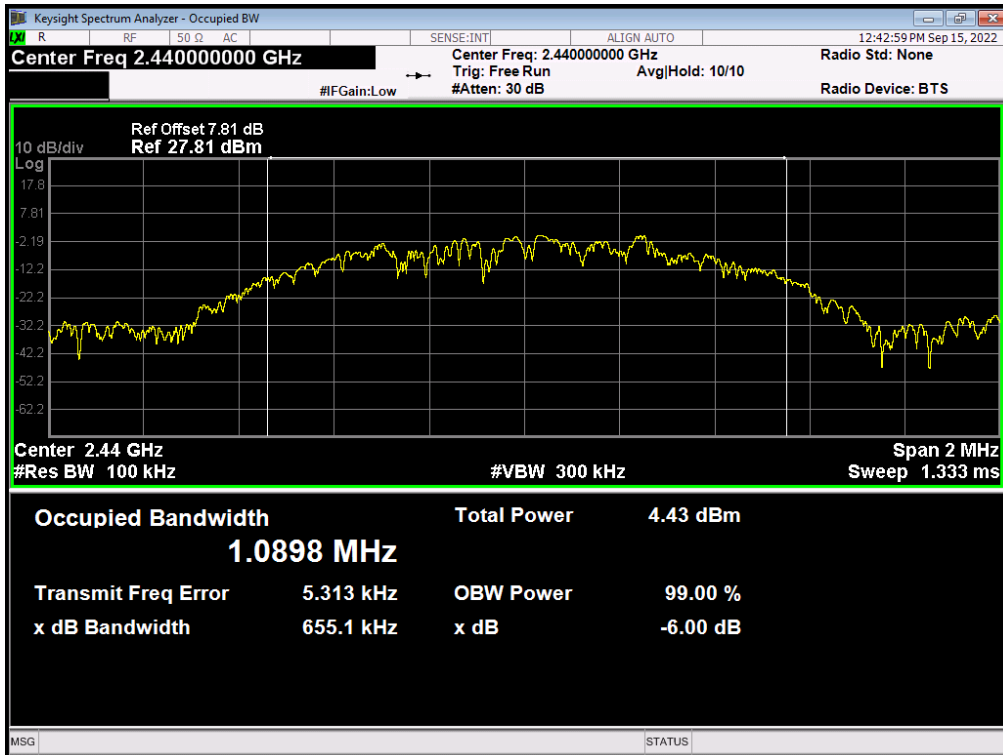

OBW NVNT BLE 2480MHz Ant1

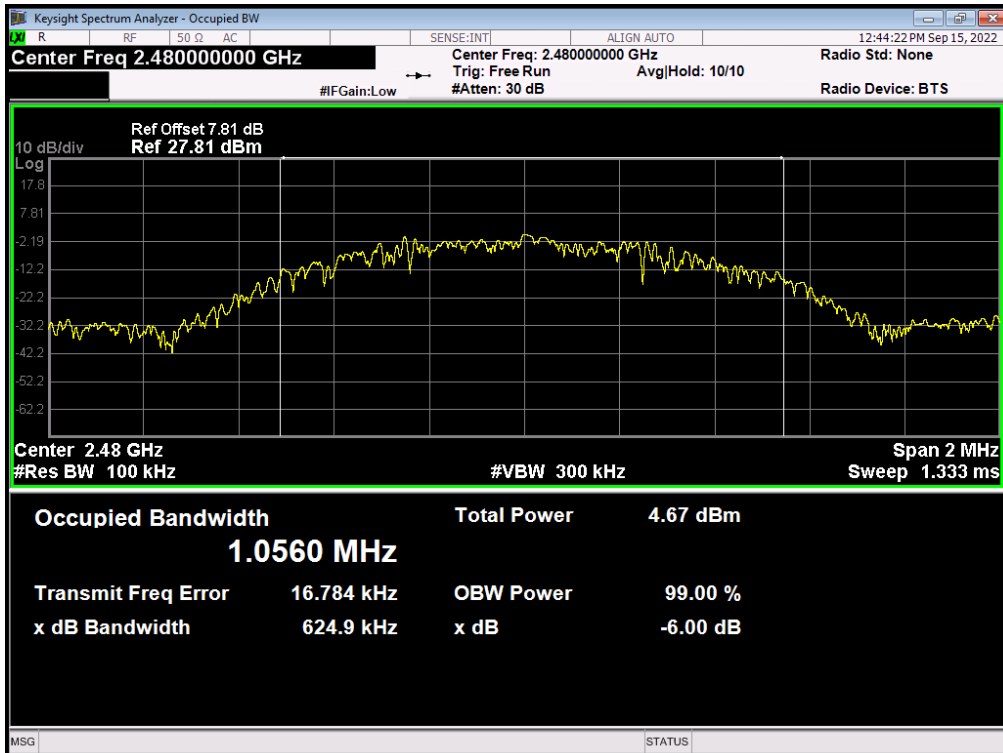

8. Power Spectral Density

8.1. Applied procedures / limit

For digitally modulated systems, the power spectral density conducted from the intentional radiator to the antenna shall not be greater than 8dBm in any 3 kHz band during any time interval of continuous transmission. This power spectral density shall be determined in accordance with the provisions of paragraph (b) of this section. The same method of determining the conducted output power shall be used to determine the power spectral density.

8.2. Test procedure

The RF output of the EUT was connected to the spectrum analyzer. Set the fundamental frequency as the center frequency of the spectral analyzer. Use RBW=3kHz , VBW= 10KHz , Set the span to 1.5 times the DTS channel bandwidth. Detector = peak, Sweep time = auto couple , Trace mode = max hold. Measure the Power Spectral Density (PSD) and record the results in dBm.

8.3. Deviation from standard

No deviation.

8.4. Test setup

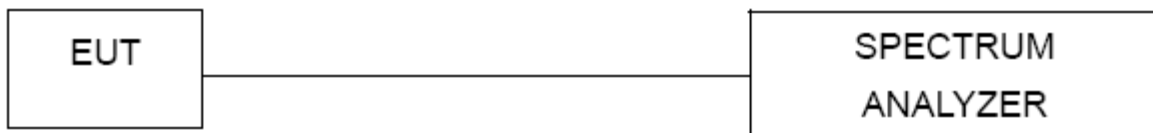

8.5. Test results

| Condition | Mode | Frequency (MHz) | Antenna | Max PSD (dBm/3kHz) | Limit (dBm/3kHz) | Verdict |
|-----------|------|-----------------|---------|--------------------|------------------|---------|
| NVNT | BLE | 2402 | Ant 1 | -14.151 | 8 | Pass |
| NVNT | BLE | 2440 | Ant 1 | -14.722 | 8 | Pass |
| NVNT | BLE | 2480 | Ant 1 | -15.047 | 8 | Pass |

PSD NVNT BLE 2402MHz Ant1

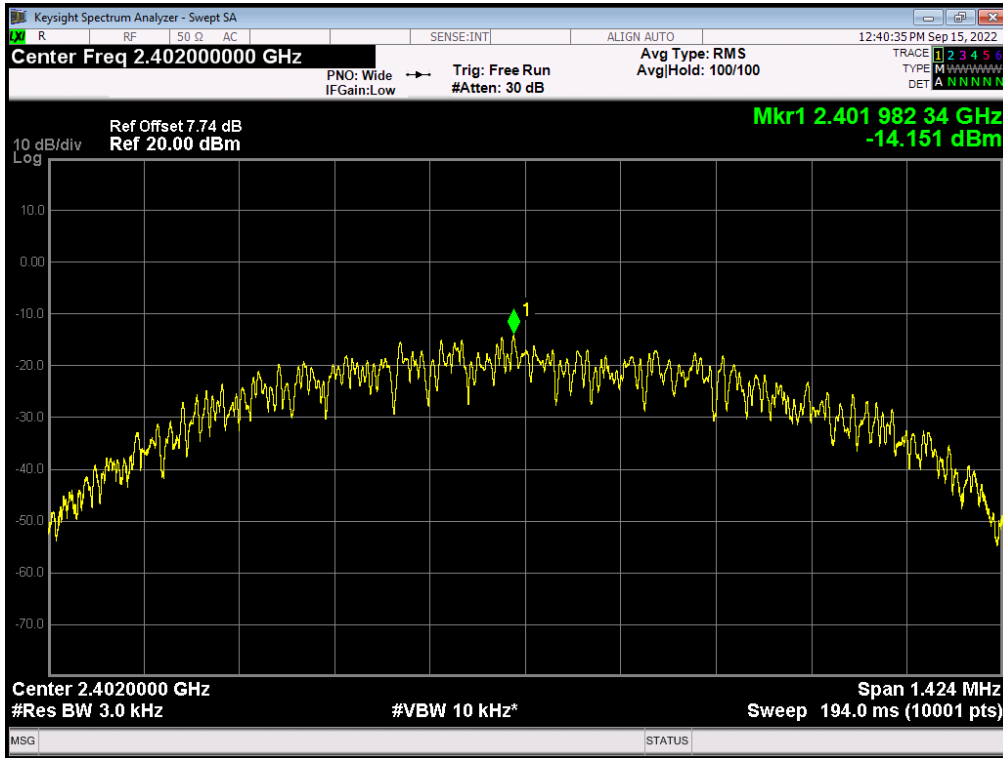

PSD NVNT BLE 2440MHz Ant1

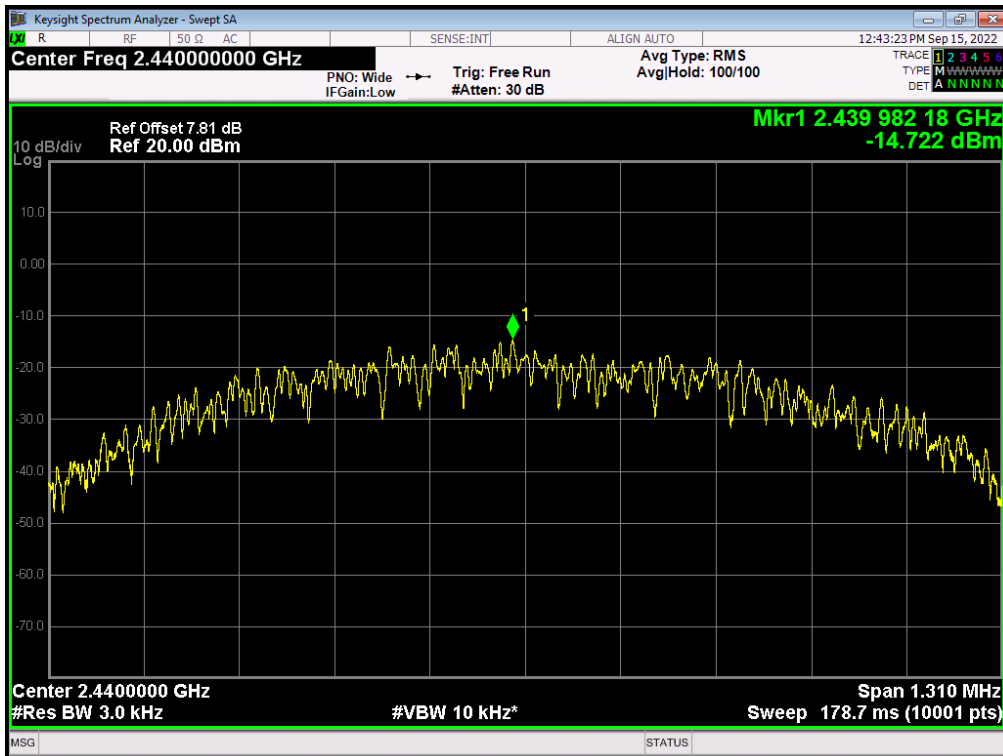

PSD NVNT BLE 2480MHz Ant1

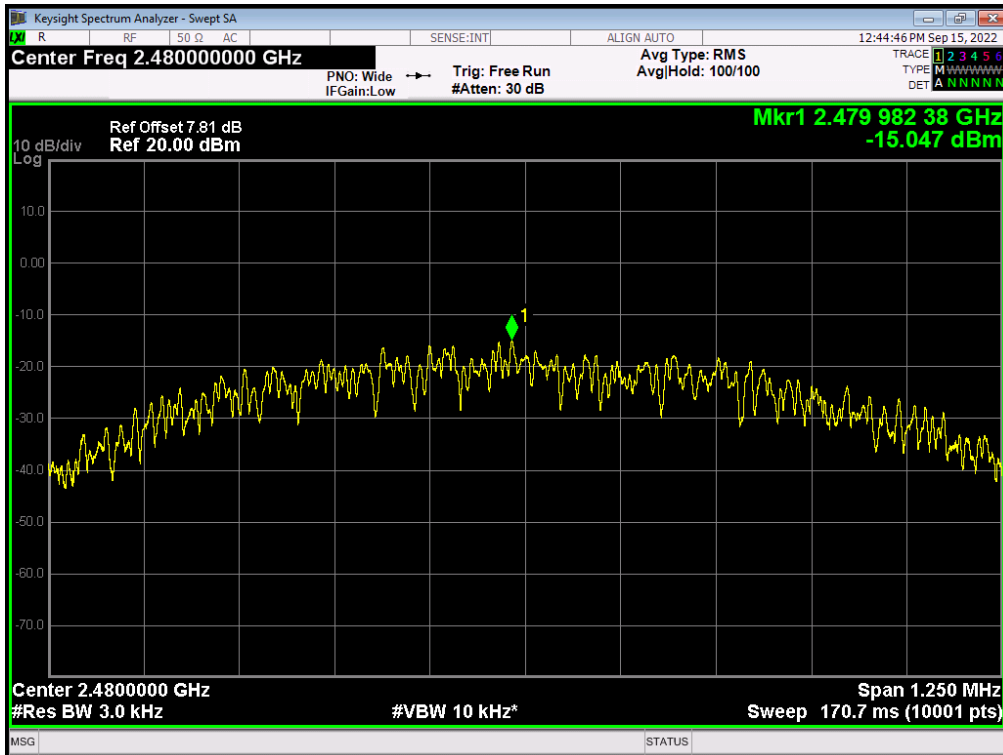

9. Band Edge

9.1. Applied procedures / limit

15.247(d) In any 100 kHz bandwidth outside the frequency band in which the spread spectrum or digitally modulated intentional radiator is operating, the radio frequency power that is produced by the intentional radiator shall be at least 20 dB below that in the 100 kHz bandwidth within the band that contains the highest level of the desired power, based on either an RF conducted or a radiated measurement, provided the transmitter demonstrates compliance with the peak conducted power limits. If the transmitter complies with the conducted power limits based on the use of RMS averaging over a time interval, as permitted under paragraph (b)(3) of this section, the attenuation required under this paragraph shall be 30 dB instead of 20 dB. Attenuation below the general limits specified in Section 15.209(a) is not required. In addition, radiated emissions which fall in the restricted bands, as defined in Section 15.205(a), must also comply with the radiated emission limits specified in Section 15.209(a) (see Section 15.205(c)).

9.2. Test procedure

- a. The EUT was directly connected to the spectrum analyzer and antenna output port as show in the block diagram below.
- b. Span = wide enough to capture the peak level of the emission operating on the channel closest to the band edge, as well as any modulation products which fall outside of the authorized band of operation, $RBW \geq 1\%$ of the span, $VBW \geq RBW$, Sweep = auto, Detector function = peak, Trace = max hold

9.3. Deviation from standard

No deviation.

9.4. Test setup



9.5. Test results

| Condition | Mode | Frequency (MHz) | Antenna | Max Value (dBc) | Limit (dBc) | Verdict |
|-----------|------|-----------------|---------|-----------------|-------------|---------|
| NVNT | BLE | 2402 | Ant 1 | -58.517 | -30 | Pass |
| NVNT | BLE | 2480 | Ant 1 | -53.156 | -30 | Pass |

Band Edge NVNT BLE 2402MHz Ant1 Ref

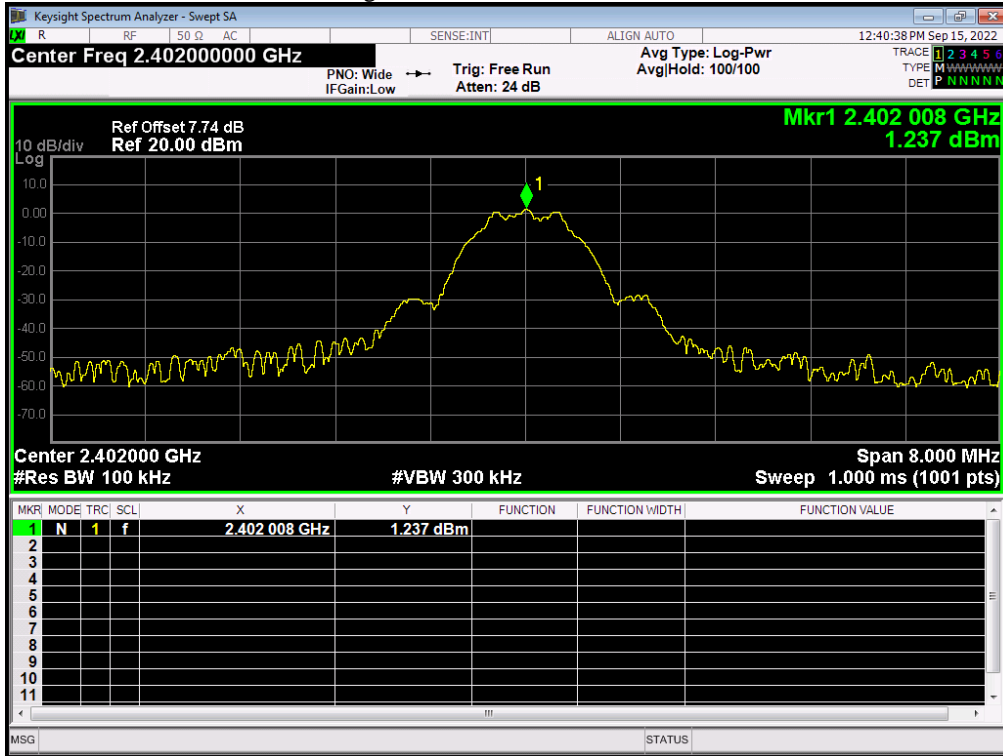

Band Edge NVNT BLE 2402MHz Ant1 Emission

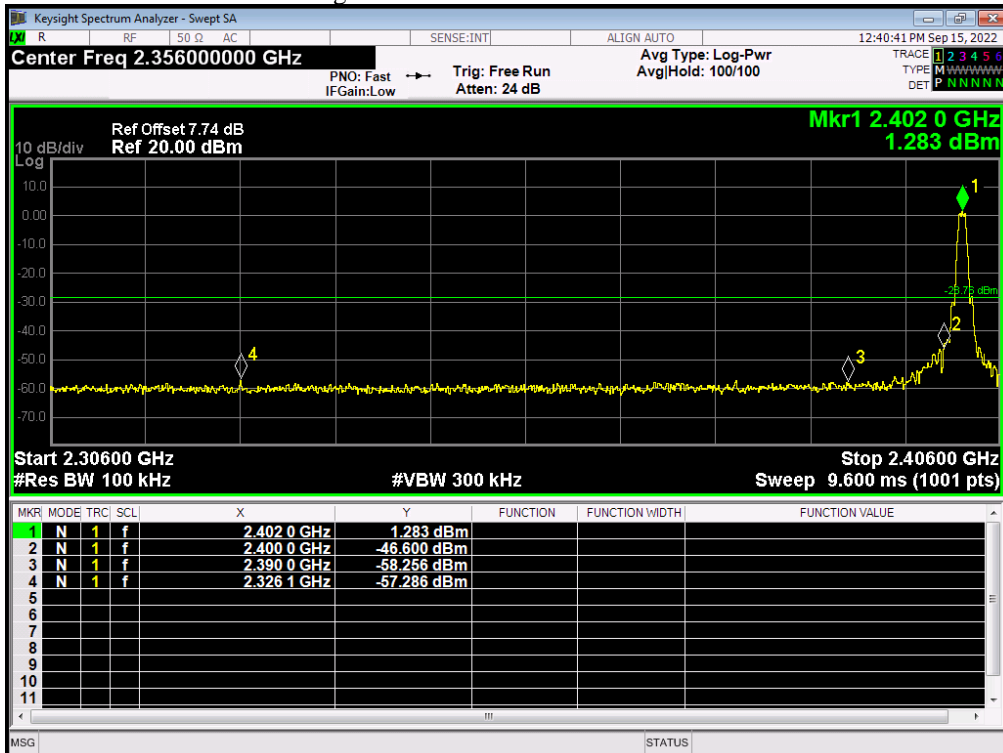

Band Edge NVNT BLE 2480MHz Ant1 Ref

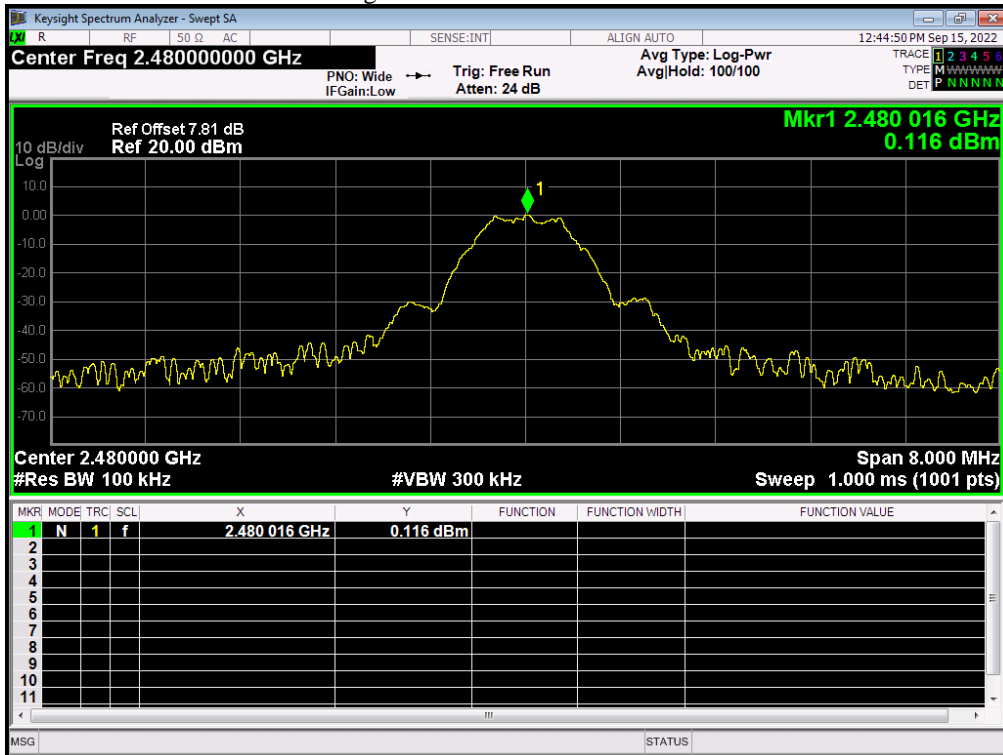

Band Edge NVNT BLE 2480MHz Ant1 Emission

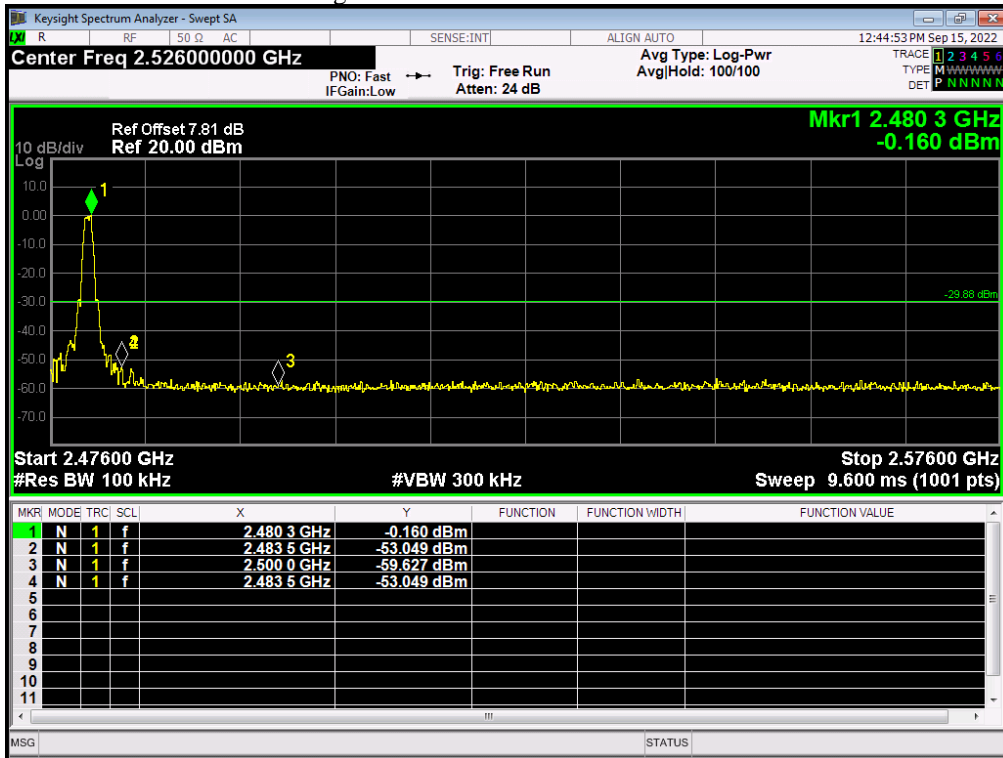

10. Conducted Spurious Emissions

10.1. Applied procedures / limit

15.247(d) In any 100 kHz bandwidth outside the frequency band in which the spread spectrum or digitally modulated intentional radiator is operating, the radio frequency power that is produced by the intentional radiator shall be at least 20 dB below that in the 100 kHz bandwidth within the band that contains the highest level of the desired power, based on either an RF conducted or a radiated measurement, provided the transmitter demonstrates compliance with the peak conducted power limits. If the transmitter complies with the conducted power limits based on the use of RMS averaging over a time interval, as permitted under paragraph (b)(3) of this section, the attenuation required under this paragraph shall be 30 dB instead of 20 dB. Attenuation below the general limits specified in Section 15.209(a) is not required. In addition, radiated emissions which fall in the restricted bands, as defined in Section 15.205(a), must also comply with the radiated emission limits specified in Section 15.209(a) (see Section 15.205(c)).

10.2. Test procedure

- a. The EUT was directly connected to the spectrum analyzer and antenna output port as show in the block diagram below.
- b. Span = wide enough to capture the peak level of the in-band emission and all spurious emissions (e.g., harmonics) from the lowest frequency generated in the EUT up through the 10th harmonic. Typically, several plots are required to cover this entire span. RBW = 100 kHz
VBW ≥ RBW, Sweep = auto, Detector function = peak, Trace = max hold
sweep points ≥ investigated frequency range/RBW.

10.3. Deviation from standard

No deviation.

10.4. Test setup



10.5. Test results

| Condition | Mode | Frequency (MHz) | Antenna | Max Value (dBc) | Limit (dBc) | Verdict |
|-----------|------|-----------------|---------|-----------------|-------------|---------|
| NVNT | BLE | 2402 | Ant 1 | -40.983 | -20 | Pass |
| NVNT | BLE | 2480 | Ant 1 | -40.533 | -20 | Pass |

Tx. Spurious NVNT BLE 2402MHz Ant1 Ref

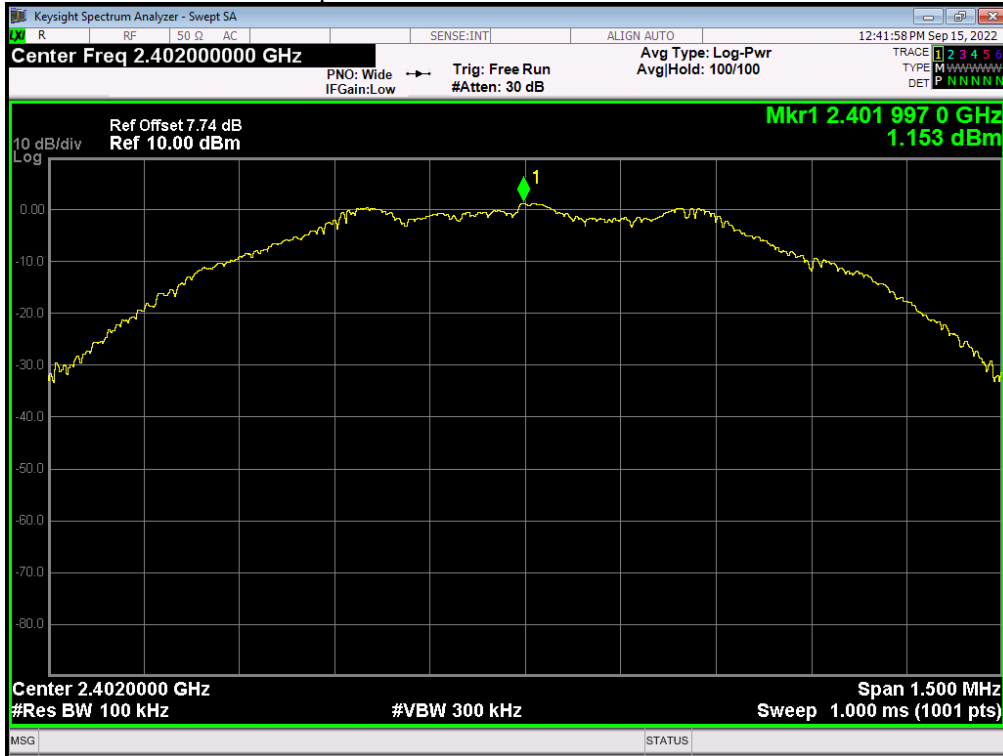

Tx. Spurious NVNT BLE 2402MHz Ant1 Emission

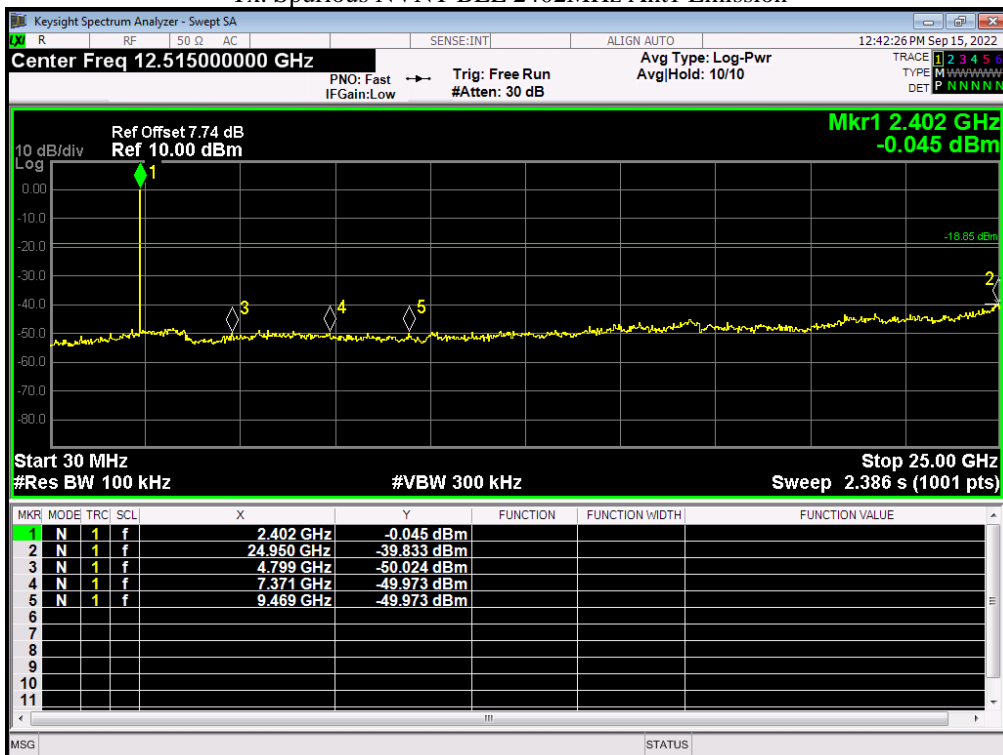

Tx. Spurious NVNT BLE 2480MHz Ant1 Ref

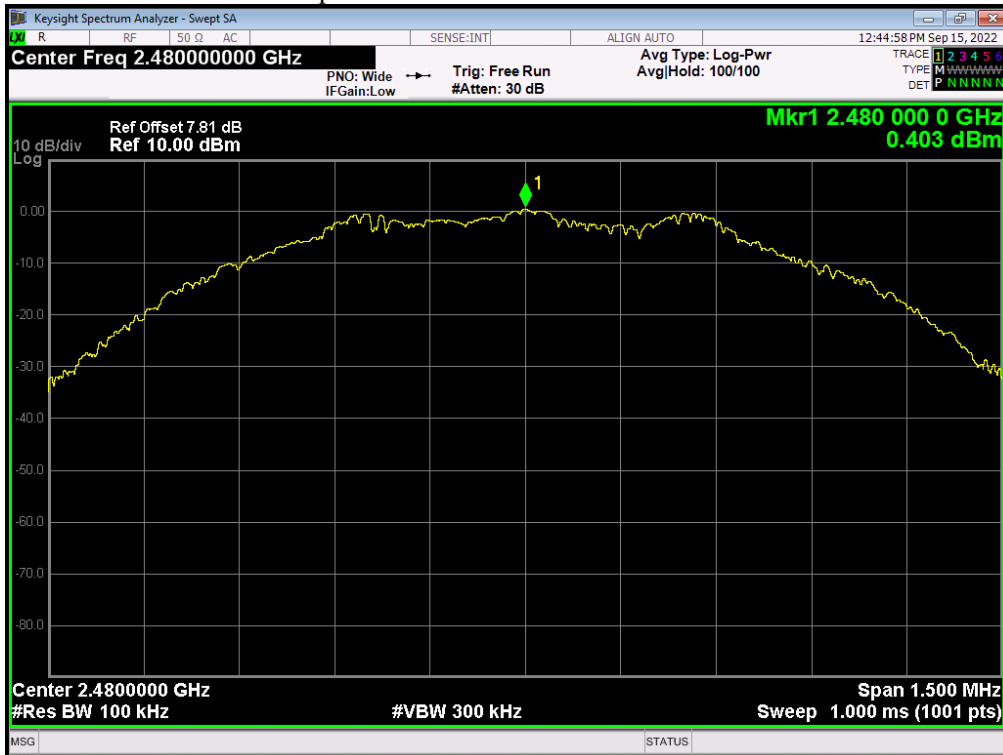

Tx. Spurious NVNT BLE 2480MHz Ant1 Emission

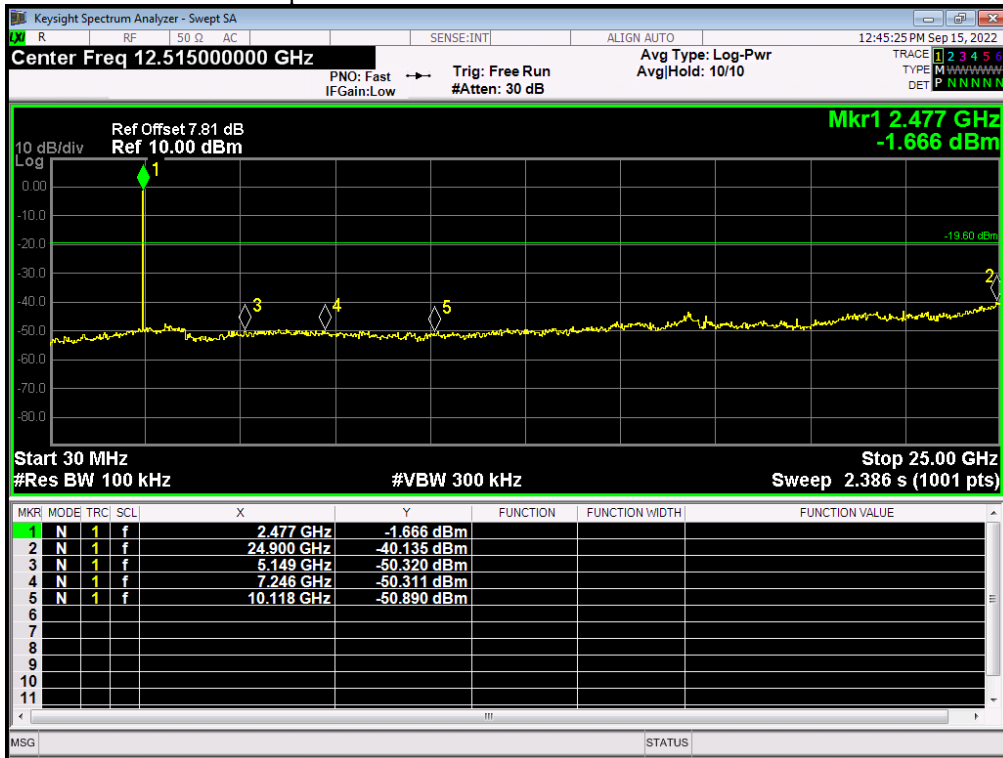

11. Antenna Requirement

11.1. Standard requirement

15.203 requirement: For intentional device, according to 15.203: an intentional radiator shall be designed to ensure that no antenna other than that furnished by the responsible party shall be used with the device. 15.247(c) (1)(i) requirement: (i) Systems operating in the 2400-2483.5 MHz band that is used exclusively for fixed. Point-to-point operations may employ transmitting antennas with directional gain greater than 6dBi provided the maximum conducted output power of the intentional radiator is reduced by 1 dB for every 3 dB that the directional gain of the antenna exceeds 6dBi.

11.2. EUT Antenna

The antenna is Integral Antenna and no consideration of replacement. Antenna gain is Maximum -1.63dBi from 2.4GHz to 2.5GHz.

12. Test setup photograph

Photos of power line conducted emission test



Photos of radiated emission test
30MHz – 1GHz



Photos of radiated emission test

Above 1GHz



13. Photos of the EUT

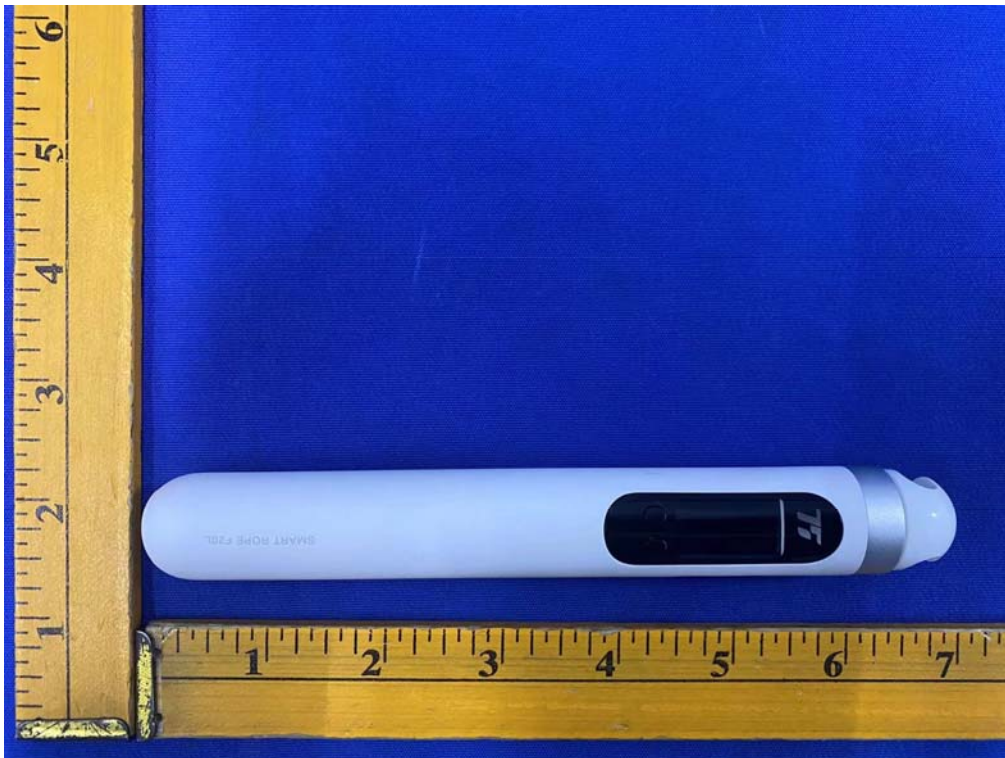

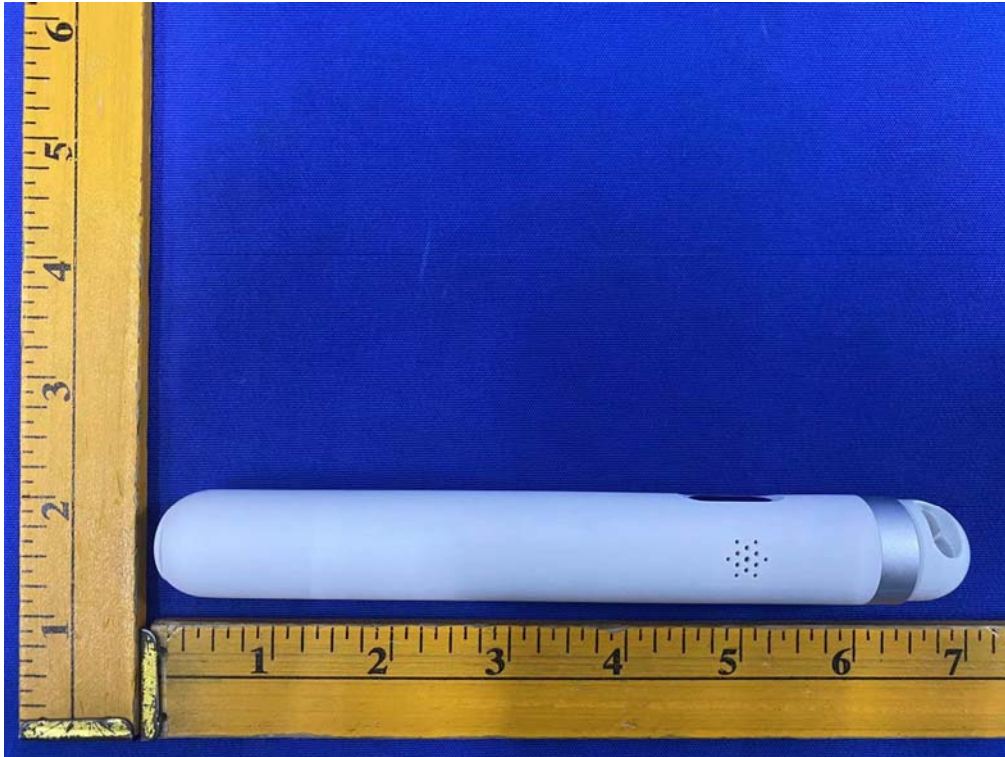





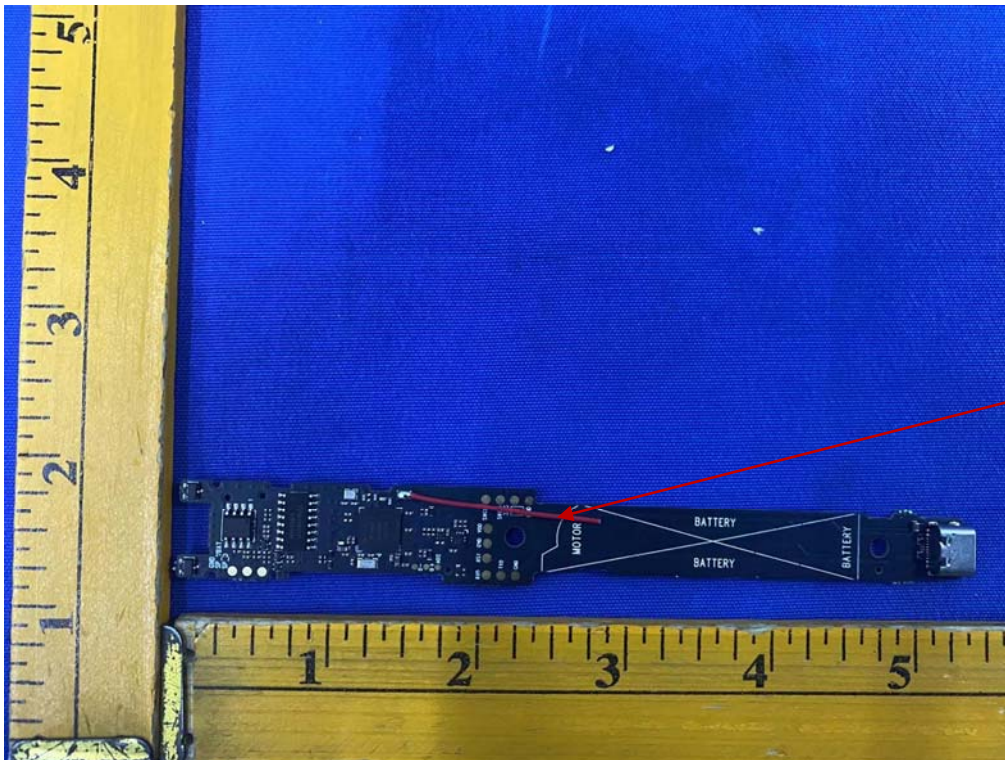

Antenna

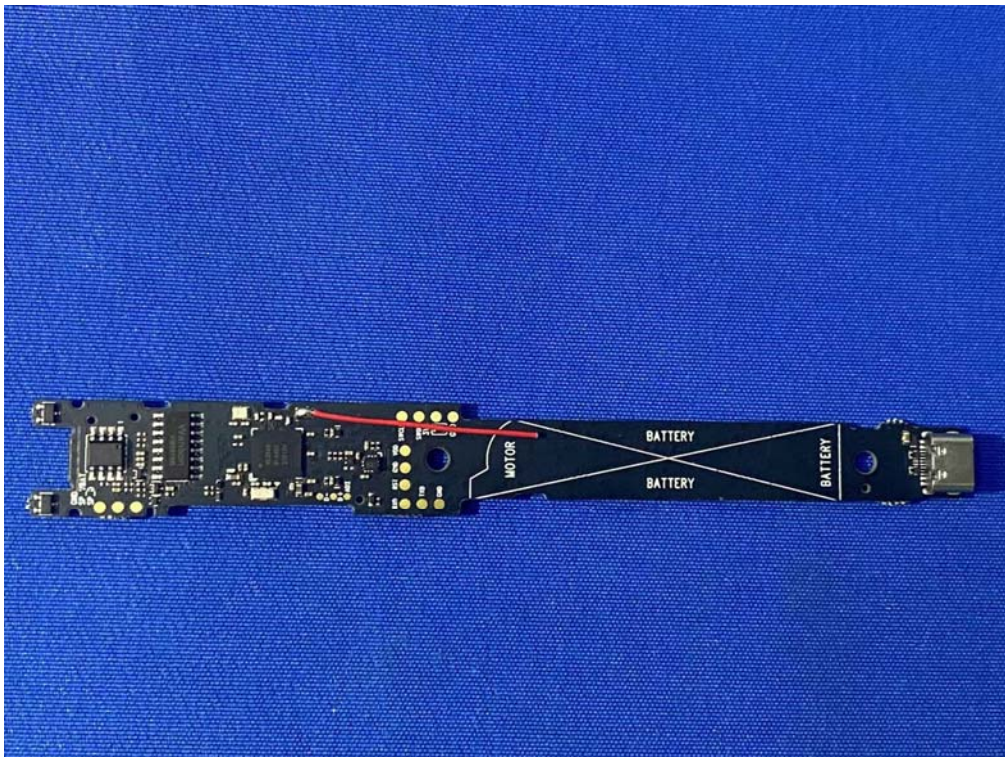
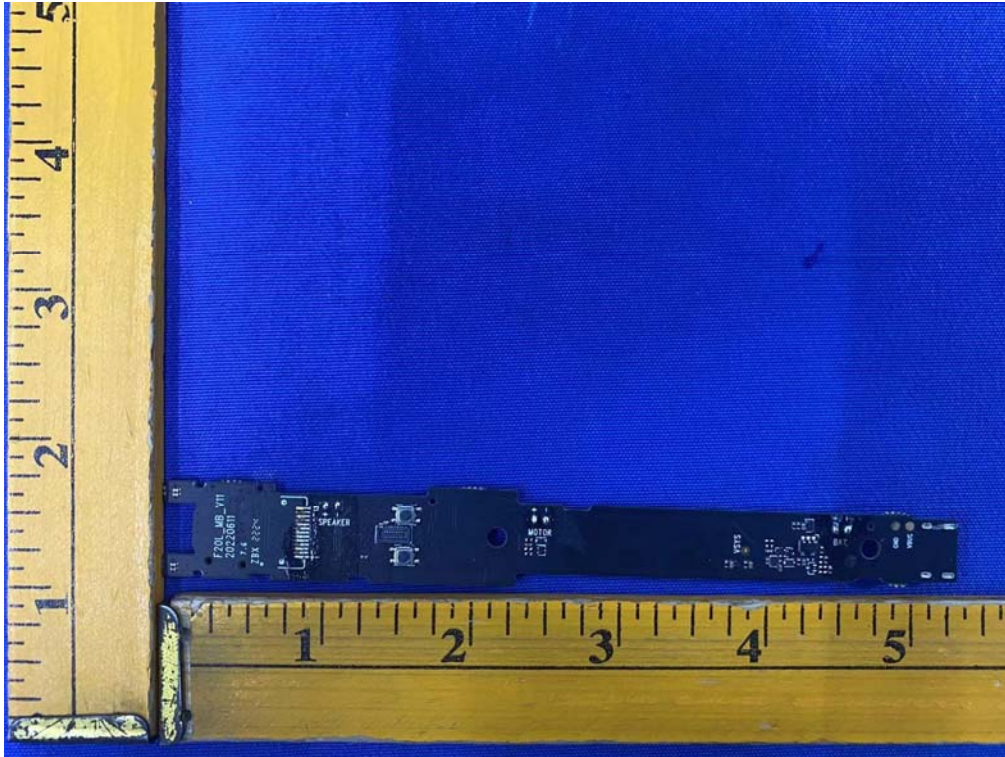

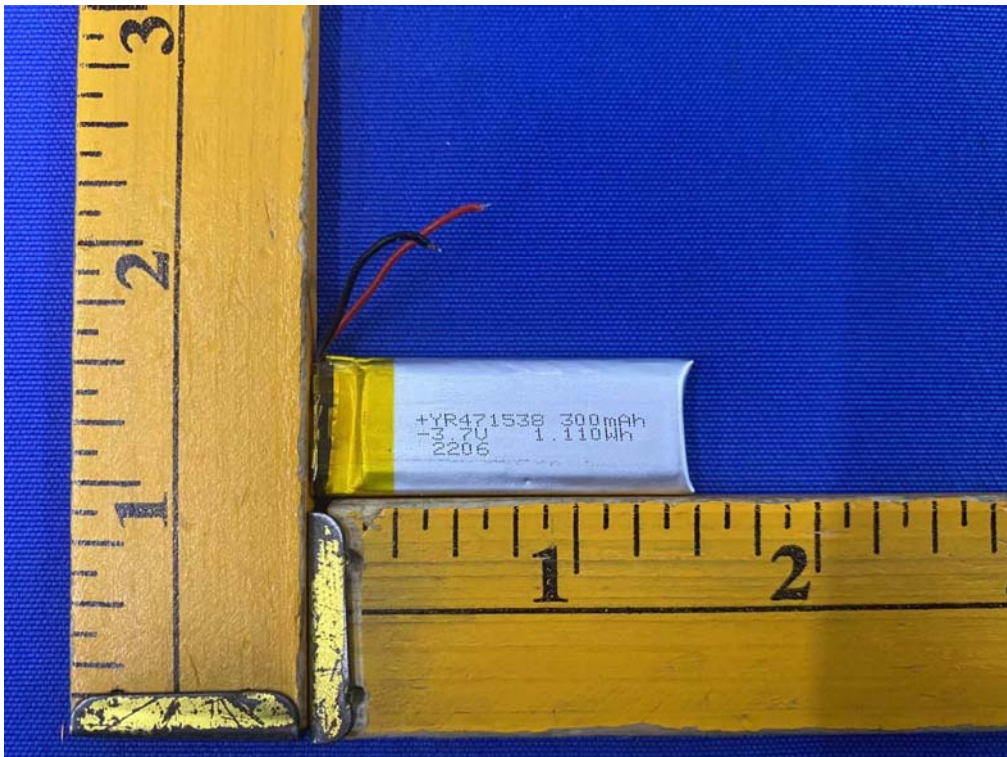
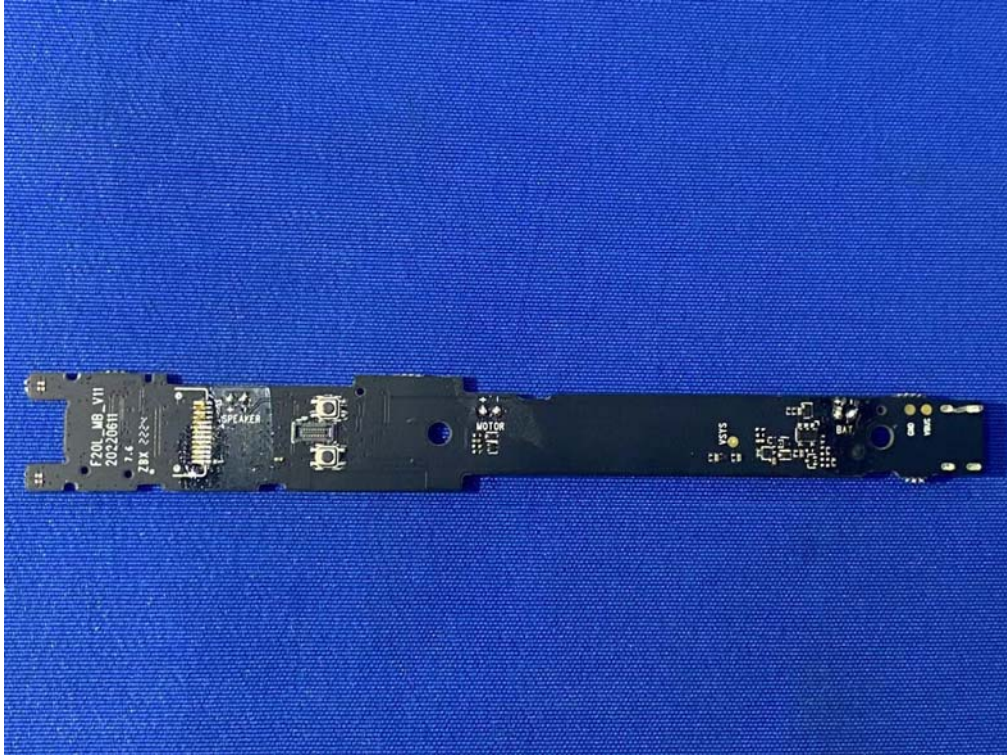

--END OF REPORT--