

Catalog

Precautions	2
Brief Introduction	2
Installation Notice	5
System Function	10
System Setting Method	11
Warning Status	13
Setting Index	
(1) Sensor ID Learn and Pair	14
(2) Sensor Postion Exchange	17
(3) Alarm threshold adjustment	20
(4) Temperature and Pressure Unit Setting	23
(5) Selection interface of vehicle tire number and sensor installation postion	26
Product Technical Parameters	30
Troubleshooting	34
Guarantee	35
Warranty Card	end

1、Precautions

- Before you install this product, read this manual to prevent the system from working improperly after installation
- The product can effectively monitor the tire to prevent tire puncture, but can not guarantee to avoid any unexpected accidents, the user should use the system to ensure that the car under normal tire pressure conditions and to avoid the use of poor quality or wear Serious tire.
- Users are not allowed to open, repair or modify this product, so as to avoid damage to the internal circuit.
- When the tire pressure and temperature abnormalities, the system can be issued by the receiver sound, light alarm, the user does not need to always observe the system display, so as not to affect traffic safety.
- Even the vehicle is equipped with the TPMS system, we still strongly advise users to regularly check the car tires to ensure traffic safety.

2、Brief Introduction

1-1 Brief introduction to working principle

The system consists of sensors, repeaters and receivers for real-time monitoring of tire pressure and temperature. After the sensor collects the pressure and temperature data in the tire, it sends it by radio frequency. The repeater can receive the pressure and temperature data sent by the sensor and forward the information to the receiver. When the tire pressure or temperature is higher or lower than the preset alarm threshold, the receiver will automatically send the appropriate alarm to remind the user to pay attention to the tire status and timely treatment, in order to avoid a flat tire and damage the accident tire. Through the operation of the system, can help the driver to maintain the normal pressure of the vehicle. But also can

enhance the vehicle comfort and dynamic performance; effective prevention of tire puncture and reduce tire safety accidents hidden dangers; reduce fuel consumption, reduce tire wear and extend tire life; thus effectively reducing operating costs.

1-2 Special Note

- 1、 During the driving process, due to the friction caused by the tire thermal expansion and contraction, pressure and temperature there will be high or low changes, this is normal.
- 2、 When the tire pressure is too high or the tire pressure is too low, care should be taken to prevent flat tire; it is recommended to maintain the standard tire pressure value of the vehicle label.
- 3、 This product will real-time monitor the tires and alarm on the abnormal conditions, drivers do not need to pay attention to the display receiving unit too much while driving, so as to avoid distractions and affect traffic safety.
- 4、 Under normal circumstances the tire will have a natural phenomenon of natural leakage, the tire pressure decreases over time, this is normal, and the installation of this product is not directly related.
- 5、 The sensor and monitor are wirelessly connected and the transmission distance is long enough. Product design has a number of anti-jamming features, the possibility of interference is very low but does not rule out the use of products due to interference and abnormalities.
- 6、 Please use this product correctly and use it within its permissible range. If it is beyond the scope of its use, the company will not be responsible for all the consequences arising therefrom!
- 7、 This product can function abnormal tire pressure monitoring, display, remind(alarm), but it can not eliminate the occurrence of puncture accident.
- 8、 The contents of this manual are subject to change without notice.

1-3 Features

- Easy to install, Perfect match between embedded monitor and original car interior;
- Button sensitive, easy to operate and learn, set up and query integration;
- White, elegant backlight display data is clearly visible;
- Supports up to 18 tires pressure / temperature monitoring simultaneously;
- Tire cycle display, data information, alarm icon at a glance, easy to observe;
- A variety of pressure / temperature unit selection;
- Independently set the tire high pressure / low pressure / temperature alarm standard value;
- Low pressure, high pressure, high temperature, leakage and other alarm functions integrated;
- Sound, flashing and other alarm methods, suitable for commercial vehicles noisy environment.

3、 Installation Notes

(1) Display Receiver Installation

1. Installation Diagram

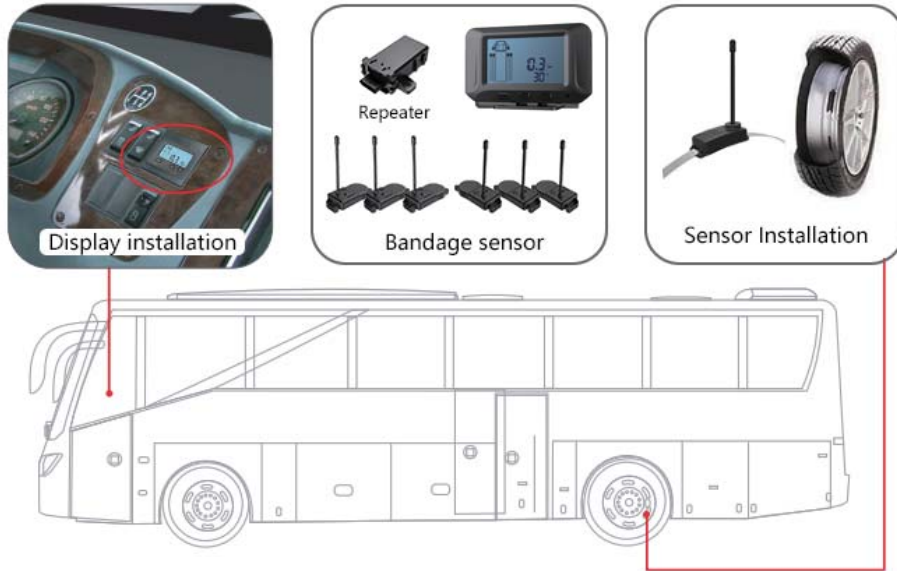

2. Display Receiver Installed on the Vehicle

(1) Display Receiver Installation

Having a slot opening in the center console in the appropriate location according to the size of the receiver ; the receiver power cord and car power supply line corresponding connection; the embedded display into, so completely consistent with the stuck. See below



① Dashboard
Slotted in place



② Installed on
the dashboard



③ Renderings

(2) Sensor installation

1、 Bandage Sensor Installation



① The steel tie around
the hub



② Put the sensor on
the steel tie



③ Pre tighten steel tie
screw



④ Installing non-slip
rubber pad



⑤ Tighten the steel tie
screw



⑥ Installation Completed

⚠ Remarks

- ①The sensor should be installed close to the valve, which will be more convenient for the receiver and sensor pairing and checking after the tire is installed.
- ②After the sensor has been installed to check the sensor is loose, be sure to tighten the screws on the cable tie.
- ③As a result of installation causes leakage, and thus cause failure, the Company does not assume joint responsibility and direct responsibility.

2. External sensor install



Lock the Anti-theft screw



Installation the sensor



Reverse fixed sensors and screw



To sure the strong and safety

External Sensor battery replacement step

- 1、 Tear down the shell;
- 2、 Remove the old battery and place good
- 3、 Install the new battery;
- 4、 The shell installed;

7

(3) Repeater Installation

1. Installation location selection

- (1)The installation position of intelligent repeater should be in the position of the relatively empty. It can't be lower than the cross beam of car chassis nearest to ground, but must close to the trailer tire(as picture below)
- (2)If there is no suitable trailer in the middle of the installation position can also choose to against the side of the trailer.
- (3)There must be no metal surface surrounded by three sides around the repeater

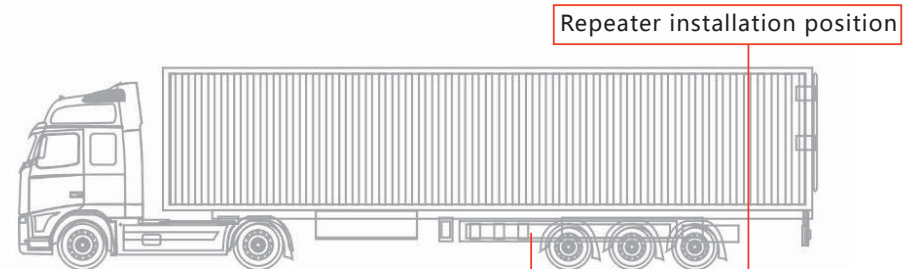

2. Installation Method

- (1)As Diagram

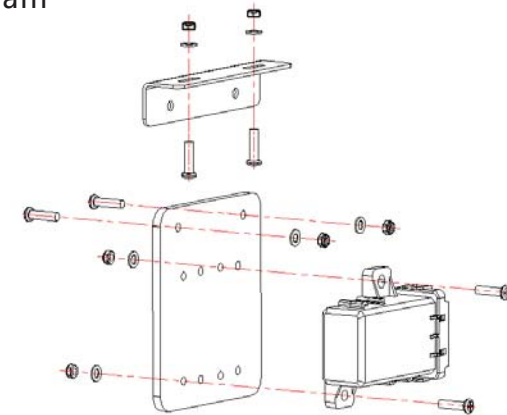

8

(2) Effect picture after installation (Vertical to the car chassis beams)

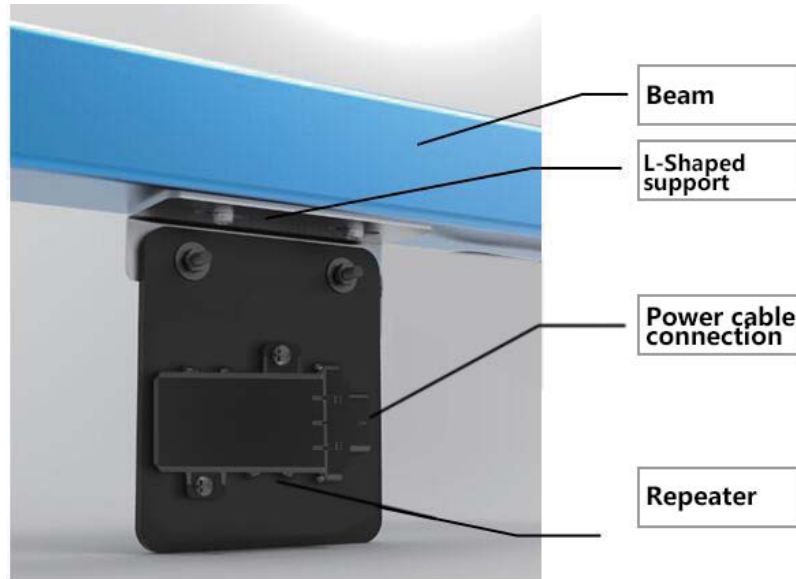

⚠ Remarks

- (1) Repeater power supply has two cores, the red power line connected to the truck often positive power supply(VCC), black power line connected to the GND, and with a fixed cable tie to prevent wear and tear short circuit
- (2) Make sure that the input voltage is compatible with the repeater's voltage range and connect the power cord according to the marked positive and negative positions.
- (3) Please connect a repeater to the vehicle at a normal open power position and connect a 2A water-proof fuse to ensure the safety of the circuit.

4、 System Function

(1) Turn on/Turn off the display receiver

Display receiver will start to turn on and work upon the vehicle powering on

(2) Description of Display button function

1. As diagram



OK : confirm key SET : set key ↶ : return key

2. Receiver Icon definition

Icon	Description
	Tire symbol
	Tire pressure abnormal symbol
	Tire leakage symbol

Pressure unit : Bar or Psi , optional
 Temperature unit : °C or °F , optional

(3)Main display interface

1.tire mode

Imitation truck shape, the upper is the vehicle head, the lower is the vehicle body. Each tire is represented by a small, rectangular icon with up to 18 tires (front 2 rear 16)..

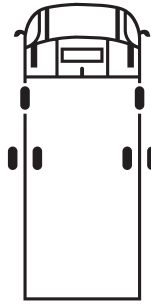

2.Receiver working status

After the boot, the receiver is in working condition, the display screen displays the pressure and temperature of each tire cyclically every 6 seconds, and the tire in the specific position flashes

3.Data up and down checking

When under working status, press ↶ to check above tire' s data and press "SET" to check below tire' s data.

5、 System Setting Method

⚠ Remarks

Note: System Preset in factory,if correct installation and normal use, do not have to operate the following settings.

(1)Enter system setting mode

When it is under normal working status, long press "SET" key for 3 seconds, enter the first setting, the screen will display "P1" , Shortly press "SET" key 1 second each time, number plus 1, it will switch from P1 to P5 circularly.Press "ok" key to enter setting. Press ↶ key or no press any key approx. 10 minutes, it will exit to normal working status.



(2)P1-P5 definition explanation

P1 : Sensor ID Learn

P2 : Sensor Postion Exchange

P3 : Tire pressure/temperature warning threshold value setting

P4 : Unit Setting

P5 : Vehicle tire number setting and sensor location setting

(3)Data Factory Default Setting

Item	Setting
Unit	Bar
High pressure warning data	12 Bar
Low pressure warning data	6 Bar
Temperature unit	°C
High temperature warning data	85 °C

Explanation :

Pressure unit : Psi (pounds per square inch) ; Bar





Temperature unit : °C (degrees Celsius) ; °F (degrees Fahrenheit)

Pressure unit conversion : 1Bar=100Kpa≈114.5Psi

Temperature unit conversion : 1°C=33.8°F

6、Warning Status

The receiver displays the tire pressure and temperature in turn every 6 seconds. When the tire pressure or temperature exceeds the safety range set by the user, the corresponding tire position on the receiver display and the corresponding parameters are blinking, the anomaly alarm icon (⚠) is displayed and the alarm sound promptly. Press the ⏪ key to turn off the alarm tone, but the anomaly warning icon (⚠) will be displayed until all tire faults are removed.

Low pressure warning	High pressure warning
<p>Correspondent tire icon blinks, meanwhile, shows LOW PRESSURE and tire pressure abnormal warning icon ; Icon shows the third tire low pressure warning.</p> 	<p>Correspondent tire icon blinks, meanwhile, shows HIGH PRESSURE and tire pressure abnormal warning icon ; Icon shows the third tire high pressure warning.</p> 
Air leakage warning	High temperature warning
<p>Correspondent tire icon and the small iron nail icon of tire abnormal icon blinks, meanwhile, shows FAST LEAKAGE and tire abnormal indicating icon ; Icon shows the third tire air leakage warning.</p> 	<p>Correspondent tire icon blinks, meanwhile, shows HIGH TEMP and temperature abnormal warning icon ; Icon shows the third tire high temperature warning.</p> 

13

7、Setting Index

(1) Sensor ID Learn and Pair

(Note: sensor preset in factory already,no need for this operation,only if the sensor or receiver is damaged and need a replacement)

1、 In the main interface, press "**SET**" key for 3 seconds, after hearing "beep", release the "**SET**" key, the screen displays the front left wheel blinking, and "**P1**" appears on the right side of the screen, which is the sensor learning Ask interface,as shown below:



2、 Press "**OK**" key at this time, confirm to enter learning pairing mode, the display will show the left front wheel is blinking, meanwhile "**00**" "**01**" appears on the right side of the screen, this is the sensor position learning interface, as shown below:



14

3、 In the above interface,you can switch the position of the tire that you want to learn and pair by pressing the "SET" key, and the corresponding tire position number will be displayed. Here,you can switch to the front right tire as an example;
 (01=left front wheel;02=front right wheel;03=Rear Left outer wheel;04=Rear Left inner wheel;05=Rear Right inner wheel;06=Rear Right outer wheel).
 tire position switch in turn like this:Front Left》 Front Right》 Rear Left outer wheel》 Rear Left inner wheel》 Rear Right inner wheel》 Rear Right outer wheel.

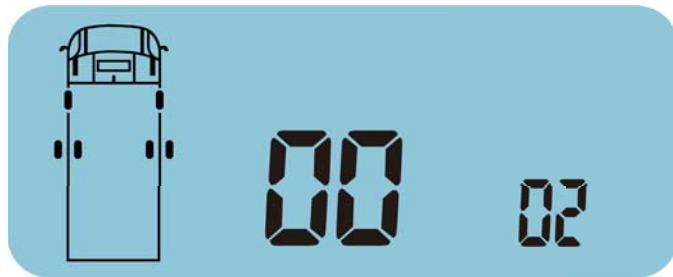

4、 4、 If in the second step, press the "OK" key,then enter the front left tire sensor pairing learning wait state.(At this point,if you press the ↵ key,it will return directly to step 2)The interface is shown as the following figure:

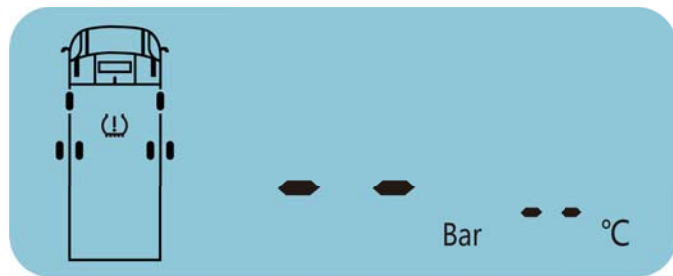

5、

- Built-in strap sensor(bandage sensor)At this point by inflating or deflating the front left (FR)sensor, the sensor is activated for pairing. (Deflation, the need for continuous 1-2 times deflated, and each deflated time of not less than 6s, inflated shall not exceed the maximum pressure of the tire.)
- External sensor: Remove the external sensor from the front left tire and re-install, activate the sensor work to match.

6、 Paired Learning is successful, the display will prompt "beep" sound and a new sensor ID code,then at the same time the wheel position will automatically jump to the next round. After all six tires have been paired successfully, the receiver will stay in the rear right(RR)display position and will no longer automatically jump.When paired learning is successful,press the ↵key,step by step to exit from operation.

⚠ Remarks

- ①During the pairing learning process, please ensure that the sensor operation is activated only for the tire on which one sensor is installed, otherwise, the ID that really needs to be learned can not be guaranteed to be learned into the display.
- ②Each process,you can press the ↵key to cancel the current operation of the steps,but has been learnt successfully,even press the ↵ Key it can' t be canceled.

(2) Sensor Postion Exchange

(Sensors were preset in factory,no need to handle such an operation. Through the setting of this function to realize the sensor tire position exchange,without removing the sensor to re-install.)

The specific operation is as follows

1、 In the main interface, press "SET" key for 3 seconds, after hearing "beep", release the "SET" key, the screen displays the front left wheel blinking, and "P1" appears on the right side of the screen, which is the sensor learning Ask interface,as shown below:

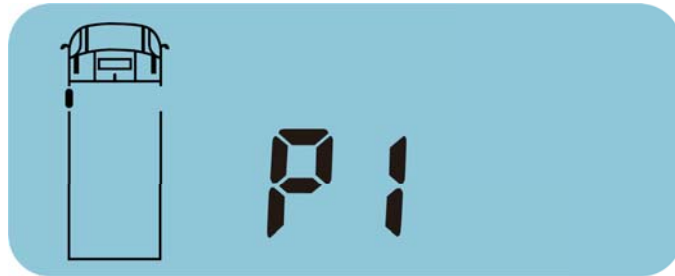

2、 Press the "SET" key to enter the inquiry interface of the sensor position exchange.At this time,the Front Left and Front Right wheels will flash at the same time,and the "P2" appears on the right of the screen as the following figure:

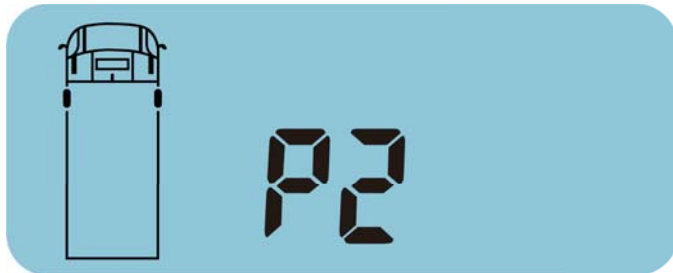

17

3、 Click the "OK" button to enter interface of sensor exchange position,the right side of the screen displays 00Bar 00 °C, then press the "SET" button,select the first sensor requires tire position exchange,relative tire position and position number will blink. As shown below:(Select the Front Left wheel for the first tire position as an example,it will display 01Bar 00 °C, Front Left wheel and 01 flashing)

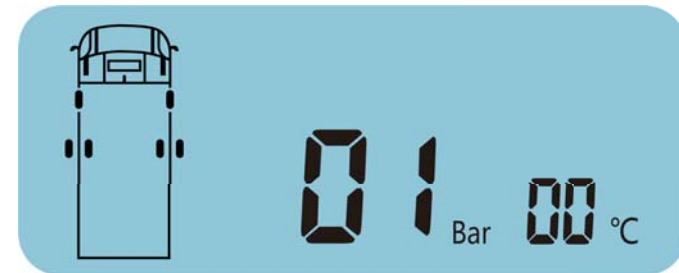

4、 Click the "OK" button to confirm the position of the first tire swap,the relative position number fixed display,for example 01Bar fixed display 00 °C will flash,press the SET button Now to select the second need to swap the tire position. As shown below:(select the Front Right wheel for another need to swap the tire position,it will show 01Bar 02 °C, Front Left and Front Right as well as 02 blinking)

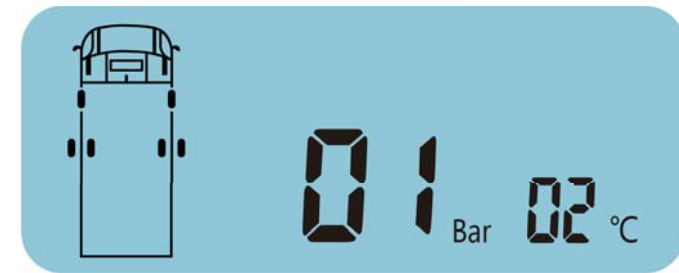

18

5、 Press the OK button to confirm,prompt "beep" will sound twice,the tire position swap success. Press the key,it will exit from operation step by step.

Remarks

- ①This setting applies if the sensor is installed in a position other than the tire to which it belongs. For example,if the sensor is labeled "Front Left", it is actually mounted to the "Rear Right".
- ②Also commonly used in tires after a period of operation,the location of the front and rear wheels exchange.

(3) Alarm threshold adjustment

(Note: the product has been set at the factory, no need for this operation.The user can set the alarm threshold according to their own specific vehicle models and actual needs)

- 1、 In the main interface, press "**SET**" key for 3 seconds, after hearing "beep", release the "**SET**" key, the screen displays the front left wheel blinking, and "**P1**" appears on the right side of the screen, which is the sensor learning Ask interface,as shown below:

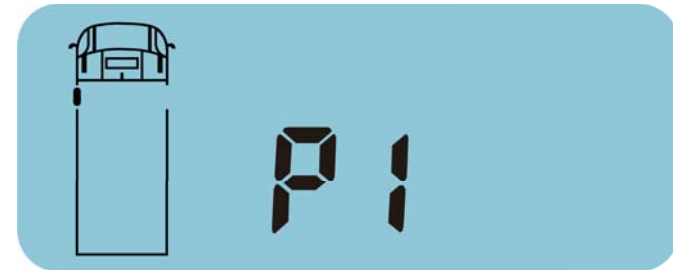

- 2、 Press the "**SET**" key to enter the inquiry interface of the sensor position exchange. At this time,the front left and front right wheels will flash at the same time,and the "**P2**" appears on the right of the screen as the following figure:



3、 Press the "**SET**" key to enter the inquiry interface of the sensor position exchange.At this moment,the screen anomaly alarm icon will flash and the "**P3**" appears on the right of the screen as the following figure:



4、 Then press "**OK**" key to confirm and enter the following interface as shown in Figure 1, at this time,press "**SET**" to cycle through the three alarm threshold setting interfaces (as shown in Figure 1, Figure 2 and Figure 3; High Pressure threshold,Low Pressure threshold,high temperature threshold).Select the interface to be set,press "**OK**" to enter the specific threshold setting,then the number flashes,press "**SET**" to set the value.Upon completion of the desired threshold value setting,-press "**OK**" to confirm and save. Press the key,it will exit from operation step by step.

High Pressure Threshold default value 12.5Bar;Setting range:9.0Bar-13.5Bar.

Low Pressure Threshold default value 7.5Bar;Setting range:5.0Bar-8.9Bar.

High temperature Threshold default value 80°C;Setting range:50°C-99°C.

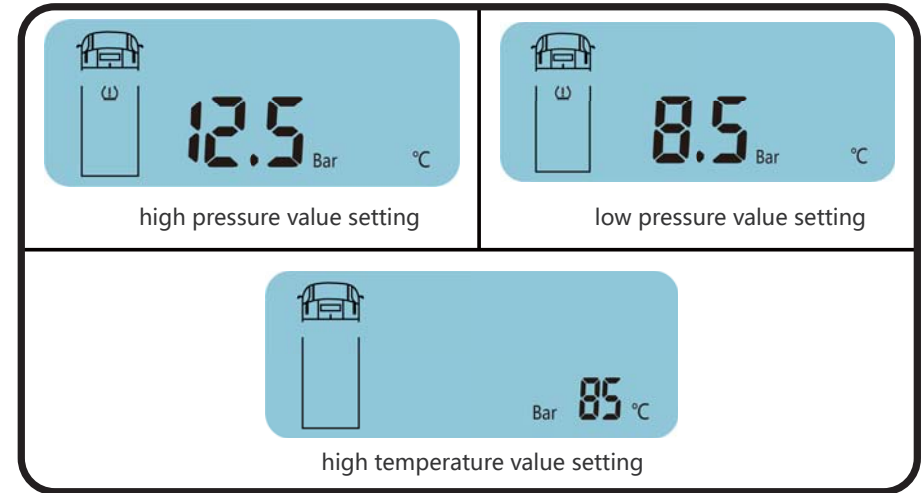

5、 Upon completion of the desired threshold value setting, Press the ↩ key,it will exit from operation step by step.

(4) Temperature and Pressure Unit Setting

(Note: the product has been set at the factory, no need for this operation.The user can reset according to their own specific vehicle models and actual needs)

1、 In the main interface, press "**SET**" key for 3 seconds, after hearing "beep", release the "**SET**" key, the screen displays the front left wheel blinking, and "**P1**" appears on the right side of the screen, which is the sensor learning Ask interface,as shown below:

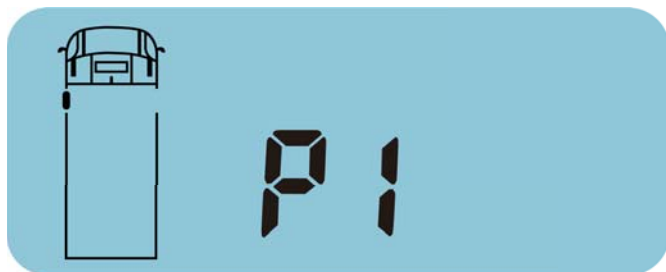

2、 Press the "**SET**" key to enter the inquiry interface of the sensor position exchange. At this time,the front left and front right wheels will flash at the same time,and the "**P2**" appears on the right of the screen as the following figure:

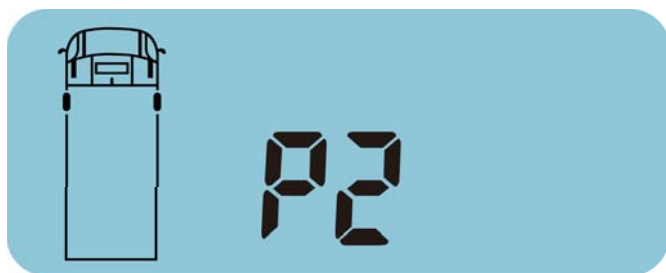

3、 Press the "**SET**" key to enter the inquiry interface of the sensor position exchange.At this moment,the screen anomaly alarm icon will flash and the "**P3**" appears on the right of the screen as the following figure:



4、 Press the "**SET**" key to enter the inquiry interface for exchanging the pressure and temperature unit.In this case, "**P4**" is fixed and displayed in the middle of the screen,and the optional pressure and temperature unit flashes on the right.As shown below;

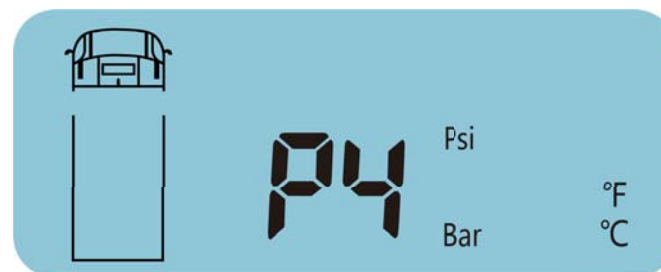

5、 Press "OK" key to enter the interface shown as figure 1,at this time The unit display will blink.You can switch to another unit setting by pressing "SET" (see the following figure 1 "Bar °C" and figure 2 "PSI °F"). After switching to the desired unit, press OK to confirm and save.Press the ↶ key, it will exit from operation step by step.

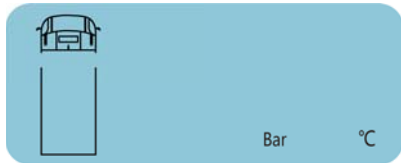

(figure 1 : Bar °C)

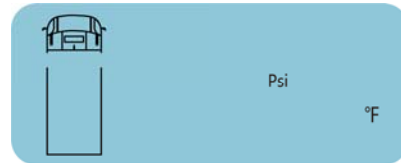

(figure 2 : PSI °F)

(5) Selection interface of vehicle tire number and sensor installation position

(Note: the product has been set at the factory, no need for this operation.The user can reset according to their own specific vehicle models and actual needs)

1、 In the main interface, press "SET" key for 3 seconds, after hearing "beep", release the "SET" key, the screen displays the front left wheel blinking, and "P1" appears on the right side of the screen, which is the sensor learning Ask interface,as shown below:

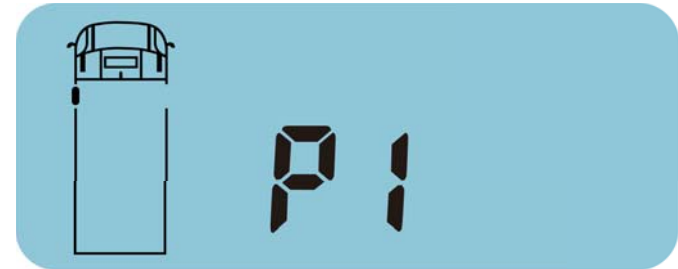

2、 Press the "SET" key to enter the inquiry interface of the sensor position exchange. At this time,the front left and front right wheels will flash at the same time,and the "P2" appears on the right of the screen as the following figure:



3、 Press the "**SET**" key to enter the inquiry interface of the sensor position exchange. At this moment,the screen anomaly alarm icon will flash and the "**P3**" appears on the right of the screen as the following figure:



4、 Press the "**SET**" key to enter the inquiry interface for exchanging the pressure and temperature unit.In this case, "**P4**" is fixed and displayed in the middle of the screen,and the optional pressure and temperature unit flashes on the right.As shown below;



7、 While selecting the number of tires, you can select the position where the sensor is to be installed on the tire by pressing "**SET**" key and confirm by pressing "**OK**". (For example, when through "**OK**" key to select the rear left outer tire,as shown in Fig. 3, it can be switched to the rear left inner tire by "**SET**" key as shown in Fig. 4.) The tire position to be selected will blink.



(figure 3 : Rear Left outer tire blinks,press" SET" key to switc)



(figure 4 : Rear Left inner tire blinks, press "OK" to confirm position)

8、 After confirming the number of tires and sensor mounting position, the next tire position to be selected flashes. At this point, press the ↻ key, step by step to exit the operation.

8、 Product Technical Parameters

(1) Truck TMPS 26 wheel Display

Item	Technical Parameters
Working Voltage	DC 12V ~ DC 32V
Working Current	<10 mA
RF Signal Receiving Sensitivity	<-105 dbm
Working Temperature	-40°C ~ 85°C
RF Transmit Signal Modulation Method	FSK
Working Frequency	433.92 MHz±30KHZ
Recevie	125KHz

5、 Click the **"SET"** button to enter the inquiry interface of the vehicle tires number and sensor installation location, then the left vehicle position will appear 18 tires flashing, while the right side of the screen appears **"P5"** as shown below:



6、 Then press **"OK"** key to confirm and enter the interface as shown in Figure 1. At this time,you can select the tire number by pressing **"OK"** key, as shown in Figure 2. (Default setting start from Front Left wheel,click to add a Front Rihgt wheel,same handling max up to 18 tires).



figure 1)



(figure 2)

(2) Truck TMPS Repeater

Item	Technical Parameters
Working Voltage	DC 12V ~ DC 32V
Working Frequency	433.92 MHz±30KHZ
RF Transmit Signal Modulation Method	FSK
RF Signal Transmission Power	< 10 dbm
RF Signal Receiving Sensitivity	< -105 dbm
Working Temperature	-40°C ~ 85°C

(3) Truck TMPS Internal Sensor

Item	Technical Parameters
Sensor battery model no	CR2450(550mAh)
Quiescent Current	<0.7uA
Working Temperature	-40°C~125°C
Storage Temperature	-40°C~125°C (store in normal temperature)
Transmission current	< 10mA
Sensor battery lifespan	More than 5 years
RF Transmit Signal Modulation Method	FSK
Working Frequency	433.92 MHz±30KHZ
Recevie	125KHz

conformity with the relevant Union harmonization legislation
Radio Equipment directive 2014 / 53 / EU with reference to the
following standards applied:

Draft ETSI EN 301 489-1 V2.2.0 (2017-03)

ETSI EN 301 489-3 V2.1.1 (2019-03)

ETSI EN 300 220-1 V3.1.1 (2017-02)

ETSI EN 300 220-2 V3.1.1 (2017-02)

ETSI EN 300 330 V2.1.1 (2017-02)

EN62311:2008

EN 60950-1:2006+A11:2009+A1:2010+A12:2011+A2:2013

(4) Truck TMPS External Sensor

Item	Technical Parameters
Sensor battery model no	CR1632(140mAh)
Quiescent Current	<0.7uA
Working Temperature	-30°C~60°C
Storage Temperature	-40°C~125°C (store in normal temperature)
Transmission current	< 10mA
Sensor battery lifespan	More than 1 years
RF Transmit Signal Modulation Method	FSK
Working Frequency	433.92 MHz±30KHZ
Recevie	125KHz

is in conformity with the relevant Union harmonization legislation:
 Radio Equipment directive: 2014 / 53 / EU
 with reference to the following standards applied:
 ETSI EN 300 220-1 V3.1.1 (2017-02)
 ETSI EN 300 220-2 V3.1.1 (2017-02)
 ETSI EN 300 330 V2.1.1 (2017-02)
 Draft ETSI EN 301 489-1 V2.2.0 (2017-03)
 ETSI EN 301 489-3 V2.1.1 (2019-03)
 EN 60950-1:2006+A11:2009+A1:2010+A12:2011+A2:2013
 EN62311:2008

9、 Troubleshooting

If encountering a problem during assembling or usage, pls. try to use below methods to solve. If the problem is still there, pls. contact our after-sale service center.

Problem phenomenon	Reason analysis	Solution
tire pressure data shown is different from the actual test data after installation	when we turn on the receiver, it shows factory test data at the first time installatio	Driving for a certain distance, it will update tire pressure and temperature value automatically.
a tire can' t display data properly	①Sensor and receiver don' t pair well ②Sensor battery drains or sensor is broken ③Maybe because of serious electromagnetic interference nearb	①Pair again ②Replace sesnor ③Make vehicle driving for a while and restart the tpms display receiver
Tire pressure and tire temperature alarm occurred more frequently	Check whether the setting warning threshold value is too high or too low.	According to the vehicle's tire parameters or the range given by user manual to reset the alarm threshold
Tires' tempera- ture is quite different	The air tempera- ture around the sensor is high	Pls. check whether tire is abnormal to cause hub heat seriously and cool the hub in time.

10、 Guarantee

One year of the guarantee period is provided with the conditions as following:

a. In addition to the claims under the law and/or contract of sale which arise from material defects, the rights arising from this guarantee are granted by the seller to the customer.

b. The product is guaranteed to be free of any defects. Parts that are subject to wear and tear such as batteries, or battery cells are not included in this guarantee.

The guarantee is excluded if

- The product has been misused or treated carelessly,
- The product has been damaged due to excessive stress, incorrect use or external influence,
- The defect has been caused by failure to observe the operating instructions,
- A repair or a repair attempt has been carried out by personnel other than that of an authorized point of service.

c. The guarantee period shall commence at the time of delivery of the product from the seller to the purchaser.

d. The place of purchase and the date of delivery shall be proven by submitting proof of purchase, for example, the sales receipt, invoice, delivery note or similar document.

e. Any defects that occur during the guarantee period should be submitted to the authorized point of service within 2 weeks since they happened. The defect will be remedied by delivery a product identical in construction. Further claims of the customer arising from this guarantee, particularly claims for reimbursement of expenses, reduction, compensation of damages or the right of withdrawal, shall be excluded.

f. The guarantee period shall not be extended if services are performed under the terms of the guarantee.

g. The parts replaced when carrying out the repairs under warranty or the product retained in case of replacement delivery shall no longer be the property of the customers' or dealers' .

h. If our customer services are called upon without due cause, the costs incurred will be charged to the customer.

i. In case any defects occur, please contact your dealer or the service center in yourcountry.

FCC Requirement

changes or modifications not expressly approved by the party responsible for compliance could void the user' s authority to operate the equipment.

This device complies with Part 15 of the FCC Rules. Operation is subject to the following two conditions:

- (1) this device may not cause harmful interference, and
- (2) this device must accept any interference received, including interference that may cause undesired operation.

Note: This equipment has been tested and found to comply with the limits for a Class B digital device, pursuant to Part 15 of the FCC Rules. These limits are designed to provide reasonable protection against harmful interference in a residential installation. This equipment generates, uses, and can radiate radio frequency energy, and if not installed and used in accordance with the instructions, may cause harmful interference to radio communications. However, there is no guarantee that interference will not occur in a particular installation. If this equipment does cause harmful interference to radio or television reception, which can be determined by turning the equipment off and on, the user is encouraged to try to correct the interference by one or more of the following measures:

- Reorient or relocate the receiving antenna.
- Increase the separation between the equipment and receiver.
- Connect the equipment into an outlet on a circuit different from that to which the receiver is connected.
- Consult the dealer or an experienced radio/TV technician for help.

Manufacturer information:

Zhejiang PDW Industrial Co., Ltd.

Quanxi Industrial Park, Wuyi County, Jinhua City, Zhejiang, P.R.

China 321200

Importer information:

City Pro car d.o.o.

Surcinska 5b, Belgrade, Serbia

Warranty card

Warranty clause

The company promises: During the warranty period, the product will be repaired or replaced in accordance with the terms of this warranty (except for the exemption clause).

1. The warranty period stipulates that the term of warranty is calculated from the beginning of the production time of the product, with a period of 1 years.
2. When the user puts forward the warranty of the product failure during the warranty period, the user must provide or produce the warranty.
 - Malfunction products;
 - Unmodified original proof of purchase which clearly shows the name of the seller and the date of purchase;
 - Filled warranty card.
3. The warranty does not apply to the following conditions:
 - Normal wear and tear;
 - Damage caused by unauthorized repair;
 - Any modification or modification of the product without the consent of the manufacturer;
 - Failure to use, maintain or store in accordance with the product instruction manual and damage caused by human activities;
 - Other failure or damage caused by other non product design, material, manufacturing, quality and other problems.
4. Products in the conditions beyond the conditions of use damage, or by corrosion, oxidation and other chemical effects.

Warranty Card

username		Product model		Date of purchase	
Contact mode (E-mail/phone)		Contact address			
Maintenance records					
Date	Failure phenomenon	Fault reason	Repair personnel		

Embedded Commercial Vehicle Tire Pressure Monitoring System

Manual

T

P

M

S

Thank you for choosing our commercial tire pressure monitoring system. Please read carefully before using this product installation instructions, we wish you a safe journey!