



<b>Report Reference ID:</b>	376484TRFWL
-----------------------------	-------------

<b>Test specification:</b>	Title 47 – Telecommunication Chapter I – Federal Communications Commission Part 22 – Public mobile services Part 90 – Private land mobile radio services
----------------------------	-------------------------------------------------------------------------------------------------------------------------------------------------------------------

<b>Applicant:</b>	<b>Leonardo Spa</b> P.zza Monte Grappa, 4 – 00195 Roma (RM) – Italy
<b>Apparatus:</b>	RadioBase Station for fixed installation
<b>Model:</b>	RBS4000K U2110DA0C14W0E100S1V2G2-000
<b>FCC ID:</b>	2ATWB-F967K-HP

<b>Testing laboratory:</b>	<b>Nemko Spa</b> Via del Carroccio, 4 – 20853 Biassono (MB) – Italy
----------------------------	------------------------------------------------------------------------

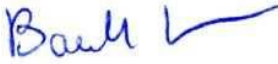
	<b>Name, function and signature</b>	<b>Date</b>
<b>Tested by:</b>	D. Guarnone  (project handler)	2019-07-04
<b>Reviewed by:</b>	P. Barbieri  (verifier)	2019-07-09

**Nemko Spa, 20853 Biassono (MB) - Italy. All rights reserved.**

This publication may be reproduced in whole for non-commercial purposes as long as Nemko Spa is acknowledged as copyright owner and source of the material. Nemko Spa takes no responsibility for and will not assume liability for damages resulting from the reader's interpretation of the reproduced material due to its placement and context. Nemko Spa accepts no responsibility for damages, if any, suffered by any third party as a result of decisions made or actions based on this report. This test report may not be partially reproduced, except with the prior written permission of Nemko Spa. The test report merely corresponds to the test sample. The phase of sampling / collection of equipment under test is carried out by the customer.

This Test Report, when bearing the Nemko name and logo is only valid when issued by a Nemko laboratory, or by a laboratory having special agreement with Nemko.



Report Number: 376484TRFWL

Specification: FCC 90

## Table of contents

<b>Section 1: Report summary</b> .....	<b>3</b>
1.1 Test specification.....	3
1.2 Statement of compliance .....	3
1.3 Exclusions .....	3
1.4 Registration number .....	3
1.5 Test report revision history .....	3
1.6 Limits of responsibility .....	3
<b>Section 2: Summary of test results</b> .....	<b>4</b>
2.1 FCC Part 90: Test results.....	4
2.2 FCC Part 22: Test results.....	4
<b>Section 3: Equipment under test</b> .....	<b>5</b>
3.1 Applicant details .....	5
3.2 Manufacturer details .....	5
3.3 Identification of equipment under test (EUT) .....	5
3.4 Accessories and support equipment.....	6
3.5 EUT description.....	6
3.6 Technical specifications of the EUT .....	7
3.7 EUT setup diagram .....	7
<b>3.8 Operation of the EUT during testing</b> .....	<b>7</b>
3.9 Modifications incorporated in the EUT.....	7
<b>Section 4: Test conditions</b> .....	<b>8</b>
4.1 Deviations from laboratory tests procedures .....	8
4.2 Test conditions, power source and ambient temperatures.....	8
4.3 Equipment used for the monitoring of the environmental conditions .....	8
4.4 Measurement uncertainty .....	9
4.5 <b>Test equipment</b> .....	<b>10</b>
<b>Appendix A: Test results</b> .....	<b>11</b>
Clause 15.31 Number of frequencies .....	11
Clause 90.205 and 22.565 Output power .....	12
Clause 90.207 Modulation characteristics .....	27
Clause 90.209 Occupied bandwidth.....	32
Clause 90.210 and 22.359 Emission masks .....	37
Clause 90.210 and 22.359 Spurious emissions at antenna terminals .....	52
Clause 90.210 and 22.359 Field strength of spurious radiation.....	67
Clause 90.213 and 22.355 Frequency stability.....	118
Clause 90.214 Transient frequency behaviour .....	122
<b>Appendix B: Block diagrams of test set-ups</b> .....	<b>125</b>
<b>Appendix C: EUT Photos</b> .....	<b>126</b>



Section 1: Report summary

Report Number: 376484TRFWL

Specification: FCC 90

## Section 1: Report summary

### 1.1 Test specification

<b>Specifications</b>	FCC Part 22 – Public mobile services FCC Part 90 – Private land mobile radio services
-----------------------	------------------------------------------------------------------------------------------

### 1.2 Statement of compliance

<b>Compliance</b>	In the configuration tested the EUT was found compliant Yes <input checked="" type="checkbox"/> No <input type="checkbox"/> This report contains an assessment of apparatus against specifications based upon tests carried out on samples submitted at Nemko Spa. These tests were conducted on a sample of the equipment for the purpose of demonstrating compliance with FCC Part 90. The tests were conducted in accordance with ANSI C63.26-2015.
-------------------	--------------------------------------------------------------------------------------------------------------------------------------------------------------------------------------------------------------------------------------------------------------------------------------------------------------------------------------------------------------------------------------------------------------------------------------------------------------

### 1.3 Exclusions

<b>Exclusions</b>	None
-------------------	------

### 1.4 Registration number

<b>Test site:</b>	FCC ID number 682159 (10 m Semi anechoic chamber)
-------------------	---------------------------------------------------

### 1.5 Test report revision history

Revision #	Details of changes made to test report
376484TRFWL	Original report issued

### 1.6 Limits of responsibility

Note that the results contained in this report relate only to the items tested and were obtained in the period between the date of initial receipt of samples and the date of issue of the report. This test report has been completed in accordance with the requirements of ISO/IEC 17025. Nemko Spa authorizes the applicant to reproduce this report provided it is reproduced in its entirety and for use by the company's employees only. Any use which a third party makes of this report, or any reliance on or decisions to be made based on it, are the responsibility of such third parties. Nemko Spa accepts no responsibility for damages, if any, suffered by any third party as a result of decisions made or actions based on this report.



Section 2: Summary of test results

Report Number: 376484TRFWL

Specification: FCC 90

## Section 2: Summary of test results

### 2.1 FCC Part 90: Test results

Part	Test method	Test description	Result
§90.205	§2.1046	Output power	Pass
§90.207	§2.1047	Modulation characteristics	Pass
§90.209	§2.1049	Occupied bandwidth	Pass
§90.210	§2.1051	Emission masks	Pass
§90.210	§2.1051	Spurious emissions at antenna terminals	Pass
§90.210	§2.1053	Field strength of spurious radiation	Pass
§90.213	§2.1055	Frequency stability	Pass
§90.214	---	Transient Behaviour	Pass

Notes: None

### 2.2 FCC Part 22: Test results

Part	Test method	Test description	Result
§22.565	§2.1046	Output power	Pass
§22.359	§2.1051	Emission masks	Pass
§22.359	§2.1051	Spurious emissions at antenna terminals	Pass
§22.359	§2.1053	Field strength of spurious radiation	Pass
§22.355	§2.1055	Frequency stability	Pass

Notes: None



Section 3: Equipment under test

Report Number: 376484TRFWL

Specification: FCC 90

## Section 3: Equipment under test

### 3.1 Applicant details

Name:	Leonardo Spa
Address:	P.zza Monte Grappa, 4
City:	Roma
Province/State:	RM
Post code:	00195
Country:	Italy
FRN:	0028621795

### 3.2 Manufacturer details

Name:	Leonardo Spa
Address:	P.zza Monte Grappa, 4
City:	Roma
Province/State:	RM
Post code:	00195
Country:	Italy
FRN:	0028621795

### 3.3 Identification of equipment under test (EUT)

Type of equipment:	RadioBase Station for fixed installation
Product marketing name:	RBS4000K U2110DA0C14W0E100S1V2G2-000
Part number:	145-0543/01
Serial number:	00307792
FCC ID:	2ATWB-F967K-HP
Date of receipt:	2019-06-18



Section 3: Equipment under test

Report Number: 376484TRFWL

Specification: FCC 90

### 3.4 Accessories and support equipment

The following information identifies accessories used to exercise the EUT during testing:

#### Item # 1

Type of equipment:	DC power supply
Brand name:	Elind
Model name or number:	60HL
Serial number:	3.542
Connection port:	DC
Cable length and type:	2 m two wires cable

#### Item # 2

Type of equipment:	Receiver (Radiocommunication Tester)
Brand name:	R&S
Model name or number:	CMT
Serial number:	883152/001
Connection port:	TX OUT and BF TX
Cable length and type:	1 m coaxial cables

### 3.5 EUT description

The EUT is a radio base station for fixed installation. The RBS is composed by the following modules:

- "Power Amplifier" (PA) module representing the final amplification stage.
- "Voltage converter" (DC/DC) module is a DC power voltage converter from an external power source (48Vdc) to the necessary voltages for the operation of the RBS modules.
- "Vectorial transceiver" (RTX) module, in UHF range equipped with an I&Q modulator and demodulator.
- "Power Supply" (SWITCH) module that generates and distributes the power supply (both the 7 Vdc and the 13.2 Vdc) to the whole RBS.
- "RBS Simulcast Controller" (CORE) module which is able to performs the voting process, manages the incoming signal, allows the local listening/monitoring of the incoming signals, allows the RBS remote control, provides an Ethernet 10/100 Base-T interface, supplies the 4W+E&M interface towards external analogical dispatcher when serving analog modulation, generates the reference synchronization signal and manages a piggy-back board

### 3.6 Technical specifications of the EUT

Operating frequency:	450 ÷ 526 MHz ( <b>450÷512</b> MHz for USA and Canada);
Modulation type:	FM with channel bandwidth 12.5 kHz / 25 kHz (voice) 4FSK 9600 bps with channel bandwidth 12.5 kHz (voice and data) C4FM with channel bandwidth 12.5 kHz (voice and data)
Occupied bandwidth:	12.5 kHz / 25 kHz
Channel step:	5 kHz – 6.25 kHz
Emission designator:	16K0F3E, 11K0F3E, 7K60FXE and 8K0F1E
RF output power:	110 W
Antenna type:	External Antenna (not provided)
Power source	External 48 VDC, (35 ÷ 60 Vdc – galvanically insulated)

### 3.7 EUT setup diagram

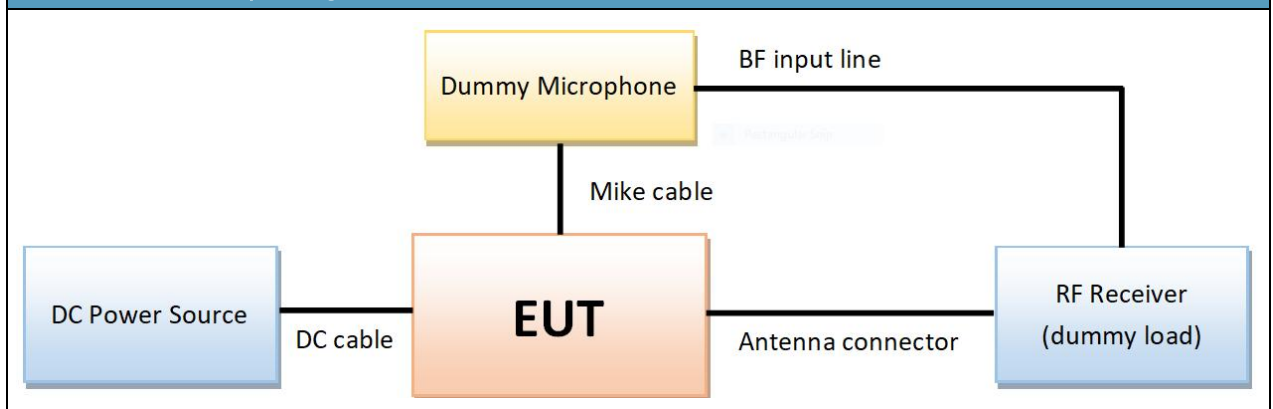

### 3.8 Operation of the EUT during testing

The EUT has been tested in TX mode at maximum power, with the antenna connector closed on a 50 Ω dummy load.

### 3.9 Modifications incorporated in the EUT

There were no modifications performed to the EUT during this assessment.

## Section 4: Test conditions

### 4.1 Deviations from laboratory tests procedures

No deviations were made from laboratory test procedures.

### 4.2 Test conditions, power source and ambient temperatures

Normal temperature, humidity and air pressure test conditions	<p>Unless different values are declared in the test case, following ambient conditions apply for the tests:</p> <p>Temperature: 18 ÷ 33 °C          Relative humidity: 30 ÷ 60 %          Air pressure: 980 ÷ 1060 hPa</p> <p>When it is impracticable to carry out tests under these conditions, a note to this effect stating the ambient temperature and relative humidity during the tests shall be recorded and stated.</p>
Power supply range:	The normal test voltage for equipment to be connected to the mains shall be the nominal mains voltage. For the purpose of the present document, the nominal voltage shall be the declared voltage, or any of the declared voltages ±5 %, for which the equipment was designed.

### 4.3 Equipment used for the monitoring of the environmental conditions

Equipment	Manufacturer	Model	Serial N°
Thermohygrometer data loggers	Testo	175-H2	20012380/305
Thermohygrometer data loggers	Testo	175-H2	38203337/703
Barometer	MSR	MSR145B	330080



## 4.4 Measurement uncertainty

EUT	Type	Test	Range and Setup features	Measurement Uncertainty	Notes
Transmitter	Conducted	Frequency error	0.001 MHz ÷ 40 GHz	0.08 ppm	(1)
		Carrier power RF Output Power	10 kHz ÷ 30 MHz	1.0 dB	(1)
			30 MHz ÷ 18 GHz	1.5 dB	(1)
			18 MHz ÷ 40 GHz	3.0 dB	(1)
			Adjacent channel power	1 MHz ÷ 18 GHz	1.6 dB
		Conducted spurious emissions	10 kHz ÷ 26 GHz	3.0 dB	(1)
			26 GHz ÷ 40 GHz	4.5 dB	(1)
		Intermodulation attenuation	1 MHz ÷ 18 GHz	2.2 dB	(1)
		Attack time – frequency behaviour	1 MHz ÷ 18 GHz	2.0 ms	(1)
		Attack time – power behaviour	1 MHz ÷ 18 GHz	2.5 ms	(1)
		Release time – frequency behaviour	1 MHz ÷ 18 GHz	2.0 ms	(1)
		Release time – power behaviour	1 MHz ÷ 18 GHz	2.5 ms	(1)
		Transient behaviour of the transmitter– Transient frequency behaviour	1 MHz ÷ 18 GHz	0.2 kHz	(1)
		Transient behaviour of the transmitter – Power level slope	1 MHz ÷ 18 GHz	9%	(1)
		Frequency deviation - Maximum permissible frequency deviation	0.001 MHz ÷ 18 GHz	1.3%	(1)
		Frequency deviation - Response of the transmitter to modulation frequencies above 3 kHz	0.001 MHz ÷ 18 GHz	0.5 dB	(1)
		Dwell time	-	3%	(1)
	Hopping Frequency Separation	0.01 MHz ÷ 18 GHz	1%	(1)	
	Occupied Channel Bandwidth	0.01 MHz ÷ 18 GHz	2%	(1)	
	Modulation Bandwidth	0.01 MHz ÷ 18 GHz	2%	(1)	
Radiated	Radiated spurious emissions	10 kHz ÷ 26.5 GHz	6.0 dB	(1)	
		26.5 GHz ÷ 40 GHz	8.0 dB	(1)	
	Effective radiated power transmitter	10 kHz ÷ 26.5 GHz	6.0 dB	(1)	
		26,5 GHz ÷ 40 GHz	8.0 dB	(1)	
Receiver	Radiated	Radiated spurious emissions	10 kHz ÷ 26.5 GHz	6.0 dB	(1)
			26.5 GHz ÷ 40 GHz	8.0 dB	(1)
		Sensitivity measurement	1 MHz ÷ 18 GHz	6.0 dB	(1)
	Conducted	Conducted spurious emissions	10 kHz ÷ 26 GHz	3.0 dB	(1)
			26 GHz ÷ 40 GHz	4.5 dB	(1)

(1) The reported expanded uncertainty of measurement is stated as the standard uncertainty of measurement multiplied by the coverage factor  $k = 2$  which has been derived from the assumed normal probability distribution with infinite degrees of freedom and for a coverage probability of 95 %

## 4.5 Test equipment

Equipment	Manufacturer	Model	Serial N°	Cal Date	Due Date
Trilog Broadband Antenna	Schwarzbeck	VULB 9162	9162-025	2018-07	2021-07
Bilog antenna (1 ÷ 18 GHz)	Schwarzbeck	STLP 9148	9148-123	2018-07	2021-07
Broadband preamplifier	Schwarzbeck	BBV 9718	9718-137	2018-08	2019-08
EMI receiver (2 Hz ÷ 44 GHz)	Rohde & Schwarz	ESW44	101620	2018-08	2019-08
EMI receiver (20 Hz ÷ 8 GHz)	Rohde & Schwarz	ESU8	100202	2019-01	2020-01
Spectrum analyzer (20 Hz ÷ 8 GHz)	Rohde & Schwarz	FSEK	848255/005	2018-02	2020-02
EMI receiver (9 kHz ÷ 3 GHz)	Rohde & Schwarz	ESCI	100888	2018-09	2019-09
Signal generator	Rohde & Schwarz	SMBV100A	263397	2018-09	2019-09
Signal generator	Rohde & Schwarz	SMBV100A	263254	2019-03	2020-03
Semi-anechoic chamber	Nemko	10 m semi-anechoic chamber	530	NSC	--
Shielded room	Siemens	10 m control room	1947	NSC	--
Radiocommunication Tester	R&S	CMT	883152/001	2018-01	2021-01
Climatic chamber	Espec	ARS-1100	4100000067	2018-11	2019-11
Oscilloscope	Yokogawa	DL1740£	27D904989	2019-03	2020-03

Note: N/A = Not Applicable, NCR = No Cal Required, COU = CAL On Use



## Appendix A: Test results

### Clause 15.31 Number of frequencies

(m) Measurements on intentional radiators or receivers, other than TV broadcast receivers, shall be performed and, if required, reported for each band in which the device can be operated with the device operating at the number of frequencies in each band specified in the following table:

Frequency range over which device operates	Number of frequencies	Location in the range of operation
1 MHz or less	1	Middle.
1 to 10 MHz	2	1 near top and 1 near bottom.
More than 10 MHz	3	1 near top, 1 near middle and 1 near bottom.

Test date: 2019-06-24

Test results: Pass

#### Test data

Start of Frequency range, MHz	End of Frequency range, MHz	Frequency range bandwidth, MHz
450	512	62

#### Test data

Low channel, MHz	Mid channel, MHz	High channel, MHz
450.1	481	511.9



## Clause 90.205 and 22.565 Output power

### **§90.205 Power and antenna height limits.**

Applicants for licenses must request and use no more power than the actual power necessary for satisfactory operation. Except where otherwise specifically provided for, the maximum power that will be authorized to applicants whose license applications for new stations are filed after August 18, 1995 is as follows:

g) 421-430 MHz. Limitations on power and antenna heights are specified in §90.279.

(h) 450-470 MHz. (1) The maximum allowable station effective radiated power (ERP) is dependent upon the station's antenna HAAT and required service area and will be authorized in accordance with table 2. Applicants requesting an ERP in excess of that listed in table 2 must submit an engineering analysis based upon generally accepted engineering practices and standards that includes coverage contours to demonstrate that the requested station parameters will not produce coverage in excess of that which the applicant requires

(i) 470-512 MHz. Power and height limitations are specified in §§90.307 and 90.309.

(1) The maximum allowable station ERP is dependent upon the station's antenna HAAT and required service area and will be authorized in accordance with table 1. Applicants requesting an ERP in excess of that listed in table 1 must submit an engineering analysis based upon generally accepted engineering practices and standards that includes coverage contours to demonstrate that the requested station parameters will not produce coverage in excess of that which the applicant requires.

(2) Applications for stations where special circumstances exist that make it necessary to deviate from the ERP and antenna heights in Table 1 will be submitted to the frequency coordinator accompanied by a technical analysis, based upon generally accepted engineering practices and standards, that demonstrates that the requested station parameters will not produce a signal strength in excess of 37 dBu at any point along the edge of the requested service area. The coordinator may then recommend any ERP appropriate to meet this condition.

(3) An applicant for a station with a service area radius greater than 40 km (25 mi) must justify the requested service area radius, which will be authorized only in accordance with table 1, note 4. For base stations with service areas greater than 80 km, all operations 80 km or less from the base station will be on a primary basis and all operations outside of 80 km from the base station will be on a secondary basis and will be entitled to no protection from primary operations.

<sup>1</sup>Maximum ERP indicated provides for a 37 dBu signal strength at the edge of the service area per FCC Report R-6602, Fig. 19 (See §73.699, Fig. 10).

<sup>2</sup>Maximum ERP of 500 watts allowed. Signal strength at the service area contour may be less than 37 dBu.

<sup>3</sup>When the actual antenna HAAT is greater than the reference HAAT, the allowable ERP will be reduced in accordance with the following equation:  $ERP_{allow} = ERP_{max} \times (HAAT_{ref} / HAAT_{actual})^2$ .

<sup>4</sup>Applications for this service area radius may be granted upon specific request with justification and must include a technical demonstration that the signal strength at the edge of the service area does not exceed 37 dBu.



## Clause 90.205 and 22.565 Output power

(s) The output power shall not exceed by more than 20 percent either the output power shown in the Radio Equipment List [available in accordance with §90.203(a)(1)] for transmitters included in this list or when not so listed, the manufacturer's rated output power for the particular transmitter specifically listed on the authorization.

### §22.565 Transmitting power limits.

The transmitting power of base, mobile and fixed transmitters operating on the channels listed in §22.561 must not exceed the limits in this section.

(a) Maximum ERP. The effective radiated power (ERP) of base and fixed transmitters must not exceed the applicable limits in this paragraph under any circumstances.

Frequency range (MHz)	Maximum ERP (watts)
152-153	1400
157-159	150
454-455	3500
459-460	150

(b) Basic power limit. Except as provided in paragraph (d) of this section, the ERP of base transmitters must not exceed 500 Watts.

(c) Height-power limits. Except as provided in paragraph (d) of this section, the ERP of base transmitters must not exceed the amount that would result in an average distance to the service contour of 41.6 kilometers (26 miles) for VHF channels or 30.7 kilometers (19 miles) for UHF channels. The average distance to the service contour is calculated by taking the arithmetic mean of the distances determined using the procedures specified in §22.567 for the eight cardinal radial directions, excluding cardinal radial directions for which 90% or more of the distance so calculated is over water.

(d) Encompassed interfering contour areas. Base transmitters are exempt from the basic power and height-power limits of this section if the area within their interfering contours is totally encompassed by the interfering contours of operating co-channel based transmitters controlled by the same licensee. For the purpose of this paragraph, operating transmitters are authorized transmitters that are providing service to subscribers.

(e) Adjacent channel protection. The ERP of base and fixed transmitters must not exceed 500 Watts if they transmit on channel 454.025 MHz and are located less than 7 kilometers (4.3 miles) from any Private Radio Services station receiving on adjacent channel 454.0000 MHz.

(f) Mobile transmitters. The transmitter output power of mobile transmitters must not exceed 60 watts.

### §2.1046 Measurements required: RF power output.

For measurements conducted pursuant to paragraphs (a) and (b) of § 2.1046, all calculations and methods used by the applicant for determining carrier power or peak envelope power, as appropriate, on the basis of measured power in the radio frequency load attached to the transmitter output terminals shall be shown. Under the test conditions specified, no components of the emission spectrum shall exceed the limits specified in the applicable rule parts as necessary for meeting occupied bandwidth or emission limitations.

s) The output power shall not exceed by more than 20 percent either the output power shown in the Radio Equipment List [available in accordance with §90.203(a)(1)] for transmitters included in this list or when not so listed, the manufacturer's rated output power for the particular transmitter specifically listed on the authorization.

## Clause 90.205 and 22.565 Output power

### §22.727 Power limits for conventional rural radiotelephone transmitters.

The transmitting power of transmitters operating on the channels listed in §22.725 must not exceed the limits in this section.

(a) *Maximum ERP.* The effective radiated power (ERP) of central office and rural subscriber station transmitters must not exceed the applicable limits in this paragraph under any circumstances.

Frequency range (MHz)	Maximum ERP (watts)
152-153	1400
157-159	150
454-455	3500
459-460	150

### §2.1046 Measurements required: RF power output.

For measurements conducted pursuant to paragraphs (a) and (b) of § 2.1046, all calculations and methods used by the applicant for determining carrier power or peak envelope power, as appropriate, on the basis of measured power in the radio frequency load attached to the transmitter output terminals shall be shown. Under the test conditions specified, no components of the emission spectrum shall exceed the limits specified in the applicable rule parts as necessary for meeting occupied bandwidth or emission limitations.

### §22.759 Power limit for BETRS.

The effective radiated power of central office and rural subscriber station transmitters used in basic exchange telephone radio systems must not exceed the limits in this section.

(a) *Maximum ERP.* The effective radiated power (ERP) of central office and rural subscriber station transmitters in BETRS must not exceed the applicable limits in this paragraph under any circumstances.

(a) *Maximum ERP.* The effective radiated power (ERP) of central office and rural subscriber station transmitters in BETRS must not exceed the applicable limits in this paragraph under any circumstances.

Frequency range (MHz)	Maximum ERP (watts)
152-153	1400
157-159	150
454-455	3500
459-460	150

(b) *Height-power limit.* The ERP of central office stations in BETRS must not exceed the amount calculated as follows:

$$ERP_w = 557,418 \div h_m^2$$

where  $ERP_w$  is the effective radiated power in Watts

$h_m$  is the average (eight cardinal radial) antenna height above average terrain in meters



Test date: 2019-07-01

Test results: Pass

Channel	Measured Output power	Measured Output power	Manufacturer's Rated Power
LOW	50.49 dBm	111.94 W	110 W
MID	50.54 dBm	113.24 W	110 W
HIGH	50.57 dBm	114.02 W	110 W

Limit (Manufacturer's rated Power + 20%): 132 W  
 The RF Power maintains unchanged from 35 to 60 Vdc at 20° C  
 Maximum values

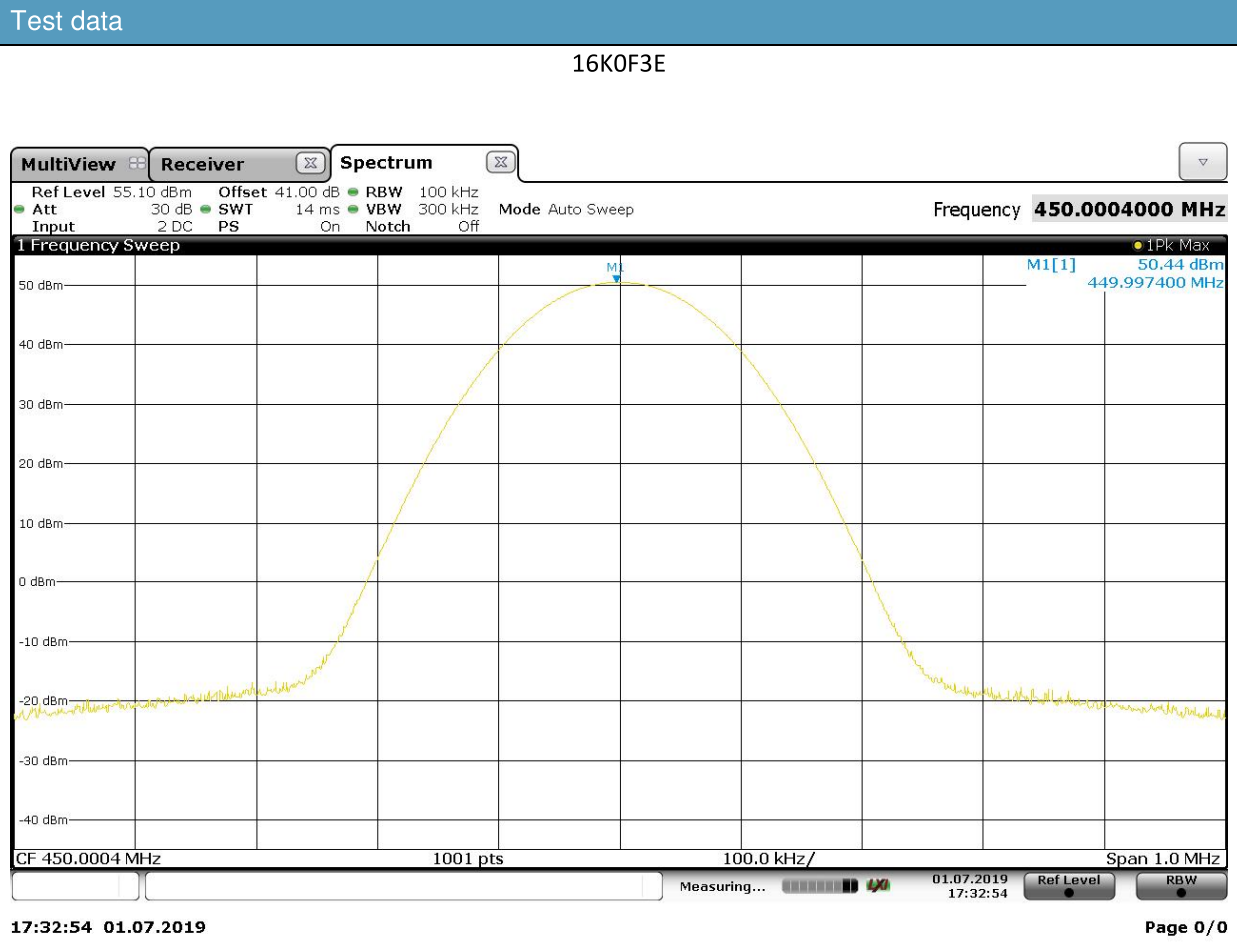



Test data

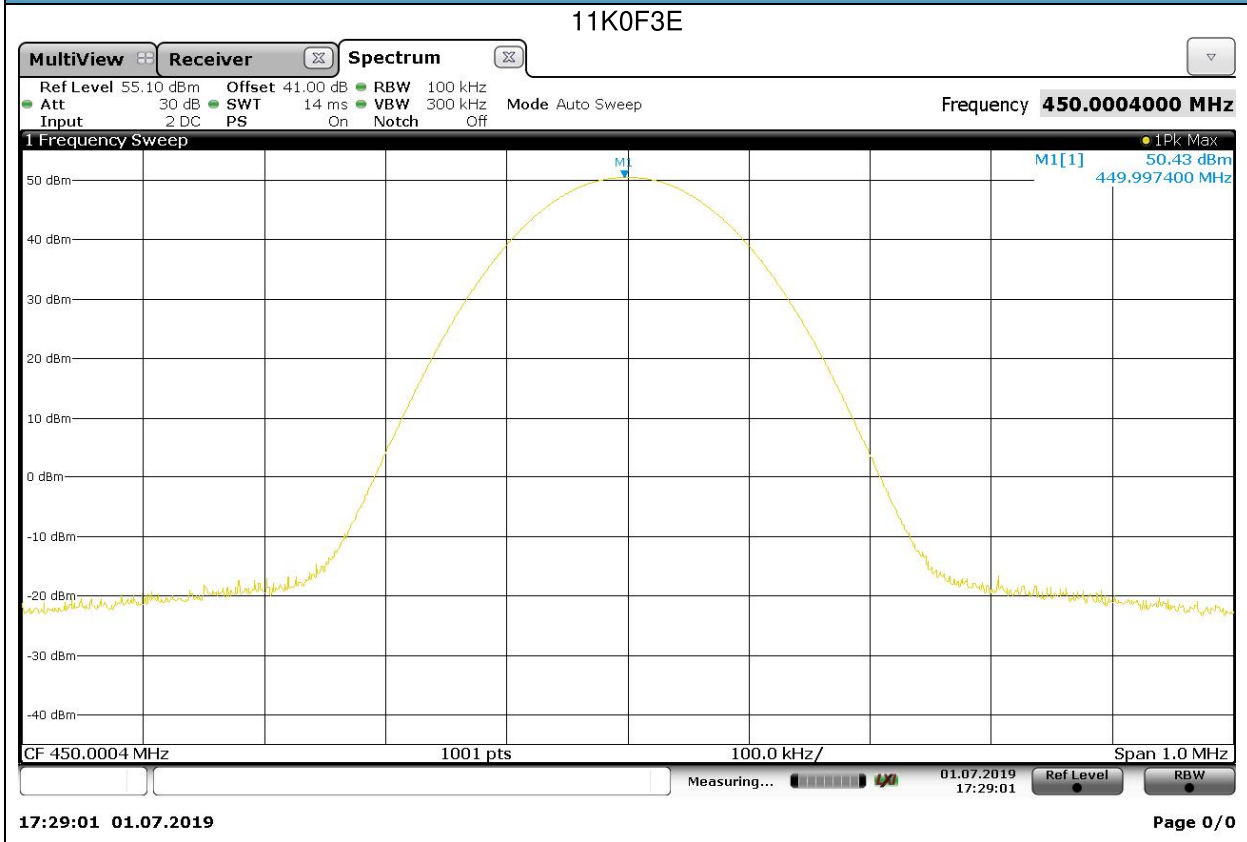





Test data

16KOF3E



17:38:18 01.07.2019

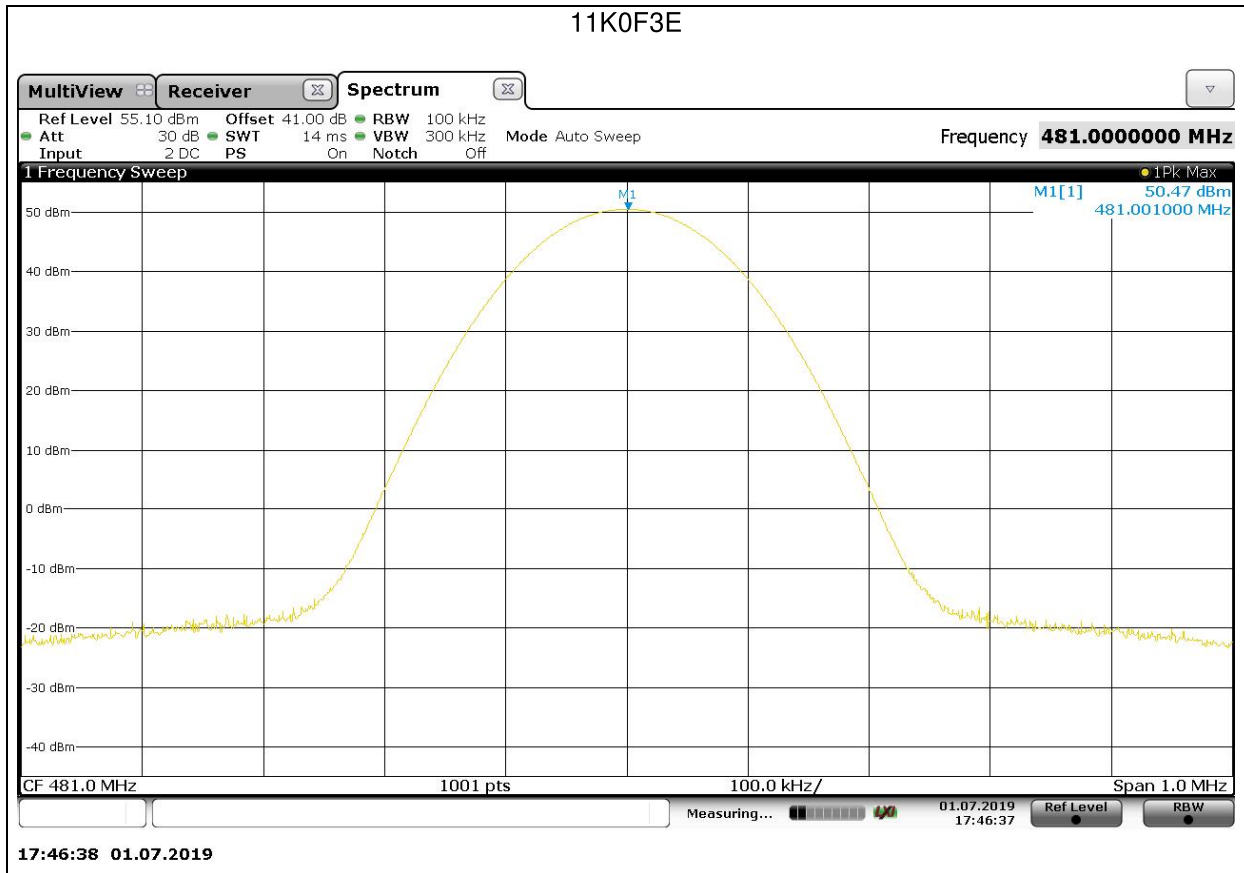

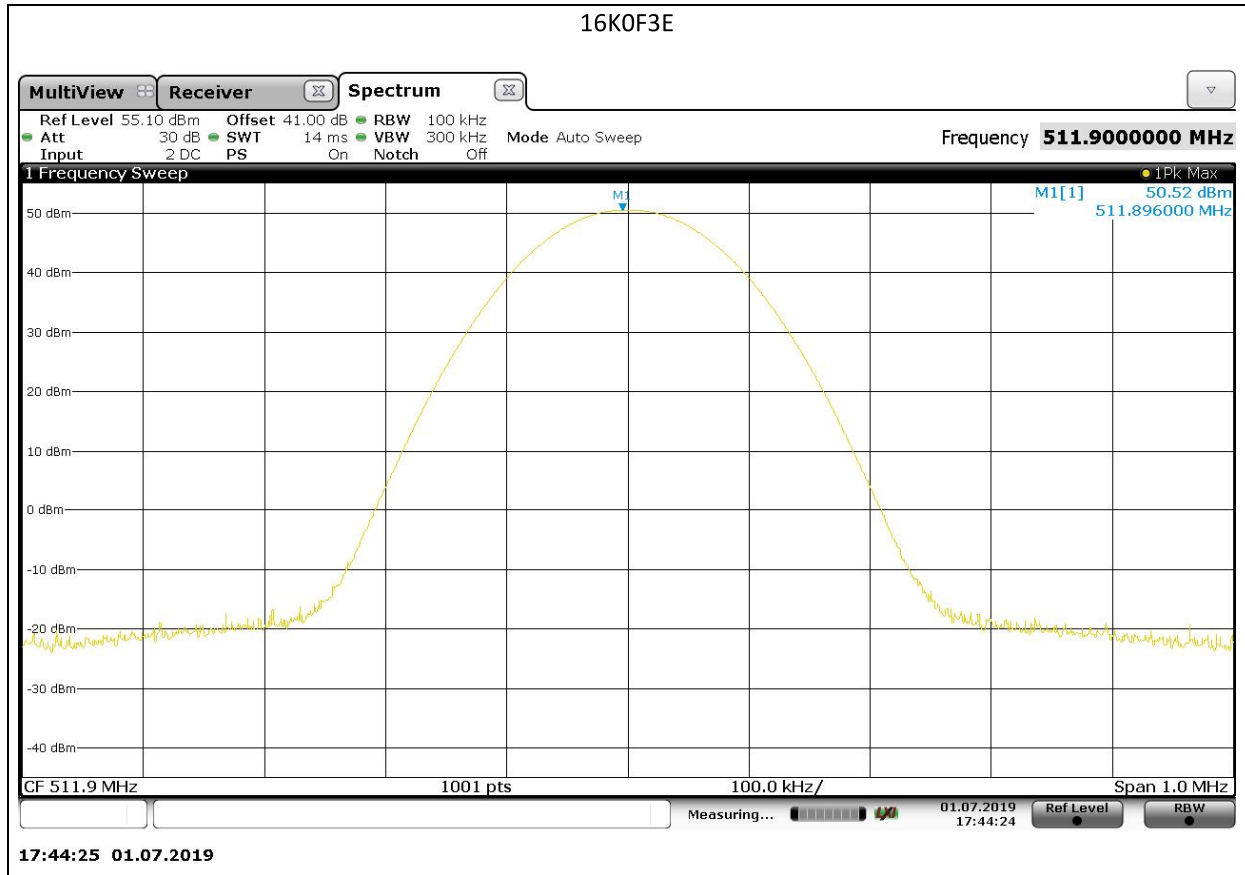

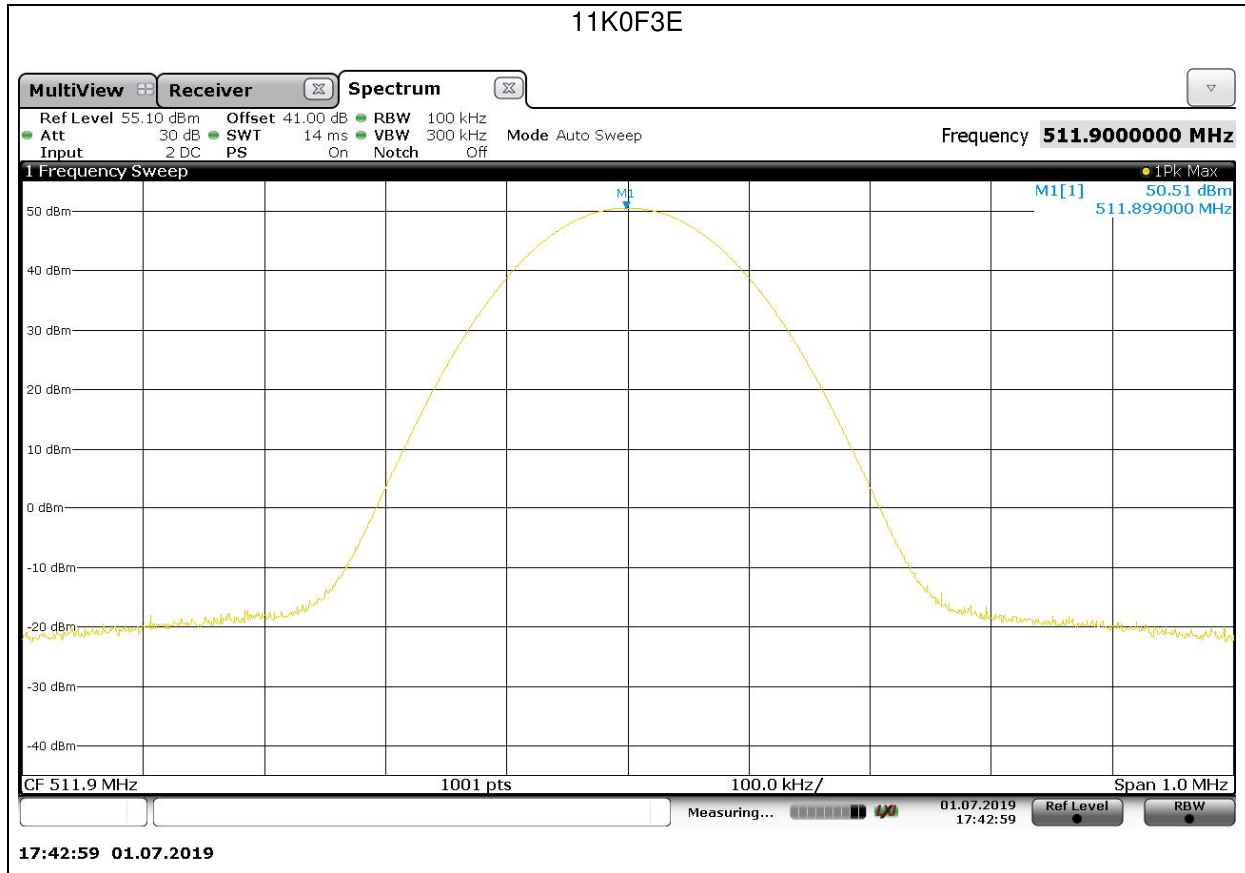

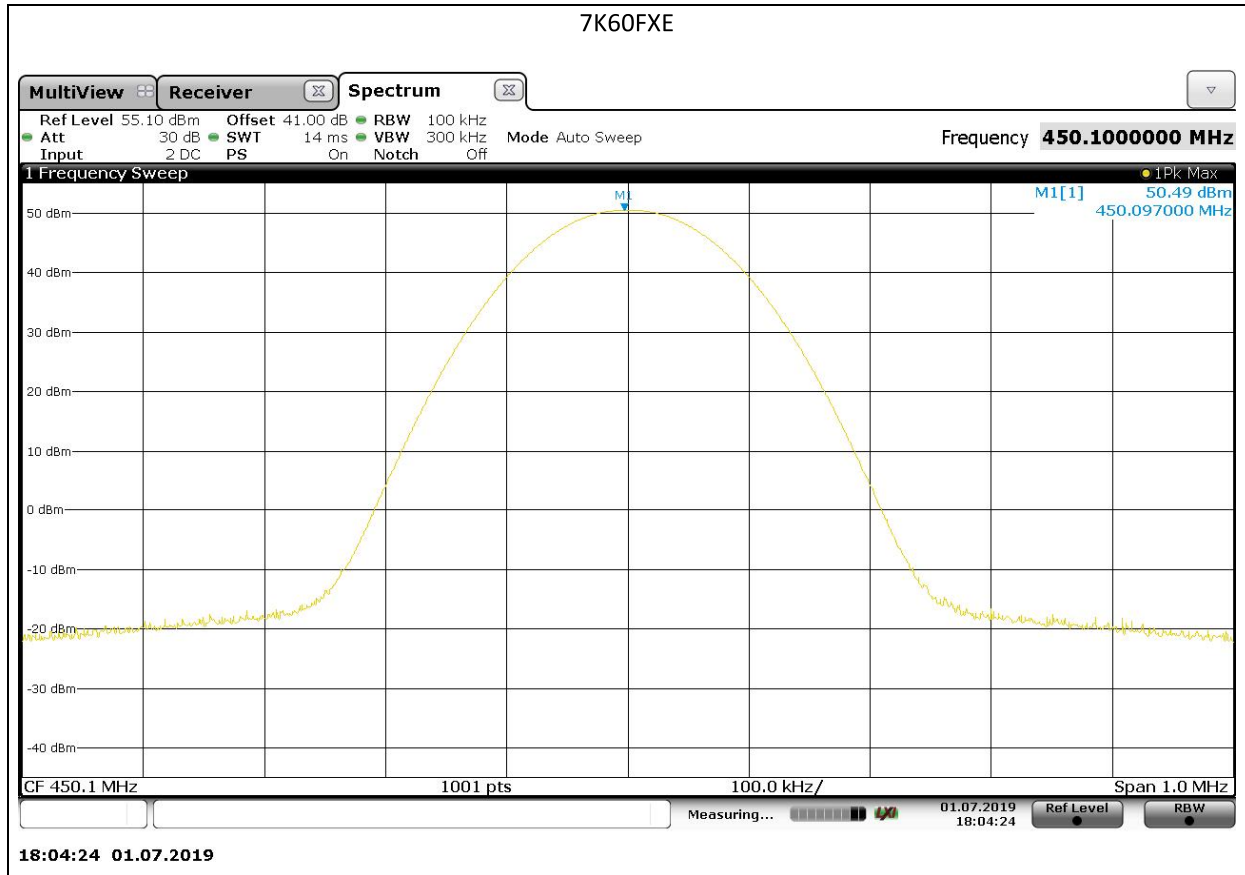

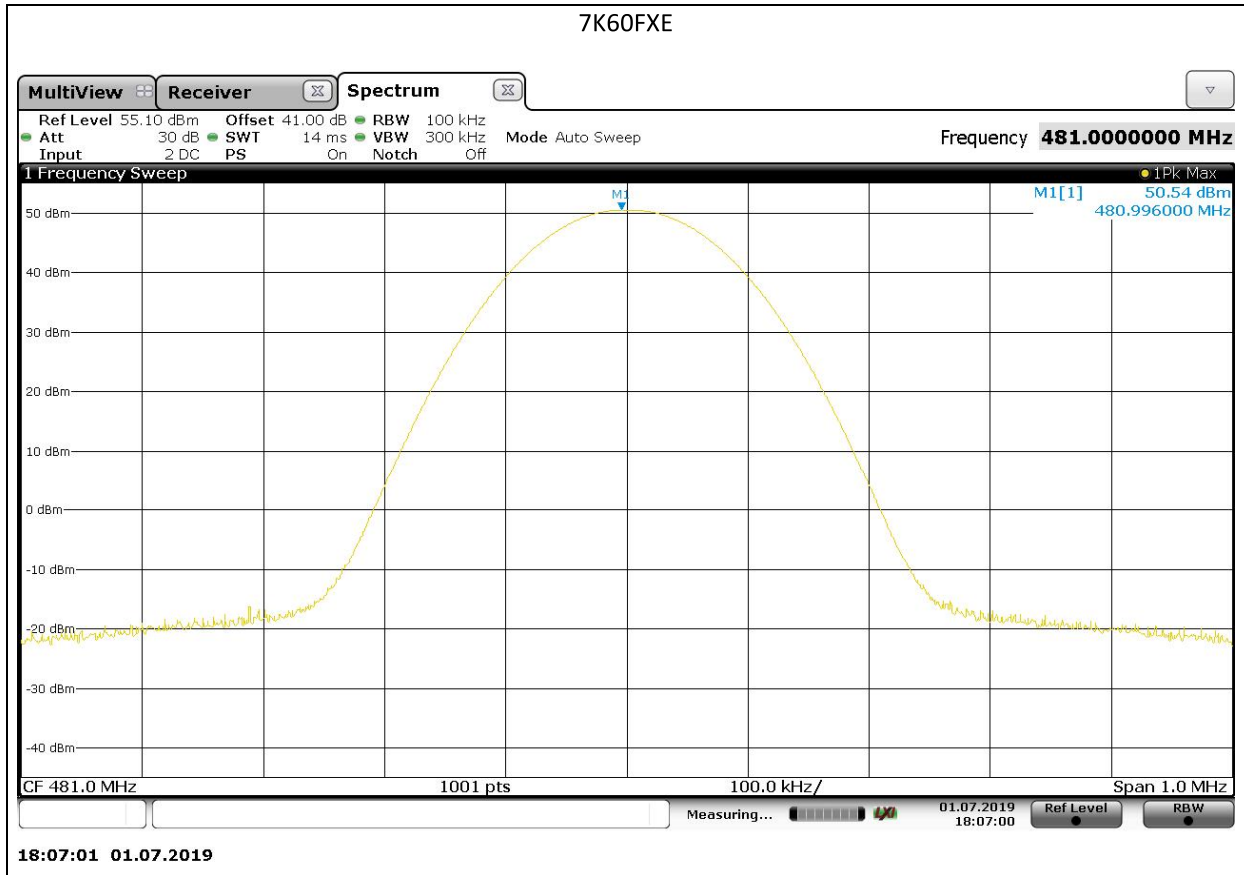

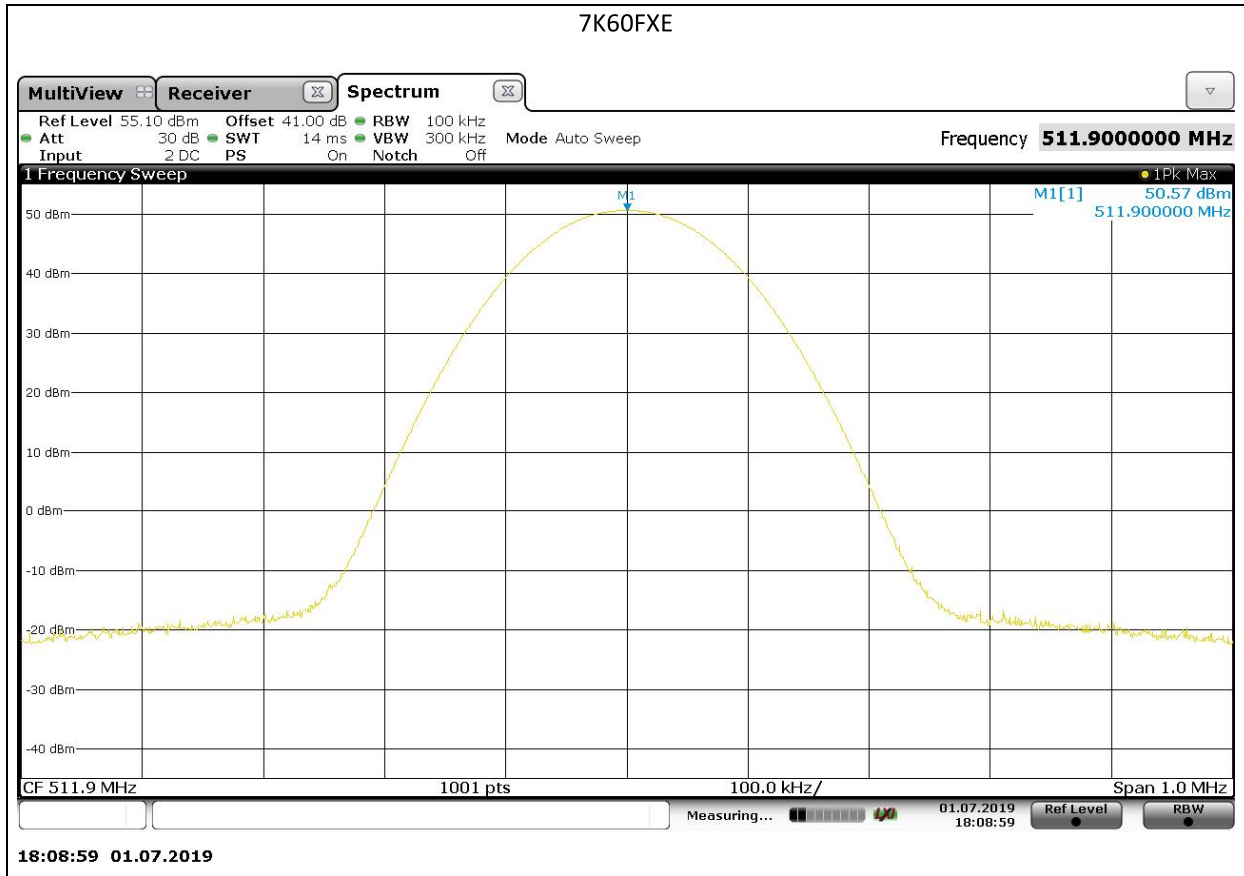







Appendix A: Test results

Report Number: 376484TRFWL

Specification: FCC 90

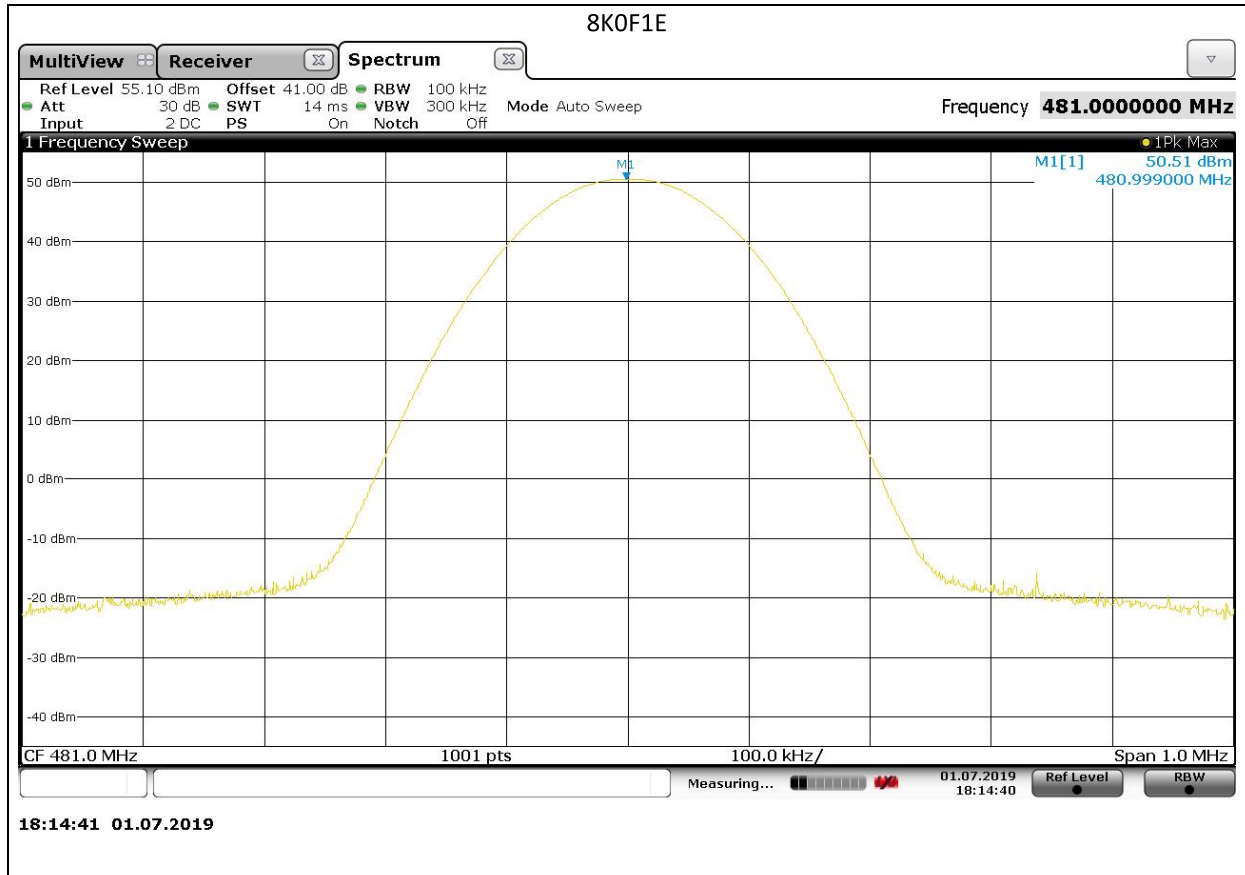





### Clause 90.207 Modulation characteristics

Unless specified elsewhere in this part, stations will be authorized emissions as provided for in paragraphs (b) through (n) of section 90.207.

#### **§2.1047 Measurements required: Modulation characteristics.**

(a) Voice modulated communication equipment. A curve or equivalent data showing the frequency response of the audio modulating circuit over a range of 100 to 5000 Hz shall be submitted. For equipment required to have an audio low-pass filter, a curve showing the frequency response of the filter, or of all circuitry installed between the modulation limiter and the modulated stage shall be submitted.

(b) Equipment which employs modulation limiting. A curve or family of curves showing the percentage of modulation versus the modulation input voltage shall be supplied. The information submitted shall be sufficient to show modulation limiting capability throughout the range of modulating frequencies and input modulating signal levels employed.

(c) Single sideband and independent sideband radiotelephone transmitters which employ a device or circuit to limit peak envelope power. A curve showing the peak envelope power output versus the modulation input voltage shall be supplied. The modulating signals shall be the same in frequency as specified in paragraph (c) of §2.1049 for the occupied bandwidth tests.

(d) Other types of equipment. A curve or equivalent data which shows that the equipment will meet the modulation requirements of the rules under which the equipment is to be licensed.

Test date: 2019-06-25

Test results: Pass

Test data

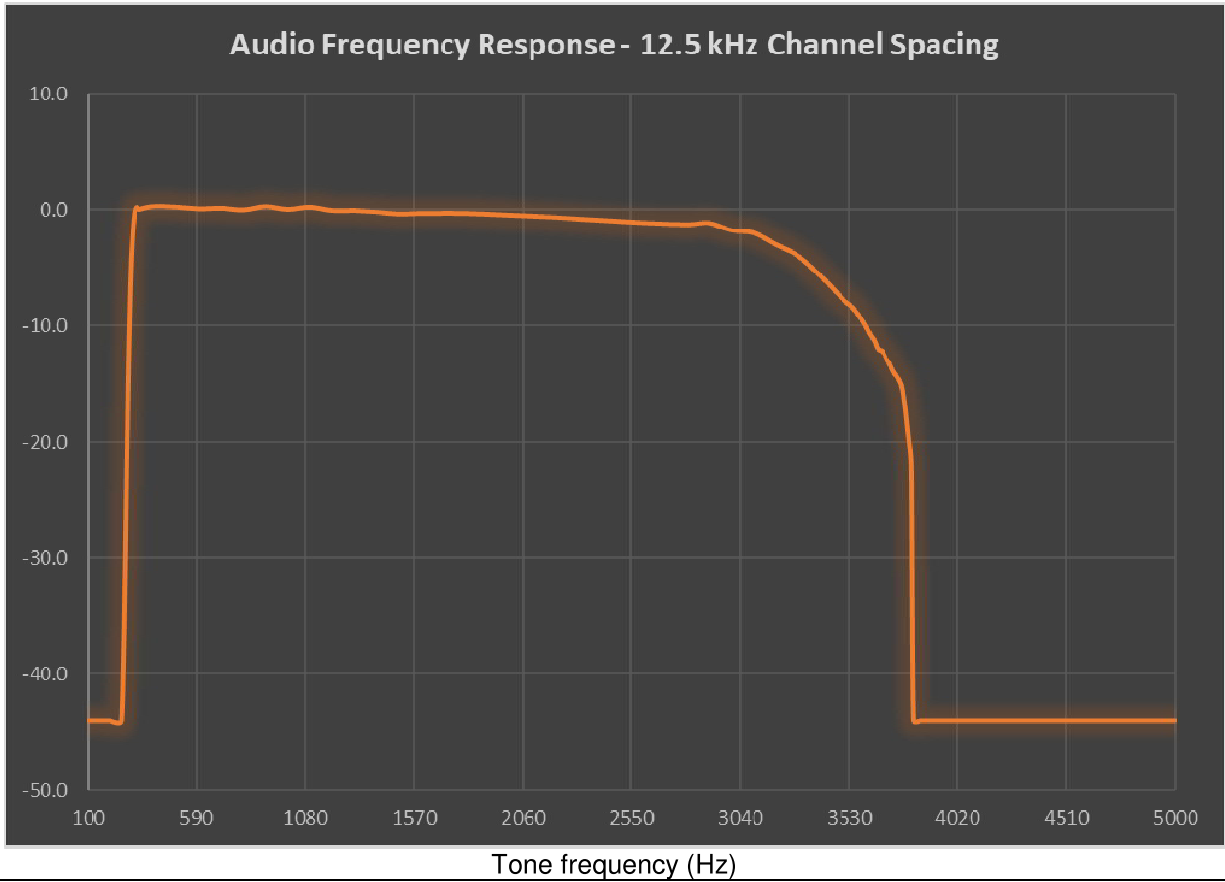

Test data

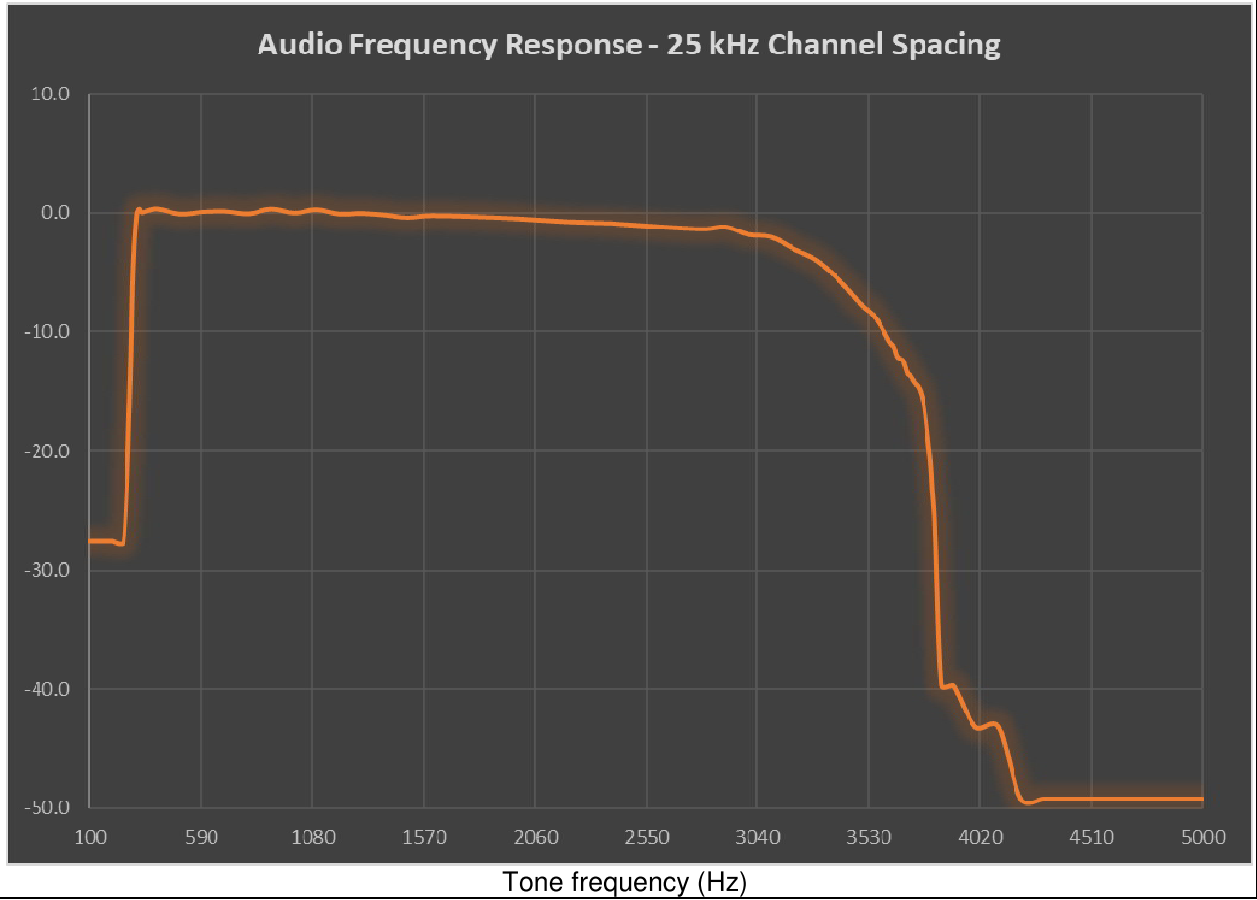

Test data

Modulation limiting

Percentage of modulation - 12.5 kHz Channel Spacing

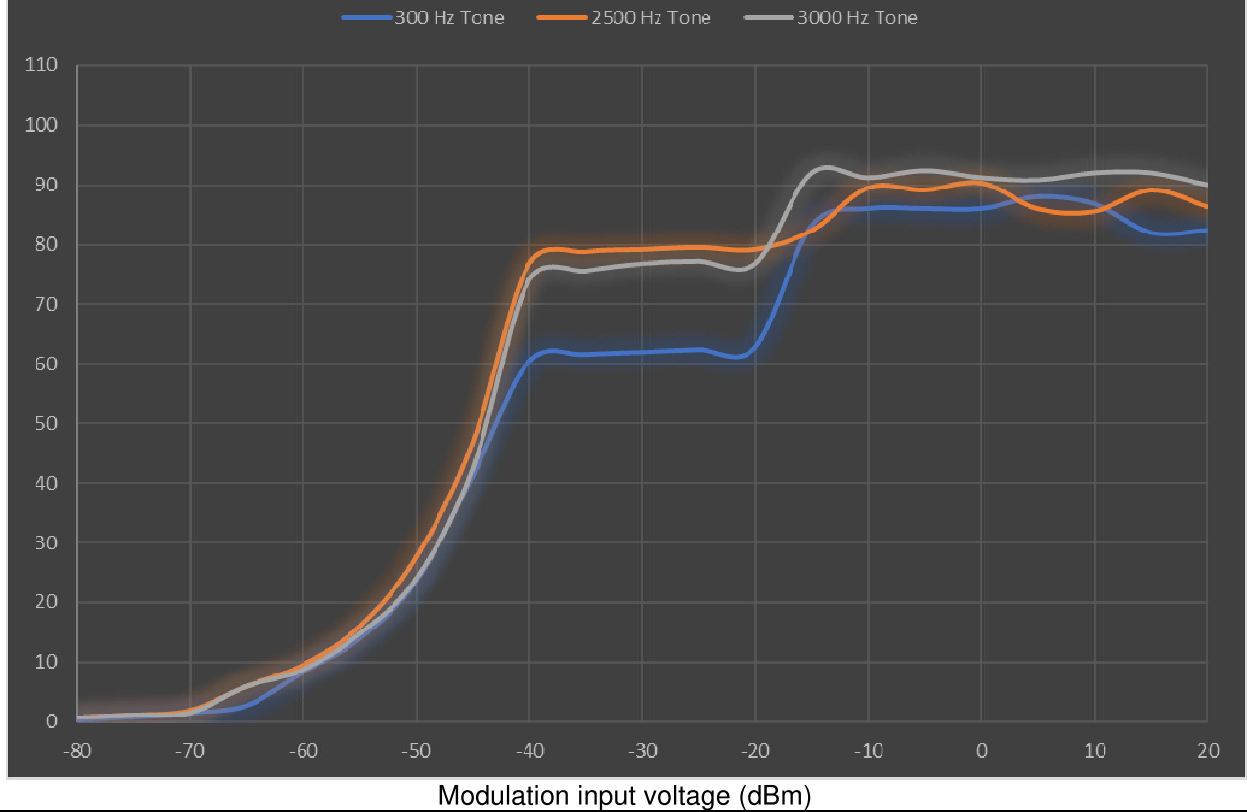

Test data

Modulation limiting

Percentage of modulation - 25 kHz Channel Spacing

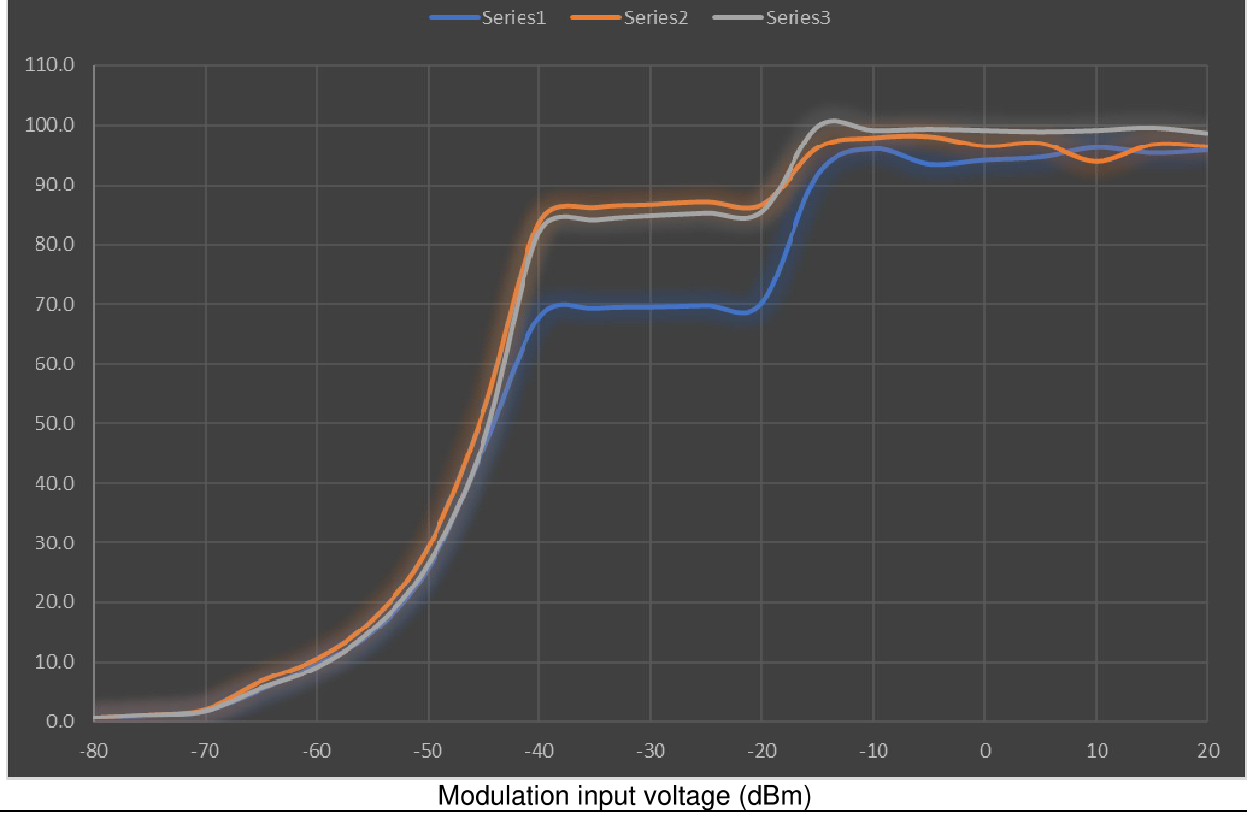



### Clause 90.209 Occupied bandwidth

Unless specified elsewhere, channel spacings and bandwidths that will be authorized in the following frequency bands are given in the following table:

STANDARD CHANNEL SPACING/BANDWIDTH

Frequency band (MHz)	Channel spacing (kHz)	Authorized bandwidth (kHz)
Below 25 <sup>2</sup>		
25-50	20	20
72-76	20	20
150-174	<sup>1</sup> 7.5	<sup>1 3</sup> 20/11.25/6
216-220 <sup>5</sup>	6.25	20/11.25/6
220-222	5	4
406-512 <sup>2</sup>	<sup>1</sup> 6.25	<sup>1 3 6</sup> 20/11.25/6
806-809/851-854	12.5	20
809-817/854-862	12.5	<sup>6</sup> 20/11.25
817-824/862-869	25	<sup>6</sup> 20
896-901/935-940	12.5	13.6
902-928 <sup>4</sup>		
929-930	25	20
1427-1432 <sup>5</sup>	12.5	12.5
<sup>3</sup> 2450-2483.5 <sup>2</sup>		
Above 2500 <sup>2</sup>		

Operations using equipment designed to operate with a 25 kHz channel bandwidth will be authorized a 20 kHz bandwidth. Operations using equipment designed to operate with a 12.5 kHz channel bandwidth will be authorized a 11.25 kHz bandwidth. Operations using equipment designed to operate with a 6.25 kHz channel bandwidth will be authorized a 6 kHz bandwidth. All stations must operate on channels with a bandwidth of 12.5 kHz or less beginning January 1, 2013, unless the operations meet the efficiency standard of §90.203(j)(3).

**§2.1049 Measurements required: Occupied bandwidth.**

The occupied bandwidth, that is the frequency bandwidth such that, below its lower and above its upper frequency limits, the mean powers radiated are each equal to 0.5 percent of the total mean power radiated by a given emission shall be measured under the conditions stated in §2.1049 as applicable.

Test date: 2019-06-25

Test results: Pass





Test data

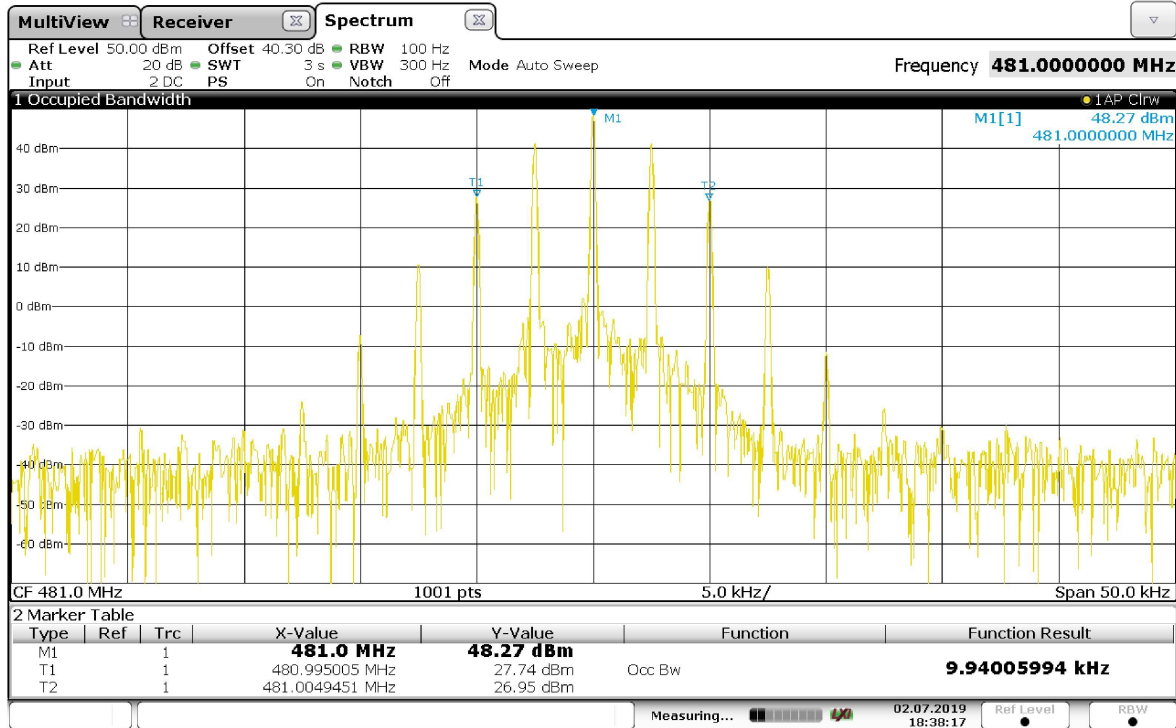

18:38:18 02.07.2019

Channel MID – FM modulation with 12.5 kHz channel bandwidth



Test data

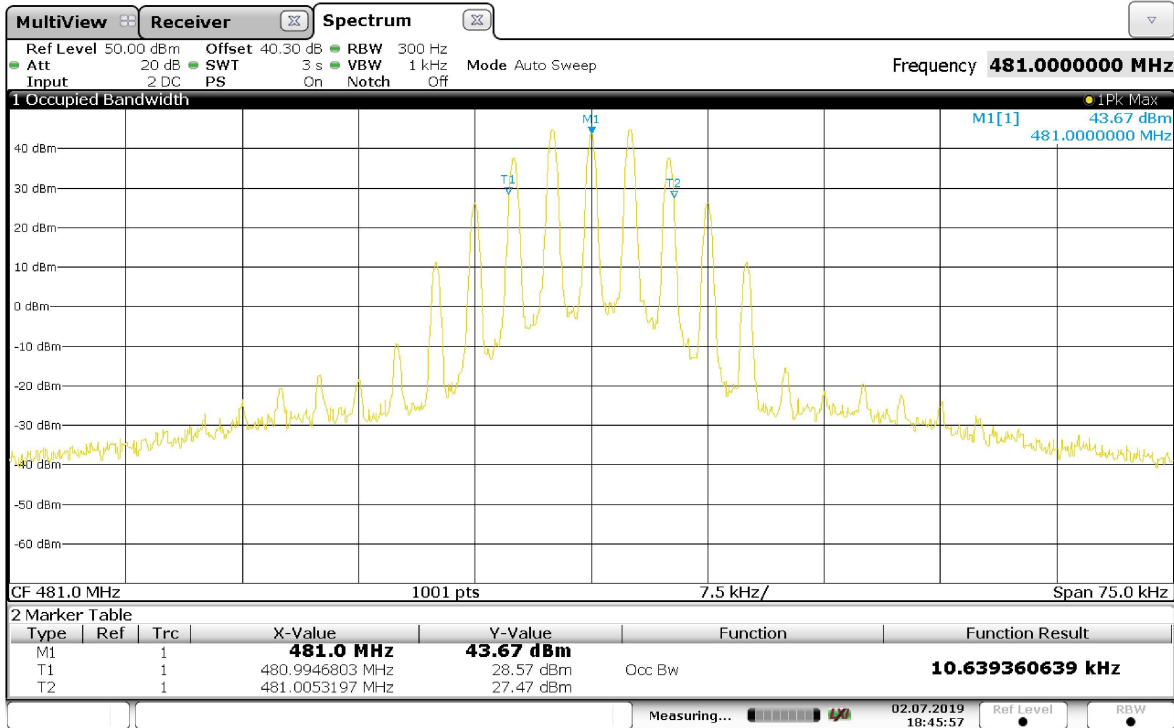

18:45:58 02.07.2019

Channel MID – FM modulation with 25 kHz channel bandwidth



Test data

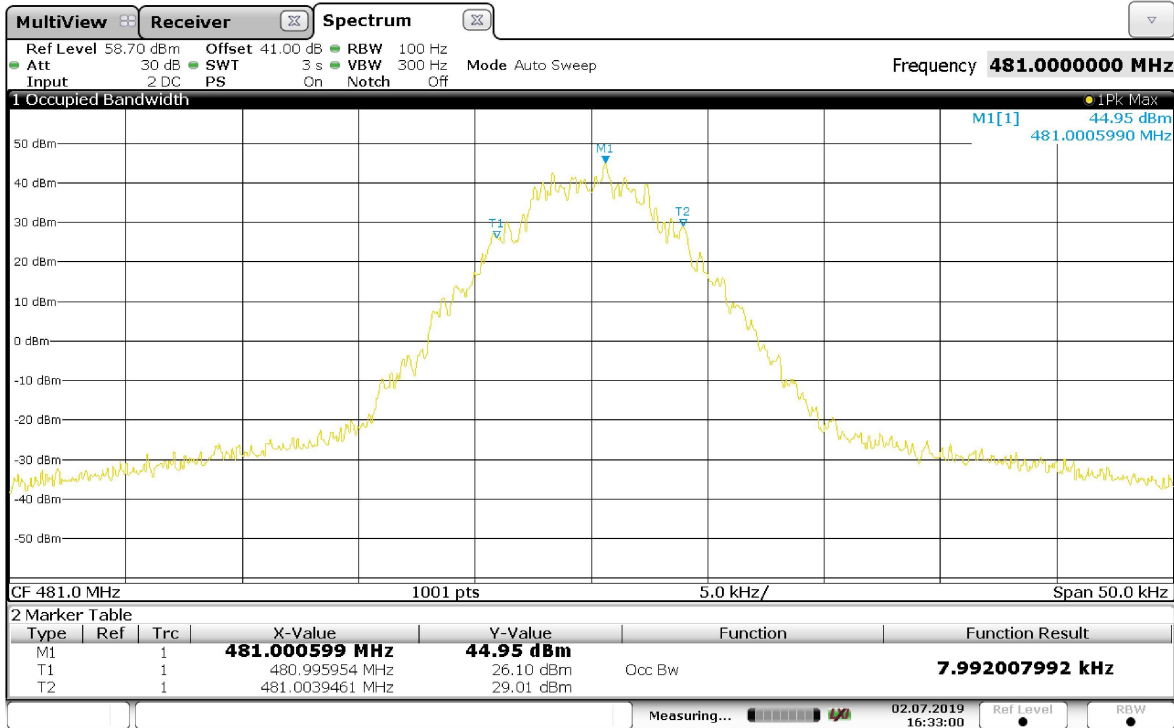

16:33:00 02.07.2019

Channel MID – 4FSK modulation with 12.5 kHz channel bandwidth



Test data

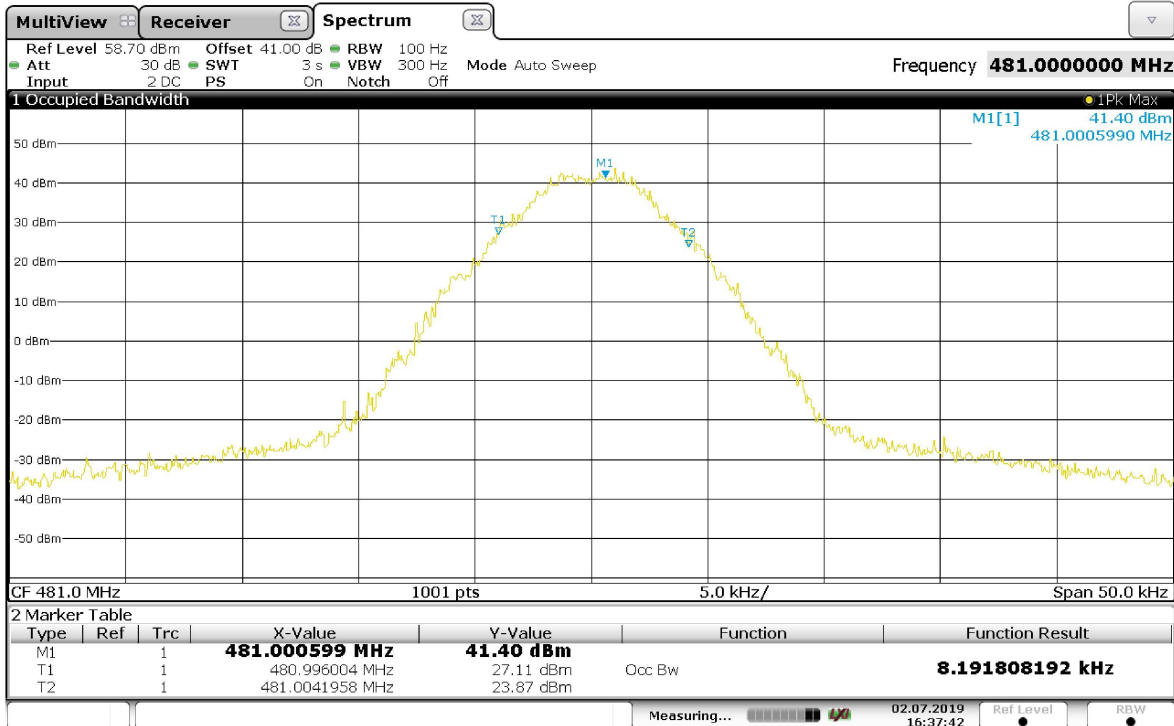

16:37:43 02.07.2019

Channel MID – C4FM modulation with 12.5 kHz channel bandwidth

## Clause 90.210 and 22.359 Emission masks

### §90.210 Emission masks.

Except as indicated elsewhere in this part, transmitters used in the radio services governed by this part must comply with the emission masks outlined in this section. Unless otherwise stated, per paragraphs (d)(4), (e)(4), and (o) of this section, measurements of emission power can be expressed in either peak or average values provided that emission powers are expressed with the same parameters used to specify the unmodulated transmitter carrier power. For transmitters that do not produce a full power unmodulated carrier, reference to the unmodulated transmitter carrier power refers to the total power contained in the channel bandwidth. Unless indicated elsewhere in this part, the table in this section specifies the emission masks for equipment operating under this part.

#### APPLICABLE EMISSION MASKS

Frequency band (MHz)	Mask for equipment with audio low pass filter	Mask for equipment without audio low pass filter
Below 25 <sup>1</sup>	A or B	A or C
25-50	B	C
72-76	B	C
150-174 <sup>2</sup>	B, D, or E	C, D or E
150 paging only	B	C
220-222	F	F
421-512 <sup>2 5</sup>	B, D, or E	C, D, or E
450 paging only	B	G
806-809/851-854 <sup>6</sup>	B	H
809-824/854-869 <sup>35</sup>	B, D	D, G.
896-901/935-940	I	J
902-928	K	K
929-930	B	G
4940-4990 MHz	L or M	L or M
5850-5925 <sup>4</sup>		
All other bands	B	C



Emission Mask B. For transmitters that are equipped with an audio low-pass filter, the power of any emission must be attenuated below the unmodulated carrier power (P) as follows:

- (1) On any frequency removed from the assigned frequency by more than 50 percent, but not more than 100 percent of the authorized bandwidth: At least 25 dB.
- (2) On any frequency removed from the assigned frequency by more than 100 percent, but not more than 250 percent of the authorized bandwidth: At least 35 dB.
- (3) On any frequency removed from the assigned frequency by more than 250 percent of the authorized bandwidth: At least  $43 + 10 \log (P)$  dB.

Emission Mask D — 12.5 kHz channel bandwidth equipment. For transmitters designed to operate with a 12.5 kHz channel bandwidth, any emission must be attenuated below the power (P) of the highest emission contained within the authorized bandwidth as follows:

- (1) On any frequency from the center of the authorized bandwidth  $f_0$  to 5.625 kHz removed from  $f_0$ : Zero dB.
- (2) On any frequency removed from the center of the authorized bandwidth by a displacement frequency ( $f_d$  in kHz) of more than 5.625 kHz but no more than 12.5 kHz: At least  $7.27(f_d - 2.88 \text{ kHz})$  dB.
- (3) On any frequency removed from the center of the authorized bandwidth by a displacement frequency ( $f_d$  in kHz) of more than 12.5 kHz: At least  $50 + 10 \log (P)$  dB or 70 dB, whichever is the lesser attenuation.
- (4) The reference level for showing compliance with the emission mask shall be established using a resolution bandwidth sufficiently wide (usually two or three times the channel bandwidth) to capture the true peak emission of the equipment under test. In order to show compliance with the emission mask up to and including 50 kHz removed from the edge of the authorized bandwidth, adjust the resolution **bandwidth to 100 Hz with** the measuring instrument in a peak hold mode. A sufficient number of sweeps must be measured to insure that the emission profile is developed. If video filtering is used, its bandwidth must not be less than the instrument resolution bandwidth. For emissions beyond 50 kHz from the edge of the authorized bandwidth, see paragraph (o) of this section. If it can be shown that use of the above instrumentation settings do not accurately represent the true interference potential of the equipment under test, an alternate procedure may be used provided prior Commission approval is obtained.

### §22.359 Emission limitations.

The rules in this section govern the spectral characteristics of emissions in the Public Mobile Services, except for the Air-Ground Radiotelephone Service (see §22.861, instead) and the Cellular Radiotelephone Service (see §22.917, instead).

- (a) Out of band emissions. The power of any emission outside of the authorized operating frequency ranges must be attenuated below the transmitting power (P) by a factor of at least  $43 + 10 \log (P)$  dB.



Appendix A: Test results

Report Number: 376484TRFWL

Specification: FCC 90

(b) Measurement procedure. Compliance with these rules is based on the use of measurement instrumentation employing a resolution bandwidth of 30 kHz or more. In the 60 kHz bands immediately outside and adjacent to the authorized frequency range or channel, a resolution bandwidth of at least one percent of the emission bandwidth of the fundamental emission of the transmitter may be employed. A narrower resolution bandwidth is permitted in all cases to improve measurement accuracy provided the measured power is integrated over the full required measurement bandwidth (i.e., 30 kHz or 1 percent of emission bandwidth, as specified). The emission bandwidth is defined as the width of the signal between two points, one below the carrier center frequency and one above the carrier center frequency, outside of which all emissions are attenuated at least 26 dB below the transmitter power.

(c) Alternative out of band emission limit. Licensees in the Public Mobile Services may establish an alternative out of band emission limit to be used at specified frequencies (band edges) in specified geographical areas, in lieu of that set forth in this section, pursuant to a private contractual arrangement of all affected licensees and applicants. In this event, each party to such contract shall maintain a copy of the contract in their station files and disclose it to prospective assignees or transferees and, upon request, to the FCC.

(d) Interference caused by out of band emissions. If any emission from a transmitter operating in any of the Public Mobile Services results in interference to users of another radio service, the FCC may require a greater attenuation of that emission than specified in this section.

Test date: 2019-07-02

Test results: Pass