

# Operating Instructions



## RADAR DETECTION SYSTEM (77GHz 2T4R)

Please read this manual thoroughly before operating the unit,  
and keep it for future reference.

V1.0

# Contents

1. Precautions.....	1
2. Product Features .....	2
3. Technical Specifications.....	2
4. Accessories .....	3
5. Parts Identification .....	4
6. Installation .....	5
7. Object Detection Capability.....	8
8. PC Configuration Tool.....	9
9. Mobile Phone Configuration Tool .....	20
10. Testing and Maintenance .....	27
11. Troubleshooting .....	28

# 1. Precautions

## ● Storage and Keeping

- 1 ) Do not expose the device to excessive heat or cold. The storage temperature of this device is  $-30\sim+80^{\circ}\text{C}$ , and the operating temperature is  $-20\sim+70^{\circ}\text{C}$ . The humidity is RH90%.
- 2 ) Never use this device in environments with excessive moisture, dust or smoke.
- 3 ) Avoid dropping or striking this device.
- 4 ) Never puncture, scratch or use abrasive cleaning materials on this device.
- 5 ) Do not place cables where they may be pinched or stepped on.

## ● Operating Precautions

- 1 ) The device may be powered by a 12 or 24 volt automotive battery or vehicle electrical system.
- 2 ) Improper connection of the system or power supply will damage the sensor and control box.
- 3 ) Testing and inspection of the system in accordance with these instructions and a record of the results should be listed on the daily maintenance report. The units on operating vehicles must be tested each day prior to the vehicle's operation. Results of this test must be recorded in the maintenance log.
- 4 ) The radar detection system is intended for use on commercial vehicles and machinery equipment. Proper installation requires a good understanding of vehicle/machine electrical systems and procedures, along with proficiency in the installation.



### Warning!

1. Do not open the equipment's enclosure. This can cause damage, short-circuiting or electrical shocks that could lead to serious injury or death.
2. The equipment is not an alternative to safe driving practices.
3. Must use a plug sealer if this port is not used.
4. The loosen wire reserved on E-cable should be isolated to avoid short-circuiting.



This symbol is intended to alert the user not to dispose of electrical and electronic equipment.

## 2. Product Features

- 1) Advanced microwave sensing technology.
- 2) Automatically activated when the driver shifts vehicle into reverse status.
- 3) Configuring detection zones and alarm trigger with USB to UART cable on computer.
- 4) Configuring and updating system by phone or computer through Wi-Fi (optional function). It can be used when the control box has the Wi-Fi module.
- 5) The device is capable of visualizing the radar-zones on the display. As soon as an object enters the detection zone it will activate a transparent colored visualization alert in the monitor to make the driver aware of the potential danger. (Green - Far, Yellow - Middle, Red - Close).
- 6) Detect moving objects including any transportation vehicles, motorcycles, bicycles, pedestrians, etc.
- 7) Work effectively in harsh environment and in poor visibility including darkness, smoke, fog and dust.

## 3. Technical Specifications









- 1) Frequency of Radar sensor: 76.00...77.00GHz.
- 2) Transmitter Type: FMCW.
- 3) Power Supply: 10 to 32V DC.
- 4) Detection Range: 0.2- 40m, width limit, up to 5 detection zones (distance of each zone can be configured ).
- 5) Detection Zone Visualization: Green (furthest), Yellow (middle), Red (closest).
- 6) Detection Tolerance: +/-15cm.
- 7) Antenna Beam Angle: 120° (Horizontal), 14° (Vertical).
- 8) Trigger Input x1 : Trigger from vehicle, high active  
Range above +10Vdc, up to supply voltage.
- 9) Alarm Output x1: Switched to Ground when activated  
Loading up to 1.0A.
- 10) Video format:CVBS(PAL/NTSC), 720P 25fps/30fps, 1080P 25fps/30fps
- 11) Wi-Fi module: 2.4GHz (Optional)
- 12) Operating Temperature: -20 to +70°C.
- 13) Storage Temperature: -30 to +80°C.
- 14) IP Protection: IP69K (sensor), IP66(Control Box)
- 15) Vibration Rating: 5.9G
- 16) Dimensions: Sensor: 106.6(W) x72.9(H) x34.5(D) mm.  
Control Box: 152.6(W) x89.2(H) x53.8(D) mm.
- 17) Weight: 158.8Grams (sensor) 240Grams (control box)
- 18) Mounting: Two (4.5mm) diameter mounting holes (sensor)  
Four (6mm) diameter mounting holes (control box)



### Special Notice

All specifications are subject to change without notice.

## 4. Accessories

 <p>Sensor Transition Cable 3m red (4 pin aviation interface, female to male)</p>	 <p>Monitor Transition Cable 3m (4 pin aviation interface, female to female)</p>
 <p>Camera Cable 3m (4 pin aviation interface, female to male) (Optional)</p>	 <p>Extension Cable 1.5m (5 pin aviation female interface to 4 wires)</p>
 <p>Plug Sealer</p>	 <p>Buzzer</p>
 <p>USB to UART Cable</p>	 <p>Sensor mounting Bracket (Optional)</p>
 <p>Dual Sensors Transition cable (4 pin aviation interface, one female to two male) 3m red (Optional)</p>	<p>Manual</p>

Attention: "Optional" means that this is an optional accessory.

# 5. Parts Identification

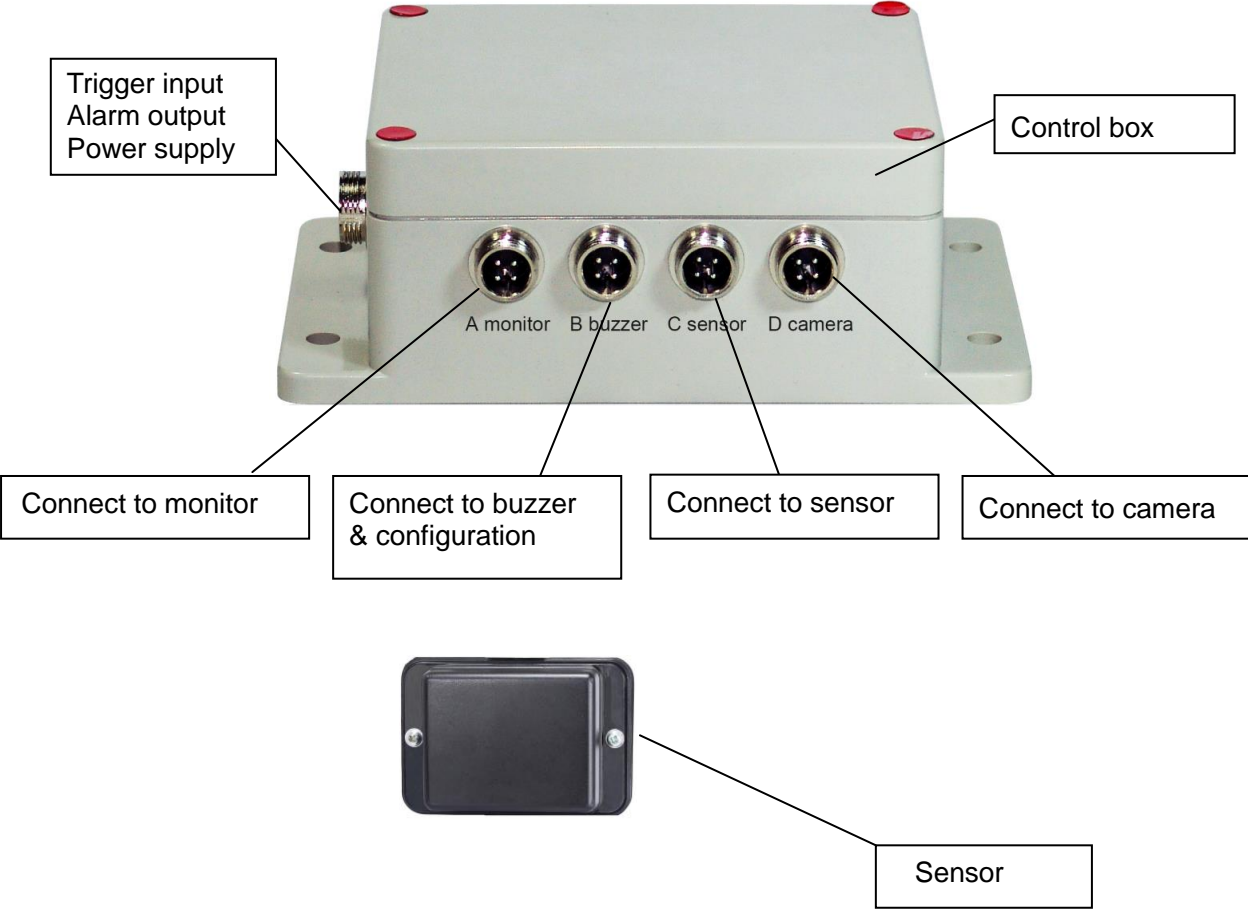

# 6. Installation

Firstly check the contents of the shipping package and make sure the following items are included:

- 1(or 2) – Sensor(s)
- 1 - Control Box
- 1 - Buzzer
- 1 - Cable 1.5m Extension Cable
- 1 - Cable 3m Monitor Transition Cable
- 1 - Cable 3m Sensor Transition Cable red
- 1 - Cable 0.9m USB to UART Cable

Operation Manual & some installation accessories, some accessories may be excluded if they are optional.

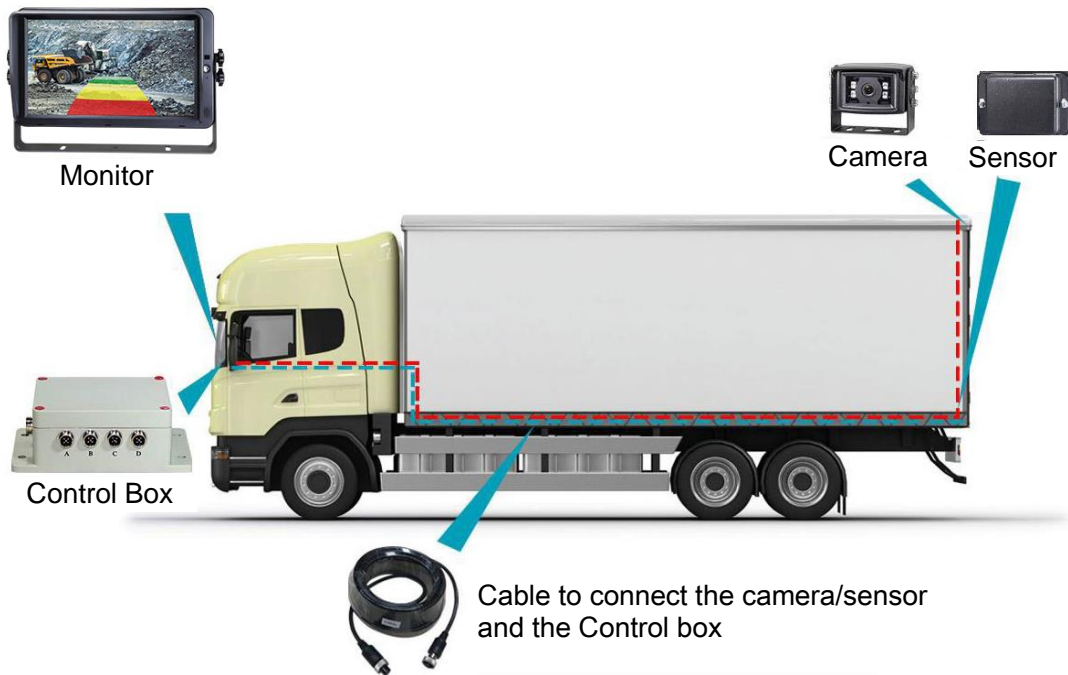

## 6.1 Sensor Installation

The radar sensor mounting location is important to proper operation. Ideally the sensor should be mounted on the rear center of the vehicle at roughly 1m +/- 0.3m above the ground. The sensor face should be perpendicular to the ground. The arrow on the back of the sensor must be placed downward.

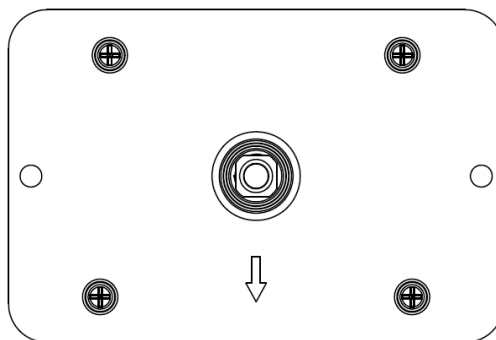

It can be tilted horizontally at a certain angle with sensor mounting bracket (Optional).



**Important!**

Before the RADAR DETECTION SYSTEM is permanently installed to the vehicle, verify that the sensor mounting location provides a clear detection zone. Temporarily attach the sensor in the proposed mounting location, apply power to the system, and verify that nothing is being detected.

## 6.2 System Connection Diagram (2 ways)

### 6.2.1 Integrating with Vision System

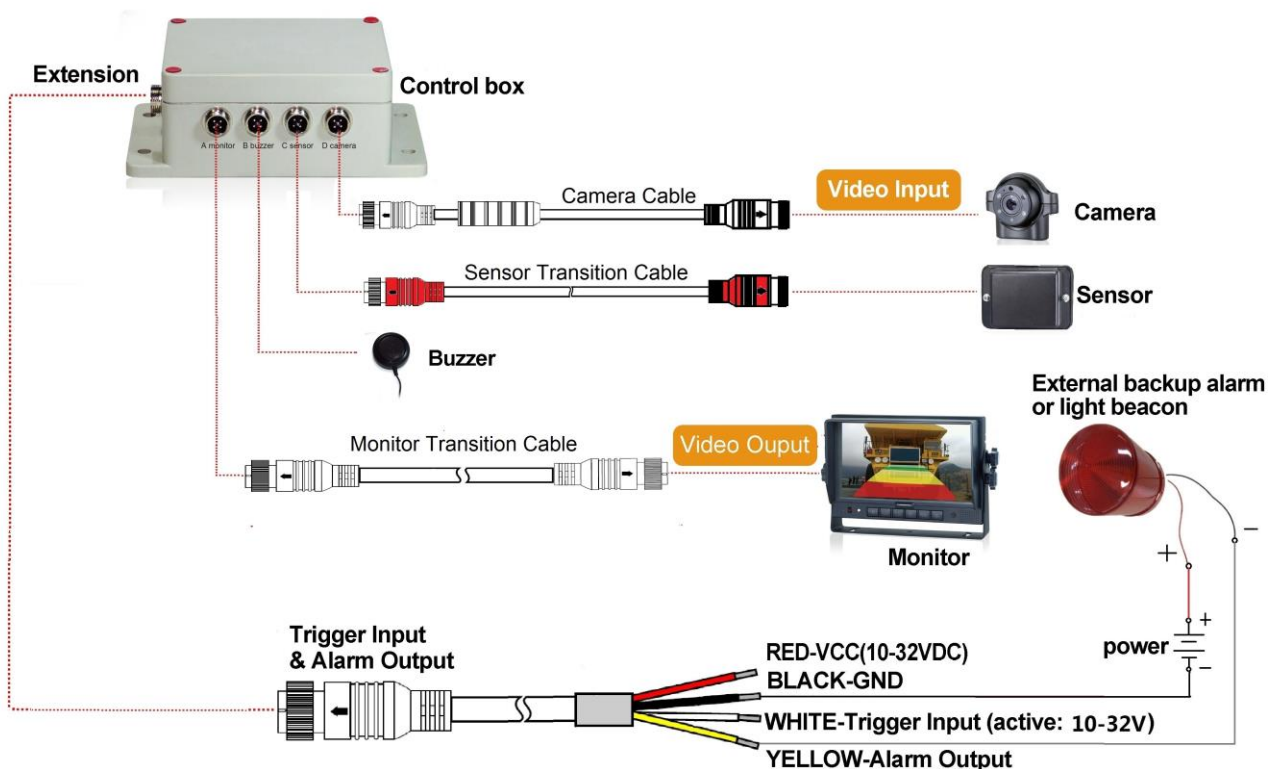

Port A for monitor (through Cable 3m Monitor Transition Cable (Optional))

Port B for buzzer

Port C for radar sensor (through Cable 3m Sensor Transition Cable red for one sensor, and cable 3m



dual Sensors Transition cable for two sensors,each sensor can be extended with Sensor Transition Cable)

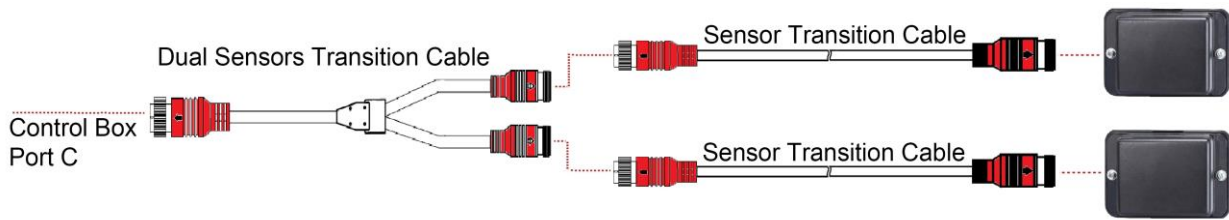

The connection of two sensors (Optional)

Port D for backup camera (through Cable 3m Camera Cable)

Port E for extension cable (through Cable 1.5m Extension Cable, Red: 10-32VDC, Black: Ground, White: Trigger input, Yellow: Alarm output)

The whole system is powered by vehicle battery through DC Wire or Cigarette Lighter.

### 6.2.2 Standalone System without Vision System

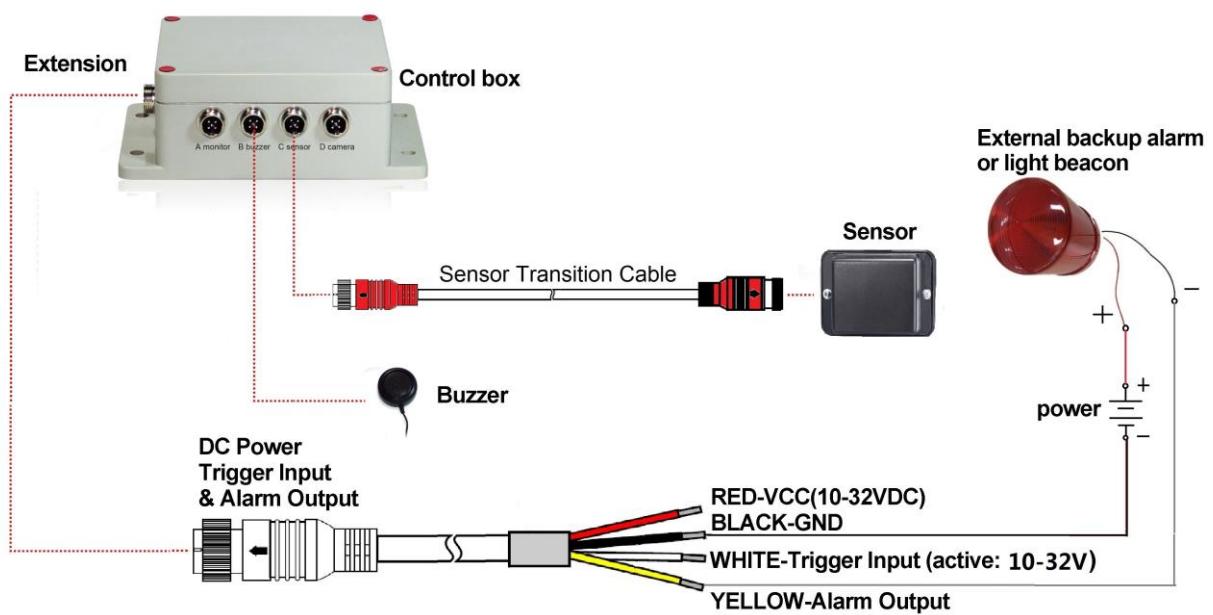

Port A (Reserved, use a plug sealer for IP protection)

Port B for buzzer

Port C for radar sensor (through Cable 3m Sensor Transition Cable red for one sensor, and cable 3m dual Sensors Transition cable for two sensors, each sensor can be extended with Sensor Transition Cable)

Port D (Reserved, use a plug sealer for IP protection)

Port E for extension cable (through Cable 1.5m Extension Cable, Red: 10-32VDC, Black: Ground, White: Trigger input, Yellow: Alarm output)

The whole system is powered by extension DC wire (Red: 10-32VDC, Black: Ground) which is powered by vehicle battery or Cigarette Lighter.

### ●Trigger Input

The system provides an auxiliary input that allows an external signal input to change the sensor status between standby and active. As a backing sensor application, single white wire of extension cable connects to positive power wire of the back-up light.

### ●Alarm Output

The system provides an auxiliary output that triggers an external device whenever the sensor detects an object. This output can be used to activate an external backup alarm or a light beacon. The output is switched from a high impedance state to ground when activated and is protected against over-current or short-circuit. The maximum operating current is approximately 1 amp. The power supply for alarm can't exceed 24V.

## 7. Object Detection Capability

### 7.1 Tips for Users

Radar works on the principle of line of sight and relies on some of the electromagnetic energy transmitted by the sensor being reflected back from the object to the sensor. If an object does not reflect enough electromagnetic energy back to the sensor it will not be detected.

In the case where there are multiple objects in the detection area at various distances and/or angles, the sensor detects the closest object, which is the most important one for collision avoidance.

The object nature, location and direction are key influences in determining if an object is detected or not. The influencing factors are listed below.

- Size: Larger surfaces are detected better than smaller surfaces.
- Material: Metal is detected better than non-metal materials, e.g. wood, plastic.
- Surface: A smooth and solid surface is detected better than rough, uneven, porous, fragmented or liquid surfaces, e.g. bushes, gravel, water.
- Shape: A flat object is better detected than a complex shape.
- Angle: An object facing directly towards the sensor (perpendicular, orientation head on to the sensor) is detected better than an object that is located towards the edges of the detection area or at an angle.
- Distance: An object closer to the sensor is better detected than one that it is further away.

## 7.2 Alerts Description

The system provides the operator both visual and audible indications of a detected object. As soon as an object enters the zones it will activate a transparent visualization to make the operator aware of the potential danger. Distance to the detected object is displayed with five colored zones on monitor. Distance of each zone and the width can be both customized.

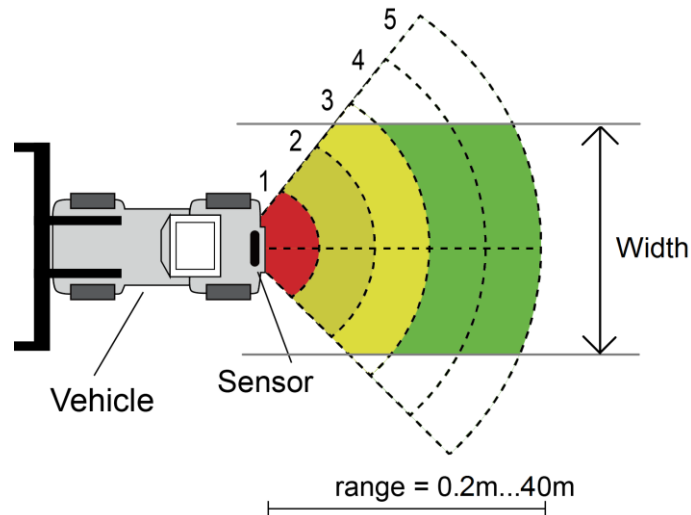

The buzzer can provide an audible alert through “Beep” that will increase in rate as an object becomes closer, alerting the operator that an object is being detected. The monitor’s internal buzzer can provide an audible alert too.

Conditions	Visual	Buzzer
No Object Detected	None	Off
Object in Zone 5	Green	Bi-Bi-Bi
Object in Zone 4	Green	BiBi-BiBi-BiBi
Object in Zone 3	Yellow	BiBiBi-BiBiBi-BiBiBi
Object in Zone 2	Yellow	BiBiBiBi-BiBiBiBi-BiBiBiBi
Object in Zone 1	Red	Constant tone

## 8. PC Configuration Tool

### 8.1 PC System Requirements

The system requires a PC with a USB connector and the software environment with .NET Framework 4.6.2 (or newer) and Microsoft Visual C++ Redistributable package.

NDP462-KB3151800-x86-x64-AllOS-ENU.exe (Download from Microsoft Homepage)

<https://www.microsoft.com/en-us/download/details.aspx?id=53344>

vc\_redist.x64.exe or vc\_redist.x86.exe (Download from Microsoft Homepage)

<http://www.microsoft.com/en-us/download/details.aspx?id=48145>

The Configuration Tool is compatible with Microsoft Windows 7 or newer (32-bit or 64-bit version) operating system.

## 8.2 PC Software Installation

The software installation requires two steps. First, the installation of a USB to serial port driver and second the installation of the Configuration Tool itself. The installation files can be found on the supplied archive.

### 8.2.1 USB to Serial Port Driver Installation

A USB to serial port driver is required to communicate between the PC and the Control Box. We will provide the driver. You can also download the driver from official website of SILICON LABS.

<https://www.silabs.com/products/development-tools/software/usb-to-uart-bridge-vcp-drivers>

This driver we provided should be installed before the USB to serial port connection is made to a PC.

Double clicked "CP210xVCPInstaller\_x64.exe"(64-bits system) or "CP210xVCPInstaller\_x86.exe" file(32-bits system), then it starts installing the USB driver.

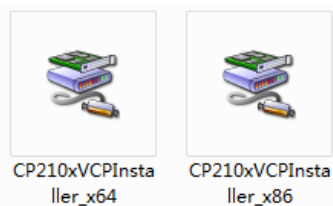

Go on with Next



and accept the license agreements. Go on with Next.

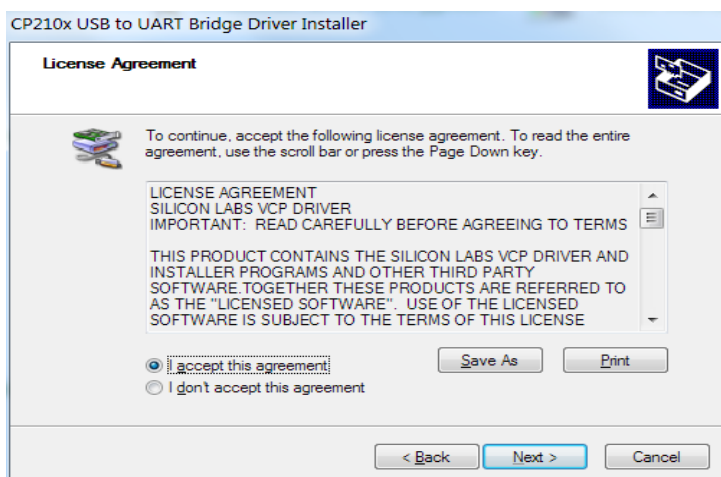

When finished you can close the installation with the Finish button.

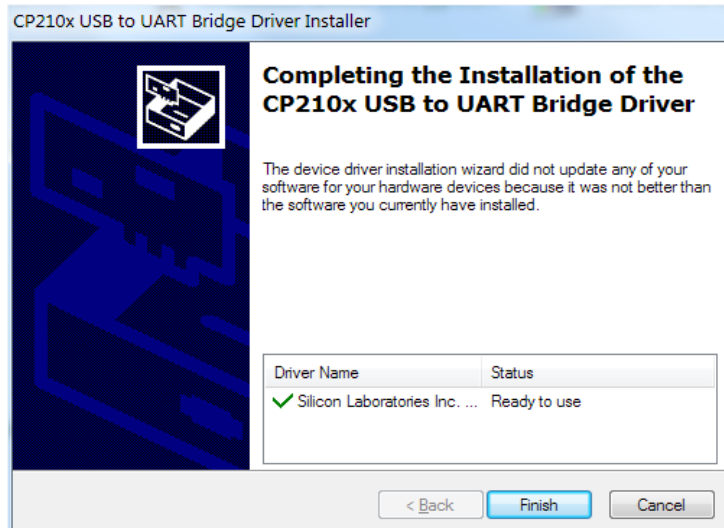

If you have plugged the cable into the PC while running the setup installation, please unplug and replug the cable for the system to detect the device.

Plug in the USB to Serial adapter to the PC USB port. Windows should detect the driver as Silicon Labs CP210x USB to UART Bridge. Go to Device Manager and check for the “Silicon Labs CP210x USB to UART Bridge” device and the COM port number assigned by Windows.

### 8.2.2 Configuration Tool Software Installation

The installation of the “Configuration Tool.exe” is very simple. Just extract the.exe from the archive (zip, rar, gz, 7-zip) in a directory of your choice. Start the Configuration Tool.exe on the PC.

## 8.3 Using the Configuration Tool Software

There are two ways to connection the Control Box. You can connect via Wi-Fi (optional function).Or you can also connect the Control Box’s Port B (B buzzer) to the PC with the USB to serial port cable.

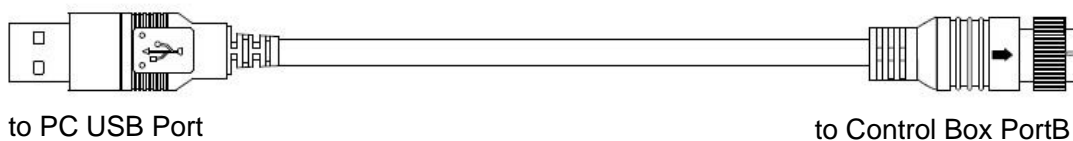

Before connection, ensure the Control Box is powered and the trigger input line is on low level (or no connect). And make sure all the connections are correct.

### 8.3.1 User Interface Overview

The interface of Configuration Tools is outlined below.

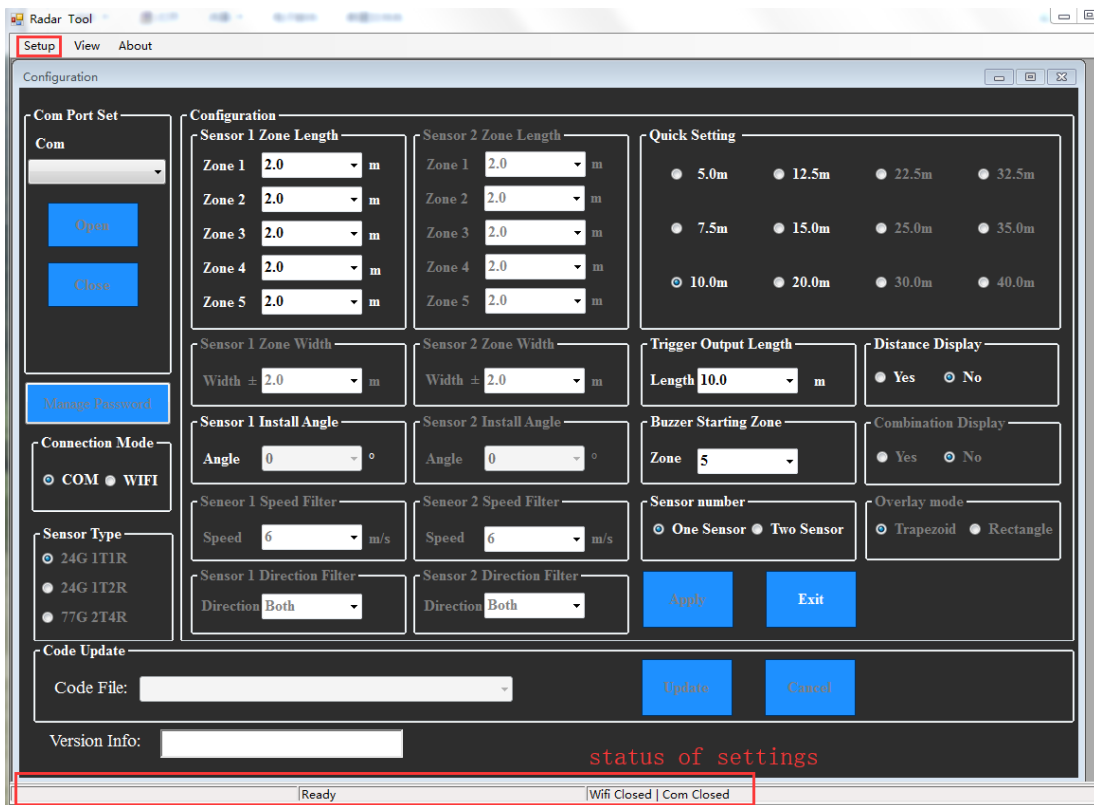

Click the “setup” button on the top bar and it will show the settings interface. The bottom bar is a status bar, which is used to show the connection state and application state.

The settings interface is divided into several parts.

COM port which is used to select the COM port number for connection when you select COM mode. If you select Wi-Fi mode in Connection Mode, the interface will change into Wi-Fi Port. “Manage Password” can set Wi-Fi password.

Code Update is updating function.

Other parts are used to set up the detection zone length, width (Type 1 sensor cannot be set), trigger output length, buzzer starting zone and so on.

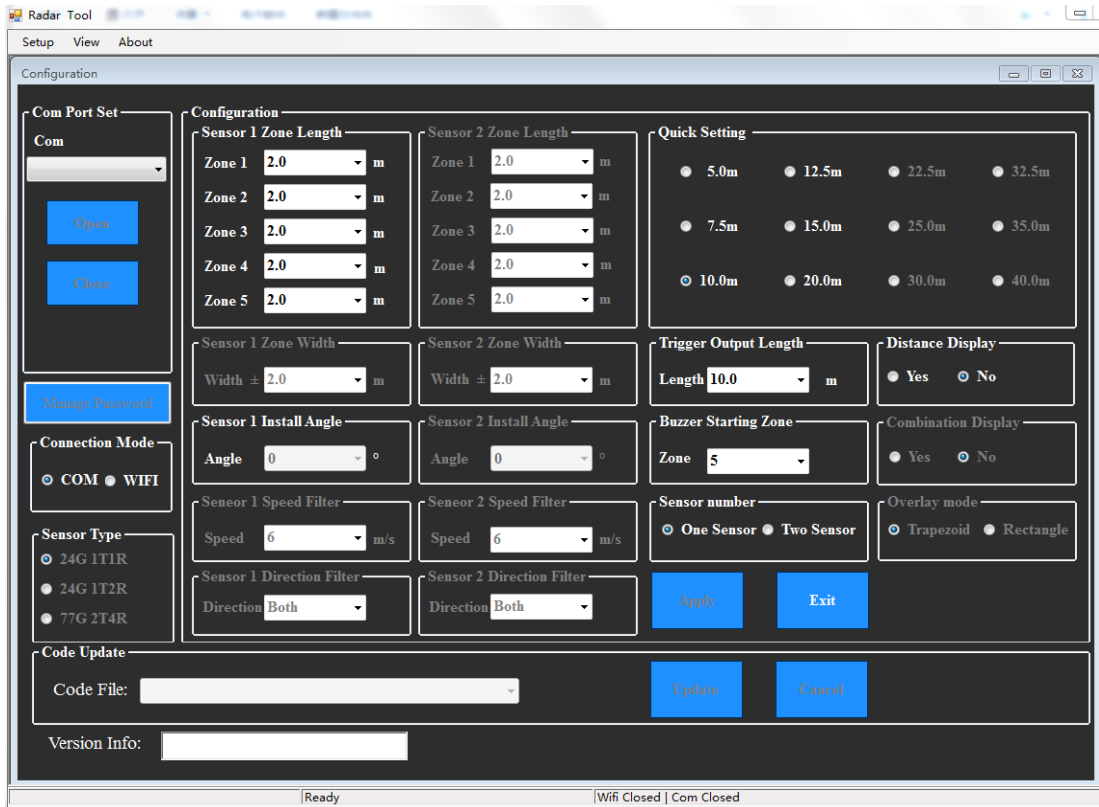

Click the “View” button and the interface is displayed above. It will change in pace with your settings.

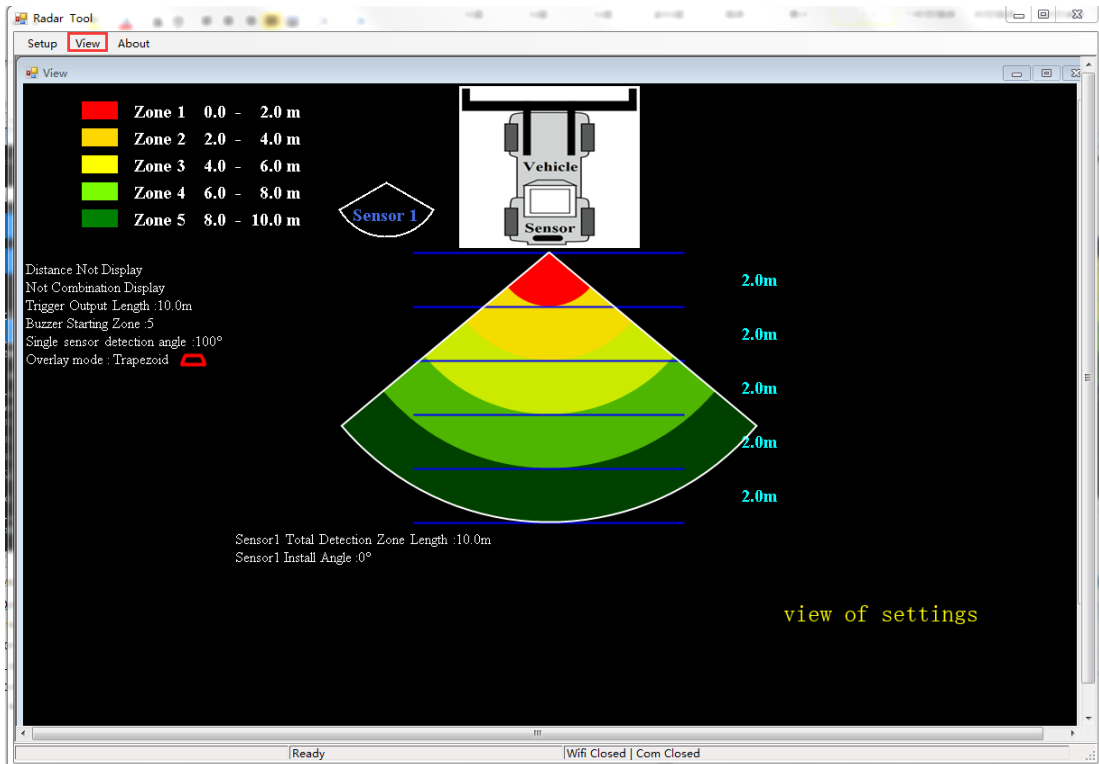

Clicking the "About" button and it will display the version number of the configuration tool.

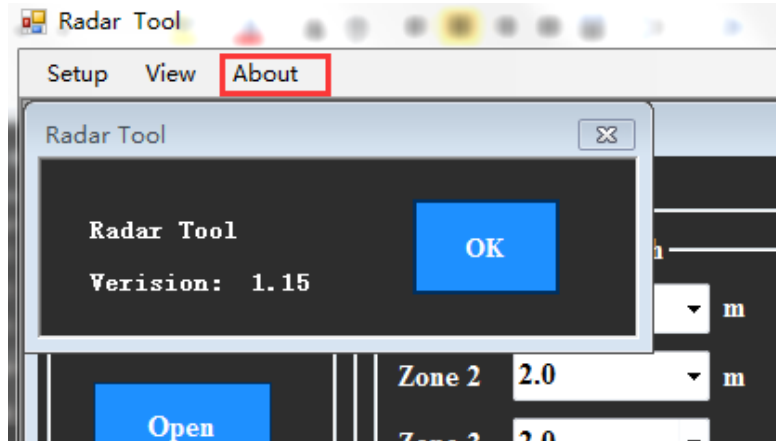

### 8.3.2 Connecting to the Control Box

#### 8.3.2.1 Connecting Via USB to UART Cable

Select the COM Mode. To check the COM port number you are using for the connected Control Box on the PC you will need to open Windows "Device Manager".

In the Device Manager window click "Ports (COM & LPT)" and check "Silicon Labs CP210x USB to UART Bridge (COM###)". The "###" represents the number of the port through which the display is currently connected to the PC.

The COM port identified before should be used by selecting it from the drop down list and then click "Open". When the connection is successful, "Com Closed" will change into "Com Opened" at the bottom status bar.

Com Port setup needs to be run every time the Configuration Tool is opened.

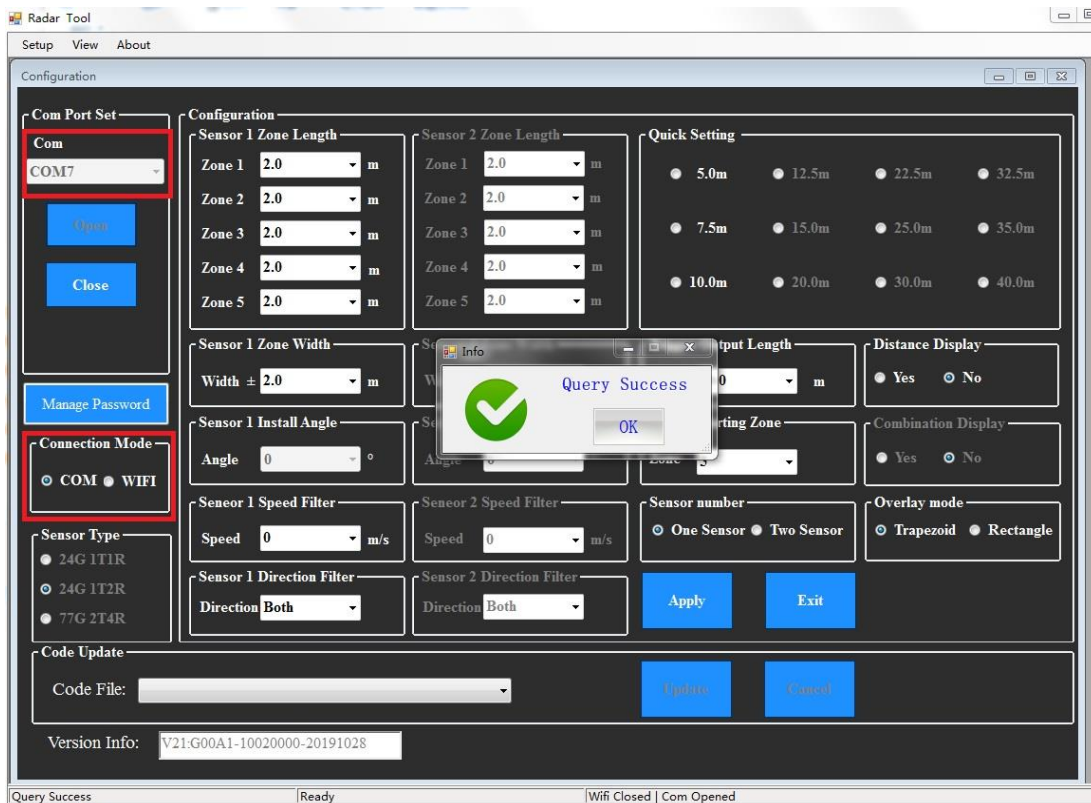



### 8.3.2.2 Connecting Via Wi-Fi (Optional Function)

Select Wi-Fi Mode. Click the Wi-Fi Port Set and search the Wi-Fi account as “MSRADAR###”. The “###” represents six bits of numbers. Each control box has its unique account. Select the account and input the password, then click “Open” and it will connect automatically. It spends one minute or less on connection and displays “Wi-Fi Connect ” when finish at the bottom status bar.

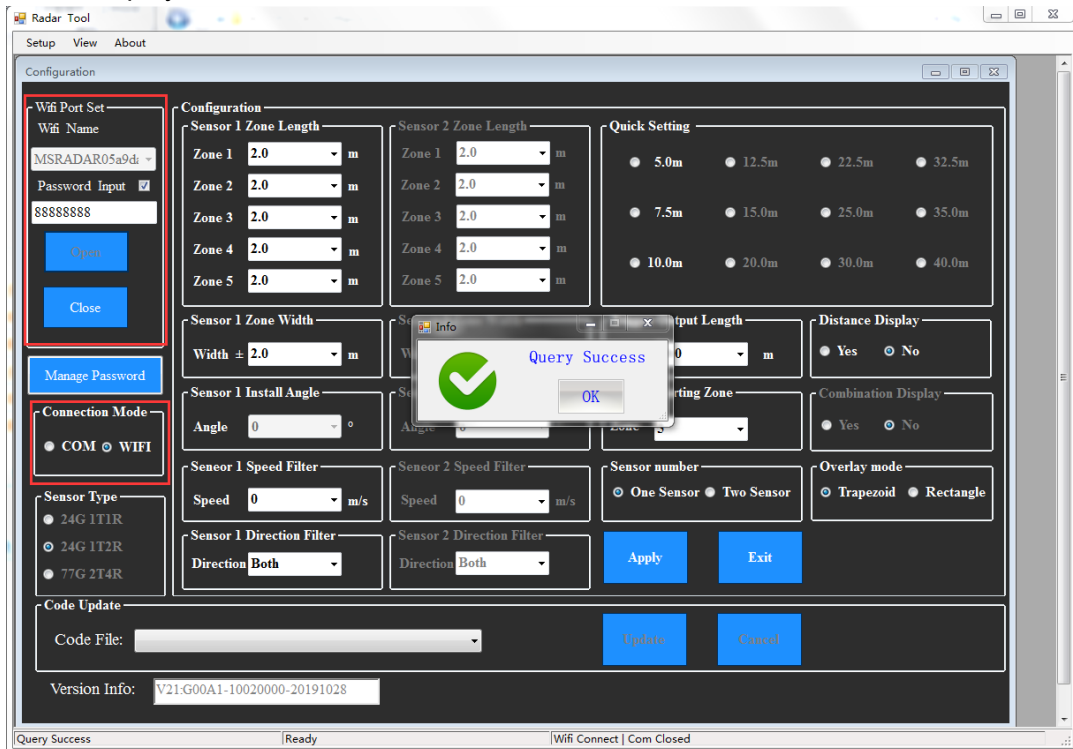

A popup window displays “Query Success” when you finish connecting.

The Wi-Fi default password is 88888888. “Manage Password” can change the password.

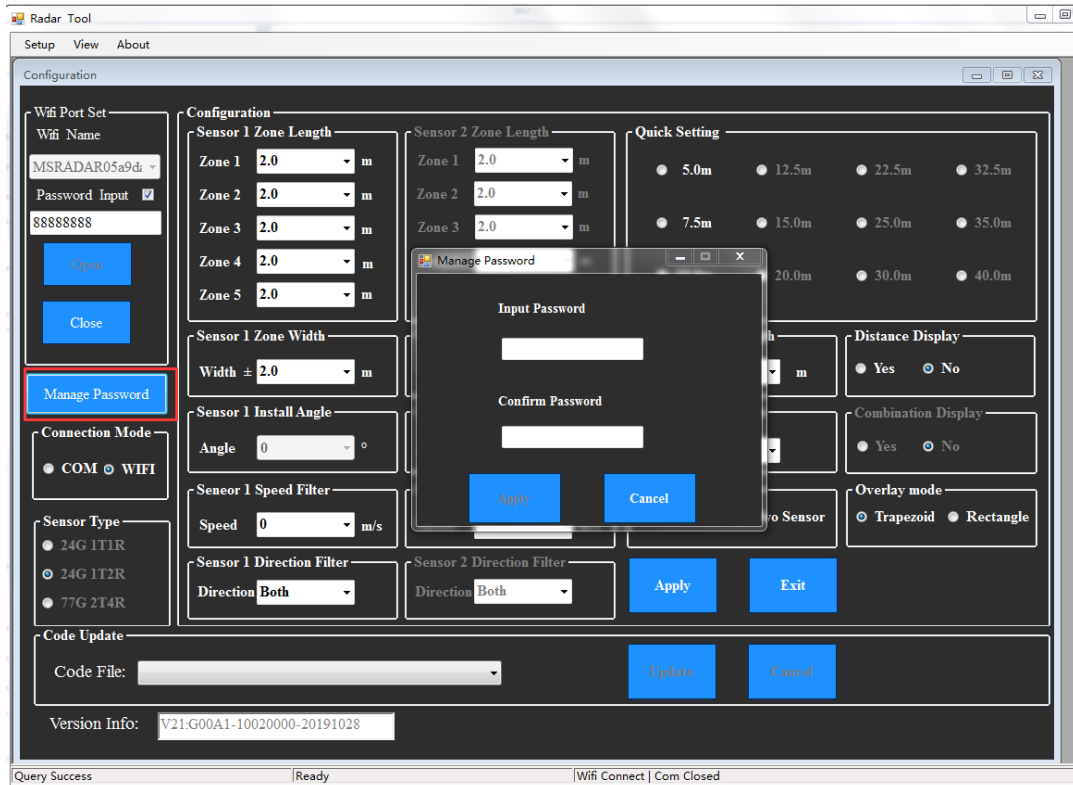

It can be queried in "Manage Password" of COM Port Set if you forget it. Click the button of "PW Query" and it will show.

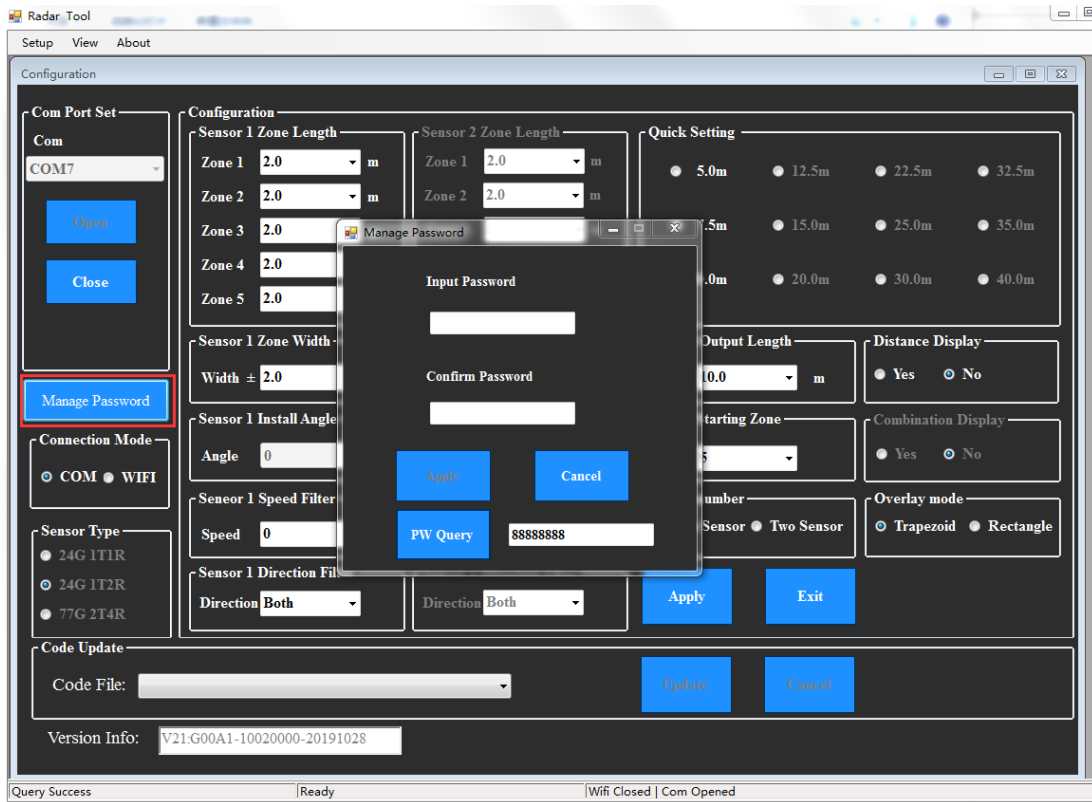

### 8.3.3 Reading Configuration from the Control Box

When click the “Open” button via COM or Wi-Fi, Configuration Tool will send a query instruction to Control Box and read configuration data from the Control Box. Once configuration has been read successfully, the latest configuration data is displayed in part B, the firmware version information is displayed in part C and connection status is displayed in part D.

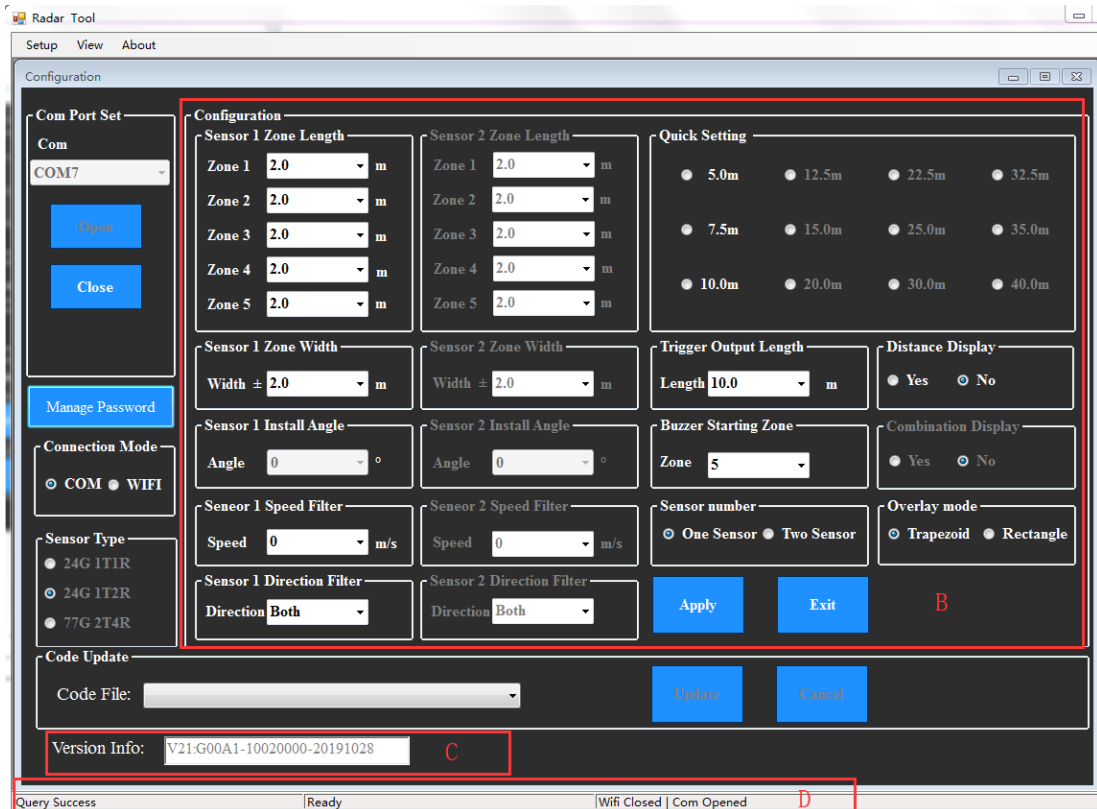

Warning

Please keep the connection between the Control Box and the PC while using Configuration Tool.

### 8.3.4 Setup Detection Area

The part B is a configuration group box. This is used to configure “Sensor Zone Length Configuration”, “Quick Setting”, “Sensor Zone Width”, “Combination Display”, “Trigger Output Length”, “Buzzer Starting Zone” and so on.

#### 8.3.4.1 Sensor Zone Length

The detection area length can be set in two ways;

- 1: setting each zone individually via the “Sensor 1 Detection Zone Length”. “Sensor 1 Detection Zone Length” can be set when you choose sensor number as two sensors.
- 2: setting each zone quickly via the “Quick Setting”.

#### 8.3.4.2 Sensor 1 Detection Zone Length Setup

This is used to set up each of the five zones individually. Make “L” represent the maximum detection length of sensor. Zone 1 has a range from 0.1m to L and others have a range from 0m to L selectable via

the pull down menus or data input. The combined total length will not exceed L. It is the same settings to Sensor 2 Zone Length.

Note: The Trigger Output Length and Buzzer Starting Zone will return none when the Sensor 1 Detection Zones Length is changed. Please set the Trigger Output Length and Buzzer Starting Zone manually as required.

#### 8.3.4.3 Quick Setting

There are 12 kinds “Quick Zones”, these are preset zones and can be selected by clicking the appropriate check box. Using this option will set the total length, max trigger output length and buzzer starting zone and create five equal zones.

#### 8.3.4.4 Sensor 1 Zone Width/ Sensor 2 Zone Width

Set the width of detection zone as the following picture. This configuration is not supported to Type 1 sensor. The value you set is the half side of detection zone. The total of width is the double of the value. You can set the range from  $\pm 0.1\text{m}$  to  $\pm 10\text{m}$  (0.2m to 20m) via the pull down menus or data input.

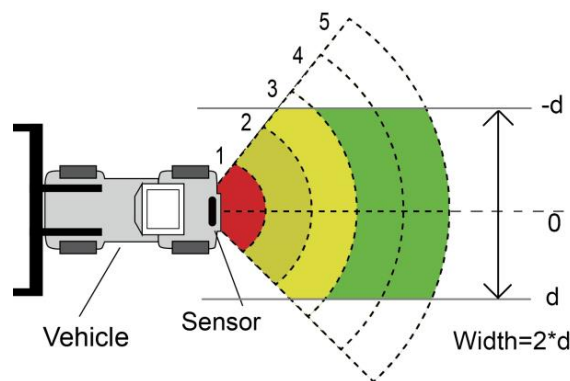

#### 8.3.4.5 Trigger Output Length

The Trigger Output Length is set at the point where you want the trigger output to start in the detection area. Select the appropriate Trigger Output Length from the drop down box or input the specific number. The range is from 1m to the sum of detection length Sensor 1 selected.

#### 8.3.4.6 Distance Display

It will display the detecting distance of the object on the monitor if select Yes and no distance information will be shown if select No.

#### 8.3.4.7 Sensor 1 Install Angle/ Sensor 2 Install Angle

It shows the horizontal angle you should mount the sensor. You can only read the angle and can't configure.

#### 8.3.4.8 Buzzer Starting Zone

Select the required buzzer starting zone from the drop down box. The range is from 1 to the max zone.

#### 8.3.4.9 Combination Display

It is active only if using two sensors. Two sensors will combined detect when you select Yes. In this mode, two sensors should be mounted at proper degrees horizontally. Two sensors detect independently and the monitor will show each of alarm zones if you select NO. This option is only available for 1T1R and 1T2R sensors.

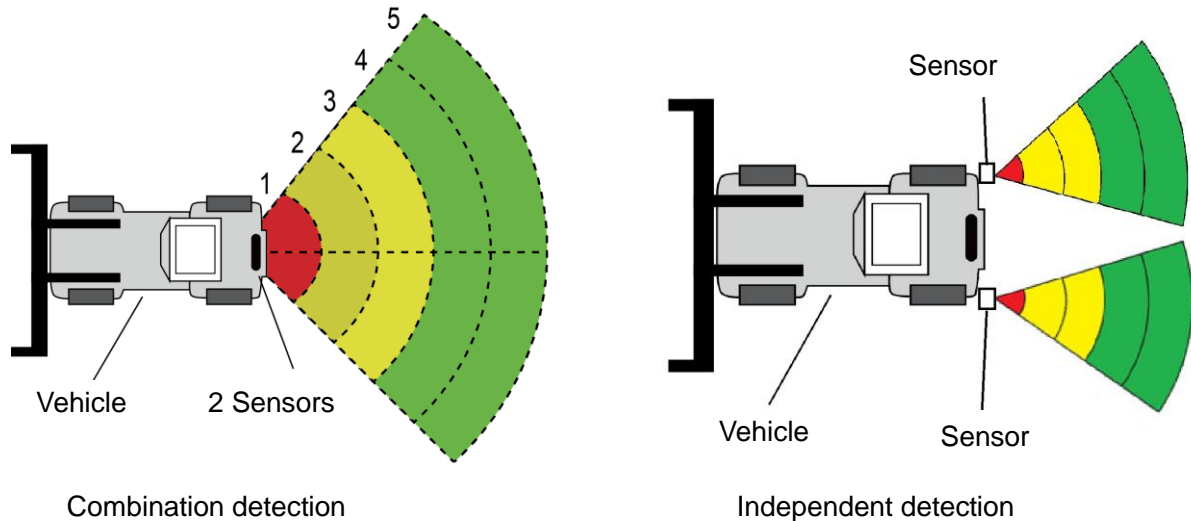

#### 8.3.4.10 Sensor 1 Speed Filter/ Sensor 2 Speed Filter

If the speed of objects is lower than the speed you set, there will be no alarm. Be available for special version.

#### 8.3.4.11 Sensor number

Two Sensors can be set when you use two sensors in one control box.

#### 8.3.4.12 Overlay mode

It changes the overlay display mode in the monitor.

#### 8.3.4.13 Sensor 1 Direction Filter/ Sensor 2 Direction Filter

Both: alarm when the object is far away or near.

Away: alarm only if the object is far away.

Near: alarm only if the object is near.

Be available for special version.

### 8.3.5 Download Configuration Data to the Control Box

Make sure the Configuration Tool is in connected state. Once all the required configurations are selected, all the settings can be programmed into the Control Box. The “view” interface will also display the status you set.

Click the “Apply” button and it will download the configuration data to the Control Box. Once configuration is downloaded, A popup window prompts “Config Success” and “Apply Success” will be displayed at the Part D.

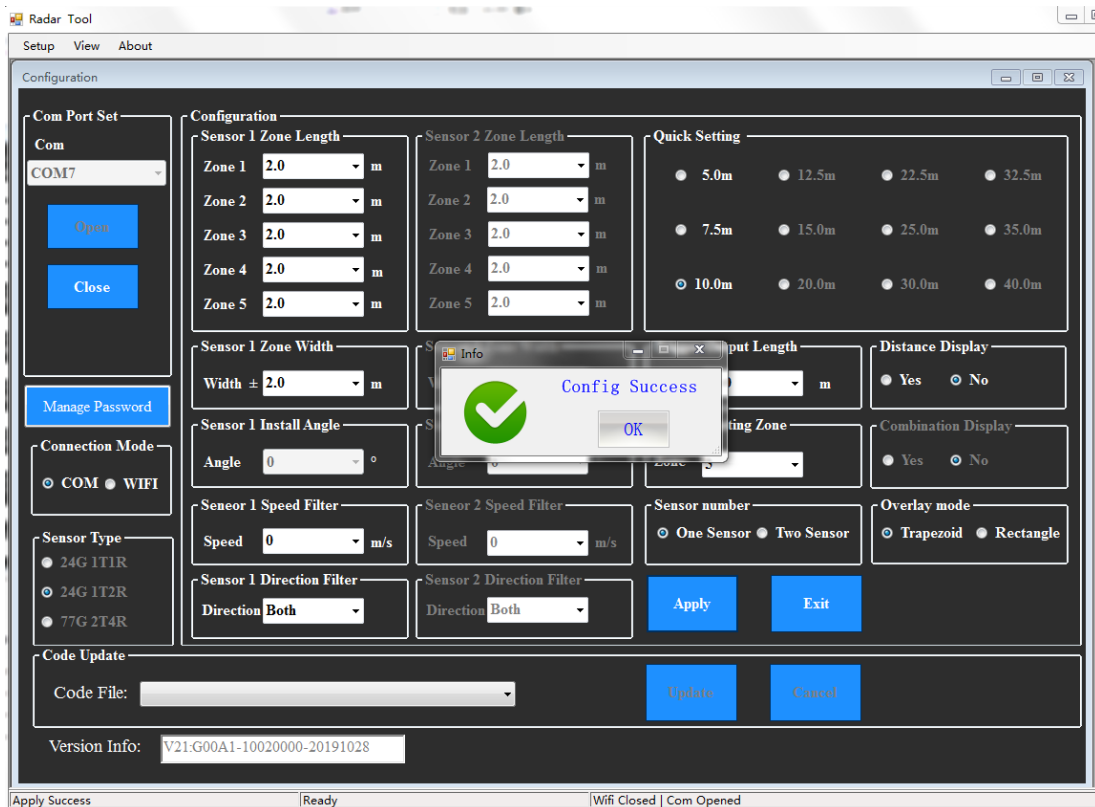

### Warning

If the Part D displays “Query Failed”, please check the connection between the PC and the Control Box or Wi-Fi connection.

## 8.3.6 System Update

Choose the Code File(.jic) to update the control box system via Wi-Fi or UART port. It spends about two minutes on updating. Don't cut off the power supply of the control box during the update or the control box will update fail and lead to abnormal operation.

## 9. Mobile Phone Configuration Tool

Only with optional Wi-Fi functionality in control box is supported.

### 9.1 System Requirements

The APP of the configuration tool can only be operated on Android operating system currently.

### 9.2 Using the Configuration Tool Software

## 9.2.1 User Interface Overview

The interface of Configuration Tools is shown below.

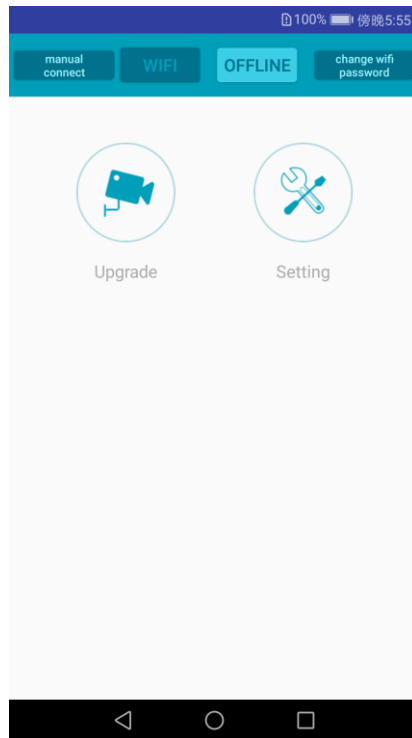

The top bar is Wi-Fi connection setting.

The “Upgrade” icon is the function of system upgrading.

The “setting” icon configures the detection area and alarm trigger.

### 9.2.2 Connecting to the Control Box

Click the Wi-Fi button, wait for scanning device, and you will find Wi-Fi account of the control box. The Wi-Fi name begins with MSRADAR. The Wi-Fi button color will change from deep to pale if successful connection. It will connect automatically if default password is not changed. GPS need to be opened at the same time if Android system is 6.0 or earlier version.

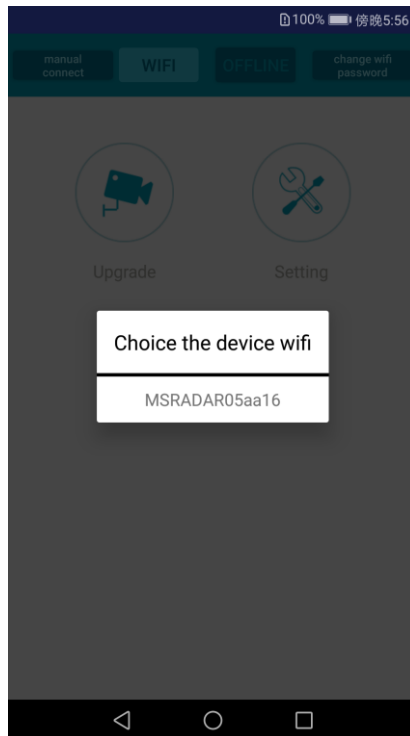

Some Android systems like version 4.0 may not be able to connect automatically and need to be connected manually. If Wi-Fi connects fail, you can click “manual connect” option and click “jump” to connect. Search the Wi-Fi account as “MSRADAR##” and enter default password:88888888.

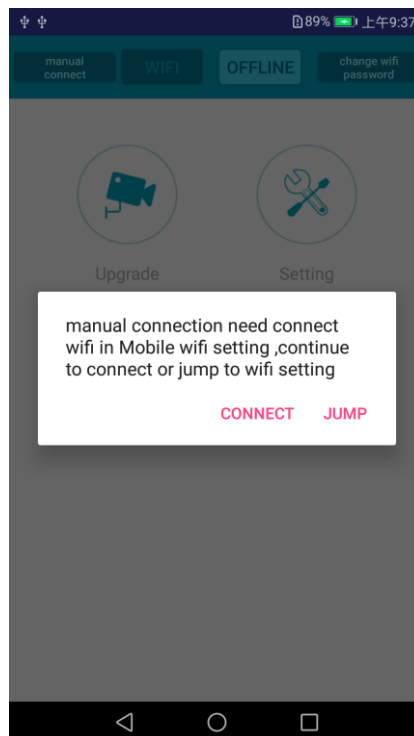



Click the option “change WIFI password” and you can set your password.

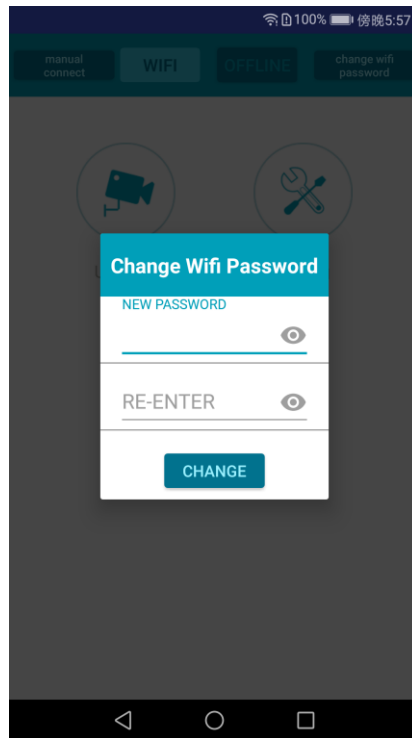

## 9.2.3 Reading Configuration from the Control Box and setup Detection Area

### 9.2.3.1 Reading Configuration

After connecting the control box, click the setting button and the current configuration will be displayed below. System version is displayed at top bar.

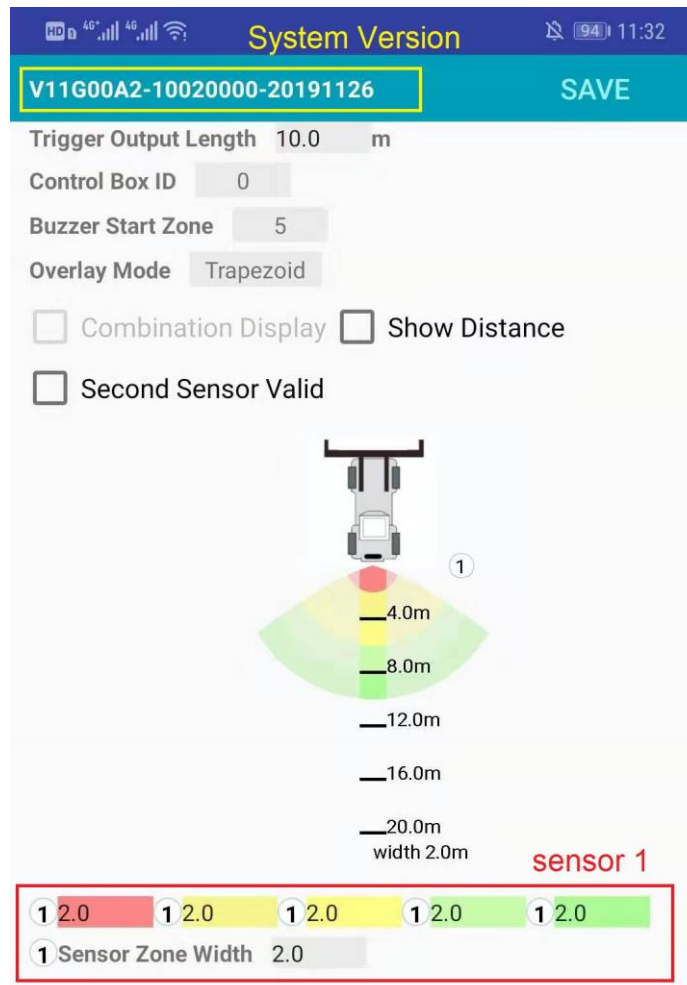

### 9.2.3.2 Trigger Output Length

The Trigger Output Length is set at the point where you want the trigger output to start in the detection area. Select the appropriate Trigger Output Length from the drop down box or input the specific number. The range is from 1m to the sum of detection length Sensor 1 selected.

### 9.2.3.3 Control Box ID

Set the control box ID when using CAN bus.

### 9.2.3.4 Buzzer Starting Zone

Select the required buzzer starting zone from the drop down box. The range is from 1 to the max zone.

### 9.2.3.5 Overlay Mode

It changes the overlay display mode in the monitor.

### 9.2.3.6 Combination Display

It is active only if using two sensors. Two sensors will combined detect when you select the option. In this mode, two sensors should be mounted at proper degrees horizontally. Two sensors detect independently and the monitor will show each of alarm zones if you unselect. This option is only available for 1T1R and 1T2R sensors.

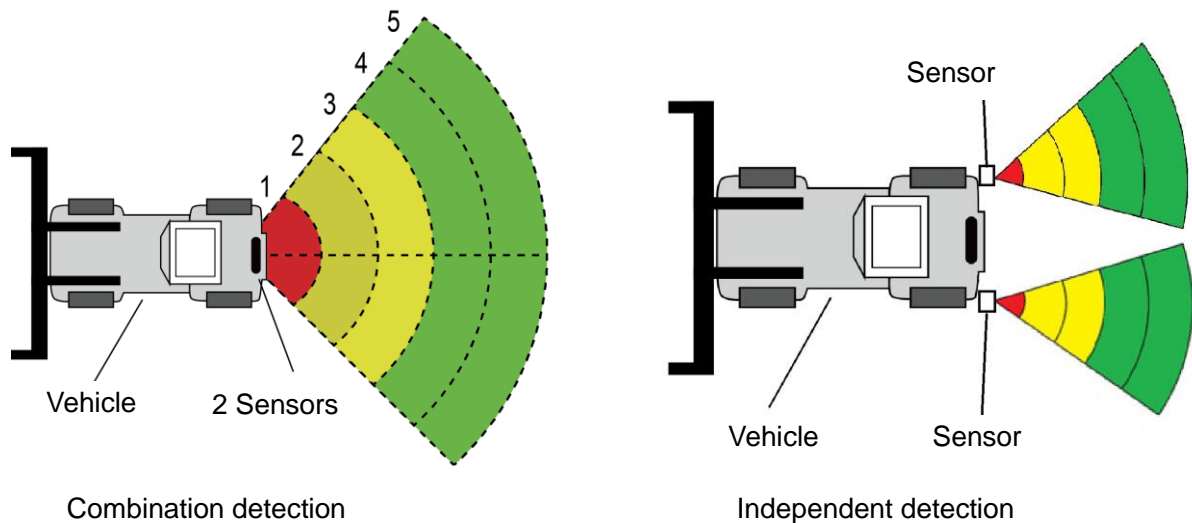

### 9.2.3.7 Show Distance

On the monitor it will show distance value that the sensor has detected if you select the option of "Show distance". If using two sensors, each value will also be displayed when unselecting "Combination display". Only one closest value will be display if selecting "Combination Display".

### 9.2.3.8 Second Sensor Valid

The option will be selected when using two sensors and two detecting zones can be set. Ignore this option when using one sensor.

### 9.2.3.9 Detecting Zones Setting

Detecting zones and its width settings are shown below the car model. Each number represents the distance of each zone .The closest zone is red, the second and the third zones are yellow and the farthest two zones are green. It will display one line of number if unselecting "Second Sensor Valid". Three detecting zones can be set when the farthest two zones are set 0. This is used to set up each of the five zones individually. Zone 1 has a range from 0.1m to 20.0m and others have a range from 0m to 20.0m selectable via data input. The combined total length will not exceed 20m. It is the same settings to Sensor 2 Zone Length.

### 9.2.3.10 Sensor Zone Width

Set the width of detection zone as the following picture. This configuration is not supported to Type 1 sensor. The value you set is the half side of detection zone. The total of width is the double of the value. You can set the range from  $\pm 0.1\text{m}$  to  $\pm 10\text{m}$  (0.2m to 20m) via data input.

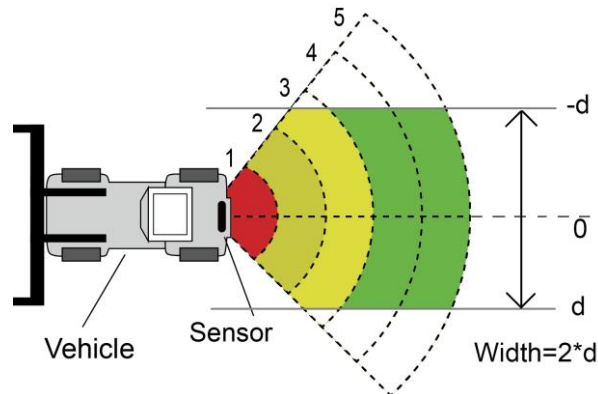

### 9.2.4 Download Configuration Data to the Control Box

Make sure the APP is in connected state. Once all the required configurations are selected, all the settings can be programmed into the Control Box. Click the “SAVE” button and it will download the configuration data to the Control Box. Once configuration is downloaded, “Set success” will be displayed.

### 9.2.5 System Update

Place the (.jic) suffix installation file in the path: radar/update/ xxx.jic. If you do not have this directory, you need to create new folders “Radar” and “update” under home directory. Back to the APP home page, click the Upgrade button. Choose the Code File(.jic) to update the control box system. It has progress bar and the percentage prompt on updating. Don't cut off the power supply during the update or the control box will update fail and lead to abnormal operation. A successful prompt will be shown after update has finished.

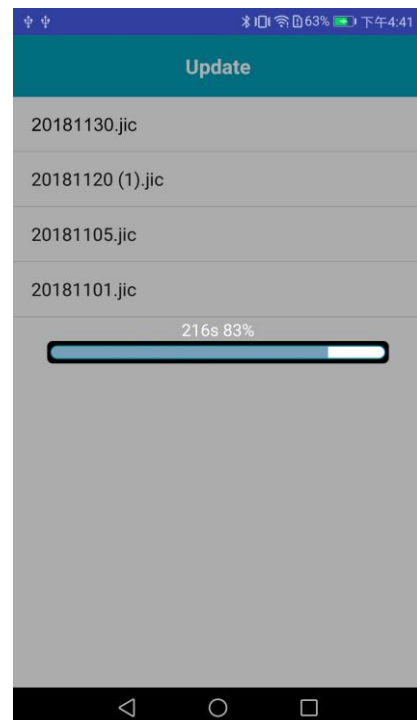
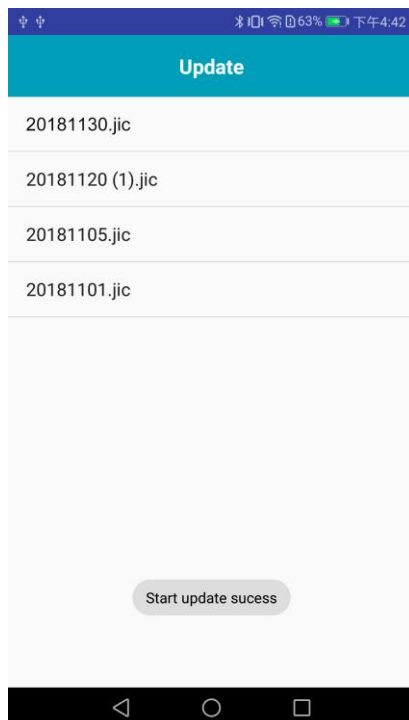

## 10. Testing and Maintenance

A walk-around test shall be performed every day to verify proper function of the system and to familiarize the operator with the zone of detection. More frequent inspections should be performed when:

- The vehicle is operating in a particularly dirty or harsh environment.
- The operator has reason to suspect the system has been damaged.

This test should be performed with two people, one who remains in the cab (the operator), and one who walks through the sensor detection field (the assistant).

- 1) Clean the sensor face of any accumulation of dirt, mud, snow, ice, or debris.
- 2) Visually inspect the attached wiring and cable and verify that they are properly secured and not damaged. Inspect the Radar Sensor and control box and verify that they are securely attached to the vehicle.
- 3) Set the park brakes, start the vehicle, depress and hold the vehicle brake, and place the vehicle in reverse.
- 4) The area to the rear of the vehicle should be clear of obstacles for a distance greater than the sensor range. If the monitor shows any overlay or buzzer sounds, then there are objects to the rear of the vehicle that will interfere with the test. Move the vehicle to a clear area and proceed.
- 5) The assistant should move to just behind the rear corner of the vehicle in sight of the operator's mirrors. He should then walk toward the center line of the vehicle parallel to the rear, while the operator notes when the monitor shows an overlay and buzzer sounds, signifying the sensor has detected the object.
- 6) The assistant should continue walking through the area at the rear of the vehicle while the operator notes the area where detection occurs.
- 7) Next, walk from the center of the rear of the vehicle straight back, away from the vehicle. When the buzzer quits sounding or overlay disappears, the detection limit has been reached.
- 8) The assistant should walk the complete rear of the vehicle while the operator notes the detection edges of the entire coverage area.
- 9) After the test, the operator and the assistant need to communicate the details on the detection zone.

## 11. Troubleshooting

The symptoms described below do not necessarily mean a failure within the system. Please check the following items before you initiate request for repair.

Symptoms	Causes	Solutions
No reaction from the system while the gear is switched to reverse.	No power input or no trigger input.	Check whether the power and activation input cable is in well connection. According to section 6.2.
No reaction on display while there are obstacles within the detecting area.	Improper connection of the sensor or monitor etc.	Check whether it is loose in connection.
No audible alert while there are obstacles within the detecting area.	The monitor sound volume is turned off or set too low.	Turn on or turn up monitor sound volume.
Monitor shows "No Sensor Detected".	Improper connection of the sensor.	Check whether it is loose in connection.
There is no obstacle within the detecting area, but constant warning occurs.	The ground is detected.	Adjust the angle of sensor.
Can not configure with USB TO UART cable.	The control Box isn't powered or the trigger input line is on high level.	Make sure the box is powered and the trigger input is on low level (or no connect).
Can not search Wi-Fi device on PC Configuration Tool.	Wi-Fi signal is weak or Wi-Fi is not working well on the computer.	Let the computer get close to the radar control box and reconnect Wi-Fi.
Can not search Wi-Fi device on mobile phone Configuration Tool.	Wi-Fi signal is weak or your phone haven't turn on the Wi-Fi settings.	Confirm that the phone turn on the Wi-Fi settings and reconnect Wi-Fi on the configuration tool.
Wi-Fi always disconnects automatically.	Wi-Fi may suffer from interference like engine room.	Keep Wi-Fi away from high frequency interference sources and restart the control box.

## Federal Communications Commission (FCC) Interference Statement

This equipment has been tested and found to comply with the limits for a Class B digital device, pursuant to Part 15 of the FCC Rules.

These limits are designed to provide reasonable protection against harmful interference in a residential installation. This equipment generate, uses and can radiate radio frequency energy and, if not installed and used in accordance with the instructions, may cause harmful interference to radio communications.

However, there is no guarantee that interference will not occur in a particular installation. If this equipment does cause harmful interference to radio or television reception, which can be determined by turning the equipment off and on, the user is encouraged to try to correct the interference by one of the following measures:

- Reorient or relocate the receiving antenna.
- Increase the separation between the equipment and receiver.
- Connect the equipment into an outlet on a circuit different from that to which the receiver is connected.
- Consult the dealer or an experienced radio/TV technician for help.

This device complies with Part 15 of the FCC Rules. Operation is subject to the following two conditions:

(1) This device may not cause harmful interference, and (2) this device must accept any interference received, including interference that may cause undesired operation.

FCC Caution: Any changes or modifications not expressly approved by the party responsible for compliance could void the user's authority to operate this equipment.

### **RF exposure warning**

This equipment complies with FCC radiation exposure limits set forth for an uncontrolled environment.

This equipment must be installed and operated in accordance with provided instructions and the antenna(s) used for this transmitter must be installed to provide a separation distance of at least 20 cm from all persons and must not be collocated or operating in conjunction with any other antenna or transmitter.