

**TEST REPORT**

<b>Applicant:</b>	STONKAM CO., LTD
<b>Address of Applicant:</b>	1/F, #6 Building, Huangzhou Industrial Park, Chebei Rd., Tianhe Dist., 510665 Guangzhou, China
<b>Manufacturer:</b>	STONKAM CO., LTD
<b>Address of Manufacturer:</b>	1/F, #6 Building, Huangzhou Industrial Park, Chebei Rd., Tianhe Dist., 510665 Guangzhou, China
<b>Product name:</b>	1080P 2.4GHz Digital Wireless Camera
<b>Model:</b>	HDW135871CAI
<b>Rating(s):</b>	DC 24V
<b>Trademark:</b>	STONKAM
<b>Standards:</b>	47 CFR PART 15 Subpart C section 15.247
<b>FCC ID:</b>	2ATW7-HDW871
<b>Data of Receipt:</b>	2021-12-02
<b>Date of Test:</b>	2021-12-02~2021-12-28
<b>Date of Issue:</b>	2021-12-28
<b>Test Result</b>	<b>Pass*</b>

\* In the configuration tested, the test item complied with the standards specified above.

**Authorized for issue by:****Test by:****Reviewed by:**

Dec. 28, 2021 Chivas Tsang

Dec. 28, 2021

Project Engineer

Victor Meng

Project Manager

Date

Name/Position

Signature

Date

Name/Position

Signature

**Possible test case verdicts:**

test case does not apply to the test object.. : N/A

test object does meet the requirement..... : P (Pass)

test object does not meet the requirement.. : F (Fail)

**Testing Laboratory information:**

Testing Laboratory Name ..... : ITL Co., Ltd

Address..... : No. 8 Jinqianling Street 5, Huangjiang Town, Dongguan,  
Guangdong, 523757 P.R.C.

Testing location : Same as above

Tel : 0086-769-39001678

Fax : 0086-20-62824387

E-mail : itl@i-testlab.com

**General remarks:**

**The test results presented in this report relate only to the object tested.**

**The results contained in this report reflect the results for this particular model and serial number. It is the responsibility of the manufacturer to ensure that all production models meet the intent of the requirements detailed within this report.**

**This report would be invalid test report without all the signatures of testing technician and approver.**

**This report shall not be reproduced, except in full, without the written approval of the Issuing testing laboratory.**

**General product information:**

/

## 1 Test Summary

Test	Test Requirement	Test method	Result
Antenna Requirement	FCC PART 15 C section 15.247 (c) and Section 15.203	FCC PART 15 C section 15.247 (c) and Section 15.203	PASS
Occupied Bandwidth (-20dB)	FCC PART 15 C section 15.247 (a)(1);	ANSI C63.10:2013	PASS
Carrier Frequencies Separated	FCC PART 15 C section 15.247(a)(1);	ANSI C63.10:2013	PASS
Hopping Channel Number	FCC PART 15 C section 15.247(a)(1)(iii)	ANSI C63.10:2013	PASS
Dwell Time	FCC PART 15 C section 15.247(a)(1)(iii);	ANSI C63.10:2013	PASS
Maximum Peak Output Power	FCC PART 15 C section 15.247(b)(1);	ANSI C63.10:2013	PASS
Conducted Spurious Emission (30 MHz to 25 GHz)	FCC PART 15 C section 15.247(d);	ANSI C63.10:2013	PASS
Radiated Spurious Emission (9 kHz to 25 GHz)	FCC PART 15 C section 15.247(d);	ANSI C63.10:2013	PASS
Band Edges Measurement	FCC PART 15 C section 15.247 (d) &15.205	ANSI C63.10:2013	PASS
Conducted Emissions at Mains Terminals	FCC PART 15 C section 15.207;	ANSI C63.10:2013	N/A
Radiated Emissions which fall in the restricted bands	FCC PART 15 C section 15.209	ANSI C63.10:2013	PASS
Pseudorandom Frequency Hopping Sequence	47 CFR Part 15, Subpart C Section 15.247(b)(4)&TCB Exclusion List	ANSI C63.10:2013	PASS

### Remark:

N/A: not applicable. Refer to the relative section for the details.  
EUT: In this whole report EUT means Equipment Under Test.  
Tx: In this whole report Tx (or tx) means Transmitter.  
Rx: In this whole report Rx (or rx) means Receiver.  
RF: In this whole report RF means Radio Frequency.  
ANSI C63.10:2013 the detail version is ANSI C63.10:2013 in the whole report.

## 2 Contents

	Page
<b>TEST REPORT</b> .....	<b>1</b>
<b>1 TEST SUMMARY</b> .....	<b>3</b>
<b>2 CONTENTS</b> .....	<b>4</b>
<b>3 GENERAL INFORMATION</b> .....	<b>5</b>
3.1 CLIENT INFORMATION .....	5
3.2 GENERAL DESCRIPTION OF E.U.T. ....	5
3.3 DETAILS OF E.U.T. ....	5
3.4 DESCRIPTION OF SUPPORT UNITS .....	5
3.5 TEST LOCATION .....	6
3.6 DEVIATION FROM STANDARDS .....	6
3.7 ABNORMALITIES FROM STANDARD CONDITIONS .....	6
3.8 OTHER INFORMATION REQUESTED BY THE CUSTOMER .....	6
3.9 TEST FACILITY .....	6
3.10 MEASUREMENT UNCERTAINTY .....	6
<b>4 INSTRUMENTS USED DURING TEST</b> .....	<b>7</b>
<b>5 TEST RESULTS</b> .....	<b>8</b>
5.1 E.U.T. TEST CONDITIONS .....	8
5.2 ANTENNA REQUIREMENT .....	9
5.3 OCCUPIED BANDWIDTH .....	10
5.4 CARRIER FREQUENCIES SEPARATED .....	13
5.5 HOPPING CHANNEL NUMBER .....	16
5.6 DWELL TIME .....	18
5.7 MAXIMUM PEAK OUTPUT POWER .....	23
5.8 CONDUCTED SPURIOUS EMISSIONS .....	26
5.9 RADIATED SPURIOUS EMISSIONS .....	29
5.9.1 <i>Harmonic and other spurious emissions</i> .....	32
5.10 RADIATED EMISSIONS WHICH FALL IN THE RESTRICTED BANDS .....	40
5.11 BAND EDGES REQUIREMENT .....	42
5.12 CONDUCTED EMISSIONS AT MAINS TERMINALS 150 KHZ TO 30 MHZ .....	44
5.12.1 <i>Measurement Data</i> .....	46
5.13 OTHER REQUIREMENTS FREQUENCY HOPPING SPREAD SPECTRUM SYSTEM .....	48

### 3 General Information

#### 3.1 Client Information

Applicant: STONKAM CO., LTD  
 Address of Applicant: 1/F, #6 Building, Huangzhou Industrial Park, Chebei Rd., Tianhe Dist., 510665 Guangzhou, China

#### 3.2 General Description of E.U.T.

Name: 1080P 2.4GHz Digital Wireless Camera  
 Model No.: HDW135871CAI  
 Operating Frequency: 2408 MHz to 2478 MHz  
 19 channels

channel	Frequency	channel	Frequency	channel	Frequency	channel	Frequency
1	2408	6	2425	11	2448	16	2468
2	2411	7	2428	12	2452	17	2472
3	2415	8	2432	13	2455	18	2475
4	2418	9	2442	14	2458	19	2478
5	2422	10	2445	15	2465		

Modulation Technique: Frequency Hopping Spread Spectrum (FHSS)

Type of Modulation: 16QAM/QPSK/BPSK  
 Dwell time: Per channel is less than 0.4s.  
 Antenna Type: External antenna  
 Antenna gain: 3 dBi  
 Function: 2.4G Digital Wireless camera

#### 3.3 Details of E.U.T.

EUT Power Supply: DC 24V  
 Test mode: The program used to control the EUT for staying in continuous transmitting and receiving mode is programmed. Channel lowest (2408MHz), middle (2445MHz) and highest (2478MHz) are chosen for full testing.

Power cord: /

#### 3.4 Description of Support Units

The EUT has been tested as an independent unit for fixed frequency by testing lab.

Details of Support Equipment(s)

Description	Manufacturer	Model No.	Connection	Working state
/	/	/	/	/

### 3.5 Test Location

All tests were performed at:

ITL Co., Ltd

No. 8 Jinqianling Street 5, Huangjiang Town, Dongguan, Guangdong, 523757 P.R.C.

0086-769-39001678

itl@i-testlab.com

No tests were sub-contracted.

### 3.6 Deviation from Standards

None.

### 3.7 Abnormalities from Standard Conditions

None.

### 3.8 Other Information Requested by the Customer

None.

### 3.9 Test Facility

The test facility is recognized, certified, or accredited by the following organizations:

- **CNAS Lab code:L9342**
- **FCC Designation No.:CN5035**
- **IC Registration NO.: 12593A**
- **NVLAP LAB CODE: 600199-0**

### 3.10 Measurement Uncertainty

The below measurement uncertainties given below are based on a 95% confidence level (base on a coverage factor (k=2).)

Parameter	Uncertainty
Radio frequency	2.25%
total RF power, conducted	±1.34 dB
RF power density , conducted	±1.49 dB
All emissions, radiated	±2.72 dB
Temperature	±5.02 dB
Humidity	±0.8°C
DC and low frequency voltages	±1.5 %

#### 4 Instruments Used during Test

No.	Test Equipment	Manufacturer	Model	Serial No.	Last Cal.	Cal. Due
ITL-114	Spectrum Analyzer	Agilent	N9010A	MY51250936	2021/01/20	2022/01/19
ITL-154	EMI test receiver 9kHz to 26.5GHz	R&S	ESR26	101257	2021/01/20	2022/01/19
ITL-116	Pre Amplifier	HP	8447F	3113A05905	2021/01/20	2022/01/19
ITL-117	Wideband Amplifier Super Ultra	Mini-circuits	ZVA-183- S+	469101134	2021/01/20	2022/01/19
ITL-180	Trilog-Broadband Antenna	Schwarzbeck	VULB 9164	005	2021/1/31	2023/01/30
ITL-110	Horn Antenna	A-INFOMW	JXTXLB- 10180-N	J2031090612 133	2020/06/19	2022/06/18
ITL-103	Two-line v- network	R&S	ENV216	100120	2021/08/10	2022/08/09
ITL-115	50Ω Coaxial Cable	Mini-circuits	CBL	C001	2020/06/19	2022/06/18
ITL-100	Semi-Anechoic chamber	ETS•Lindgren	FACT3 2.0	CT09015	2019/10/16	2022/10/15
ITL-163	Active Loop Antenna	Schwarzbeck	FMZB 1519B	1519B-062	□020/06/19	2022/06/18
ITL-101	Shielded Room	ETS•Lindgren	8*4*3	CT09010	2021/01/22	2022/01/21
ITL-166	Power Sensor	Agilent	U2021XA	MY5365004	2021/01/20	2022/01/19

## 5 Test Results

### 5.1 E.U.T. test conditions

<b>Test Voltage:</b>	Input: DC 24V
<b>Temperature:</b>	20.0 -25.0 °C
<b>Humidity:</b>	38-50 % RH
<b>Atmospheric Pressure:</b>	1000 -1010 mbar

**Test frequencies and frequency range:** According to the 15.31(m) Measurements on intentional radiators or receivers, other than TV broadcast receivers, shall be performed and, if required, reported for each band in which the device can be operated with the device operating at the number of frequencies in each band specified in the following table:

According to the 15.33 (a) For an intentional radiator, the spectrum shall be investigated from the lowest radio frequency signal generated in the device, without going below 9 kHz, up to at least the frequency shown in the following table:

#### Number of fundamental frequencies to be tested in EUT transmit band

Frequency range in which	Number of frequencies	Location in frequency range of operation
1 MHz or less	1	Middle
1 MHz to 10 MHz	2	1 near top and 1 near bottom
More than 10 MHz	3	1 near top, 1 near middle and 1 near bottom

#### Frequency range of radiated emission measurements

Lowest frequency generated	Upper frequency range of measurement
9 kHz to below 10 GHz	10th harmonic of highest fundamental frequency or to 40 GHz,
At or above 10 GHz to below	5th harmonic of highest fundamental frequency or to 100 GHz,
At or above 30 GHz	5th harmonic of highest fundamental frequency or to 200 GHz,



## EUT channels and frequencies list:

channel	Frequency	channel	Frequency	channel	Frequency	channel	Frequency
1	2408	6	2425	11	2448	16	2468
2	2411	7	2428	12	2452	17	2472
3	2415	8	2432	13	2455	18	2475
4	2418	9	2442	14	2458	19	2478
5	2422	10	2445	15	2465		

Test frequencies are the lowest channel: 1 channel (2408 MHz), middle channel: 10 channel (2445 MHz) and highest channel: 19 channel (2478 MHz)

## 5.2 Antenna requirement

### Standard requirement

15.203 requirement:

For intentional device. According to 15.203. an intentional radiator shall be designed to Ensure that no antenna other than that furnished by the responsible party shall be used with the device.

15.247(c) (1)(i) requirement:

(i) Systems operating in the 2400-2483.5 MHz bands that are used exclusively for fixed. Point-to-point operations may employ transmitting antennas with directional gain greater than 6 dBi provided the maximum conducted output power of the intentional radiator is reduced by 1 dB for every 3 dB that the directional gain of the antenna exceeds 6 dBi.

### EUT Antenna

The antenna is an external Antenna that uses a unique coupling. The best case gain of the antenna is 3dBi.

**Test result: The unit does meet the FCC requirements.**

### 5.3 Occupied Bandwidth

**Test Requirement:** FCC Part 15 C section 15.247

(a)(1) Frequency hopping systems shall have hopping channel carrier frequencies separated by a minimum of 25 kHz or the 20 dB bandwidth of the hopping channel, whichever is greater. Alternatively, frequency hopping systems operating in the 2400-2483.5 MHz band may have hopping channel carrier frequencies that are separated by 25 kHz or two-thirds of the 20 dB bandwidth of the hopping channel, whichever is greater, provided the systems operate with an output power no greater than 125 mW.

**Test Method:** ANSI C63.10:2013

**Test Status:** Test the EUT in continuous transmitting mode at the lowest, middle and highest channel.

**Test Configuration:**

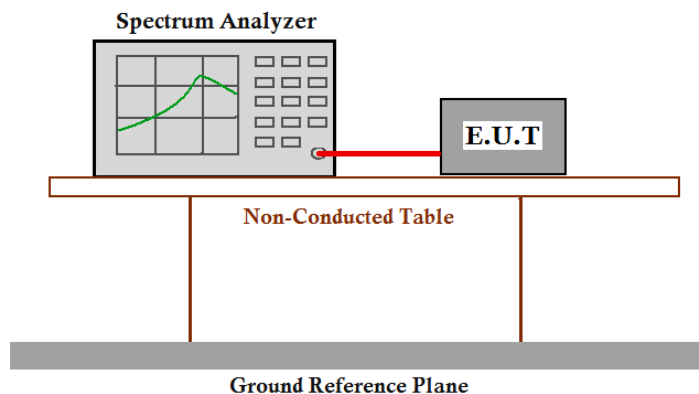

**Test Procedure:**

1. Remove the antenna from the EUT and then connect a low RF cable from the antenna port to the spectrum;
2. Set the spectrum analyzer: Span = approximately 2 to 3 times the 20dB bandwidth, centring on a hopping channel;
3. Set the spectrum analyzer: RBW  $\geq$  1% of the 20dB bandwidth VBW  $\geq$  RBW. Sweep = auto; Detector Function = Peak. Trace = Max Hold.
4. Mark the peak frequency and -20dB points bandwidth.

Test result (-20dB bandwidth):

Test Channel	Bandwidth(MHz)	2/3 bandwidth(MHz)
Lowest	4.411	2.941
Middle	4.407	2.938
Highest	4.382	2.921

Result plot as follows:

Lowest Channel:

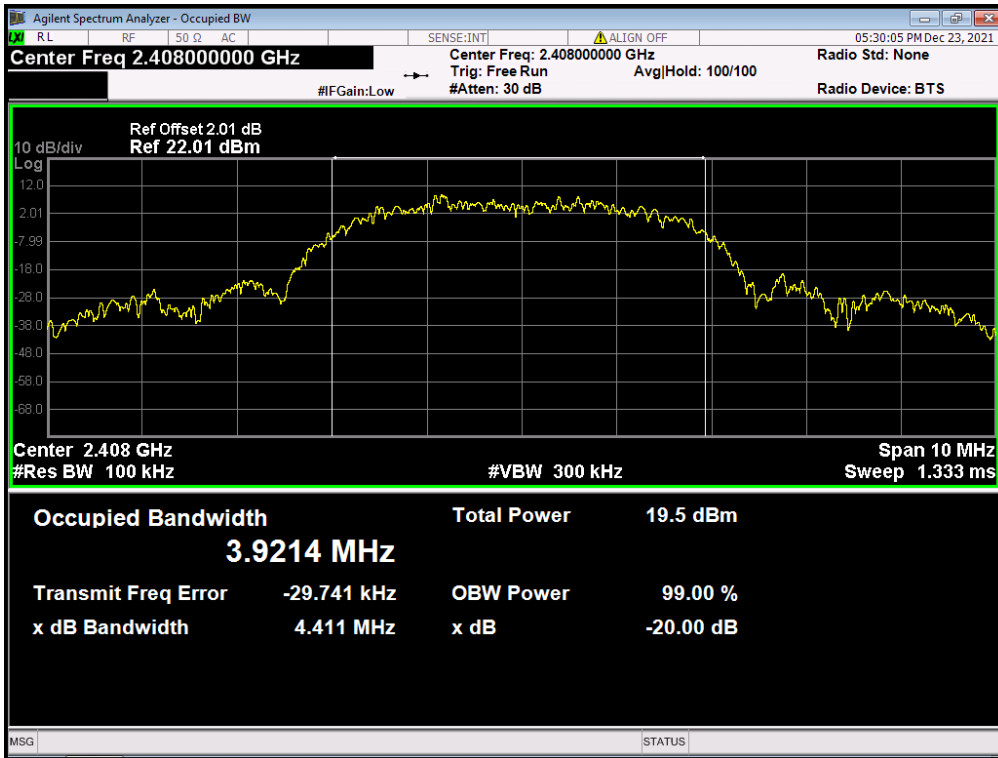

Middle Channel:



Highest Channel:

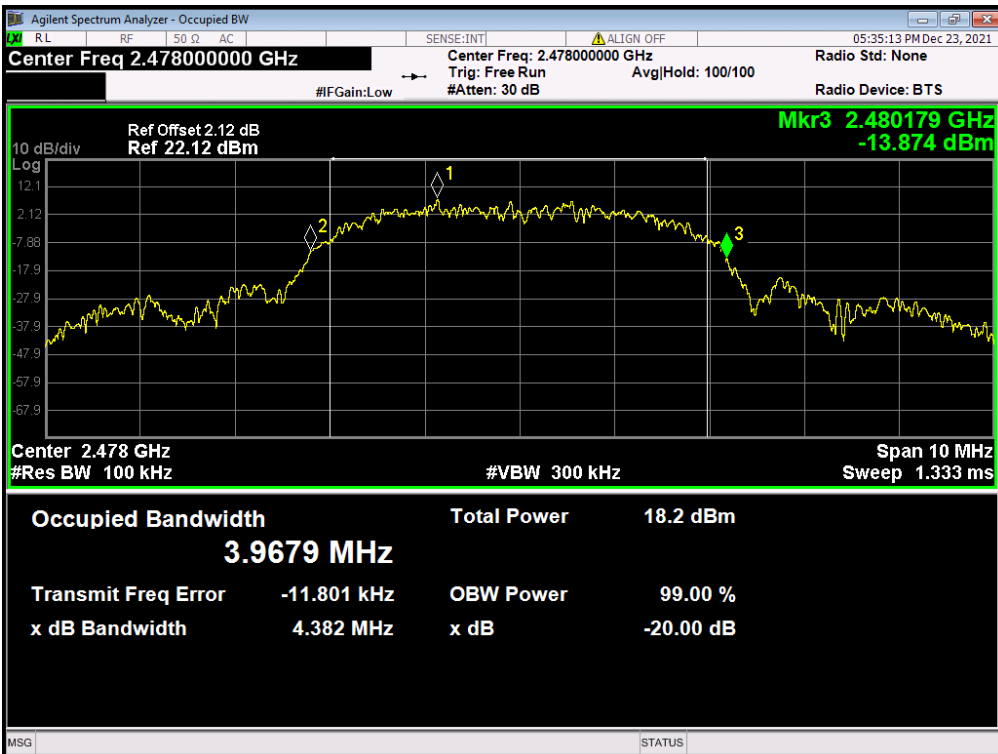

## 5.4 Carrier Frequencies Separated

**Test Requirement:** FCC Part 15 C section 15.247

(a),(1) Frequency hopping systems shall have hopping channel carrier frequencies separated by a minimum of 25 kHz or the 20 dB bandwidth of the hopping channel, whichever is greater. Alternatively, frequency hopping systems operating in the 2400-2483.5 MHz band may have hopping channel carrier frequencies that are separated by 25 kHz or two-thirds of the 20 dB bandwidth of the hopping channel, whichever is greater, provided the systems operate with an output power no greater than 125 mW.

**Test Method:** ANSI C63.10:2013

**Test Status:** Test the EUT in continuous transmitting mode at the lowest, middle and highest channel

**Test Configuration:**

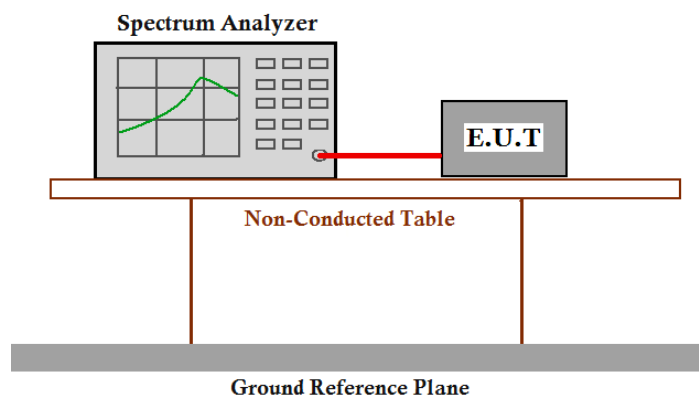

**Test Procedure:**

1. Remove the antenna from the EUT and then connect a low attenuation RF cable from the antenna port to the spectrum.
2. Set the spectrum analyzer: RBW  $\geq$  1% of the span, VBW  $\geq$  RBW, Sweep = auto; Detector  
Function = Peak. Trace = Max, hold.
3. Allow the trace to stabilize. Use the marker-delta function to determine the separation between the peaks of the adjacent channels. The limit is specified in one of the subparagraphs of this Section. Submit this plot.

Test result:

Test Channel	Carrier Frequencies Separated	Pass/Fail
Lower Channels	3.08MHz	Pass
Middle Channels	3.04MHz	Pass
Upper Channels	3.00MHz	Pass
Remark: The limit is maximum two-thirds of the 20 dB bandwidth: 2.941 MHz		

Carrier Frequencies Separated plot:

1. Lowest Channels:

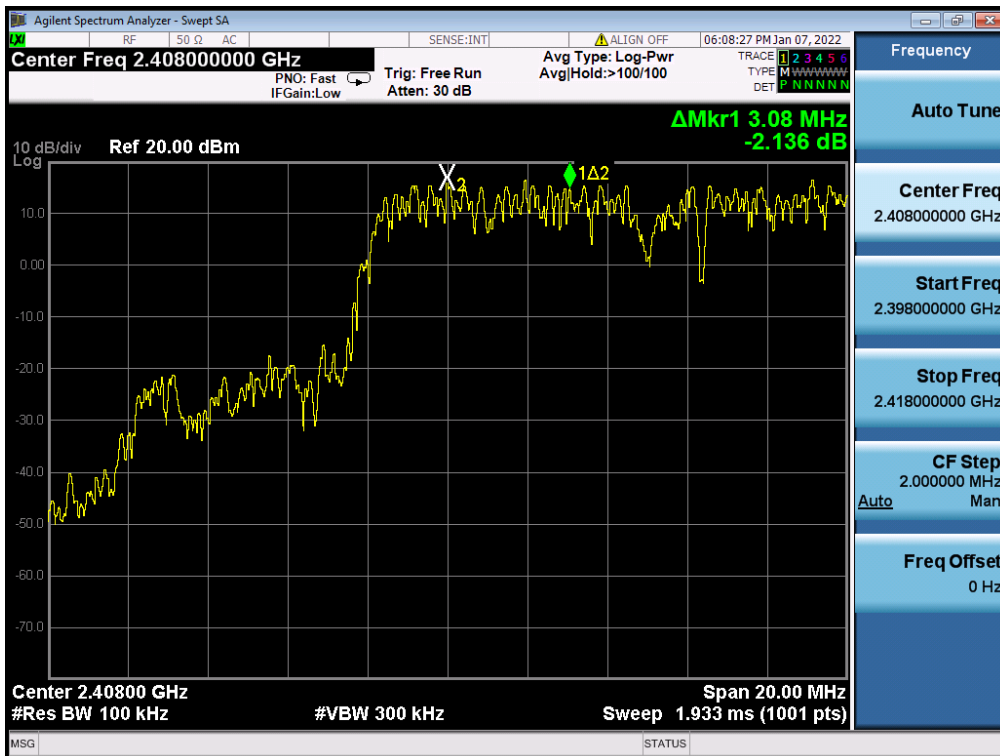

2. Middle Channels:

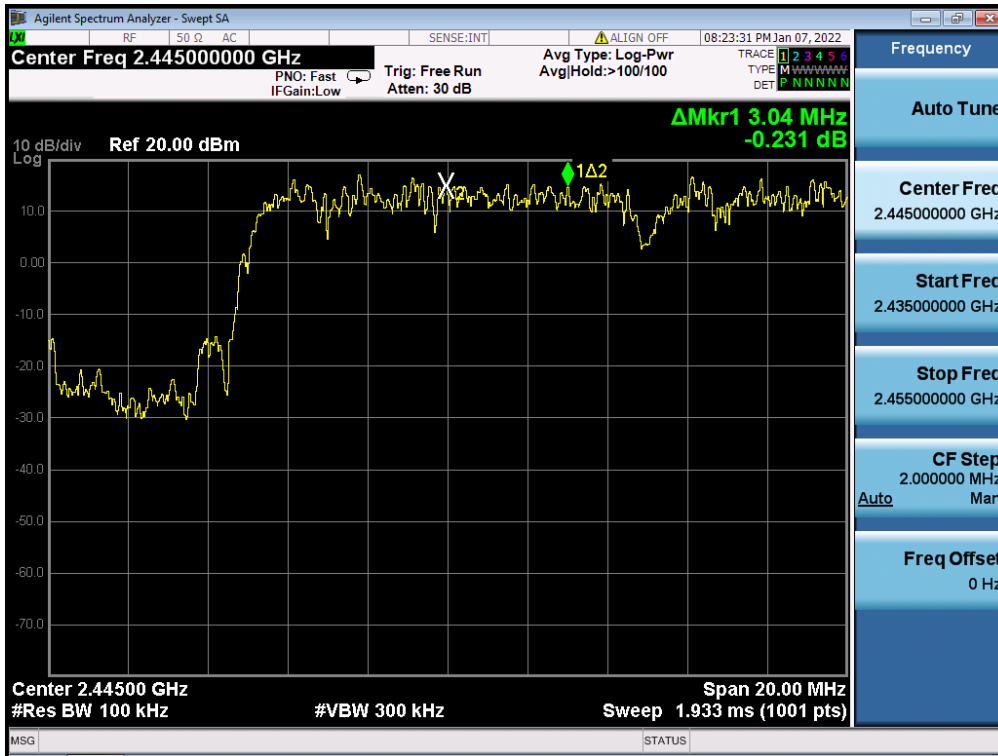

3. Highest Channels



## 5.5 Hopping Channel Number

**Test Requirement:** FCC Part15 C section 15.247  
(a)(1)(iii) Frequency hopping systems in the 2400-2483.5 MHz band shall use at least 15 channels.

**Test Method:** ANSI C63.10:2013

**Test Status:** Test the EUT in hopping mode.

**Test Configuration:**

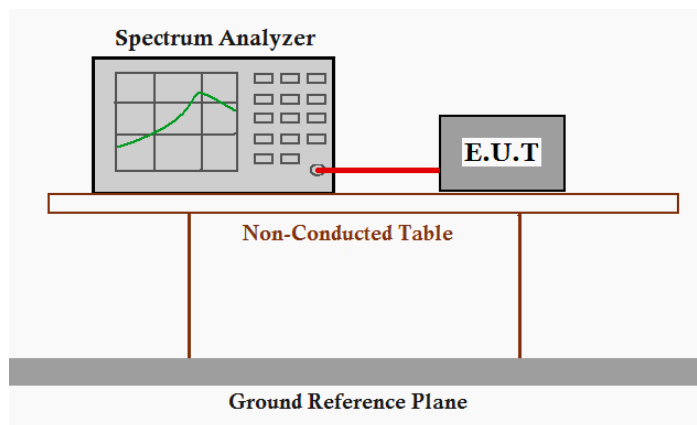

### Test Procedure:

1. Remove the antenna from the EUT and then connect a low attenuation RF cable from the antenna port to the spectrum.
2. Set the spectrum analyzer: RBW = 100 kHz. VBW = 300 kHz. Sweep = auto; Detector Function = Peak. Trace = Max hold.
3. Allow the trace to stabilize. It may prove necessary to break the span up to sections. in order to clearly show all of the hopping frequencies. The limit is specified in one of the subparagraphs of this Section.
4. Set the spectrum analyzer: start frequency = 2400 MHz. stop frequency = 2483.5 MHz. Submit the test result graph.



Test result: Total channels are 19 channels.

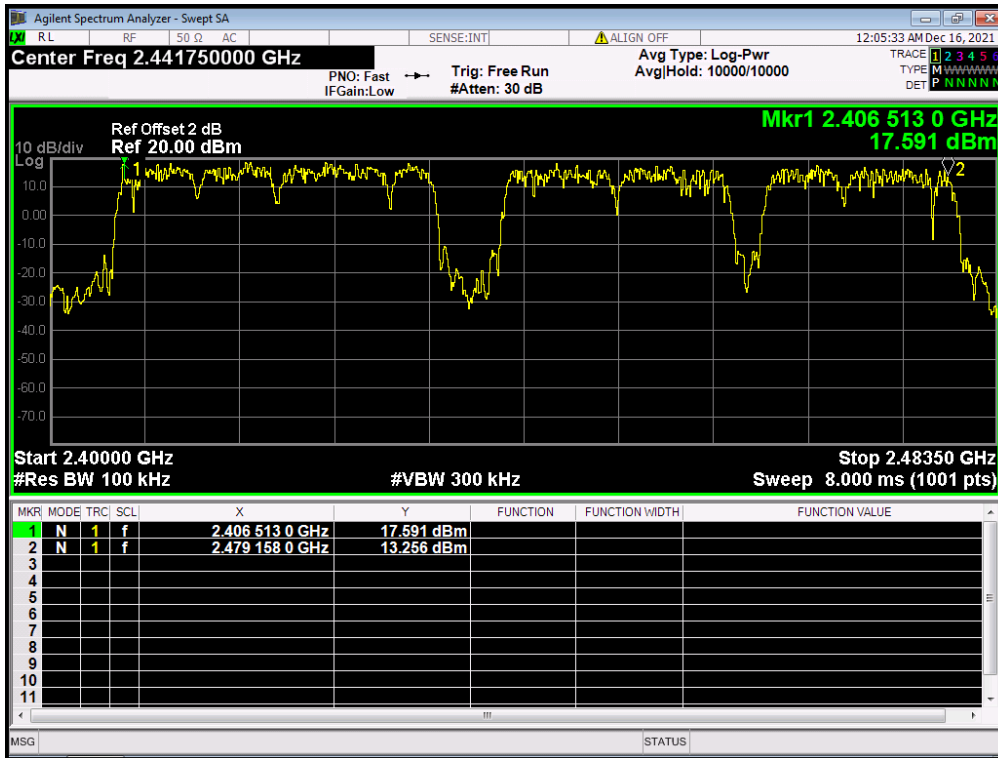

Test result: The unit does meet the FCC requirements.

## 5.6 Dwell Time

**Test Requirement:** FCC Part 15 C section 15.247

(a)(1)(iii) Frequency hopping systems in the 2400-2483.5 MHz band shall use at least 15 channels. The average time of occupancy on any channel shall not be greater than 0.4 seconds within a period of 0.4 seconds multiplied by the number of hopping channels employed. Frequency hopping systems may avoid or suppress transmissions on a particular hopping frequency provided that a minimum of 15 channels are used.

**Test Method:** ANSI C63.10:2013

**Test Status:** Test the EUT in continuous transmitting mode at the lowest, middle and highest channel

**Test Configuration:**

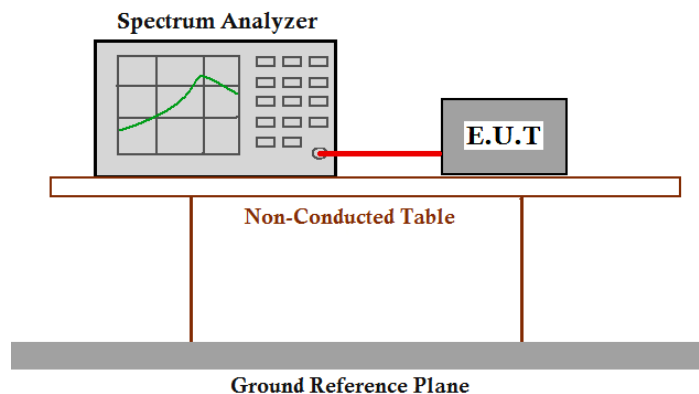

**Test Procedure:**

1. Remove the antenna from the EUT and then connect a low attenuation RF cable from the antenna port to the spectrum.
  2. Set spectrum analyzer span = 0. centered on a hopping channel;
  3. Set RBW = 1 MHz and VBW = 3 MHz. Sweep = as necessary to capture the entire dwell time per hopping channel. Detector Function = Peak. Trace = View;
  4. Use the marker-delta function to determine the dwell time. If this value varies with different modes of operation (e.g.. data rate. modulation format. etc.). Repeat this test for each variation.
- The limit is specified in one of the subparagraphs of this Section. Submit this plot(s). An oscilloscope may be used instead of a spectrum analyzer.



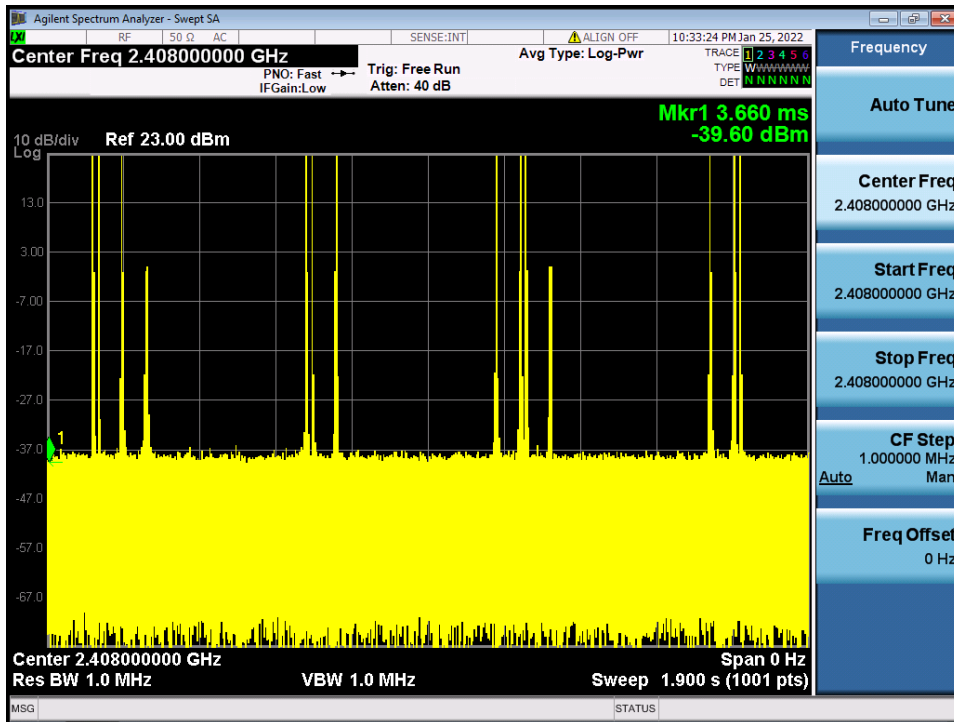

Middle channel (2.445 GHz):

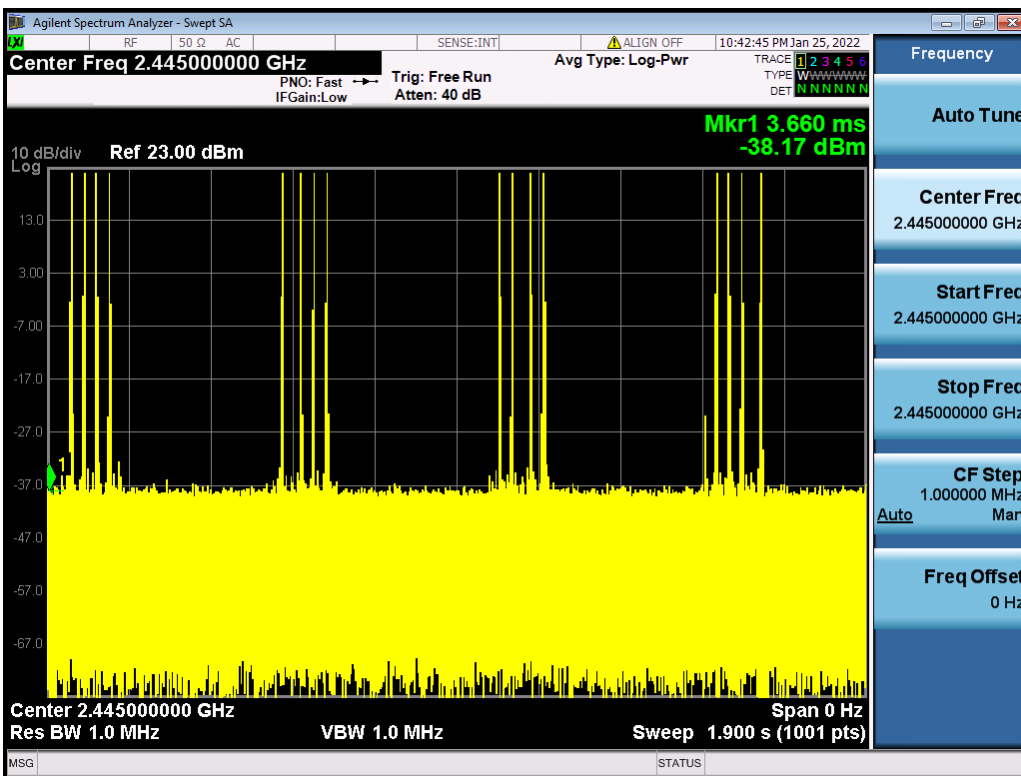
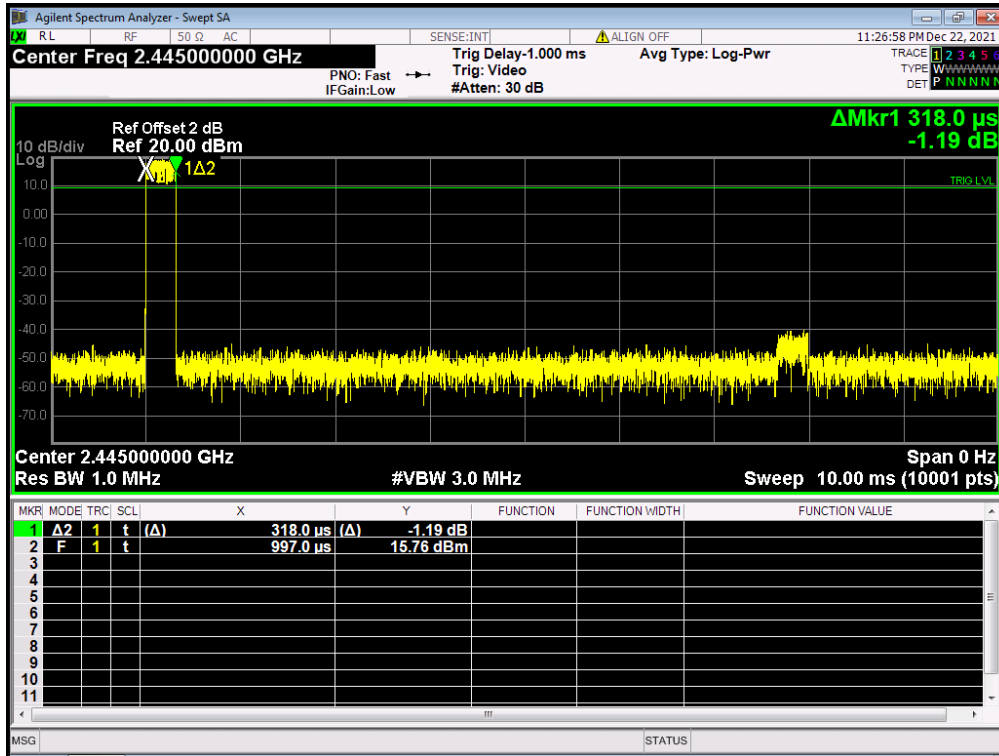

Highest channel (2.478 GHz):

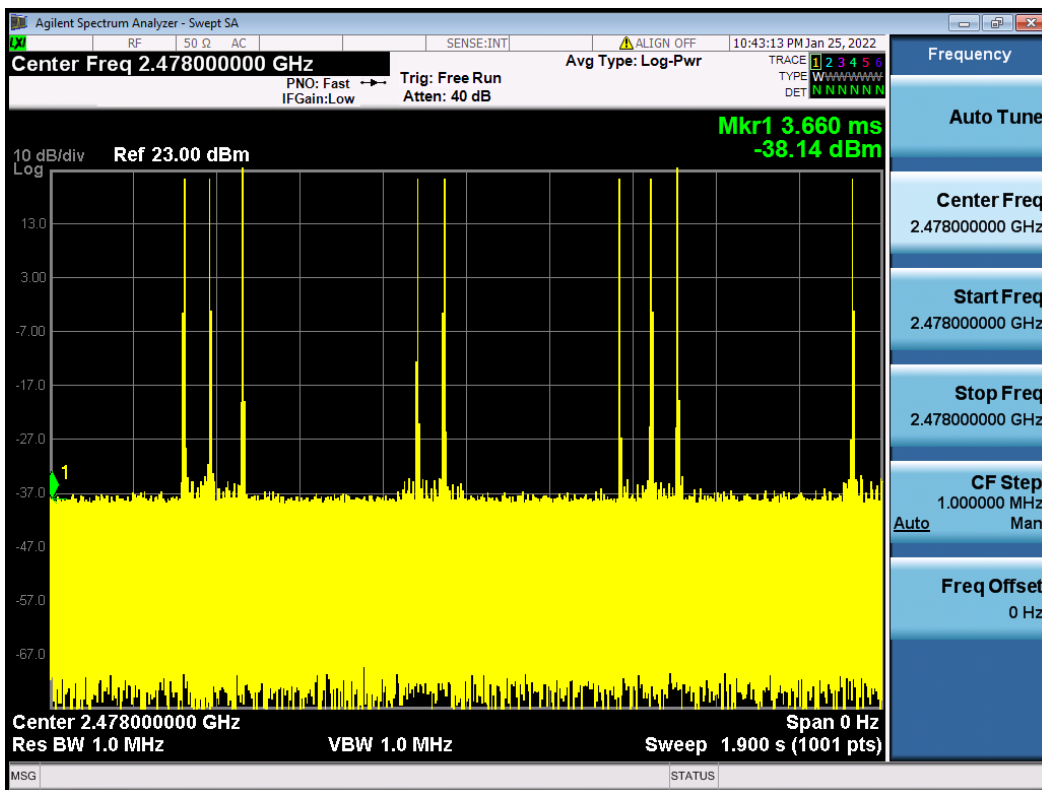
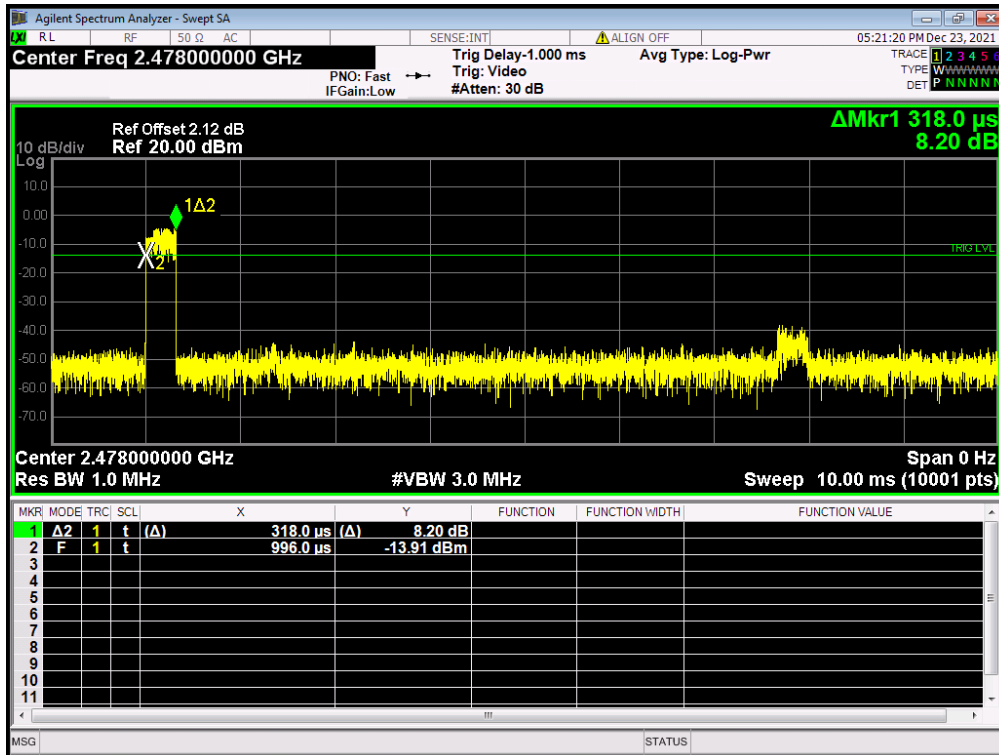

The results are not greater than 0.4 seconds

The unit does meet the FCC requirements.

## 5.7 Maximum Peak Output Power

**Test Requirement:** FCC Part 15 C section 15.247

(b)(1) For frequency hopping systems operating in the 2400-2483.5 MHz band employing at least 75 non-overlapping hopping channels, and all frequency hopping systems in the 5725-5850 MHz band: 1 watt.  
For all other frequency hopping systems in the 2400-2483.5 MHz band: 0.125W

Refer to the result "Hopping channel number" of this document. The 1 watt (30.0 dBm) limit applies.

**Test Method:** ANSI C63.10:2013

**Test Limit:**

**Test mode:** Test the EUT in continuous transmitting mode at the lowest, middle and highest channel.

**Test Configuration:**

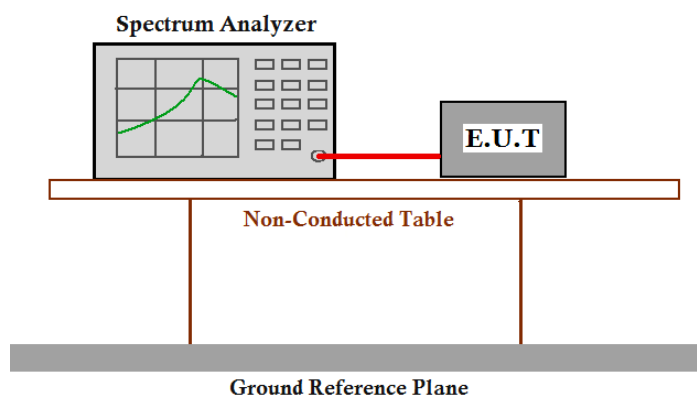

**Test Procedure:**

- 1 . Remove the antenna from the EUT and then connect a low attenuation RF cable from the antenna port to the spectrum.
- 2 . Set the spectrum analyzer: RBW = 1 MHz. VBW = 3 MHz. Sweep = auto; Detector Function =Peak.
- 3 . Keep the EUT in transmitting at lowest, medium and highest channel individually. Record the max value.

Test Result:				
Test Channel	Fundamental Frequency (MHz)	Output Power (dBm)	Limit (dBm)	Result
Lowest	2408	16.584	30.0	Pass
Middle	2445	15.239	30.0	Pass
Highest	2478	14.550	30.0	Pass
Remark: cable lose add as offset factor				
Test result: The unit does meet the FCC requirements.				
Test result plot as follows:				

Lowest Channel:

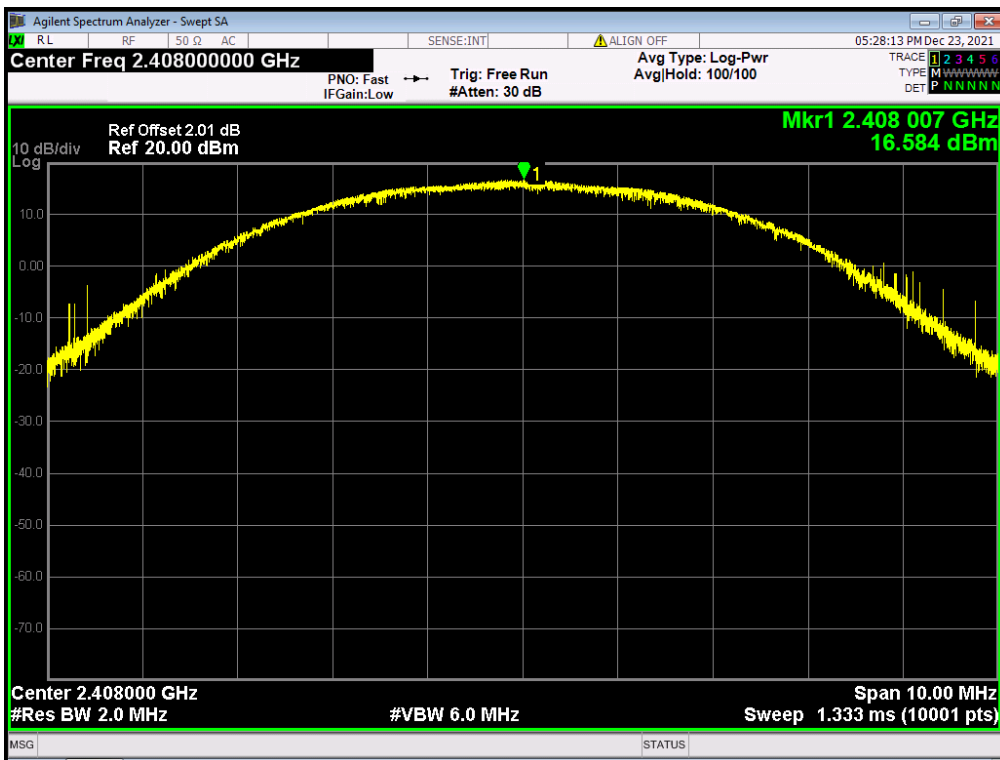



Middle Channel:

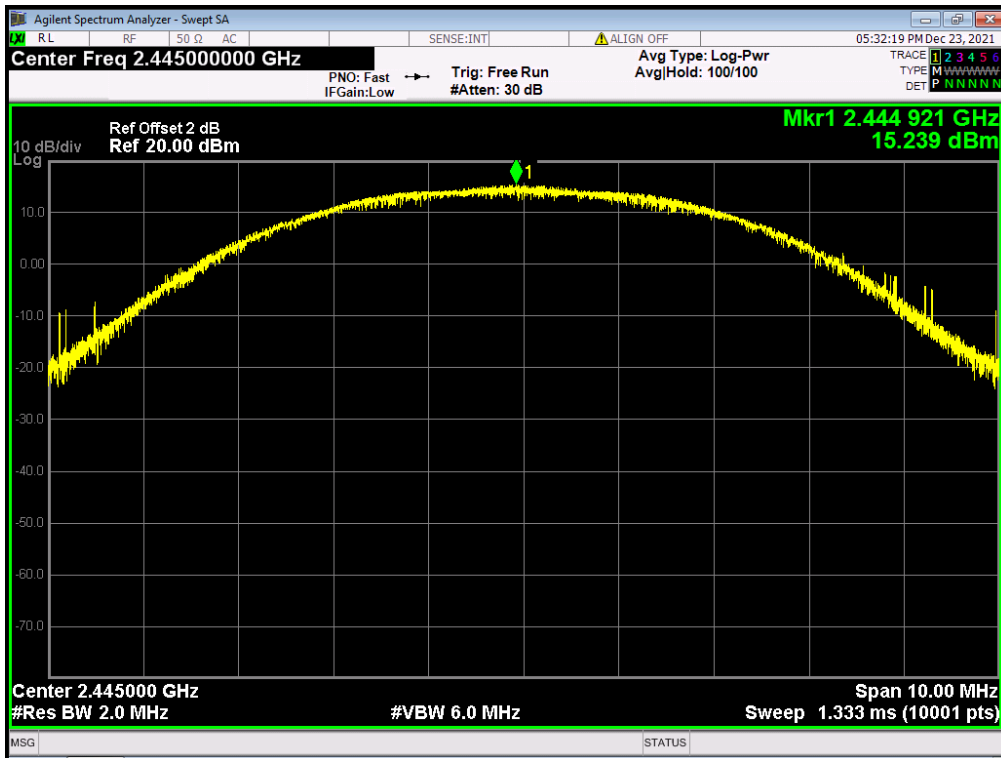

Highest Channel:

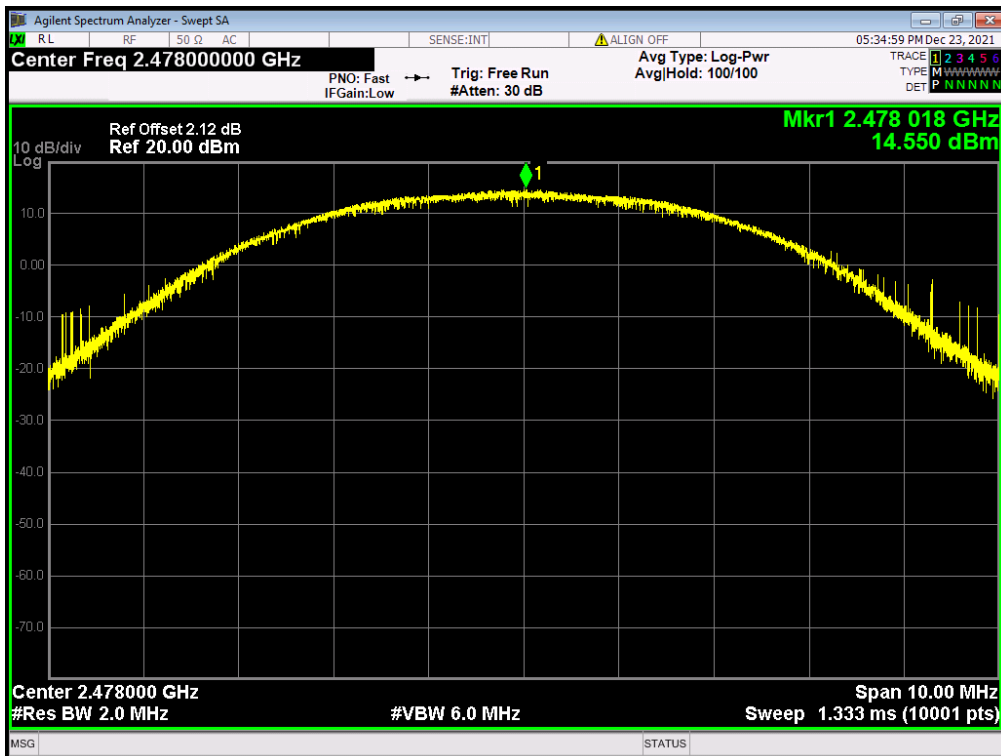

## 5.8 Conducted Spurious Emissions

**Test Requirement:** FCC Part15 C section 15.247

(d) In any 100 kHz bandwidth outside the frequency band in which the spread spectrum or digitally modulated intentional radiator is operating. The radio frequency power that is produced by the intentional radiator shall be at least 20 dB below that in the 100 kHz bandwidth within the band that contains the highest level of the desired power. Based on either an RF conducted or a radiated measurement. Provided the transmitter demonstrates compliance with the peak conducted power limits.

**Test Method:** ANSI C63.10:2013

**Test Status:** Test the EUT in continuous transmitting mode at the lowest, middle and highest channel.

**Test Configuration:**

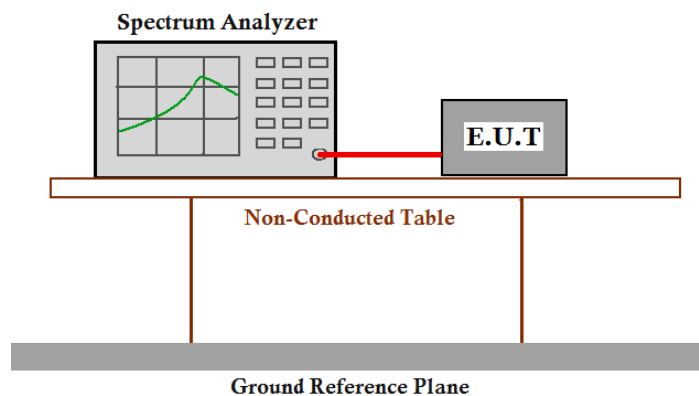

**Test Procedure:**

1. Remove the antenna from the EUT and then connect a low attenuation RF cable from the antenna port to the spectrum.
2. Set the spectrum analyzer: RBW = 100 kHz. VBW  $\geq$  RBW. Sweep = auto; Detector Function = Peak (Max. hold).

Test result plot as follows

Lowest Channel:

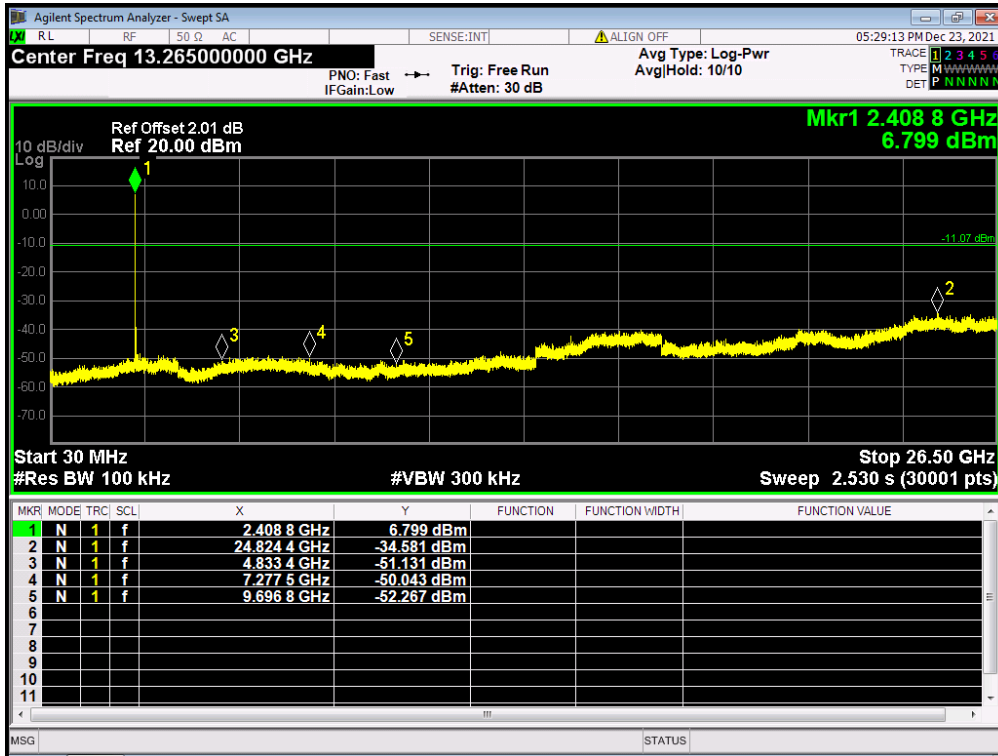

Middle Channel

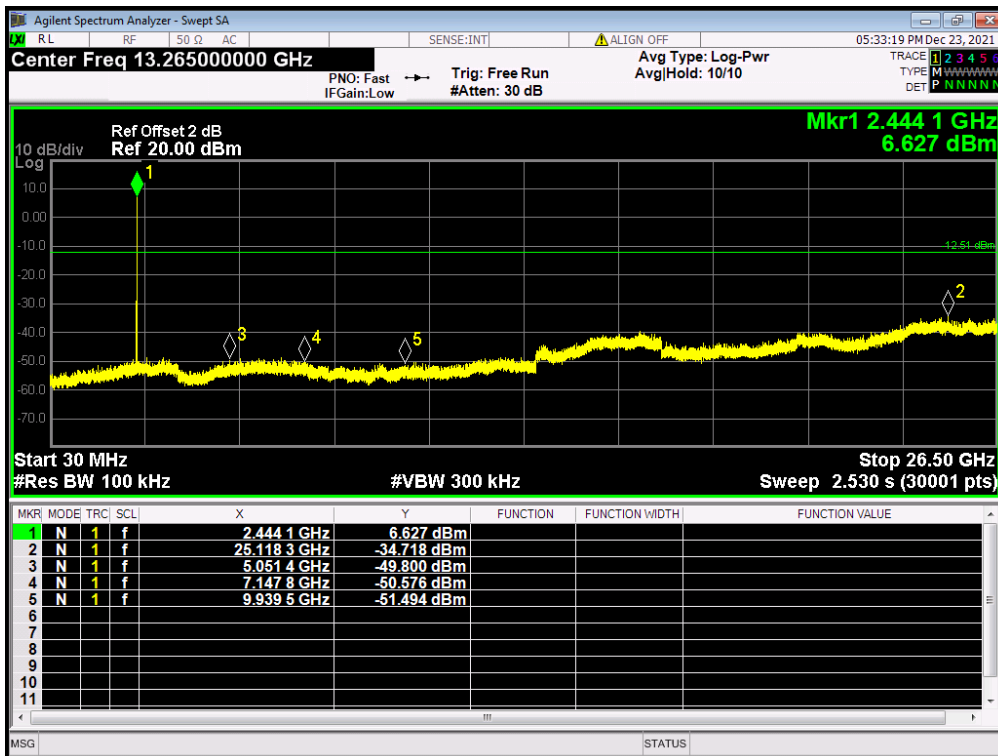

Highest channel

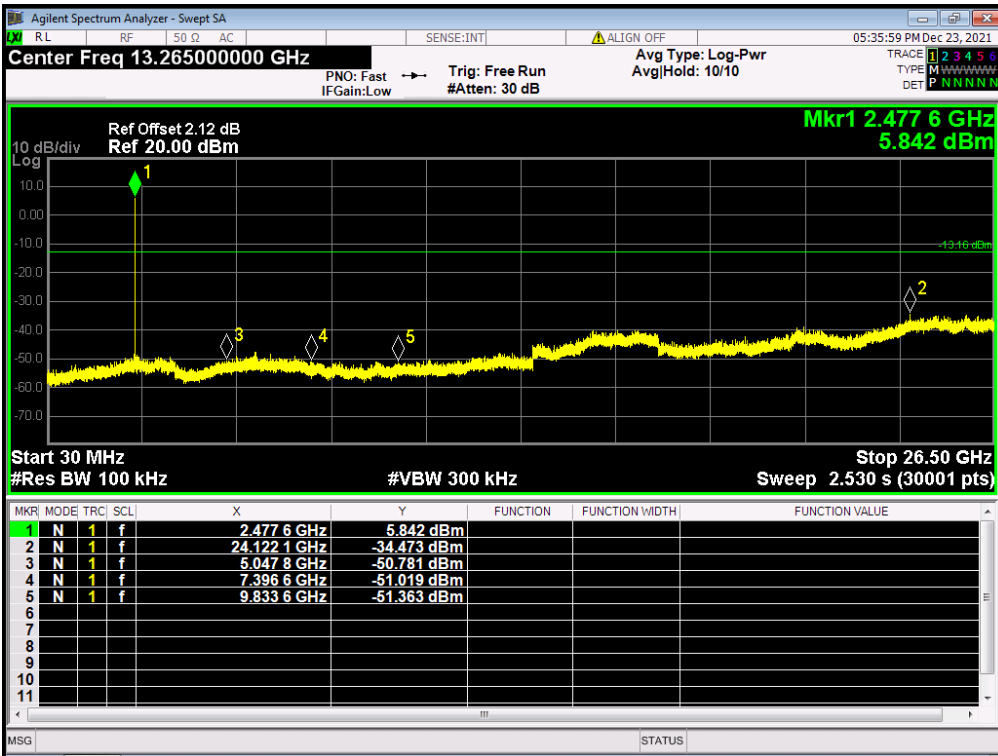

Test result: The unit does meet the FCC requirements.

## 5.9 Radiated Spurious Emissions

<b>Test Requirement:</b>	FCC Part15 C section 15.247  (d) In any 100 kHz bandwidth outside the frequency band in which the spread spectrum or digitally modulated intentional radiator is operating. The radio frequency power that is produced by the intentional radiator shall be at least 20 dB below that in the 100 kHz bandwidth within the band that Contains the highest level of the desired power, based on either an RF conducted or a radiated measurement, and provided the transmitter demonstrates compliance with the peak conducted power limits.
<b>Test Method:</b>	ANSI C63.10:2013
<b>Test Status:</b>	Test the EUT in continuous transmitting mode at the lowest, middle and highest channel.
<b>Detector:</b>	For PK value: RBW = 1 MHz for $f \geq 1$ GHz, 100 kHz for $f < 1$ GHz, 9kHz for $<30$ MHz VBW $\geq$ RBW Sweep = auto Detector function = peak Trace = max hold  For AV value: RBW = 1 MHz for $f \geq 1$ GHz, 100 kHz for $f < 1$ GHz, 9kHz for $<30$ MHz VBW =10 Hz Sweep = auto Detector function = peak Trace = max hold

15.209 Limit:

Frequency (MHz)	Field Strength (microvolts/meter)	Measurement Distance (meters)
0.009 - 0.490	2400/F(kHz)	300
0.490 - 1.705	24000/F(kHz)	30
1.705 - 30.0	30	30
30 - 88	100	3
88 - 216	150	3
216 - 960	200	3
Above 960	500	3

**Test Configuration:**

1) 9kHz to 30MHz emissions:

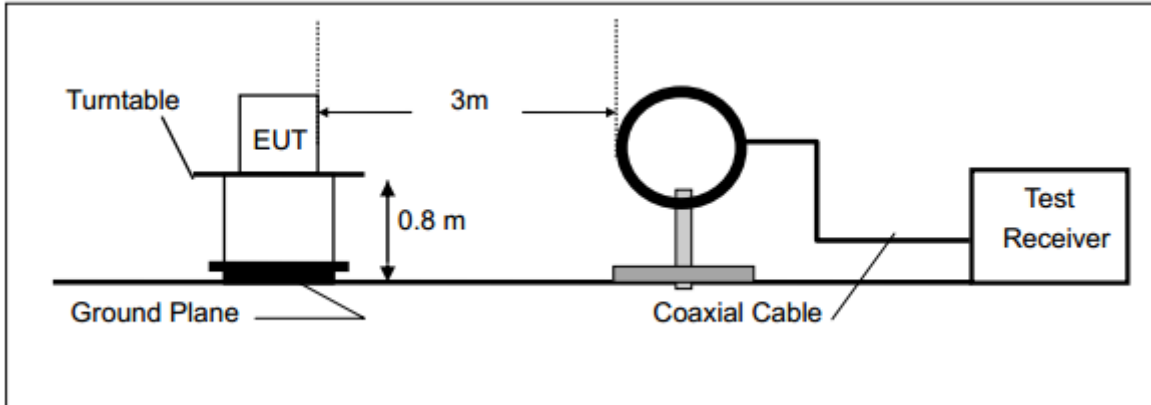

2) 30 MHz to 1 GHz emissions:

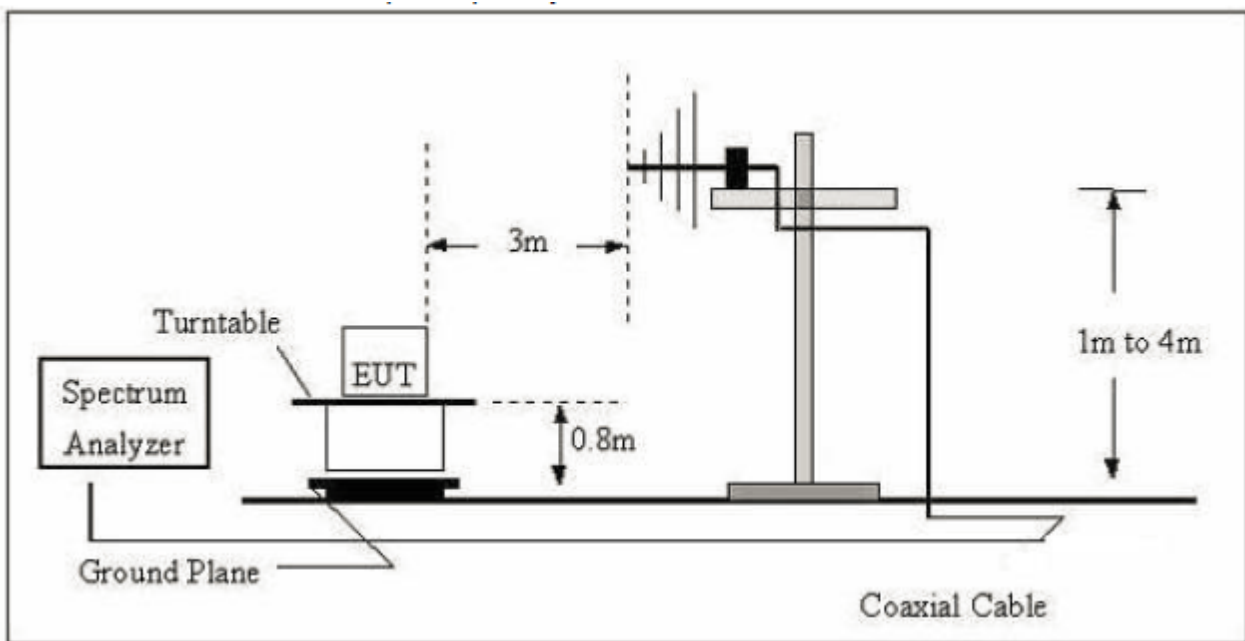

## 3) 1 GHz to 40 GHz emissions:

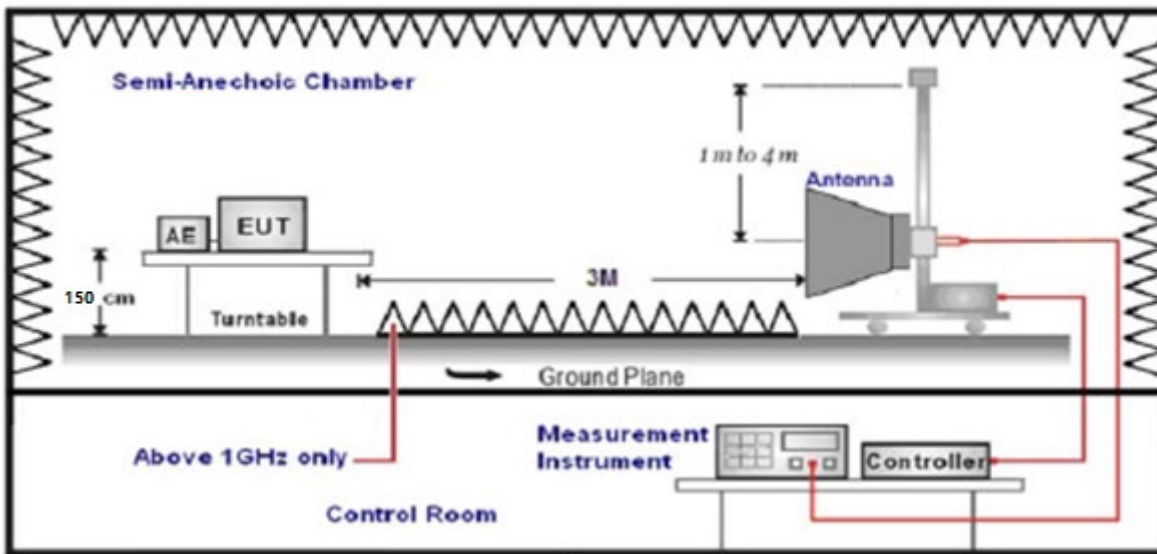

**Test Procedure:** The receiver was scanned from 9kHz to 25GHz. When an emission was found, the table was rotated to produce the maximum signal strength. An initial pre-scan was performed for in peak detection mode using the receiver. The EUT was measured for both the Horizontal and Vertical polarities and performed a pre-test three orthogonal planes. For intentional radiators, measurements of the variation of the input power or the radiated signal level of the fundamental frequency component of the emission, as appropriate, shall be performed with the supply voltage varied between 85% and 115% of the nominal rated supply voltage. After pre-test, it was found that the worse radiation emission was get at the X position. So the data shown was the X position only. The worst case emissions were reported.

Now set the VBW to 10 Hz, while maintaining all of the other instrument settings. This peak level, once corrected, must comply with the limit specified in Section 15.209. If the dwell time per channel of the hopping signal is less than 100 ms, then the reading obtained with the 10 Hz VBW may be further adjusted by a "duty cycle correction factor", derived from  $20\log(\text{dwell time}/100 \text{ ms})$ , in an effort to demonstrate compliance with the 15.209 limit. Submit this data.

**For the radiated emission test above 1GHz:**

Place the measurement antenna away from each area of the EUT determined to be a source of emissions at the specified measurement distance, while keeping the measurement antenna aimed at the source of emissions at each frequency of significant emissions, with polarization oriented for maximum response. The measurement antenna may have to be higher or lower than the EUT, depending on the radiation pattern of the emission and staying aimed at the emission source for receiving the maximum signal. The final measurement antenna elevation shall be that which maximizes the emissions.

The measurement antenna elevation for maximum emissions shall be restricted to a range of heights of from 1 m to 4 m above the ground or reference ground plane.

**5.9.1 Harmonic and other spurious emissions**

**Worst case data**

9kHz~30MHz Test result

The Low frequency, which started from 9kHz to 30MHz, was pre-scanned and the result which was 20dB lower than the limit line per 15.31(o) was not report

30 MHz~1 GHz Spurious Emissions .Quasi-Peak Measurement

Horizontal:

Peak scan

Level (dBμV/m)

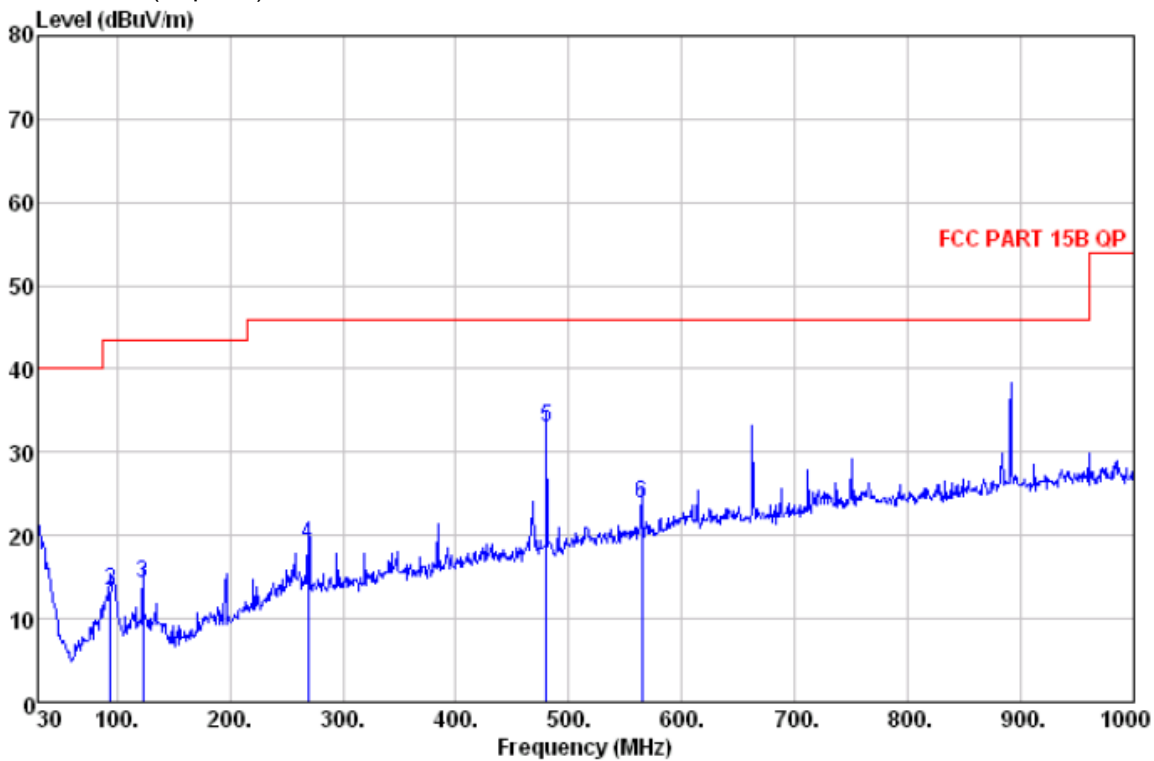

Quasi-peak measurement

No.	Freq MHz	Read Level dBuV	Antenna Factor dB	Cable Loss dB	Preamp Factor dB	Level dBuV/m	Limit Line dBuV/m	Over Limit dB	Pol/Phase	Remark
1	30.000	23.96	22.90	0.63	28.50	18.99	40.00	-21.01	HORIZONTAL	QP
2	94.020	32.57	8.22	1.13	28.57	13.35	43.50	-30.15	HORIZONTAL	QP
3	123.120	32.33	9.11	1.32	28.47	14.29	43.50	-29.21	HORIZONTAL	QP
4	269.590	30.94	13.18	2.01	27.22	18.91	46.00	-27.09	HORIZONTAL	QP
5	480.080	42.11	16.72	2.72	28.48	33.07	46.00	-12.93	HORIZONTAL	QP
6	564.470	31.46	18.22	2.96	28.78	23.86	46.00	-22.14	HORIZONTAL	QP



30 MHz~1 GHz Spurious Emissions .Quasi-Peak Measurement

Vertical:

Peak scan

Level (dBμV/m)

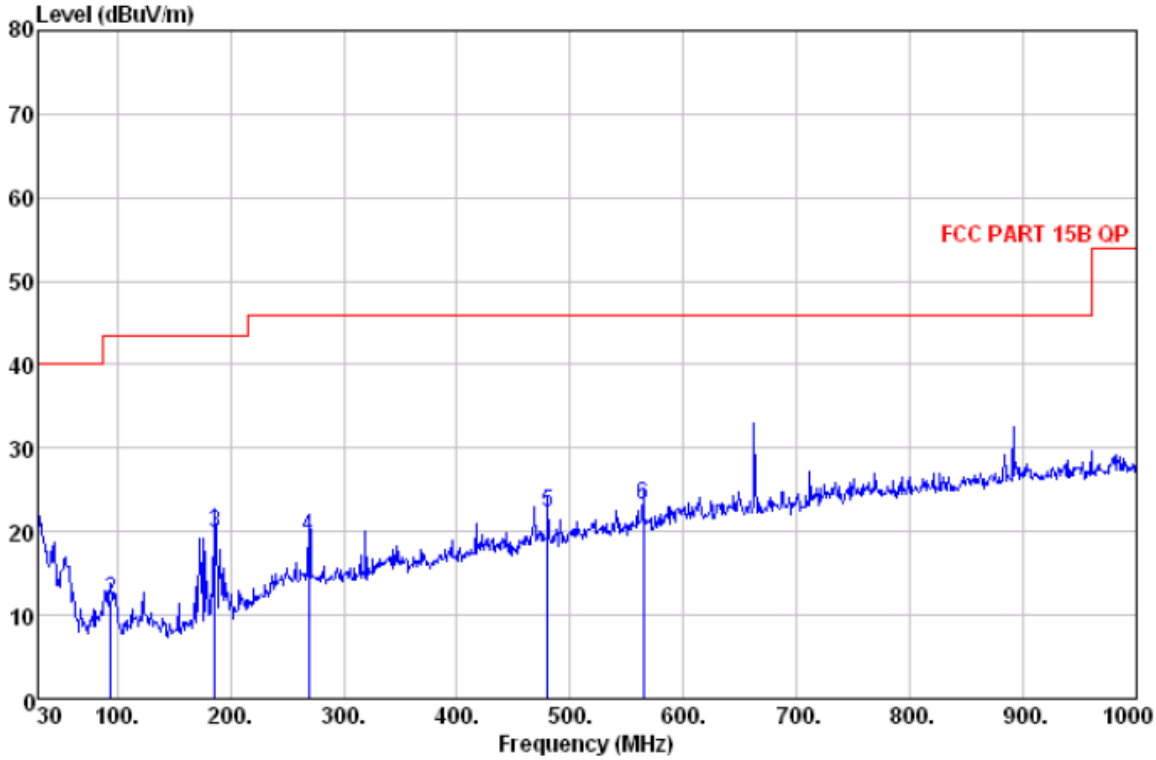

Quasi-peak measurement

No.	Freq MHz	Read Level dBμV	Antenna Factor dB	Cable Loss dB	Preamp Factor dB	Level dBμV/m	Limit Line dBμV/m	Over Limit dB	Pol/Phase	Remark
1	30.000	23.33	22.90	0.63	28.50	18.36	40.00	-21.64	VERTICAL	QP
2	94.020	31.03	8.22	1.13	28.57	11.81	43.50	-31.69	VERTICAL	QP
3	186.170	36.23	9.63	1.64	27.68	19.82	43.50	-23.68	VERTICAL	QP
4	269.590	31.39	13.18	2.01	27.22	19.36	46.00	-26.64	VERTICAL	QP
5	480.080	31.22	16.72	2.72	28.48	22.18	46.00	-23.82	VERTICAL	QP
6	564.470	30.81	18.22	2.96	28.78	23.21	46.00	-22.79	VERTICAL	QP

**Spurious emissions above 1GHz**

Horizontal:

Peak scan

Level (dBuV/m)

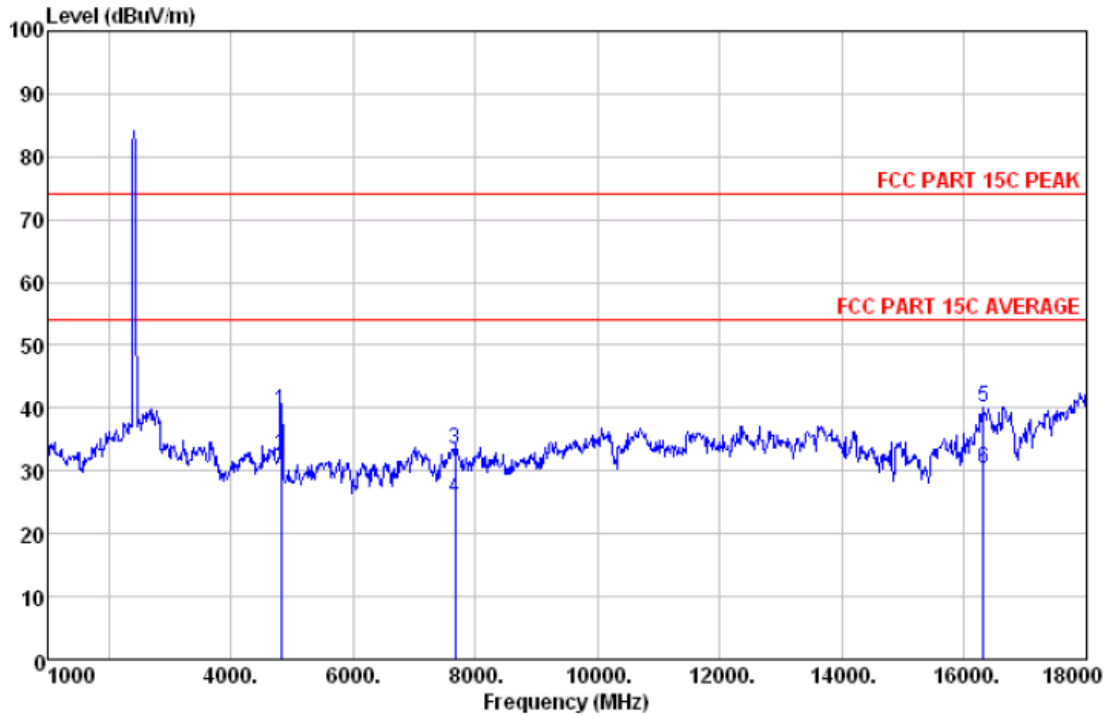

No.	Freq MHz	Read Level dBuV	Antenna Factor dB	Cable Loss dB	Preamp Factor dB	Level dBuV/m	Limit Line dBuV/m	Over Limit dB	Pol/Phase	Remark
1	4825.000	24.16	33.36	9.60	27.62	39.50	74.00	-34.50	HORIZONTAL	Peak
2	4825.000	17.02	33.36	9.60	27.62	32.36	54.00	-21.64	HORIZONTAL	Average
3	7664.000	11.14	37.13	12.58	27.31	33.54	74.00	-40.46	HORIZONTAL	Peak
4	7664.000	3.32	37.13	12.58	27.31	25.72	54.00	-28.28	HORIZONTAL	Average
5	516317.000	6.01	40.01	19.74	25.74	40.02	74.00	-33.98	HORIZONTAL	Peak
6	616317.000	-3.70	40.01	19.74	25.74	30.31	54.00	-23.69	HORIZONTAL	Average

**Level=Read Level + Antenna Factor + Cable Loss - Preamp Factor**

**Note: The emission above limit is fundamental emission, which is not subject to the limit.**

Vertical:

Peak scan

Level (dBµV/m)

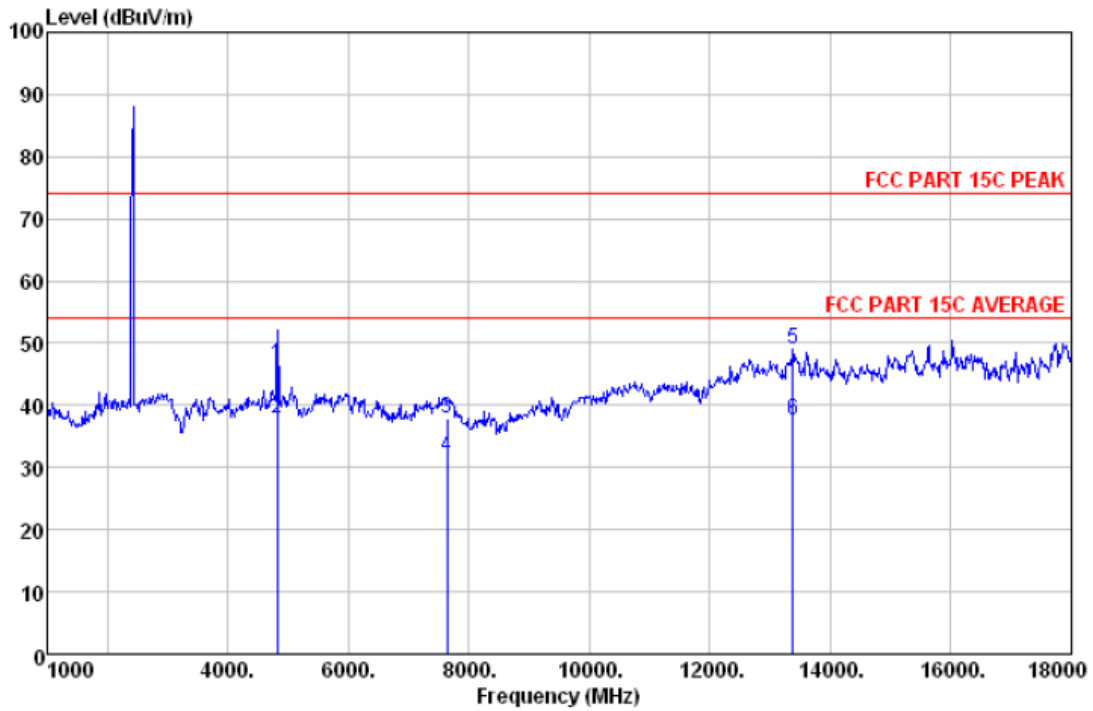

No.	Freq MHz	Read Level dBµV	Antenna Factor dB	Cable Loss dB	Preamp Factor dB	Level dBµV/m	Limit Line dBµV/m	Over Limit dB	Pol/Phase	Remark
1	4825.000	31.16	33.36	9.60	27.62	46.50	74.00	-27.50	VERTICAL	Peak
2	4825.000	22.50	33.36	9.60	27.62	37.84	54.00	-16.16	VERTICAL	Average
3	7636.000	15.49	37.15	12.55	27.31	37.88	74.00	-36.12	VERTICAL	Peak
4	7636.000	9.24	37.15	12.55	27.31	31.63	54.00	-22.37	VERTICAL	Average
5	13376.000	17.80	40.17	17.49	26.36	49.10	74.00	-24.90	VERTICAL	Peak
6	13376.000	6.28	40.17	17.49	26.36	37.58	54.00	-16.42	VERTICAL	Average

Level=Read Level + Antenna Factor + Cable Loss - Preamp Factor

Note: The emission above limit is fundamental emission, which is not subject to the limit.

**Test at Middle Channel in transmitting status**

Spurious emissions above 1GHz

Horizontal:

Peak scan

Level (dBµV/m)

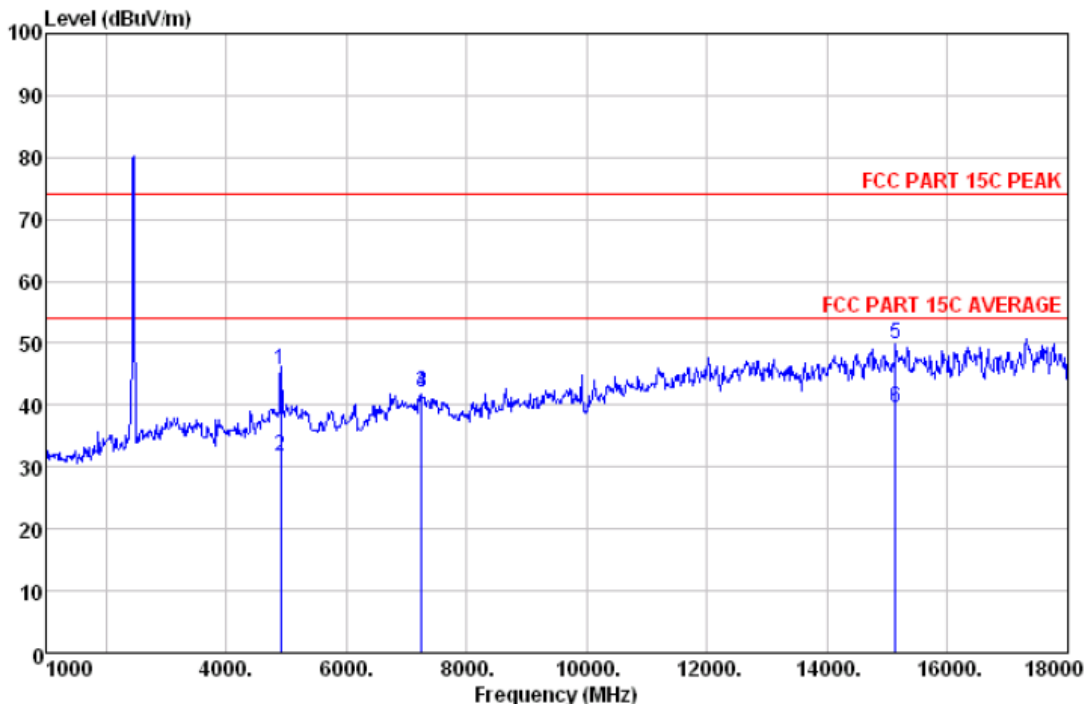

No.	Freq MHz	Read Level dBµV	Antenna Factor dB	Cable Loss dB	Preamp Factor dB	Level dBµV/m	Limit Line dBµV/m	Over Limit dB	PoI/Phase	Remark
1	4910.000	30.27	33.43	9.70	27.61	45.79	74.00	-28.21	HORIZONTAL	Peak
2	4910.000	16.13	33.43	9.70	27.61	31.65	54.00	-22.35	HORIZONTAL	Averag
3	7256.000	20.32	36.81	12.18	27.33	41.98	74.00	-32.02	HORIZONTAL	Peak
4	7256.000	20.32	36.81	12.18	27.33	41.98	54.00	-12.02	HORIZONTAL	Averag
5	15127.000	17.11	39.92	18.83	26.05	49.81	74.00	-24.19	HORIZONTAL	Peak
6	15127.000	6.89	39.92	18.83	26.05	39.59	54.00	-14.41	HORIZONTAL	Averag

**Level=Read Level + Antenna Factor + Cable Loss - Preamp Factor**

**Note: The emission above limit is fundamental emission, which is not subject to the limit.**

Vertical:

Peak scan

Level (dBµV/m)

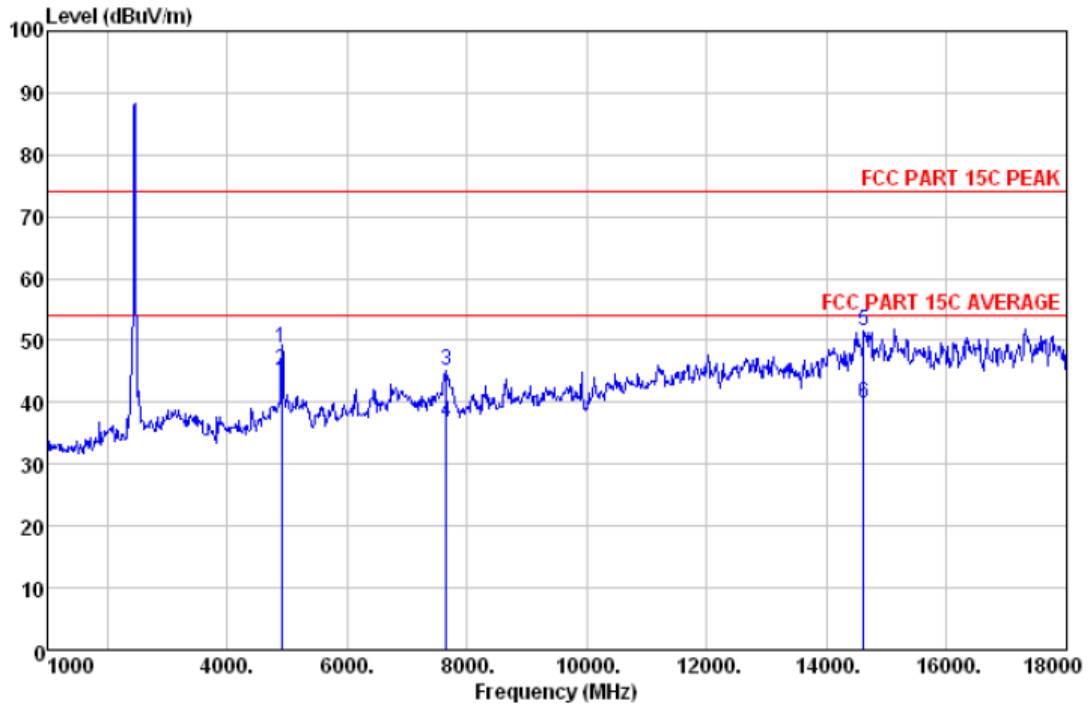

No.	Freq MHz	Read Level dBµV	Antenna Factor dB	Cable Loss dB	Preamp Factor dB	Level dBµV/m	Limit Line dBµV/m	Over Limit dB	Pol/Phase	Remark
1	4910.000	33.27	33.43	9.70	27.61	48.79	74.00	-25.21	VERTICAL	Peak
2	4910.000	29.54	33.43	9.70	27.61	45.06	54.00	-8.94	VERTICAL	Average
3	7647.000	22.82	37.14	12.56	27.31	45.21	74.00	-28.79	VERTICAL	Peak
4	7647.000	14.26	37.14	12.56	27.31	36.65	54.00	-17.35	VERTICAL	Average
5	51461.7000	19.34	39.79	18.48	26.13	51.48	74.00	-22.52	VERTICAL	Peak
6	61461.7000	7.64	39.79	18.48	26.13	39.78	54.00	-14.22	VERTICAL	Average

Note: The emission above limit is fundamental emission, which is not subject to the limit.

**Test at high Channel in transmitting status**

Spurious emissions above 1GHz

Horizontal:

Peak scan

Level (dBμV/m)

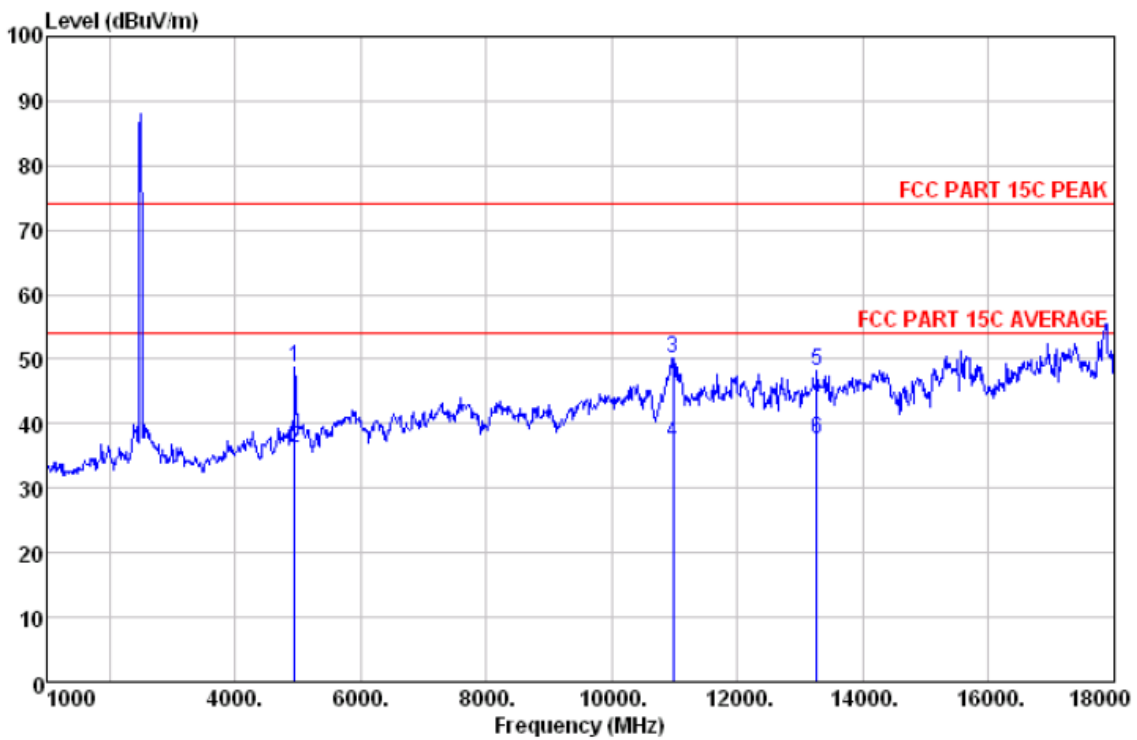

No.	Freq MHz	Read Level dBμV	Antenna Factor dB	Cable Loss dB	Preamp Factor dB	Level dBμV/m	Limit Line dBμV/m	Over Limit dB	Pol/Phase	Remark
1	4944.000	33.10	33.46	9.74	27.60	48.70	74.00	-25.30	HORIZONTAL	Peak
2	4944.000	20.59	33.46	9.74	27.60	36.19	54.00	-17.81	HORIZONTAL	Average
	31097.9000	22.54	39.17	15.56	27.03	50.24	74.00	-23.76	HORIZONTAL	Peak
	41097.9000	9.36	39.17	15.56	27.03	37.06	54.00	-16.94	HORIZONTAL	Average
	51325.7000	16.87	40.34	17.39	26.40	48.20	74.00	-25.80	HORIZONTAL	Peak
	61325.7000	6.19	40.34	17.39	26.40	37.52	54.00	-16.48	HORIZONTAL	Average

**Level=Read Level + Antenna Factor + Cable Loss - Preamp Factor**

**Note: The emission above limit is fundamental emission, which is not subject to the limit.**

Vertical:

Peak scan

Level (dBµV/m)

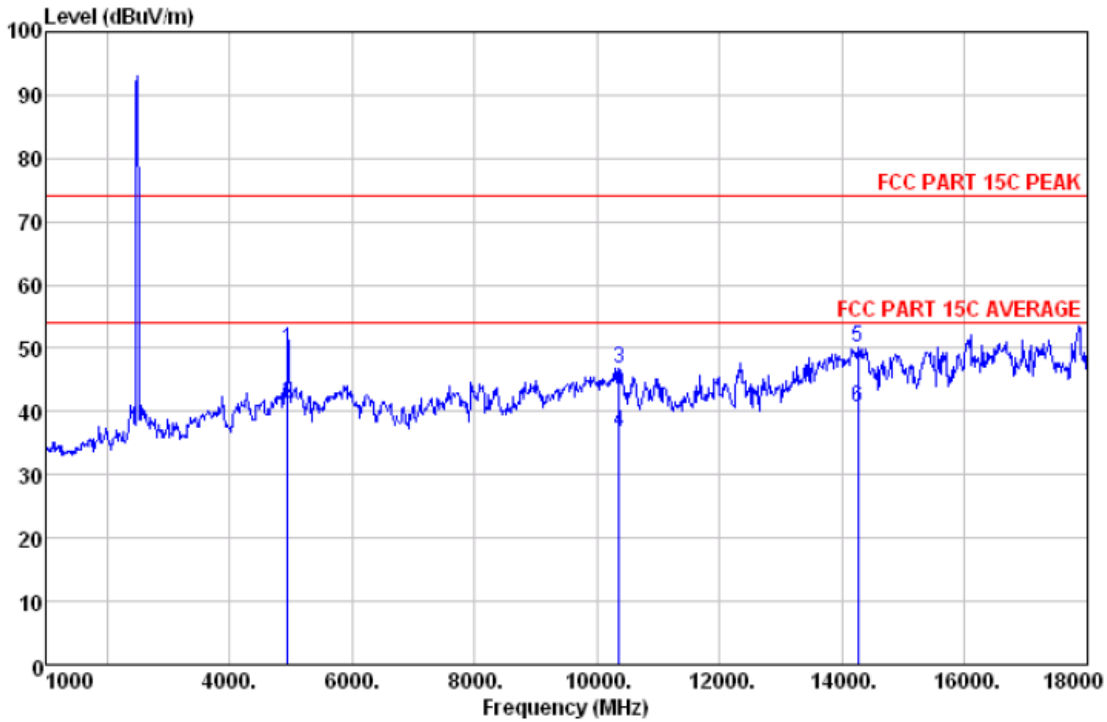

No.	Freq MHz	Read Level dBµV	Antenna Factor dB	Cable Loss dB	Preamp Factor dB	Level dBµV/m	Limit Line dBµV/m	Over Limit dB	Pol/Phase	Remark
1	4944.000	34.30	33.46	9.74	27.60	49.90	74.00	-24.10	VERTICAL	Peak
2	4944.000	25.73	33.46	9.74	27.60	41.33	54.00	-12.67	VERTICAL	Average
	310350.000	20.15	38.72	14.93	27.08	46.72	74.00	-27.28	VERTICAL	Peak
	410350.000	10.32	38.72	14.93	27.08	36.89	54.00	-17.11	VERTICAL	Average
	514260.000	18.79	39.46	18.19	26.18	50.26	74.00	-23.74	VERTICAL	Peak
	614260.000	9.18	39.46	18.19	26.18	40.65	54.00	-13.35	VERTICAL	Average

**Note: The emission above limit is fundamental emission, which is not subject to the limit.**

Remark:

- 1). The field strength is calculated by adding the Antenna Factor, Cable Factor & Pre-amplifier. The basic equation with a sample calculation is as follows:  
Final Test Level = Receiver Reading + Antenna Factor + Cable Loss – Pre-amplifier Factor.
- 2). As shown in Section, for frequencies above 1000 MHz, the above field strength limits are based on average limits. However, the peak field strength of any emission shall not exceed the maximum permitted average limits specified above by more than 20 dB under any condition of modulation.
- 3). The test only performs the EUT in transmitting status since the test frequencies were over 1GHz only required transmitting status.

**Test result: The unit does meet the FCC requirements.**

## 5.10 Radiated Emissions which fall in the restricted bands

**Test Requirement:** FCC Part15 C Section 15.247

(d) In addition, radiated emissions which fall in the restricted bands. as defined in Section 15.205(a), must also comply with the radiated emission limits specified in Section 15.209(a) (see Section 15.205(c)).

**Test Method:** ANSI C63.10:2013 Clause 6.4, 6.5 and 6.6

**Test Status:** Test the EUT in continuous transmitting mode at the lowest (2408MHz) and highest (2478 MHz) channel.

**Measurement Distance:** 3m (Semi-Anechoic Chamber)

**Limit:** Section 15.209(a)

Frequency (MHz)	Field Strength (microvolts/meter)	Measurement Distance (meters)
0.009 - 0.490	2400/F(kHz)	300
0.490 - 1.705	24000/F(kHz)	30
1.705 - 30.0	30	30
30 - 88	100	3
88 - 216	150	3
216 - 960	200	3
Above 960	500	3

**Detector:** For PK value:

RBW = 1 MHz for  $f \geq 1$  GHz, 100 kHz for  $f < 1$  GHz

VBW  $\geq$  RBW Sweep = auto

Detector function = peak

Trace = max hold

For AV value:

RBW = 1 MHz for  $f \geq 1$  GHz, 100 kHz for  $f < 1$  GHz

VBW =10 Hz

Sweep = auto

Detector function = peak

Trace = max hold



**Test Result:**

Frequency (MHz)	Reading Level (dB $\mu$ V/m)	Correct (dB/m)	Emission Level (dB $\mu$ V/m)	Limit (dB $\mu$ V/m)	Margin (dB)	Antenna polarization	Detector
<b>Low Channel</b>							
2310.000	32.79	6.54	39.33	74.00	-34.67	H	PK
2310.000	18.07	6.54	24.61	54.00	-29.39	H	AV
2390.000	30.44	6.61	37.05	74.00	-36.95	V	PK
2390.000	19.72	6.61	26.33	54.00	-27.67	V	AV
<b>High Channel</b>							
2483.500	33.38	6.70	40.08	74.00	-33.92	H	PK
2483.500	19.65	6.70	26.35	54.00	-27.65	H	AV
2500.000	30.38	6.72	37.10	74.00	-36.90	V	PK
2500.000	18.74	6.72	25.46	54.00	-28.54	V	AV

Remark: No any other emission which falls in restricted bands can be detected and be reported.

**Test result: The unit does meet the FCC requirements.**

## 5.11 Band Edges Requirement

**Test Requirement:** FCC Part15 C section 15.247

(d) In any 100 kHz bandwidth outside the frequency band in which the spread spectrum or digitally modulated intentional radiator is operating, the radio frequency power that is produced by the intentional radiator shall be at least 20 dB below that in the 100 kHz bandwidth within the band that contains the highest level of the desired power, based on either an RF conducted or a radiated measurement, provided the transmitter demonstrates compliance with the peak conducted power limits. If the transmitter complies with the conducted power limits based on the use of RMS averaging over a time interval, as permitted under paragraph (b)(3) of this section, the attenuation required under this paragraph shall be 30 dB instead of 20 dB. Attenuation below the general limits specified in Section 15.209(a) is not required. In addition, radiated emissions which fall in the restricted bands, as defined in Section 15.205(a), must also comply with the radiated emission limits specified in Section 15.209(a) (see Section 15.205(c)).

**Frequency Band:** 2400 MHz to 2483.5 MHz

**Test Method:** ANSI C63.10:2013 Clause 6.9

**Test Status:** Test the EUT in continuous transmitting mode at the lowest (2408 MHz), and highest (2478 MHz) channel and hopping mode

**Test Configuration:**

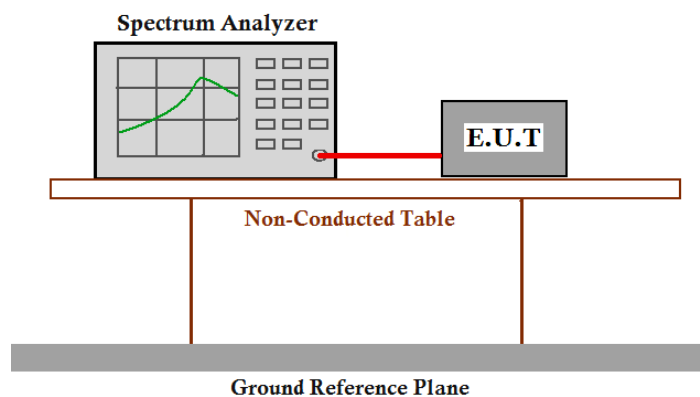

**Test Procedure:**

Set RBW of spectrum analyzer to 100 kHz and VBW of spectrum analyzer to 300 kHz with suitable frequency span including 10MHz bandwidth from band edge.

The band edges was measured and recorded Result:

The Lower Edges attenuated more than 20dB.

The Upper Edges attenuated more than 20dB.

The graph as below. Represents the emissions take for this device.

Low channel:

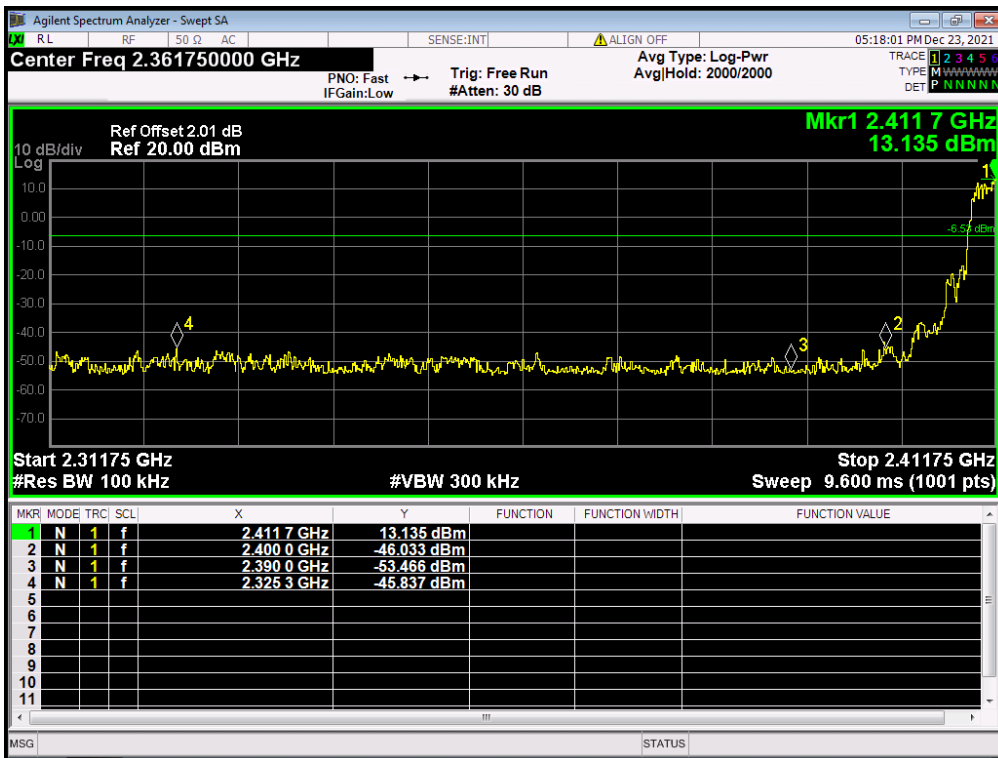

High channel:

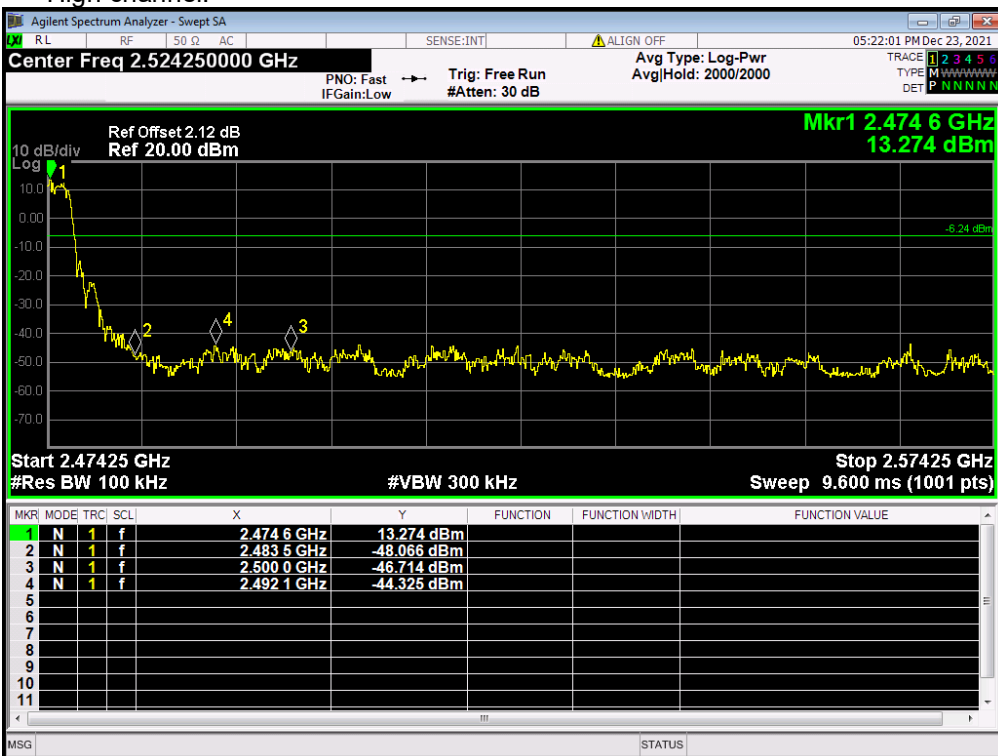

Test result: The unit does meet the FCC requirements.

## 5.12 Conducted Emissions at Mains Terminals 150 kHz to 30 MHz

**Test Requirement:** FCC Part 15 C section 15.207

**Test Method:** ANSI C63.10:2013 Clause 6.2

**Test Voltage:** N/A

**Frequency Range:** 150 kHz to 30 MHz

**Detector:** Peak for pre-scan (9 kHz Resolution Bandwidth)

### Test Limit

#### Limits for conducted disturbance at the mains ports of class B

Frequency Range	Class B Limit dB( $\mu$ V)	
	Quasi-peak	Average
0.15 to 0.50	66 to 56	56 to 46
0.50 to 5	56	46
5 to 30	60	50

NOTE 1 The limit decreases linearly with the logarithm of the frequency in the range 0,15 MHz to 0,50 MHz.

### EUT Operation:

Test in normal operating mode. For intentional radiators, measurements of the variation of the input power or the radiated signal level of the fundamental frequency component of the emission, as appropriate, shall be performed with the supply voltage varied between 85% and 115% of the nominal rated supply voltage.

Pre-Scan has been conducted to determine the worst-case mode from all possible combinations between available modulations, data rates and antenna ports (if EUT with antenna diversity architecture).

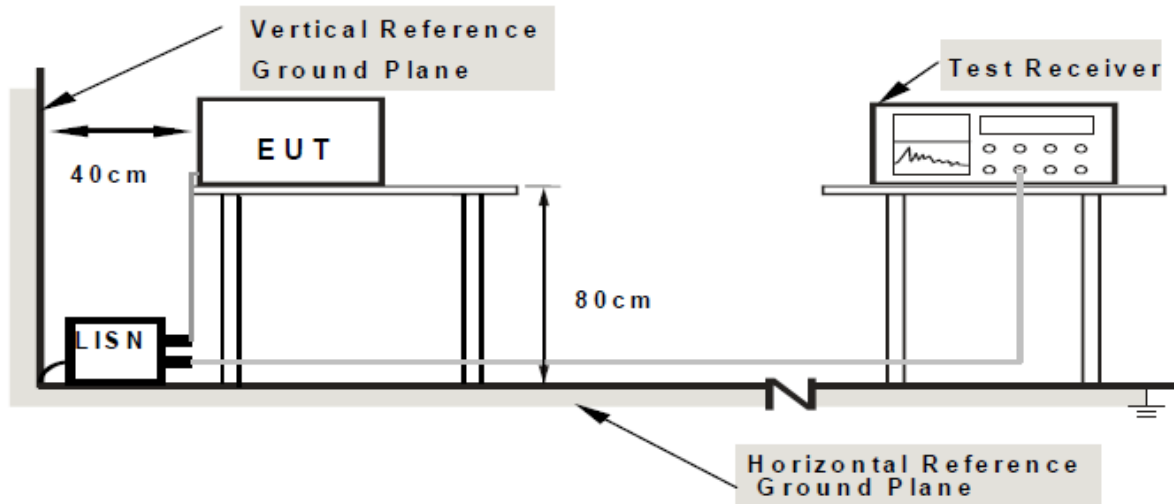
**Test Configuration:**

**Note: 1. Support units were connected to second LISN.**

**2. Both of LISNs (AMN) are 80 cm from EUT and at least 80 cm from other units and other metal planes**

**Test procedure:**

1. The mains terminal disturbance voltage test was conducted in a shielded room.
2. The tabletop EUT was placed upon a non-metallic table 0.8m above the ground reference plane. And for floor-standing arrangement, the EUT was placed on the horizontal ground reference plane, but separated from metallic contact with the ground reference plane by 0.1m of insulation.

**5.12.1 Measurement Data**

An initial pre-scan was performed on the live and neutral lines with peak detector. Quasi-Peak and Average measurement were performed at the frequencies with maximized peak emission were detected. For EUT the communicating was worst case mode.

**The following Quasi-Peak and Average measurements were performed on the EUT Live line**

Peak Scan:

Level (dB $\mu$ V)

/

Quasi-peak and Average measurement

/

**Neutral Line**

Peak Scan:

Level (dB $\mu$ V)

/

Quasi-peak and Average measurement

/

**5.13 Other requirements Frequency Hopping Spread Spectrum System**

**Test Requirement: 47 CFR Part 15C Section 15.247 (a)(1), (h) requirement**

The system shall hop to channel frequencies that are selected at the system hopping rate from a Pseudorandom ordered list of hopping frequencies. Each frequency must be used equally on the average by each transmitter. The system receivers shall have input bandwidths that match the hopping channel bandwidths of their corresponding transmitters and shall shift frequencies in synchronization with the transmitted signals.

Frequency hopping spread spectrum systems are not required to employ all available hopping channels during each transmission. However, the system, consisting of both the transmitter and the receiver, must be designed to comply with all of the regulations in this section should the transmitter be presented with a continuous data (or information) stream. In addition, a system employing short transmission bursts must comply with the definition of a frequency hopping system and must distribute its transmissions over the minimum number of hopping channels specified in this section.

The incorporation of intelligence within a frequency hopping spread spectrum system that permits the system to recognize other users within the spectrum band so that it individually and independently chooses and adapts its hopsets to avoid hopping on occupied channels is permitted.

The coordination of frequency hopping systems in any other manner for the express purpose of avoiding the simultaneous occupancy of individual hopping frequencies by multiple transmitters is not permitted.

**Compliance for section 15.247(a)(1)**

The pseudorandom sequence may be generated in a nine stage shift register whose 5th and 9th stage outputs are added in a modulo-two addition stage. And the result is fed back to the input of the first stage. The sequence begins with the first ONE of 9 consecutive ONES; i.e. the shift register is initialized with nine ones.

- Number of shift register stages: 9
- Length of pseudo-random sequence:  $2^9 - 1 = 511$  bits
- Longest sequence of zeros: 8 (non-inverted signal)

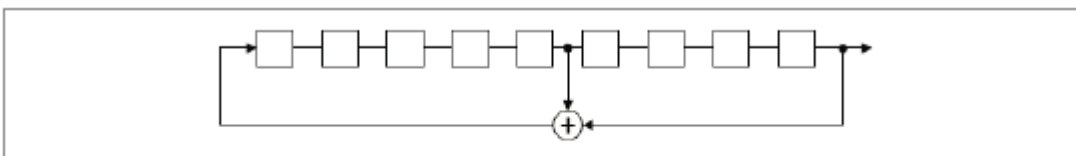

*Linear Feedback Shift Register for Generation of the PRBS sequence*

An example of Pseudorandom Frequency Hopping Sequence as follow:

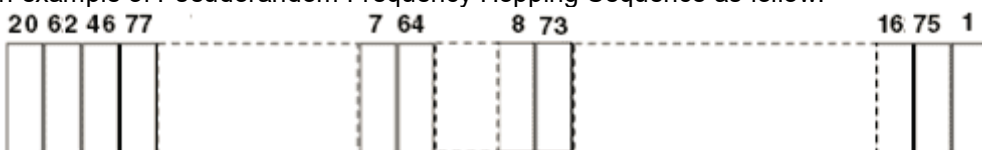

Each frequency used equally on the average by each transmitter.

The receivers are designed to have input and IF bandwidths that match the hopping channel bandwidths of any transmitters and shift frequencies in synchronization with the transmitted signals.



**Compliance for section 15.247(g)**

The system transmits the packet with the pseudorandom hopping frequency with a continuous data and the short burst transmission from the system is also transmitted under the frequency hopping system with the pseudorandom hopping frequency system.

**Compliance for section 15.247(h)**

The system incorporates with an adaptive system to detect other user within the spectrum band so that it individually and independently to avoid hopping on the occupied channels. The system is designed not have the ability to coordinated with other FHSS System in an effort to avoid the simultaneous occupancy of individual hopping frequencies by multiple transmitter.

**--End of Report--**