



FCC TEST REPORT

**Test report
On Behalf of
Shenzhen Suichen Technology Co. Ltd.
For
Wireless pico projector
Model No.: P105GW
FCC ID: 2ATVI-P105GW**

Prepared for : Shenzhen Suichen Technology Co. Ltd.
12A01, Yunsong building, No.33, Tairan 8, Tian'an community, Shatou street,
Futian District, Shenzhen, China

Prepared By : Shenzhen HUAKE Testing Technology Co., Ltd.
1F, B2 Building, Junfeng Zhongcheng Zhizao Innovation Park, Fuhai Street,
Bao'an District, Shenzhen City, China

Date of Test: Aug. 21, 2019 ~ Aug. 28, 2019

Date of Report: Aug. 28, 2019

Report Number: HK1908162016-3E



TEST RESULT CERTIFICATION

Applicant's name: Shenzhen Suichen Technology Co. Ltd.
Address: 12A01, Yunsong building, No.33, Tairan 8, Tian'an community,
Shatou street, Futian District, Shenzhen, China
Manufacture's Name.....: Shenzhen Suichen Technology Co. Ltd.
Address: 12A01, Yunsong building, No.33, Tairan 8, Tian'an community,
Shatou street, Futian District, Shenzhen, China

Product description

Trade Mark: N/A
Product name.....: Wireless pico projector
Model and/or type reference : P105GW
Standards: FCC Rules and Regulations Part 15 Subpart C Section 15.247
ANSI C63.10: 2013

This publication may be reproduced in whole or in part for non-commercial purposes as long as the Shenzhen HUAK Testing Technology Co., Ltd. is acknowledged as copyright owner and source of the material. Shenzhen HUAK Testing Technology Co., Ltd. takes no responsibility for and will not assume liability for damages resulting from the reader's interpretation of the reproduced material due to its placement and context.

Date of Test:
Date (s) of performance of tests: Aug. 21, 2019 ~ Aug. 28, 2019
Date of Issue.....: Aug. 28, 2019
Test Result.....: **Pass**

Testing Engineer : 

(Gary Qian)
Technical Manager : 

(Eden Hu)
Authorized Signatory : 

(Jason Zhou)



TABLE OF CONTENTS

1. Test Result Summary	4
1.1. TEST PROCEDURES AND RESULTS.....	4
1.2. TEST FACILITY	4
1.3. MEASUREMENT UNCERTAINTY	5
2. EUT Description	6
2.1. GENERAL DESCRIPTION OF EUT	6
2.2. CARRIER FREQUENCY OF CHANNELS	7
2.3. OPERATION OF EUT DURING TESTING	7
2.4. DESCRIPTION OF TEST SETUP	8
3. General Information	9
3.1. TEST ENVIRONMENT AND MODE	9
3.2. DESCRIPTION OF SUPPORT UNITS	10
4. Test Results and Measurement Data	11
4.1. CONDUCTED EMISSION	11
4.2. MAXIMUM CONDUCTED OUTPUT POWER	15
4.3. EMISSION BANDWIDTH.....	17
4.4. POWER SPECTRAL DENSITY	28
4.5. CONDUCTED BAND EDGE AND SPURIOUS EMISSION MEASUREMENT	40
4.6. RADIATED SPURIOUS EMISSION MEASUREMENT	50
4.7. ANTENNA REQUIREMENT	76
4.8. PHOTOS OF THE EUT	79



1. Test Result Summary

1.1. TEST PROCEDURES AND RESULTS

Requirement	CFR 47 Section	Result
Antenna requirement	§15.203/§15.247 (c)	PASS
AC Power Line Conducted Emission	§15.207	PASS
Conducted Peak Output Power	§15.247 (b)(3) §2.1046	PASS
6dB Emission Bandwidth	§15.247 (a)(2) §2.1049	PASS
Power Spectral Density	§15.247 (e)	PASS
Band Edge	§15.247(d) §2.1051, §2.1057	PASS
Spurious Emission	§15.205/§15.209 §2.1053, §2.1057	PASS

Note:

1. PASS: Test item meets the requirement.
2. Fail: Test item does not meet the requirement.
3. N/A: Test case does not apply to the test object.
4. The test result judgment is decided by the limit of test standard.

1.2. TEST FACILITY

Test Firm : Shenzhen HUAKE Testing Technology Co., Ltd.

Address : 1F, B2 Building, Junfeng Zhongcheng Zhizao Innovation Park, Fuhai Street, Bao'an District, Shenzhen City, China



1.3. Measurement Uncertainty

The reported uncertainty of measurement $y \pm U$, where expanded uncertainty U is based on a standard uncertainty multiplied by a coverage factor of $k=2$, providing a level of confidence of approximately 95 %.

No.	Item	MU
1	Conducted Emission	$\pm 2.56\text{dB}$
2	RF power, conducted	$\pm 0.12\text{dB}$
3	Spurious emissions, conducted	$\pm 0.11\text{dB}$
4	All emissions, radiated(<1G)	$\pm 3.92\text{dB}$
5	All emissions, radiated(>1G)	$\pm 4.28\text{dB}$
6	Temperature	$\pm 0.1^\circ\text{C}$
7	Humidity	$\pm 1.0\%$



2. EUT Description

2.1. GENERAL DESCRIPTION OF EUT

Equipment	Wireless pico projector
Model Name	P105GW
Serial Model	N/A
Model Difference	All model's the function, software and electric circuit are the same, only with a product color and model named different. Test sample model: P105GW
Trade Mark	N/A
FCC ID	2ATVI-P105GW
Antenna Type	Internal Antenna
Antenna Gain	Antenna 1:1dBi Antenna 2:1dBi MIMO: 4.010dBi
Operation frequency	802.11b/g/n 20:2412~2462 MHz 802.11n 40: 2422~2452MHz
Number of Channels	802.11b/g/n20: 11CH 802.11n 40: 7CH
Modulation Type	CCK/OFDM/DBPSK/DAPSK
Power Source	DC7.6V from battery or DC12V from adapter With AC100-240V~50-60Hz, 1.0A Max
Power Rating	DC7.6V from battery or DC12V from adapter With AC100-240V~50-60Hz, 1.0A Max
Note: The EUT incorporates a MIMO function. Physically, it provides two completed transmitters and receivers(2T2R), two transmit signals are completely correlated, then, Direction gain= $GANT+10*\log(2)$ dBi.	



2.2. Carrier Frequency of Channels

Channel List for 802.11b/802.11g/802.11n (HT20)							
Channel	Frequency (MHz)	Channel	Frequency (MHz)	Channel	Frequency (MHz)	Channel	Frequency (MHz)
01	2412	04	2427	07	2442	10	2457
02	2417	05	2432	08	2447	11	2462
03	2422	06	2437	09	2452		

Channel List For 802.11n (HT40)							
Channel	Frequency (MHz)	Channel	Frequency (MHz)	Channel	Frequency (MHz)	Channel	Frequency (MHz)
--	--	04	2427	07	2442	--	--
--	--	05	2432	08	2447	--	--
03	2422	06	2437	09	2452		

Note:

In section 15.31(m), regards to the operating frequency range over 10 MHz, the Lowest frequency, the middle frequency, and the highest frequency of channel were selected to perform the test, and the selected channel see below:

2.3. Operation of EUT during testing

Operating Mode

The mode is used: **Transmitting mode for 802.11b/802.11g/802.11n (HT20)**

Low Channel: 2412MHz

Middle Channel: 2437MHz

High Channel: 2462MHz

The mode is used: **Transmitting mode for 802.11n (HT40)**

Low Channel: 2422MHz

Middle Channel: 2437MHz

High Channel: 2452MHz



2.4. DESCRIPTION OF TEST SETUP

Operation of EUT during conducted testing and Radiation testing:



Operation of EUT during Above 1GHz Radiation testing:



- Adapter information
Model: AD40ACH120300
Input: 100-240V~, 50/60Hz, 1.0A Max.
Output: 12VDC, 3.0A
- PC information
Model: TP00067A
Input: DC20V, 2.25/3.25A
Output: 5VDC, 1A



3. Genera Information

3.1. Test environment and mode

Operating Environment:	
Temperature:	25.0 °C
Humidity:	56 % RH
Atmospheric Pressure:	1010 mbar
Test Mode:	
Engineering mode:	Keep the EUT in continuous transmitting by select channel and modulations(The value of duty cycle is 98.46%)
The sample was placed (0.8m below 1GHz, 1.5m above 1GHz) above the ground plane of 3m chamber. Measurements in both horizontal and vertical polarities were performed. During the test, each emission was maximized by: having the EUT continuously working, investigated all operating modes, rotated about all 3 axis (X, Y & Z) and considered typical configuration to obtain worst position, manipulating interconnecting cables, rotating the turntable, varying antenna height from 1m to 4m in both horizontal and vertical polarizations. The emissions worst-case are shown in Test Results of the following pages. For the full battery state and The output power to the maximum state.	

We have verified the construction and function in typical operation. All the test modes were carried out with the EUT in transmitting operation, which was shown in this test report and defined as follows:

Per-scan all kind of data rate in lowest channel, and found the follow list which it was worst case.

Mode	Data rate
802.11b	1Mbps
802.11g	6Mbps
802.11n(H20)	6.5Mbps
802.11n(H40)	13.5Mbps

Final Test Mode:

Operation mode:	Keep the EUT in continuous transmitting with modulation
1. For WIFI function, the engineering test program was provided and enabled to make EUT continuous transmit/receive.	
2. According to ANSI C63.10 standards, the test results are both the “worst case” and “worst setup” 1Mbps for 802.11b, 6Mbps for 802.11g, 6.5Mbps for 802.11n(H20), 13.5Mbps for 802.11(H40). Duty cycle setting during the transmission is 98.5% with maximum power setting for all modulations.	



3.2. Description of Support Units

The EUT has been tested as an independent unit together with other necessary accessories or support units. The following support units or accessories were used to form a representative test configuration during the tests.

Equipment	Model No.	Serial No.	FCC ID	Trade Name
/	/	/	/	/

Note:

- 1. All the equipment/cables were placed in the worst-case configuration to maximize the emission during the test.*
- 2. Grounding was established in accordance with the manufacturer's requirements and conditions for the intended use.*
- 3. For conducted measurements (Output Power, 6dB Emission Bandwidth, Power Spectral Density, Spurious Emissions), the antenna of EUT is connected to the test equipment via temporary antenna connector, the antenna connector is soldered on the antenna port of EUT, and the temporary antenna connector is listed in the Test Instruments.*



4. Test Results and Measurement Data

4.1. Conducted Emission

4.1.1. Test Specification

Test Requirement:	FCC Part15 C Section 15.207														
Test Method:	ANSI C63.10:2013														
Frequency Range:	150 kHz to 30 MHz														
Receiver setup:	RBW=9 kHz, VBW=30 kHz, Sweep time=auto														
Limits:	<table border="1"> <thead> <tr> <th rowspan="2">Frequency range (MHz)</th> <th colspan="2">Limit (dBuV)</th> </tr> <tr> <th>Quasi-peak</th> <th>Average</th> </tr> </thead> <tbody> <tr> <td>0.15-0.5</td> <td>66 to 56*</td> <td>56 to 46*</td> </tr> <tr> <td>0.5-5</td> <td>56</td> <td>46</td> </tr> <tr> <td>5-30</td> <td>60</td> <td>50</td> </tr> </tbody> </table>	Frequency range (MHz)	Limit (dBuV)		Quasi-peak	Average	0.15-0.5	66 to 56*	56 to 46*	0.5-5	56	46	5-30	60	50
Frequency range (MHz)	Limit (dBuV)														
	Quasi-peak	Average													
0.15-0.5	66 to 56*	56 to 46*													
0.5-5	56	46													
5-30	60	50													
Test Setup:	<p><i>Remark</i> <i>E.U.T: Equipment Under Test</i> <i>LISN: Line Impedance Stabilization Network</i> <i>Test table height=0.8m</i></p>														
Test Mode:	Charging + transmitting with modulation														
Test Procedure:	<ol style="list-style-type: none"> 1. The E.U.T is connected to the main power through a line impedance stabilization network (L.I.S.N.). This provides a 50ohm/50uH coupling impedance for the measuring equipment. 2. The peripheral devices are also connected to the main power through a LISN that provides a 50ohm/50uH coupling impedance with 50ohm termination. (Please refer to the block diagram of the test setup and photographs). 3. Both sides of A.C. line are checked for maximum conducted interference. In order to find the maximum emission, the relative positions of equipment and all of the interface cables must be changed according to ANSI C63.10: 2013 on conducted measurement. 														
Test Result:	PASS														



4.1.2. Test Instruments

Conducted Emission Shielding Room Test Site (843)				
Equipment	Manufacturer	Model	Serial Number	Calibration Due
Wireless pico projector	R&S	P105GW	HKE-010	Dec. 27, 2019
LISN	R&S	ENV216	HKE-002	Dec. 27, 2019
Conducted test software	Tonscend	TS+ Rev 2.5.0.0	HKE-081	N/A

Note: The calibration interval of the above test instruments is 12 months and the calibrations are traceable to international system unit (SI).



4.1.3. Test data

All the test modes completed for test. only the worst result of AC240V/60Hz(802.11b at 2412MHz) was reported as below:

Conducted Emission on Line Terminal of the power line (150 kHz to 30MHz)

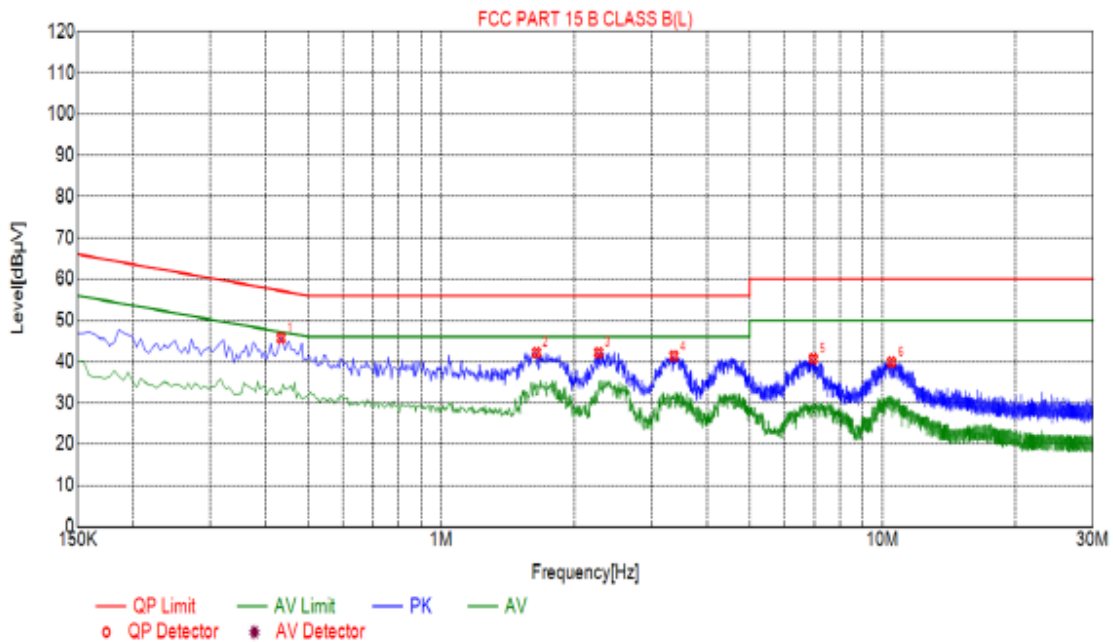

Suspected List						
NO.	F req. [MHz]	Level [dBμV]	Factor [dB]	Limit [dBμV]	Margin [dB]	Detector
1	0.4335	45.73	10.05	57.19	11.46	PK
2	1.6440	42.23	10.12	56.00	13.77	PK
3	2.2740	42.22	10.18	56.00	13.78	PK
4	3.3675	41.37	10.24	56.00	14.63	PK
5	6.9720	40.64	10.20	60.00	19.36	PK
6	10.4865	39.93	10.04	60.00	20.07	PK

Remark: Transd = Cable lose + Antenna factor - Pre-amplifier; Margin = Limit – Level



Conducted Emission on Neutral Terminal of the power line (150 kHz to 30MHz)

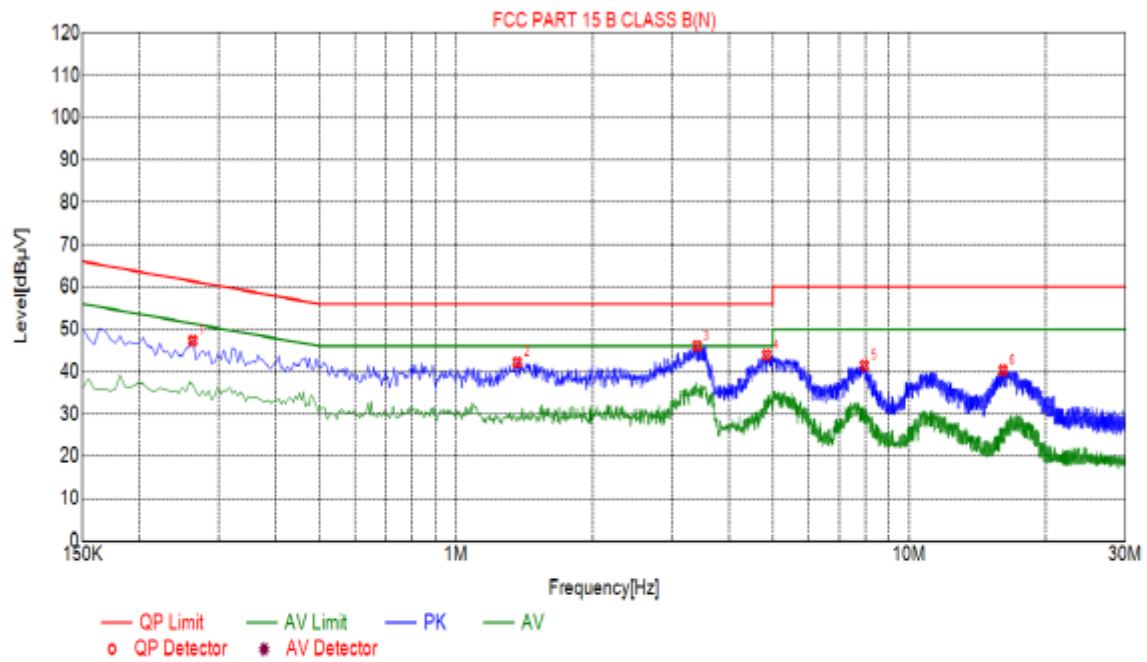

Suspected List						
NO.	F req. [MHz]	Level [dBµV]	Factor [dB]	Limit [dBµV]	Margin [dB]	Detector
1	0.2625	47.26	10.03	61.35	14.09	PK
2	1.3650	42.24	10.11	56.00	13.76	PK
3	3.4035	46.10	10.24	56.00	9.90	PK
4	4.8435	43.95	10.26	56.00	12.05	PK
5	7.9620	41.44	10.15	60.00	18.56	PK
6	16.1115	40.30	9.98	60.00	19.70	PK

Remark: Transd = Cable lose + Antenna factor - Pre-amplifier; Margin = Limit – Level



4.2. Maximum Conducted Output Power

4.2.1. Test Specification

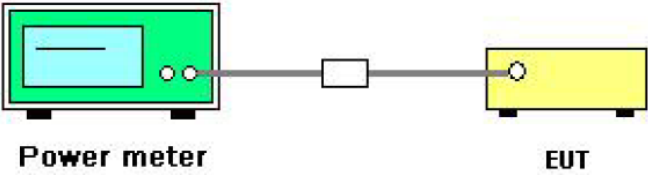
Test Requirement:	FCC Part15 C Section 15.247 (b)(3)
Test Method:	KDB 558074
Limit:	30dBm
Test Setup:	 <p>The diagram shows a green Power meter connected to a yellow EUT. A white attenuator is placed between them, connected by a grey RF cable. The Power meter has two ports on its right side, and the EUT has one port on its left side.</p>
Test Mode:	Transmitting mode with modulation
Test Procedure:	<ol style="list-style-type: none"> 1. The testing follows the Measurement Procedure of FCC KDB No. 558074 DTS D01 Meas. Guidance v05. 2. The RF output of EUT was connected to the power meter by RF cable and attenuator. The path loss was compensated to the results for each measurement. 3. Set to the maximum power setting and enable the EUT transmit continuously. 4. Measure the Peak output power and record the results in the test report.
Test Result:	PASS

4.2.2. Test Instruments

RF Test Room				
Equipment	Manufacturer	Model	Serial Number	Calibration Due
Power meter	Agilent	E4419B	HKE-085	Dec. 27, 2019
Power Sensor	Agilent	E9300A	HKE-086	Dec. 27, 2019
RF cable	Times	1-40G	HKE-034	Dec. 27, 2019
RF automatic control unit	Tonscend	JS0806-2	HKE-060	Dec. 27, 2019

Note: The calibration interval of the above test instruments is 12 months and the calibrations are traceable to international system unit (SI).



4.2.3. Test Data

Test Channel	Frequency	Maximum Peak Conducted Output Power (dBm)			LIMIT
	(MHz)	Antenna port 1	Antenna port 2	MIMO	dBm
TX 802.11b Mode					
CH01	2412	14.11	14.63	/	30
CH06	2437	14.35	14.03	/	30
CH11	2462	14.42	14.75	/	30
TX 802.11g Mode					
CH01	2412	12.25	12.14	/	30
CH06	2437	12.37	12.52	/	30
CH11	2462	13.04	12.37	/	30
TX 802.11n20 Mode					
CH01	2412	10.55	10.24	13.41	30
CH06	2437	10.36	10.53	13.46	30
CH11	2462	10.75	10.18	13.48	30
TX 802.11n40 Mode					
CH03	2422	9.45	10.25	12.88	30
CH06	2437	9.12	9.06	12.10	30
CH09	2452	9.34	9.19	12.28	30
Note: This product supports antenna 1 and antenna 2 launch, but only support 802.11 n for MIMO mode, not support 802.11 b and 802.11 g for MIMO mode.					



4.3. Emission Bandwidth

4.3.1. Test Specification

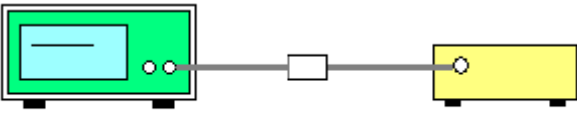
Test Requirement:	FCC Part15 C Section 15.247 (a)(2)
Test Method:	KDB 558074
Limit:	>500kHz
Test Setup:	 <p style="text-align: center;">Spectrum Analyzer EUT</p>
Test Mode:	Transmitting mode with modulation
Test Procedure:	<ol style="list-style-type: none"> 1. The testing follows FCC KDB Publication No. 558074 DTS D01 Meas. Guidance v05. 2. Set to the maximum power setting and enable the EUT transmit continuously. 3. Make the measurement with the spectrum analyzer's resolution bandwidth (RBW) = 100 kHz. Set the Video bandwidth (VBW) = 300 kHz. In order to make an accurate measurement. The 6dB bandwidth must be greater than 500 kHz. 4. Measure and record the results in the test report.
Test Result:	PASS

4.3.2. Test Instruments

RF Test Room				
Equipment	Manufacturer	Model	Serial Number	Calibration Due
Spectrum analyzer	Agilent	N9020A	HKE-048	Dec. 27, 2019
RF Cable (9KHz-26.5GHz)	Tonscend	170660	N/A	Dec. 27, 2019
RF automatic control unit	Tonscend	JS0806-2	HKE-060	Dec. 27, 2019

Note: The calibration interval of the above test instruments is 12 months and the calibrations are traceable to international system unit (SI).

**4.3.3. Test data****For antenna port 1**

Test channel	6dB Emission Bandwidth (MHz)			
	802.11b	802.11g	802.11n(H20)	802.11n(H40)
Lowest	10.11	16.39	17.63	35.77
Middle	10.11	16.43	17.63	36.13
Highest	9.636	16.43	17.62	36.03
Limit:	>500k			
Test Result:	PASS			

Test plots as follows:



802.11b Modulation

Lowest channel

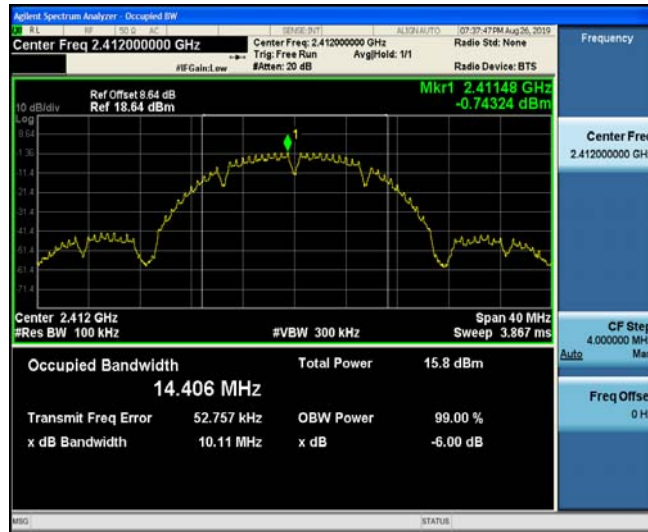

Middle channel



Highest channel





802.11g Modulation

Lowest channel



Middle channel

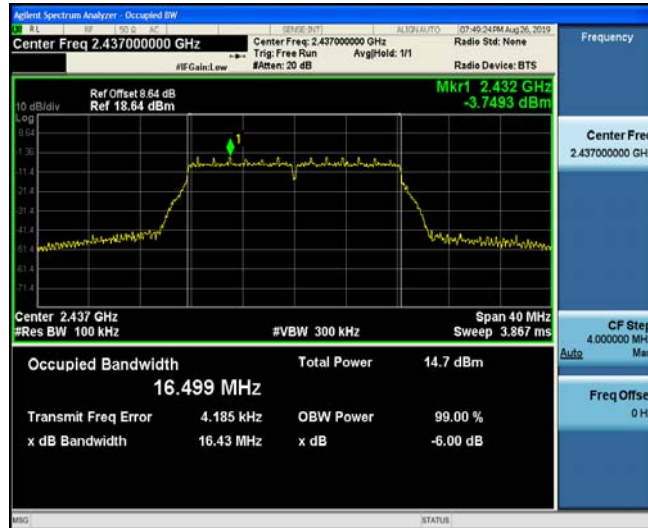

Highest channel

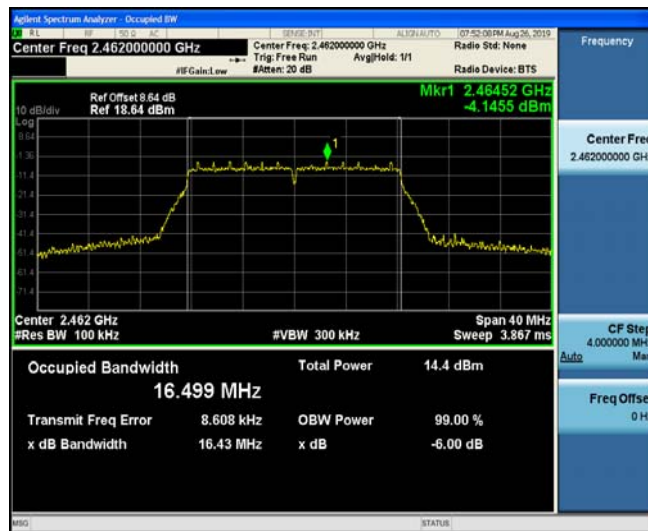



802.11n (HT20) Modulation

Lowest channel

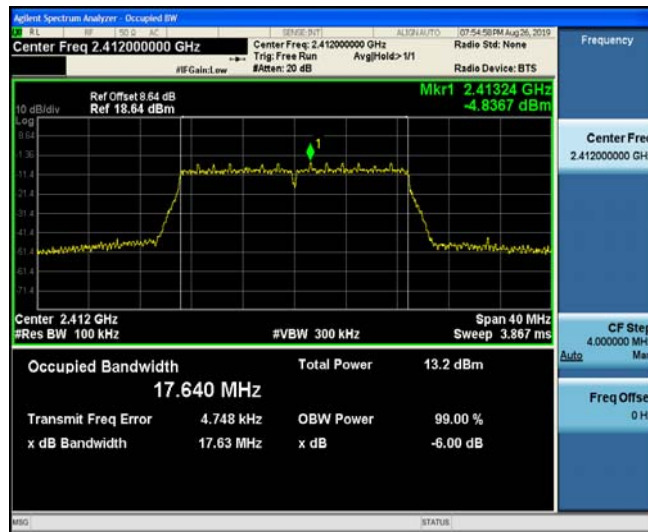

Middle channel



Highest channel





802.11n (HT40) Modulation

Lowest channel

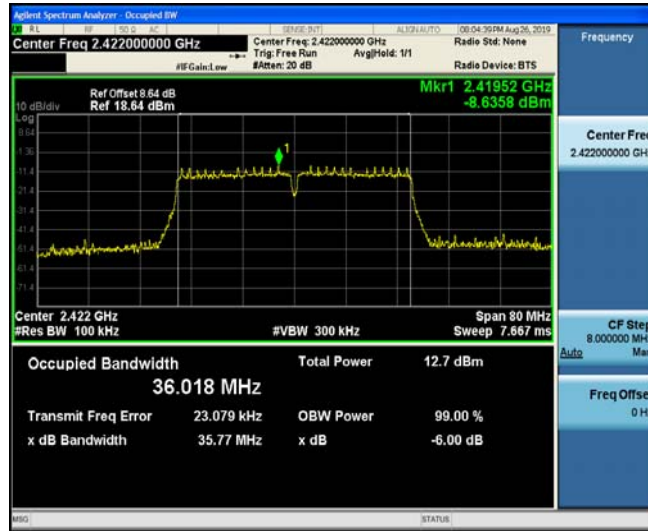

Middle channel

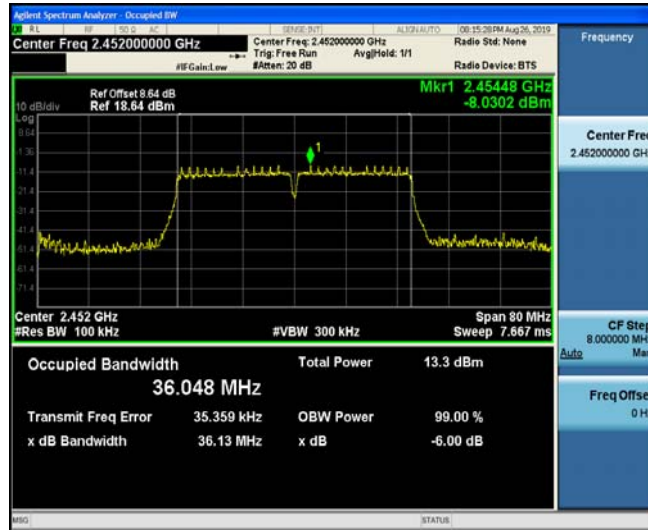

Highest channel

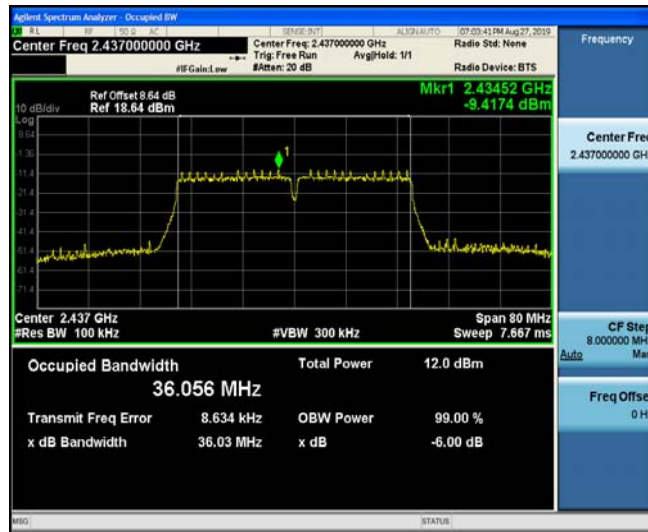

**For antenna port 2**

Test channel	6dB Emission Bandwidth (MHz)			
	802.11b	802.11g	802.11n(H20)	802.11n(H40)
Lowest	10.09	16.40	17.64	36.11
Middle	10.11	16.40	17.62	36.12
Highest	10.10	16.38	17.65	36.12
Limit:	≥500 (kHz)			
Test Result:	PASS			

Test plots as follows:



802.11b Modulation

Lowest channel

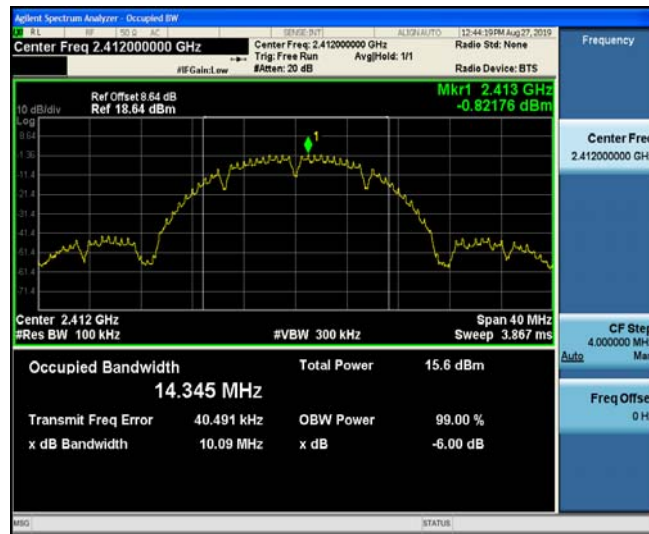

Middle channel

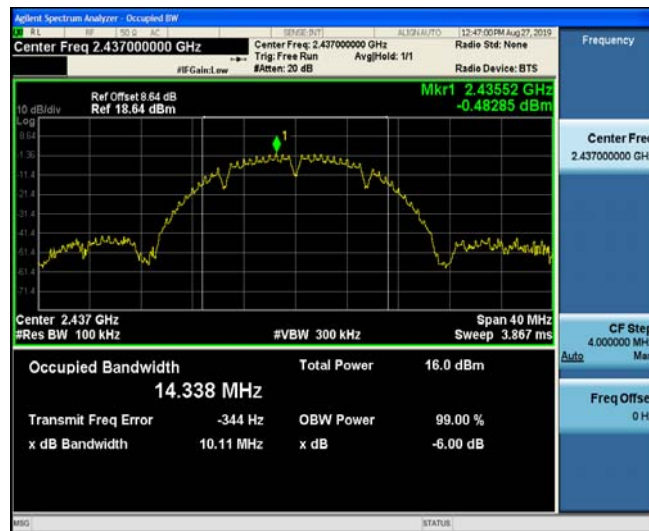

Highest channel





802.11g Modulation

Lowest channel



Middle channel

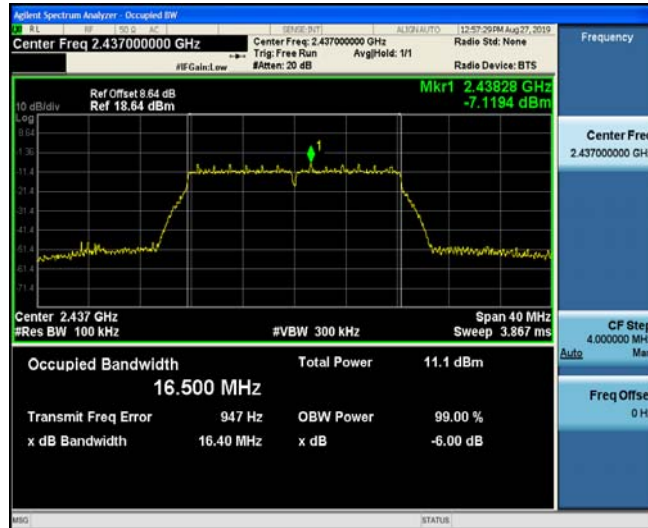

Highest channel

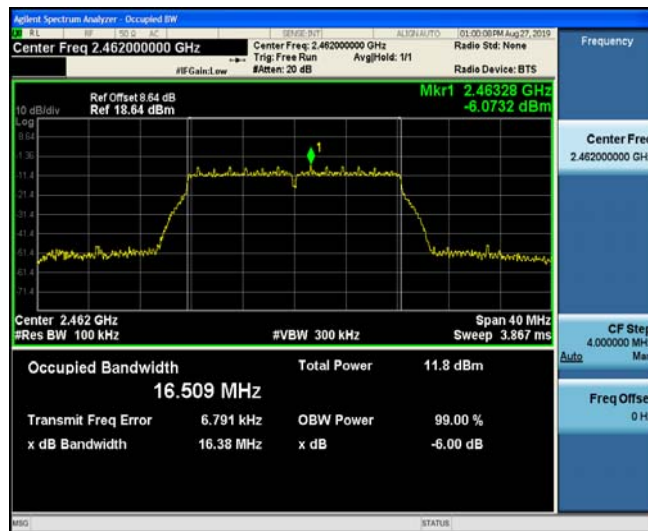



802.11n (HT20) Modulation

Lowest channel

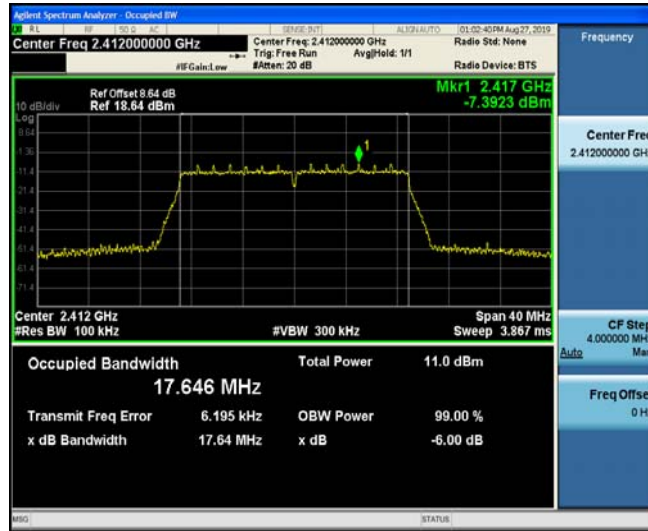

Middle channel

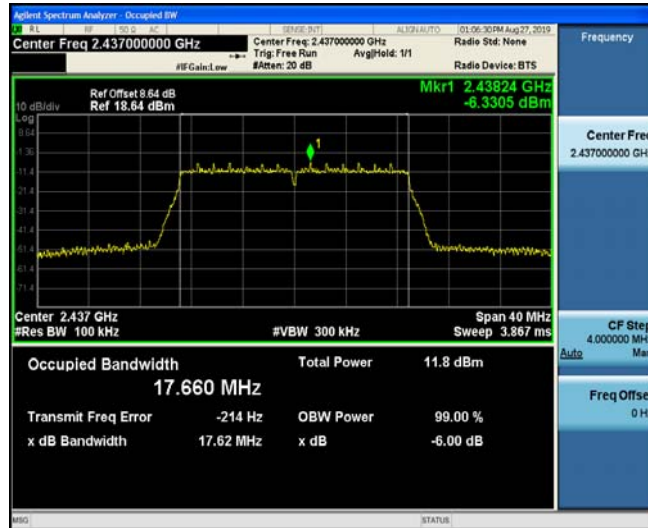

Highest channel

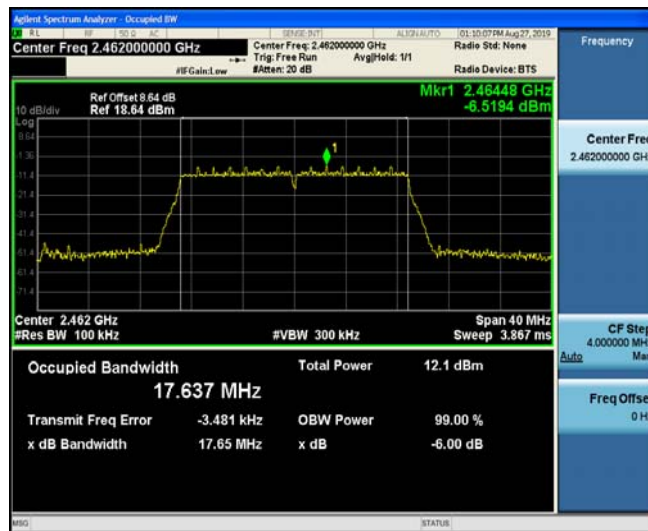



802.11n (HT40) Modulation

Lowest channel

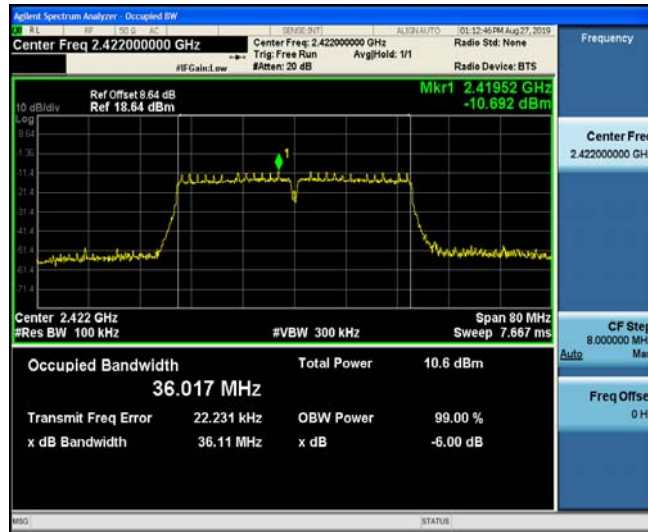

Middle channel



Highest channel

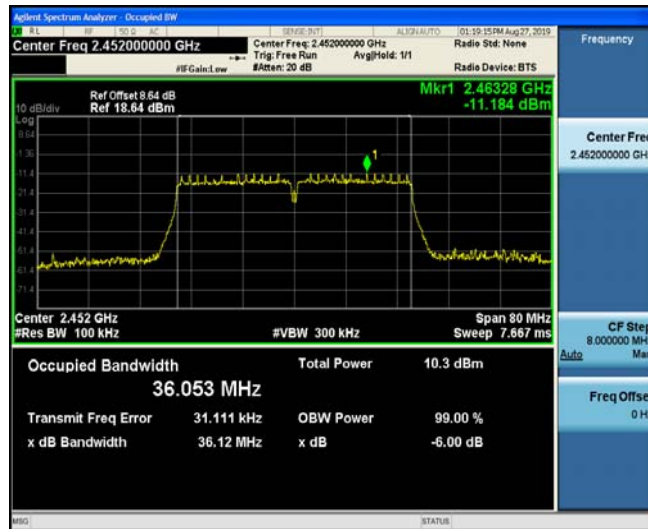



4.4. Power Spectral Density

4.4.1. Test Specification

Test Requirement:	FCC Part15 C Section 15.247 (e)
Test Method:	KDB 558074
Limit:	The average power spectral density shall not be greater than 8dBm in any 3kHz band at any time interval of continuous transmission.
Test Setup:	<p style="text-align: center;">Spectrum Analyzer EUT</p>
Test Mode:	Transmitting mode with modulation
Test Procedure:	<ol style="list-style-type: none"> 1. The testing follows Measurement procedure 10.2 method PKPSD of FCC KDB Publication No.558074 D01 DTS Meas. Guidance v05 2. The RF output of EUT was connected to the spectrum analyzer by RF cable and attenuator. The path loss was compensated to the results for each measurement. 3. Set to the maximum power setting and enable the EUT transmit continuously. 4. Make the measurement with the spectrum analyzer's resolution bandwidth (RBW): $3\text{ kHz} \leq \text{RBW} \leq 100\text{ kHz}$. Video bandwidth $\text{VBW} \geq 3 \times \text{RBW}$. Set the span to at least 1.5 times the OBW. 5. Detector = Peak, Sweep time = auto couple. 6. Employ trace averaging (Peak) mode over a minimum of 100 traces. Use the peak marker function to determine the maximum power level. 6. Measure and record the results in the test report.
Test Result:	PASS

4.4.2. Test Instruments

RF Test Room				
Equipment	Manufacturer	Model	Serial Number	Calibration Due
Spectrum analyzer	Agilent	N9020A	HKE-048	Dec. 27, 2019
RF Cable (9KHz-26.5GHz)	Tonscend	170660	N/A	Dec. 27, 2019
RF automatic control unit	Tonscend	JS0806-2	HKE-060	Dec. 27, 2019

Note: The calibration interval of the above test instruments is 12 months and the calibrations are traceable to international system unit (SI).



4.4.3. Test data

For antenna port 1

EUT Set Mode	Channel	Result (dBm/30kHz)	Result (dBm/3kHz)
802.11b	Lowest	-0.62	-10.62
	Middle	-4.83	-14.83
	Highest	-3.32	-13.32
802.11g	Lowest	-9.04	-19.04
	Middle	-8.56	-18.56
	Highest	-8.4	-18.4
802.11n(H20)	Lowest	-9.96	-19.96
	Middle	-8.99	-18.99
	Highest	-8.5	-18.5
802.11n(H40)	Lowest	-14.29	-24.29
	Middle	-13.35	-23.35
	Highest	-14.67	-24.67
PSD test result (dBm/3kHz)= PSD test result (dBm/30kHz)-10			
Limit: 8dBm/3kHz			
Test Result:	PASS		

Test plots as follows:



802.11b Modulation

Lowest channel



Middle channel



Highest channel





802.11g Modulation

Lowest channel



Middle channel



Highest channel





802.11n (HT20) Modulation

Lowest channel



Middle channel



Highest channel





802.11n (HT40) Modulation

Lowest channel



Middle channel



Highest channel



**For antenna port 2**

EUT Set Mode	Channel	Result (dBm/30kHz)	Result (dBm/3kHz)
802.11b	Lowest	-3.25	-13.25
	Middle	-5.33	-15.33
	Highest	-4.06	-14.06
802.11g	Lowest	-8.38	-18.38
	Middle	-11.99	-21.99
	Highest	-10.77	-20.77
802.11n(H20)	Lowest	-11.69	-21.69
	Middle	-10.79	-20.79
	Highest	-10.71	-20.71
802.11n(H40)	Lowest	-15.57	-25.57
	Middle	-16.49	-26.49
	Highest	-16.19	-26.19
PSD test result (dBm/3kHz)= PSD test result (dBm/30kHz)-10			
Limit: 8dBm/3kHz			
Test Result:	PASS		

Test plots as follows:



802.11b Modulation

Lowest channel



Middle channel



Highest channel





802.11g Modulation

Lowest channel



Middle channel

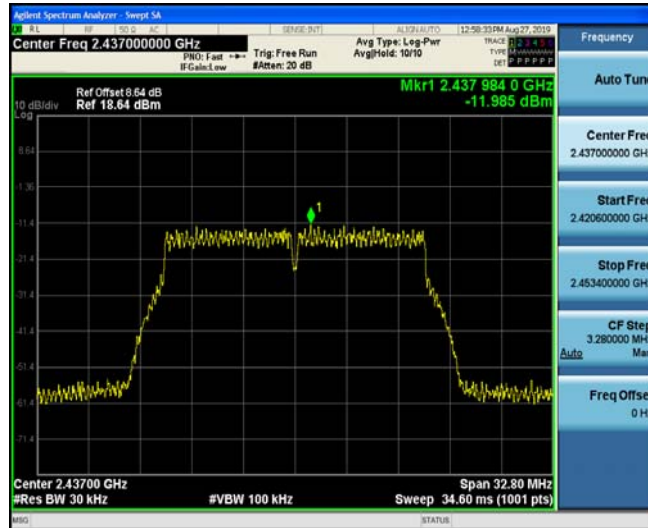

Highest channel





802.11n (HT20) Modulation

Lowest channel



Middle channel



Highest channel

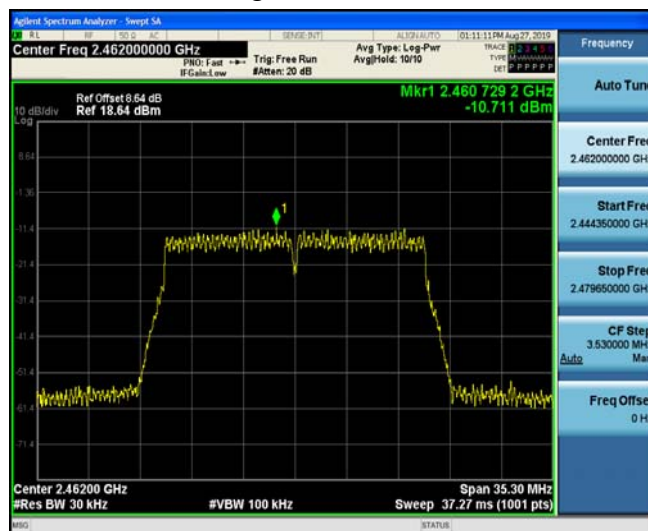



802.11n (HT40) Modulation

Lowest channel

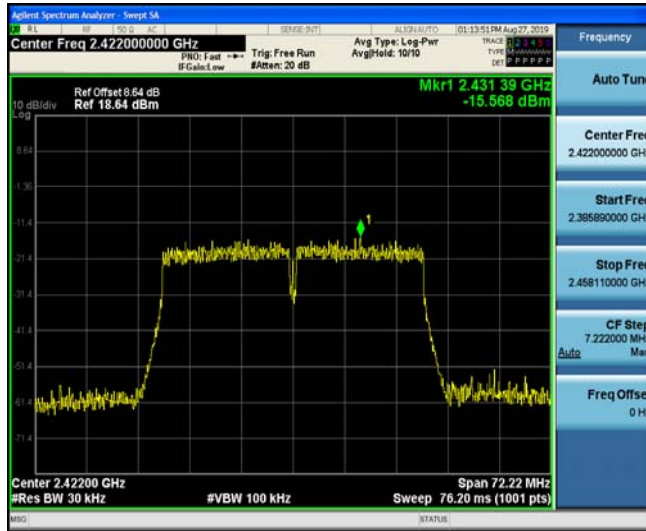

Middle channel



Highest channel

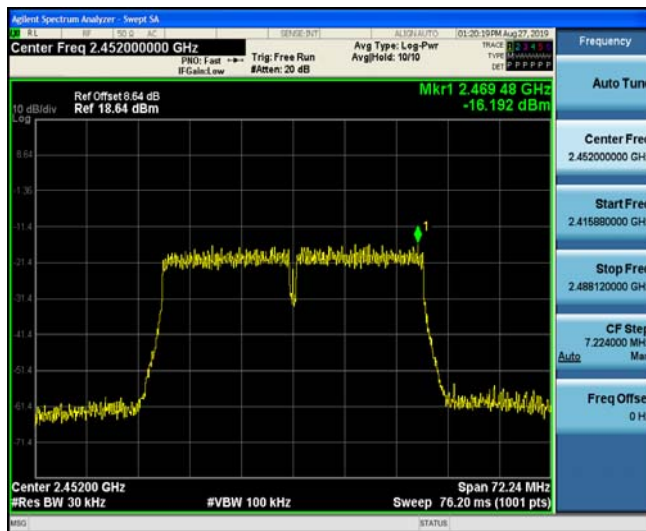

**For MIMO antenna port 1+antenna port 2**

TX 802.11b Mode			
Frequency	Power Density (dBm)	Limit (dBm)	Result
2412 MHz	/	8	/
2437 MHz	/	8	/
2462 MHz	/	8	/
TX 802.11g Mode			
2412 MHz	/	8	/
2437 MHz	/	8	/
2462 MHz	/	8	/
TX 802.11n/HT20 Mode			
2412 MHz	-7.73	8	PASS
2437 MHz	-6.79	8	PASS
2462 MHz	-6.46	8	PASS
TX 802.11n/HT40 Mode			
2422 MHz	-11.87	8	PASS
2437 MHz	-11.63	8	PASS
2452 MHz	-12.35	8	PASS
Note: 1 According to KDB 662911, Result power = $10\log(10^{(ant1/10)}+10^{(ant2/10)})$. 2 Result unit: W, The end result is converted to units of dBm.			

Note: This product supports antenna 1 and antenna 2 launch, but only support 802.11 n for MIMO mode, not support 802.11 b and 802.11 g for MIMO mode.



4.5. Conducted Band Edge and Spurious Emission Measurement

4.5.1. Test Specification

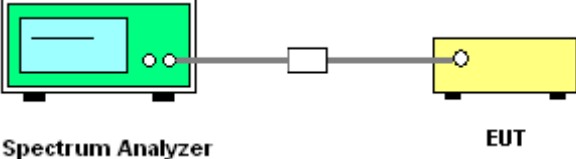
Test Requirement:	FCC Part15 C Section 15.247 (d)
Test Method:	KDB558074
Limit:	In any 100 kHz bandwidth outside of the authorized frequency band, the emissions which fall in the non-restricted bands shall be attenuated at least 20 dB / 30dB relative to the maximum PSD level in 100 kHz by RF conducted measurement and radiated emissions which fall in the restricted bands, as defined in Section 15.205(a), must also comply with the radiated emission limits specified in Section 15.209(a).
Test Setup:	 <p>The diagram illustrates the test setup. On the left is a Spectrum Analyzer with a green screen and a blue panel. A grey cable connects it to a small white rectangular attenuator. Another grey cable connects the attenuator to a yellow rectangular Equipment Under Test (EUT).</p> <p>Spectrum Analyzer EUT</p>
Test Mode:	Transmitting mode with modulation
Test Procedure:	<ol style="list-style-type: none">1. The testing follows FCC KDB Publication No. 558074 D01 DTS Meas. Guidance v05.2. The RF output of EUT was connected to the spectrum analyzer by RF cable and attenuator. The path loss was compensated to the results for each measurement.3. Set to the maximum power setting and enable the EUT transmit continuously.4. Set RBW = 100 kHz, VBW=300 kHz, Peak Detector. Unwanted Emissions measured in any 100 kHz bandwidth outside of the authorized frequency band shall be attenuated by at least 20 dB relative to the maximum in-band peak PSD level in 100 kHz when maximum peak conducted output power procedure is used. If the transmitter complies with the conducted power limits based on the use of RMS averaging over a time interval, the attenuation required under this paragraph shall be 30 dB instead of 20 dB per 15.247(d).5. Measure and record the results in the test report.6. The RF fundamental frequency should be excluded against the limit line in the operating frequency band.
Test Result:	PASS



4.5.2. Test Instruments

RF Test Room				
Equipment	Manufacturer	Model	Serial Number	Calibration Due
Spectrum analyzer	Agilent	N9020A	HKE-048	Dec. 27, 2019
Signal generator	Agilent	N5183A	HKE-071	Dec. 27, 2019
RF Cable (9KHz-26.5GHz)	Tonscend	170660	N/A	Dec. 27, 2019
RF automatic control unit	Tonscend	JS0806-2	HKE-060	Dec. 27, 2019

Note: The calibration interval of the above test instruments is 12 months and the calibrations are traceable to international system unit (SI).



4.5.3. Test Data
Chain 1
802.11b Modulation

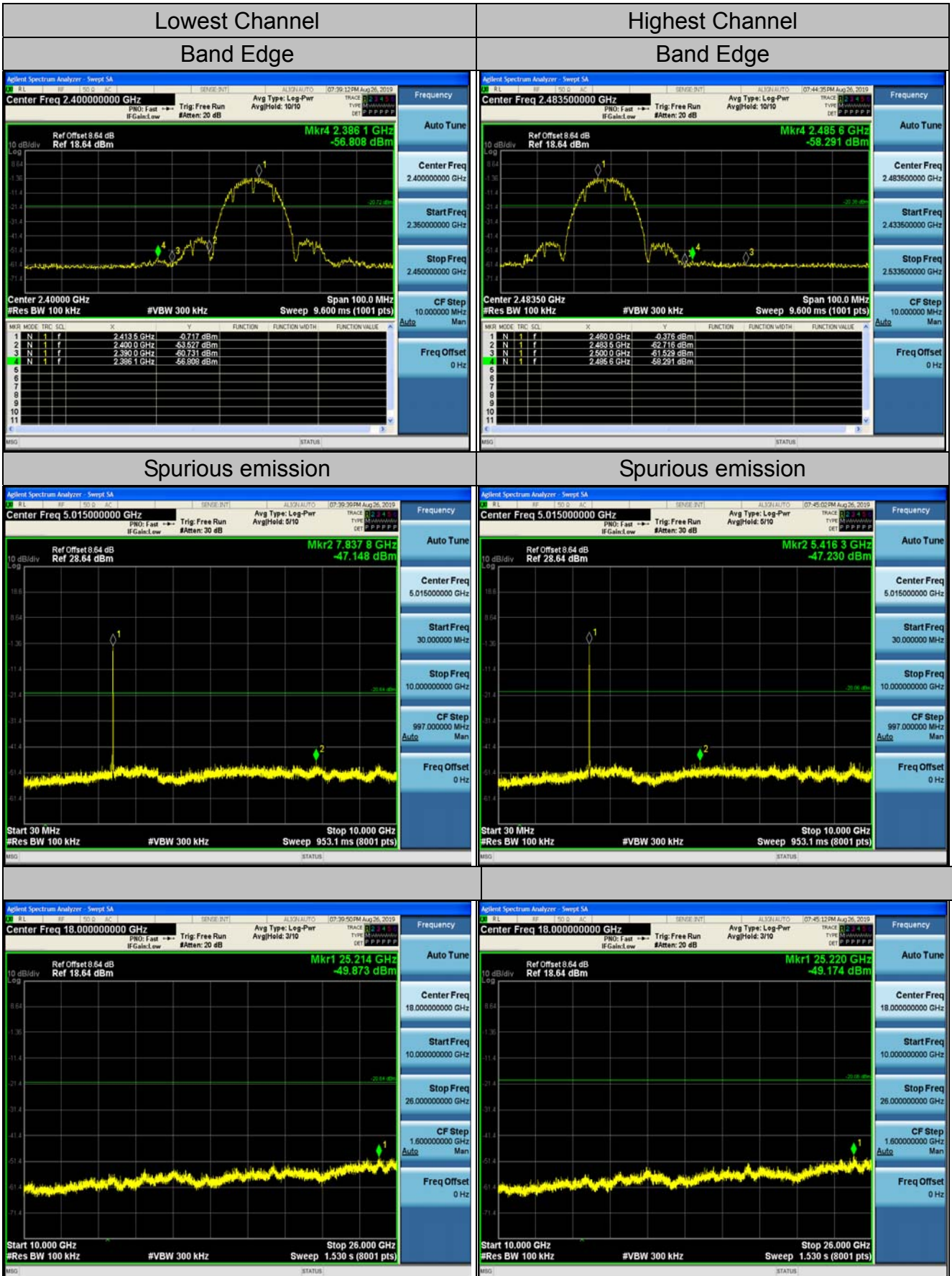



802.11g Modulation

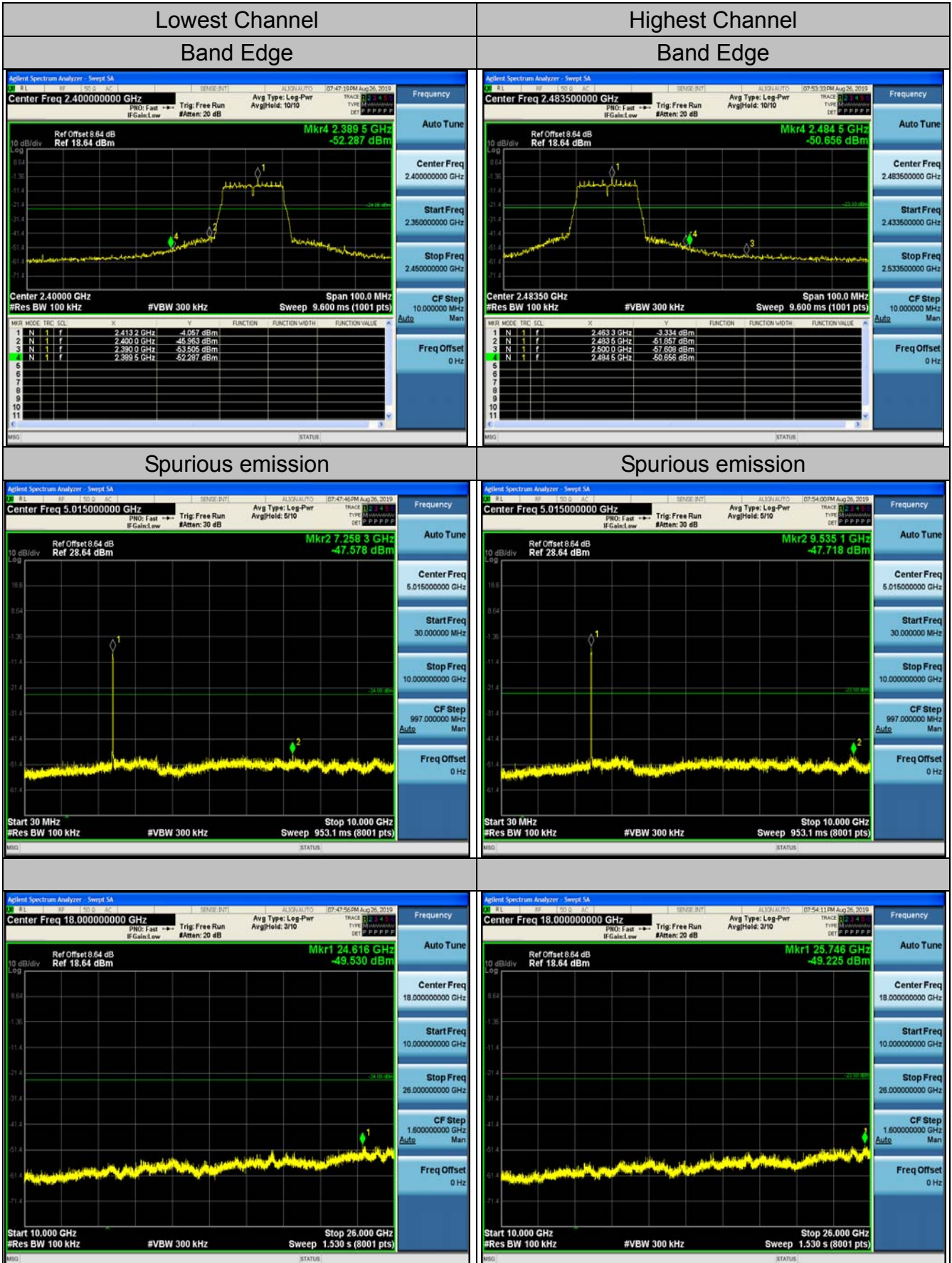



802.11n (HT20) Modulation

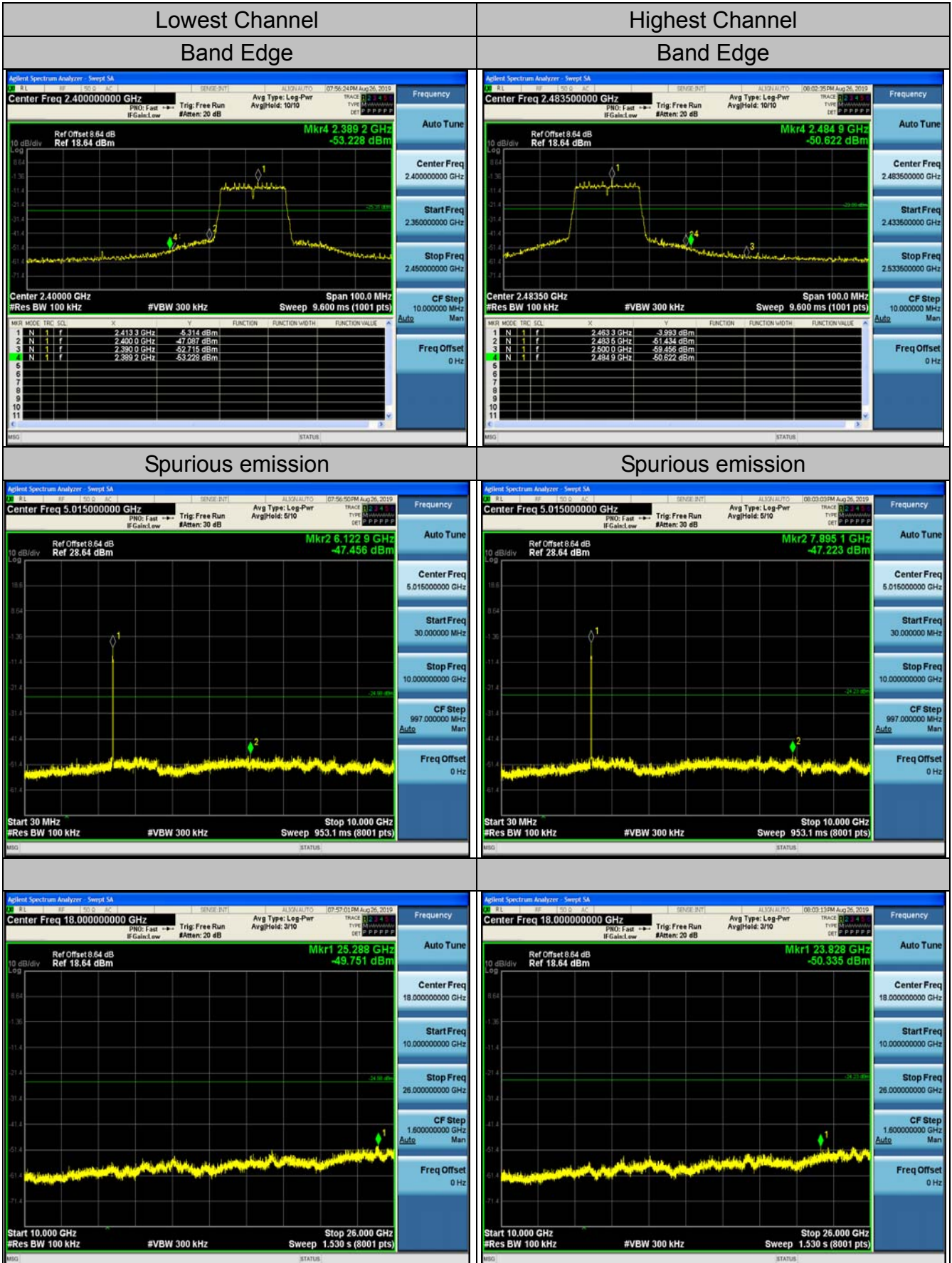



802.11n (HT40) Modulation

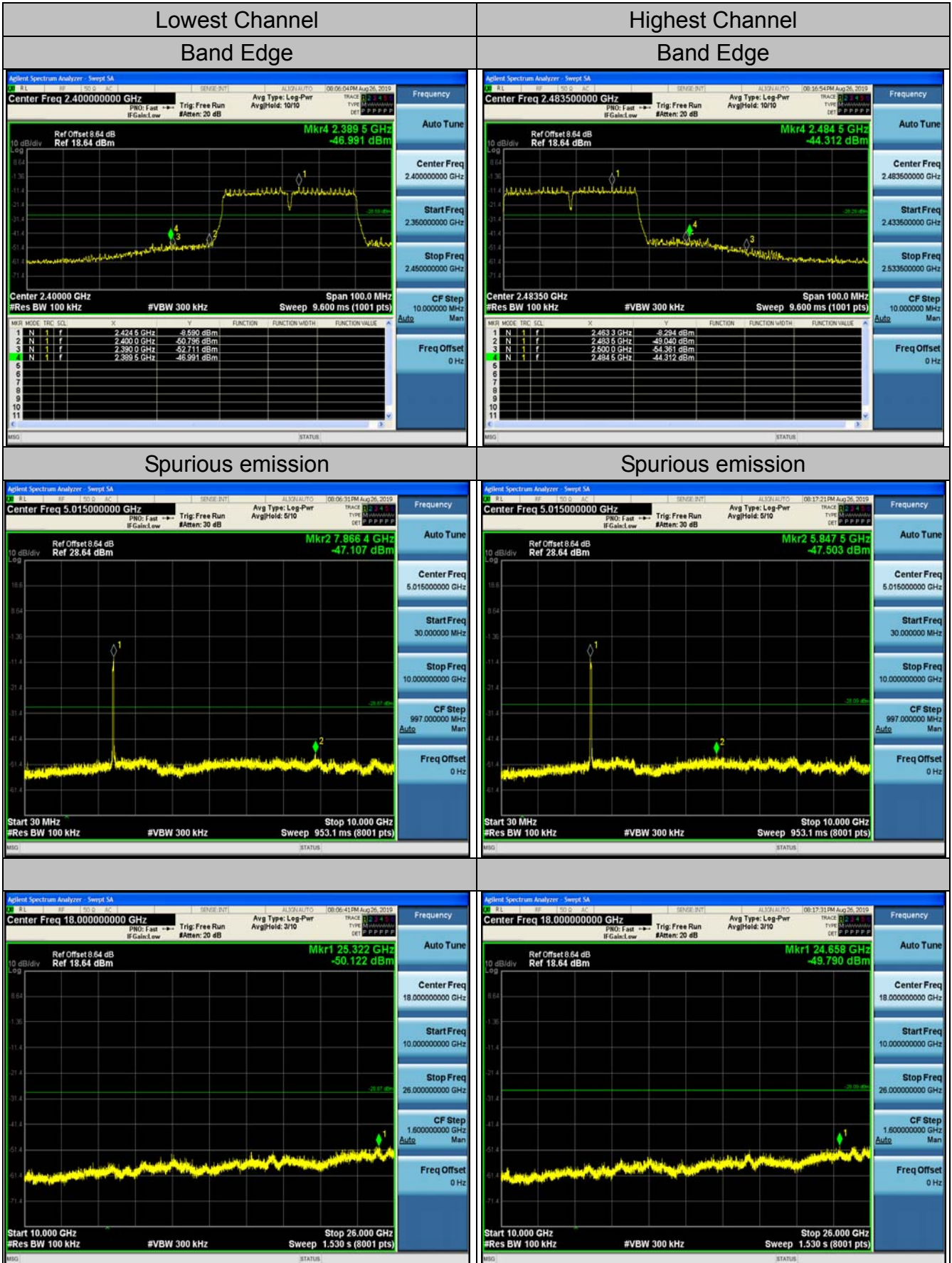



Chain 2
802.11b Modulation

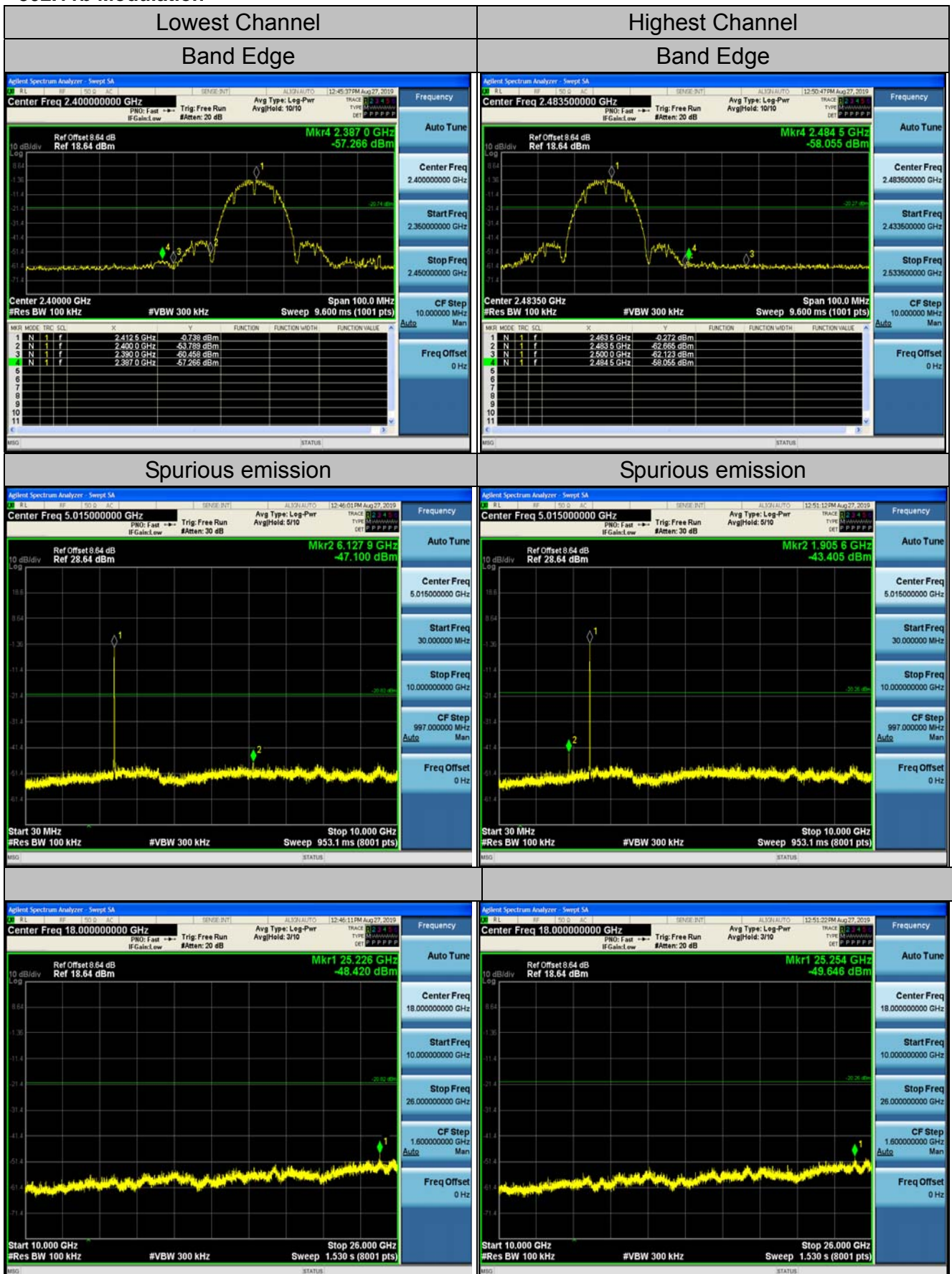



802.11g Modulation

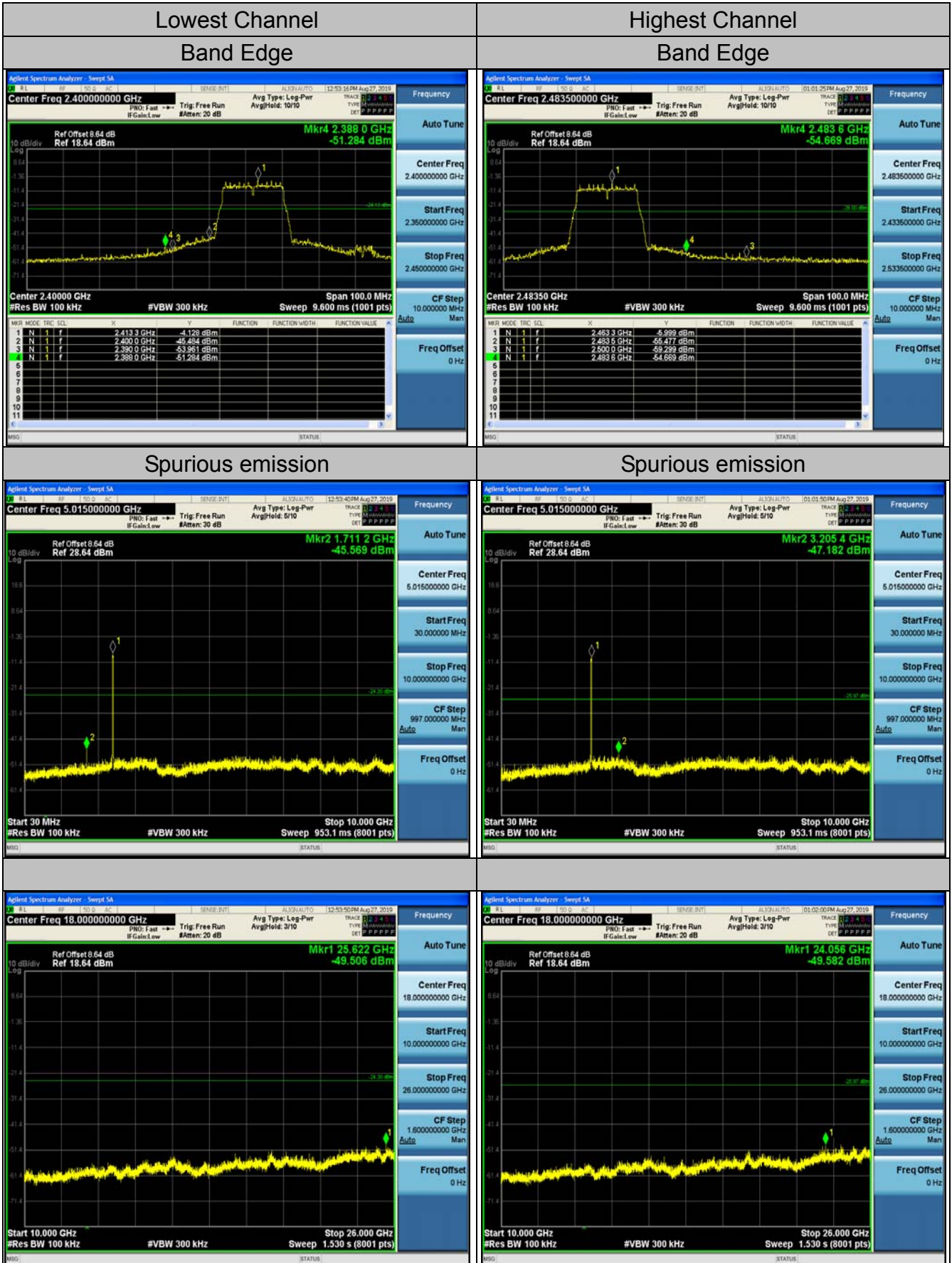



802.11n (HT20) Modulation

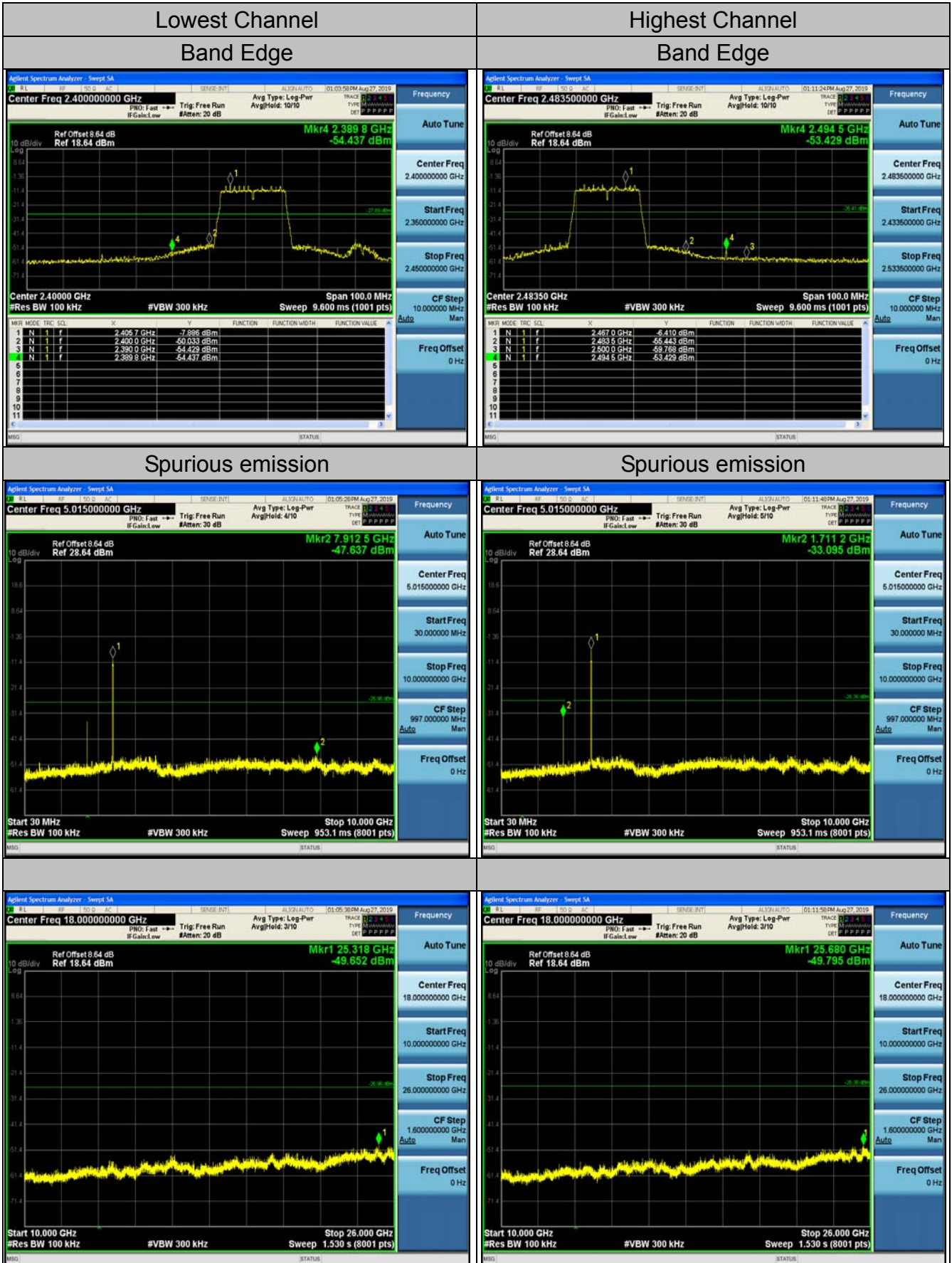



802.11n (HT40) Modulation





4.6. Radiated Spurious Emission Measurement

4.6.1. Test Specification

Test Requirement:	FCC Part15 C Section 15.209					
Test Method:	ANSI C63.10: 2013					
Frequency Range:	9 kHz to 25 GHz					
Measurement Distance:	3 m					
Antenna Polarization:	Horizontal & Vertical					
Operation mode:	Transmitting mode with modulation					
Receiver Setup:	Frequency	Detector	RBW	VBW	Remark	
	9kHz- 150kHz	Quasi-peak	200Hz	1kHz	Quasi-peak Value	
	150kHz- 30MHz	Quasi-peak	9kHz	30kHz	Quasi-peak Value	
	30MHz-1GHz	Quasi-peak	120KHz	300KHz	Quasi-peak Value	
	Above 1GHz	Peak	1MHz	3MHz	Peak Value	
		Peak	1MHz	10Hz	Average Value	
Limit:	Frequency	Field Strength (microvolts/meter)	Measurement Distance (meters)			
	0.009-0.490	2400/F(KHz)	300			
	0.490-1.705	24000/F(KHz)	30			
	1.705-30	30	30			
	30-88	100	3			
	88-216	150	3			
	216-960	200	3			
	Above 960	500	3			
	Frequency	Field Strength (microvolts/meter)	Measurement Distance (meters)	Detector		
	Above 1GHz	500	3	Average		
	5000	3	Peak			
Test setup:	For radiated emissions below 30MHz					
	<p>Distance = 3m</p> <p>0.8m</p> <p>EUT</p> <p>Turn table</p> <p>Ground Plane</p> <p>Computer</p> <p>Pre -Amplifier</p> <p>Receiver</p>					
	30MHz to 1GHz					

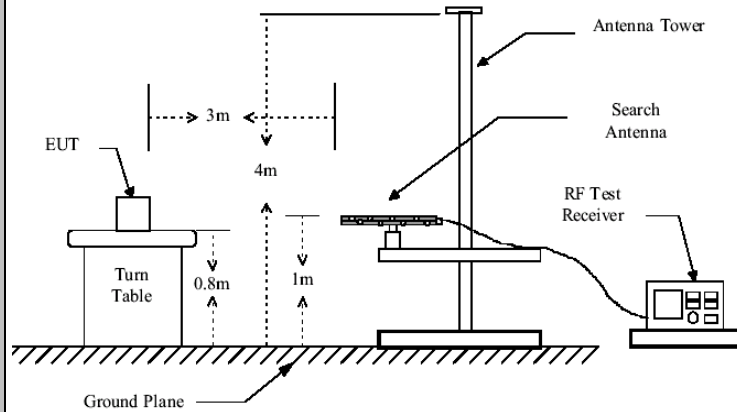

Above 1GHz

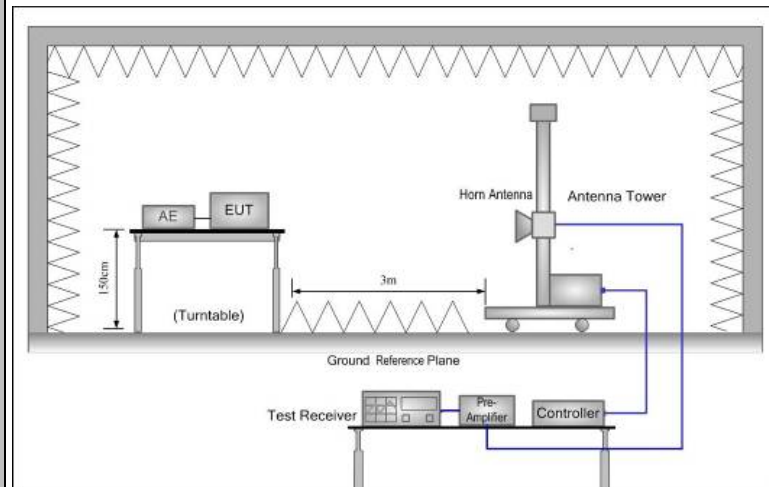

Test Procedure:

1. For the radiated emission test below 1GHz:
 The EUT was placed on a turntable with 0.8 meter above ground. The EUT was set 3 meters from the interference receiving antenna, which was mounted on the top of a variable height antenna tower. The EUT was arranged to its worst case and then tune the antenna tower (from 1 m to 4 m) and turntable (from 0 degree to 360 degrees) to find the maximum reading. A pre-amp and a high PASS filter are used for the test in order to get better signal level.
 For the radiated emission test above 1GHz:
 Place the measurement antenna on a turntable with 1.5 meter above ground, which is away from each area of the EUT determined to be a source of emissions at the specified measurement distance, while keeping the measurement antenna aimed at the source of emissions at each frequency of significant emissions, with polarization oriented for maximum response. The measurement antenna may have to be higher or lower than the EUT, depending on the radiation pattern of the emission and staying aimed at the emission source for receiving the maximum signal. The final measurement antenna elevation shall be that which



	<p>maximizes the emissions. The measurement antenna elevation for maximum emissions shall be restricted to a range of heights of from 1 m to 4 m above the ground or reference ground plane.</p> <ol style="list-style-type: none">3. Corrected Reading: Antenna Factor + Cable Loss + Read Level - Preamp Factor = Level4. For measurement below 1GHz, If the emission level of the EUT measured by the peak detector is 3 dB lower than the applicable limit, the peak emission level will be reported. Otherwise, the emission measurement will be repeated using the quasi-peak detector and reported.5. Use the following spectrum analyzer settings:<ol style="list-style-type: none">(1) Span shall wide enough to fully capture the emission being measured;(2) Set RBW=100 kHz for $f < 1$ GHz; VBW \geq RBW; Sweep = auto; Detector function = peak; Trace = max hold;(3) Set RBW = 1 MHz, VBW= 3MHz for $f \geq 1$ GHz for peak measurement. <p>For average measurement: VBW = 10 Hz, when duty cycle is no less than 98 percent. VBW $\geq 1/T$, when duty cycle is less than 98 percent where T is the minimum transmission duration over which the transmitter is on and is transmitting at its maximum power control level for the tested mode of operation.</p>
Test results:	PASS



4.6.2. Test Instruments

Radiated Emission Test Site (966)				
Name of Equipment	Manufacturer	Model	Serial Number	Calibration Due
Receiver	R&S	ESCI-7	HKE-010	Dec. 27, 2019
Spectrum analyzer	Agilent	N9020A	HKE-048	Dec. 27, 2019
Preamplifier	EMCI	EMC051845 SE	HKE-015	Dec. 27, 2019
Preamplifier	Agilent	83051A	HKE-016	Dec. 27, 2019
Loop antenna	Schwarzbeck	FMZB 1519 B	HKE-014	Sep. 26, 2019
Broadband antenna	Schwarzbeck	VULB 9163	HKE-012	Sep. 26, 2019
Horn antenna	Schwarzbeck	9120D	HKE-013	Sep. 26, 2019
Antenna Mast	Keleto	CC-A-4M	N/A	N/A
Position controller	Taiwan MF	MF7802	HKE-011	Dec. 27, 2019
Radiated test software	Tonscend	TS+ Rev 2.5.0.0	HKE-082	N/A
RF cable (9KHz-1GHz)	Times	381806-001	N/A	N/A
RF cable	Times	1-40G	HKE-034	Dec. 27, 2019

Note: The calibration interval of the above test instruments is 12 months and the calibrations are traceable to international system unit (SI).



4.6.3. Test Data

Please refer to following diagram for individual
Below 1GHz

test mode: TX 802.11b 2412MHz

All the test modes completed for test. The worst case of Radiated Emission; the test data of this mode was reported.

Horizontal

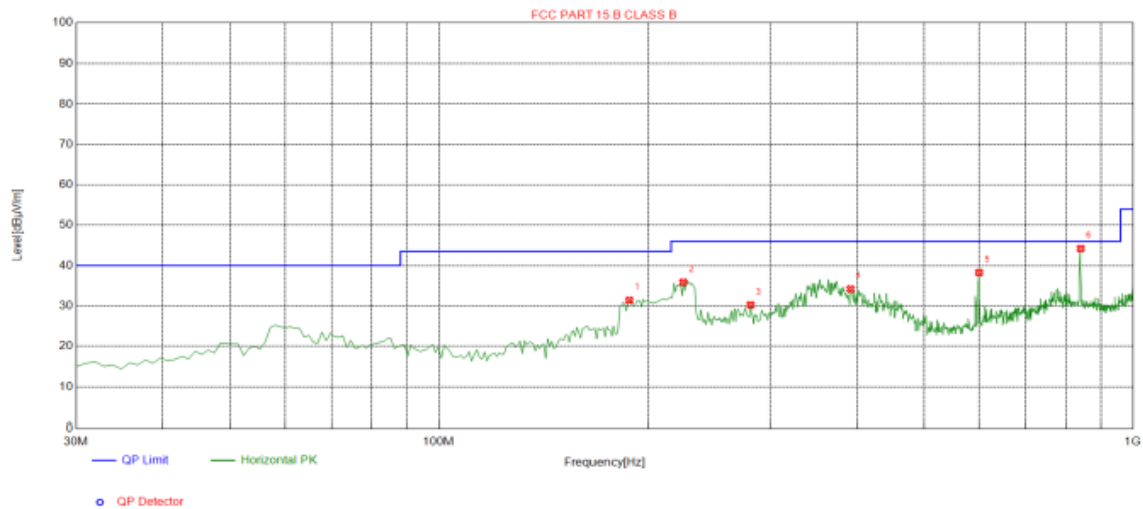

Suspected List								
NO.	Freq. [MHz]	Level [dBµV/m]	Factor [dB]	Limit [dBµV/m]	Margin [dB]	Height [cm]	Angle [°]	Polarity
1	188.110	31.40	-16.17	43.50	12.10	100	159	Horizontal
2	224.970	35.90	-14.44	46.00	10.10	100	34	Horizontal
3	281.230	30.26	-13.20	46.00	15.74	100	111	Horizontal
4	391.810	34.21	-10.61	46.00	11.79	100	143	Horizontal
5	600.360	38.28	-6.09	46.00	7.72	100	151	Horizontal
6	840.920	44.23	-2.57	46.00	1.77	100	149	Horizontal

Remark: Transd = Cable lose + Antenna factor - Pre-amplifier; Margin = Limit – Level



Vertical

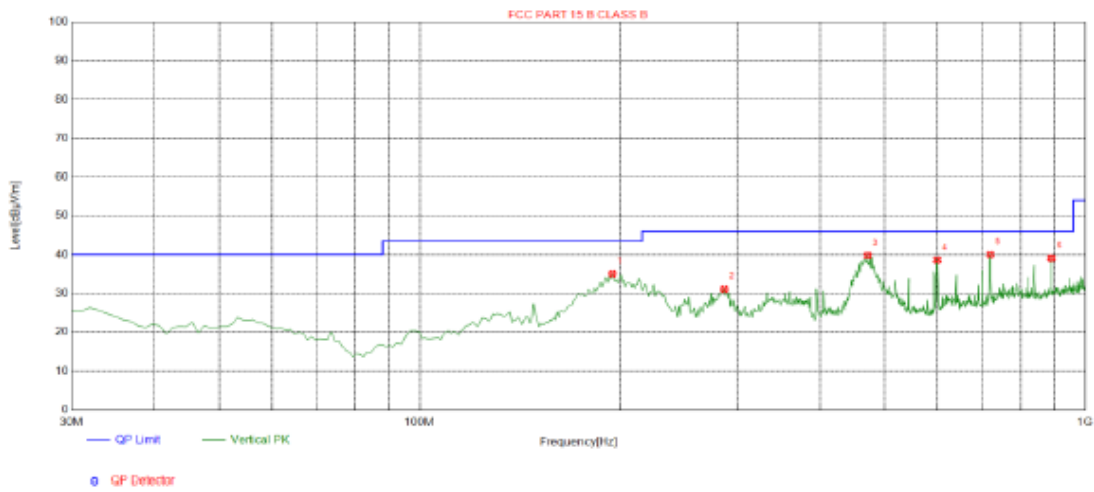

Suspected List								
NO.	Freq. [MHz]	Level [dBµV/m]	Factor [dB]	Limit [dBµV/m]	Margin [dB]	Height [cm]	Angle [°]	Polarity
1	194.900	34.97	-15.54	43.50	8.53	100	292	Vertical
2	287.050	31.14	-12.96	46.00	14.86	100	73	Vertical
3	471.350	39.79	-8.35	46.00	6.21	100	319	Vertical
4	599.390	38.64	-6.15	46.00	7.36	100	319	Vertical
5	720.640	40.05	-4.70	46.00	5.95	100	316	Vertical
6	890.390	39.08	-1.88	46.00	6.92	100	208	Vertical

Remark: Transd = Cable lose + Antenna factor - Pre-amplifier; Margin = Limit – Level

Remark:

- (1) Measuring frequencies from 9 KHz to the 1 GHz, Radiated emission test from 9KHz to 30MHz was verified, and no any emission was found except system noise floor.
- (2) * denotes emission frequency which appearing within the Restricted Bands specified in provision of 15.205, then the general radiated emission limits in 15.209 apply.
- (3) The IF bandwidth of EMI Test Receiver between 30MHz to 1GHz was 120KHz, 1 MHz for measuring above 1 GHz, below 30MHz was 10KHz.

**Above 1GHz****RADIATED EMISSION TEST**

LOW CH1 (802.11b Mode)/2412

Horizontal:

Frequency	Meter Reading	Factor	Emission Level	Limits	Margin	Detector Type
(MHz)	(dB μ V)	(dB)	(dB μ V/m)	(dB μ V/m)	(dB)	
4824	61.25	-3.64	57.61	74	-16.39	peak
4824	47.12	-3.64	43.48	54	-10.52	AVG
7236	57.03	-0.95	56.08	74	-17.92	peak
7236	43.75	-0.95	42.8	54	-11.2	AVG

Remark: Factor = Antenna Factor + Cable Loss – Pre-amplifier.

Vertical:

Frequency	Meter Reading	Factor	Emission Level	Limits	Margin	Detector Type
(MHz)	(dB μ V)	(dB)	(dB μ V/m)	(dB μ V/m)	(dB)	
4824	62.45	-3.64	58.81	74	-15.19	peak
4824	47.12	-3.64	43.48	54	-10.52	AVG
7236	57.36	-0.95	56.41	74	-17.59	peak
7236	43.15	-0.95	42.2	54	-11.8	AVG

Remark: Factor = Antenna Factor + Cable Loss – Pre-amplifier.



MID CH6 (802.11b Mode)/2437

Horizontal:

Frequency	Meter Reading	Factor	Emission Level	Limits	Margin	Detector Type
(MHz)	(dB μ V)	(dB)	(dB μ V/m)	(dB μ V/m)	(dB)	
4874	65.75	-3.51	62.24	74	-11.76	peak
4874	45.36	-3.51	41.85	54	-12.15	AVG
7311	57.25	-0.82	56.43	74	-17.57	peak
7311	38.96	-0.82	38.14	54	-15.86	AVG

Remark: Factor = Antenna Factor + Cable Loss – Pre-amplifier.

Vertical:

Frequency	Meter Reading	Factor	Emission Level	Limits	Margin	Detector Type
(MHz)	(dB μ V)	(dB)	(dB μ V/m)	(dB μ V/m)	(dB)	
4874	62.13	-3.51	58.62	74	-15.38	peak
4874	44.03	-3.51	40.52	54	-13.48	AVG
7311	56.45	-0.82	55.63	74	-18.37	peak
7311	41.96	-0.82	41.14	54	-12.86	AVG

Remark: Factor = Antenna Factor + Cable Loss – Pre-amplifier.



HIGH CH11 (802.11b Mode)/2462

Horizontal:

Frequency	Meter Reading	Factor	Emission Level	Limits	Margin	Detector Type
(MHz)	(dB μ V)	(dB)	(dB μ V/m)	(dB μ V/m)	(dB)	
4924	61.22	-3.43	57.79	74	-16.21	peak
4924	42.43	-3.43	39	54	-15	AVG
7386	55.32	-0.75	54.57	74	-19.43	peak
7386	40.16	-0.75	39.41	54	-14.59	AVG

Remark: Factor = Antenna Factor + Cable Loss – Pre-amplifier.

Vertical:

Frequency	Meter Reading	Factor	Emission Level	Limits	Margin	Detector Type
(MHz)	(dB μ V)	(dB)	(dB μ V/m)	(dB μ V/m)	(dB)	
4924	61.28	-3.43	57.85	74	-16.15	peak
4924	44.11	-3.43	40.68	54	-13.32	AVG
7386	53.06	-0.75	52.31	74	-21.69	peak
7386	38.75	-0.75	38	54	-16	AVG

Remark: Factor = Antenna Factor + Cable Loss – Pre-amplifier.

Remark:

(1) Measuring frequencies from 1 GHz to the 25 GHz.

(2) "F" denotes fundamental frequency; "H" denotes spurious frequency. "E" denotes band edge frequency.

(3) * denotes emission frequency which appearing within the Restricted Bands specified in provision of 15.205, then the general radiated emission limits in 15.209 apply.

(4) Data of measurement within this frequency range shown "---" in the table above means the reading of emissions are attenuated more than 20dB below the permissible limits or the field strength is too small to be measured.

(5) The IF bandwidth of EMI Test Receiver between 30MHz to 1GHz was 120KHz, 1 MHz for measuring above 1 GHz, below 30MHz was 10KHz.

(6) When the test results of Peak Detected below the limits of Average Detected, the Average Detected is not need completed. For example: Top Channel at Fundamental 73.16dBuV/m(PK Value) <93.98(AV Limit), at harmonic 53.20 dBuV/m(PK Value) <54 dBuV/m(AV Limit), the Average Detected not need to completed.



LOW CH1 (802.11g Mode)/2412

Horizontal:

Frequency	Meter Reading	Factor	Emission Level	Limits	Margin	Detector Type
(MHz)	(dB μ V)	(dB)	(dB μ V/m)	(dB μ V/m)	(dB)	
4824	64.55	-3.64	60.91	74	-13.09	peak
4824	43.07	-3.64	39.43	54	-14.57	AVG
7236	54.39	-0.95	53.44	74	-20.56	peak
7236	43.48	-0.95	42.53	54	-11.47	AVG

Remark: Factor = Antenna Factor + Cable Loss – Pre-amplifier.

Vertical:

Frequency	Meter Reading	Factor	Emission Level	Limits	Margin	Detector Type
(MHz)	(dB μ V)	(dB)	(dB μ V/m)	(dB μ V/m)	(dB)	
4824	61.07	-3.64	57.43	74	-16.57	peak
4824	44.25	-3.64	40.61	54	-13.39	AVG
7236	58.18	-0.95	57.23	74	-16.77	peak
7236	43.63	-0.95	42.68	54	-11.32	AVG

Remark: Factor = Antenna Factor + Cable Loss – Pre-amplifier.



MID CH6 (802.11g Mode)/2437

Horizontal:

Frequency	Meter Reading	Factor	Emission Level	Limits	Margin	Detector Type
(MHz)	(dB μ V)	(dB)	(dB μ V/m)	(dB μ V/m)	(dB)	
4874	61.57	-3.51	58.06	74	-15.94	peak
4874	48.15	-3.51	44.64	54	-9.36	AVG
7311	54.66	-0.82	53.84	74	-20.16	peak
7311	42.27	-0.82	41.45	54	-12.55	AVG

Remark: Factor = Antenna Factor + Cable Loss – Pre-amplifier.

Vertical:

Frequency	Meter Reading	Factor	Emission Level	Limits	Margin	Detector Type
(MHz)	(dB μ V)	(dB)	(dB μ V/m)	(dB μ V/m)	(dB)	
4874	63.74	-3.51	60.23	74	-13.77	peak
4874	44.33	-3.51	40.82	54	-13.18	AVG
7311	52.96	-0.82	52.14	74	-21.86	peak
7311	41.15	-0.82	40.33	54	-13.67	AVG

Remark: Factor = Antenna Factor + Cable Loss – Pre-amplifier.



HIGH CH11 (802.11g Mode)/2462

Horizontal:

Frequency	Meter Reading	Factor	Emission Level	Limits	Margin	Detector Type
(MHz)	(dB μ V)	(dB)	(dB μ V/m)	(dB μ V/m)	(dB)	
4924	60.42	-3.43	56.99	74	-17.01	peak
4924	44.45	-3.43	41.02	54	-12.98	AVG
7386	54.76	-0.75	54.01	74	-19.99	peak
7386	38.12	-0.75	37.37	54	-16.63	AVG

Remark: Factor = Antenna Factor + Cable Loss – Pre-amplifier.

Vertical:

Frequency	Meter Reading	Factor	Emission Level	Limits	Margin	Detector Type
(MHz)	(dB μ V)	(dB)	(dB μ V/m)	(dB μ V/m)	(dB)	
4924	61.45	-3.43	58.02	74	-15.98	peak
4924	46.11	-3.43	42.68	54	-11.32	AVG
7386	53.64	-0.75	52.89	74	-21.11	peak
7386	41.06	-0.75	40.31	54	-13.69	AVG

Remark: Factor = Antenna Factor + Cable Loss – Pre-amplifier.

Remark:

- (1) Measuring frequencies from 1 GHz to the 25 GHz.
- (2) "F" denotes fundamental frequency; "H" denotes spurious frequency. "E" denotes band edge frequency.
- (3) * denotes emission frequency which appearing within the Restricted Bands specified in provision of 15.205, then the general radiated emission limits in 15.209 apply.
- (4) Data of measurement within this frequency range shown "---" in the table above means the reading of emissions are attenuated more than 20dB below the permissible limits or the field strength is too small to be measured.
- (5) The IF bandwidth of EMI Test Receiver between 30MHz to 1GHz was 120KHz, 1 MHz for measuring above 1 GHz, below 30MHz was 10KHz.
- (6) When the test results of Peak Detected below the limits of Average Detected, the Average Detected is not need completed. For example: Top Channel at Fundamental 73.16dBuV/m(PK Value) <93.98(AV Limit), at harmonic 53.20 dBuV/m(PK Value) <54 dBuV/m(AV Limit), the Average Detected not need to completed.



LOW CH1 (802.11n/H20 Mode)/2412

Horizontal:

Frequency	Meter Reading	Factor	Emission Level	Limits	Margin	Detector Type
(MHz)	(dB μ V)	(dB)	(dB μ V/m)	(dB μ V/m)	(dB)	
4824	61.26	-3.64	57.62	74	-16.38	peak
4824	47.37	-3.64	43.73	54	-10.27	AVG
7236	58.03	-0.95	57.08	74	-16.92	peak
7236	42.78	-0.95	41.83	54	-12.17	AVG

Remark: Factor = Antenna Factor + Cable Loss – Pre-amplifier.

Vertical:

Frequency	Meter Reading	Factor	Emission Level	Limits	Margin	Detector Type
(MHz)	(dB μ V)	(dB)	(dB μ V/m)	(dB μ V/m)	(dB)	
4824	62.26	-3.64	58.62	74	-15.38	peak
4824	47.03	-3.64	43.39	54	-10.61	AVG
7236	57.66	-0.95	56.71	74	-17.29	peak
7236	41.14	-0.95	40.19	54	-13.81	AVG

Remark: Factor = Antenna Factor + Cable Loss – Pre-amplifier.



MID CH6 (802.11n/H20 Mode)/2437

Horizontal:

Frequency	Meter Reading	Factor	Emission Level	Limits	Margin	Detector Type
(MHz)	(dB μ V)	(dB)	(dB μ V/m)	(dB μ V/m)	(dB)	
4874.00	63.63	-3.51	60.12	74.00	-13.88	peak
4874.00	43.41	-3.51	39.90	54.00	-14.10	AVG
7311.00	55.21	-0.82	54.39	74.00	-19.61	peak
7311.00	44.06	-0.82	43.24	54.00	-10.76	AVG

Remark: Factor = Antenna Factor + Cable Loss – Pre-amplifier.

Vertical:

Frequency	Meter Reading	Factor	Emission Level	Limits	Margin	Detector Type
(MHz)	(dB μ V)	(dB)	(dB μ V/m)	(dB μ V/m)	(dB)	
4874.00	60.32	-3.51	56.81	74.00	-17.19	peak
4874.00	45.14	-3.51	41.63	54.00	-12.37	AVG
7311.00	55.57	-0.82	54.75	74.00	-19.25	peak
7311.00	42.79	-0.82	41.97	54.00	-12.03	AVG

Remark: Factor = Antenna Factor + Cable Loss – Pre-amplifier.



HIGH CH11 (802.11n/H20 Mode)/2462

Horizontal:

Frequency	Meter Reading	Factor	Emission Level	Limits	Margin	Detector Type
(MHz)	(dB μ V)	(dB)	(dB μ V/m)	(dB μ V/m)	(dB)	
4924	58.52	-3.43	55.09	74	-18.91	peak
4924	44.12	-3.43	40.69	54	-13.31	AVG
7386	54.75	-0.75	54	74	-20	peak
7386	42.33	-0.75	41.58	54	-12.42	AVG

Remark: Factor = Antenna Factor + Cable Loss – Pre-amplifier.

Vertical:

Frequency	Meter Reading	Factor	Emission Level	Limits	Margin	Detector Type
(MHz)	(dB μ V)	(dB)	(dB μ V/m)	(dB μ V/m)	(dB)	
4924	64.36	-3.43	60.93	74	-13.07	peak
4924	44.12	-3.43	40.69	54	-13.31	AVG
7386	54.47	-0.75	53.72	74	-20.28	peak
7386	38.65	-0.75	37.9	54	-16.1	AVG

Remark: Factor = Antenna Factor + Cable Loss – Pre-amplifier.



LOW CH3 (802.11n/H40 Mode)/2422

Horizontal:

Frequency	Meter Reading	Factor	Emission Level	Limits	Margin	Detector Type
(MHz)	(dB μ V)	(dB)	(dB μ V/m)	(dB μ V/m)	(dB)	
4844	60.45	-3.63	56.82	74	-17.18	peak
4844	46.10	-3.63	42.47	54	-11.53	AVG
7266	56.37	-0.94	55.43	74	-18.57	peak
7266	44.22	-0.94	43.28	54	-10.72	AVG

Remark: Factor = Antenna Factor + Cable Loss – Pre-amplifier.

Vertical:

Frequency	Meter Reading	Factor	Emission Level	Limits	Margin	Detector Type
(MHz)	(dB μ V)	(dB)	(dB μ V/m)	(dB μ V/m)	(dB)	
4844	62.06	-3.63	58.43	74	-15.57	peak
4844	46.69	-3.63	43.06	54	-10.94	AVG
7266	53.23	-0.94	52.29	74	-21.71	peak
7266	41.47	-0.94	40.53	54	-13.47	AVG

Remark: Factor = Antenna Factor + Cable Loss – Pre-amplifier.



MID CH6 (802.11n/H40 Mode)/2437

Horizontal:

Frequency	Meter Reading	Factor	Emission Level	Limits	Margin	Detector Type
(MHz)	(dB μ V)	(dB)	(dB μ V/m)	(dB μ V/m)	(dB)	
4874	62.11	-3.51	58.6	74	-15.4	peak
4874	47.37	-3.51	43.86	54	-10.14	AVG
7311	52.26	-0.82	51.44	74	-22.56	peak
7311	44.52	-0.82	43.7	54	-10.3	AVG

Remark: Factor = Antenna Factor + Cable Loss – Pre-amplifier.

Vertical:

Frequency	Meter Reading	Factor	Emission Level	Limits	Margin	Detector Type
(MHz)	(dB μ V)	(dB)	(dB μ V/m)	(dB μ V/m)	(dB)	
4874	62.47	-3.51	58.96	74	-15.04	peak
4874	43.03	-3.51	39.52	54	-14.48	AVG
7311	55.43	-0.82	54.61	74	-19.39	peak
7311	38.12	-0.82	37.3	54	-16.7	AVG

Remark: Factor = Antenna Factor + Cable Loss – Pre-amplifier.



HIGH CH9 (802.11n/H40 Mode)/2452
Horizontal:

Frequency	Meter Reading	Factor	Emission Level	Limits	Margin	Detector Type
(MHz)	(dBμV)	(dB)	(dBμV/m)	(dBμV/m)	(dB)	
4904	62.57	-3.43	59.14	74	-14.86	peak
4904	43.32	-3.43	39.89	54	-14.11	AVG
7356	54.09	-0.75	53.34	74	-20.66	peak
7356	42.47	-0.75	41.72	54	-12.28	AVG

Remark: Factor = Antenna Factor + Cable Loss – Pre-amplifier.

Vertical:

Frequency	Meter Reading	Factor	Emission Level	Limits	Margin	Detector Type
(MHz)	(dBμV)	(dB)	(dBμV/m)	(dBμV/m)	(dB)	
4904	61.99	-3.43	58.56	74	-15.44	peak
4904	48.85	-3.43	45.42	54	-8.58	AVG
7356	55.06	-0.75	54.31	74	-19.69	peak
7356	42.22	-0.75	41.47	54	-12.53	AVG

Remark: Factor = Antenna Factor + Cable Loss – Pre-amplifier.

Remark:

- (1) Measuring frequencies from 1 GHz to the 25 GHz.
- (2) "F" denotes fundamental frequency; "H" denotes spurious frequency. "E" denotes band edge frequency.
- (3) * denotes emission frequency which appearing within the Restricted Bands specified in provision of 15.205, then the general radiated emission limits in 15.209 apply.
- (4) Data of measurement within this frequency range shown "---" in the table above means the reading of emissions are attenuated more than 20dB below the permissible limits or the field strength is too small to be measured.
- (5) The IF bandwidth of EMI Test Receiver between 30MHz to 1GHz was 120KHz, 1 MHz for measuring above 1 GHz, below 30MHz was 10KHz.
- (6) When the test results of Peak Detected below the limits of Average Detected, the Average Detected is not need completed. For example: Top Channel at Fundamental 73.16dBuV/m(PK Value) <93.98(AV Limit), at harmonic 53.20 dBuV/m(PK Value) <54 dBuV/m(AV Limit), the Average Detected not need to completed.

**Test Result of Radiated Spurious at Band edges**

Operation Mode:
802.11b Mode TX CH Low (2412MHz)

Horizontal

Frequency	Meter Reading	Factor	Emission Level	Limits	Margin	Detector Type
(MHz)	(dB μ V)	(dB)	(dB μ V/m)	(dB μ V/m)	(dB)	
2310	62.43	-5.81	56.62	74	-17.38	peak
2310	/	-5.81	/	54	/	AVG
2390	62.13	-5.84	56.29	74	-17.71	peak
2390	52.75	-5.84	46.91	54	-7.09	AVG
2400	62.45	-5.84	56.61	74	-17.39	peak
2400	48.33	-5.84	42.49	54	-11.51	AVG

Remark: Factor = Antenna Factor + Cable Loss – Pre-amplifier.

Vertical:

Frequency	Meter Reading	Factor	Emission Level	Limits	Margin	Detector Type
(MHz)	(dB μ V)	(dB)	(dB μ V/m)	(dB μ V/m)	(dB)	
2310	55.74	-5.81	49.93	74	-24.07	peak
2310	/	-5.81	/	54	/	AVG
2390	61.52	-5.84	55.68	74	-18.32	peak
2390	48.26	-5.84	42.42	54	-11.58	AVG
2400	62.11	-5.84	56.27	74	-17.73	peak
2400	45.47	-5.84	39.63	54	-14.37	AVG

Remark: Factor = Antenna Factor + Cable Loss – Pre-amplifier.



Operation Mode: TX CH High (2462MHz)

Horizontal

Frequency	Meter Reading	Factor	Emission Level	Limits	Margin	Detector Type
(MHz)	(dB μ V)	(dB)	(dB μ V/m)	(dB μ V/m)	(dB)	
2483.50	58.33	-5.65	52.68	74	-21.32	peak
2483.50	/	-5.65	/	54	/	AVG
2500.00	53.12	-5.65	47.47	74	-26.53	peak
2500.00	/	-5.65	/	54	/	AVG

Remark: Factor = Antenna Factor + Cable Loss – Pre-amplifier.

Vertical:

Frequency	Meter Reading	Factor	Emission Level	Limits	Margin	Detector Type
(MHz)	(dB μ V)	(dB)	(dB μ V/m)	(dB μ V/m)	(dB)	
2483.50	56.65	-5.65	51	74	-23	peak
2483.50	/	-5.65	/	54	/	AVG
2500.00	55.59	-5.65	49.94	74	-24.06	peak
2500.00	/	-5.65	/	54	/	AVG

Remark: Factor = Antenna Factor + Cable Loss – Pre-amplifier.

Remark: All the other emissions not reported were too low to read and deemed to comply with FCC limit.



Operation Mode: 802.11g Mode TX CH Low (2412MHz)

Horizontal

Frequency	Meter Reading	Factor	Emission Level	Limits	Margin	Detector Type
(MHz)	(dB μ V)	(dB)	(dB μ V/m)	(dB μ V/m)	(dB)	
2310	56.22	-5.81	50.41	74	-23.59	peak
2310	/	-5.81	/	54	/	AVG
2390	61.41	-5.84	55.57	74	-18.43	peak
2390	46.21	-5.84	40.37	54	-13.63	AVG
2400	62.06	-5.84	56.22	74	-17.78	peak
2400	49.13	-5.84	43.29	54	-10.71	AVG

Remark: Factor = Antenna Factor + Cable Loss – Pre-amplifier.

Vertical:

Frequency	Meter Reading	Factor	Emission Level	Limits	Margin	Detector Type
(MHz)	(dB μ V)	(dB)	(dB μ V/m)	(dB μ V/m)	(dB)	
2310	56.24	-5.81	50.43	74	-23.57	peak
2310	/	-5.81	/	54	/	AVG
2390	62.52	-5.84	56.68	74	-17.32	peak
2390	48.36	-5.84	42.52	54	-11.48	AVG
2400	61.17	-5.84	55.33	74	-18.67	peak
2400	47.08	-5.84	41.24	54	-12.76	AVG

Remark: Factor = Antenna Factor + Cable Loss – Pre-amplifier.



Operation Mode: TX CH High (2462MHz)

Horizontal

Frequency	Meter Reading	Factor	Emission Level	Limits	Margin	Detector Type
(MHz)	(dB μ V)	(dB)	(dB μ V/m)	(dB μ V/m)	(dB)	
2483.50	59.23	-5.65	53.58	74	-20.42	peak
2483.50	/	-5.65	/	54	/	AVG
2500.00	53.06	-5.65	47.41	74	-26.59	peak
2500.00	/	-5.65	/	54	/	AVG

Remark: Factor = Antenna Factor + Cable Loss – Pre-amplifier.

Vertical:

Frequency	Meter Reading	Factor	Emission Level	Limits	Margin	Detector Type
(MHz)	(dB μ V)	(dB)	(dB μ V/m)	(dB μ V/m)	(dB)	
2483.50	51.39	-5.65	45.74	74	-28.26	peak
2483.50	/	-5.65	/	54	/	AVG
2500.00	52.52	-5.65	46.87	74	-27.13	peak
2500.00	/	-5.65	/	54	/	AVG

Remark: Factor = Antenna Factor + Cable Loss – Pre-amplifier.

Remark: All the other emissions not reported were too low to read and deemed to comply with FCC limit.



Operation Mode: 802.11n/H20 Mode TX CH Low (2412MHz)

Horizontal

Frequency	Meter Reading	Factor	Emission Level	Limits	Margin	Detector Type
(MHz)	(dB μ V)	(dB)	(dB μ V/m)	(dB μ V/m)	(dB)	
2310	56.13	-5.81	50.32	74	-23.68	peak
2310	/	-5.81	/	54	/	AVG
2390	61.52	-5.84	55.68	74	-18.32	peak
2390	48.34	-5.84	42.5	54	-11.5	AVG
2400	60.02	-5.84	54.18	74	-19.82	peak
2400	48.33	-5.84	42.49	54	-11.51	AVG

Remark: Factor = Antenna Factor + Cable Loss – Pre-amplifier.

Vertical:

Frequency	Meter Reading	Factor	Emission Level	Limits	Margin	Detector Type
(MHz)	(dB μ V)	(dB)	(dB μ V/m)	(dB μ V/m)	(dB)	
2310	54.24	-5.81	48.43	74	-25.57	peak
2310	/	-5.81	/	54	/	AVG
2390	63.96	-5.84	58.12	74	-15.88	peak
2390	47.45	-5.84	41.61	54	-12.39	AVG
2400	64.37	-5.84	58.53	74	-15.47	peak
2400	48.28	-5.84	42.44	54	-11.56	AVG

Remark: Factor = Antenna Factor + Cable Loss – Pre-amplifier.



Operation Mode: TX CH High (2462MHz)

Horizontal

Frequency	Meter Reading	Factor	Emission Level	Limits	Margin	Detector Type
(MHz)	(dB μ V)	(dB)	(dB μ V/m)	(dB μ V/m)	(dB)	
2483.50	55.45	-5.65	49.8	74	-24.2	peak
2483.50	/	-5.65	/	54	/	AVG
2500.00	54.63	-5.65	48.98	74	-25.02	peak
2500.00	/	-5.65	/	54	/	AVG

Remark: Factor = Antenna Factor + Cable Loss – Pre-amplifier.

Vertical:

Frequency	Meter Reading	Factor	Emission Level	Limits	Margin	Detector Type
(MHz)	(dB μ V)	(dB)	(dB μ V/m)	(dB μ V/m)	(dB)	
2483.50	56.77	-5.65	51.12	74	-22.88	peak
2483.50	/	-5.65	/	54	/	AVG
2500.00	54.04	-5.65	48.39	74	-25.61	peak
2500.00	/	-5.65	/	54	/	AVG

Remark: Factor = Antenna Factor + Cable Loss – Pre-amplifier.

Remark: All the other emissions not reported were too low to read and deemed to comply with FCC limit.



Operation Mode: 802.11n/H40 Mode TX CH Low (2422MHz)

Horizontal

Frequency	Meter Reading	Factor	Emission Level	Limits	Margin	Detector Type
(MHz)	(dB μ V)	(dB)	(dB μ V/m)	(dB μ V/m)	(dB)	
2310	60.23	-5.81	54.42	74	-19.58	peak
2310	/	-5.81	/	54	/	AVG
2390	62.47	-5.84	56.63	74	-17.37	peak
2390	45.65	-5.84	39.81	54	-14.19	AVG
2400	62.14	-5.84	56.3	74	-17.7	peak
2400	45.88	-5.84	40.04	54	-13.96	AVG

Remark: Factor = Antenna Factor + Cable Loss – Pre-amplifier.

Vertical:

Frequency	Meter Reading	Factor	Emission Level	Limits	Margin	Detector Type
(MHz)	(dB μ V)	(dB)	(dB μ V/m)	(dB μ V/m)	(dB)	
2310	58.63	-5.81	52.82	74	-21.18	peak
2310	/	-5.81	/	54	/	AVG
2390	61.47	-5.84	55.63	74	-18.37	peak
2390	45.08	-5.84	39.24	54	-14.76	AVG
2400	61.12	-5.84	55.28	74	-18.72	peak
2400	47.55	-5.84	41.71	54	-12.29	AVG

Remark: Factor = Antenna Factor + Cable Loss – Pre-amplifier.



Operation Mode: TX CH High (2452MHz)

Horizontal

Frequency	Meter Reading	Factor	Emission Level	Limits	Margin	Detector Type
(MHz)	(dB μ V)	(dB)	(dB μ V/m)	(dB μ V/m)	(dB)	
2483.50	56.44	-5.65	50.79	74	-23.21	peak
2483.50	/	-5.65	/	54	/	AVG
2500.00	53.28	-5.65	47.63	74	-26.37	peak
2500.00	/	-5.65	/	54	/	AVG

Remark: Factor = Antenna Factor + Cable Loss – Pre-amplifier.

Vertical:

Frequency	Meter Reading	Factor	Emission Level	Limits	Margin	Detector Type
(MHz)	(dB μ V)	(dB)	(dB μ V/m)	(dB μ V/m)	(dB)	
2483.50	54.75	-5.65	49.1	74	-24.9	peak
2483.50	/	-5.65	/	54	/	AVG
2500.00	53.29	-5.65	47.64	74	-26.36	peak
2500.00	/	-5.65	/	54	/	AVG

Remark: Factor = Antenna Factor + Cable Loss – Pre-amplifier.

Remark: All the other emissions not reported were too low to read and deemed to comply with FCC limit.



4.7. ANTENNA REQUIREMENT

Standard Applicable

For intentional device, according to FCC 47 CFR Section 15.203, an intentional radiator shall be designed to ensure that no antenna other than that furnished by the responsible party shall be used with the device. And according to FCC 47 CFR Section 15.247, if transmitting antennas of directional gain greater than 6dBi are used, the power shall be reduced by the amount in dB that the directional gain of the antenna exceeds 6dBi.

Refer to statement below for compliance.

The manufacturer may design the unit so that the user can replace a broken antenna, but the use of a standard antenna jack or electrical connector is prohibited. Further, this requirement does not apply to intentional radiators that must be professionally installed.

Antenna Connected Construction

The antenna used in this product is a Integral Antenna, and the best case gain of the antenna is Antenna port 1:1dBi and Antenna port 2:1dBi.

ANTENNA

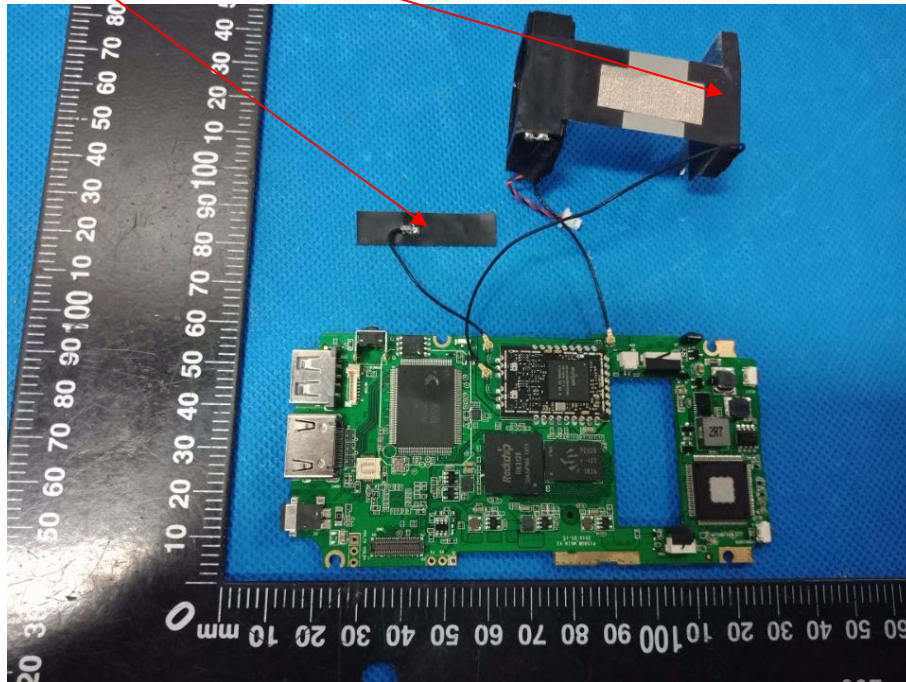

PHOTOGRAPH OF TEST

Radiated Emission





Conducted Emission





4.8. PHOTOS OF THE EUT

Reference to the reporter : ANNEX A of external photos and ANNEX B of internal photos

*******End of Report*******