



# RF TEST REPORT

**Applicant**            Quectel Wireless Solutions Co., Ltd.  
**FCC ID**                XMR201707BG96  
**Product**              Quectel BG96  
**Brand**                 Quectel  
**Model**                 BG96  
**Report No.**           RXA1706-0199RF04R1  
**Issue Date**          July 12, 2017

TA Technology (Shanghai) Co., Ltd. tested the above equipment in accordance with the requirements in **FCC CFR47 Part 2 (2016)/ FCC CFR 47 Part 90S (2016)**. The test results show that the equipment tested is capable of demonstrating compliance with the requirements as documented in this report.

*Xianqing Li*

Performed by: Xianqing Li

*Kai Xu*

Approved by: Kai Xu

---

**TA Technology (Shanghai) Co., Ltd.**

No.145, Jintang Rd, Tangzhen Industry Park, Pudong Shanghai, China

TEL: +86-021-50791141/2/3

FAX: +86-021-50791141/2/3-8000



## TABLE OF CONTENT

1. Test Laboratory .....	4
1.1. Notes of the Test Report .....	4
1.2. Test facility .....	4
1.3. Testing Location .....	5
2. General Description of Equipment under Test.....	6
3. Applied Standards .....	7
4. Test Configuration .....	8
5. Test Case Results .....	9
5.1. RF Power Output .....	9
5.2. Effective Radiated Power .....	12
5.3. Occupied Bandwidth .....	15
5.4. Emission Mask .....	21
5.5. Peak-to-Average Power Ratio (PAPR).....	27
5.6. Frequency Stability.....	29
5.7. Spurious Emissions at Antenna Terminals.....	33
5.8. Radiates Spurious Emission .....	38
6. Main Test Instruments.....	45
ANNEX A: EUT Appearance and Test Setup .....	46
A.1 EUT Appearance.....	46
A.2 Test Setup.....	48



### Summary of measurement results

No.	Test Type	Clause in FCC rules	Verdict
1	RF power output	2.1046/90.635(b)	PASS
2	Effective Radiated Power	90.635(b)	PASS
3	Occupied Bandwidth	2.1049/ 90.209	PASS
4	Emission Masks	2.1051 / 90.691	PASS
5	Peak-to-Average Power Ratio	KDB 971168 D01(5.7)	PASS
6	Frequency Stability	2.1055 / 90.213	PASS
7	Spurious Emissions at Antenna Terminals	2.1051 / 90.691	PASS
8	Radiates Spurious Emission	2.1053 /90.691	PASS
Date of Testing: June 24, 2017~ July 3, 2017			
Note: PASS: The EUT complies with the essential requirements in the standard. FAIL: The EUT does not comply with the essential requirements in the standard.			



## 1. Test Laboratory

### 1.1. Notes of the Test Report

This report shall not be reproduced in full or partial, without the written approval of **TA technology (shanghai) co., Ltd.** The results documented in this report apply only to the tested sample, under the conditions and modes of operation as described herein .Measurement Uncertainties were not taken into account and are published for informational purposes only. This report is written to support regulatory compliance of the applicable standards stated above. This report must not be used by the client to claim product certification, approval, or endorsement by any government agencies.

### 1.2. Test facility

#### **CNAS (accreditation number:L2264)**

TA Technology (Shanghai) Co., Ltd. has obtained the accreditation of China National Accreditation Service for Conformity Assessment (CNAS).

#### **FCC (recognition number is 428261)**

TA Technology (Shanghai) Co., Ltd. has been listed on the US Federal Communications Commission list of test facilities recognized to perform electromagnetic emissions measurements.

#### **IC (recognition number is 8510A)**

TA Technology (Shanghai) Co., Ltd. has been listed by industry Canada to perform electromagnetic emission measurement.

#### **VCCI (recognition number is C-4595, T-2154, R-4113, G-10766)**

TA Technology (Shanghai) Co., Ltd. has been listed by industry Japan to perform electromagnetic emission measurement.

#### **A2LA (Certificate Number: 3857.01)**

TA Technology (Shanghai) Co., Ltd. has been listed by American Association for Laboratory Accreditation to perform electromagnetic emission measurement.



### 1.3. Testing Location

Company: TA Technology (Shanghai) Co., Ltd.  
Address: No.145, Jintang Rd, Tangzhen Industry Park, Pudong  
City: Shanghai  
Post code: 201201  
Country: P. R. China  
Contact: Xu Kai  
Telephone: +86-021-50791141/2/3  
Fax: +86-021-50791141/2/3-8000  
Website: <http://www.ta-shanghai.com>  
E-mail: [xukai@ta-shanghai.com](mailto:xukai@ta-shanghai.com)

## 2. General Description of Equipment under Test

### Client Information

Applicant	Quectel Wireless Solutions Co., Ltd.
Applicant address	7th Floor, Hongye Building, No. 1801 Hongmei Road, Xuhui District, Shanghai, China
Manufacturer	Quectel Wireless Solutions Co., Ltd.
Manufacturer address	7th Floor, Hongye Building, No. 1801 Hongmei Road, Xuhui District, Shanghai, China

### General Information

EUT Description	
Model	BG96
Hardware Version	R1.0
Software Version	BG96MAR02A02M1G
Power Supply	External power supply
Antenna Type	The EUT don't have standard Antenna, The Antenna used for testing in this report is the after-market accessory (Dipole Antenna)
Test Mode(s)	LTE Band 26;
Test Modulation	QPSK 16QAM;
LTE Category	M1
Maximum E.R.P.	LTE Band 26: 28.03dBm
Rated Power Supply Voltage	3.8V
Extreme Voltage	Minimum: 3.3V    Maximum: 4.3V
Extreme Temperature	Lowest: -40°C    Highest: +85°C
Operating Frequency Range(s)	Band
	LTE Band 26
	Tx (MHz)
	814 ~ 824
Note: The information of the EUT is declared by the manufacturer.	

Accessory equipment	
Evaluation Board	RF Cable
RS232-to-USB Cable	Antenna: Dipole Antenna
Headset	USB Cable



### 3. Applied Standards

According to the specifications of the manufacturer, it must comply with the requirements of the following standards:

**FCC CFR47 Part 2 (2016)**

**FCC CFR 47 Part 90S (2016)**

**ANSI C63.26 (2015)**

### 4. Test Configuration

Radiated measurements are performed by rotating the EUT in three different orthogonal test planes. EUT stand-up position (Z axis), lie-down position (X, Y axis). Receiver antenna polarization (horizontal and vertical), the worst emission was found in position (Z axis, vertical polarization) and the worst case was recorded.

All mode and data rates and positions were investigated.

The following testing in LTE is set based on the maximum RF Output Power.

Test modes are chosen as the worst case configuration below for LTE Band 26

Test items	Bandwidth (MHz)					Modulation		RB			Test Channel		
	1.4	3	5	10	15	QPSK	16QAM	1	50%	100%	L	M	H
RF power output	O	O	O	O	-	O	O	O	O	O	O	O	O
Effective Isotropic Radiated power	O	O	O	O	-	O	O	-	-	O	O	O	O
Occupied Bandwidth	O	O	O	O	-	O	O	-	-	O	O	O	O
Emission Mask	O	O	O	O	-	O	O	O	-	O	O	O	O
Peak-to-Average Power Ratio	O	O	O	O	-	O	O	-	-	O	O	O	O
Frequency Stability	O	O	O	O	-	O	O	-	-	O	-	O	-
Spurious Emissions at Antenna Terminals	O	O	O	O	-	O	-	O	-	-	O	O	O
Radiates Spurious Emission	O	O	O	O	-	O	-	O	-	-	O	O	O
Note	1. The mark "O" means that this configuration is chosen for testing. 2. The mark "-" means that this configuration is not testing.												



## 5. Test Case Results

### 5.1. RF Power Output

#### Ambient condition

Temperature	Relative humidity
21°C ~25°C	40%~60%

#### Methods of Measurement

During the process of the testing, The EUT is controlled by the Base Station Simulator to ensure max power transmission and proper modulation.

#### Test Setup

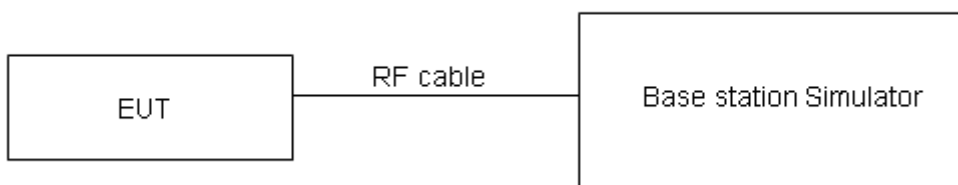

The loss between RF output port of the EUT and the input port of the tester has been taken into consideration.

#### Limits

Part 90.635 (b) the maximum output power of the transmitter for mobile stations is 100 watts.

#### Measurement Uncertainty

The assessed measurement uncertainty to ensure 95% confidence level for the normal distribution is with the coverage factor  $k = 2$ ,  $U = 0.4$  dB.



## Test Results

LTE Band 26				Conducted Power(dBm)		
BW	Modulation	RB size	RB offset	Channel/Frequency(MHz)		
				26697/814.7	26740/819	26783/823.3
1.4MHz	QPSK	1	0	22.53	22.93	21.91
		1	3	22.53	22.91	23.03
		1	5	22.47	22.86	22.80
		3	0	22.16	22.39	22.37
		3	2	22.20	22.51	22.36
		3	3	22.23	22.49	22.30
		6	0	22.33	22.40	22.28
	16QAM	1	0	23.19	23.15	22.55
		1	3	23.20	23.57	22.57
		1	5	23.59	23.29	22.29
		3	0	22.58	22.62	21.71
		3	2	22.57	22.56	21.85
		3	3	22.61	22.74	21.83
		5	0	21.68	21.41	21.29
BW	Modulation	RB size	RB offset	Channel/Frequency(MHz)		
				26705/815.5	26740/819	26775/822.5
3MHz	QPSK	1	0	22.52	22.89	21.89
		1	3	22.51	22.90	23.00
		1	5	22.44	22.81	22.76
		3	0	22.14	22.35	22.34
		3	2	22.17	22.46	22.32
		3	3	22.20	22.46	22.26
		6	0	22.31	22.36	22.23
	16QAM	1	0	23.14	23.13	22.53
		1	3	23.18	23.54	22.55
		1	5	23.56	23.25	22.26
		3	0	22.55	22.60	21.68
		3	2	22.54	22.51	21.81



BW	Modulation	RB size	RB offset	Channel/Frequency(MHz)		
				26715/816.5	26740/819	26765/822.5
5MHz	QPSK	3	3	22.59	22.70	21.80
		5	0	21.65	21.36	21.25
		1	0	22.49	22.85	21.86
		1	3	22.50	22.86	22.98
		1	5	22.42	22.80	22.73
		3	0	22.11	22.30	22.30
		3	2	22.15	22.42	22.29
	16QAM	3	3	22.17	22.41	22.22
		6	0	22.28	22.31	22.19
		1	0	23.12	23.09	22.48
		1	3	23.14	23.52	22.51
		1	5	23.54	23.22	22.24
		3	0	22.52	22.56	21.65
		3	2	22.51	22.49	21.78
10MHz	QPSK	3	3	22.56	22.65	21.76
		5	0	21.63	21.32	21.22
		1	0	/	22.53	/
		1	3	/	22.57	/
		1	5	/	22.52	/
		3	0	/	22.72	/
		3	2	/	22.79	/
	16QAM	3	3	/	22.87	/
		6	0	/	22.27	/
		1	0	/	23.10	/
		1	3	/	22.89	/
		1	5	/	22.85	/
		3	0	/	23.05	/
		3	2	/	23.10	/
BW	Modulation	RB size	RB offset	Channel/Frequency(MHz)		
				/	26740/819	/
BW	Modulation	RB size	RB offset	Channel/Frequency(MHz)		
				/	26740/819	/

## 5.2. Effective Radiated Power

### Ambient condition

Temperature	Relative humidity
21°C ~25°C	40%~60%

### Methods of Measurement

1. The testing follows ANSI C63.26 (2015) Section 5.5.2.3.
2. EUT was placed on a 0.8 meter high non-conductive stand at a 3 meter test distance from the receive antenna. A receiving antenna was placed on the antenna mast 3 meters from the EUT for emission measurements. The height of receiving antenna between 1.0m and 4.0m. Detected emissions were maximized at each frequency by rotating the EUT through 360° and adjusting the receiving antenna polarization. The radiated emission measurements of all transmit frequencies in three channels (High, Middle, Low) were measured with peak detector.
3. A log-periodic antenna or double-ridged waveguide horn antenna shall be substituted in place of the EUT. The log-periodic antenna will be driven by a signal generator and the level will be adjusted till the same power value on the spectrum analyzer or receiver. The level of the spurious emissions can be calculated through the level of the signal generator, cable loss, the gain of the substitution antenna and the reading of the spectrum analyzer or receiver.
4. The EUT is then put into continuously transmitting mode at its maximum power level during the test. Set Test Receiver or Spectrum RBW=1MHz, VBW=3MHz for above 1GHz and RBW=100kHz, VBW=300kHz for 30MHz to 1GHz, And the maximum value of the receiver should be recorded as (Pr).
5. The EUT shall be replaced by a substitution antenna. In the chamber, an substitution antenna for the frequency band of interest is placed at the reference point of the chamber. An RF Signal source for the frequency band of interest is connected to the substitution antenna with a cable that has been constructed to not interfere with the radiation pattern of the antenna. A power (PMea) is applied to the input of the substitution antenna, and adjust the level of the signal generator output until the value of the receiver reach the previously recorded (Pr). The power of signal source (PMea) is recorded. The test should be performed by rotating the test item and adjusting the receiving antenna polarization.
6. A amplifier should be connected to the Signal Source output port. And the cable should be connect between the Amplifier and the Substitution Antenna. The cable loss (Pcl), the Substitution Antenna Gain (Ga) and the Amplifier Gain (PAg) should be recorded after test.
7. The measurement results are obtained as described below:  
Power(EIRP)=PMea- PAg - Pcl + Ga  
The measurement results are amend as described below:  
Power(EIRP)=PMea- Pcl + Ga
8. This value is EIRP since the measurement is calibrated using an antenna of known gain (2.15 dBi) and known input power. ERP can be calculated from EIRP by subtracting the gain of the dipole, ERP = EIRP-2.15dBi.

**Test configuration**

**Below 1GHz:**

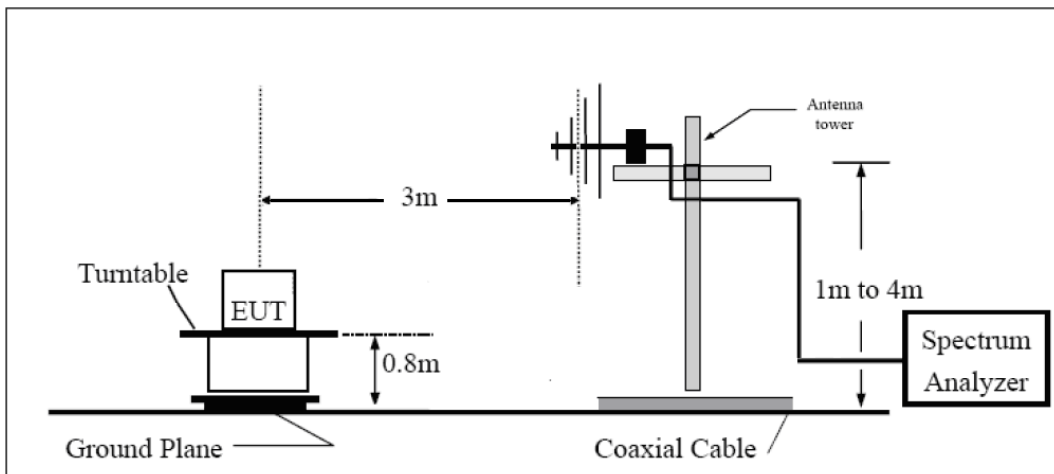

**Above 1GHz:**

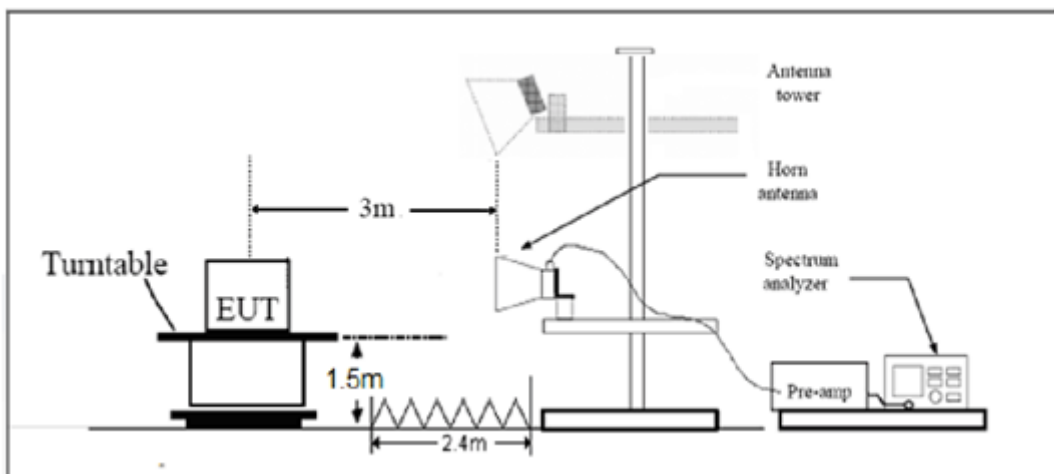

**Limits**

Rule Part 90.635(b) specifies that “The maximum output power of the transmitter for mobile stations is 100 watts”.

Limit	$\leq 100\text{ W (50 dBm)}$
-------	------------------------------

**Measurement Uncertainty**

The assessed measurement uncertainty to ensure 95% confidence level for the normal distribution is with the coverage factor  $k = 2$ ,  $U = 1.19\text{ dB}$



## Test Results:

LTE Band 26								
bandwidth	Polarization	Frequency (MHz)	Rt (dBm)	Rs (dBm)	Ps (dBm)	Gs (dBi)	ERP (dBm)	Conclusion
1.4 MHz (QPSK)	H	814.7	-27.75	-47.87	0.00	0.90	26.12	Pass
	H	819	-27.79	-47.71	0.00	1.00	27.26	Pass
	H	823.3	-27.75	-47.62	0.00	1.06	27.54	Pass
	V	814.7	-38.16	-47.78	0.00	0.90	22.95	Pass
	V	819	-38.57	-47.71	0.00	1.00	23.80	Pass
	V	823.3	-38.03	-47.33	0.00	1.06	24.17	Pass
1.4 MHz (16QAM)	H	814.7	-28.36	-47.87	0.00	0.90	25.80	Pass
	H	819	-28.37	-47.71	0.00	1.00	26.93	Pass
	H	823.3	-28.32	-47.62	0.00	1.06	27.23	Pass
	V	814.7	-38.72	-47.78	0.00	0.90	22.63	Pass
	V	819	-39.09	-47.71	0.00	1.00	23.49	Pass
	V	823.3	-38.58	-47.33	0.00	1.06	23.86	Pass
3 MHz (QPSK)	H	815.5	-27.79	-47.83	0.00	0.90	26.11	Pass
	H	819	-27.78	-47.71	0.00	1.00	27.19	Pass
	H	822.5	-27.81	-47.64	0.00	1.06	28.03	Pass
	V	815.5	-39.03	-47.71	0.00	0.90	23.33	Pass
	V	819	-39.22	-47.71	0.00	1.00	23.81	Pass
	V	822.5	-38.90	-47.36	0.00	1.06	23.93	Pass
3 MHz (16QAM)	H	815.5	-28.52	-47.83	0.00	0.90	25.80	Pass
	H	819	-28.45	-47.71	0.00	1.00	26.88	Pass
	H	822.5	-28.34	-47.64	0.00	1.06	27.70	Pass
	V	815.5	-39.59	-47.71	0.00	0.90	23.03	Pass
	V	819	-39.77	-47.71	0.00	1.00	23.49	Pass
	V	822.5	-39.44	-47.36	0.00	1.06	23.58	Pass
5 MHz (QPSK)	H	816.5	-27.96	-47.78	0.00	0.90	25.60	Pass
	H	819	-28.02	-47.71	0.00	1.00	26.86	Pass
	H	821.5	-27.83	-47.65	0.00	1.00	27.56	Pass
	V	816.5	-39.15	-47.65	0.00	0.90	23.18	Pass
	V	819	-39.43	-47.71	0.00	1.00	23.65	Pass
	V	821.5	-38.93	-47.41	0.00	1.00	22.52	Pass
5 MHz (16QAM)	H	816.5	-28.44	-47.78	0.00	0.90	25.29	Pass
	H	819	-28.51	-47.71	0.00	1.00	26.53	Pass
	H	821.5	-28.30	-47.65	0.00	1.00	27.25	Pass
	V	816.5	-39.58	-47.65	0.00	0.90	22.88	Pass
	V	819	-39.94	-47.71	0.00	1.00	23.33	Pass
	V	821.5	-39.48	-47.41	0.00	1.00	22.21	Pass
10 MHz (QPSK)	H	819	-27.73	-47.71	0.00	1.00	24.55	Pass
	V	819	-38.28	-47.71	0.00	1.00	25.26	Pass
10 MHz (16QAM)	H	819	-28.49	-47.71	0.00	1.00	26.39	Pass
	V	819	-38.94	-47.71	0.00	1.00	21.59	Pass

### 5.3. Occupied Bandwidth

#### Ambient condition

Temperature	Relative humidity
21°C ~25°C	40%~60%

#### Method of Measurement

The EUT was connected to Spectrum Analyzer and Base Station Simulator via power Splitter. The occupied bandwidth is measured using spectrum analyzer.

RBW is set to 51 kHz, VBW is set to 160 kHz for LTE Band 26.

99% power and -26dBc occupied bandwidths are recorded. Spectrum analyzer plots are included on the following pages.

#### Test Setup

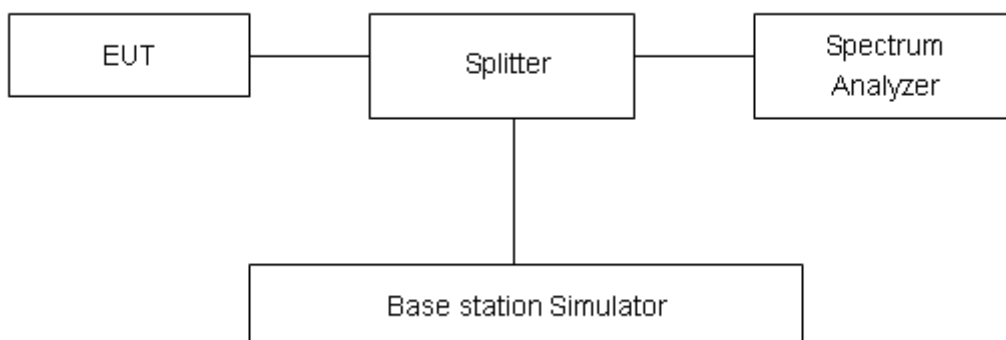

#### Limits

No specific occupied bandwidth requirements in part 2.1049.

Part 90.209 (a) Each authorization issued to a station licensed under this part will show an emission designator representing the class of emission authorized. The designator will be prefixed by a specified necessary bandwidth. This number does not necessarily indicate the bandwidth occupied by the emission at any instant. In those cases where part 2.202 of this chapter does not provide a formula for the computation of necessary bandwidth, the occupied bandwidth, as defined in part 2 of this chapter, may be used in lieu of the necessary bandwidth.

#### Measurement Uncertainty

The assessed measurement uncertainty to ensure 95% confidence level for the normal distribution is with the coverage factor  $k = 2$ ,  $U = 624\text{Hz}$ .



## Test Result

LTE Band 26						
RB	Modulation	Bandwidth (MHz)	Channel	Frequency (MHz)	99% Power Bandwidth(MHz)	-26dBc Bandwidth(MHz)
100%	QPSK	1.4	26697	814.7	1.148	1.374
			26740	819	1.1051	1.32
			26783	823.3	1.1098	1.324
		3	26705	815.5	1.1614	1.861
			26740	819	1.164	1.846
			26775	822.5	1.1626	1.855
		5	26715	816.5	1.1639	2.052
			26740	819	1.1563	2.009
			26765	821.5	1.1248	1.482
		10	26740	819	1.2021	1.911
			26740	819	1.197	1.902
			26740	819	1.1989	1.784
	16QAM	1.4	26697	814.7	1.1206	1.345
			26740	819	0.94742	1.226
			26783	823.3	0.94031	1.211
		3	26705	815.5	0.97479	1.342
			26740	819	0.98415	1.364
			26775	822.5	0.98431	1.34
		5	26715	816.5	1.10144	1.567
			26740	819	1.0058	1.572
			26765	821.5	1.0057	1.339
		10	26740	819	1.041	1.635
			26740	819	1.0503	1.647
			26740	819	1.0594	1.680





### LTE Band 26 QPSK 1.4MHz CH26697

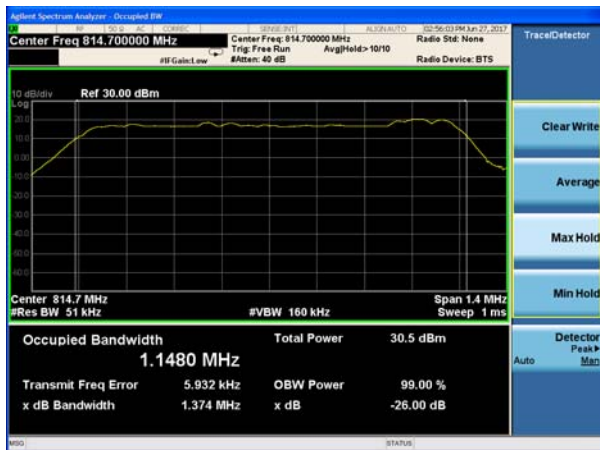

### LTE Band 26 QPSK 3MHz CH26705



### LTE Band 26 QPSK 1.4MHz CH26740

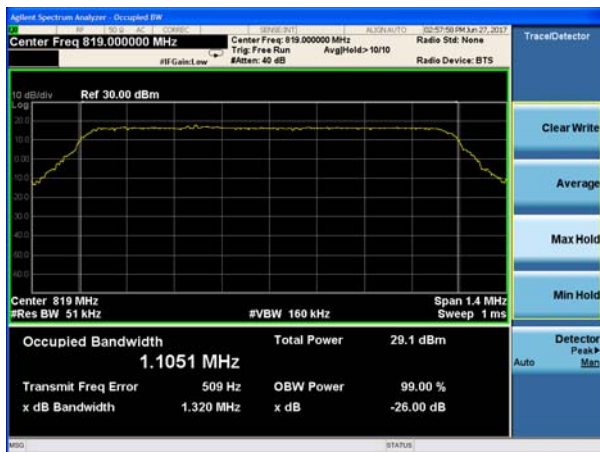

### LTE Band 26 QPSK 3MHz CH26740



### LTE Band 26 QPSK 1.4MHz CH26783

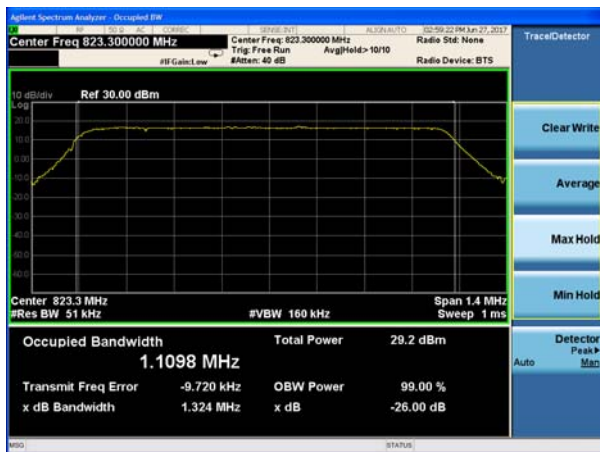

### LTE Band 26 QPSK 3MHz CH26775





### LTE Band 26 QPSK 5MHz CH26715



### LTE Band 26 QPSK 5MHz CH26740



### LTE Band 26 QPSK 5MHz CH26765



### LTE Band 26 QPSK 15MHz CH26765

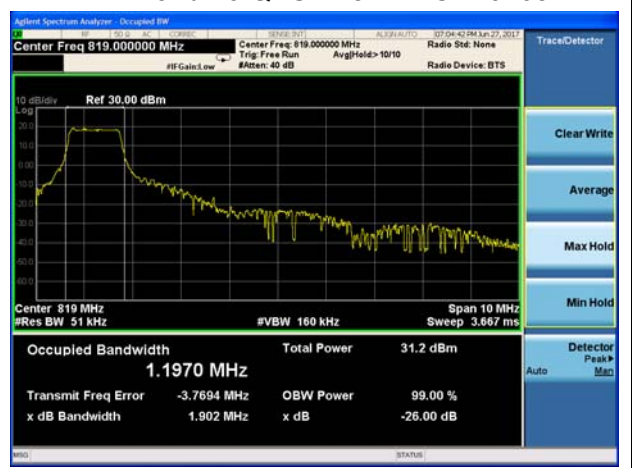

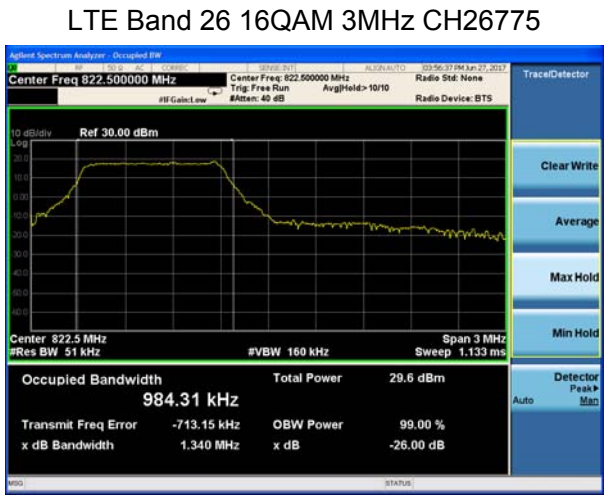
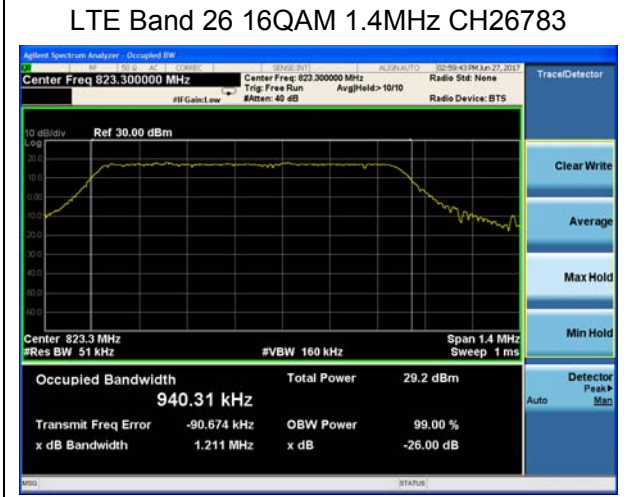
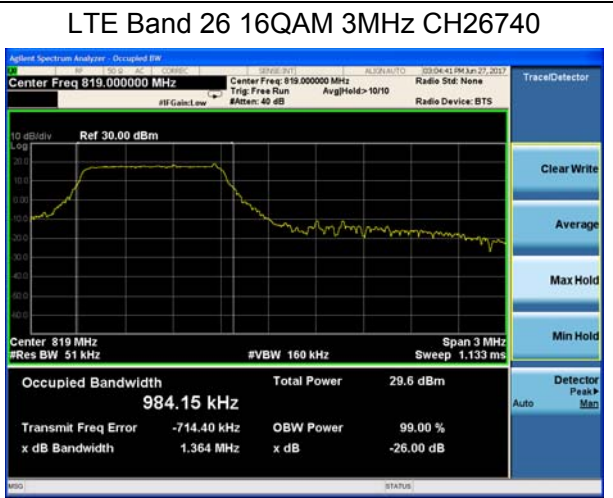
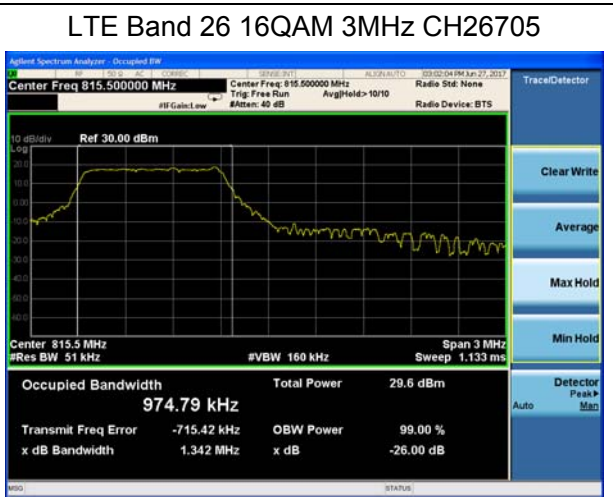



LTE Band 26 16QAM 5MHz CH26715



LTE Band 26 16QAM 5MHz CH26740



LTE Band 26 16QAM 5MHz CH26765

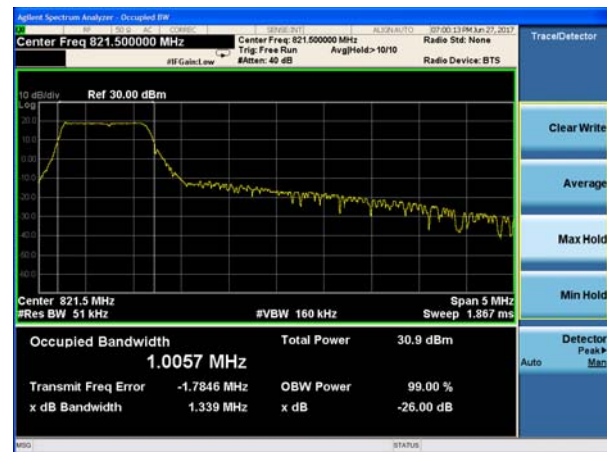

LTE Band 26 16QAM 10MHz CH26740



### 5.4. Emission Mask

#### Ambient condition

Temperature	Relative humidity
21°C ~25°C	40%~60%

#### Method of Measurement

The EUT was connected to Spectrum Analyzer and Base Station Simulator via power Splitter. The band edge of the lowest and highest channels were measured. The average detector is used. RBW is set to 51kHz,VBW is set to 160kHz for LTE Band 26. Spectrum analyzer plots are included on the following pages.

#### Test Setup

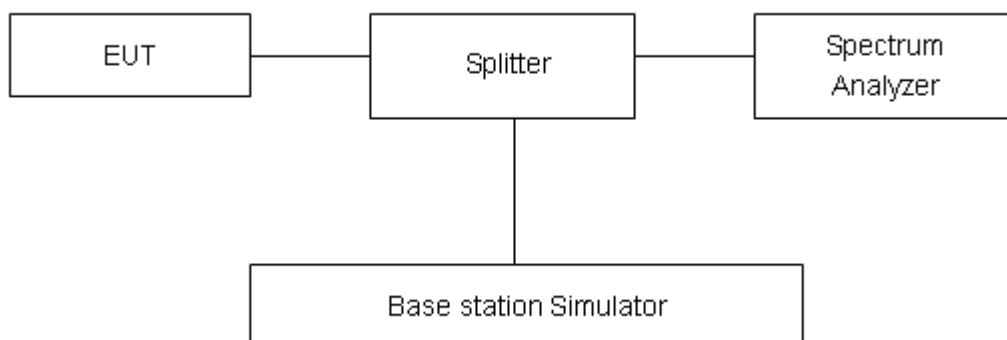

#### Limits

Rule Part 90.691(a) specifies that “ For any frequency removed from the EA licensee's frequency block by up to and including 37.5 kHz, the power of any emission shall be attenuated below the transmitter power (P) in watts by at least  $116 \text{ Log}_{10}(f/6.1)$  decibels or  $50 + 10 \text{ Log}_{10}(P)$  decibels or 80 decibels, whichever is the lesser attenuation, where f is the frequency removed from the center of the outer channel in the block in kilohertz and where f is greater than 12.5 kHz.”

#### Measurement Uncertainty

The assessed measurement uncertainty to ensure 95% confidence level for the normal distribution is with the coverage factor  $k = 1.96$ ,  $U=0.684\text{dB}$ .



Test Result:

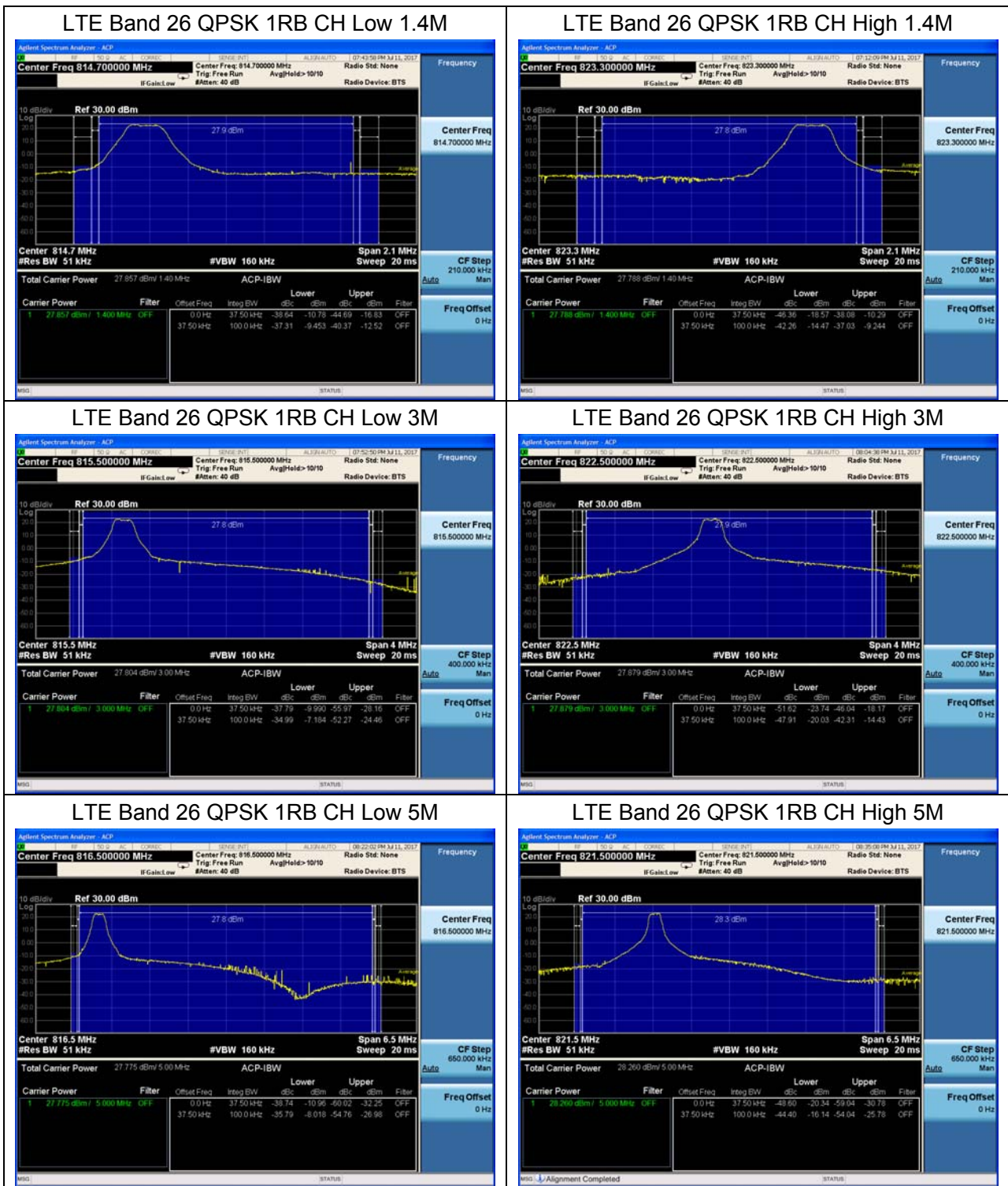



### LTE Band 26 QPSK 100%RB CH Low 1.4M

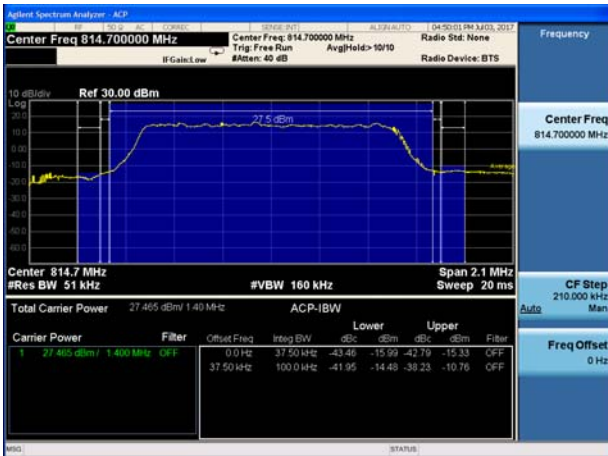

### LTE Band 26 QPSK 100%RB CH High 1.4M

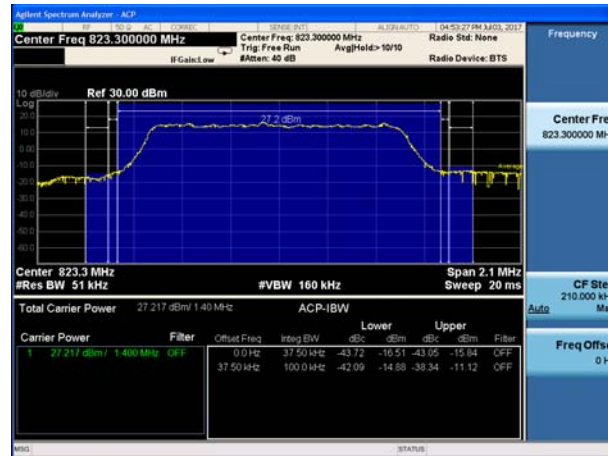

### LTE Band 26 QPSK 100%RB CH Low 3M

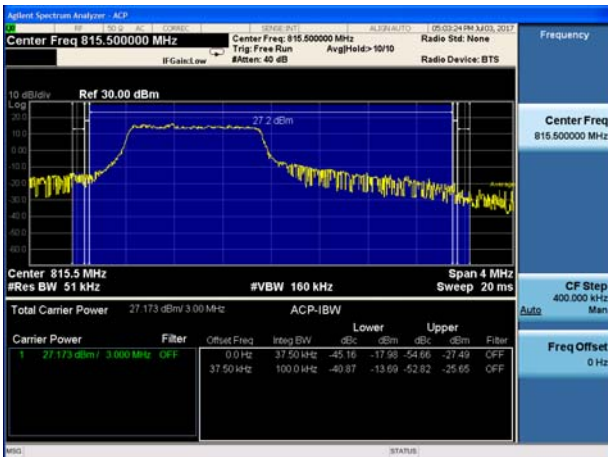

### LTE Band 26 QPSK 100%RB CH High 3M

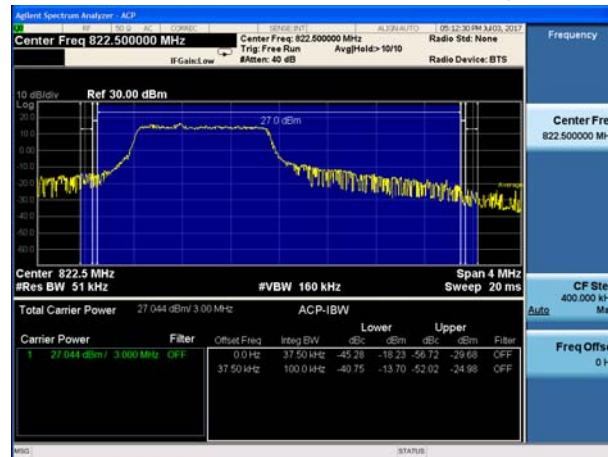

### LTE Band 26 QPSK 100%RB CH Low 5M



### LTE Band 26 QPSK 100%RB CH High 5M



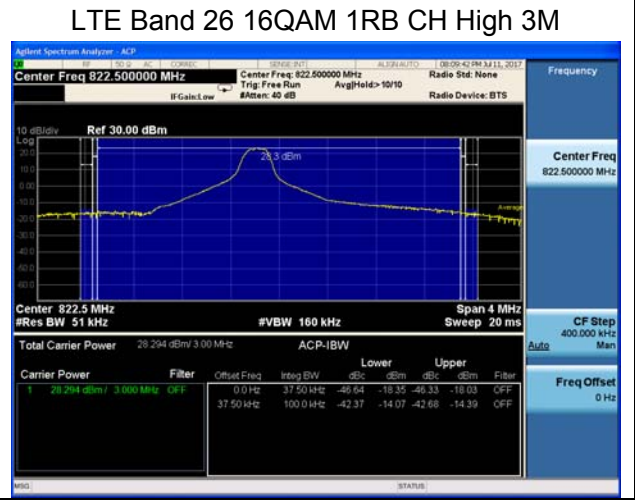
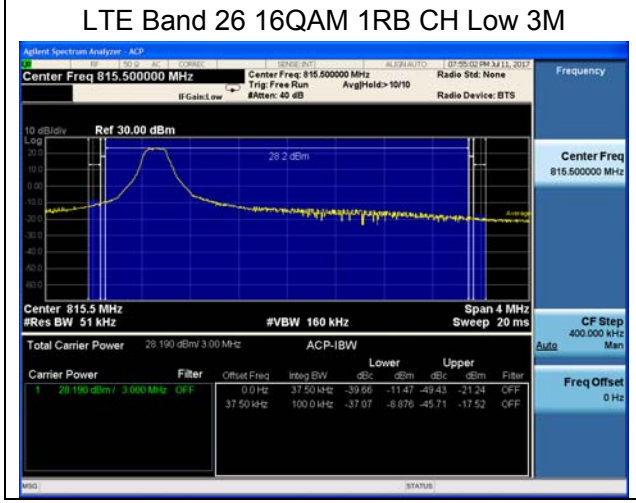
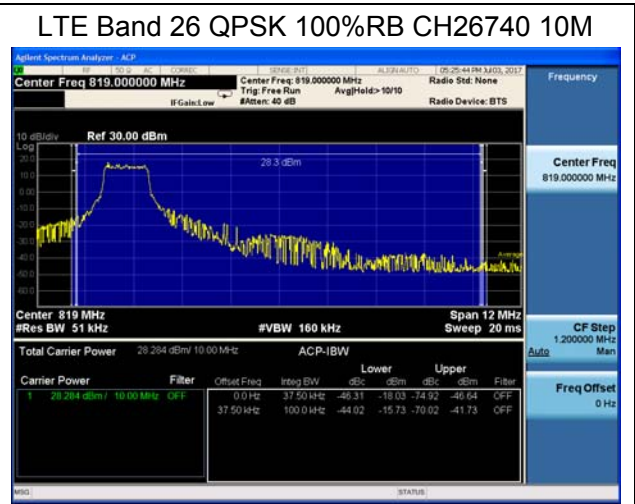



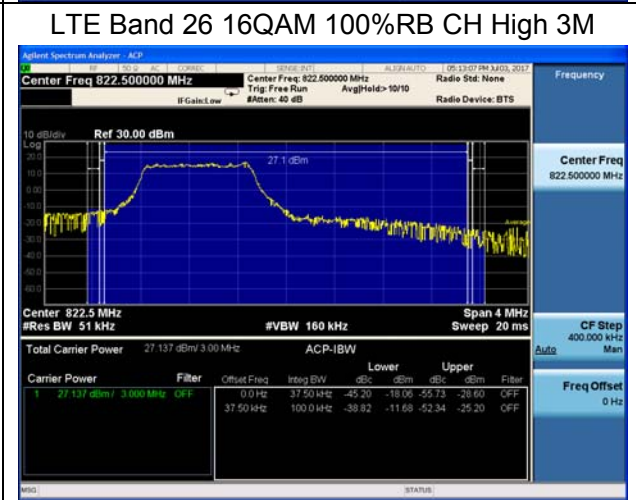
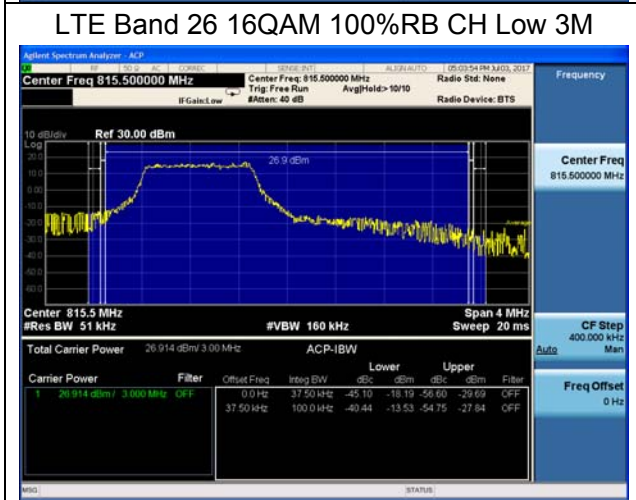
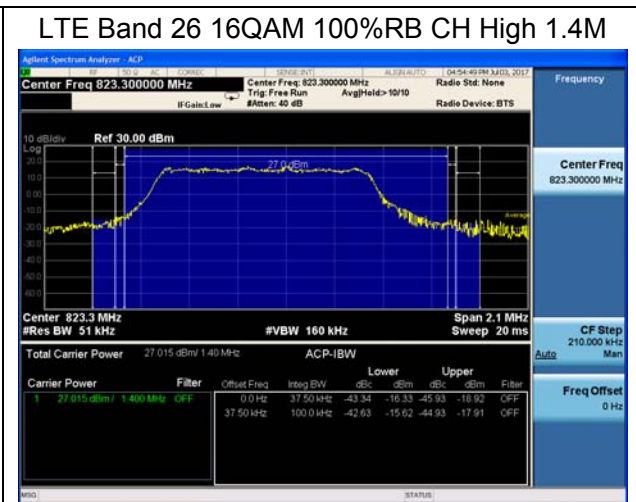
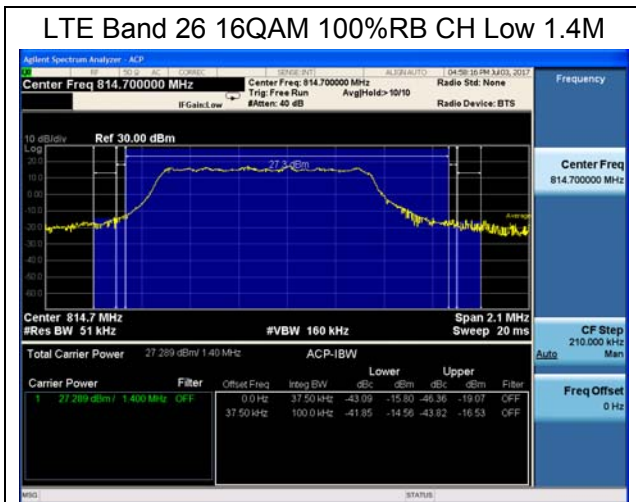
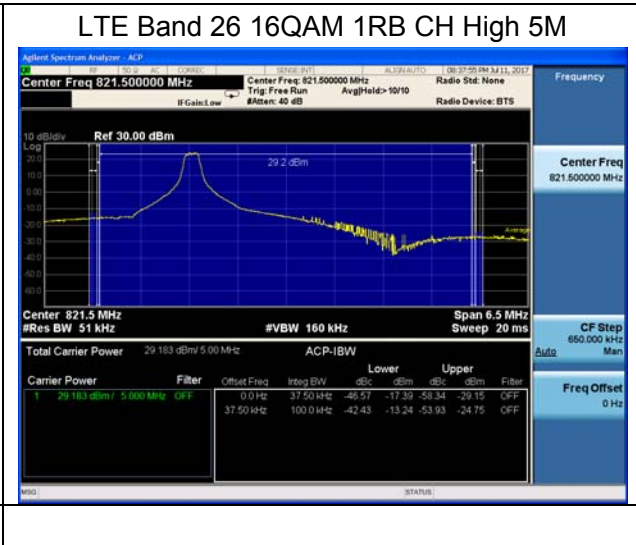
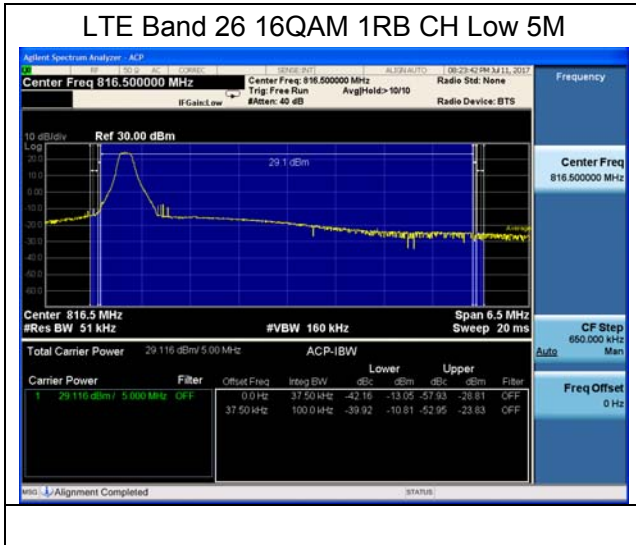



LTE Band 26 16QAM 100%RB CH Low 5M

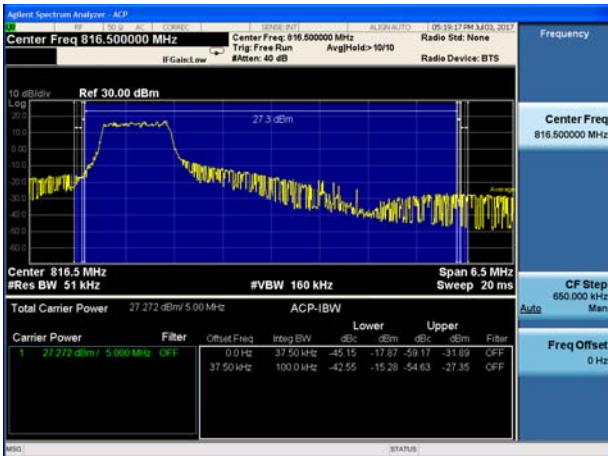

LTE Band 26 16QAM 100%RB CH High 5M



LTE Band 26 16QAM 1RB CH26740 10M



LTE Band 26 16QAM 100%RB CH26740 10M

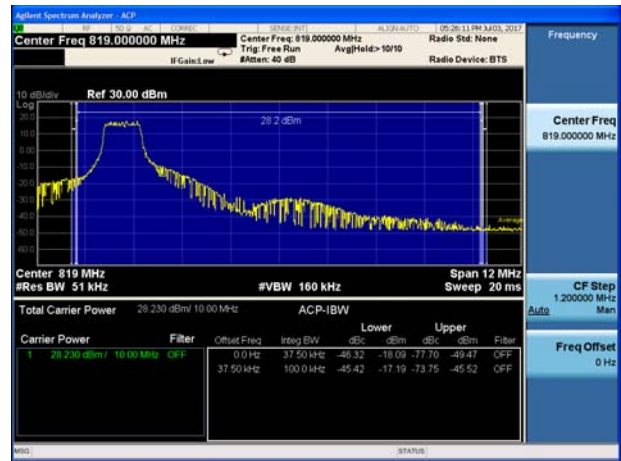

### 5.5. Peak-to-Average Power Ratio (PAPR)

#### Ambient condition

Temperature	Relative humidity
21°C ~25°C	40%~60%

#### Methods of Measurement

Measure the total peak power and record as P<sub>Pk</sub>. And measure the total average power and record as P<sub>Avg</sub>. Both the peak and average power levels must be expressed in the same logarithmic units (e.g., dBm). Determine the PAPR from:

$$PAPR (dB) = P_{Pk} (dBm) - P_{Avg} (dBm).$$

#### Test Setup

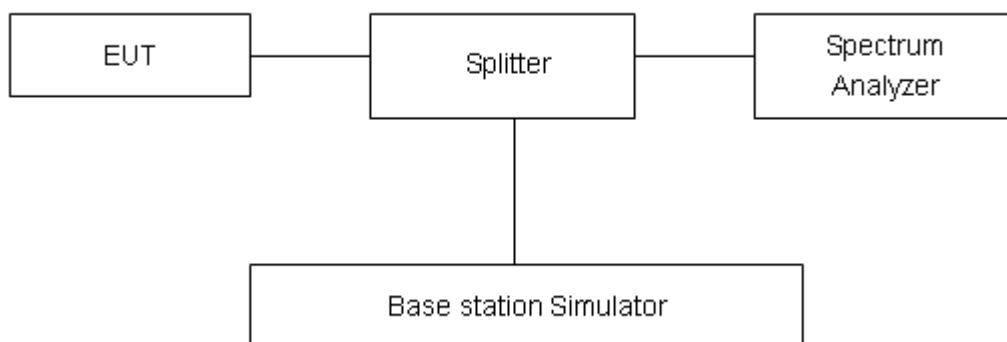

#### Limits

In measuring transmissions in this band using an average power technique, the peak-to-average ratio (PAR) of the transmission may not exceed 13 dB in 24.232(d).

#### Measurement Uncertainty

The assessed measurement uncertainty to ensure 95% confidence level for the normal distribution is with the coverage factor  $k = 2$ ,  $U = 0.4$  dB.

**Test Results**

Mode	Channel	Frequency (MHz)	Peak(dBm)	Avg(dBm)	PAPR(dB)	Limit(dB)	Conclusion
1.4 MHz (QPSK)	26697	814.7	32.81	22.33	10.48	13	PASS
	26740	819	34.06	22.40	11.66	13	PASS
	26783	823.3	34.76	22.28	12.48	13	PASS
3 MHz (QPSK)	26697	814.7	32.35	22.31	10.04	13	PASS
	26740	819	32.62	22.36	10.26	13	PASS
	26783	823.3	33.71	22.23	11.48	13	PASS
5 MHz (QPSK)	26697	814.7	32.58	22.28	10.30	13	PASS
	26740	819	32.24	22.31	9.93	13	PASS
	26783	823.3	32.38	22.19	10.19	13	PASS
10 MHz (QPSK)	26740	819	32.07	22.27	9.80	13	PASS

Mode	Channel	Frequency (MHz)	Peak(dBm)	Avg(dBm)	PAPR(dB)	Limit(dB)	Conclusion
1.4 MHz (16QAM)	26697	814.7	32.91	21.68	11.23	13	PASS
	26740	819	33.60	21.41	12.19	13	PASS
	26783	823.3	33.57	21.29	12.28	13	PASS
3 MHz (16QAM)	26697	814.7	32.94	21.65	11.29	13	PASS
	26740	819	32.35	21.36	10.99	13	PASS
	26783	823.3	33.74	21.25	12.49	13	PASS
5 MHz (16QAM)	26697	814.7	32.47	21.63	10.84	13	PASS
	26740	819	31.93	21.32	10.61	13	PASS
	26783	823.3	32.08	21.22	10.86	13	PASS
10 MHz (16QAM)	26740	819	33.21	22.56	10.65	13	PASS

## 5.6. Frequency Stability

### Ambient condition

Temperature	Relative humidity
21°C ~25°C	40%~60%

### Method of Measurement

#### 1. Frequency Stability (Temperature Variation)

The temperature inside the climate chamber is varied from -40°C to +85°C in 10°C step size,

(1) With all power removed, the temperature was decreased to 0°C and permitted to stabilize for three hours.

(2) Measure the carrier frequency with the test equipment in a “call mode”. These measurements should be made within 1 minute of powering up the mobile station, to prevent significant self warming.

(3) Repeat the above measurements at 10°C increments from -40°C to +85°C. Allow at least 1.5 hours at each temperature, un-powered, before making measurements.

#### 2. Frequency Stability (Voltage Variation)

The frequency stability shall be measured with variation of primary supply voltage as follows:

(1) Vary primary supply voltage from 85 to 115 percent of the nominal value for other than hand carried battery equipment.

(2) For hand carried, battery powered equipment, reduce primary supply voltage to the battery-operating end point which shall be specified by the manufacturer.

This transceiver is specified to operate with an input voltage of between 3.3 V and 4.3 V, with a nominal voltage of 3.8V.

### Test setup

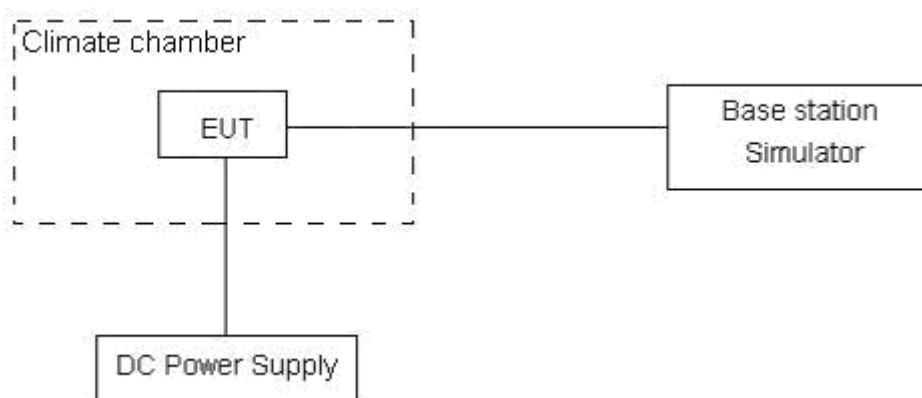

**Limits**

According to the Sec. 90.213.(a) Unless noted elsewhere, transmitters used in the services governed by this part must have a minimum frequency stability as specified in the following table.

Minimum Frequency Stability

[Parts per million (ppm)]

Frequency range (MHz)	Fixed and base stations	Mobile stations	
		Over 2 watts output power	2 watts or less output power
809-824	1.5	2.5	2.5

**Measurement Uncertainty**

The assessed measurement uncertainty to ensure 99.75% confidence level for the normal distribution is with the coverage factor  $k = 3$ ,  $U = 0.01$  ppm.



## Test Result

Bandwidth	Test status	LTE Band 26 Test Results (ppm)			
		QPSK	16QAM	Limit	Conclusion
1.4MHz Middle Channel	-40°C/Normal Voltage	-0.00381	0.00018	2.5	PASS
	-30°C/Normal Voltage	-0.00313	0.00288	2.5	PASS
	-20°C/Normal Voltage	0.00072	-0.02017	2.5	PASS
	-10°C/Normal Voltage	0.00161	-0.01818	2.5	PASS
	0°C/Normal Voltage	-0.00385	-0.00747	2.5	PASS
	10°C/Normal Voltage	-0.00264	-0.00432	2.5	PASS
	20°C/Normal Voltage	-0.00183	-0.00996	2.5	PASS
	30°C/Normal Voltage	-0.00094	-0.00877	2.5	PASS
	40°C/Normal Voltage	-0.00387	-0.00379	2.5	PASS
	50°C/Normal Voltage	-0.00018	-0.00792	2.5	PASS
	60°C/Normal Voltage	0.00083	-0.00632	2.5	PASS
	70°C/Normal Voltage	-0.00477	-0.00477	2.5	PASS
	80°C/Normal Voltage	-0.00319	-0.00874	2.5	PASS
	85°C/Normal Voltage	-0.00227	0.00359	2.5	PASS
	20°C/Minimum Voltage	-0.00033	0.00215	2.5	PASS
	20°C/Maximum Voltage	-0.00089	-0.00433	2.5	PASS
3MHz Middle Channel	-40°C/Normal Voltage	-0.00313	-0.01863	2.5	PASS
	-30°C/Normal Voltage	-0.00438	-0.01245	2.5	PASS
	-20°C/Normal Voltage	-0.00495	0.02596	2.5	PASS
	-10°C/Normal Voltage	0.00023	0.02973	2.5	PASS
	0°C/Normal Voltage	-0.00158	-0.00747	2.5	PASS
	10°C/Normal Voltage	-0.00481	-0.01158	2.5	PASS
	20°C/Normal Voltage	-0.00422	-0.03084	2.5	PASS
	30°C/Normal Voltage	-0.00343	-0.02609	2.5	PASS
	40°C/Normal Voltage	-0.00021	-0.02883	2.5	PASS
	50°C/Normal Voltage	-0.00053	0.02968	2.5	PASS
	60°C/Normal Voltage	-0.00360	0.03237	2.5	PASS
	70°C/Normal Voltage	0.00111	-0.00360	2.5	PASS
	80°C/Normal Voltage	-0.00516	-0.00386	2.5	PASS
	85°C/Normal Voltage	-0.00264	-0.00379	2.5	PASS
	20°C/Minimum Voltage	-0.00335	0.00779	2.5	PASS
	20°C/Maximum Voltage	-0.00159	0.00349	2.5	PASS
5MHz Middle Channel	-40°C/Normal Voltage	-0.00508	-0.01863	2.5	PASS
	-30°C/Normal Voltage	-0.00248	-0.02056	2.5	PASS
	-20°C/Normal Voltage	-0.00195	-0.01493	2.5	PASS



	-10°C/Normal Voltage	-0.00072	-0.00397	2.5	PASS
	0°C/Normal Voltage	0.00077	-0.00630	2.5	PASS
	10°C/Normal Voltage	0.00021	-0.00745	2.5	PASS
	20°C/Normal Voltage	-0.00501	-0.01040	2.5	PASS
	30°C/Normal Voltage	-0.00322	-0.01082	2.5	PASS
	40°C/Normal Voltage	-0.00360	-0.01161	2.5	PASS
	50°C/Normal Voltage	-0.00463	-0.02360	2.5	PASS
	60°C/Normal Voltage	-0.00250	-0.00319	2.5	PASS
	70°C/Normal Voltage	-0.00267	-0.00573	2.5	PASS
	80°C/Normal Voltage	-0.00324	-0.01908	2.5	PASS
	85°C/Normal Voltage	-0.00044	-0.01856	2.5	PASS
	20°C/Minimum Voltage	-0.00342	-0.01999	2.5	PASS
	20°C/Maximum Voltage	0.00076	-0.02177	2.5	PASS
	10MHz Middle Channel	-40°C/Normal Voltage	-0.00402	0.03463	2.5
-30°C/Normal Voltage		-0.00288	0.03072	2.5	PASS
-20°C/Normal Voltage		-0.00256	-0.01612	2.5	PASS
-10°C/Normal Voltage		-0.00321	0.00062	2.5	PASS
0°C/Normal Voltage		-0.00145	0.00482	2.5	PASS
10°C/Normal Voltage		-0.00147	0.00247	2.5	PASS
20°C/Normal Voltage		-0.00072	-0.00316	2.5	PASS
30°C/Normal Voltage		0.00032	-0.00020	2.5	PASS
40°C/Normal Voltage		0.00106	0.02017	2.5	PASS
50°C/Normal Voltage		-0.00198	0.01612	2.5	PASS
60°C/Normal Voltage		-0.00441	0.01584	2.5	PASS
70°C/Normal Voltage		-0.00482	-0.00115	2.5	PASS
80°C/Normal Voltage		-0.00308	-0.01168	2.5	PASS
85°C/Normal Voltage		-0.00045	-0.01050	2.5	PASS
20°C/Minimum Voltage		-0.00115	0.03050	2.5	PASS
20°C/Maximum Voltage		0.00083	0.03220	2.5	PASS



### 5.7. Spurious Emissions at Antenna Terminals

#### Ambient condition

Temperature	Relative humidity
21°C ~25°C	40%~60%

#### Method of Measurement

The EUT was connected to Spectrum Analyzer and Base Station Simulator via power Splitter. The measurement is carried out using a spectrum analyzer. The spectrum analyzer scans from 30MHz to the 10th harmonic of the carrier. The peak detector is used. RBW and VBW are set to 100 kHz, Sweep is set to ATUO.

#### Test setup

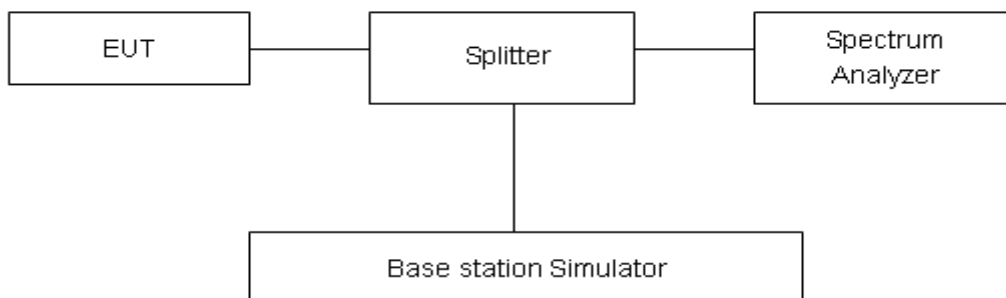

#### Limits

Rule Part 90.691 specifies that “The power of any emission outside of the authorized operating frequency ranges must be attenuated below the transmitting power (P) by a factor of at least 43 + 10 log (P) dB.”

Limit	-13 dBm
-------	---------

#### Measurement Uncertainty

The assessed measurement uncertainty to ensure 99.75% confidence level for the normal distribution is with the coverage factor  $k = 1.96$ .

Frequency	Uncertainty
100kHz-2GHz	0.684 dB
2GHz-12.75GHz	1.407 dB

### Test Result

If disturbances were found more than 20dB below limit line, the mark is not required for the EUT.  
The signal beyond the limit is carrier.

LTE Band 26 1.4MHz CH Low 30MHz~1.5GHz

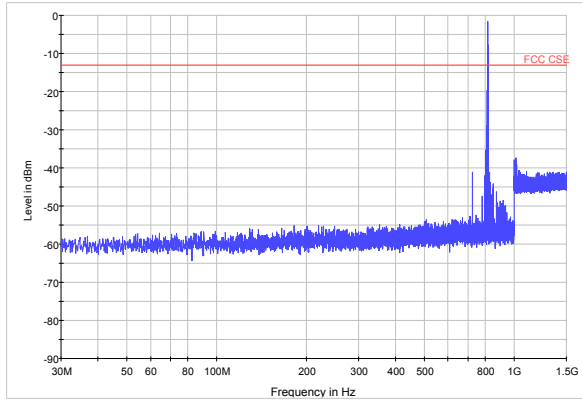

LTE Band 26 1.4MHz CH Low 1.5GHz~9GHz

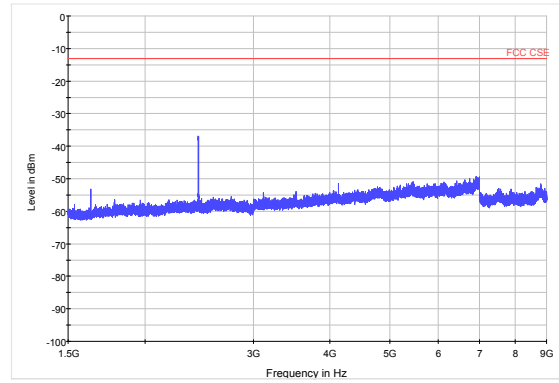

LTE Band 26 1.4MHz CH Middle 30MHz~1.5GHz

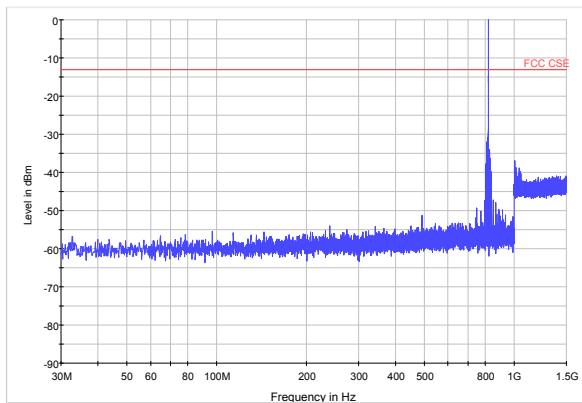

LTE Band 26 1.4MHz CH Middle 1.5GHz~9GHz

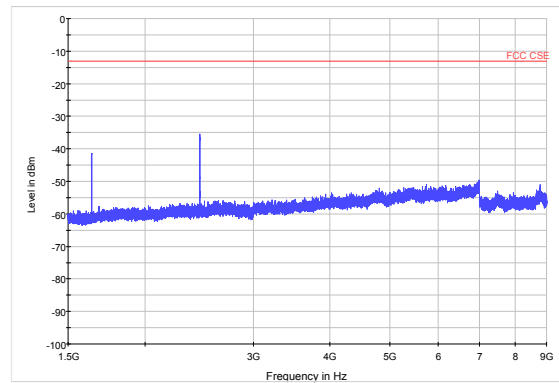

LTE Band 26 1.4MHz CH High 30MHz~1.5GHz

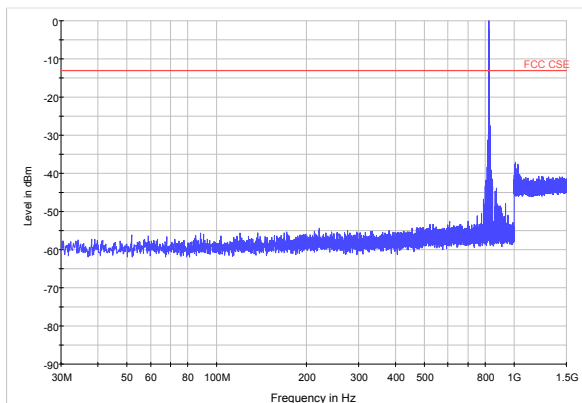

LTE Band 26 1.4MHz CH High 1.5GHz~9GHz

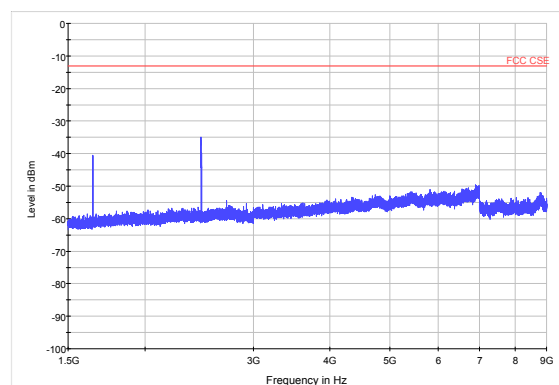



LTE Band 26 3MHz CH Low 30MHz~1.5GHz

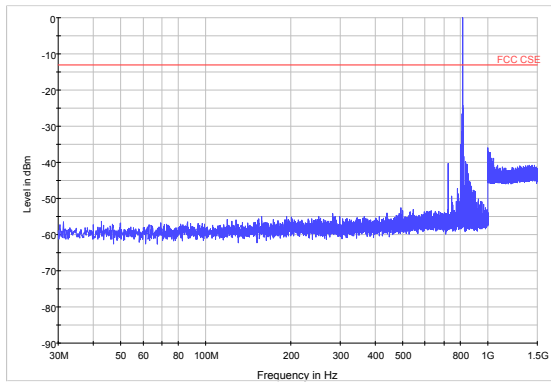

LTE Band 26 3MHz CH Low 1.5GHz~9GHz

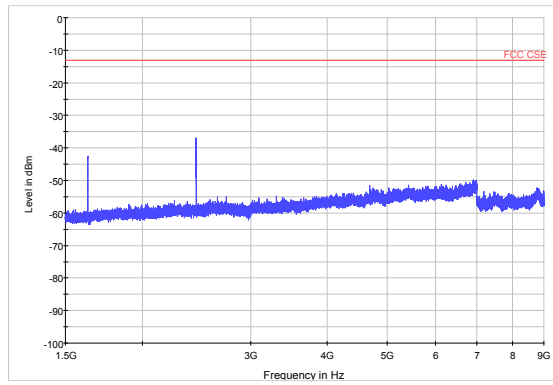

LTE Band 26 3MHz CH Middle 30MHz~1.5GHz

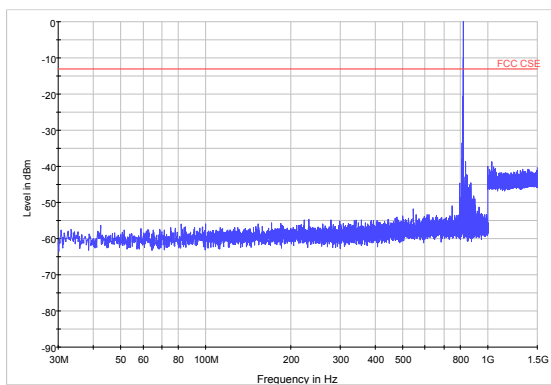

LTE Band 26 3MHz CH Middle 1.5GHz~9GHz

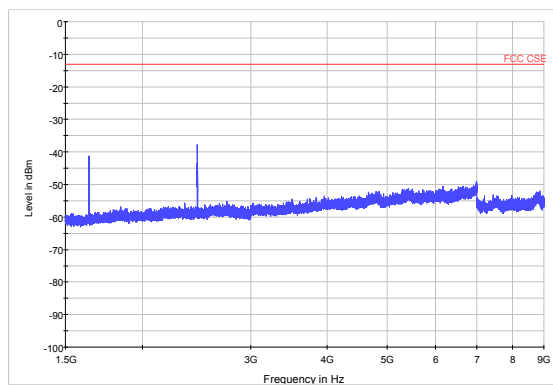

LTE Band 26 3MHz CH High 30MHz~1.5GHz

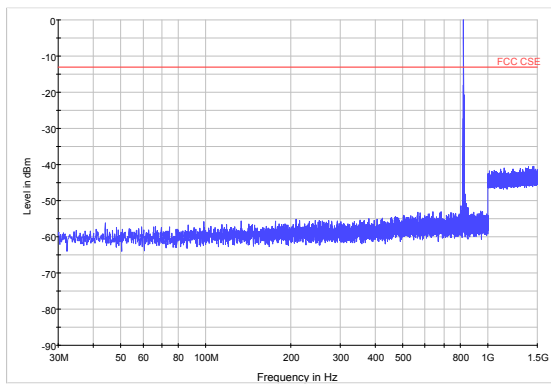

LTE Band 26 3MHz CH High 1.5GHz~9GHz

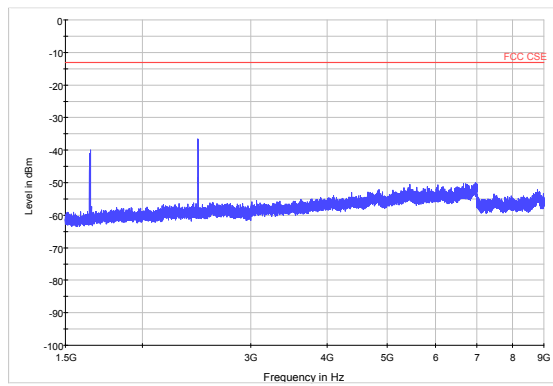



LTE Band 26 5MHz CH Low 30MHz~1.5GHz

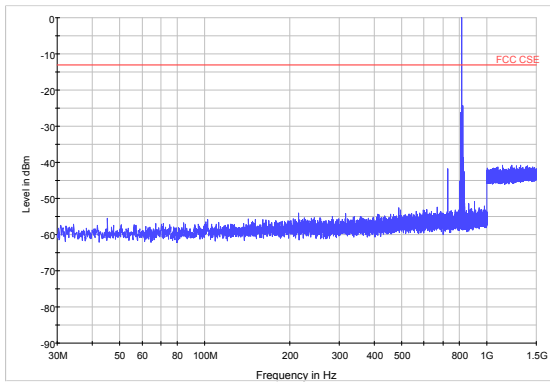

LTE Band 26 5MHz CH Low 1.5GHz~9GHz

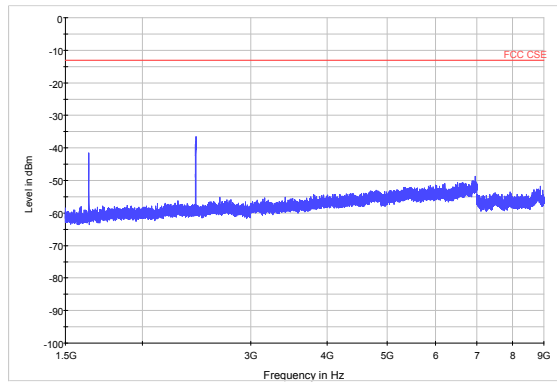

LTE Band 26 5MHz CH Middle 30MHz~1.5GHz

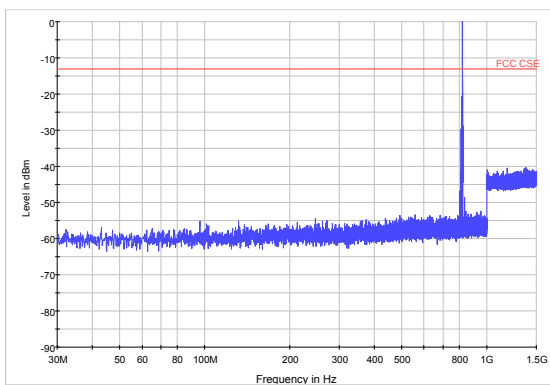

LTE Band 26 5MHz CH Middle 1.5GHz~9GHz

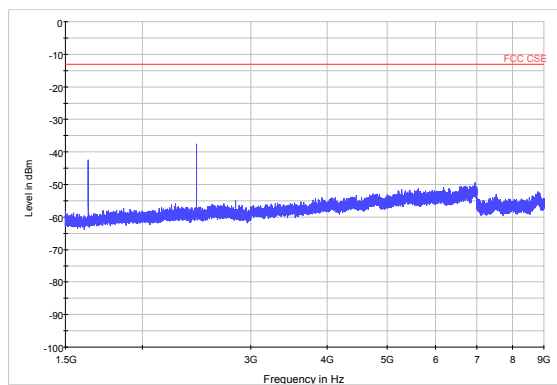

LTE Band 26 5MHz CH High 30MHz~1.5GHz

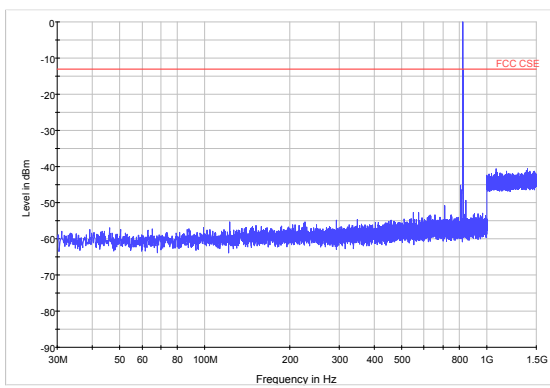

LTE Band 26 5MHz CH High 1.5GHz~9GHz

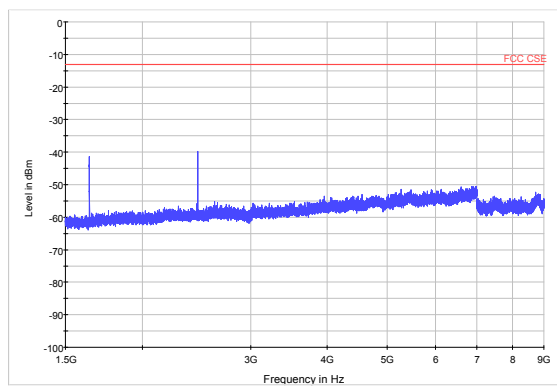



LTE Band 26 10MHz CH Middle 30MHz~1.5GHz

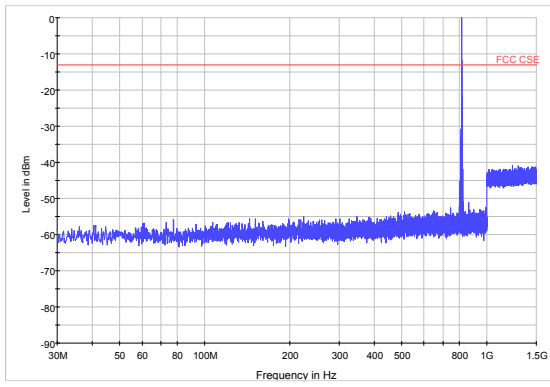

LTE Band 26 10MHz CH Middle 1.5GHz~9GHz

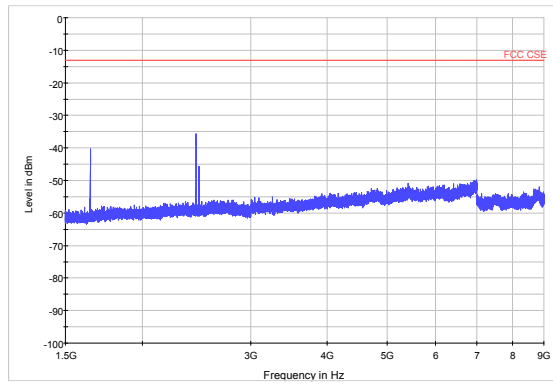

## 5.8. Radiates Spurious Emission

### Ambient condition

Temperature	Relative humidity
21°C ~25°C	40%~60%

### Method of Measurement

1. The testing follows ANSI C63.26 (2015) Section 5.5.2.3.
2. Above 30MHz: The EUT is placed on a turntable 0.8 meters above the ground in the chamber, 3 meter away from the antenna. The maximal emission value is acquired by adjusting the antenna height, polarisation and turntable azimuth. Normally, the height range of antenna is 1 m to 4 m, the azimuth range of turntable is 0° to 360°, and the receive antenna has two polarizations Vertical (V) and Horizontal (H). Above 1GHz: (Note: the FCC's permission to use 1.5m as an alternative per TCBC Conf call of Dec. 2, 2014.) The EUT is placed on a turntable 1.5 meters above the ground in the chamber, 3 meter away from the antenna. The maximal emission value is acquired by adjusting the antenna height, polarisation and turntable azimuth. Normally, the height range of antenna is 1 m to 4 m, the azimuth range of turntable is 0° to 360°, and the receive antenna has two polarizations Vertical (V) and Horizontal (H).
3. A log-periodic antenna or double-ridged waveguide horn antenna shall be substituted in place of the EUT. The log-periodic antenna will be driven by a signal generator and the level will be adjusted till the same power value on the spectrum analyzer or receiver. The level of the spurious emissions can be calculated through the level of the signal generator, cable loss, the gain of the substitution antenna and the reading of the spectrum analyzer or receiver.
4. The EUT is then put into continuously transmitting mode at its maximum power level during the test. Set Test Receiver or Spectrum RBW=1MHz, VBW=3MHz for above 1GHz and RBW=100kHz, VBW=300kHz for 30MHz to 1GHz, And the maximum value of the receiver should be recorded as (Pr).
5. The EUT shall be replaced by a substitution antenna. In the chamber, an substitution antenna for the frequency band of interest is placed at the reference point of the chamber. An RF Signal source for the frequency band of interest is connected to the substitution antenna with a cable that has been constructed to not interfere with the radiation pattern of the antenna. A power (PMea) is applied to the input of the substitution antenna, and adjust the level of the signal generator output until the value of the receiver reach the previously recorded (Pr). The power of signal source (PMea) is recorded. The test should be performed by rotating the test item and adjusting the receiving antenna polarization.
6. A amplifier should be connected to the Signal Source output port. And the cable should be connect between the Amplifier and the Substitution Antenna. The cable loss (Pcl), the Substitution Antenna Gain (Ga) and the Amplifier Gain (PAg) should be recorded after test.
7. The measurement results are obtained as described below:  
Power(EIRP)=PMea- PAg - Pcl + Ga  
The measurement results are amend as described below:  
Power(EIRP)=PMea- Pcl + Ga
8. This value is EIRP since the measurement is calibrated using an antenna of known gain (2.15 dBi)

and known input power. ERP can be calculated from EIRP by subtracting the gain of the dipole,  $ERP = EIRP - 2.15\text{dBi}$ .

**Test setup**

**30MHz~~~ 1GHz**

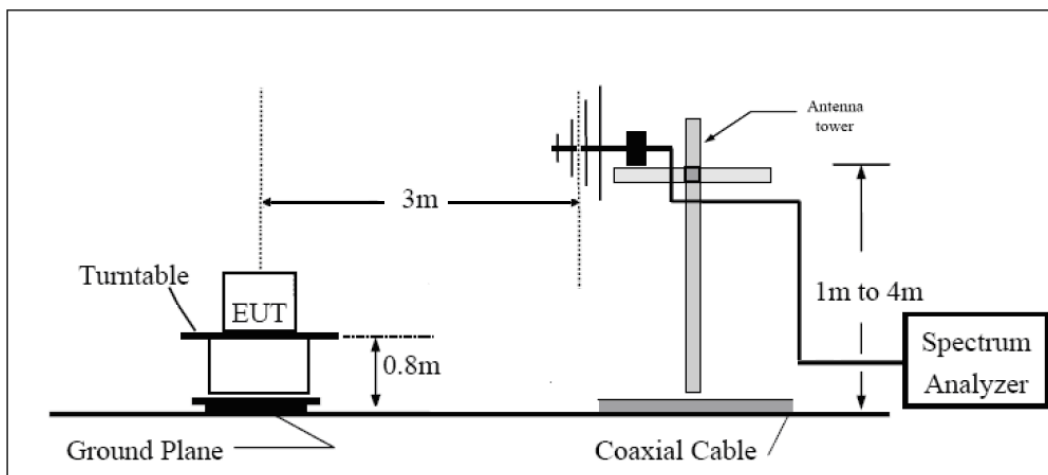

**Above 1GHz**

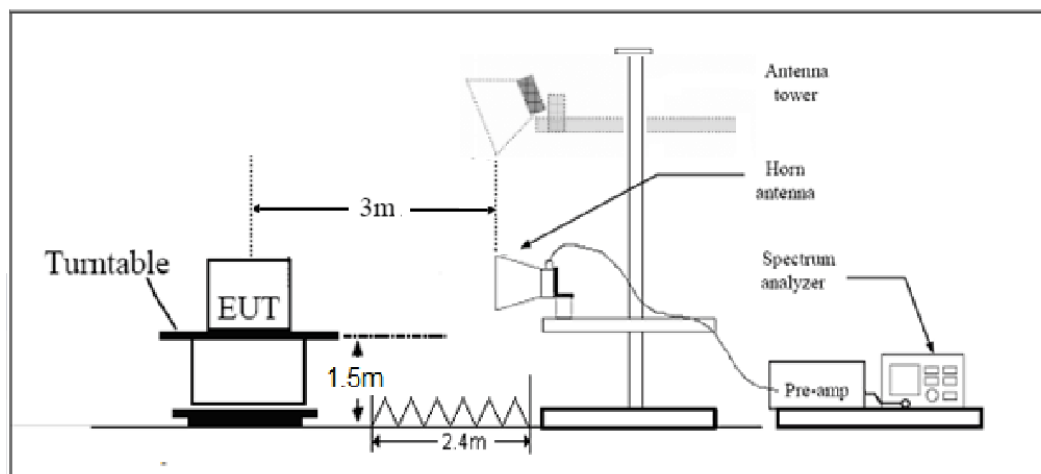

Note: Area side:2.4mX3.6m

The radiated emission was measured in the following position: EUT lie-down position (Z axis), stand-up position (X, Y axis). The worst emission was found in lie-down position (Z axis) and the worst case was recorded.

**Limits**

Rule Part 90.691 specifies that “The power of any emission outside of the authorized operating frequency ranges must be attenuated below the transmitting power (P) by a factor of at least  $43 + 10 \log(P)$  dB.”



Limit	-13 dBm
-------	---------

**Measurement Uncertainty**

The assessed measurement uncertainty to ensure 95% confidence level for the normal distribution is with the coverage factor  $k = 1.96$ ,  $U = 3.55$  dB.



**Test Result**

Note: 1.Receiver antenna polarization (horizontal and vertical), the worst emission was found in vertical polarization, and the worst case in vertical polarization was recorded.

2. The other Spurious RF Radiated emissions level is no more than noise floor.

LTE Band 26 1.4MHz CH Low

Harmonic	Frequency (MHz)	SG (dBm)	Cable Loss (dB)	Gain (dBi)	Antenna Polarization	ERP Level (dBm)	Limit (dBm)	Margin (dB)	Azimuth (deg)
2	1628.4	-59.75	2.00	10.75	vertical	-51.0	-13	38.0	90
3	2442.8	-53.84	2.51	11.05	vertical	-45.3	-13	32.3	45
4	3258.8	-57.65	4.20	11.15	vertical	-50.7	-13	37.7	180
5	4073.5	-55.45	5.20	11.15	vertical	-49.5	-13	36.5	225
6	4888.2	-53.95	5.50	11.95	vertical	-47.5	-13	34.5	135
7	5702.9	-54.45	5.70	13.55	vertical	-46.6	-13	33.6	90
8	6517.6	-52.75	6.30	13.75	vertical	-45.3	-13	32.3	45
9	7332.3	-48.55	6.80	13.85	vertical	-41.5	-13	28.5	180
10	8147.0	-48.65	6.90	14.25	vertical	-41.3	-13	28.3	225

LTE Band 26 1.4MHz CH Middle

Harmonic	Frequency (MHz)	SG (dBm)	Cable Loss (dB)	Gain (dBi)	Antenna Polarization	ERP Level (dBm)	Limit (dBm)	Margin (dB)	Azimuth (deg)
2	1628.4	-58.05	2.00	10.75	vertical	-49.3	-13	36.3	135
3	2442.8	-52.34	2.51	11.05	vertical	-43.8	-13	30.8	90
4	3276.0	-56.65	4.20	11.15	vertical	-49.7	-13	36.7	45
5	4095.0	-55.05	5.20	11.15	vertical	-49.1	-13	36.1	180
6	4914.0	-54.05	5.50	11.95	vertical	-47.6	-13	34.6	225
7	5733.0	-53.45	5.70	13.55	vertical	-45.6	-13	32.6	135
8	6552.0	-53.05	6.30	13.75	vertical	-45.6	-13	32.6	90
9	7371.0	-47.95	6.80	13.85	vertical	-40.9	-13	27.9	45
10	8190.0	-47.15	6.90	14.25	vertical	-39.8	-13	26.8	180



## LTE Band 26 1.4MHz CH High

Harmonic	Frequency (MHz)	SG (dBm)	Cable Loss (dB)	Gain (dBi)	Antenna Polarization	ERP Level (dBm)	Limit (dBm)	Margin (dB)	Azimuth (deg)
2	1645.5	-54.35	2.00	10.75	vertical	-45.6	-13	32.6	225
3	2468.6	-56.84	2.51	11.05	vertical	-48.3	-13	35.3	135
4	3293.2	-58.45	4.20	11.15	vertical	-51.5	-13	38.5	90
5	4116.5	-55.05	5.20	11.15	vertical	-49.1	-13	36.1	45
6	4939.8	-53.95	5.50	11.95	vertical	-47.5	-13	34.5	180
7	5763.1	-54.65	5.70	13.55	vertical	-46.8	-13	33.8	225
8	6586.4	-52.35	6.30	13.75	vertical	-44.9	-13	31.9	135
9	7409.7	-48.15	6.80	13.85	vertical	-41.1	-13	28.1	90
10	8233.0	-48.15	6.90	14.25	vertical	-40.8	-13	27.8	45

## LTE Band 26 3MHz CH Low

Harmonic	Frequency (MHz)	SG (dBm)	Cable Loss (dB)	Gain (dBi)	Antenna Polarization	ERP Level (dBm)	Limit (dBm)	Margin (dB)	Azimuth (deg)
2	1628.4	-60.05	2.00	10.75	vertical	-51.3	-13	38.3	180
3	2442.8	-56.04	2.51	11.05	vertical	-47.5	-13	34.5	225
4	3262.0	-57.25	4.20	11.15	vertical	-50.3	-13	37.3	135
5	4077.5	-55.45	5.20	11.15	vertical	-49.5	-13	36.5	90
6	4893.0	-53.85	5.50	11.95	vertical	-47.4	-13	34.4	45
7	5708.5	-54.45	5.70	13.55	vertical	-46.6	-13	33.6	180
8	6524.0	-53.35	6.30	13.75	vertical	-45.9	-13	32.9	225
9	7339.5	-48.55	6.80	13.85	vertical	-41.5	-13	28.5	135
10	8155.0	-48.45	6.90	14.25	vertical	-41.1	-13	28.1	90

## LTE Band 26 3MHz CH Middle

Harmonic	Frequency (MHz)	SG (dBm)	Cable Loss (dB)	Gain (dBi)	Antenna Polarization	ERP Level (dBm)	Limit (dBm)	Margin (dB)	Azimuth (deg)
2	1635.6	-59.15	2.00	10.75	vertical	-50.4	-13	37.4	45
3	2453.1	-55.84	2.51	11.05	vertical	-47.3	-13	34.3	180
4	3276.0	-57.15	4.20	11.15	vertical	-50.2	-13	37.2	225
5	4095.0	-55.15	5.20	11.15	vertical	-49.2	-13	36.2	135
6	4914.0	-54.05	5.50	11.95	vertical	-47.6	-13	34.6	90
7	5733.0	-53.45	5.70	13.55	vertical	-45.6	-13	32.6	45
8	6552.0	-53.05	6.30	13.75	vertical	-45.6	-13	32.6	180
9	7371.0	-48.95	6.80	13.85	vertical	-41.9	-13	28.9	225
10	8190.0	-47.15	6.90	14.25	vertical	-39.8	-13	26.8	135



## LTE Band 26 3MHz CH High

Harmonic	Frequency (MHz)	SG (dBm)	Cable Loss (dB)	Gain (dBi)	Antenna Polarization	ERP Level (dBm)	Limit (dBm)	Margin (dB)	Azimuth (deg)
2	1642.1	-56.25	2.00	10.75	vertical	-47.5	-13	34.5	90
3	2463.6	-53.64	2.51	11.05	vertical	-45.1	-13	32.1	45
4	3290.0	-57.45	4.20	11.15	vertical	-50.5	-13	37.5	180
5	4112.5	-55.35	5.20	11.15	vertical	-49.4	-13	36.4	225
6	4935.0	-53.75	5.50	11.95	vertical	-47.3	-13	34.3	135
7	5757.5	-54.65	5.70	13.55	vertical	-46.8	-13	33.8	90
8	6580.0	-52.35	6.30	13.75	vertical	-44.9	-13	31.9	45
9	7402.5	-48.85	6.80	13.85	vertical	-41.8	-13	28.8	180
10	8225.0	-48.15	6.90	14.25	vertical	-40.8	-13	27.8	225

## LTE Band 26 5MHz CH Low

Harmonic	Frequency (MHz)	SG (dBm)	Cable Loss (dB)	Gain (dBi)	Antenna Polarization	ERP Level (dBm)	Limit (dBm)	Margin (dB)	Azimuth (deg)
2	1628.4	-60.55	2.00	10.75	vertical	-51.8	-13	38.8	135
3	2442.9	-54.84	2.51	11.05	vertical	-46.3	-13	33.3	90
4	3266.0	-58.15	4.20	11.15	vertical	-51.2	-13	38.2	45
5	4082.5	-55.15	5.20	11.15	vertical	-49.2	-13	36.2	180
6	4899.0	-54.35	5.50	11.95	vertical	-47.9	-13	34.9	225
7	5715.5	-53.45	5.70	13.55	vertical	-45.6	-13	32.6	135
8	6532.0	-53.05	6.30	13.75	vertical	-45.6	-13	32.6	90
9	7348.5	-48.95	6.80	13.85	vertical	-41.9	-13	28.9	45
10	8165.0	-48.15	6.90	14.25	vertical	-40.8	-13	27.8	180

## LTE Band 26 5MHz CH Middle

Harmonic	Frequency (MHz)	SG (dBm)	Cable Loss (dB)	Gain (dBi)	Antenna Polarization	ERP Level (dBm)	Limit (dBm)	Margin (dB)	Azimuth (deg)
2	1633.5	-59.15	2.00	10.75	vertical	-50.4	-13	37.4	225
3	2450.6	-54.34	2.51	11.05	vertical	-45.8	-13	32.8	135
4	3276.0	-57.35	4.20	11.15	vertical	-50.4	-13	37.4	90
5	4095.0	-55.15	5.20	11.15	vertical	-49.2	-13	36.2	45
6	4914.0	-53.55	5.50	11.95	vertical	-47.1	-13	34.1	180
7	5733.0	-53.45	5.70	13.55	vertical	-45.6	-13	32.6	225
8	6552.0	-52.75	6.30	13.75	vertical	-45.3	-13	32.3	135
9	7371.0	-48.95	6.80	13.85	vertical	-41.9	-13	28.9	90
10	8190.0	-47.15	6.90	14.25	vertical	-39.8	-13	26.8	45



## LTE Band 26 5MHz CH High

Harmonic	Frequency (MHz)	SG (dBm)	Cable Loss (dB)	Gain (dBi)	Antenna Polarization	ERP Level (dBm)	Limit (dBm)	Margin (dB)	Azimuth (deg)
2	1640.8	-56.65	2.00	10.75	vertical	-47.9	-13	34.9	180
3	2460.9	-53.84	2.51	11.05	vertical	-45.3	-13	32.3	225
4	3290.0	-57.05	4.20	11.15	vertical	-50.1	-13	37.1	135
5	4112.5	-55.35	5.20	11.15	vertical	-49.4	-13	36.4	90
6	4935.0	-53.75	5.50	11.95	vertical	-47.3	-13	34.3	45
7	5757.5	-54.15	5.70	13.55	vertical	-46.3	-13	33.3	180
8	6580.0	-52.35	6.30	13.75	vertical	-44.9	-13	31.9	225
9	7402.5	-48.85	6.80	13.85	vertical	-41.8	-13	28.8	135
10	8225.0	-47.75	6.90	14.25	vertical	-40.4	-13	27.4	90

## LTE Band 26 10MHz CH Middle

Harmonic	Frequency (MHz)	SG (dBm)	Cable Loss (dB)	Gain (dBi)	Antenna Polarization	ERP Level (dBm)	Limit (dBm)	Margin (dB)	Azimuth (deg)
2	1629.2	-59.95	2.00	10.75	vertical	-51.2	-13	38.2	45
3	2443.9	-55.34	2.51	11.05	vertical	-46.8	-13	33.8	180
4	3276.0	-57.85	4.20	11.15	vertical	-50.9	-13	37.9	225
5	4095.0	-55.15	5.20	11.15	vertical	-49.2	-13	36.2	135
6	4914.0	-53.55	5.50	11.95	vertical	-47.1	-13	34.1	90
7	5733.0	-54.45	5.70	13.55	vertical	-46.6	-13	33.6	45
8	6552.0	-52.75	6.30	13.75	vertical	-45.3	-13	32.3	180
9	7371.0	-48.95	6.80	13.85	vertical	-41.9	-13	28.9	225
10	8190.0	-48.15	6.90	14.25	vertical	-40.8	-13	27.8	135

## 6. Main Test Instruments

Name	Manufacturer	Type	Serial Number	Calibration Date	Expiration Time
Base Station Simulator	R&S	CMW500	150415	2017-05-14	2018-05-13
Power Splitter	Hua Xiang	SHX-GF2-2-13	10120101	NA	NA
Spectrum Analyzer	Agilent	N9010A	MY47191109	2017-05-20	2018-05-19
Universal Radio Communication Tester	Agilent	E5515C	MY48367192	2017-05-20	2018-05-19
Signal Analyzer	R&S	FSV30	100815	2016-12-16	2017-12-15
EMI Test Receiver	R&S	ESCI	100948	2016-12-16	2017-12-15
Trilog Antenna	SCHWARZBECK	VUBL 9163	9163-201	2014-12-06	2017-12-05
Horn Antenna	R&S	HF907	100126	2014-12-06	2017-12-05
Signal generator	R&S	SMB 100A	102594	2017-05-14	2018-05-13
Climatic Chamber	Re Ce	PT-30B	20101891	2015-07-18	2018-07-17
RF Cable	Agilent	SMA 15cm	0001	2017-02-06	2017-08-05
Preampfier	R&S	SCU18	102327	2017-06-18	2018-06-17

\*\*\*\*\*END OF REPORT \*\*\*\*\*

## ANNEX A: EUT Appearance and Test Setup

### A.1 EUT Appearance

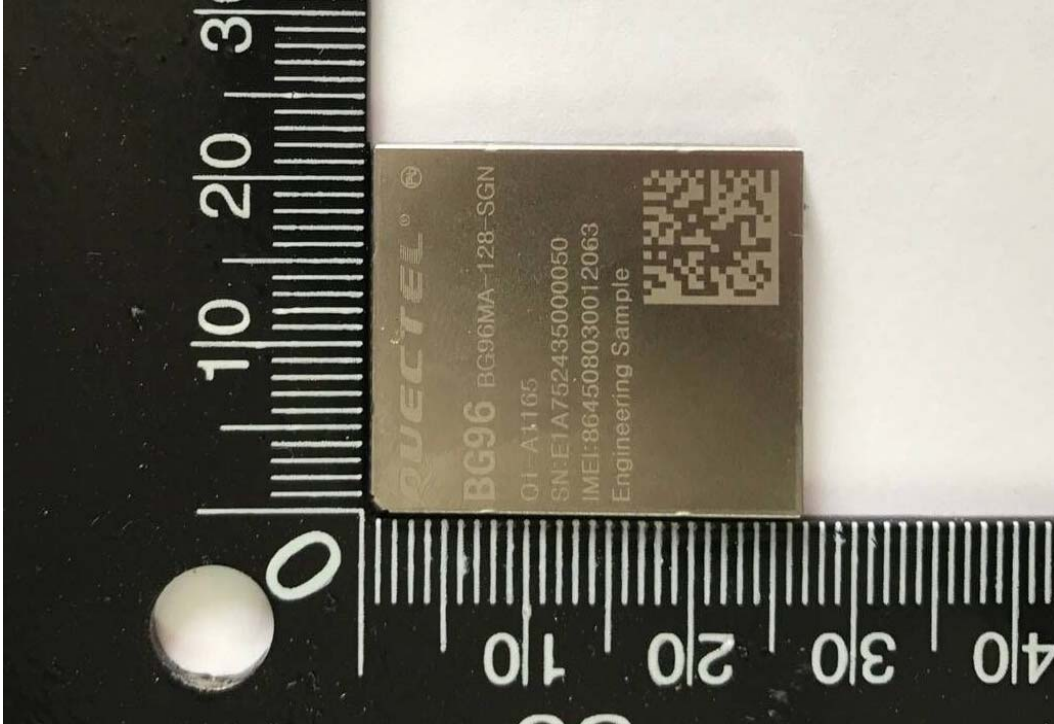

sheilding

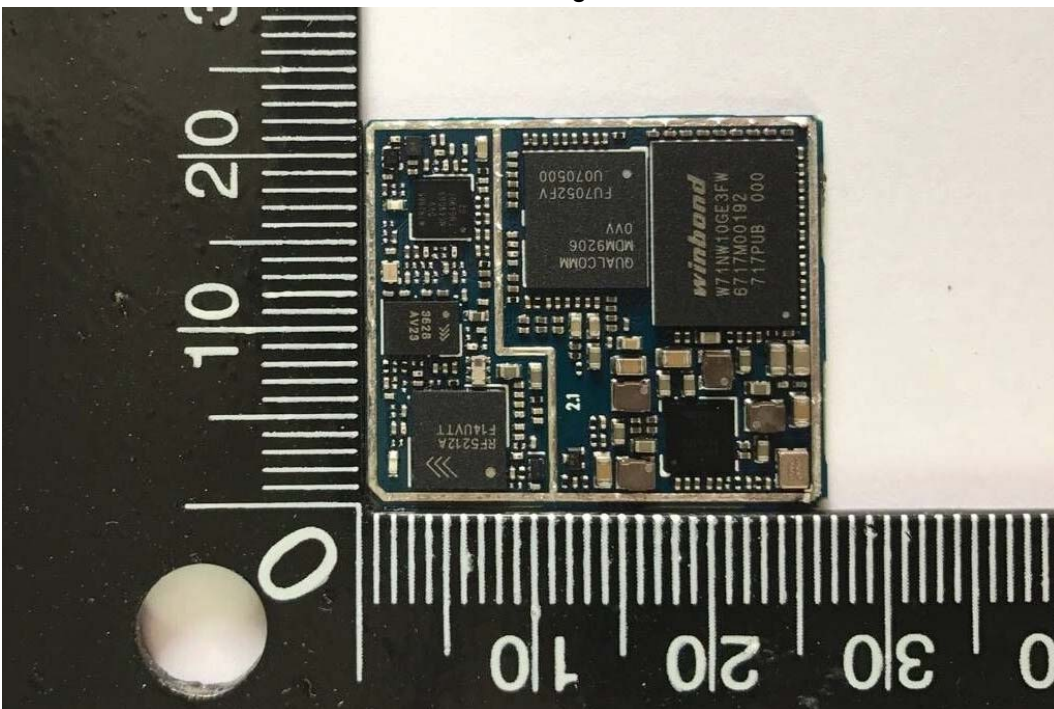

No sheilding  
Front Side

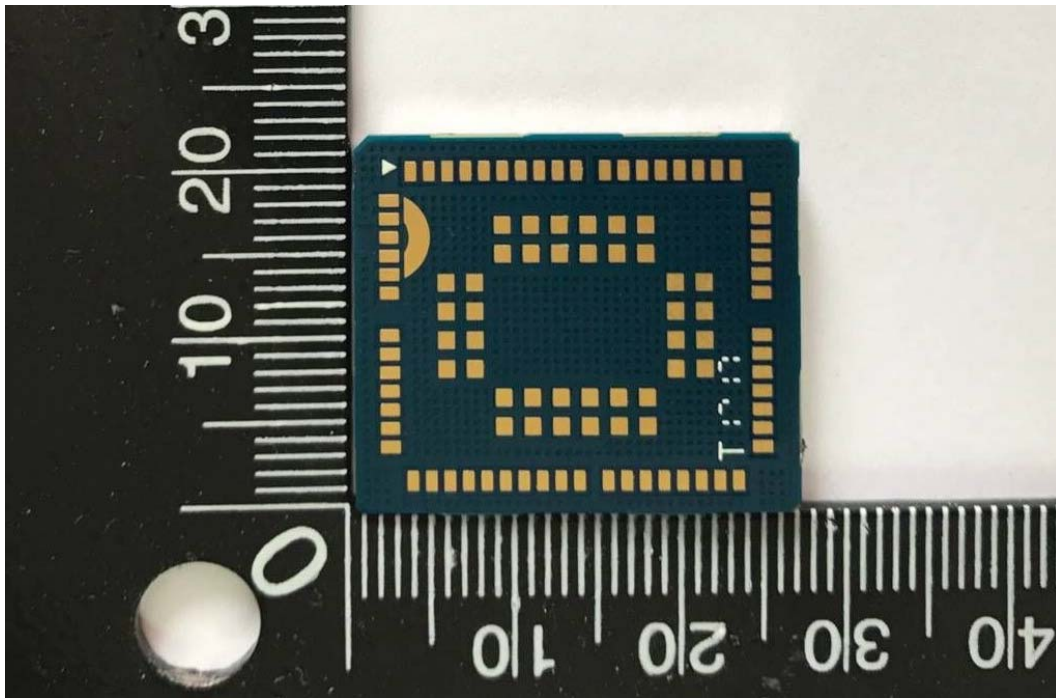

Back Side

a: EUT

**Picture 1 EUT and Accessory**

## A.2 Test Setup

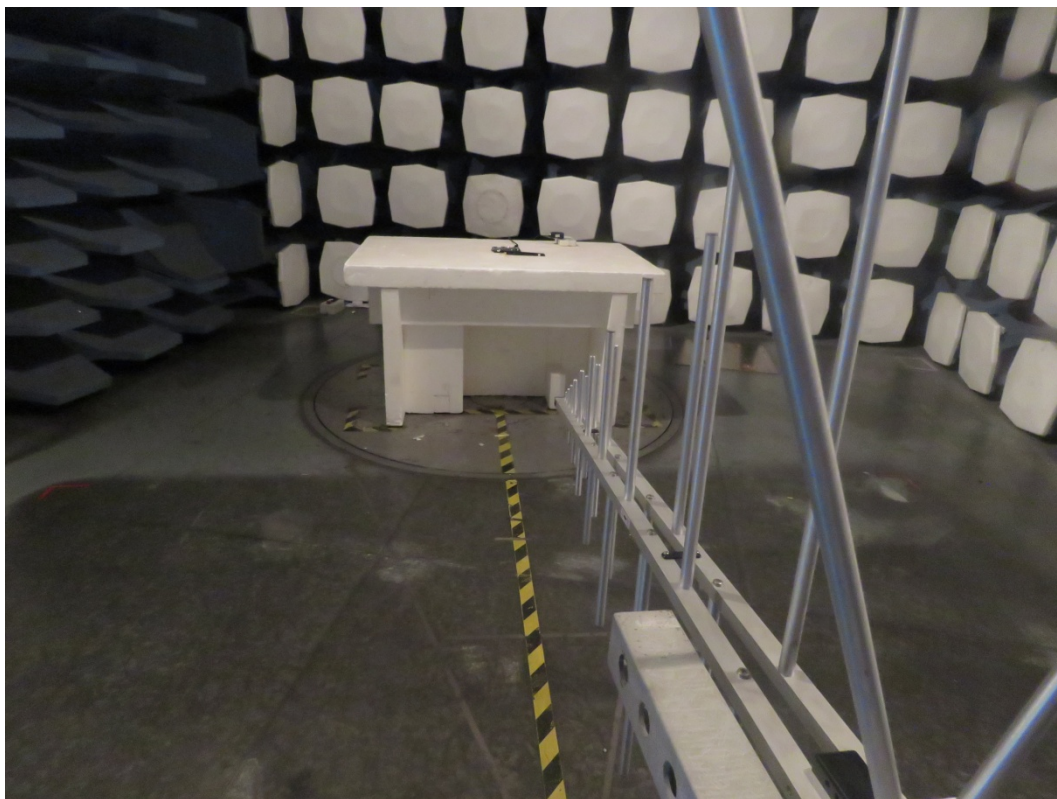

Below 1GHz

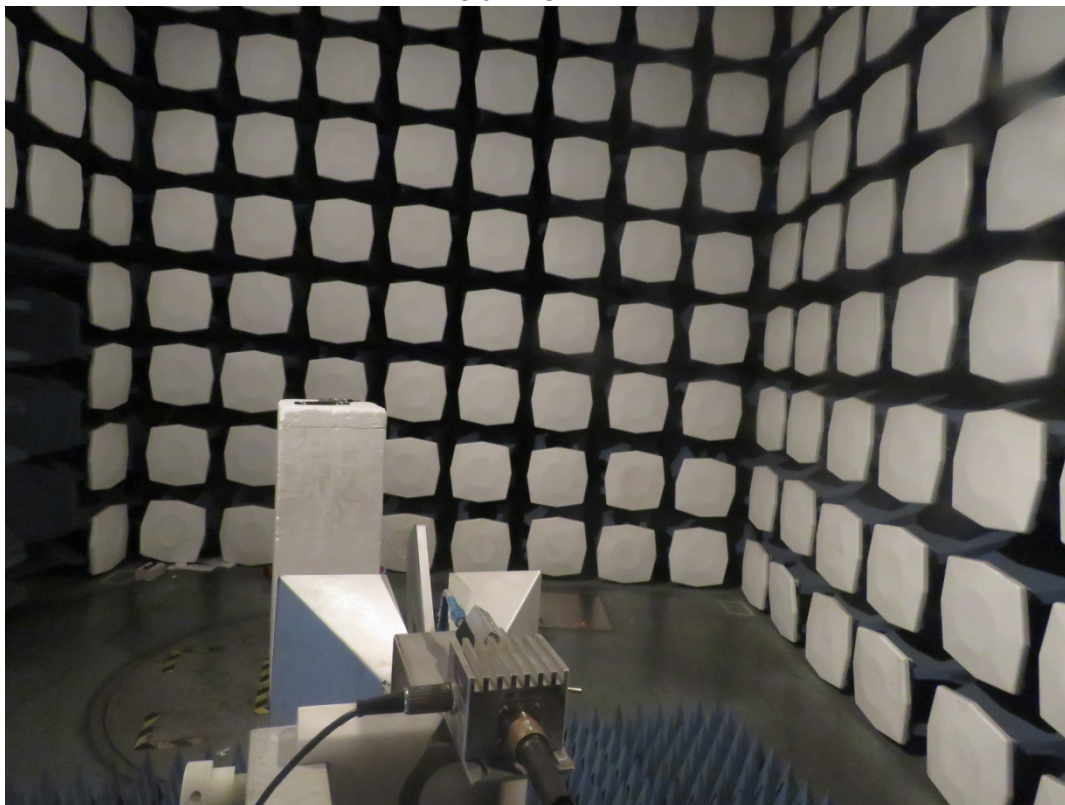

Above 1GHz

**Picture 2: Radiated Spurious Emissions Test setup**