



# RF TEST REPORT

<b>Applicant</b>	Quectel Wireless Solutions Co., Ltd.
<b>FCC ID</b>	XMR201707BG96
<b>Product</b>	Quectel BG96
<b>Brand</b>	Quectel
<b>Model</b>	BG96
<b>Report No.</b>	RXA1706-0199RF02R1
<b>Issue Date</b>	July 12, 2017

TA Technology (Shanghai) Co., Ltd. tested the above equipment in accordance with the requirements in **FCC CFR47 Part 2 (2017)/ FCC CFR 47 Part 24E (2017)**. The test results show that the equipment tested is capable of demonstrating compliance with the requirements as documented in this report.

*Jiang peng Lan*

*Performed by: Jiangpeng Lan*

*Kai Xu*

*Approved by: Kai Xu*

**TA Technology (Shanghai) Co., Ltd.**

*No.145, Jintang Rd, Tangzhen Industry Park, Pudong Shanghai, China*

*TEL: +86-021-50791141/2/3*

*FAX: +86-021-50791141/2/3-8000*



# TABLE OF CONTENT

- 1. Test Laboratory .....4
  - 1.1. Notes of the test report.....4
  - 1.2. Test facility.....4
  - 1.3. Testing Location .....5
- 2. General Description of Equipment under Test.....6
- 3. Applied Standards.....7
- 4. Test Configuration.....8
- 5. Test Case Results.....10
  - 5.1. RF Power Output.....10
  - 5.2. Effective Isotropic Radiated Power .....15
  - 5.3. Occupied Bandwidth .....20
  - 5.4. Band Edge Compliance.....30
  - 5.5. Peak-to-Average Power Ratio (PAPR) .....40
  - 5.6. Frequency Stability .....43
  - 5.7. Spurious Emissions at Antenna Terminals .....48
  - 5.8. Radiates Spurious Emission .....60
- 6. Main Test Instruments .....73
- ANNEX A: EUT Appearance and Test Setup.....74
  - A.1 EUT Appearance .....74
  - A.2 Test Setup.....76



### Summary of measurement results

No.	Test Case	Clause in FCC rules	Verdict
1	RF power output	2.1046	PASS
2	Effective Isotropic Radiated power	24.232(c)	PASS
3	Occupied Bandwidth	2.1049	PASS
4	Band Edge Compliance	2.1051 /24.238(a)	PASS
5	Peak-to-Average Power Ratio	24.232/KDB 971168 D01(5.7)	PASS
6	Frequency Stability	2.1055 / 24.235	PASS
7	Spurious Emissions at Antenna Terminals	2.1051 / 24.238(a)	PASS
8	Radiates Spurious Emission	2.1053 / 24.238(a)	PASS
Date of Testing: June 24 ,2017~July 3 ,2017			
Note: PASS: The EUT complies with the essential requirements in the standard. FAIL: The EUT does not comply with the essential requirements in the standard.			



## 1. Test Laboratory

### 1.1. Notes of the test report

This report shall not be reproduced in full or partial, without the written approval of **TA technology (shanghai) co., Ltd.** The results documented in this report apply only to the tested sample, under the conditions and modes of operation as described herein. Measurement Uncertainties were not taken into account and are published for informational purposes only. This report is written to support regulatory compliance of the applicable standards stated above. This report must not be used by the client to claim product certification, approval, or endorsement by any government agencies.

### 1.2. Test facility

#### **CNAS (accreditation number: L2264)**

TA Technology (Shanghai) Co., Ltd. has obtained the accreditation of China National Accreditation Service for Conformity Assessment (CNAS).

#### **FCC (recognition number is 428261)**

TA Technology (Shanghai) Co., Ltd. has been listed on the US Federal Communications Commission list of test facilities recognized to perform electromagnetic emissions measurements.

#### **IC (recognition number is 8510A)**

TA Technology (Shanghai) Co., Ltd. has been listed by industry Canada to perform electromagnetic emission measurement.

#### **VCCI (recognition number is C-4595, T-2154, R-4113, G-10766)**

TA Technology (Shanghai) Co., Ltd. has been listed by industry Japan to perform electromagnetic emission measurement.

#### **A2LA (Certificate Number: 3857.01)**

TA Technology (Shanghai) Co., Ltd. has been listed by American Association for Laboratory Accreditation to perform electromagnetic emission measurement.



### 1.3. Testing Location

Company: TA Technology (Shanghai) Co., Ltd.  
Address: No.145, Jintang Rd, Tangzhen Industry Park, Pudong  
City: Shanghai  
Post code: 201201  
Country: P. R. China  
Contact: Xu Kai  
Telephone: +86-021-50791141/2/3  
Fax: +86-021-50791141/2/3-8000  
Website: <http://www.ta-shanghai.com>  
E-mail: [xukai@ta-shanghai.com](mailto:xukai@ta-shanghai.com)

## 2. General Description of Equipment under Test

### Client Information

Applicant	Quectel Wireless Solutions Co., Ltd.
Applicant address	7th Floor, Hongye Building, No. 1801 Hongmei Road, Xuhui District, Shanghai, China
Manufacturer	Quectel Wireless Solutions Co., Ltd.
Manufacturer address	7th Floor, Hongye Building, No. 1801 Hongmei Road, Xuhui District, Shanghai, China

### General information

EUT Description			
Model	BG96		
IMEI	864508030012063		
Hardware Version	R1.0		
Software Version	BG96MAR02A02M1G		
Power Supply	External power supply		
Antenna Type	The EUT don't have standard Antenna, The Antenna used for testing in this report is the after-market accessory (Dipole Antenna)		
Test Mode(s)	GSM1900; LTE Band 2;		
Test Modulation	(GSM)GMSK,8PSK; (LTE)QPSK,16QAM		
LTE Category	M1		
Maximum E.I.R.P	GSM 1900:	32.43 dBm	
	LTE Band 2:	29.66 dBm	
Rated Power Supply Voltage	3.8V		
Extreme Voltage	Minimum: 3.3V    Maximum: 4.3V		
Extreme Temperature	Lowest: -40°C    Highest: +85°C		
Operating Frequency Range(s)	Band	Tx (MHz)	Rx (MHz)
	GSM1900	1850 ~ 1910	1930 ~ 1990
	LTE Band 2	1850 ~ 1910	1930 ~ 1990
Note: The information of the EUT is declared by the manufacturer.			

Accessory equipment	
Evaluation Board	RF Cable
RS232-to-USB Cable	Antenna: Dipole Antenna
Headset	USB Cable



### **3. Applied Standards**

According to the specifications of the manufacturer, it must comply with the requirements of the following standards:

**FCC CFR47 Part 2 (2017)**

**FCC CFR 47 Part 24E (2017)**

**ANSI C63.26 (2015)**

**KDB 971168 D01 Power Meas License Digital Systems v02r02**

## 4. Test Configuration

Radiated measurements are performed by rotating the EUT in three different orthogonal test planes. EUT stand-up position (X, Y axis), lie down position (Z axis). Receiver antenna polarization (horizontal and vertical), the worst emission was found in position (Z axis, vertical polarization) and the worst case was recorded.

All mode and data rates and positions and RB size and modulations were investigated.

Subsequently, only the worst case emissions are reported.

The following testing in GSM/LTE is set based on the maximum RF Output Power.

Test modes are chosen to be reported as the worst case configuration below:

	Test items	Modes/Modulation
		GSM 1900
Conducted Test cases	RF power output	GPRS(1Tx slot) EGPRS(1Tx slot)
	Occupied Bandwidth	GPRS(1Tx slot) EGPRS(1Tx slot)
	Band Edge Compliance	GPRS(1Tx slot) EGPRS(1Tx slot)
	Peak-to-Average Power Ratio	GPRS(1Tx slot) EGPRS(1Tx slot)
	Frequency Stability	GPRS(1Tx slot) EGPRS(1Tx slot)
	Spurious Emissions at Antenna Terminals	GPRS(1Tx slot)
Radiated Test cases	Effective Isotropic Radiated power	GPRS(1Tx slot) EGPRS(1Tx slot)
	Radiates Spurious Emission	GPRS(1Tx slot)





Test modes are chosen to be reported as the worst case configuration below for LTE Band 2

Test items	Bandwidth (MHz)						Modulation		RB			Test Channel		
	1.4	3	5	10	15	20	QPSK	16QAM	1	50%	100%	L	M	H
RF power output	O	O	O	O	O	O	O	O	O	O	O	O	O	O
Effective Isotropic Radiated power	O	O	O	O	O	O	O	O	-	-	O	O	O	O
Occupied Bandwidth	O	O	O	O	O	O	O	O	-	-	O	O	O	O
Band Edge Compliance	O	O	O	O	O	O	O	O	O	-	O	O	-	O
Peak-to-Average Power Ratio	O	O	O	O	O	O	O	O	-	-	O	O	O	O
Frequency Stability	O	O	O	O	O	O	O	O	-	-	O	-	O	-
Conducted Spurious Emissions	O	O	O	O	O	O	O	-	O	-	-	O	O	O
Radiates Spurious Emission	O	O	O	O	O	O	O	-	O	-	-	O	O	O
Note	1. The mark "O" means that this configuration is chosen for testing. 2. The mark "-" means that this configuration is not testing.													

## 5. Test Case Results

### 5.1.RF Power Output

#### Ambient condition

Temperature	Relative humidity	Pressure
23°C ~25°C	45%~50%	101.5kPa

#### Methods of Measurement

During the process of the testing, The EUT is controlled by the Base Station Simulator to ensure max power transmission and proper modulation.

#### Test Setup



The loss between RF output port of the EUT and the input port of the tester has been taken into consideration.

#### Limits

No specific RF power output requirements in part 2.1046.

#### Measurement Uncertainty

The assessed measurement uncertainty to ensure 95% confidence level for the normal distribution is with the coverage factor  $k = 2$ ,  $U = 0.4$  dB.

**Test Results**

GSM 1900		Conducted Power(dBm)		
		Channel 512	Channel 661	Channel 810
		1850.2(MHz)	1880(MHz)	1909.8(MHz)
GPRS (GMSK)	1TXslot	29.76	29.66	29.46
	2TXslots	29.65	29.57	29.38
	3TXslots	29.51	29.45	29.27
	4TXslots	29.42	29.32	29.16
EGPRS (8PSK)	1TXslot	26.06	25.88	25.84
	2TXslots	25.89	25.81	25.68
	3TXslots	25.78	25.64	25.49
	4TXslots	25.57	25.45	25.38



LTE Band 2				Conducted Power(dBm)		
Bandwidth	Modulation	RB size	RB offset	Channel/Frequency (MHz)		
				18607/1850.7	18900/1880	19193/1909.3
1.4MHz	QPSK	1	0	23.25	23.37	23.73
		1	3	23.17	23.33	23.73
		1	5	23.22	23.39	23.73
		3	0	23.80	23.66	23.76
		3	2	23.63	23.53	23.65
		3	3	23.43	23.58	23.67
		6	0	23.42	23.55	23.70
	16QAM	1	0	23.80	23.83	23.84
		1	3	23.87	23.83	23.89
		1	5	23.72	23.85	23.79
		3	0	23.53	23.61	23.57
		3	2	23.50	23.62	23.57
		3	3	23.50	23.69	23.50
		5	0	23.52	23.72	23.74
Bandwidth	Modulation	RB size	RB offset	Channel/Frequency (MHz)		
				18615/1851.5	18900/1880	19185/1908.5
3MHz	QPSK	1	0	23.27	23.41	23.76
		1	3	23.20	23.38	23.77
		1	5	23.25	23.44	23.77
		3	0	23.80	23.68	23.79
		3	2	23.65	23.53	23.67
		3	3	23.43	23.59	23.67
		6	0	23.45	23.59	23.73
	16QAM	1	0	23.83	23.85	23.87
		1	3	23.90	23.88	23.93
		1	5	23.74	23.89	23.82
		3	0	23.54	23.64	23.59
		3	2	23.51	23.65	23.59
		3	3	23.50	23.71	23.53
		5	0	23.55	23.76	23.77
Bandwidth	Modulation	RB size	RB offset	Channel/Frequency (MHz)		
				18625/1852.5	18900/1880	19175/1907.5
5MHz	QPSK	1	0	23.24	23.39	23.72
		1	3	23.18	23.34	23.74
		1	5	23.22	23.39	23.73
		3	0	23.77	23.63	23.75



		3	2	23.63	23.49	23.62
		3	3	23.41	23.57	23.63
		6	0	23.43	23.58	23.71
	16QAM	1	0	23.80	23.81	23.84
		1	3	23.87	23.86	23.90
		1	5	23.71	23.87	23.78
		3	0	23.52	23.60	23.56
		3	2	23.48	23.60	23.55
		3	3	23.47	23.66	23.49
		5	0	23.53	23.72	23.72
Bandwidth	Modulation	RB size	RB offset	Channel/Frequency (MHz)		
				18650/1855	18900/1880	19150/1905
10MHz	QPSK	1	0	23.26	23.40	23.75
		1	3	23.21	23.39	23.78
		1	5	23.24	23.43	23.76
		3	0	23.80	23.68	23.79
		3	2	23.66	23.54	23.66
		3	3	23.43	23.61	23.68
		6	0	23.51	23.60	23.75
	16QAM	1	0	23.82	23.84	23.86
		1	3	23.90	23.90	23.93
		1	5	23.74	23.89	23.81
		3	0	23.55	23.65	23.60
		3	2	23.50	23.64	23.58
		3	3	23.50	23.71	23.53
		5	0	23.56	23.77	23.76
Bandwidth	Modulation	RB size	RB offset	Channel/Frequency (MHz)		
				18675/1857.5	18900/1880	19125/1902.5
15MHz	QPSK	1	0	23.25	23.36	23.73
		1	3	23.19	23.38	23.75
		1	5	23.21	23.38	23.72
		3	0	23.78	23.64	23.76
		3	2	23.63	23.49	23.62
		3	3	23.40	23.58	23.64
		6	0	23.49	23.56	23.70
	16QAM	1	0	23.77	23.82	23.84
		1	3	23.88	23.87	23.91
		1	5	23.71	23.85	23.78
		3	0	23.52	23.63	23.57
		3	2	23.47	23.59	23.54



Bandwidth	Modulation	RB size	RB offset	Channel/Frequency (MHz)		
				18700/1860	18900/1880	19100/1900
20MHz		3	3	23.48	23.67	23.50
		5	0	23.53	23.72	23.72
	QPSK	1	0	23.22	23.32	23.70
		1	3	23.18	23.34	23.73
		1	5	23.19	23.37	23.69
		3	0	23.75	23.59	23.72
		3	2	23.61	23.45	23.59
		3	3	23.37	23.53	23.60
	16QAM	6	0	23.46	23.51	23.66
		1	0	23.75	23.78	23.79
		1	3	23.84	23.85	23.87
		1	5	23.69	23.82	23.76
		3	0	23.49	23.59	23.54
		3	2	23.44	23.57	23.51
3		3	23.45	23.62	23.46	
	5	0	23.51	23.68	23.69	

## 5.2. Effective Isotropic Radiated Power

### Ambient condition

Temperature	Relative humidity	Pressure
23°C ~25°C	45%~50%	101.5kPa

### Methods of Measurement

1. The testing follows ANSI C63.26 (2015) Section 5.5.2.3.
2. EUT was placed on a 0.8 meter high non-conductive stand at a 3 meter test distance from the receive antenna. A receiving antenna was placed on the antenna mast 3 meters from the EUT for emission measurements. The height of receiving antenna between 1.0m and 4.0m. Detected emissions were maximized at each frequency by rotating the EUT through 360° and adjusting the receiving antenna polarization. The radiated emission measurements of all transmit frequencies in three channels (High, Middle, Low) were measured with peak detector.
3. A log-periodic antenna or double-ridged waveguide horn antenna shall be substituted in place of the EUT. The log-periodic antenna will be driven by a signal generator and the level will be adjusted till the same power value on the spectrum analyzer or receiver. The level of the spurious emissions can be calculated through the level of the signal generator, cable loss, the gain of the substitution antenna and the reading of the spectrum analyzer or receiver.
4. The EUT is then put into continuously transmitting mode at its maximum power level during the test. Set Test Receiver or Spectrum RBW=1MHz, VBW=3MHz for above 1GHz and RBW=100kHz, VBW=300kHz for 30MHz to 1GHz., And the maximum value of the receiver should be recorded as (Pr).
5. The EUT shall be replaced by a substitution antenna. In the chamber, an substitution antenna for the frequency band of interest is placed at the reference point of the chamber. An RF Signal source for the frequency band of interest is connected to the substitution antenna with a cable that has been constructed to not interfere with the radiation pattern of the antenna. A power (PMea) is applied to the input of the substitution antenna, and adjust the level of the signal generator output until the value of the receiver reach the previously recorded (Pr). The power of signal source (PMea) is recorded. The test should be performed by rotating the test item and adjusting the receiving antenna polarization.
6. A amplifier should be connected to the Signal Source output port. And the cable should be connect between the Amplifier and the Substitution Antenna. The cable loss (Pcl) ,the Substitution Antenna Gain (Ga) and the Amplifier Gain (PAg) should be recorded after test.
7. The measurement results are obtained as described below:  
$$\text{Power(EIRP)} = \text{PMea} - \text{PAg} - \text{Pcl} + \text{Ga}$$
  
The measurement results are amend as described below:  
$$\text{Power(EIRP)} = \text{PMea} - \text{Pcl} + \text{Ga}$$
8. This value is EIRP since the measurement is calibrated using an antenna of known gain (2.15 dBi) and known input power. ERP can be calculated from EIRP by subtracting the gain of the dipole,  $\text{ERP} = \text{EIRP} - 2.15\text{dBi}$ .

**Test configuration**

**Below 1GHz:**

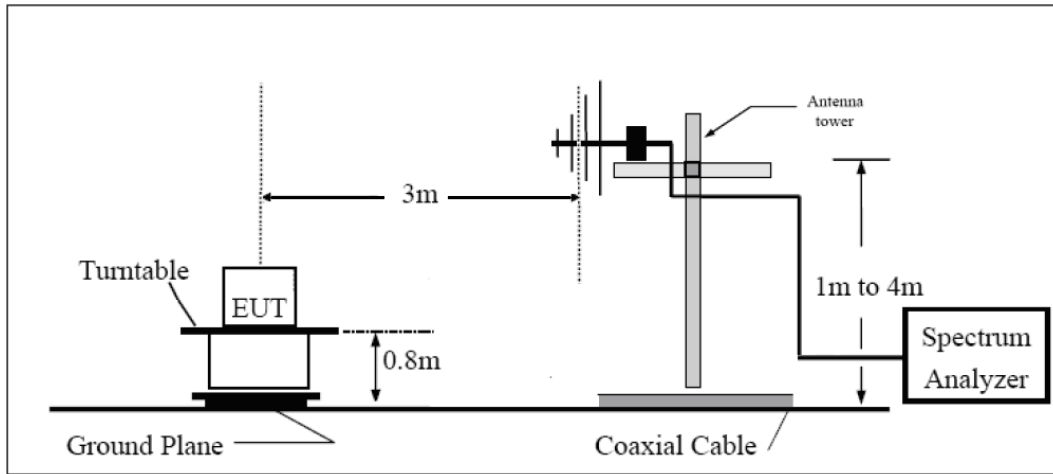

**Above 1GHz:**

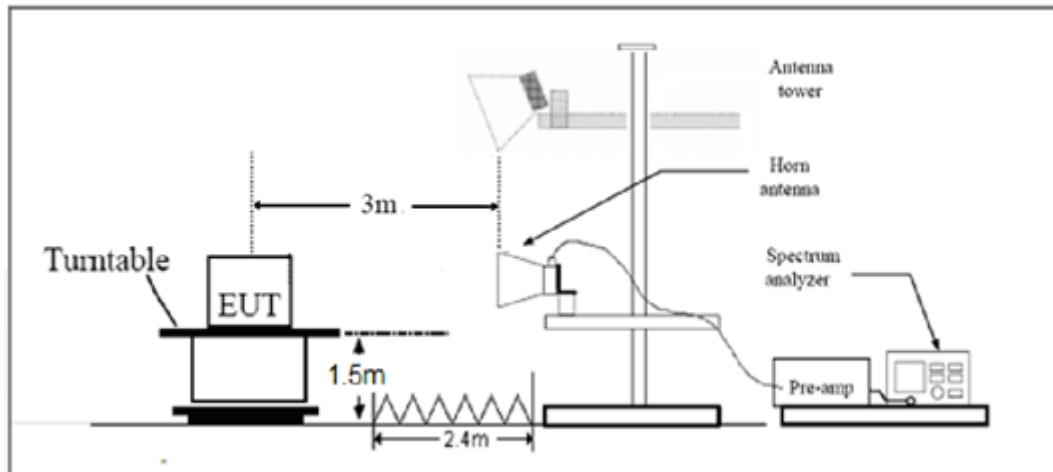

**Limits**

Rule Part 24.232(c) Mobile and portable stations are limited to 2 watts EIRP.

Rule Part 24.232(e) Peak transmit power must be measured over any interval of continuous transmission using instrumentation calibrated in terms of an rms-equivalent voltage.

Limit (EIRP)	$\leq 2\text{ W}$ (33 dBm)
--------------	----------------------------

**Measurement Uncertainty**

The assessed measurement uncertainty to ensure 95% confidence level for the normal distribution is with the coverage factor  $k = 2$ ,  $U = 1.19\text{ dB}$





## Test Results:

Mode	Polarization	Frequency (MHz)	Rt (dBm)	Rs (dBm)	Ps (dBm)	Gs (dBi)	EIRP (dBm)	Limit (dBm)	Conclusion
GPRS 1900	H	1850.2	-35.72	-53.21	0.00	1.92	31.88	33	Pass
	H	1880	-35.17	-53.42	0.00	1.94	31.82	33	Pass
	H	1909.8	-34.21	-53.67	0.00	1.90	32.43	33	Pass
	V	1850.2	-35.52	-53.70	0.00	1.92	28.27	33	Pass
	V	1880	-34.35	-53.91	0.00	1.94	29.16	33	Pass
	V	1909.8	-34.97	-54.55	0.00	1.90	29.73	33	Pass
EGPRS 1900	H	1850.2	-35.00	-53.21	0.00	1.92	28.06	33	Pass
	H	1880	-34.71	-53.42	0.00	1.94	27.88	33	Pass
	H	1909.8	-33.78	-53.67	0.00	1.90	27.84	33	Pass
	V	1850.2	-35.49	-53.70	0.00	1.92	26.56	33	Pass
	V	1880	-35.21	-53.91	0.00	1.94	26.38	33	Pass
	V	1909.8	-35.64	-54.55	0.00	1.90	26.34	33	Pass



LTE Band 2									
bandwidth	Polarization	Frequency (MHz)	Rt (dBm)	Rs (dBm)	Ps (dBm)	Gs (dBi)	EIRP (dBm)	Limit (dBm)	Conclusion
1.4 MHz (QPSK)	H	1850.7	-27.83	-54.89	0.00	1.90	28.96	33	Pass
	H	1880	-28.92	-56.66	0.00	1.92	29.66	33	Pass
	H	1909.3	-30.62	-58.09	0.00	1.91	29.38	33	Pass
	V	1850.7	-31.17	-55.05	0.00	1.90	25.78	33	Pass
	V	1880	-31.39	-56.41	0.00	1.92	26.94	33	Pass
	V	1909.3	-33.94	-57.85	0.00	1.91	25.82	33	Pass
1.4 MHz (16QAM)	H	1850.7	-28.14	-54.89	0.00	1.90	28.65	33	Pass
	H	1880	-29.28	-56.66	0.00	1.92	29.30	33	Pass
	H	1909.3	-30.95	-58.09	0.00	1.91	29.05	33	Pass
	V	1850.7	-31.50	-55.05	0.00	1.90	25.45	33	Pass
	V	1880	-31.71	-56.41	0.00	1.92	26.62	33	Pass
	V	1909.3	-34.45	-57.85	0.00	1.91	25.31	33	Pass
3 MHz (QPSK)	H	1851.5	-27.57	-54.93	0.00	1.91	29.27	33	Pass
	H	1880	-29.06	-56.66	0.00	1.94	29.54	33	Pass
	H	1908.5	-30.54	-58.08	0.00	1.91	29.45	33	Pass
	V	1851.5	-31.57	-55.04	0.00	1.91	25.38	33	Pass
	V	1880	-32.06	-56.41	0.00	1.94	26.29	33	Pass
	V	1908.5	-33.38	-57.86	0.00	1.91	26.39	33	Pass
3 MHz (16QAM)	H	1851.5	-27.84	-54.93	0.00	1.91	29.00	33	Pass
	H	1880	-29.38	-56.66	0.00	1.94	29.22	33	Pass
	H	1908.5	-30.84	-58.08	0.00	1.91	29.15	33	Pass
	V	1851.5	-31.90	-55.04	0.00	1.91	25.05	33	Pass
	V	1880	-32.35	-56.41	0.00	1.94	26.00	33	Pass
	V	1908.5	-33.72	-57.86	0.00	1.91	26.05	33	Pass
5 MHz (QPSK)	H	1852.5	-27.57	-54.93	0.00	1.91	29.27	33	Pass
	H	1880	-28.14	-54.98	0.00	1.92	28.76	33	Pass
	H	1907.5	-29.64	-56.66	0.00	1.94	28.96	33	Pass
	V	1852.5	-30.95	-58.05	0.00	1.90	29.00	33	Pass
	V	1880	-30.77	-55.14	0.00	1.92	26.29	33	Pass
	V	1907.5	-31.96	-56.41	0.00	1.94	26.39	33	Pass
5 MHz (16QAM)	H	1852.5	-33.91	-57.97	0.00	1.90	25.96	33	Pass
	H	1880	-28.48	-54.98	0.00	1.92	28.42	33	Pass
	H	1907.5	-29.94	-56.66	0.00	1.94	28.66	33	Pass
	V	1852.5	-31.26	-58.05	0.00	1.90	28.69	33	Pass
	V	1880	-31.06	-55.14	0.00	1.92	26.00	33	Pass
	V	1907.5	-32.27	-56.41	0.00	1.94	26.08	33	Pass
10 MHz (QPSK)	H	1855	-29.26	-55.09	0.00	1.91	27.74	33	Pass
	H	1880	-30.29	-56.66	0.00	1.94	28.31	33	Pass
	H	1905	-31.68	-58.01	0.00	1.92	28.25	33	Pass



LTE Band 2									
bandwidth	Polarization	Frequency (MHz)	Rt (dBm)	Rs (dBm)	Ps (dBm)	Gs (dBi)	EIRP (dBm)	Limit (dBm)	Conclusion
	V	1855	-31.61	-55.08	0.00	1.91	25.38	33	Pass
	V	1880	-33.08	-56.41	0.00	1.94	25.27	33	Pass
	V	1905	-34.34	-57.81	0.00	1.92	25.39	33	Pass
10 MHz (16QAM)	H	1855	-29.58	-55.09	0.00	1.91	27.42	33	Pass
	H	1880	-30.59	-56.66	0.00	1.94	28.01	33	Pass
	H	1905	-31.98	-58.01	0.00	1.92	27.95	33	Pass
	V	1855	-31.94	-55.08	0.00	1.91	25.05	33	Pass
	V	1880	-33.37	-56.41	0.00	1.94	24.98	33	Pass
	V	1905	-34.66	-57.81	0.00	1.92	25.07	33	Pass
15 MHz (QPSK)	H	1857.5	-29.93	-55.23	0.00	1.93	27.23	33	Pass
	H	1880	-31.07	-56.66	0.00	1.94	27.53	33	Pass
	H	1902.5	-32.34	-57.95	0.00	1.92	27.53	33	Pass
	V	1857.5	-32.42	-55.24	0.00	1.93	24.75	33	Pass
	V	1880	-33.12	-56.41	0.00	1.94	25.23	33	Pass
	V	1902.5	-34.88	-57.69	0.00	1.92	24.73	33	Pass
15 MHz (16QAM)	H	1857.5	-30.24	-55.23	0.00	1.93	26.92	33	Pass
	H	1880	-31.38	-56.66	0.00	1.94	27.22	33	Pass
	H	1902.5	-32.65	-57.95	0.00	1.92	27.22	33	Pass
	V	1857.5	-32.72	-55.24	0.00	1.93	24.45	33	Pass
	V	1880	-33.43	-56.41	0.00	1.94	24.92	33	Pass
	V	1902.5	-35.20	-57.69	0.00	1.92	24.41	33	Pass
20 MHz (QPSK)	H	1860	-30.94	-55.35	0.00	1.93	26.34	33	Pass
	H	1880	-31.86	-56.66	0.00	1.94	26.74	33	Pass
	H	1900	-33.11	-57.86	0.00	1.92	26.67	33	Pass
	V	1860	-34.01	-55.31	0.00	1.93	23.23	33	Pass
	V	1880	-34.48	-56.41	0.00	1.94	23.87	33	Pass
	V	1900	-36.36	-57.66	0.00	1.92	23.22	33	Pass
20 MHz (16QAM)	H	1860	-31.24	-55.35	0.00	1.93	26.04	33	Pass
	H	1880	-32.19	-56.66	0.00	1.94	26.41	33	Pass
	H	1900	-33.43	-57.86	0.00	1.92	26.35	33	Pass
	V	1860	-34.32	-55.31	0.00	1.93	22.92	33	Pass
	V	1880	-34.80	-56.41	0.00	1.94	23.55	33	Pass
	V	1900	-36.67	-57.66	0.00	1.92	22.91	33	Pass

### 5.3.Occupied Bandwidth

#### Ambient condition

Temperature	Relative humidity	Pressure
23°C ~25°C	45%~50%	101.5kPa

#### Method of Measurement

The EUT was connected to Spectrum Analyzer and Base Station Simulator via power Splitter. The occupied bandwidth is measured using spectrum analyzer.

RBW is set to 3kHz, VBW is set to 10kHz for GSM 1900,

RBW is set to 51kHz, VBW is set to 160kHz for LTE Band 2.

99% power and -26dBc occupied bandwidths are recorded. Spectrum analyzer plots are included on the following pages.

#### Test Setup

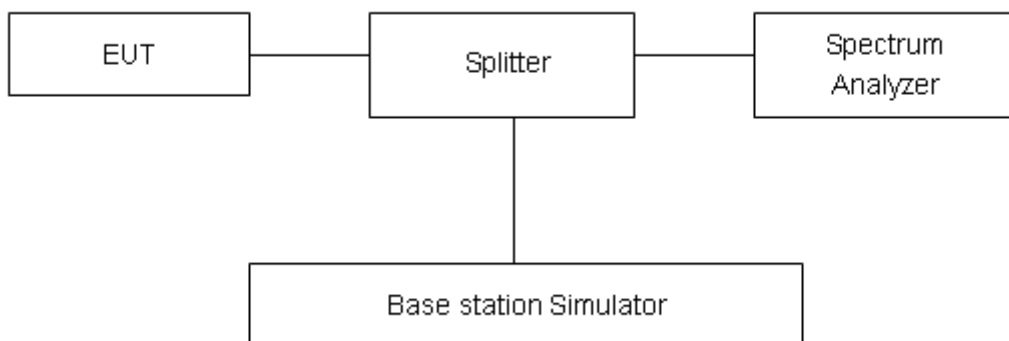

#### Limits

No specific occupied bandwidth requirements in part 2.1049.

#### Measurement Uncertainty

The assessed measurement uncertainty to ensure 95% confidence level for the normal distribution is with the coverage factor  $k = 2$ ,  $U = 624\text{Hz}$ .



## Test Result

Mode	Channel	Frequency (MHz)	99% Power Bandwidth (MHz)	-26dBc Bandwidth(MHz)
GPRS 1900 (GMSK)	512	1850.2	0.24637	0.3169
	661	1880.0	0.24585	0.3154
	810	1909.8	0.24375	0.3155
EGPRS 1900 (8-PSK)	512	1850.2	0.24164	0.3155
	661	1880.0	0.2447	0.3111
	810	1909.8	0.24768	0.3121

LTE Band 2					
Modulation	Bandwidth (MHz)	Channel	Frequency (MHz)	99% Power Bandwidth(MHz)	-26dBc Bandwidth(MHz)
QPSK	1.4	18607	1850.7	1.1143	1.324
		18900	1880.0	1.1111	1.341
		19193	1909.3	1.1084	1.345
	3	18615	1851.5	1.1712	1.932
		18900	1880	1.1621	1.896
		19185	1908.5	1.1229	1.511
	5	18625	1852.5	1.1764	2.066
		18900	1880	1.1669	2.051
		19175	1907.5	1.1595	2.038
	10	18650	1855	1.2041	1.970
		18900	1880	1.1876	1.955
		19150	1905	1.1881	1.964
	15	18675	1857.5	1.2045	1.913
		18900	1880	1.2171	2.062
		19125	1902.5	1.2160	2.067
20	18700	1860	1.2329	1.802	
	18900	1880	1.2544	2.005	
	19100	1900	1.2025	2.072	
16QAM	1.4	18607	1850.7	0.9494	1.312
		18900	1880.0	0.9476	1.300



		19193	1909.3	0.9510	1.355
3		18615	1851.5	0.9741	1.321
		18900	1880	0.9855	1.307
		19185	1908.5	0.9709	1.320
5		18625	1852.5	1.0150	1.570
		18900	1880	1.0119	1.558
		19175	1907.5	1.0040	1.490
10		18650	1855	1.0528	1.620
		18900	1880	1.1939	1.823
		19150	1905	1.0418	1.617
15		18675	1857.5	1.0975	1.862
		18900	1880	1.8960	1.865
		19125	1902.5	1.0970	1.892
20		18700	1860	1.1216	1.965
		18900	1880	1.1472	1.957
		19100	1900	1.0892	1.842

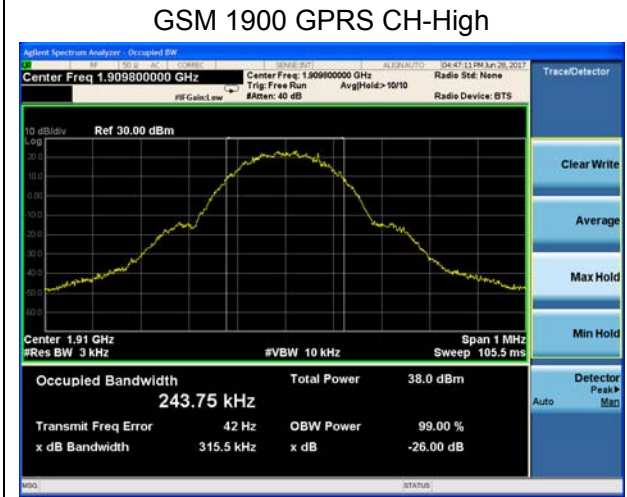
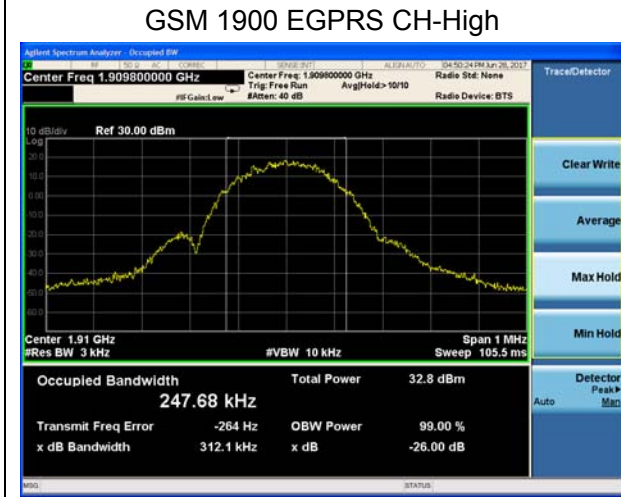
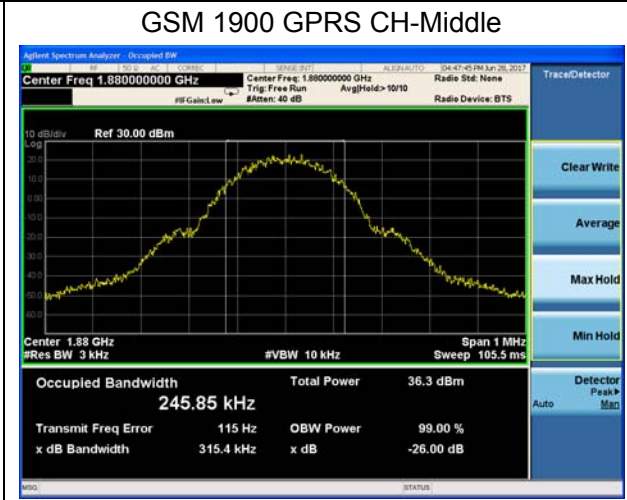
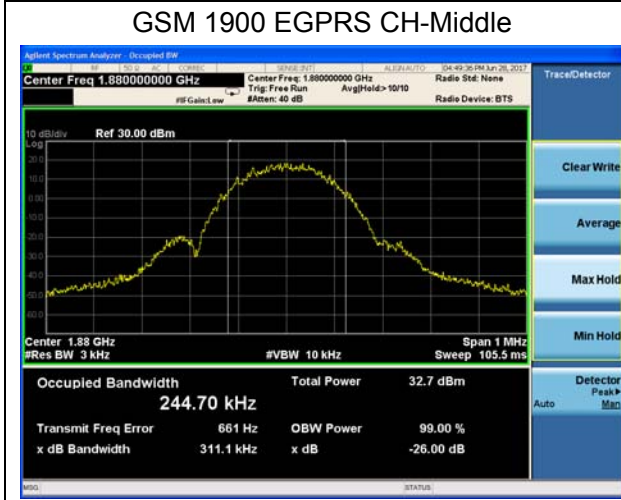
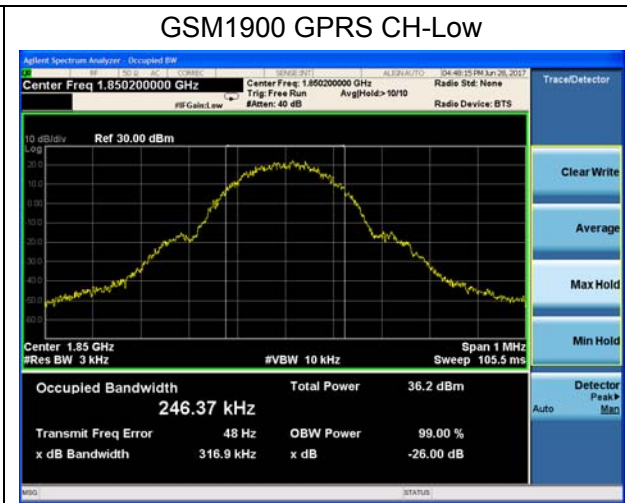
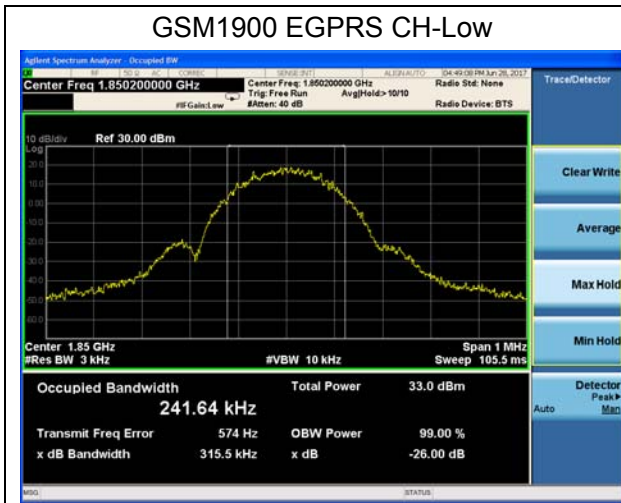

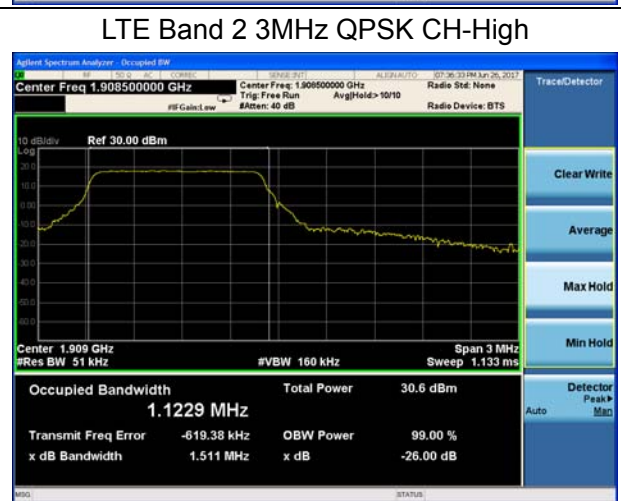
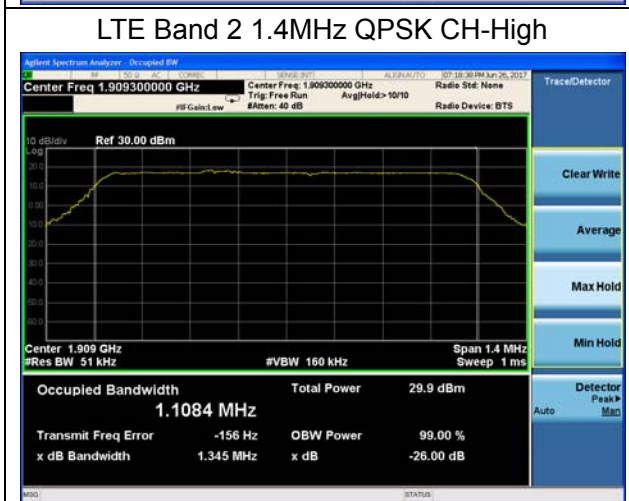
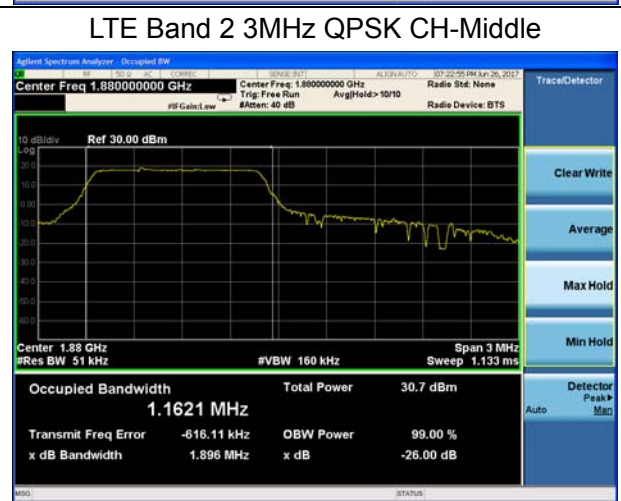
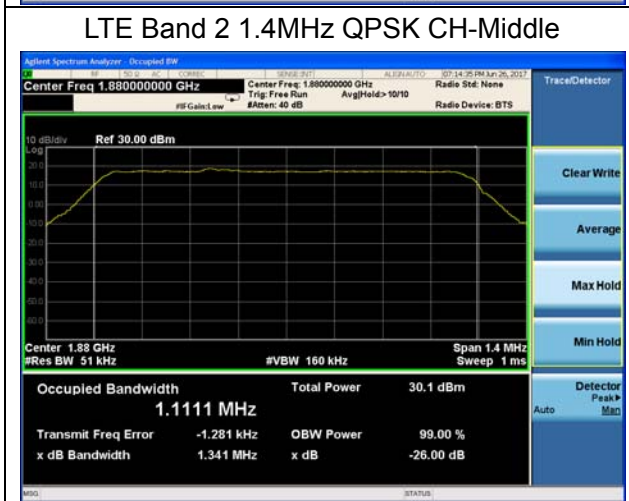
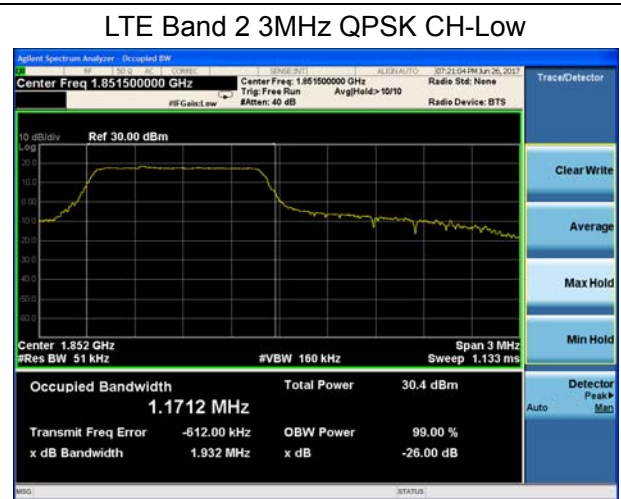
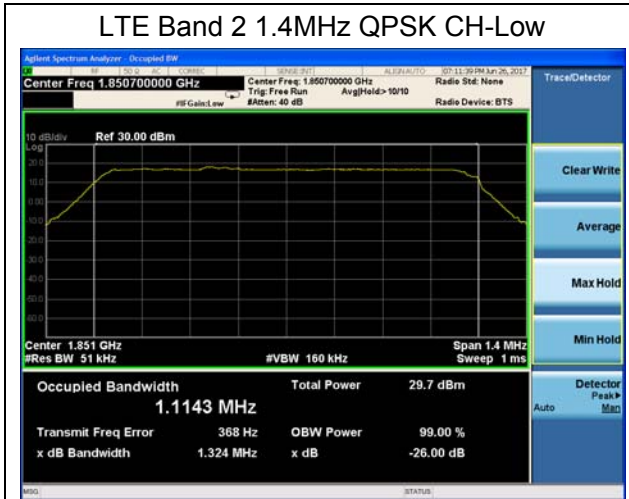



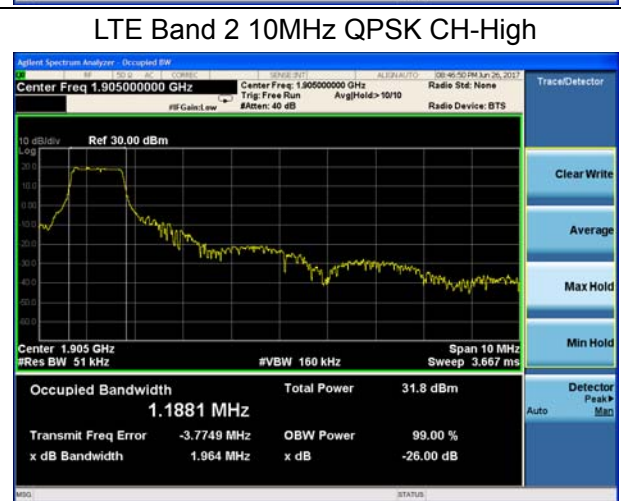
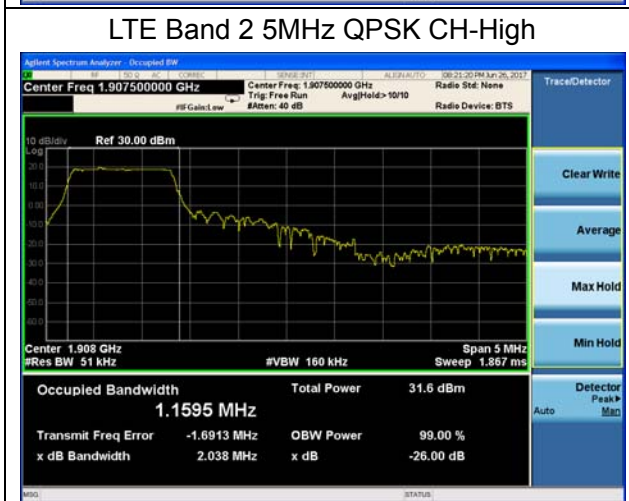
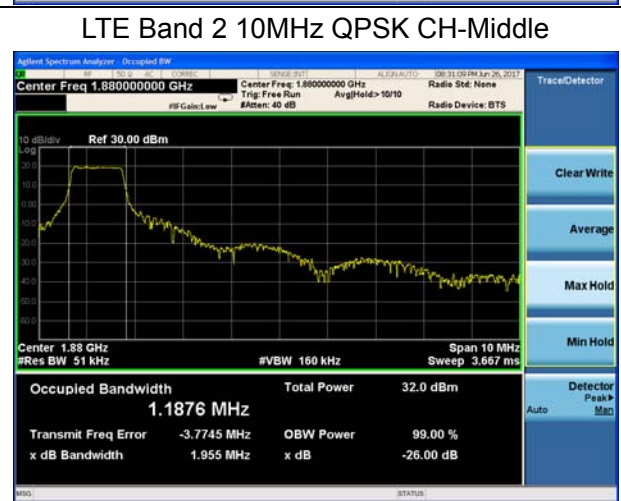
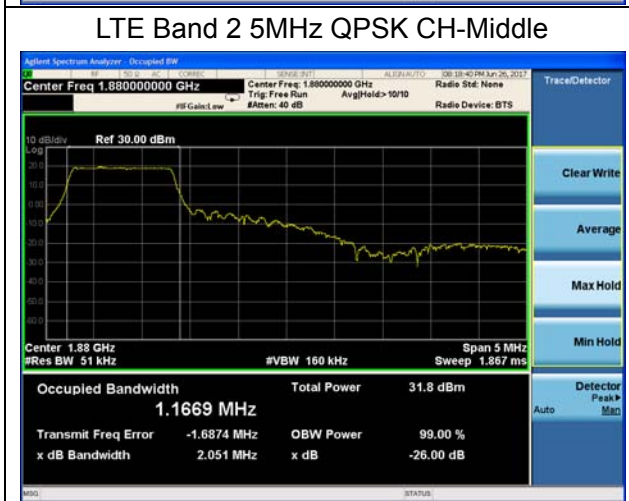
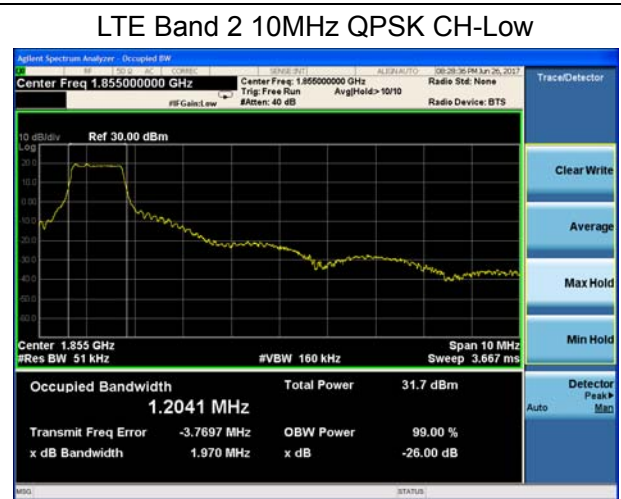
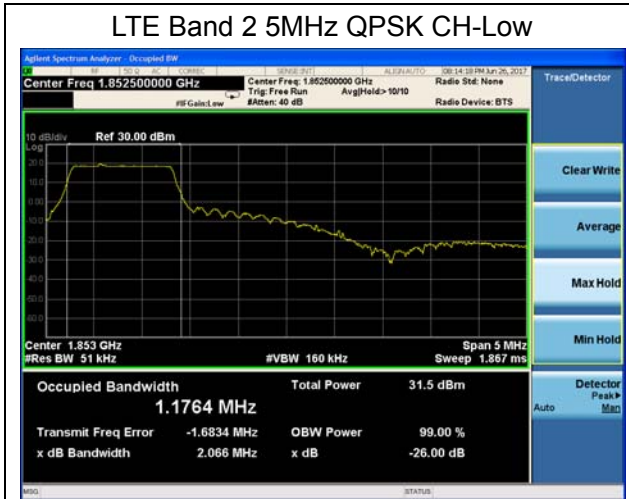

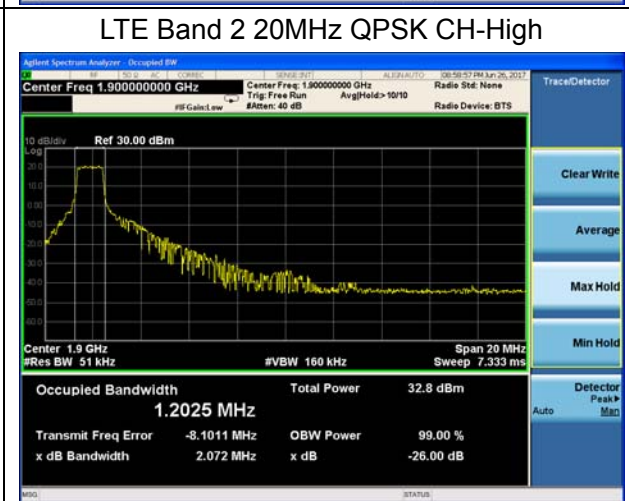
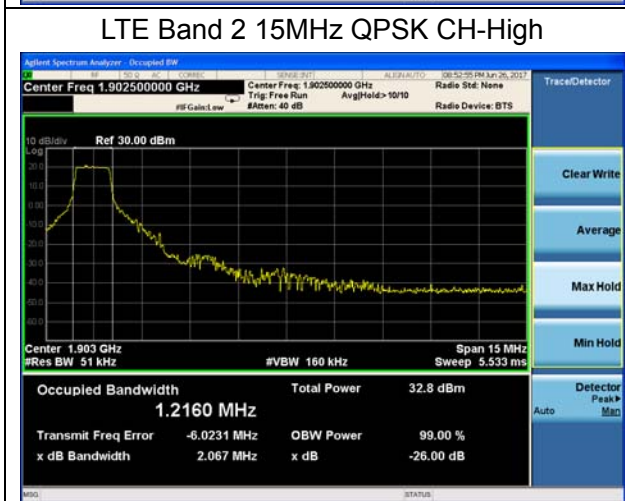
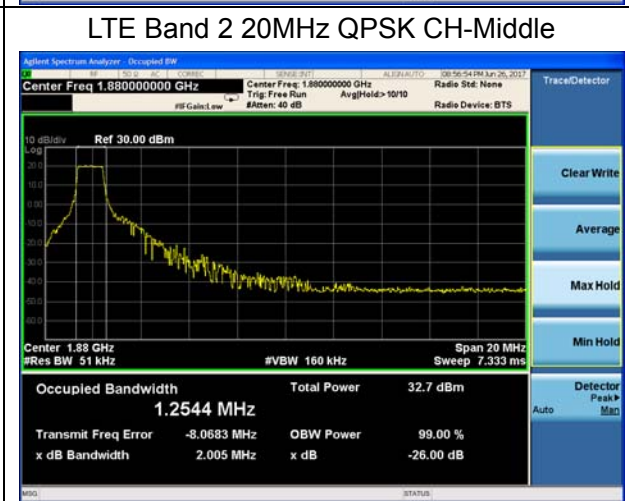
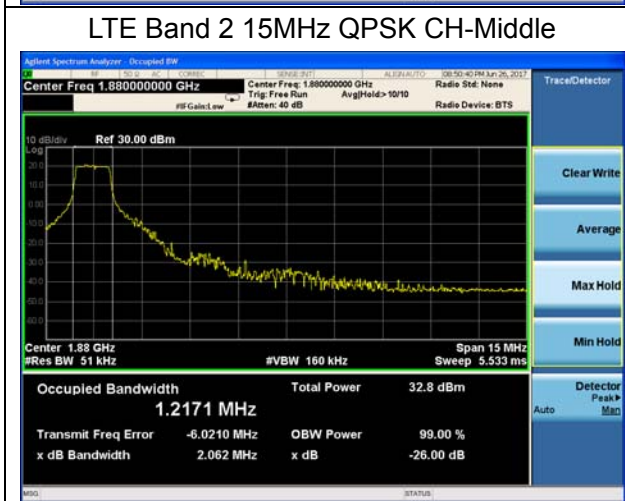
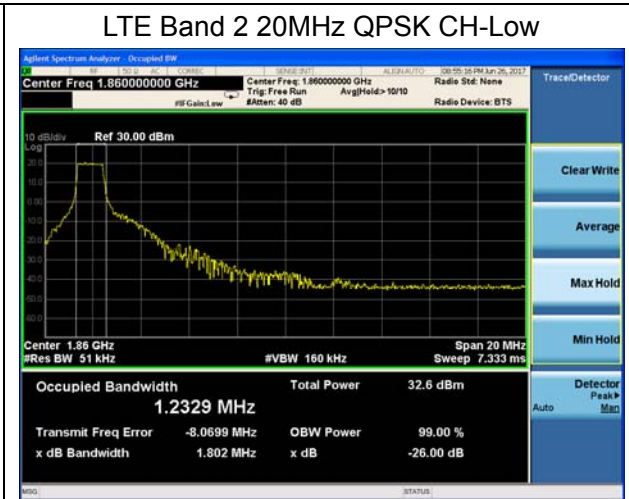
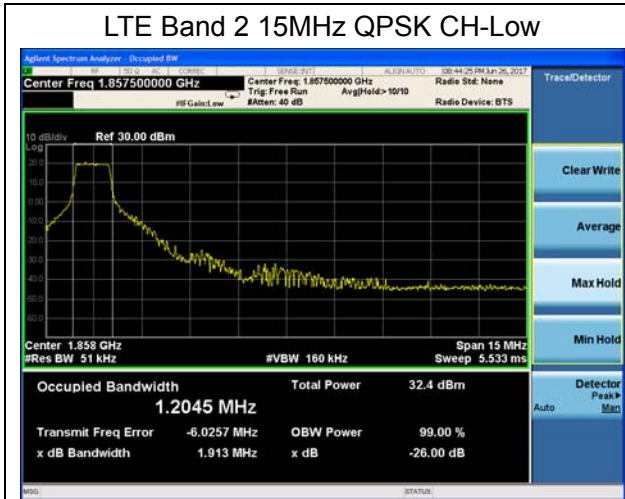

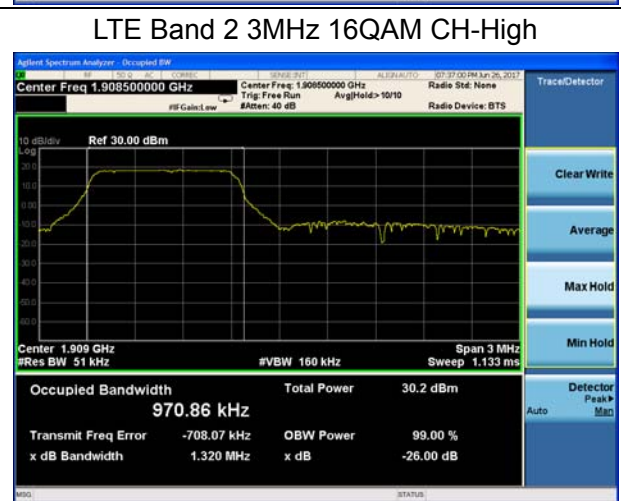
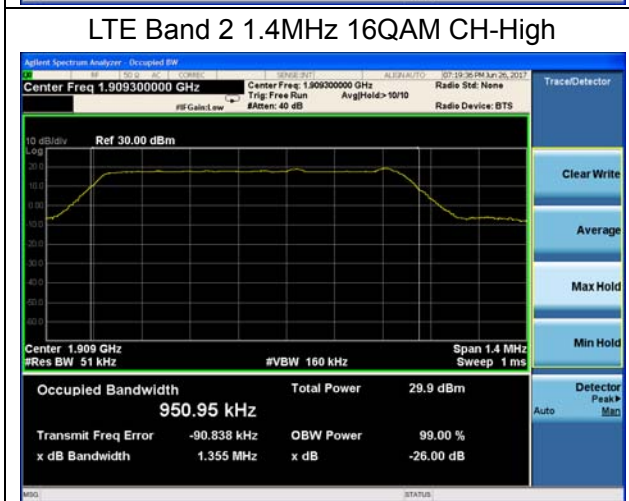
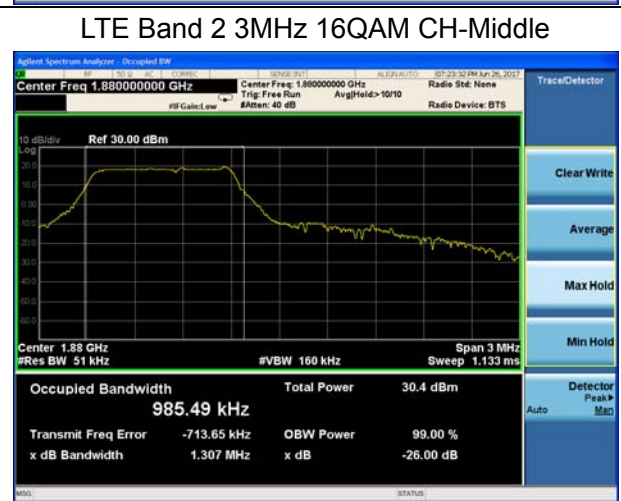
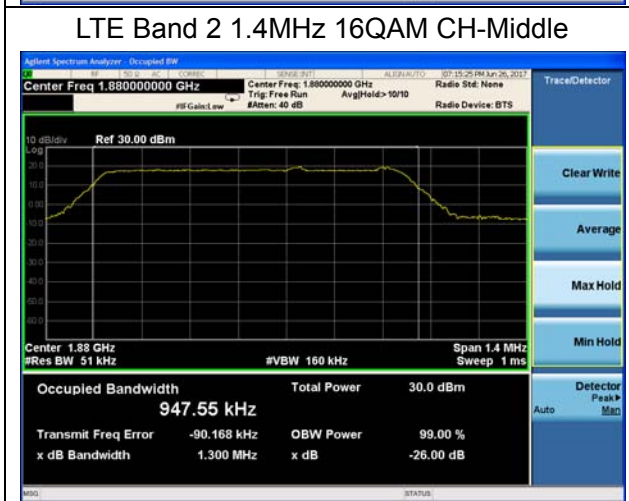
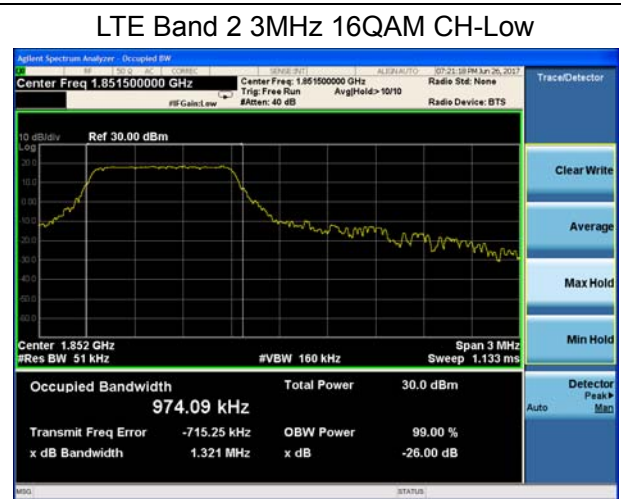
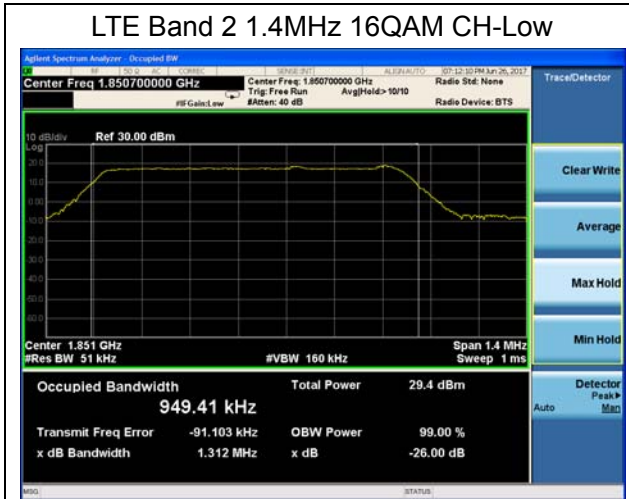

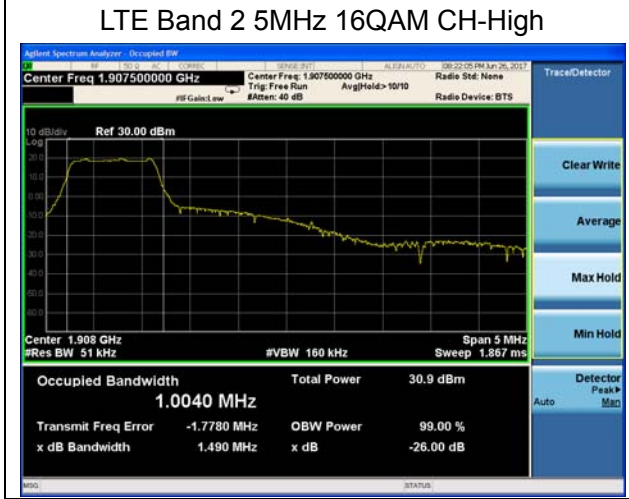
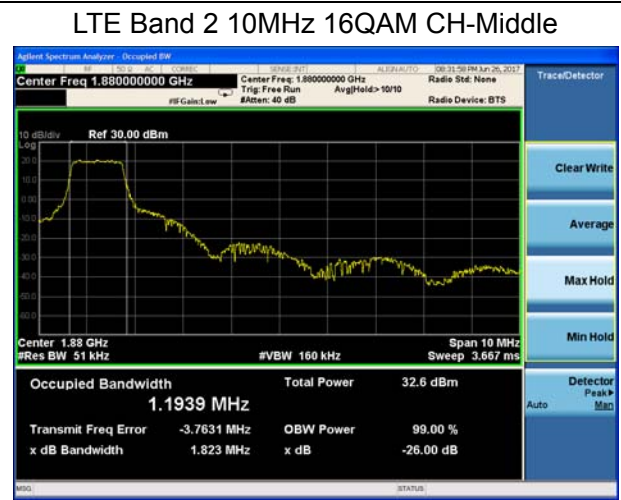
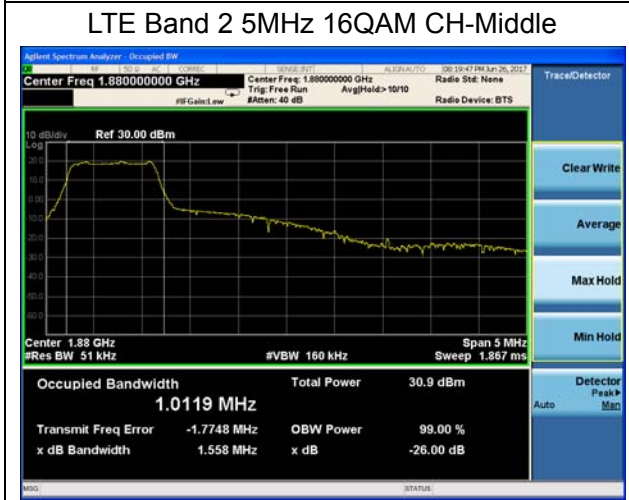
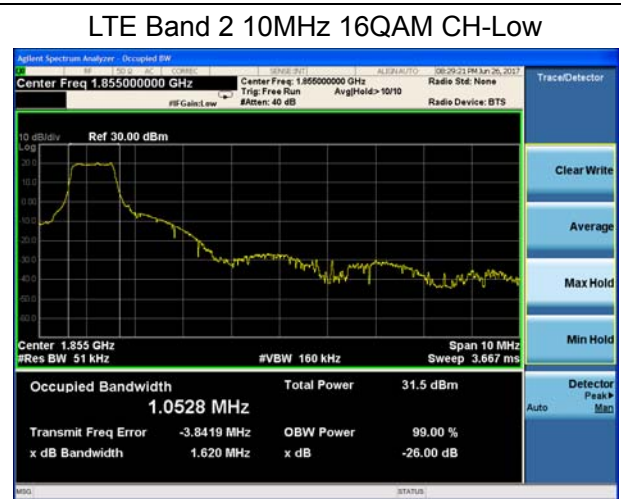
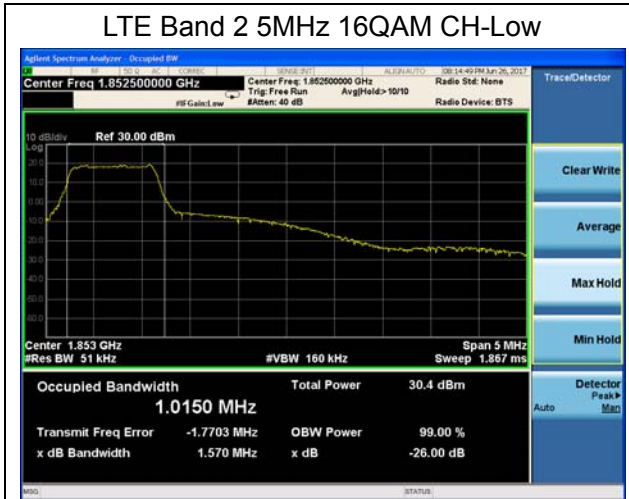





LTE Band 2 15MHz 16QAM CH-Low



LTE Band 2 20MHz 16QAM CH-Low



LTE Band 2 15MHz 16QAM CH-Middle



LTE Band 2 20MHz 16QAM CH-Middle

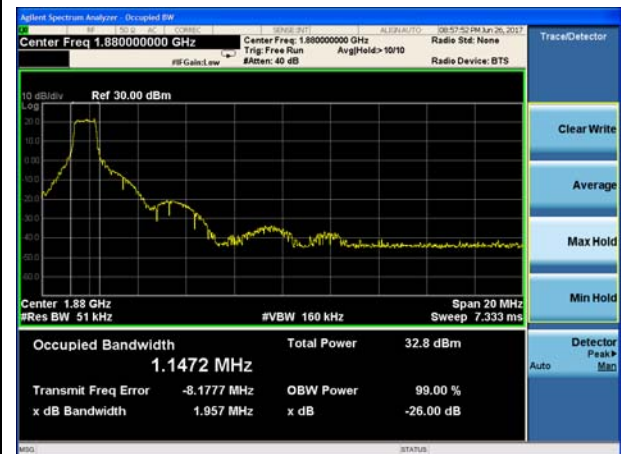

LTE Band 2 15MHz 16QAM CH-High

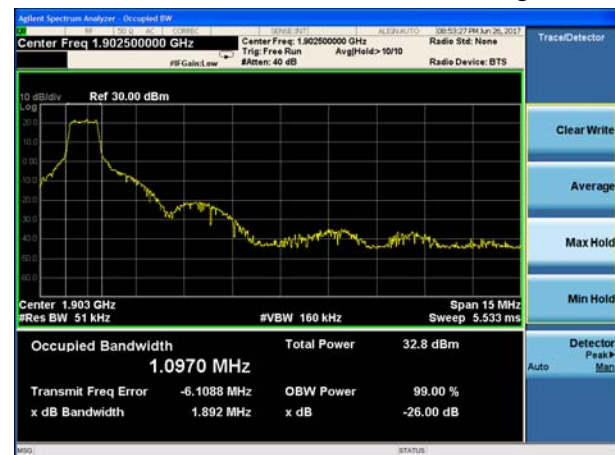

LTE Band 2 20MHz 16QAM CH-High

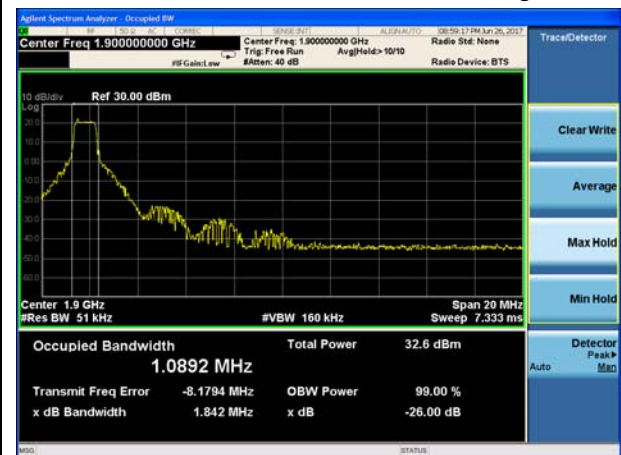

### 5.4. Band Edge Compliance

#### Ambient condition

Temperature	Relative humidity	Pressure
23°C ~25°C	45%~50%	101.5kPa

#### Method of Measurement

The EUT was connected to Spectrum Analyzer and Base Station Simulator via power Splitter. The band edge of the lowest and highest channels were measured. The Average detector is used and RBW is set to 3kHz, VBW is set to 10kHz for GSM 1900, RBW is set to 15kHz, VBW is set to 51kHz for LTE Band 2. Spectrum analyzer plots are included on the following pages.

#### Test Setup

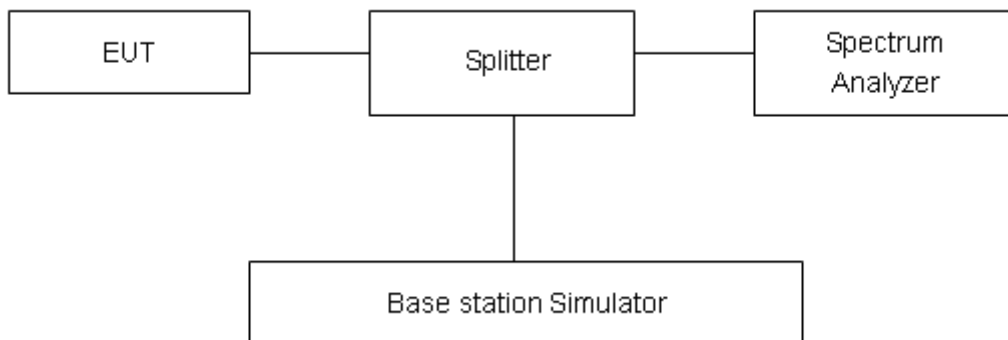

#### Limits

Rule Part 24.238(a) specifies that “on any frequency outside a licensee's frequency block, the power of any emission shall be attenuated below the transmitter power (P) by at least 43 + 10 log<sub>10</sub> (P) dB.”

Limit	-13 dBm
-------	---------

#### Measurement Uncertainty

The assessed measurement uncertainty to ensure 95% confidence level for the normal distribution is with the coverage factor  $k = 1.96$ ,  $U=0.684$ dB.



Test Result:

GSM1900 GPRS CH-Low



GSM 1900 GPRS CH-High



GSM1900 EGPRS CH-Low



GSM 1900 EGPRS CH-High



LTE Band 2 1.4MHz QPSK 1RB CH-Low

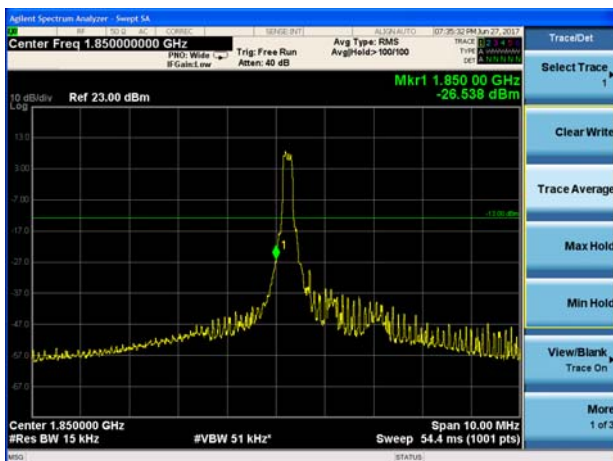

LTE Band 2 1.4MHz QPSK 1RB CH-High

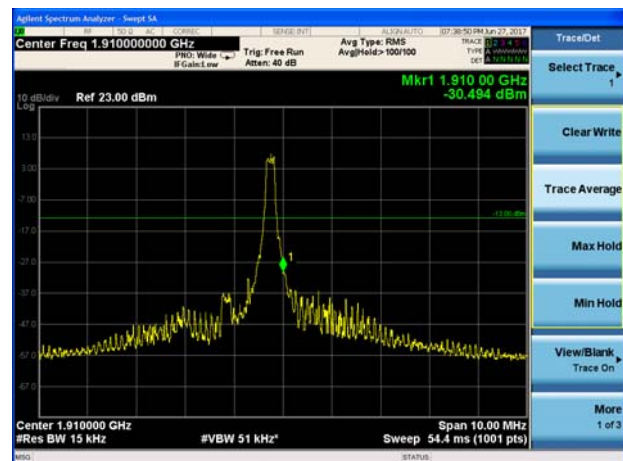



LTE Band 2 1.4MHz QPSK 100%RB CH-Low

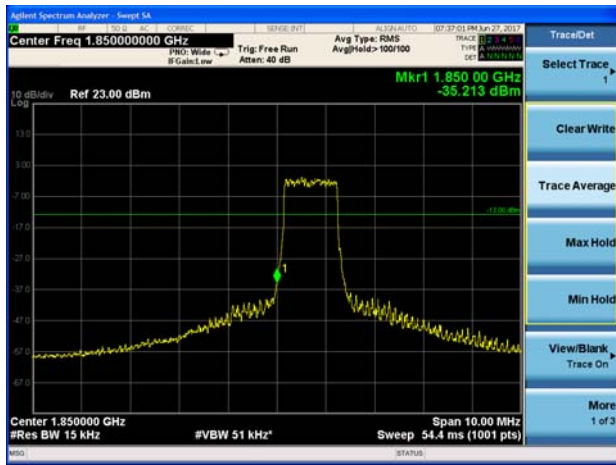

LTE Band 2 1.4MHz QPSK 100%RB CH-High

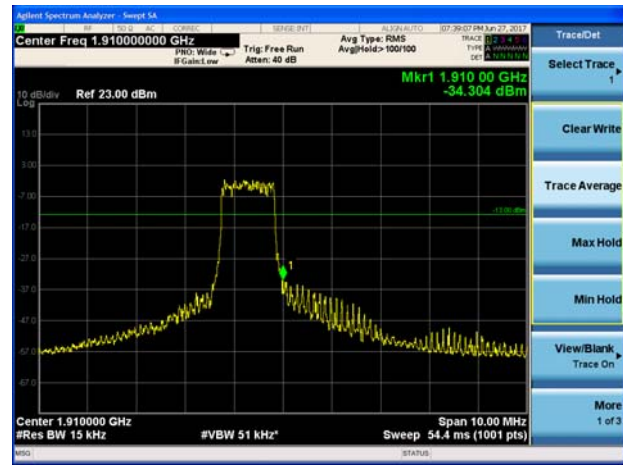

LTE Band 2 3MHz QPSK 1RB CH-Low

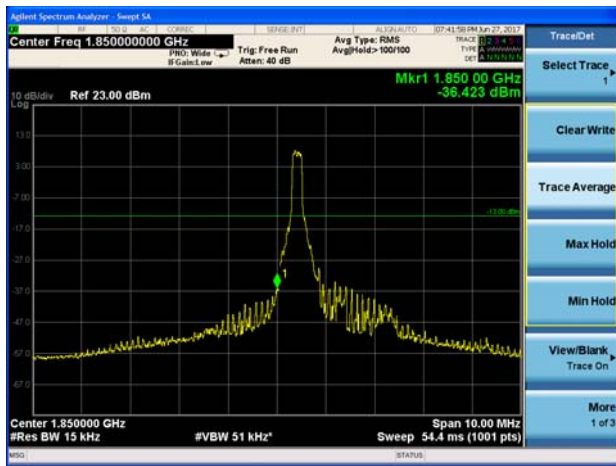

LTE Band 2 3MHz QPSK 1RB CH-High

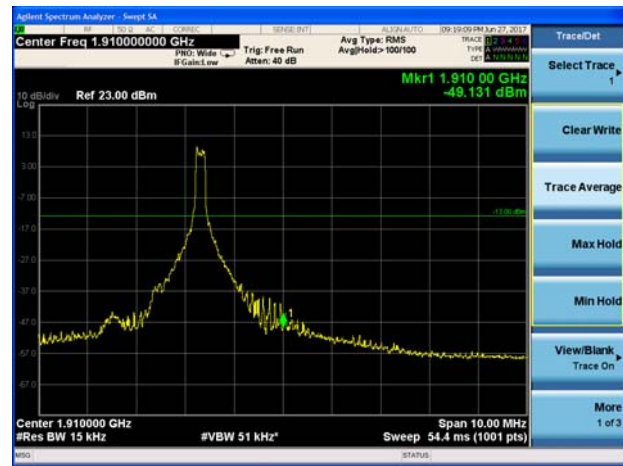

LTE Band 2 3MHz QPSK 100%RB CH-Low

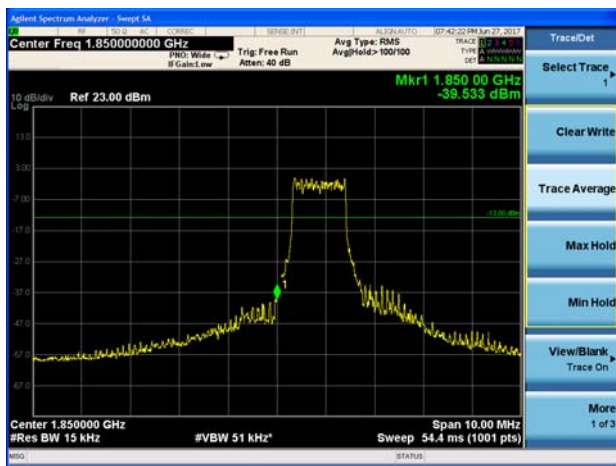

LTE Band 2 3MHz QPSK 100%RB CH-High

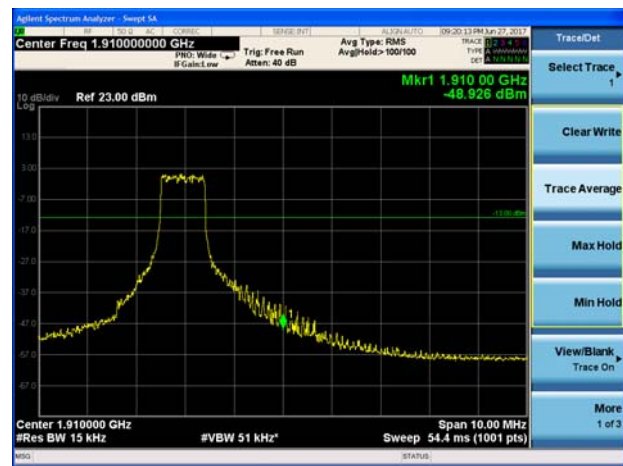





LTE Band 2 5MHz QPSK 1RB CH-Low

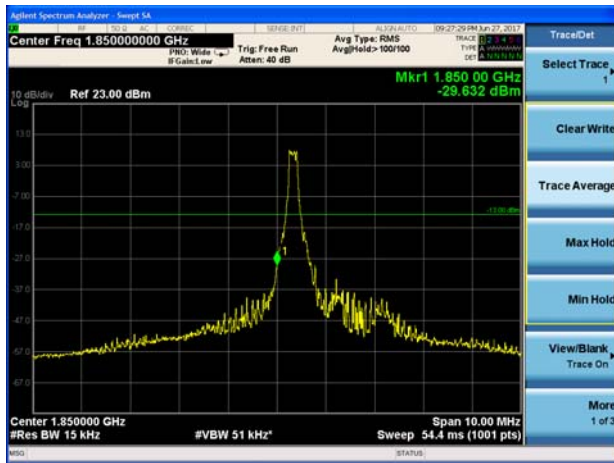

LTE Band 2 5MHz QPSK 1RB CH-High

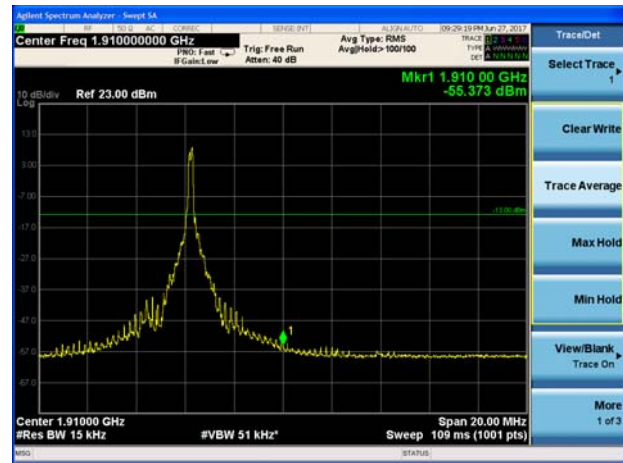

LTE Band 2 5MHz QPSK 100%RB CH-Low

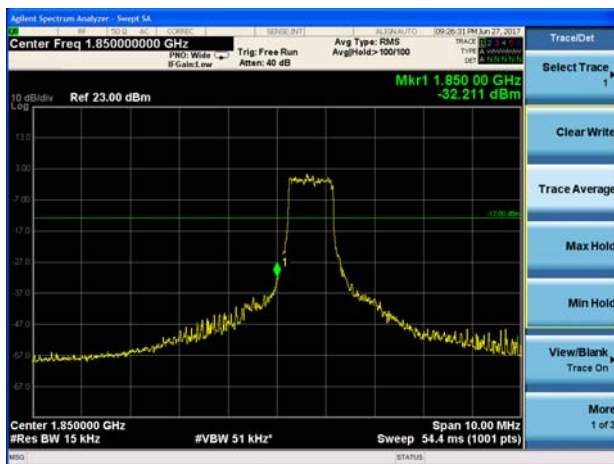

LTE Band 2 5MHz QPSK 100%RB CH-High

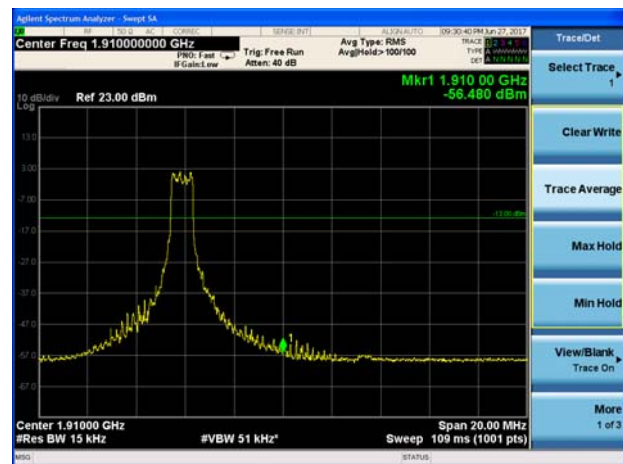

LTE Band 2 10MHz QPSK 1RB CH-Low

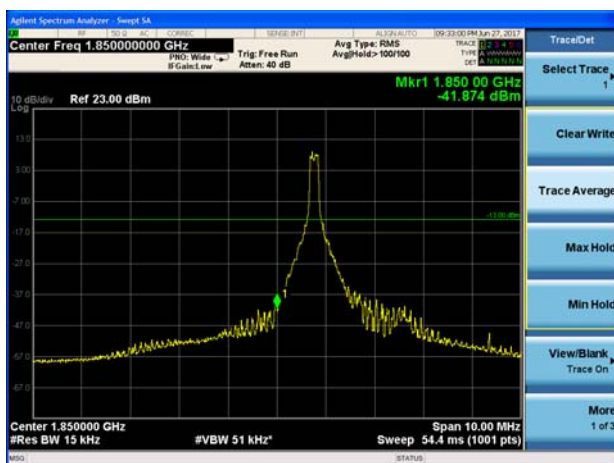

LTE Band 2 10MHz QPSK 1RB CH-High

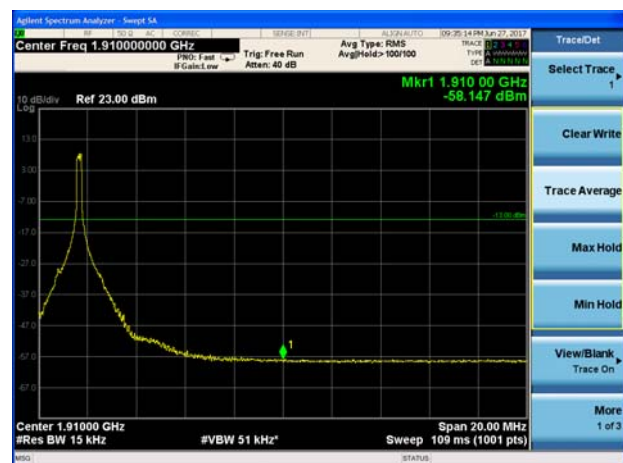



LTE Band 2 10MHz QPSK 100%RB CH-Low

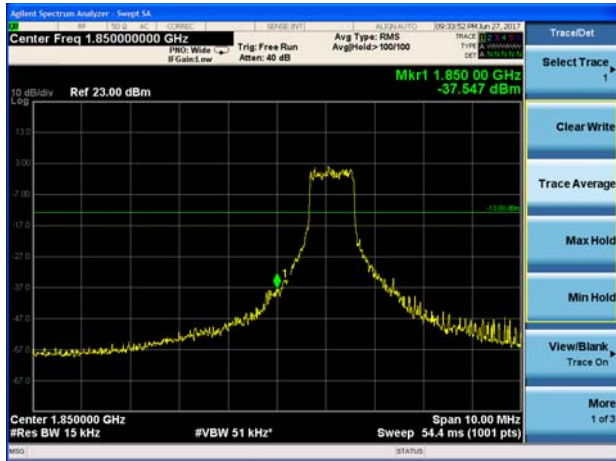

LTE Band 2 10MHz QPSK 100%RB CH-High

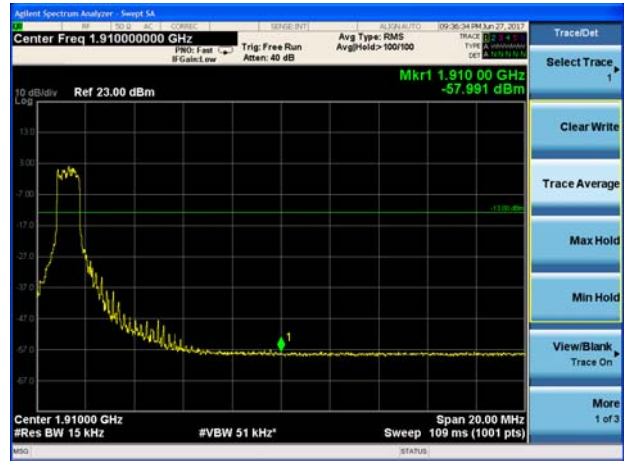

LTE Band 2 15MHz QPSK 1RB CH-Low

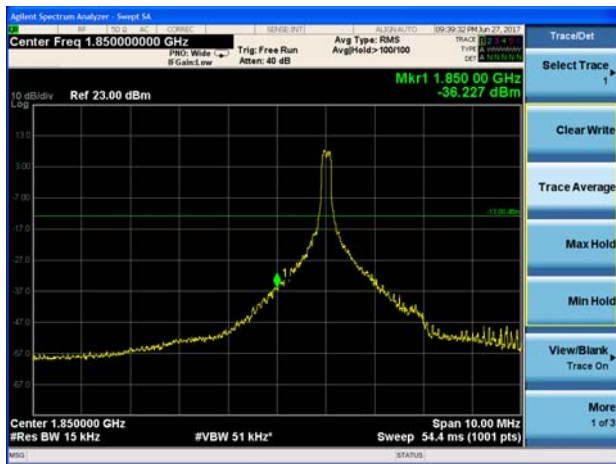

LTE Band 2 15MHz QPSK 1RB CH-High

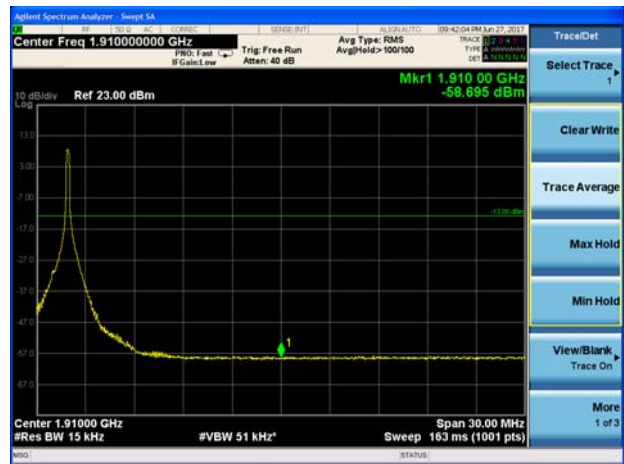

LTE Band 2 15MHz QPSK 100%RB CH-Low

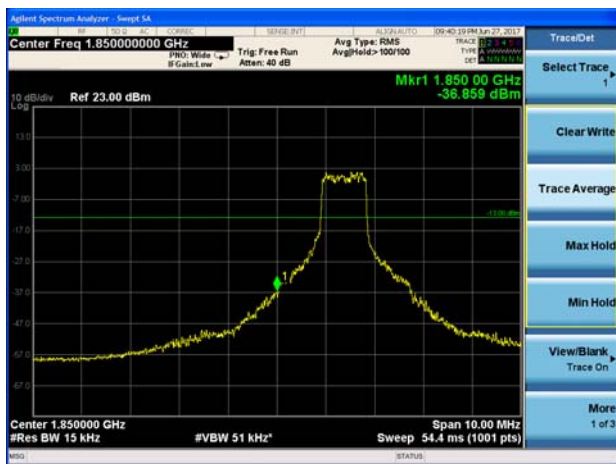

LTE Band 2 15MHz QPSK 100%RB CH-High

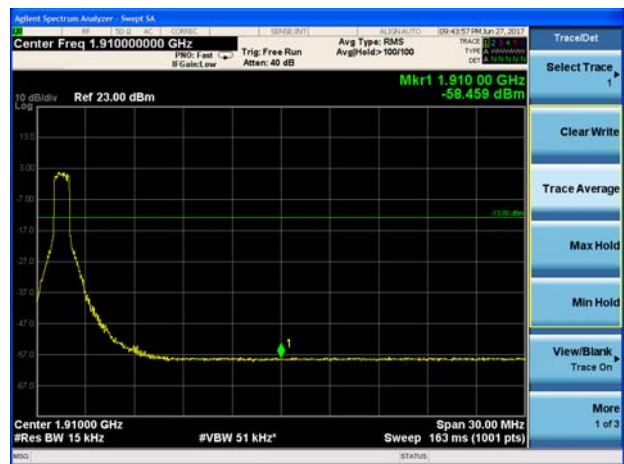



LTE Band 2 20MHz QPSK 1RB CH-Low

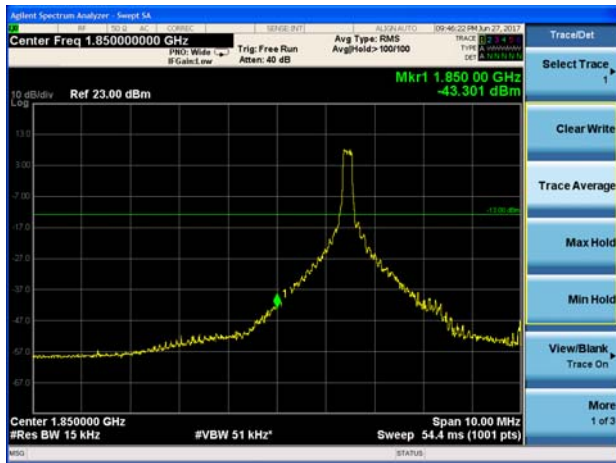

LTE Band 2 20MHz QPSK 1RB CH-High

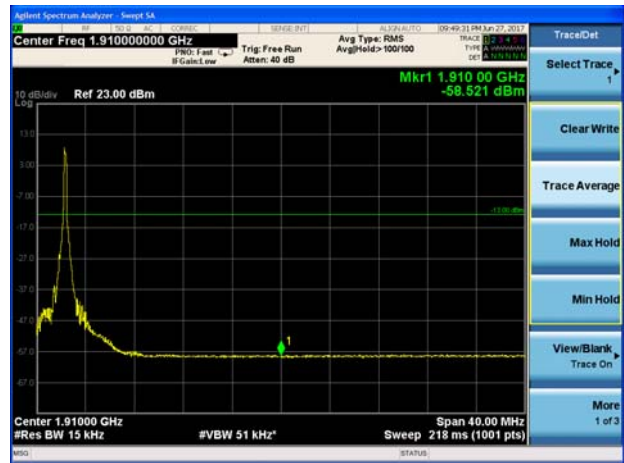

LTE Band 2 20MHz QPSK 100%RB CH-Low

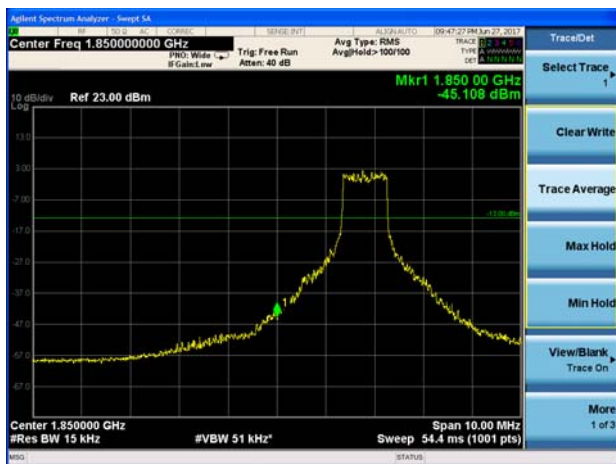

LTE Band 2 20MHz QPSK 100%RB CH-High

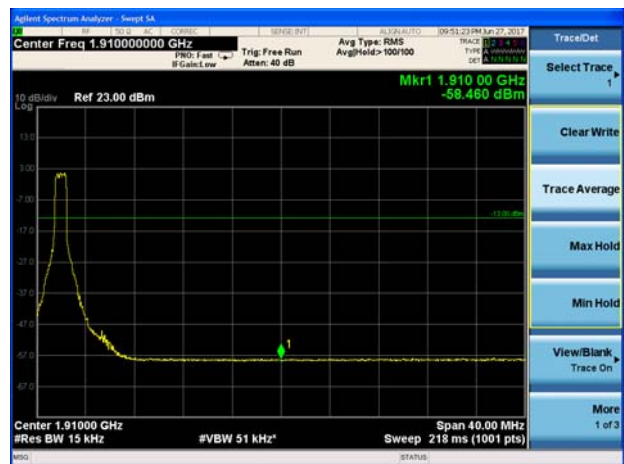

LTE Band 2 1.4MHz 16QAM 1RB CH-Low

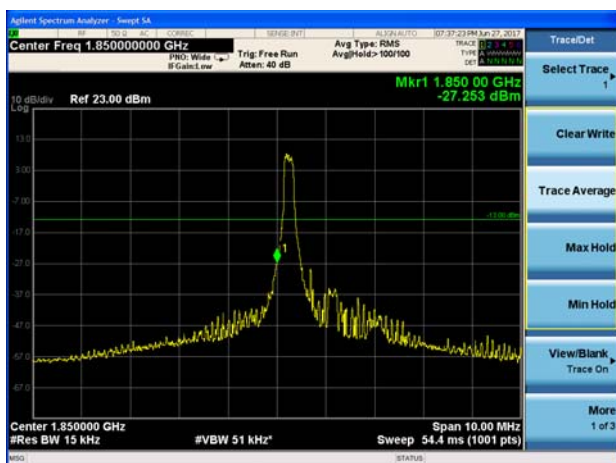

LTE Band 2 1.4MHz 16QAM 1RB CH-High

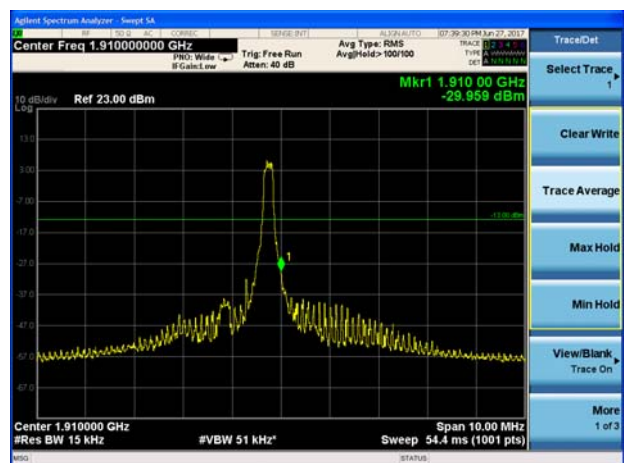



LTE Band 2 1.4MHz 16QAM 100%RB CH-Low

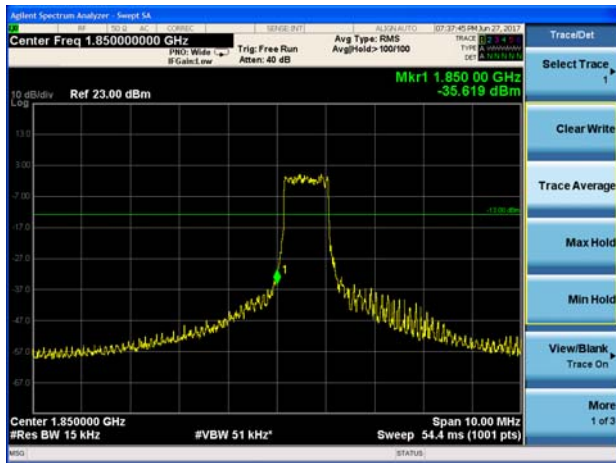

LTE Band 2 1.4MHz 16QAM 100%RB CH-High

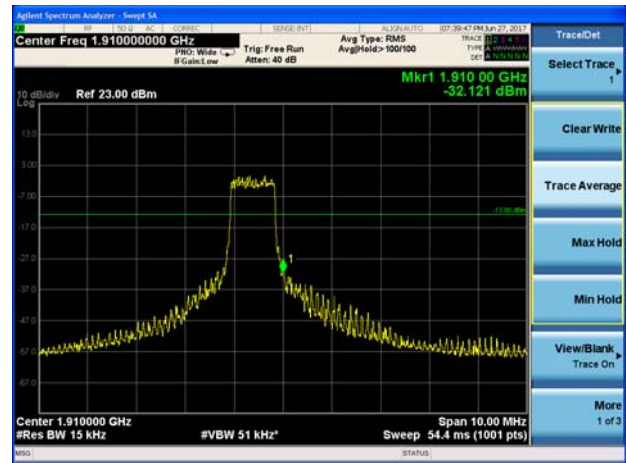

LTE Band 2 3MHz 16QAM 1RB CH-Low

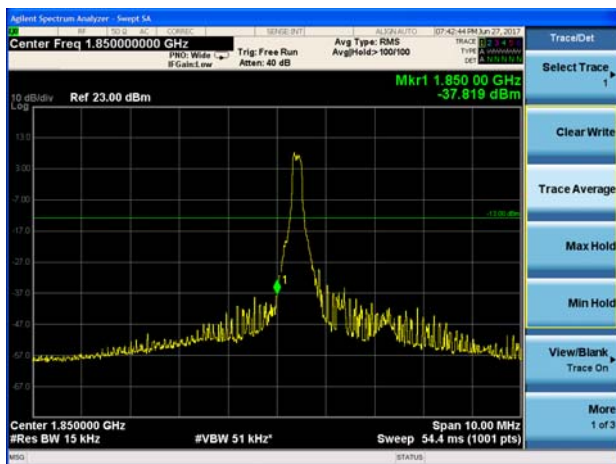

LTE Band 2 3MHz 16QAM 1RB CH-High

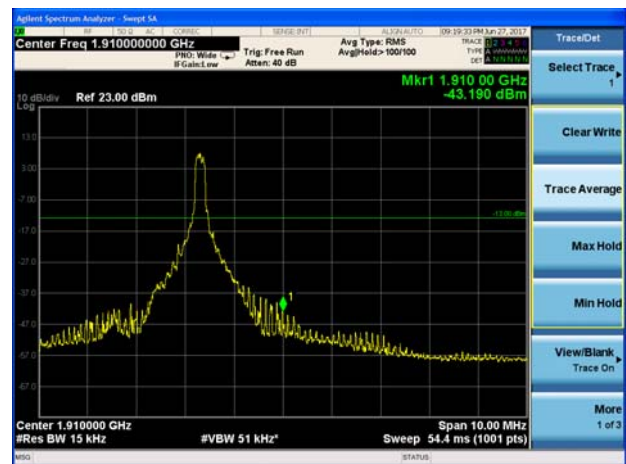

LTE Band 2 3MHz 16QAM 100%RB CH-Low

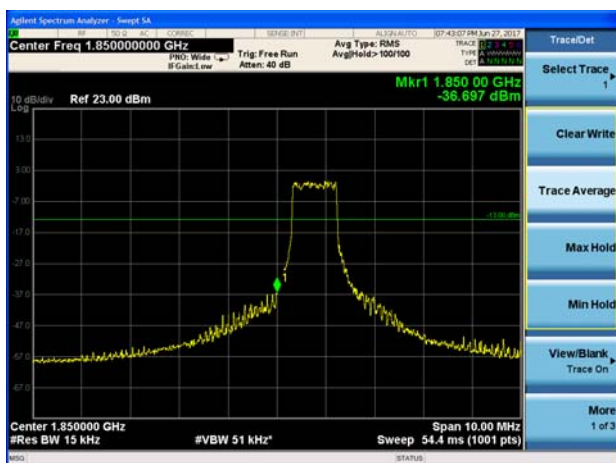

LTE Band 2 3MHz 16QAM 100%RB CH-High

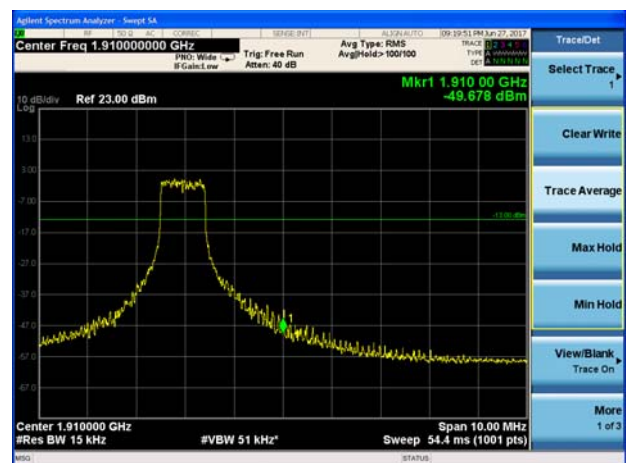





LTE Band 2 5MHz 16QAM 1RB CH-Low

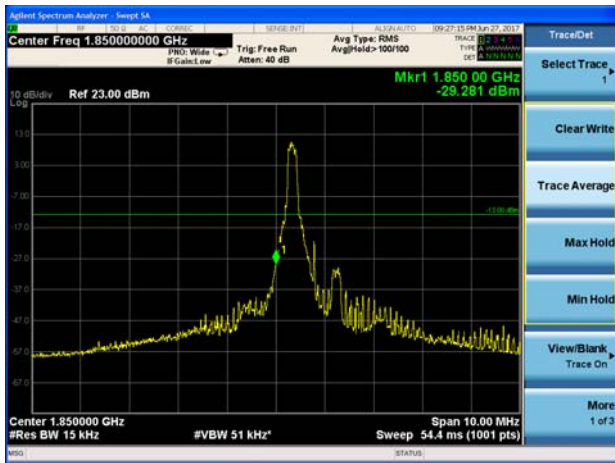

LTE Band 2 5MHz 16QAM 1RB CH-High

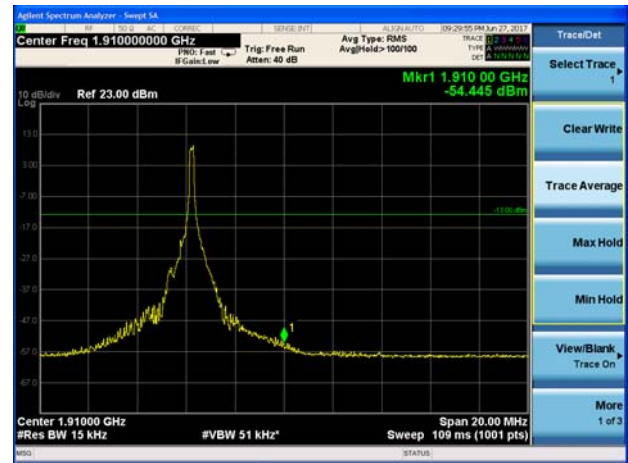

LTE Band 2 5MHz 16QAM 100%RB CH-Low

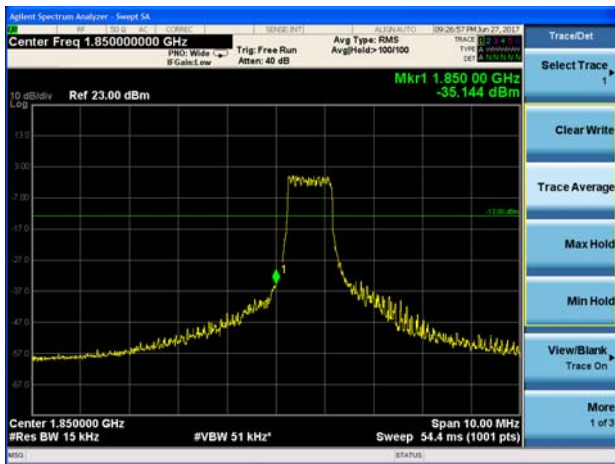

LTE Band 2 5MHz 16QAM 100%RB CH-High

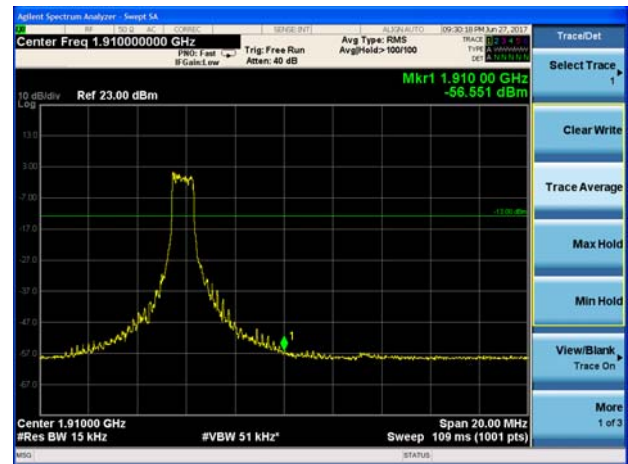

LTE Band 2 10MHz 16QAM 1RB CH-Low

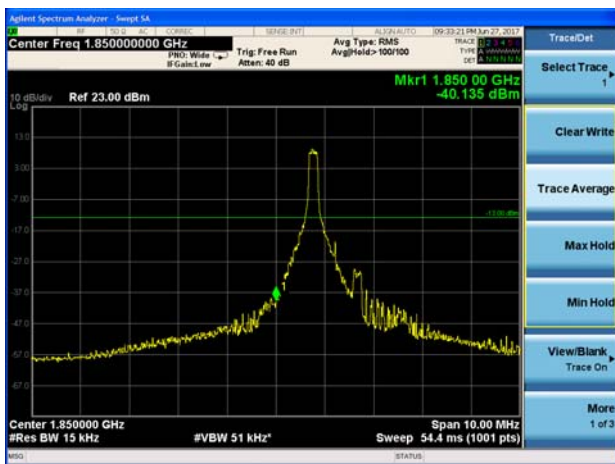

LTE Band 2 10MHz 16QAM 1RB CH-High

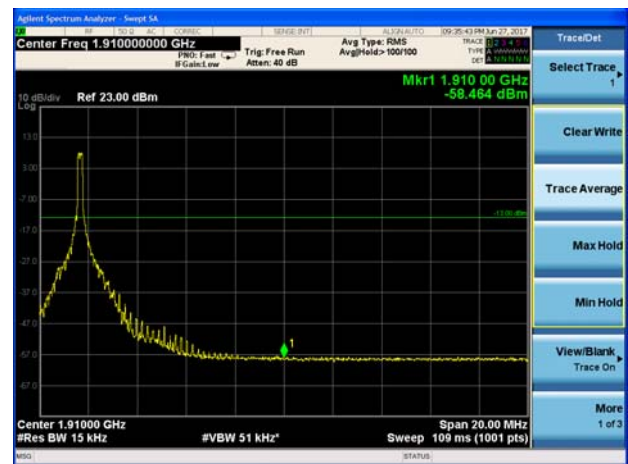



LTE Band 2 10MHz 16QAM 100%RB CH-Low

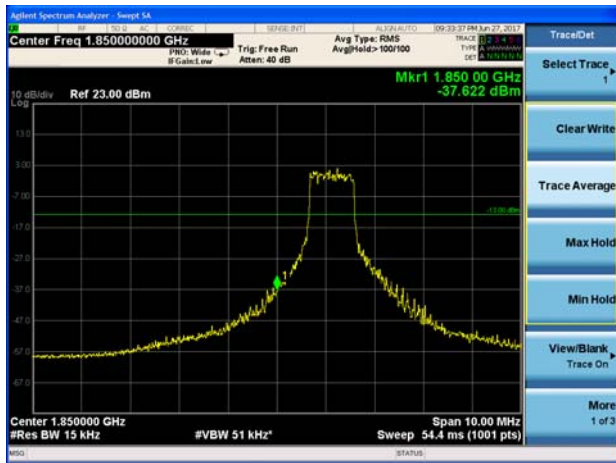

LTE Band 2 10MHz 16QAM 100%RB CH-High

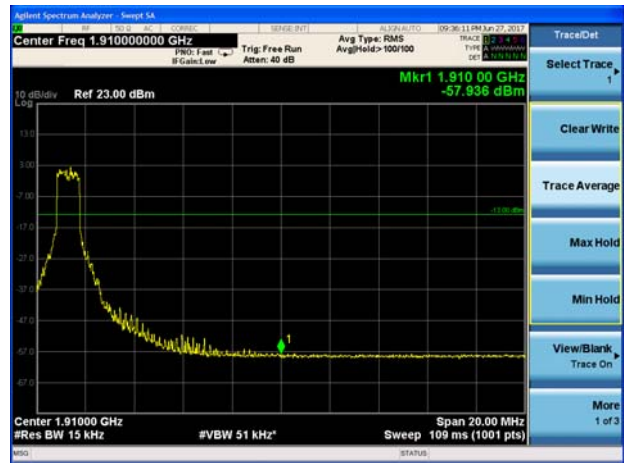

LTE Band 2 15MHz 16QAM 1RB CH-Low

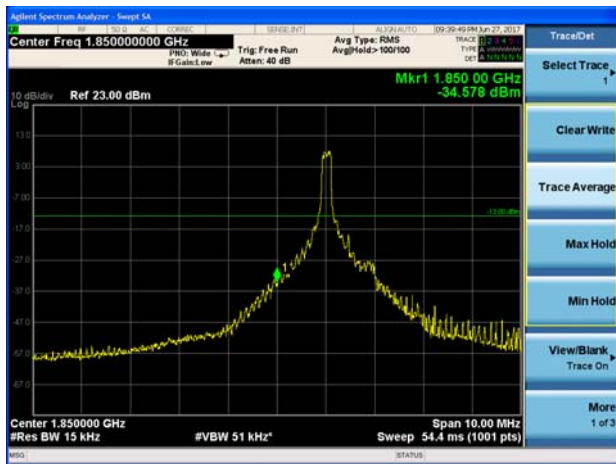

LTE Band 2 15MHz 16QAM 1RB CH-High

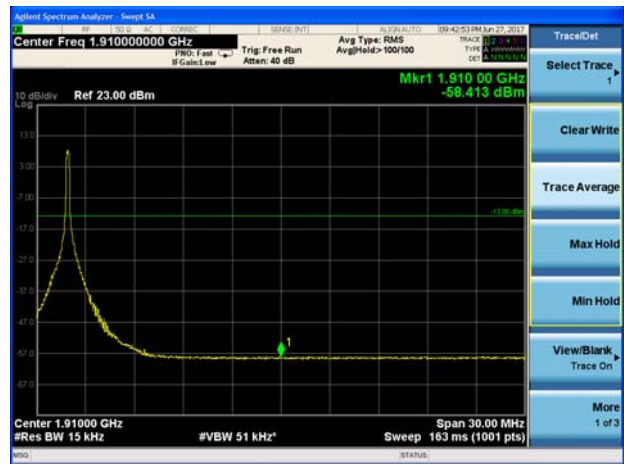

LTE Band 2 15MHz 16QAM 100%RB CH-Low

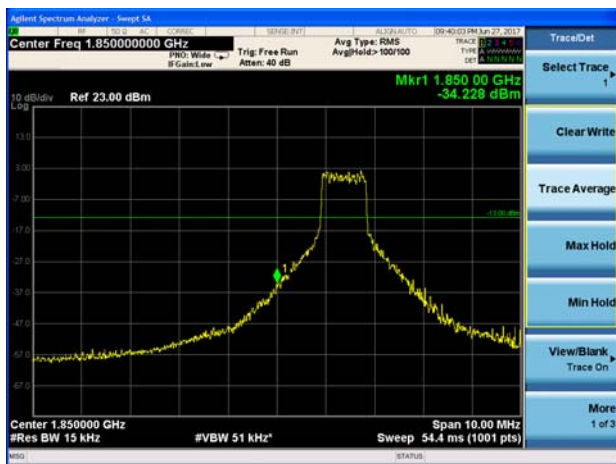

LTE Band 2 15MHz 16QAM 100%RB CH-High

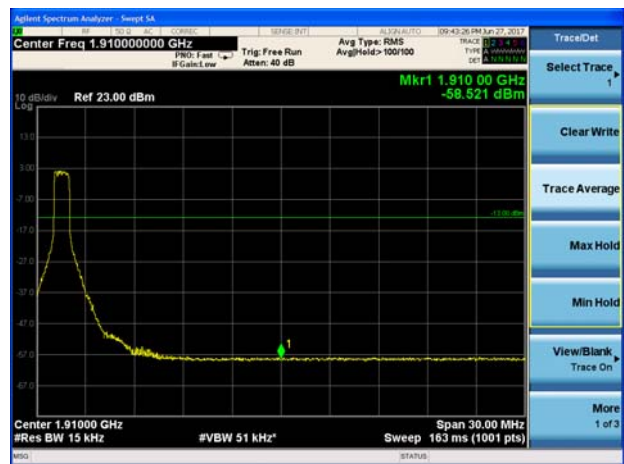



### LTE Band 2 20MHz 16QAM 1RB CH-Low

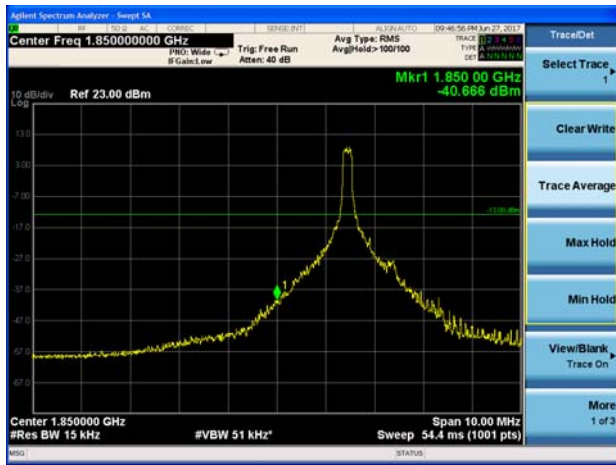

### LTE Band 2 20MHz 16QAM 1RB CH-High



### LTE Band 2 20MHz 16QAM 100%RB CH-Low

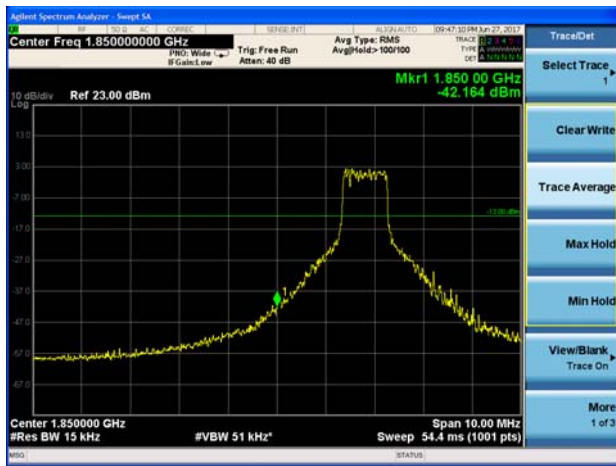

### LTE Band 2 20MHz 16QAM 100%RB CH-High

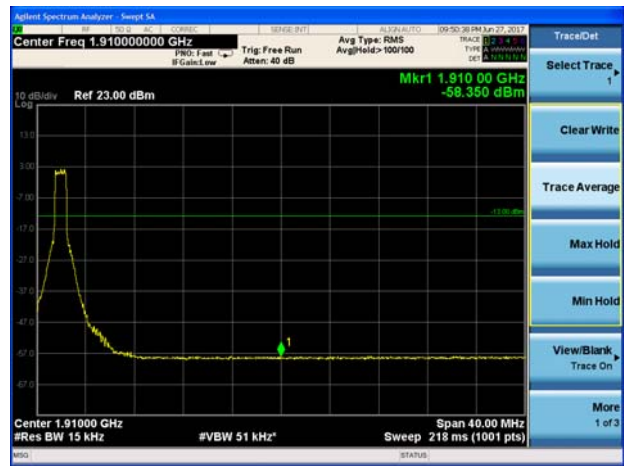

### 5.5. Peak-to-Average Power Ratio (PAPR)

#### Ambient condition

Temperature	Relative humidity	Pressure
23°C ~25°C	45%~50%	101.5kPa

#### Methods of Measurement

Measure the total peak power and record as PPk. And measure the total average power and record as PAvg. Both the peak and average power levels must be expressed in the same logarithmic units (e.g., dBm). Determine the PAPR from:

$$PAPR (dB) = PPk (dBm) - PAvg (dBm).$$

#### Test Setup

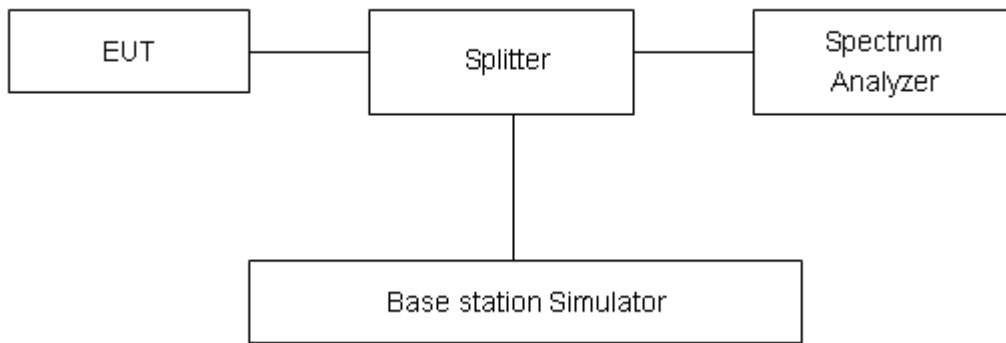

#### Limits

In measuring transmissions in this band using an average power technique, the peak-to-average ratio (PAR) of the transmission may not exceed 13 dB in 24.232(d).

#### Measurement Uncertainty

The assessed measurement uncertainty to ensure 95% confidence level for the normal distribution is with the coverage factor  $k = 2$ ,  $U = 0.4$  dB.





## Test Results

Mode	Channel	Frequency (MHz)	Peak(dBm)	Avg(dBm)	PAPR(dB)	Limit(dB)	Conclusion
GPRS 1900 (GMSK)	512	1850.2	30.38	29.42	0.96	≤13	PASS
	661	1880	30.34	29.32	1.02	≤13	PASS
	810	1909.8	30.21	29.16	1.05	≤13	PASS
EGPRS 1900 (8-PSK)	512	1850.2	26.46	25.57	0.89	≤13	PASS
	661	1880	26.36	25.45	0.91	≤13	PASS
	810	1909.8	26.23	25.38	0.85	≤13	PASS

LTE Band 2		Channel	Frequency (MHz)	Peak (dBm)	Avg (dBm)	PAPR (dB)	Limit(dB)	Conclusion
Modulation	Bandwidth							
QPSK	1.4MHz	18607	1850.7	33.20	23.42	9.78	≤13	PASS
		18900	1880.0	33.29	23.55	9.74	≤13	PASS
		19193	1909.3	33.26	23.70	9.56	≤13	PASS
	3MHz	18615	1851.5	33.43	23.45	9.98	≤13	PASS
		18900	1880	33.32	23.59	9.73	≤13	PASS
		19185	1908.5	32.81	23.73	9.08	≤13	PASS
	5MHz	18625	1852.5	33.04	23.43	9.61	≤13	PASS
		18900	1880	32.76	23.58	9.18	≤13	PASS
		19175	1907.5	33.14	23.71	9.43	≤13	PASS
	10MHz	18650	1855	32.90	23.51	9.39	≤13	PASS
		18900	1880	32.72	23.60	9.12	≤13	PASS
		19150	1905	32.88	23.75	9.13	≤13	PASS
	15MHz	18675	1857.5	33.01	23.49	9.52	≤13	PASS
		18900	1880	31.57	23.56	8.01	≤13	PASS
		19125	1902.5	32.78	23.70	9.08	≤13	PASS
20MHz	18700	1860	32.46	23.46	9.00	≤13	PASS	
	18900	1880	32.45	23.51	8.94	≤13	PASS	
	19100	1900	32.88	23.66	9.22	≤13	PASS	
16QAM	1.4MHz	18607	1850.7	34.04	23.52	10.52	≤13	PASS
		18900	1880.0	34.38	23.72	10.66	≤13	PASS
		19193	1909.3	33.85	23.74	10.11	≤13	PASS
	3MHz	18615	1851.5	33.72	23.55	10.17	≤13	PASS
		18900	1880	34.41	23.76	10.65	≤13	PASS
		19185	1908.5	33.45	23.77	9.68	≤13	PASS
	5MHz	18625	1852.5	33.46	23.53	9.93	≤13	PASS
		18900	1880	33.88	23.72	10.16	≤13	PASS
		19175	1907.5	33.42	23.72	9.70	≤13	PASS
10MHz	18650	1855	33.32	23.56	9.76	≤13	PASS	



		18900	1880	33.69	23.77	9.92	≤13	PASS
		19150	1905	33.11	23.76	9.35	≤13	PASS
	15MHz	18675	1857.5	32.77	23.53	9.24	≤13	PASS
		18900	1880	32.69	23.72	8.97	≤13	PASS
		19125	1902.5	32.75	23.72	9.03	≤13	PASS
	20MHz	18700	1860	33.37	23.51	9.86	≤13	PASS
		18900	1880	32.98	23.68	9.30	≤13	PASS
		19100	1900	32.98	23.69	9.29	≤13	PASS

## 5.6. Frequency Stability

### Ambient condition

Temperature	Relative humidity	Pressure
23°C ~25°C	45%~50%	101.5kPa

### Method of Measurement

#### 1. Frequency Stability (Temperature Variation)

The temperature inside the climate chamber is varied from -40°C to +85°C in 10°C step size,

(1) With all power removed, the temperature was decreased to 0°C and permitted to stabilize for three hours.

(2) Measure the carrier frequency with the test equipment in a “call mode”. These measurements should be made within 1 minute of powering up the mobile station, to prevent significant self warming.

(3) Repeat the above measurements at 10°C increments from -40°C to +85°C. Allow at least 1.5 hours at each temperature, un-powered, before making measurements.

#### 2. Frequency Stability (Voltage Variation)

The frequency stability shall be measured with variation of primary supply voltage as follows:

(1) Vary primary supply voltage from 85 to 115 percent of the nominal value for other than hand carried battery equipment.

(2) For hand carried, battery powered equipment, reduce primary supply voltage to the battery-operating end point which shall be specified by the manufacturer.

This transceiver is specified to operate with an input voltage of between 3.3 V and 4.3 V, with a nominal voltage of 3.8V.

### Test setup

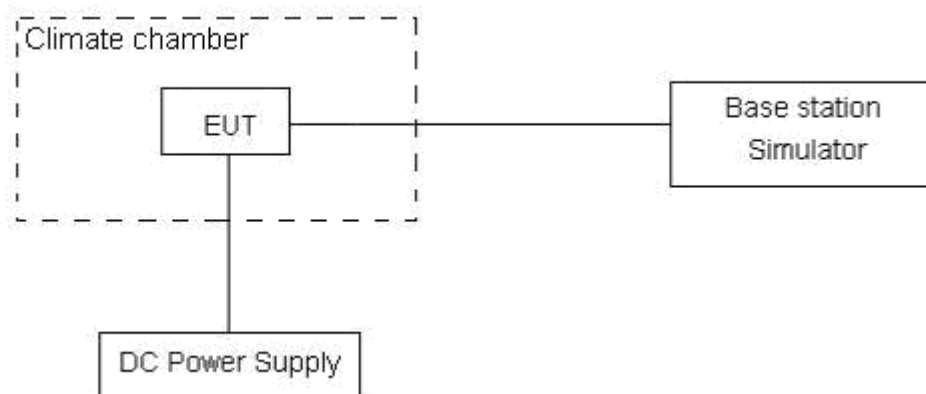

**Limits**

No specific frequency stability requirements in part 24.235

**Measurement Uncertainty**

The assessed measurement uncertainty to ensure 99.75% confidence level for the normal distribution is with the coverage factor  $k = 3$ ,  $U = 0.01\text{ppm}$ .

**Test Result**

Mode	Test status	Test Results (ppm)	
		GPRS(GMSK)	EGPRS(8PSK)
GSM 1900 Middle Channel	-40°C/Normal Voltage	0.0139	0.0135
	-30°C/Normal Voltage	0.0144	0.0070
	-20°C/Normal Voltage	0.0140	0.0129
	-10°C/Normal Voltage	0.0155	0.0123
	0°C/Normal Voltage	0.0170	0.0131
	10°C/Normal Voltage	0.0170	0.0120
	20°C/Normal Voltage	0.0185	0.0150
	30°C/Normal Voltage	0.0121	0.0119
	40°C/Normal Voltage	0.0162	0.0122
	50°C/Normal Voltage	0.0161	0.0140
	60°C/Normal Voltage	0.0146	0.0117
	70°C/Normal Voltage	0.0157	0.0124
	80°C/Normal Voltage	0.0145	0.0193
	85°C/Normal Voltage	0.0172	0.0118
	20°C/Min Voltage	0.0172	0.0125
20°C/Max Voltage	0.0137	0.0116	



Bandwidth	Test status	LTE Band 2 Middle Channel Test Results (ppm)	
		QPSK	16QAM
1.4MHz	-40°C/Normal Voltage	-0.00399	0.00378
	-30°C/Normal Voltage	-0.00274	0.00394
	-20°C/Normal Voltage	-0.00106	0.00364
	-10°C/Normal Voltage	-0.00433	0.00427
	0°C/Normal Voltage	-0.00320	0.00394
	10°C/Normal Voltage	-0.00021	0.00416
	20°C/Normal Voltage	-0.00184	0.00584
	30°C/Normal Voltage	-0.00221	0.00381
	40°C/Normal Voltage	-0.00271	0.00513
	50°C/Normal Voltage	-0.00241	0.00366
	60°C/Normal Voltage	-0.00366	0.00311
	70°C/Normal Voltage	-0.00218	0.00375
	80°C/Normal Voltage	-0.00166	0.00308
	85°C/Normal Voltage	-0.00124	0.00506
	20°C/Min Voltage	0.00060	0.00382
	20°C/Max Voltage	-0.00176	0.00370
3MHz	-40°C/Normal Voltage	-0.00113	0.00396
	-30°C/Normal Voltage	-0.00001	0.00337
	-20°C/Normal Voltage	-0.00161	0.00466
	-10°C/Normal Voltage	-0.00031	0.00533
	0°C/Normal Voltage	-0.00230	0.00514
	10°C/Normal Voltage	-0.00171	0.00461
	20°C/Normal Voltage	-0.00326	0.00501
	30°C/Normal Voltage	-0.00006	0.00295
	40°C/Normal Voltage	-0.00078	0.00408
	50°C/Normal Voltage	-0.00315	0.00440
	60°C/Normal Voltage	-0.00209	0.00459
	70°C/Normal Voltage	-0.00199	0.00624
	80°C/Normal Voltage	-0.00406	0.00580
	85°C/Normal Voltage	-0.00166	0.00471
20°C/Min Voltage	-0.00202	0.00473	
20°C/Max Voltage	-0.00419	0.00486	
5MHz	-40°C/Normal Voltage	-0.00069	-0.00293
	-30°C/Normal Voltage	-0.00293	-0.00303
	-20°C/Normal Voltage	-0.00041	0.00184
	-10°C/Normal Voltage	-0.00124	-0.00352
	0°C/Normal Voltage	-0.00276	-0.00260



	10°C/Normal Voltage	-0.00248	-0.00299
	20°C/Normal Voltage	-0.00054	-0.00269
	30°C/Normal Voltage	-0.00129	-0.00273
	40°C/Normal Voltage	-0.00036	-0.00256
	50°C/Normal Voltage	-0.00165	-0.00065
	60°C/Normal Voltage	-0.00072	-0.00313
	70°C/Normal Voltage	-0.00131	-0.00252
	80°C/Normal Voltage	-0.00295	-0.00371
	85°C/Normal Voltage	-0.00143	-0.00437
	20°C/Min Voltage	-0.00004	-0.00224
	20°C/Max Voltage	-0.00091	-0.00373
10MHz	-40°C/Normal Voltage	-0.00283	-0.00578
	-30°C/Normal Voltage	-0.00379	-0.00323
	-20°C/Normal Voltage	-0.00508	-0.00273
	-10°C/Normal Voltage	-0.00077	-0.00219
	0°C/Normal Voltage	-0.00171	-0.00193
	10°C/Normal Voltage	-0.00043	-0.00306
	20°C/Normal Voltage	-0.00134	-0.00188
	30°C/Normal Voltage	-0.00288	-0.00006
	40°C/Normal Voltage	-0.00229	-0.00064
	50°C/Normal Voltage	-0.00021	-0.00010
	60°C/Normal Voltage	-0.00154	-0.00259
	70°C/Normal Voltage	-0.00208	-0.00229
	80°C/Normal Voltage	-0.00301	-0.00195
	85°C/Normal Voltage	-0.00432	-0.00187
	20°C/Min Voltage	-0.00530	-0.00226
20°C/Max Voltage	-0.00360	-0.00285	
15MHz	-40°C/Normal Voltage	-0.00485	-0.00018
	-30°C/Normal Voltage	-0.00390	0.00080
	-20°C/Normal Voltage	-0.00460	-0.00331
	-10°C/Normal Voltage	-0.00395	-0.00046
	0°C/Normal Voltage	-0.00290	-0.00040
	10°C/Normal Voltage	-0.00181	0.00346
	20°C/Normal Voltage	-0.00136	0.00049
	30°C/Normal Voltage	-0.00043	-0.00009
	40°C/Normal Voltage	-0.00198	0.00215
	50°C/Normal Voltage	-0.00343	0.00212
	60°C/Normal Voltage	-0.00082	0.00301
	70°C/Normal Voltage	-0.00200	0.00572
	80°C/Normal Voltage	-0.00182	0.00515



	85°C/Normal Voltage	-0.00277	-0.00396	
	20°C/Min Voltage	-0.00148	-0.00195	
	20°C/Max Voltage	-0.00359	-0.00301	
20MHz	-40°C/Normal Voltage	0.00114	0.00435	
	-30°C/Normal Voltage	-0.00106	0.00396	
	-20°C/Normal Voltage	-0.00316	0.00235	
	-10°C/Normal Voltage	0.00012	0.00256	
	0°C/Normal Voltage	0.00135	0.00223	
	10°C/Normal Voltage	0.00097	0.00421	
	20°C/Normal Voltage	0.00222	0.00327	
	30°C/Normal Voltage	-0.00184	0.00301	
	40°C/Normal Voltage	-0.00004	0.00408	
	50°C/Normal Voltage	-0.00102	0.00639	
	60°C/Normal Voltage	-0.00186	0.00576	
	70°C/Normal Voltage	0.00230	0.00338	
	80°C/Normal Voltage	-0.00037	0.00271	
	85°C/Normal Voltage	-0.00040	0.00432	
		20°C/Min Voltage	-0.00101	0.00422
		20°C/Max Voltage	-0.00295	0.00636

### 5.7. Spurious Emissions at Antenna Terminals

#### Ambient condition

Temperature	Relative humidity	Pressure
23°C ~25°C	45%~50%	101.5kPa

#### Method of Measurement

The EUT was connected to Spectrum Analyzer and Base Station Simulator via power Splitter. The measurement is carried out using a spectrum analyzer. The spectrum analyzer scans from 9kHz to the 10th harmonic of the carrier. The peak detector is used.set RBW 1MHz and VBW is 3MHz, Sweep is set to ATUO.

#### Test setup

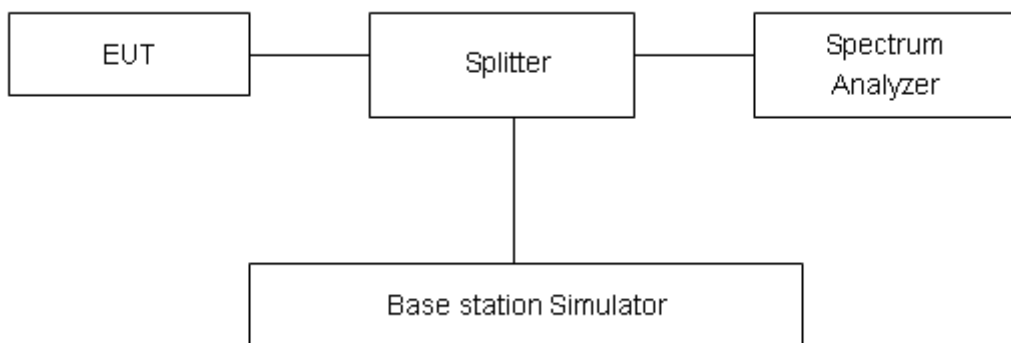

#### Limits

Rule Part 24.238(a) specifies that “on any frequency outside a licensee’s frequency block, the power of any emission shall be attenuated below the transmitter power (P) by at least 43 + 10 log<sub>10</sub> (P) dB.”

Limit	-13 dBm
-------	---------

#### Measurement Uncertainty

The assessed measurement uncertainty to ensure 99.75% confidence level for the normal distribution is with the coverage factor  $k = 1.96$ .

Frequency	Uncertainty
100kHz-2GHz	0.684 dB
2GHz-18GHz	1.407 dB





### Test Result

Sweep from 9 kHz to 30MHz, and the emissions more than 20 dB below the permissible value are not reported.

If disturbances were found more than 20dB below limit line, the mark is not required for the EUT. The signal beyond the limit is carrier.

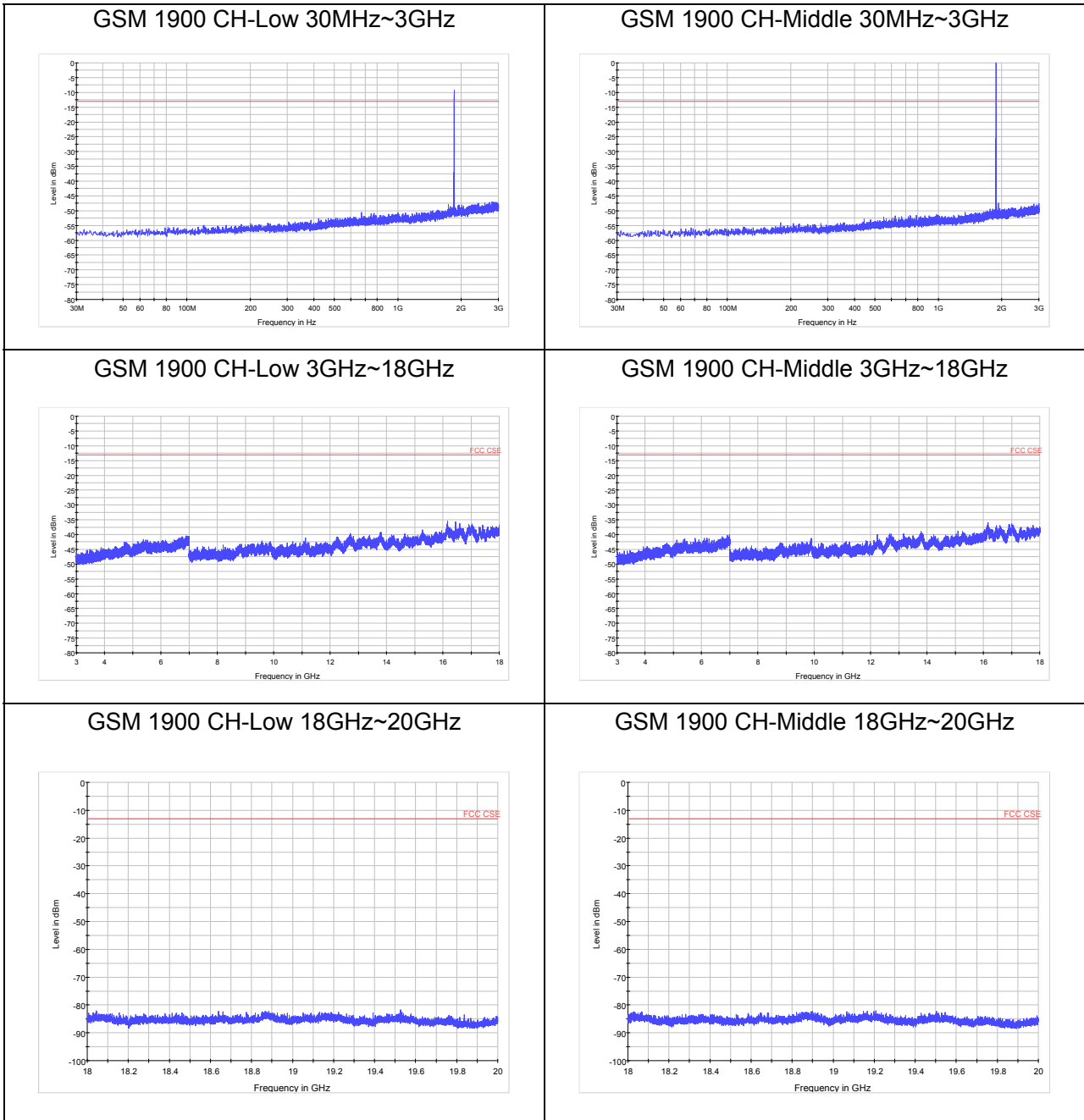



GSM 1900 CH-High 30MHz~3GHz

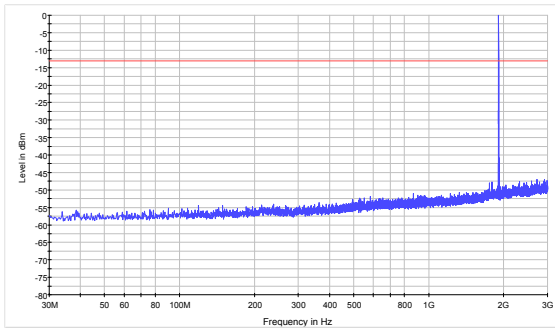

LTE Band 2 1.4MHz CH-Low 30MHz~3GHz

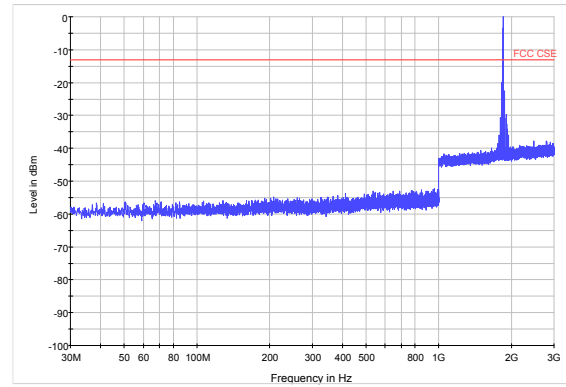

GSM 1900 CH-High 3GHz~18GHz

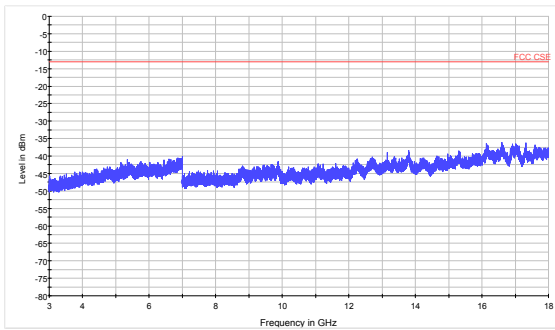

LTE Band 2 1.4MHz CH-Low 3GHz~18GHz

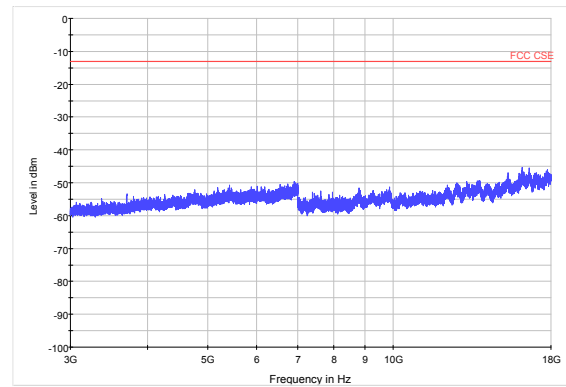

GSM 1900 CH-High 18GHz~20GHz

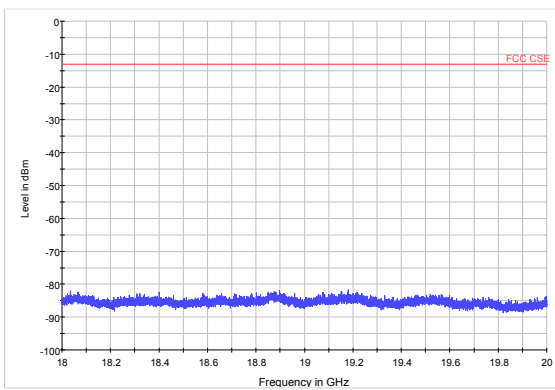

LTE Band 2 1.4MHz CH-Low 18GHz~20GHz

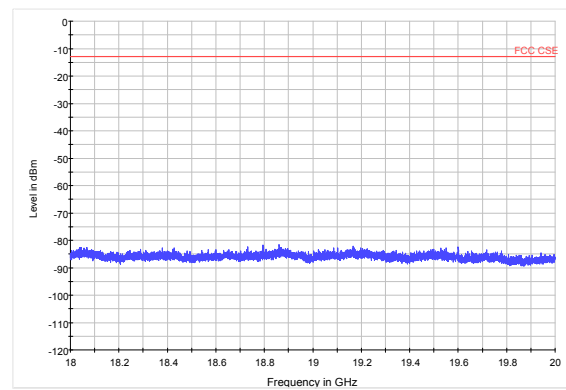



LTE Band 2 1.4MHz CH-Middle 30MHz~3GHz

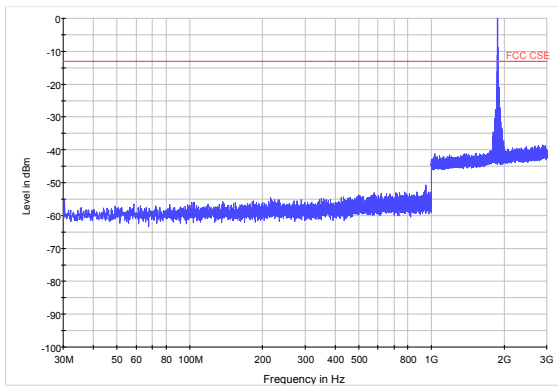

LTE Band 2 1.4MHz CH-High 30MHz~3GHz

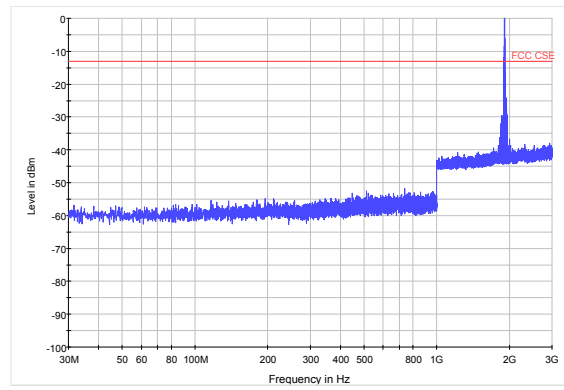

LTE Band 2 1.4MHz CH-Middle 3GHz~18GHz

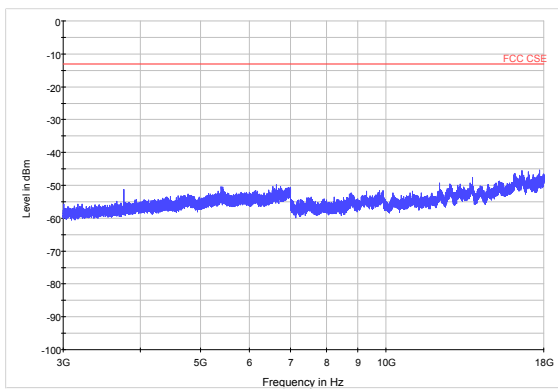

LTE Band 2 1.4MHz CH-High 3GHz~18GHz

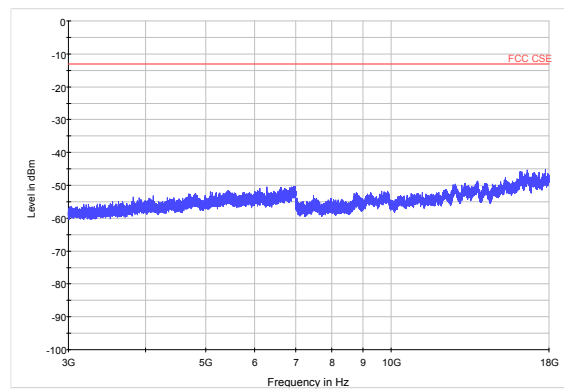

LTE Band 2 1.4MHz CH-Middle 18GHz~20GHz

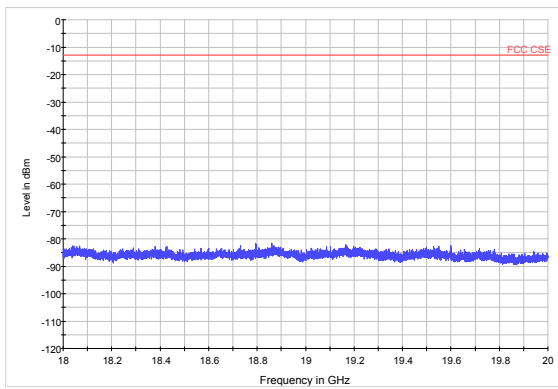

LTE Band 2 1.4MHz CH-High 18GHz~20GHz

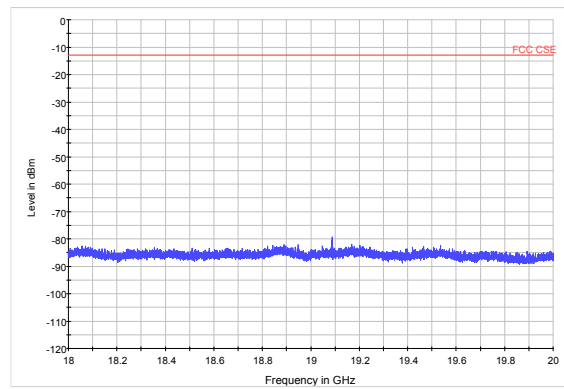



LTE Band 2 3MHz CH-Low 30MHz~3GHz

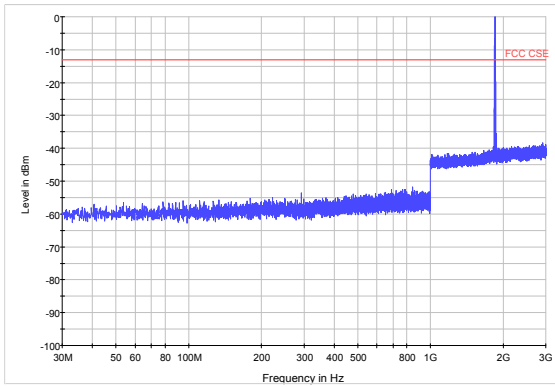

LTE Band 2 3MHz CH-Middle 30MHz~3GHz

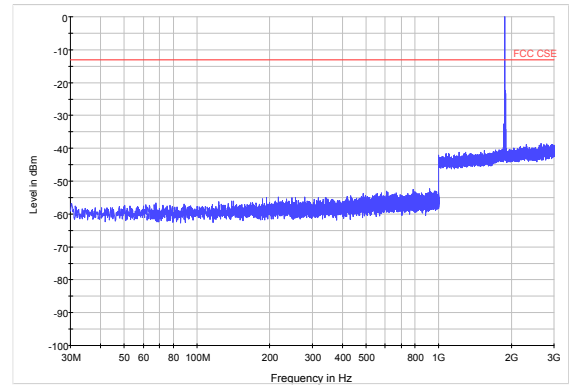

LTE Band 2 3MHz CH-Low 3GHz~18GHz

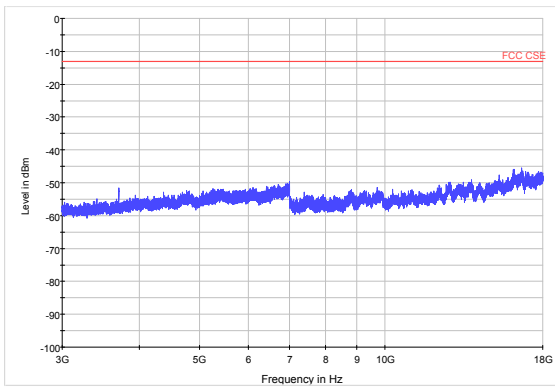

LTE Band 2 3MHz CH-Middle 3GHz~18GHz

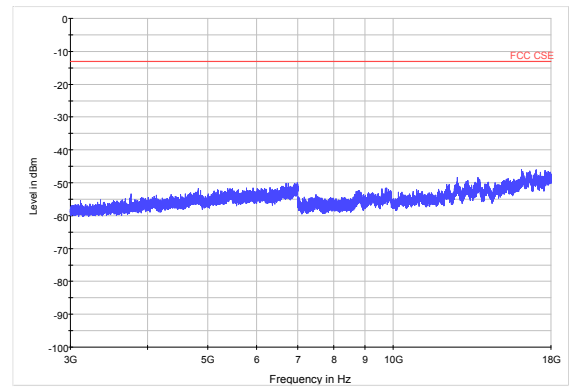

LTE Band 2 3MHz CH-Low 18GHz~20GHz

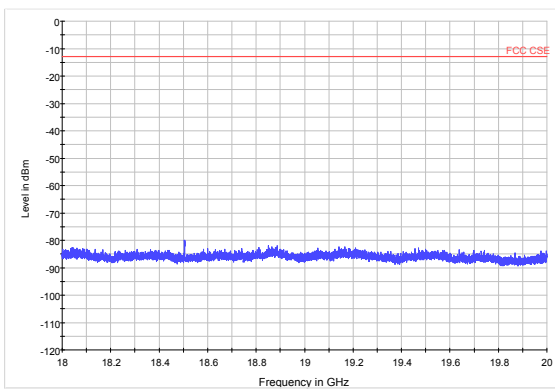

LTE Band 2 3MHz CH-Middle 18GHz~20GHz

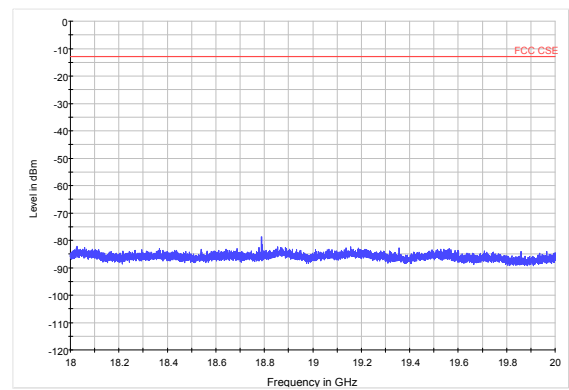



LTE Band 2 3MHz CH-High 30MHz~3GHz

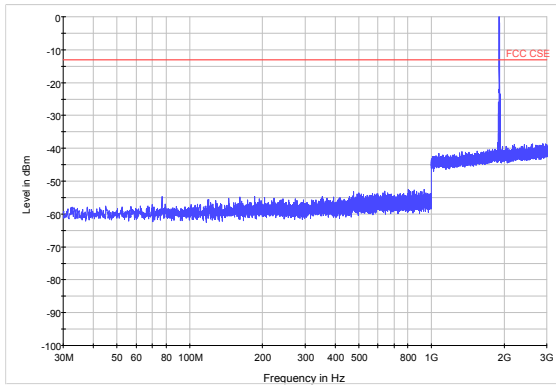

LTE Band 2 5MHz CH-Low 30MHz~3GHz

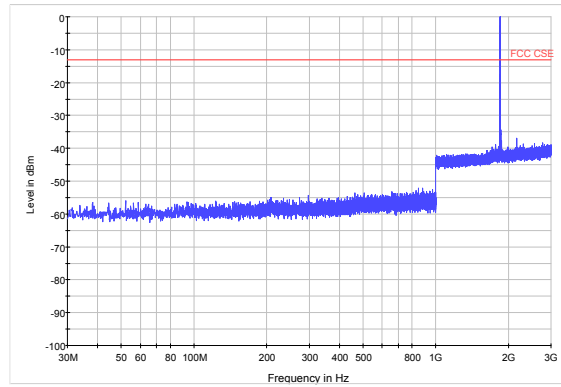

LTE Band 2 3MHz CH-High 3GHz~18GHz

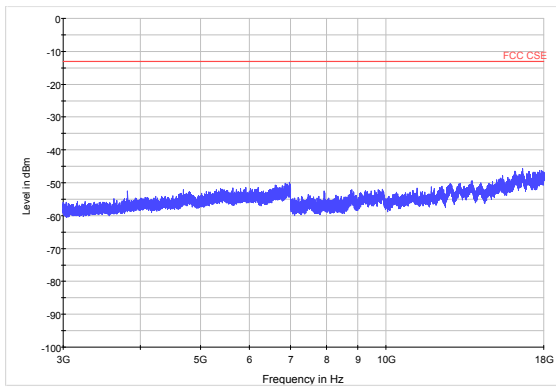

LTE Band 2 5MHz CH-Low 3GHz~18GHz

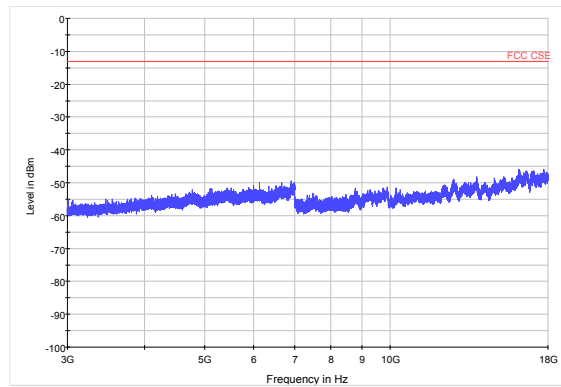

LTE Band 2 3MHz CH-High 18GHz~20GHz

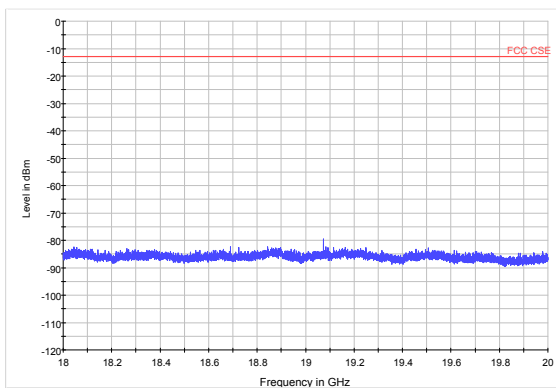

LTE Band 2 5MHz CH-Low 18GHz~20GHz

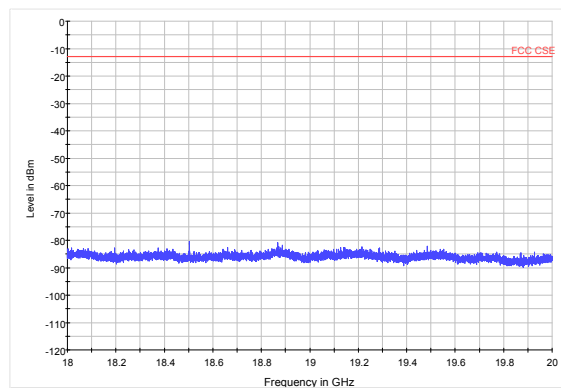



LTE Band 2 5MHz CH-Middle 30MHz~3GHz

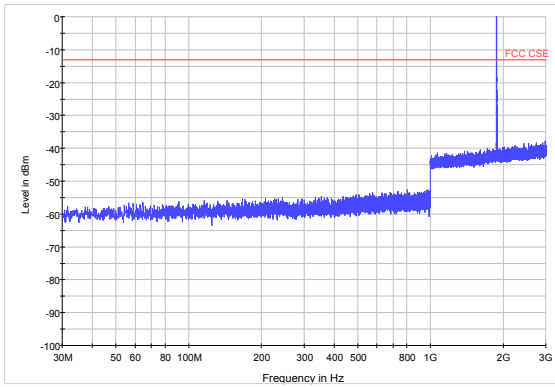

LTE Band 2 5MHz CH-High 30MHz~3GHz

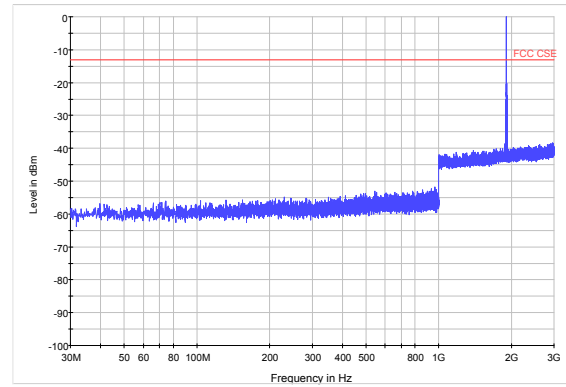

LTE Band 2 5MHz CH-Middle 3GHz~18GHz

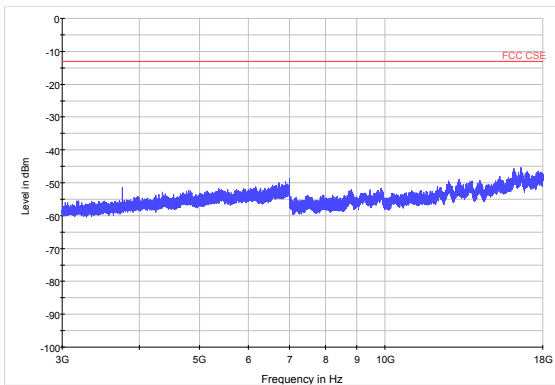

LTE Band 2 5MHz CH-High 3GHz~18GHz

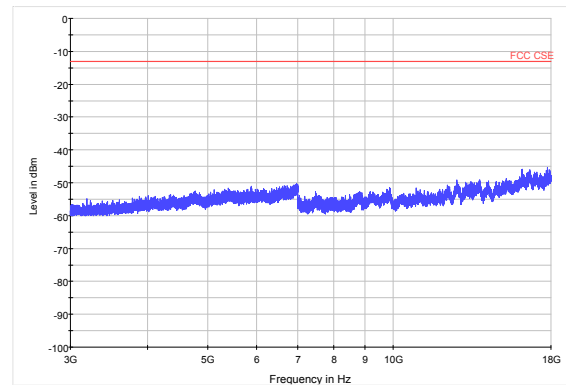

LTE Band 2 5MHz CH-Middle 18GHz~20GHz

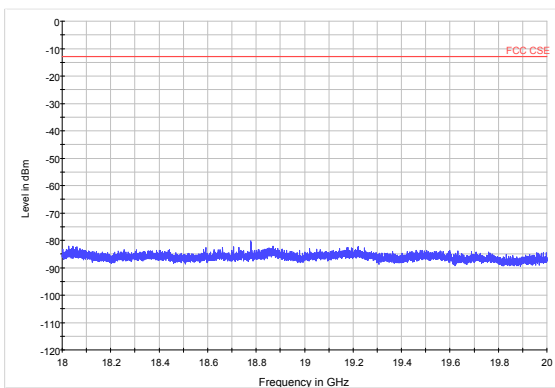

LTE Band 2 5MHz CH-High 18GHz~20GHz

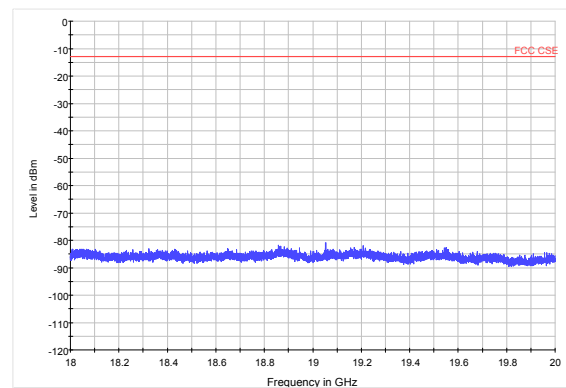



LTE Band 2 10MHz CH-Low 30MHz~3GHz

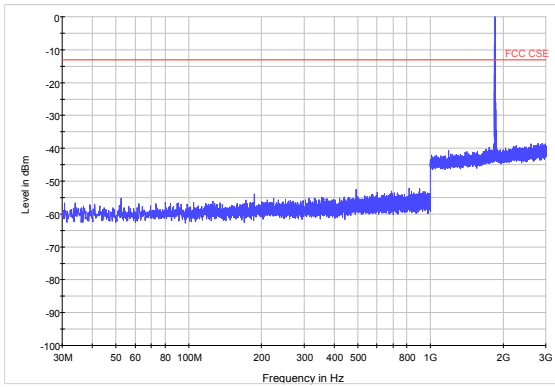

LTE Band 2 10MHz CH-Middle 30MHz~3GHz

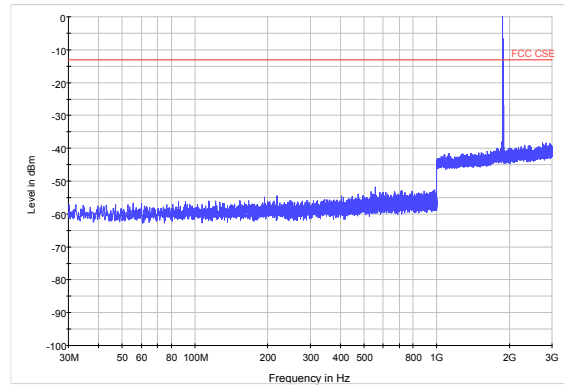

LTE Band 2 10MHz CH-Low 3GHz~18GHz

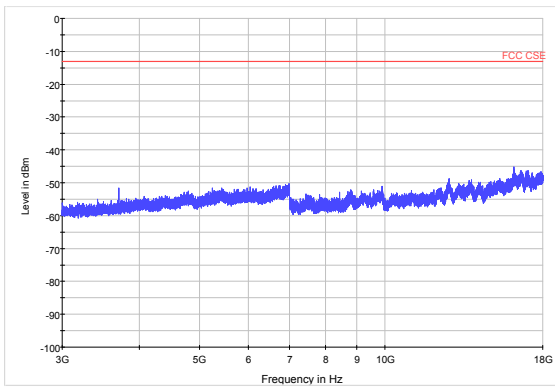

LTE Band 2 10MHz CH-Middle 3GHz~18GHz

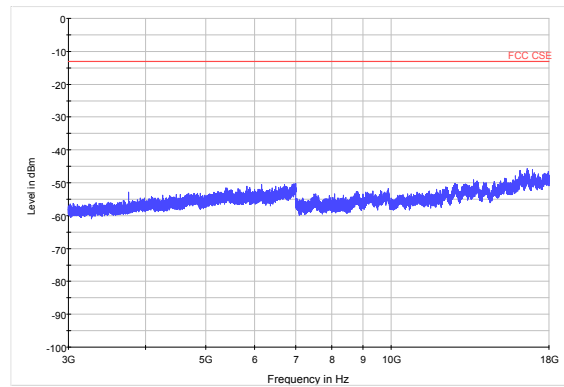

LTE Band 2 10MHz CH-Low 18GHz~20GHz

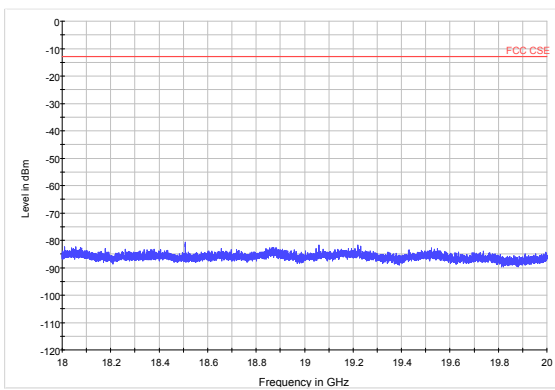

LTE Band 2 10MHz CH-Middle 18GHz~20GHz

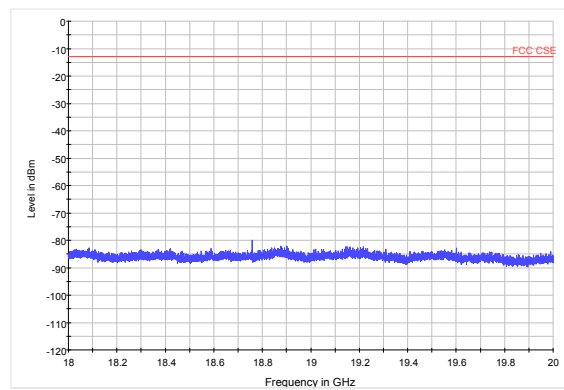



LTE Band 2 10MHz CH-High 30MHz~3GHz

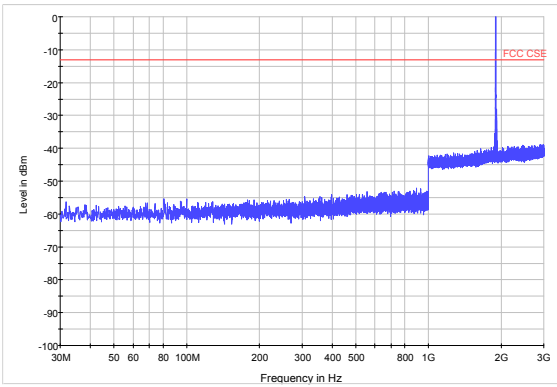

LTE Band 2 15MHz CH-Low 30MHz~3GHz

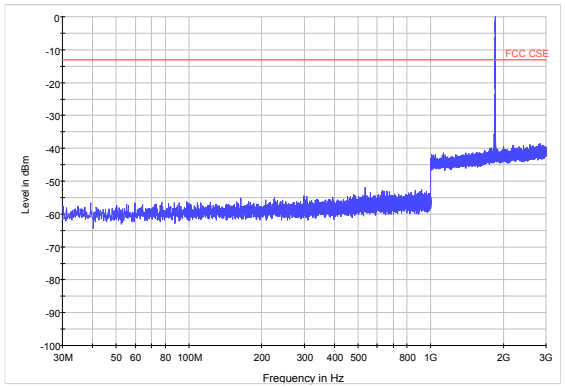

LTE Band 2 10MHz CH-High 3GHz~18GHz

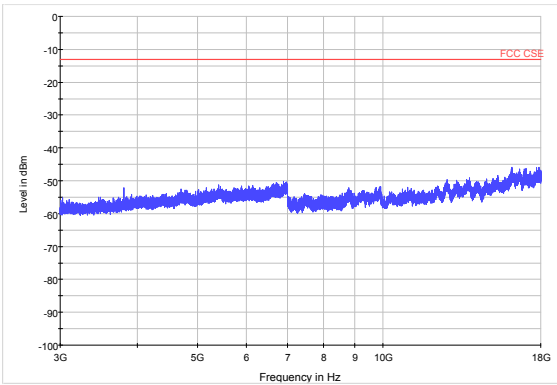

LTE Band 2 15MHz CH-Low 3GHz~18GHz

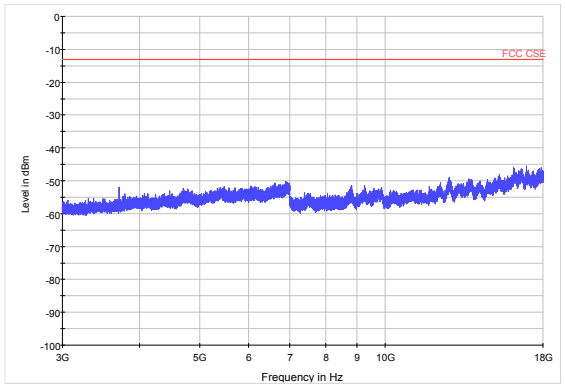

LTE Band 2 10MHz CH-High 18GHz~20GHz

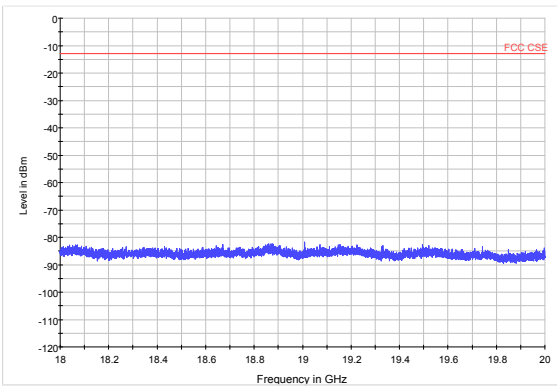

LTE Band 2 15MHz CH-Low 18GHz~20GHz

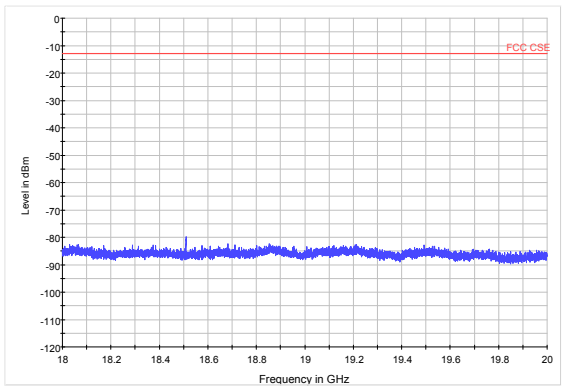





LTE Band 2 15MHz CH-Middle 30MHz~3GHz

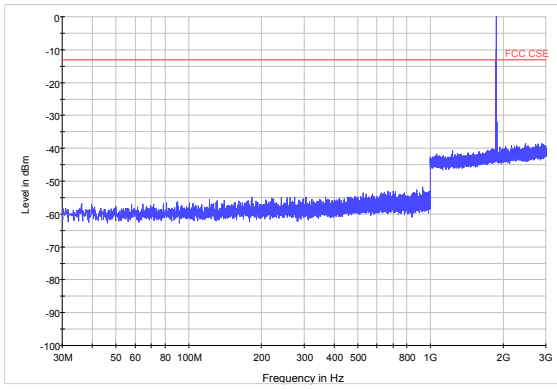

LTE Band 2 15MHz CH-High 30MHz~3GHz

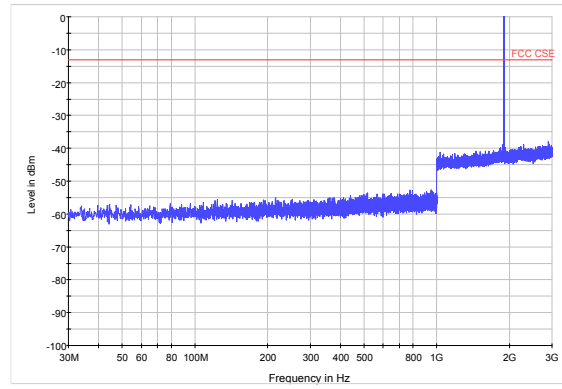

LTE Band 2 15MHz CH-Middle 3GHz~18GHz

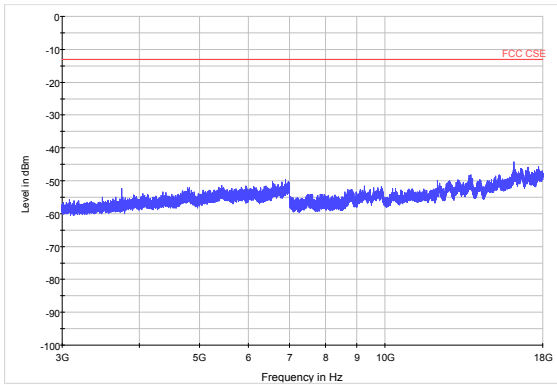

LTE Band 2 15MHz CH-High 3GHz~18GHz

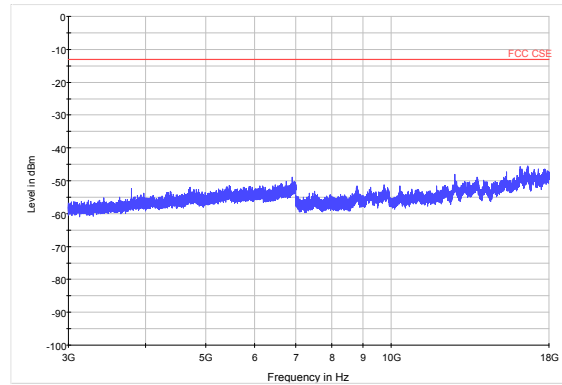

LTE Band 2 15MHz CH-Middle 18GHz~20GHz

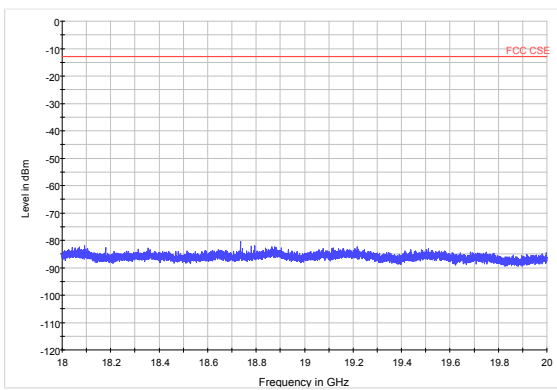

LTE Band 2 15MHz CH-High 18GHz~20GHz

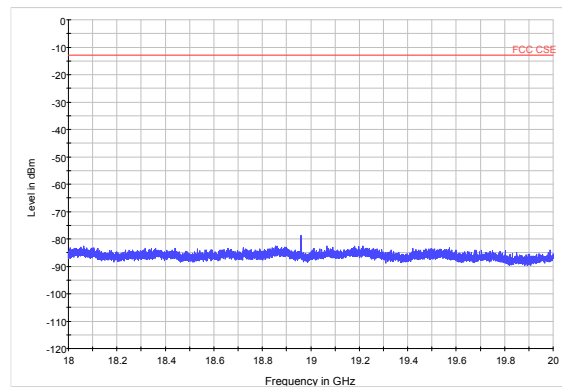



LTE Band 2 20MHz CH-Low 30MHz~3GHz

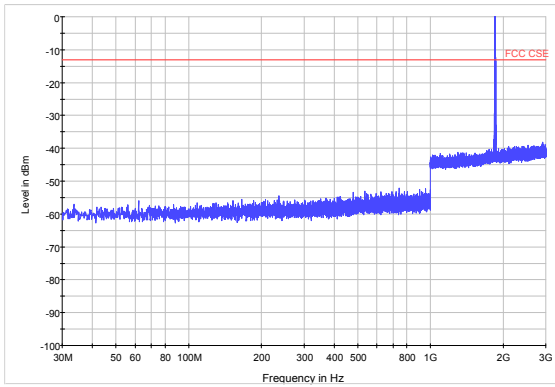

LTE Band 2 20MHz CH-Middle 30MHz~3GHz

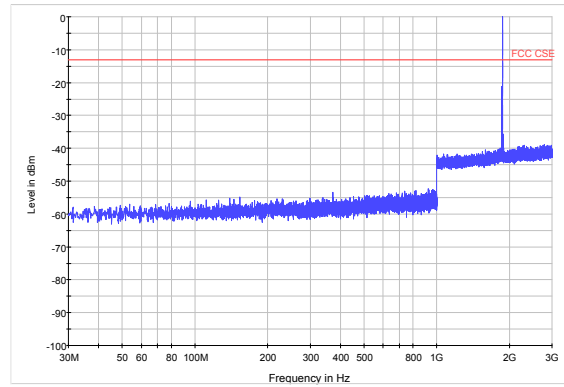

LTE Band 2 20MHz CH-Low 3GHz~18GHz

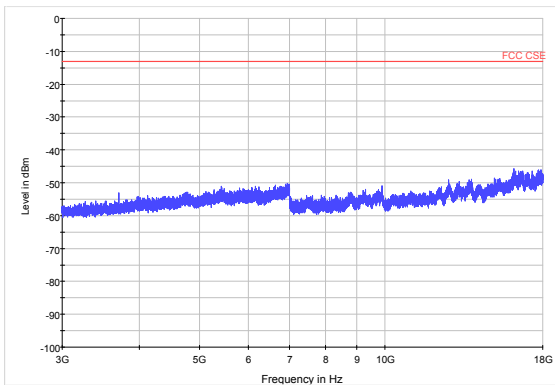

LTE Band 2 20MHz CH-Middle 3GHz~18GHz

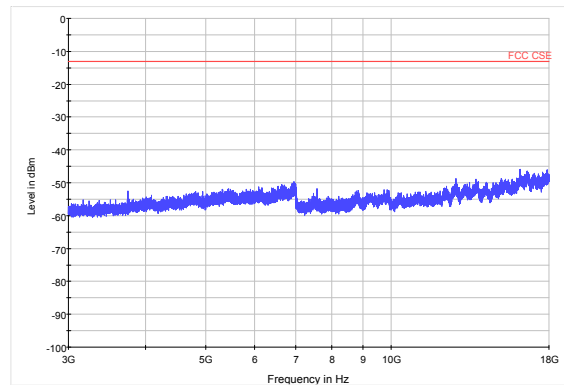

LTE Band 2 20MHz CH-Low 18GHz~20GHz

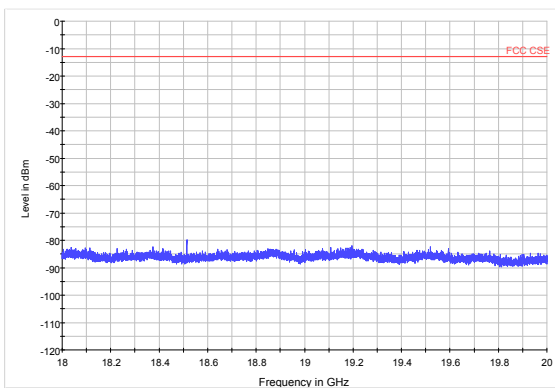

LTE Band 2 20MHz CH-Middle 18GHz~20GHz

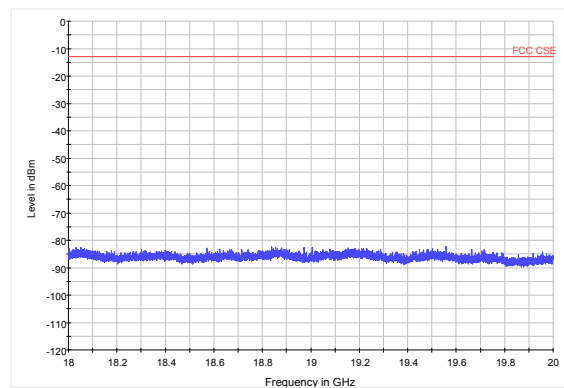



### LTE Band 2 20MHz CH-High 30MHz~3GHz

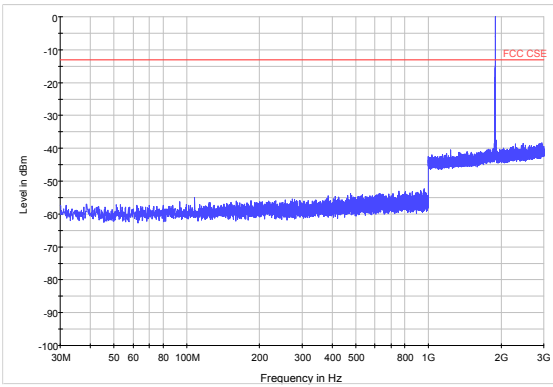

### LTE Band 2 20MHz CH-High 3GHz~18GHz

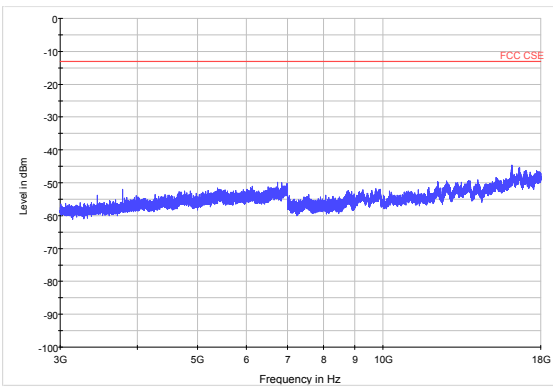

### LTE Band 2 20MHz CH-High 18GHz~20GHz

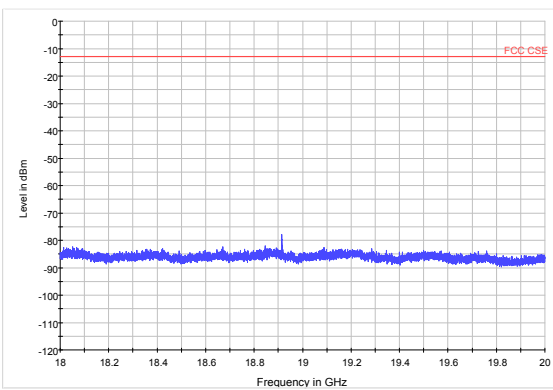

## 5.8. Radiates Spurious Emission

### Ambient condition

Temperature	Relative humidity	Pressure
23°C ~25°C	45%~50%	101.5kPa

### Method of Measurement

1. The testing follows ANSI C63.26 (2015) Section 5.5.2.3.
2. Above 30MHz: The EUT is placed on a turntable 0.8 meters above the ground in the chamber, 3 meter away from the antenna. The maximal emission value is acquired by adjusting the antenna height, polarisation and turntable azimuth. Normally, the height range of antenna is 1 m to 4 m, the azimuth range of turntable is 0° to 360°, and the receive antenna has two polarizations Vertical (V) and Horizontal (H). Above 1GHz: (Note: the FCC's permission to use 1.5m as an alternative per TCBC Conf call of Dec. 2, 2014.) The EUT is placed on a turntable 1.5 meters above the ground in the chamber, 3 meter away from the antenna. The maximal emission value is acquired by adjusting the antenna height, polarisation and turntable azimuth. Normally, the height range of antenna is 1 m to 4 m, the azimuth range of turntable is 0° to 360°, and the receive antenna has two polarizations Vertical (V) and Horizontal (H).
3. A log-periodic antenna or double-ridged waveguide horn antenna shall be substituted in place of the EUT. The log-periodic antenna will be driven by a signal generator and the level will be adjusted till the same power value on the spectrum analyzer or receiver. The level of the spurious emissions can be calculated through the level of the signal generator, cable loss, the gain of the substitution antenna and the reading of the spectrum analyzer or receiver.
4. The EUT is then put into continuously transmitting mode at its maximum power level during the test. Set Test Receiver or Spectrum RBW=1MHz, VBW=3MHz, And the maximum value of the receiver should be recorded as (Pr).
5. The EUT shall be replaced by a substitution antenna. In the chamber, an substitution antenna for the frequency band of interest is placed at the reference point of the chamber. An RF Signal source for the frequency band of interest is connected to the substitution antenna with a cable that has been constructed to not interfere with the radiation pattern of the antenna. A power (PMea) is applied to the input of the substitution antenna, and adjust the level of the signal generator output until the value of the receiver reach the previously recorded (Pr). The power of signal source (PMea) is recorded. The test should be performed by rotating the test item and adjusting the receiving antenna polarization.
6. A amplifier should be connected to the Signal Source output port. And the cable should be connect between the Amplifier and the Substitution Antenna. The cable loss (Pcl), the Substitution Antenna Gain (Ga) and the Amplifier Gain (PAg) should be recorded after test.
7. The measurement results are obtained as described below:  
$$\text{Power(EIRP)} = \text{PMea} - \text{PAg} - \text{Pcl} + \text{Ga}$$
The measurement results are amend as described below:  
$$\text{Power(EIRP)} = \text{PMea} - \text{Pcl} + \text{Ga}$$
8. This value is EIRP since the measurement is calibrated using an antenna of known gain (2.15 dBi) and known input power. ERP can be calculated from EIRP by subtracting the gain of the dipole, ERP

= EIRP-2.15dBi.

**Test setup**

**30MHz~~~ 1GHz**

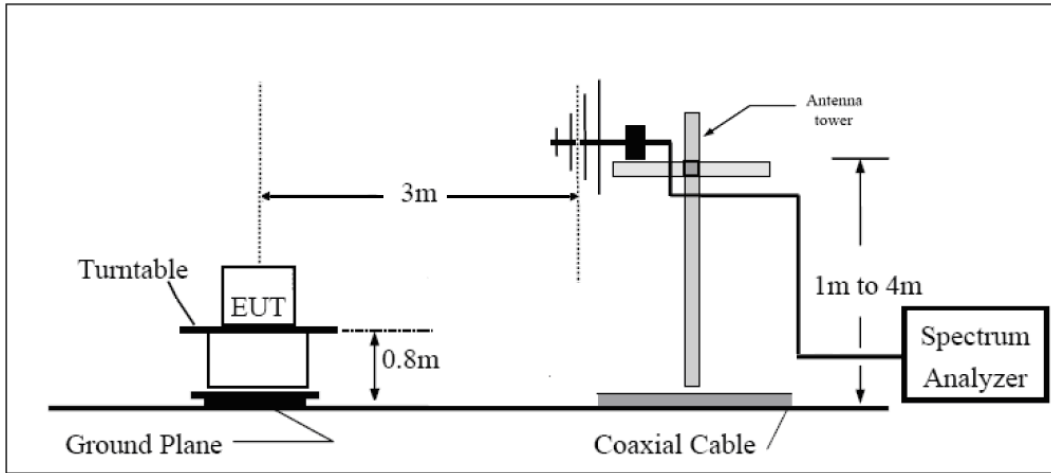

**Above 1GHz**

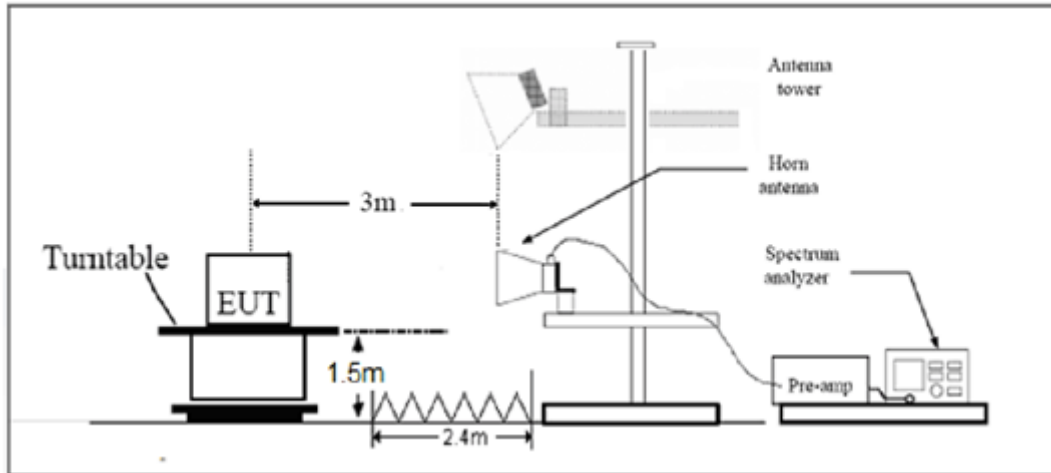

Note: Area side: 2.4mX3.6m

The radiated emission was measured in the following position: EUT lie-down position (Z axis), stand-up position (X, Y axis). The worst emission was found in lie-down position (Z axis) and the worst case was recorded.

**Limits**

Rule Part 24.238(a) specifies that “on any frequency outside a licensee’s frequency block, the power of any emission shall be attenuated below the transmitter power (P) by at least 43 + 10 log<sub>10</sub> (P) dB.”

Limit	-13 dBm
-------	---------

**Measurement Uncertainty**

The assessed measurement uncertainty to ensure 95% confidence level for the normal distribution is with the coverage factor  $k = 1.96$ ,  $U = 3.55$  dB.

**Test Result**

## GSM 1900 CH-Low

Harmonic	Frequency (MHz)	SG (dBm)	Cable Loss (dB)	Gain (dBi)	Antenna Polarization	EIRP Level (dBm)	Limit (dBm)	Margin (dB)	Azimuth (deg)
2	3700	-53.75	5.1	11.05	vertical	-47.8	-13.0	34.83	135
3	5551	-53.93	5.42	12.65	vertical	-46.7	-13.0	33.74	45
4	7401	-49.75	6.7	13.85	vertical	-42.6	-13.0	29.60	180
5	9251	-48.94	7.01	14.75	vertical	-41.2	-13.0	28.24	270
6	11101	-46.07	7.48	15.95	vertical	-37.6	-13.0	24.63	135
7	12951	-45.64	7.51	16.55	vertical	-36.6	-13.0	23.56	45
8	14802	-43.31	8.24	15.35	vertical	-36.2	-13.0	23.23	270
9	16652	-40.64	8.41	14.95	vertical	-34.1	-13.0	21.13	180
10	18502	-40.31	8.54	15.45	vertical	-33.4	-13.0	20.37	270

Note: 1.The other Spurious RF Radiated emissions level is no more than noise floor.  
2.The worst emission was found in the antenna is vertical position.

## GSM 1900 CH-Middle

Harmonic	Frequency (MHz)	SG (dBm)	Cable Loss (dB)	Gain (dBi)	Antenna Polarization	EIRP Level (dBm)	Limit (dBm)	Margin (dB)	Azimuth (deg)
2	3760	-53.25	5.1	11.05	vertical	-47.3	-13.0	34.29	135
3	5640	-53.43	5.42	12.65	vertical	-46.2	-13.0	33.24	45
4	7520	-49.25	6.7	13.85	vertical	-42.1	-13.0	29.10	180
5	9400	-47.94	7.01	14.75	vertical	-40.2	-13.0	27.24	270
6	11280	-45.47	7.48	15.95	vertical	-37.0	-13.0	24.03	135
7	13160	-45.34	7.51	16.55	vertical	-36.3	-13.0	23.34	45
8	15040	-43.11	8.24	15.35	vertical	-36.0	-13.0	23.04	270
9	16920	-40.64	8.41	14.95	vertical	-34.1	-13.0	21.13	180
10	18800	-40.21	8.54	15.45	vertical	-33.3	-13.0	20.26	270

Note: 1.The other Spurious RF Radiated emissions level is no more than noise floor.  
2. The worst emission was found in the antenna is vertical position.



## GSM 1900 CH-High

Harmonic	Frequency (MHz)	SG (dBm)	Cable Loss (dB)	Gain (dBi)	Antenna Polarization	EIRP Level (dBm)	Limit (dBm)	Margin (dB)	Azimuth (deg)
2	3819	-53.15	5.1	11.05	vertical	-47.2	-13.0	34.19	135
3	5730	-52.43	5.42	12.65	vertical	-45.2	-13.0	32.24	45
4	7639	-49.25	6.7	13.85	vertical	-42.1	-13.0	29.10	180
5	9549	-47.94	7.01	14.75	vertical	-40.2	-13.0	27.24	270
6	11459	-45.47	7.48	15.95	vertical	-37.0	-13.0	24.03	135
7	13369	-45.24	7.51	16.55	vertical	-36.2	-13.0	23.17	45
8	15278	-42.81	8.24	15.35	vertical	-35.7	-13.0	22.74	180
9	17188	-40.64	8.41	14.95	vertical	-34.1	-13.0	21.13	225
10	19098	-40.61	8.54	15.45	vertical	-33.7	-13.0	20.65	135

Note: 1. The other Spurious RF Radiated emissions level is no more than noise floor.  
2. The worst emission was found in the antenna is vertical position.



LTE Band 2 1.4MHz CH-Low

Harmonic	Frequency (MHz)	SG (dBm)	Cable Loss (dB)	Gain (dBi)	Antenna Polarization	EIRP Level (dBm)	Limit (dBm)	Margin (dB)	Azimuth (deg)
2	3701	-53.45	5.1	11.05	vertical	-47.5	-13.0	34.5	45
3	5552	-47.73	5.42	12.65	vertical	-40.5	-13.0	27.5	45
4	7403	-50.25	6.7	13.85	vertical	-43.1	-13.0	30.1	45
5	9254	-48.84	7.01	14.75	vertical	-41.1	-13.0	28.1	90
6	11104	-47.47	7.48	15.95	vertical	-39.0	-13.0	26.0	90
7	12955	-47.54	7.51	16.55	vertical	-38.5	-13.0	25.5	90
8	14806	-43.11	8.24	15.35	vertical	-36.0	-13.0	23.0	45
9	16656	-43.74	8.41	14.95	vertical	-37.2	-13.0	24.2	180
10	18507	-43.71	8.54	15.45	vertical	-36.8	-13.0	23.8	225

Note: 1.The other Spurious RF Radiated emissions level is no more than noise floor.  
 2.The worst emission was found in the antenna is vertical position.

LTE Band 2 1.4MHz CH-Middle

Harmonic	Frequency (MHz)	SG (dBm)	Cable Loss (dB)	Gain (dBi)	Antenna Polarization	EIRP Level (dBm)	Limit (dBm)	Margin (dB)	Azimuth (deg)
2	3760	-64.15	5.10	11.05	vertical	-58.2	-13.0	45.2	135
3	5640	-55.83	5.42	12.65	vertical	-48.6	-13.0	35.6	90
4	7520	-47.95	6.70	13.85	vertical	-40.8	-13.0	27.8	45
5	9400	-49.54	7.01	14.75	vertical	-41.8	-13.0	28.8	135
6	11280	-45.67	7.48	15.95	vertical	-37.2	-13.0	24.2	225
7	13160	-49.24	7.51	16.55	vertical	-40.2	-13.0	27.2	45
8	15040	-45.51	8.24	15.35	vertical	-38.4	-13.0	25.4	90
9	16920	-43.34	8.41	14.95	vertical	-36.8	-13.0	23.8	90
10	18800	-43.71	8.54	15.45	vertical	-36.8	-13.0	23.8	45

Note: 1.The other Spurious RF Radiated emissions level is no more than noise floor.  
 2.The worst emission was found in the antenna is vertical position.

LTE Band 2 1.4MHz CH-High

Harmonic	Frequency (MHz)	SG (dBm)	Cable Loss (dB)	Gain (dBi)	Antenna Polarization	EIRP Level (dBm)	Limit (dBm)	Margin (dB)	Azimuth (deg)
2	3819	-56.25	5.10	11.05	vertical	-50.3	-13.0	37.3	45
3	5728	-56.03	5.42	12.65	vertical	-48.8	-13.0	35.8	90
4	7637	-51.85	6.70	13.85	vertical	-44.7	-13.0	31.7	90
5	9547	-51.14	7.01	14.75	vertical	-43.4	-13.0	30.4	135
6	11456	-46.97	7.48	15.95	vertical	-38.5	-13.0	25.5	225
7	13365	-46.94	7.51	16.55	vertical	-37.9	-13.0	24.9	90
8	15274	-46.31	8.24	15.35	vertical	-39.2	-13.0	26.2	45
9	17184	-44.74	8.41	14.95	vertical	-38.2	-13.0	25.2	90
10	19093	-43.01	8.54	15.45	vertical	-36.1	-13.0	23.1	225

Note: 1.The other Spurious RF Radiated emissions level is no more than noise floor.  
 2.The worst emission was found in the antenna is vertical position.

LTE Band 2 3MHz CH-Low

Harmonic	Frequency (MHz)	SG (dBm)	Cable Loss (dB)	Gain (dBi)	Antenna Polarization	EIRP Level (dBm)	Limit (dBm)	Margin (dB)	Azimuth (deg)
2	3703	-54.45	5.10	11.05	vertical	-48.5	-13.0	35.5	45
3	5555	-56.03	5.42	12.65	vertical	-48.8	-13.0	35.8	90
4	7406	-50.05	6.70	13.85	vertical	-42.9	-13.0	29.9	90
5	9258	-47.74	7.01	14.75	vertical	-40.0	-13.0	27.0	90
6	11109	-48.27	7.48	15.95	vertical	-39.8	-13.0	26.8	45
7	12961	-47.04	7.51	16.55	vertical	-38.0	-13.0	25.0	180
8	14812	-43.21	8.24	15.35	vertical	-36.1	-13.0	23.1	225
9	16664	-44.74	8.41	14.95	vertical	-38.2	-13.0	25.2	135
10	18515	-43.41	8.54	15.45	vertical	-36.5	-13.0	23.5	225

Note: 1.The other Spurious RF Radiated emissions level is no more than noise floor.  
 2.The worst emission was found in the antenna is vertical position.



## LTE Band 2 3MHz CH-Middle

Harmonic	Frequency (MHz)	SG (dBm)	Cable Loss (dB)	Gain (dBi)	Antenna Polarization	EIRP Level (dBm)	Limit (dBm)	Margin (dB)	Azimuth (deg)
2	3760	-54.85	5.10	11.05	vertical	-48.9	-13.0	35.9	90
3	5640	-53.03	5.42	12.65	vertical	-45.8	-13.0	32.8	90
4	7520	-48.25	6.70	13.85	vertical	-41.1	-13.0	28.1	45
5	9400	-46.64	7.01	14.75	vertical	-38.9	-13.0	25.9	180
6	11280	-45.07	7.48	15.95	vertical	-36.6	-13.0	23.6	45
7	13160	-47.74	7.51	16.55	vertical	-38.7	-13.0	25.7	0
8	15040	-43.41	8.24	15.35	vertical	-36.3	-13.0	23.3	135
9	16920	-41.14	8.41	14.95	vertical	-34.6	-13.0	21.6	225
10	18800	-42.41	8.54	15.45	vertical	-35.5	-13.0	22.5	90

Note: 1.The other Spurious RF Radiated emissions level is no more than noise floor.  
2.The worst emission was found in the antenna is vertical position.

## LTE Band 2 3MHz CH-High

Harmonic	Frequency (MHz)	SG (dBm)	Cable Loss (dB)	Gain (dBi)	Antenna Polarization	EIRP Level (dBm)	Limit (dBm)	Margin (dB)	Azimuth (deg)
2	3817	-56.45	5.10	11.05	vertical	-50.5	-13.0	37.5	45
3	5726	-56.03	5.42	12.65	vertical	-48.8	-13.0	35.8	90
4	7634	-48.05	6.70	13.85	vertical	-40.9	-13.0	27.9	225
5	9543	-49.94	7.01	14.75	vertical	-42.2	-13.0	29.2	45
6	11451	-44.47	7.48	15.95	vertical	-36.0	-13.0	23.0	90
7	13360	-45.04	7.51	16.55	vertical	-36.0	-13.0	23.0	90
8	15268	-44.41	8.24	15.35	vertical	-37.3	-13.0	24.3	90
9	17177	-42.84	8.41	14.95	vertical	-36.3	-13.0	23.3	45
10	19085	-44.21	8.54	15.45	vertical	-37.3	-13.0	24.3	180

Note: 1.The other Spurious RF Radiated emissions level is no more than noise floor.  
2.The worst emission was found in the antenna is vertical position.



## LTE Band 2 5MHz CH-Low

Harmonic	Frequency (MHz)	SG (dBm)	Cable Loss (dB)	Gain (dBi)	Antenna Polarization	EIRP Level (dBm)	Limit (dBm)	Margin (dB)	Azimuth (deg)
2	3705	-54.65	5.10	11.05	vertical	-48.7	-13.0	35.7	225
3	5558	-53.33	5.42	12.65	vertical	-46.1	-13.0	33.1	135
4	7410	-49.55	6.70	13.85	vertical	-42.4	-13.0	29.4	225
5	9263	-49.24	7.01	14.75	vertical	-41.5	-13.0	28.5	225
6	11115	-46.57	7.48	15.95	vertical	-38.1	-13.0	25.1	315
7	12968	-45.44	7.51	16.55	vertical	-36.4	-13.0	23.4	270
8	14820	-41.71	8.24	15.35	vertical	-34.6	-13.0	21.6	225
9	16673	-42.74	8.41	14.95	vertical	-36.2	-13.0	23.2	135
10	18525	-41.01	8.54	15.45	vertical	-34.1	-13.0	21.1	225

Note: 1.The other Spurious RF Radiated emissions level is no more than noise floor.  
2.The worst emission was found in the antenna is vertical position.

## LTE Band 2 5MHz CH-Middle

Harmonic	Frequency (MHz)	SG (dBm)	Cable Loss (dB)	Gain (dBi)	Antenna Polarization	EIRP Level (dBm)	Limit (dBm)	Margin (dB)	Azimuth (deg)
2	3760	-55.95	5.10	11.05	vertical	-50.0	-13.0	37.0	225
3	5640	-52.53	5.42	12.65	vertical	-45.3	-13.0	32.3	0
4	7520	-48.65	6.70	13.85	vertical	-41.5	-13.0	28.5	135
5	9400	-47.74	7.01	14.75	vertical	-40.0	-13.0	27.0	225
6	11280	-45.17	7.48	15.95	vertical	-36.7	-13.0	23.7	315
7	13160	-45.74	7.51	16.55	vertical	-36.7	-13.0	23.7	270
8	15040	-43.81	8.24	15.35	vertical	-36.7	-13.0	23.7	225
9	16920	-41.44	8.41	14.95	vertical	-34.9	-13.0	21.9	135
10	18800	-41.61	8.54	15.45	vertical	-34.7	-13.0	21.7	135

Note: 1.The other Spurious RF Radiated emissions level is no more than noise floor.  
2.The worst emission was found in the antenna is vertical position.

LTE Band 2 5MHz CH-High

Harmonic	Frequency (MHz)	SG (dBm)	Cable Loss (dB)	Gain (dBi)	Antenna Polarization	EIRP Level (dBm)	Limit (dBm)	Margin (dB)	Azimuth (deg)
2	3815	-56.35	5.10	11.05	vertical	-50.4	-13.0	37.4	45
3	5723	-56.03	5.42	12.65	vertical	-48.8	-13.0	35.8	90
4	7630	-48.75	6.70	13.85	vertical	-41.6	-13.0	28.6	90
5	9538	-50.14	7.01	14.75	vertical	-42.4	-13.0	29.4	90
6	11445	-44.97	7.48	15.95	vertical	-36.5	-13.0	23.5	45
7	13353	-45.24	7.51	16.55	vertical	-36.2	-13.0	23.2	180
8	15260	-43.71	8.24	15.35	vertical	-36.6	-13.0	23.6	225
9	17168	-41.14	8.41	14.95	vertical	-34.6	-13.0	21.6	135
10	19075	-41.41	8.54	15.45	vertical	-34.5	-13.0	21.5	225

Note: 1.The other Spurious RF Radiated emissions level is no more than noise floor.  
 2.The worst emission was found in the antenna is vertical position.

LTE Band 2 10MHz CH-Low

Harmonic	Frequency (MHz)	SG (dBm)	Cable Loss (dB)	Gain (dBi)	Antenna Polarization	EIRP Level (dBm)	Limit (dBm)	Margin (dB)	Azimuth (deg)
2	3710	-55.75	5.10	11.05	vertical	-49.8	-13.0	36.8	225
3	5565	-56.03	5.42	12.65	vertical	-48.8	-13.0	35.8	315
4	7420	-48.45	6.70	13.85	vertical	-41.3	-13.0	28.3	270
5	9275	-47.54	7.01	14.75	vertical	-39.8	-13.0	26.8	225
6	11130	-48.07	7.48	15.95	vertical	-39.6	-13.0	26.6	135
7	12985	-46.54	7.51	16.55	vertical	-37.5	-13.0	24.5	225
8	14840	-41.91	8.24	15.35	vertical	-34.8	-13.0	21.8	90
9	16695	-41.24	8.41	14.95	vertical	-34.7	-13.0	21.7	90
10	18550	-41.31	8.54	15.45	vertical	-34.4	-13.0	21.4	45

Note: 1.The other Spurious RF Radiated emissions level is no more than noise floor.  
 2.The worst emission was found in the antenna is vertical position.



## LTE Band 2 10MHz CH-Middle

Harmonic	Frequency (MHz)	SG (dBm)	Cable Loss (dB)	Gain (dBi)	Antenna Polarization	EIRP Level (dBm)	Limit (dBm)	Margin (dB)	Azimuth (deg)
2	3760	-54.65	5.10	11.05	vertical	-48.7	-13.0	35.7	180
3	5640	-53.03	5.42	12.65	vertical	-45.8	-13.0	32.8	225
4	7520	-48.15	6.70	13.85	vertical	-41.0	-13.0	28.0	135
5	9400	-47.74	7.01	14.75	vertical	-40.0	-13.0	27.0	225
6	11280	-44.57	7.48	15.95	vertical	-36.1	-13.0	23.1	0
7	13160	-46.74	7.51	16.55	vertical	-37.7	-13.0	24.7	90
8	15040	-44.01	8.24	15.35	vertical	-36.9	-13.0	23.9	90
9	16920	-42.64	8.41	14.95	vertical	-36.1	-13.0	23.1	45
10	18800	-42.21	8.54	15.45	vertical	-35.3	-13.0	22.3	180

Note: 1.The other Spurious RF Radiated emissions level is no more than noise floor.  
2.The worst emission was found in the antenna is vertical position.

## LTE Band 2 10MHz CH-High

Harmonic	Frequency (MHz)	SG (dBm)	Cable Loss (dB)	Gain (dBi)	Antenna Polarization	EIRP Level (dBm)	Limit (dBm)	Margin (dB)	Azimuth (deg)
2	3810	-55.85	5.10	11.05	vertical	-49.9	-13.0	36.9	45
3	5715	-55.63	5.42	12.65	vertical	-48.4	-13.0	35.4	0
4	7620	-49.85	6.70	13.85	vertical	-42.7	-13.0	29.7	135
5	9525	-49.34	7.01	14.75	vertical	-41.6	-13.0	28.6	225
6	11430	-44.47	7.48	15.95	vertical	-36.0	-13.0	23.0	45
7	13335	-45.94	7.51	16.55	vertical	-36.9	-13.0	23.9	315
8	15240	-43.51	8.24	15.35	vertical	-36.4	-13.0	23.4	270
9	17145	-40.54	8.41	14.95	vertical	-34.0	-13.0	21.0	225
10	19050	-42.11	8.54	15.45	vertical	-35.2	-13.0	22.2	135

Note: 1.The other Spurious RF Radiated emissions level is no more than noise floor.  
2.The worst emission was found in the antenna is vertical position.

LTE Band 2 15MHz CH-Low

Harmonic	Frequency (MHz)	SG (dBm)	Cable Loss (dB)	Gain (dBi)	Antenna Polarization	EIRP Level (dBm)	Limit (dBm)	Margin (dB)	Azimuth (deg)
2	3715.0	-56.95	5.10	11.05	vertical	-51.0	-13.0	38.0	45
3	5572.5	-53.03	5.42	12.65	vertical	-45.8	-13.0	32.8	180
4	7430.0	-49.55	6.70	13.85	vertical	-42.4	-13.0	29.4	225
5	9287.5	-47.04	7.01	14.75	vertical	-39.3	-13.0	26.3	135
6	11145.0	-45.07	7.48	15.95	vertical	-36.6	-13.0	23.6	225
7	13002.5	-45.94	7.51	16.55	vertical	-36.9	-13.0	23.9	90
8	14860.0	-42.21	8.24	15.35	vertical	-35.1	-13.0	22.1	90
9	16717.5	-41.94	8.41	14.95	vertical	-35.4	-13.0	22.4	135
10	18575.0	-41.41	8.54	15.45	vertical	-34.5	-13.0	21.5	45

Note: 1.The other Spurious RF Radiated emissions level is no more than noise floor.  
 2.The worst emission was found in the antenna is vertical position.

LTE Band 2 15MHz CH-Middle

Harmonic	Frequency (MHz)	SG (dBm)	Cable Loss (dB)	Gain (dBi)	Antenna Polarization	EIRP Level (dBm)	Limit (dBm)	Margin (dB)	Azimuth (deg)
2	3760.0	-52.85	5.10	11.05	vertical	-46.9	-13.0	33.9	180
3	5640.0	-55.73	5.42	12.65	vertical	-48.5	-13.0	35.5	45
4	7520.0	-48.75	6.70	13.85	vertical	-41.6	-13.0	28.6	0
5	9400.0	-47.54	7.01	14.75	vertical	-39.8	-13.0	26.8	135
6	11280.0	-44.87	7.48	15.95	vertical	-36.4	-13.0	23.4	225
7	13160.0	-48.34	7.51	16.55	vertical	-39.3	-13.0	26.3	315
8	15040.0	-43.81	8.24	15.35	vertical	-36.7	-13.0	23.7	270
9	16920.0	-41.74	8.41	14.95	vertical	-35.2	-13.0	22.2	225
10	18800.0	-41.01	8.54	15.45	vertical	-34.1	-13.0	21.1	135

Note: 1.The other Spurious RF Radiated emissions level is no more than noise floor.  
 2.The worst emission was found in the antenna is vertical position.

LTE Band 2 15MHz CH-High

Harmonic	Frequency (MHz)	SG (dBm)	Cable Loss (dB)	Gain (dBi)	Antenna Polarization	EIRP Level (dBm)	Limit (dBm)	Margin (dB)	Azimuth (deg)
2	3805.0	-52.35	5.10	11.05	vertical	-46.4	-13.0	33.4	225
3	5707.5	-53.73	5.42	12.65	vertical	-46.5	-13.0	33.5	0
4	7610.0	-48.55	6.70	13.85	vertical	-41.4	-13.0	28.4	135
5	9512.5	-49.54	7.01	14.75	vertical	-41.8	-13.0	28.8	225
6	11415.0	-45.47	7.48	15.95	vertical	-37.0	-13.0	24.0	315
7	13317.5	-46.04	7.51	16.55	vertical	-37.0	-13.0	24.0	270
8	15220.0	-43.81	8.24	15.35	vertical	-36.7	-13.0	23.7	225
9	17122.5	-42.04	8.41	14.95	vertical	-35.5	-13.0	22.5	225
10	19025.0	-41.61	8.54	15.45	vertical	-34.7	-13.0	21.7	135

Note: 1.The other Spurious RF Radiated emissions level is no more than noise floor.  
 2.The worst emission was found in the antenna is vertical position.

LTE Band 2 20MHz CH-Low

Harmonic	Frequency (MHz)	SG (dBm)	Cable Loss (dB)	Gain (dBi)	Antenna Polarization	EIRP Level (dBm)	Limit (dBm)	Margin (dB)	Azimuth (deg)
2	3720.0	-55.25	5.10	11.05	vertical	-49.3	-13.0	36.3	90
3	5580.0	-56.03	5.42	12.65	vertical	-48.8	-13.0	35.8	225
4	7440.0	-48.15	6.70	13.85	vertical	-41.0	-13.0	28.0	45
5	9300.0	-46.44	7.01	14.75	vertical	-38.7	-13.0	25.7	135
6	11160.0	-46.57	7.48	15.95	vertical	-38.1	-13.0	25.1	45
7	13020.0	-45.14	7.51	16.55	vertical	-36.1	-13.0	23.1	90
8	14880.0	-41.11	8.24	15.35	vertical	-34.0	-13.0	21.0	225
9	16740.0	-41.94	8.41	14.95	vertical	-35.4	-13.0	22.4	45
10	18600.0	-41.41	8.54	15.45	vertical	-34.5	-13.0	21.5	90

Note: 1.The other Spurious RF Radiated emissions level is no more than noise floor.  
 2.The worst emission was found in the antenna is vertical position.



LTE Band 2 20MHz CH-Middle

Harmonic	Frequency (MHz)	SG (dBm)	Cable Loss (dB)	Gain (dBi)	Antenna Polarization	EIRP Level (dBm)	Limit (dBm)	Margin (dB)	Azimuth (deg)
2	3760.0	-55.25	5.10	11.05	vertical	-49.3	-13.0	36.3	135
3	5640.0	-55.43	5.42	12.65	vertical	-48.2	-13.0	35.2	270
4	7520.0	-49.85	6.70	13.85	vertical	-42.7	-13.0	29.7	225
5	9400.0	-48.74	7.01	14.75	vertical	-41.0	-13.0	28.0	225
6	11280.0	-46.17	7.48	15.95	vertical	-37.7	-13.0	24.7	135
7	13160.0	-46.24	7.51	16.55	vertical	-37.2	-13.0	24.2	90
8	15040.0	-42.31	8.24	15.35	vertical	-35.2	-13.0	22.2	225
9	16920.0	-40.24	8.41	14.95	vertical	-33.7	-13.0	20.7	45
10	18800.0	-40.21	8.54	15.45	vertical	-33.3	-13.0	20.3	135

Note: 1.The other Spurious RF Radiated emissions level is no more than noise floor.  
 2.The worst emission was found in the antenna is vertical position.

LTE Band 2 20MHz CH-High

Harmonic	Frequency (MHz)	SG (dBm)	Cable Loss (dB)	Gain (dBi)	Antenna Polarization	EIRP Level (dBm)	Limit (dBm)	Margin (dB)	Azimuth (deg)
2	3800.0	-55.15	5.10	11.05	vertical	-49.2	-13.0	36.2	45
3	5700.0	-55.93	5.42	12.65	vertical	-48.7	-13.0	35.7	180
4	7600.0	-48.45	6.70	13.85	vertical	-41.3	-13.0	28.3	225
5	9500.0	-49.24	7.01	14.75	vertical	-41.5	-13.0	28.5	135
6	11400.0	-44.47	7.48	15.95	vertical	-36.0	-13.0	23.0	225
7	13300.0	-46.04	7.51	16.55	vertical	-37.0	-13.0	24.0	90
8	15200.0	-44.11	8.24	15.35	vertical	-37.0	-13.0	24.0	90
9	17100.0	-41.54	8.41	14.95	vertical	-35.0	-13.0	22.0	45
10	19000.0	-40.81	8.54	15.45	vertical	-33.9	-13.0	20.9	180

Note: 1.The other Spurious RF Radiated emissions level is no more than noise floor.  
 2.The worst emission was found in the antenna is vertical position.



## 6. Main Test Instruments

Name	Manufacturer	Type	Serial Number	Calibration Date	Expiration Time
Base Station Simulator	R&S	CMW500	150415	2017-05-14	2018-05-13
Power Splitter	Hua Xiang	SHX-GF2-2-13	10120101	2017-05-14	2018-05-13
Spectrum Analyzer	Agilent	N9010A	MY47191109	2017-05-20	2018-05-19
Universal Radio Communication Tester	Agilent	E5515C	MY48367192	2017-05-20	2018-05-19
Signal Analyzer	R&S	FSV30	100815	2016-12-16	2017-12-15
EMI Test Receiver	R&S	ESCI	100948	2017-05-20	2018-05-19
Signal generator	R&S	SMB 100A	102594	2017-05-14	2018-05-13
Signal generator	R&S	SMR27	100365	2017-05-14	2018-05-13
Trilog Antenna	SCHWARZBECK	VUBL 9163	9163-201	2014-12-06	2017-12-05
Horn Antenna	R&S	HF907	100126	2014-12-06	2017-12-05
Climatic Chamber	Re Ce	PT-30B	20101891	2015-07-18	2018-07-17
Horn Antenna	ETS-Lindgren	3160-09	00102644	2015-01-30	2018-01-29
RF Cable	Agilent	SMA 15cm	0001	2017-02-06	2017-08-05
Preampflier	R&S	SCU18	102327	2017-06-18	2018-06-17

\*\*\*\*\*END OF REPORT \*\*\*\*\*

## ANNEX A: EUT Appearance and Test Setup

### A.1 EUT Appearance

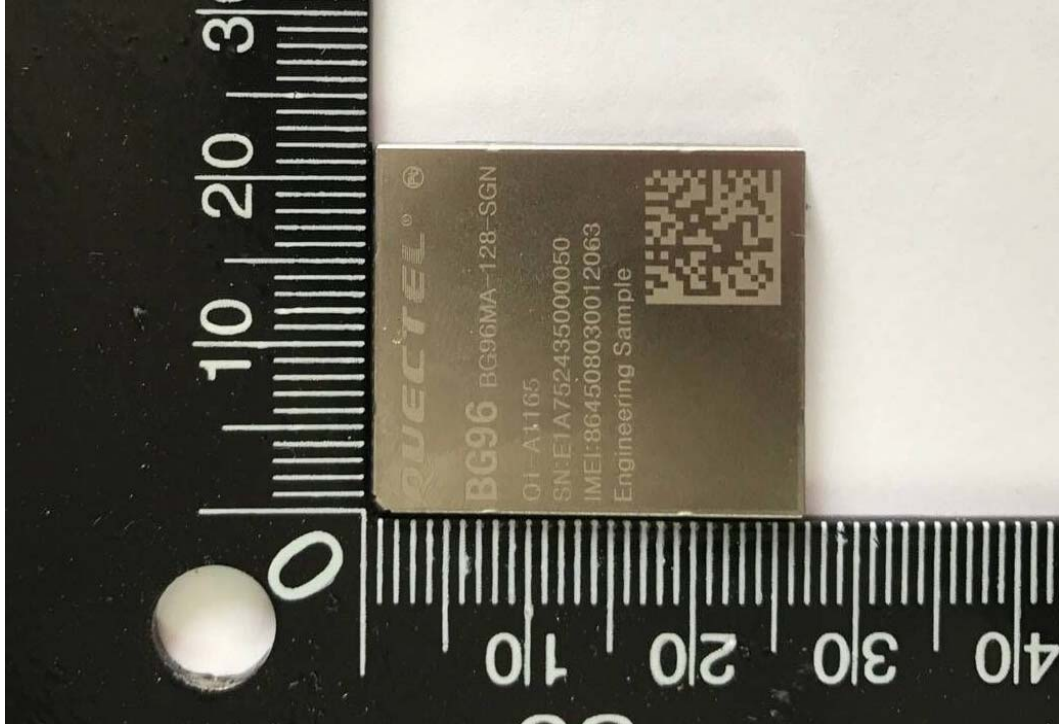

shielding

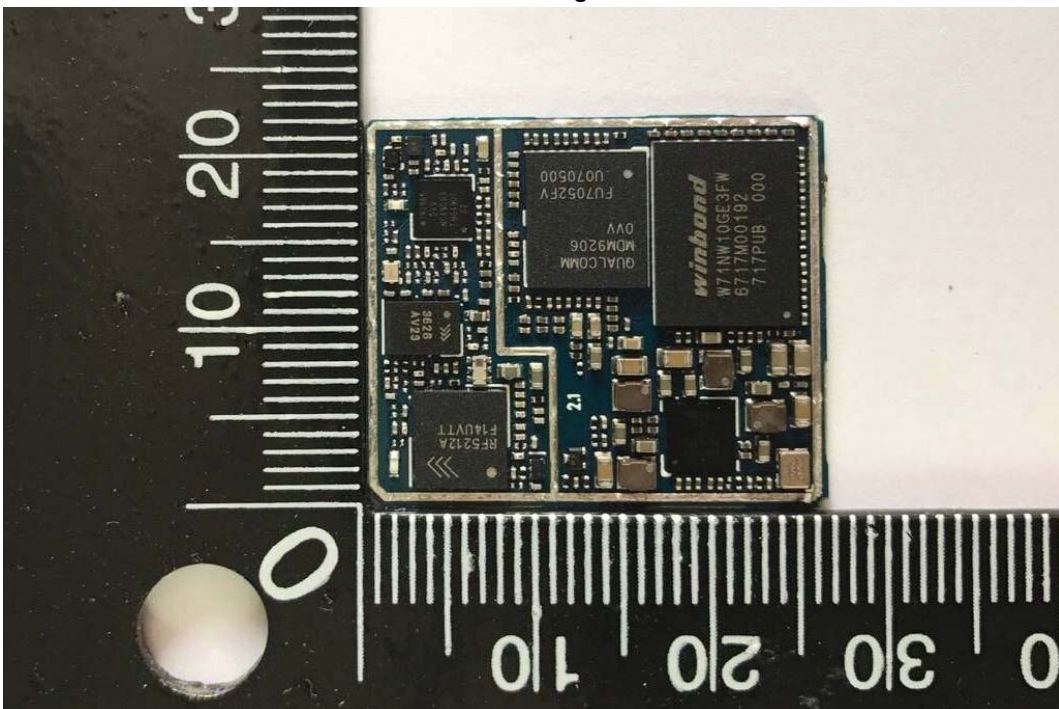

No shielding  
Front Side

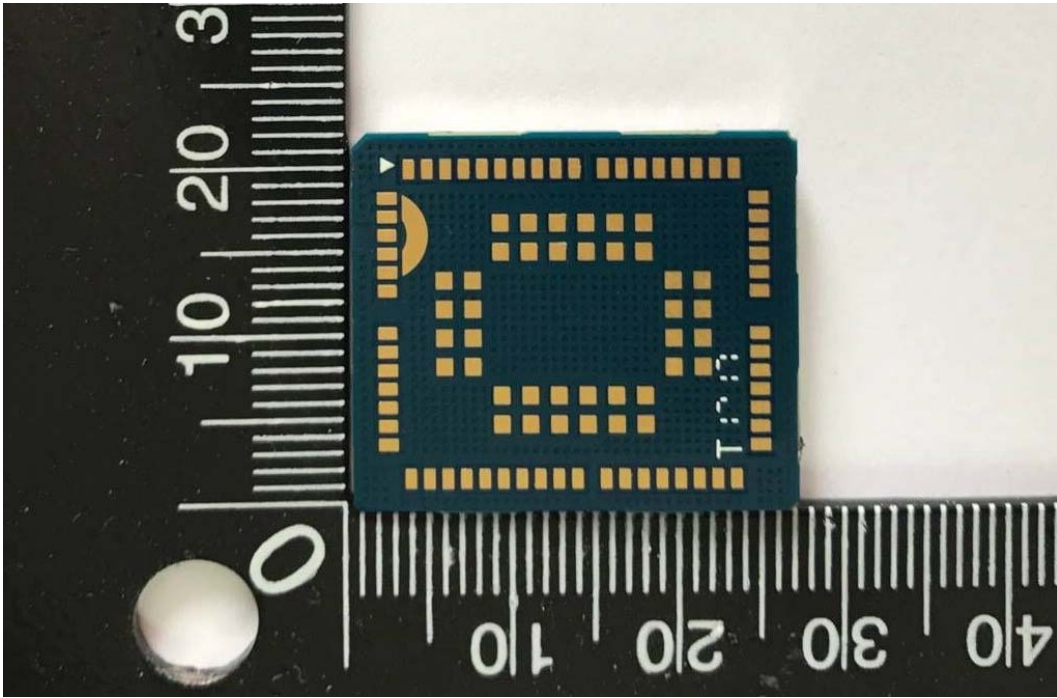

Back Side  
a: EUT



## A.2 Test Setup

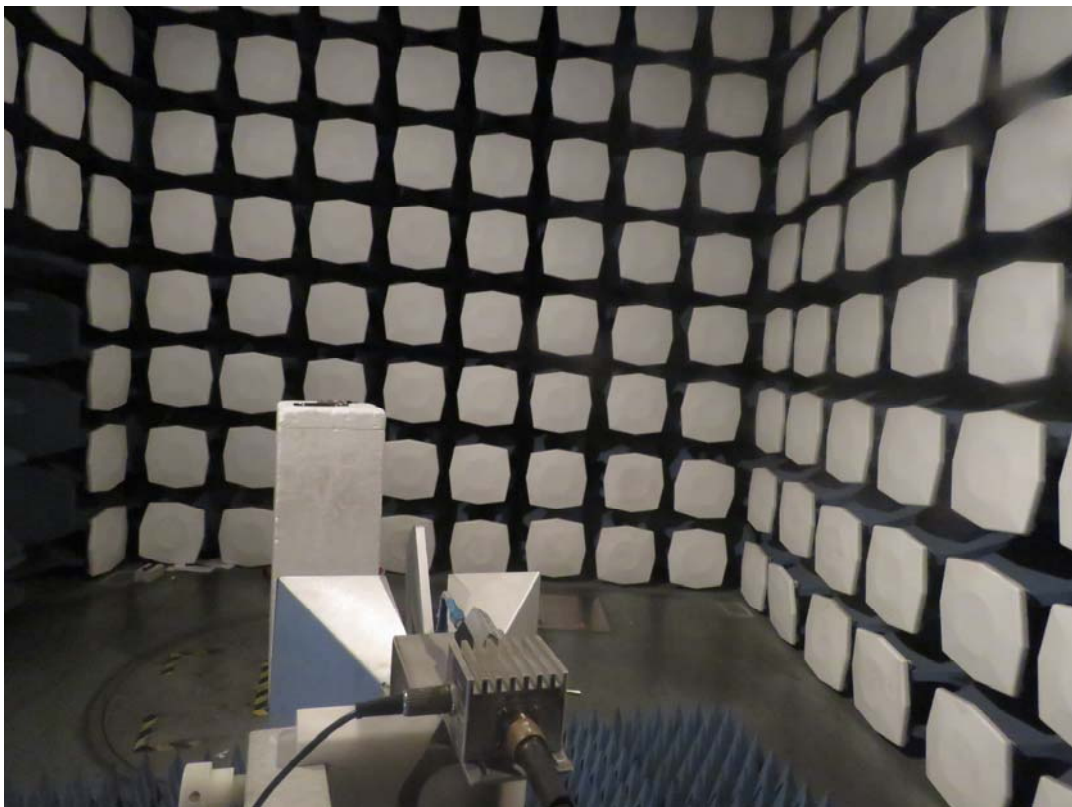
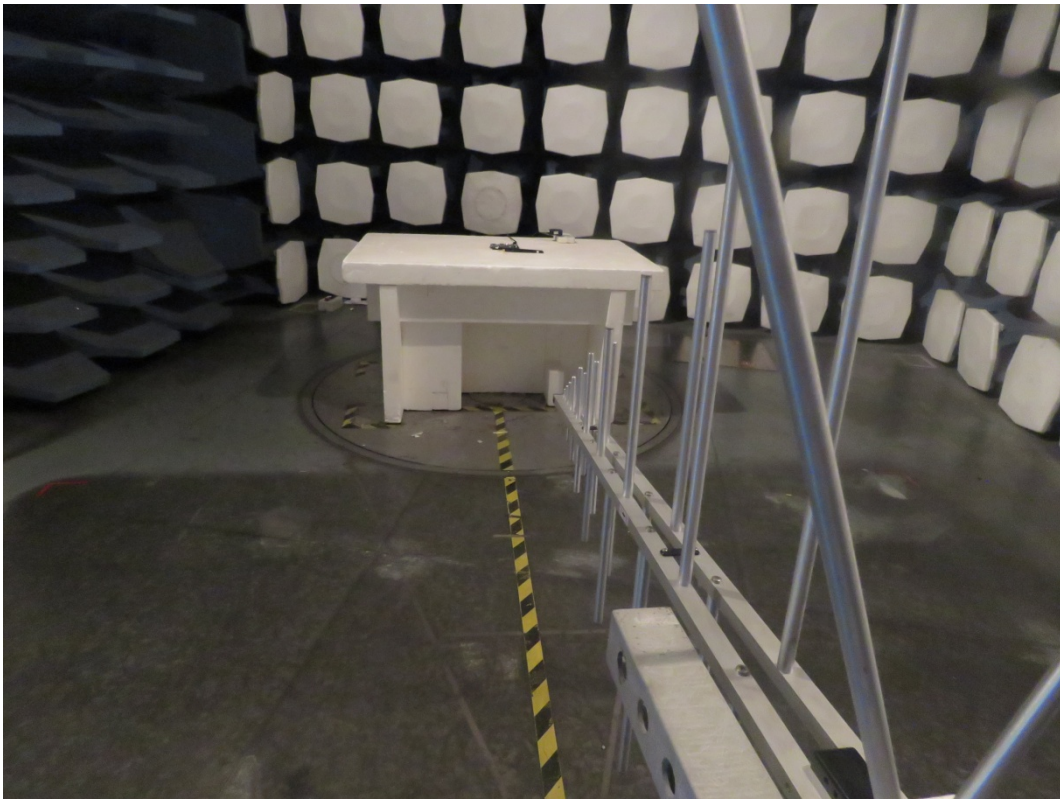

**Picture 2: Radiated Spurious Emissions Test setup**