

5.5. Peak-to-Average Power Ratio (PAPR)

Ambient condition

Temperature	Relative humidity	Pressure
23°C ~25°C	45%~50%	101.5kPa

Methods of Measurement

Measure the total peak power and record as P_{Pk} . And measure the total average power and record as P_{Avg} . Both the peak and average power levels must be expressed in the same logarithmic units (e.g., dBm). Determine the PAPR from:

$$PAPR (dB) = P_{Pk} (dBm) - P_{Avg} (dBm).$$

Test Setup

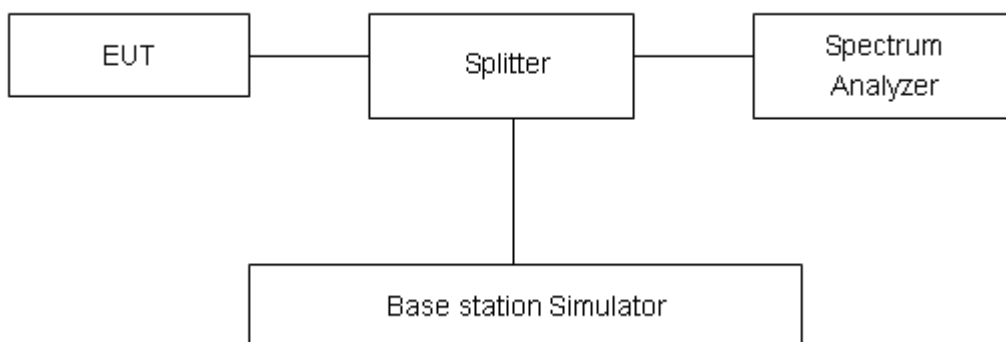

Limits

According to the Sec. 22.913(d), The peak-to-average ratio (PAR) of the transmission must not exceed 13 dB.

Measurement Uncertainty

The assessed measurement uncertainty to ensure 95% confidence level for the normal distribution is with the coverage factor $k = 2$, $U = 0.4$ dB.

Test Results

Mode	Channel	Frequency (MHz)	Peak (dBm)	Avg (dBm)	PAPR (dB)	Limit (dB)	Conclusion
GPRS 850 (GMSK)	128	824.2	30.69	30.01	0.68	≤13	PASS
	190	836.6	30.82	30.11	0.71	≤13	PASS
	251	848.8	30.92	30.28	0.64	≤13	PASS
EGPRS 850 (8-PSK)	128	824.2	26.84	26.05	0.79	≤13	PASS
	190	836.6	26.97	26.06	0.91	≤13	PASS
	251	848.8	27.00	26.19	0.81	≤13	PASS

LTE Band 5								
Modulation	Bandwidth (MHz)	Channel	Frequency (MHz)	Peak (dBm)	Avg (dBm)	PAPR (dB)	Limit (dB)	Conclusion
QPSK	1.4	20407	824.7	32.89	22.62	10.27	≤13	PASS
		20525	836.5	32.98	22.71	10.27	≤13	PASS
		20643	848.3	34.59	22.86	11.73	≤13	PASS
	3	20415	825.5	32.71	22.70	10.01	≤13	PASS
		20525	836.5	32.95	22.73	10.22	≤13	PASS
		20635	847.5	34.52	22.90	11.62	≤13	PASS
	5	20425	826.5	32.69	22.68	10.01	≤13	PASS
		20525	836.5	33.21	22.69	10.52	≤13	PASS
		20625	846.5	32.99	22.85	10.14	≤13	PASS
	10	20450	829	32.56	22.65	9.91	≤13	PASS
		20525	836.5	32.60	22.64	9.96	≤13	PASS
		20600	844	32.87	22.81	10.06	≤13	PASS
16QAM	1.4	20407	824.7	33.44	22.67	10.77	≤13	PASS
		20525	836.5	34.24	23.20	11.04	≤13	PASS
		20643	848.3	34.79	23.00	11.79	≤13	PASS
	3	20415	825.5	34.01	22.70	11.31	≤13	PASS
		20525	836.5	34.24	23.25	10.99	≤13	PASS
		20635	847.5	35.15	23.04	12.11	≤13	PASS
	5	20425	826.5	33.86	22.67	11.19	≤13	PASS
		20525	836.5	34.41	23.20	11.21	≤13	PASS
		20625	846.5	33.85	23.00	10.85	≤13	PASS
	10	20450	829	33.35	22.65	10.70	≤13	PASS
		20525	836.5	33.28	23.16	10.12	≤13	PASS
		20600	844	32.99	22.97	10.02	≤13	PASS

LTE Band 26								
Modulation	Bandwidth (MHz)	Channel	Frequency (MHz)	Peak (dBm)	Avg (dBm)	PAPR (dB)	Limit (dB)	Conclusion
QPSK	1.4	26797	824.7	33.12	22.76	10.36	≤13	PASS
		26915	836.5	34.32	22.74	11.58	≤13	PASS
		27033	848.3	34.27	22.75	11.52	≤13	PASS
	3	26805	825.5	32.83	22.74	10.09	≤13	PASS
		26915	836.5	34.86	22.73	12.13	≤13	PASS
		27025	847.5	34.05	22.73	11.32	≤13	PASS
	5	26815	826.5	33.04	22.82	10.22	≤13	PASS
		26915	836.5	32.82	22.75	10.07	≤13	PASS
		27015	846.5	33.18	22.77	10.41	≤13	PASS
	10	26840	829	33.13	22.80	10.33	≤13	PASS
		26915	836.5	33.01	22.71	10.30	≤13	PASS
		26990	844	32.72	22.72	10.00	≤13	PASS
	15	26865	831.5	31.94	22.77	9.17	≤13	PASS
		26915	836.5	32.64	22.66	9.98	≤13	PASS
		26965	841.5	33.86	22.68	11.18	≤13	PASS
16QAM	1.4	26797	824.7	34.28	23.10	11.18	≤13	PASS
		26915	836.5	36.11	23.19	12.92	≤13	PASS
		27033	848.3	35.77	22.87	12.90	≤13	PASS
	3	26805	825.5	34.12	23.08	11.04	≤13	PASS
		26915	836.5	35.43	23.15	12.28	≤13	PASS
		27025	847.5	35.59	22.82	12.77	≤13	PASS
	5	26815	826.5	33.94	23.11	10.83	≤13	PASS
		26915	836.5	34.20	23.20	11.00	≤13	PASS
		27015	846.5	33.77	22.86	10.91	≤13	PASS
	10	26840	829	33.08	23.08	10.00	≤13	PASS
		26915	836.5	33.76	23.15	10.61	≤13	PASS
		26990	844	33.41	22.82	10.59	≤13	PASS
	15	26865	831.5	32.47	23.06	9.41	≤13	PASS
		26915	836.5	32.80	23.11	9.69	≤13	PASS
		26965	841.5	33.03	22.79	10.24	≤13	PASS

5.6. Frequency Stability

Ambient condition

Temperature	Relative humidity	Pressure
23°C ~25°C	45%~50%	101.5kPa

Method of Measurement

1. Frequency Stability (Temperature Variation)

The temperature inside the climate chamber is varied from -40°C to +85°C in 10°C step size,

(1) With all power removed, the temperature was decreased to 0°C and permitted to stabilize for three hours.

(2) Measure the carrier frequency with the test equipment in a “call mode”. These measurements should be made within 1 minute of powering up the mobile station, to prevent significant self warming.

(3) Repeat the above measurements at 10°C increments from -40°C to +85°C. Allow at least 1.5 hours at each temperature, un-powered, before making measurements. Frequency Stability (Voltage Variation)

The frequency stability shall be measured with variation of primary supply voltage as follows:

(1) Vary primary supply voltage from 85 to 115 percent of the nominal value for other than hand carried battery equipment.

(2) For hand carried, battery powered equipment, reduce primary supply voltage to the battery-operating end point which shall be specified by the manufacturer.

This transceiver is specified to operate with an input voltage of between 3.3 V and 4.3 V, with a nominal voltage of 3.8V.

Test setup

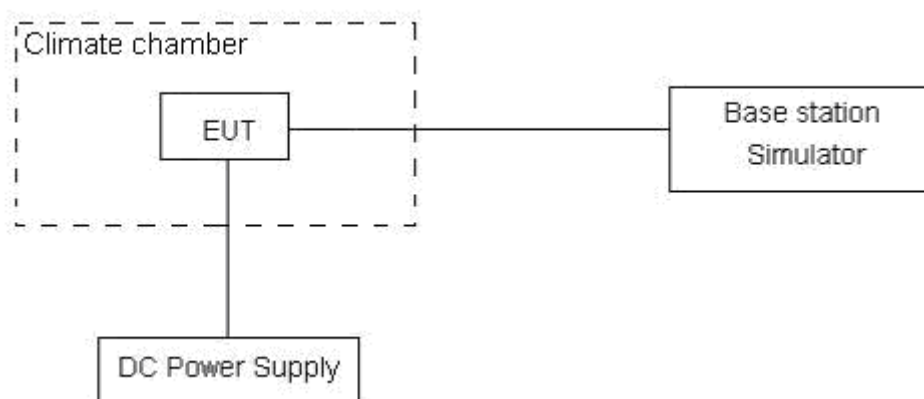

Limits

According to the Sec. 22.355, the frequency stability of the carrier shall be accurate to within 2.5 ppm of the received frequency for mobile stations.

Limits	≤ 2.5 ppm
--------	----------------

Measurement Uncertainty

The assessed measurement uncertainty to ensure 99.75% confidence level for the normal distribution is with the coverage factor $k = 3$, $U = 0.01$ ppm.

Test Result

Mode	Test status	Test Results (ppm)		Limit (ppm)	Conclusion
		GPRS (GMSK)	EGPRS (8PSK)		
GSM 850 Middle Channel	-40°C/Normal Voltage	0.0211	0.0202	2.5	PASS
	-30°C/Normal Voltage	0.0294	0.0242	2.5	PASS
	-20°C/Normal Voltage	0.0297	0.0257	2.5	PASS
	-10°C/Normal Voltage	0.0292	0.0253	2.5	PASS
	0°C/Normal Voltage	0.0301	0.0250	2.5	PASS
	10°C/Normal Voltage	0.0333	0.0241	2.5	PASS
	20°C/Normal Voltage	0.0395	0.0317	2.5	PASS
	30°C/Normal Voltage	0.0312	0.0262	2.5	PASS
	40°C/Normal Voltage	0.0343	0.0248	2.5	PASS
	50°C/Normal Voltage	0.0355	0.0288	2.5	PASS
	60°C/Normal Voltage	0.0325	0.0302	2.5	PASS
	70°C/Normal Voltage	0.0349	0.0273	2.5	PASS
	80°C/Normal Voltage	0.0350	0.0266	2.5	PASS
	85°C/Normal Voltage	0.0338	0.0279	2.5	PASS
	20°C/Minimum Voltage	0.0273	0.0234	2.5	PASS
	20°C/Maximum Voltage	0.0217	0.0208	2.5	PASS



Bandwidth	Test status	LTE Band 5 Middle Channel Test Results (ppm)			
		QPSK	16QAM	Limit (ppm)	Conclusion
1.4MHz	-40°C/Normal Voltage	-0.00147	-0.01488	2.5	PASS
	-30°C/Normal Voltage	-0.00025	-0.01676	2.5	PASS
	-20°C/Normal Voltage	-0.00142	-0.01840	2.5	PASS
	-10°C/Normal Voltage	-0.00279	-0.01732	2.5	PASS
	0°C/Normal Voltage	-0.00198	-0.02276	2.5	PASS
	10°C/Normal Voltage	-0.00053	-0.02736	2.5	PASS
	20°C/Normal Voltage	-0.00059	-0.01711	2.5	PASS
	30°C/Normal Voltage	0.00234	-0.01736	2.5	PASS
	40°C/Normal Voltage	0.00104	-0.02404	2.5	PASS
	50°C/Normal Voltage	0.00429	-0.01883	2.5	PASS
	60°C/Normal Voltage	0.00430	-0.02723	2.5	PASS
	70°C/Normal Voltage	-0.00128	-0.02343	2.5	PASS
	80°C/Normal Voltage	-0.00143	-0.01695	2.5	PASS
	85°C/Normal Voltage	0.00212	-0.01592	2.5	PASS
	20°C/Minimum Voltage	-0.00146	-0.01522	2.5	PASS
	20°C/Maximum Voltage	0.00099	-0.02527	2.5	PASS
3MHz	-40°C/Normal Voltage	-0.00178	-0.01886	2.5	PASS
	-30°C/Normal Voltage	-0.00259	-0.01704	2.5	PASS
	-20°C/Normal Voltage	-0.00334	-0.01677	2.5	PASS
	-10°C/Normal Voltage	-0.00158	-0.02166	2.5	PASS
	0°C/Normal Voltage	-0.00031	-0.01933	2.5	PASS
	10°C/Normal Voltage	-0.00438	-0.01900	2.5	PASS
	20°C/Normal Voltage	-0.00491	-0.01522	2.5	PASS
	30°C/Normal Voltage	-0.00392	-0.00512	2.5	PASS
	40°C/Normal Voltage	-0.00197	-0.00279	2.5	PASS
	50°C/Normal Voltage	-0.00160	0.00207	2.5	PASS
	60°C/Normal Voltage	-0.00361	0.00385	2.5	PASS
	70°C/Normal Voltage	-0.00209	-0.00123	2.5	PASS
	80°C/Normal Voltage	-0.00061	0.00393	2.5	PASS
	85°C/Normal Voltage	-0.00164	0.00286	2.5	PASS
	20°C/Minimum Voltage	-0.00197	0.00123	2.5	PASS
	20°C/Maximum Voltage	0.00099	0.00146	2.5	PASS
5MHz	-40°C/Normal Voltage	-0.00219	-0.02227	2.5	PASS
	-30°C/Normal Voltage	-0.00092	-0.01994	2.5	PASS
	-20°C/Normal Voltage	-0.00499	-0.01961	2.5	PASS



	-10°C/Normal Voltage	-0.00552	-0.01583	2.5	PASS
	0°C/Normal Voltage	-0.00453	-0.00573	2.5	PASS
	10°C/Normal Voltage	-0.00258	-0.00340	2.5	PASS
	20°C/Normal Voltage	-0.00221	0.00146	2.5	PASS
	30°C/Normal Voltage	-0.00422	0.00324	2.5	PASS
	40°C/Normal Voltage	-0.00056	-0.01977	2.5	PASS
	50°C/Normal Voltage	-0.00463	-0.01600	2.5	PASS
	60°C/Normal Voltage	-0.00516	-0.00589	2.5	PASS
	70°C/Normal Voltage	-0.00417	-0.00356	2.5	PASS
	80°C/Normal Voltage	-0.00222	0.00129	2.5	PASS
	85°C/Normal Voltage	-0.00185	0.00307	2.5	PASS
	20°C/Minimum Voltage	-0.00386	-0.02244	2.5	PASS
	20°C/Maximum Voltage	-0.00183	-0.02011	2.5	PASS
	10MHz	-40°C/Normal Voltage	-0.00252	0.01378	2.5
-30°C/Normal Voltage		-0.00126	0.00426	2.5	PASS
-20°C/Normal Voltage		-0.00532	-0.00082	2.5	PASS
-10°C/Normal Voltage		-0.00586	0.01753	2.5	PASS
0°C/Normal Voltage		-0.00487	0.00326	2.5	PASS
10°C/Normal Voltage		-0.00292	0.00164	2.5	PASS
20°C/Normal Voltage		-0.00255	0.00186	2.5	PASS
30°C/Normal Voltage		-0.00455	-0.01739	2.5	PASS
40°C/Normal Voltage		-0.00090	-0.01339	2.5	PASS
50°C/Normal Voltage		-0.00496	-0.01176	2.5	PASS
60°C/Normal Voltage		-0.00550	-0.01542	2.5	PASS
70°C/Normal Voltage		-0.00243	-0.00532	2.5	PASS
80°C/Normal Voltage		-0.00094	-0.00299	2.5	PASS
85°C/Normal Voltage		-0.00197	0.00186	2.5	PASS
20°C/Minimum Voltage		-0.00231	0.00365	2.5	PASS
20°C/Maximum Voltage	0.00066	-0.01578	2.5	PASS	

Bandwidth	Test status	LTE Band 26 Middle Channel Test Results (ppm)			
		QPSK	16QAM	Limit (ppm)	Conclusion
1.4MHz	-40°C/Normal Voltage	-0.00255	-0.00904	2.5	PASS
	-30°C/Normal Voltage	-0.00082	-0.00258	2.5	PASS
	-20°C/Normal Voltage	-0.00245	-0.00454	2.5	PASS
	-10°C/Normal Voltage	-0.00195	-0.00467	2.5	PASS
	0°C/Normal Voltage	-0.00237	-0.00055	2.5	PASS
	10°C/Normal Voltage	-0.00209	-0.00196	2.5	PASS



	20°C/Normal Voltage	-0.00316	0.00197	2.5	PASS
	30°C/Normal Voltage	0.00110	0.00117	2.5	PASS
	40°C/Normal Voltage	0.00018	-0.01288	2.5	PASS
	50°C/Normal Voltage	-0.00241	-0.01149	2.5	PASS
	60°C/Normal Voltage	-0.00175	-0.00275	2.5	PASS
	70°C/Normal Voltage	-0.00218	-0.00581	2.5	PASS
	80°C/Normal Voltage	-0.00326	-0.00439	2.5	PASS
	85°C/Normal Voltage	-0.00109	-0.00863	2.5	PASS
	20°C/Minimum Voltage	-0.00053	-0.00961	2.5	PASS
	20°C/Maximum Voltage	-0.00207	-0.01095	2.5	PASS
3MHz	-40°C/Normal Voltage	-0.00073	-0.01100	2.5	PASS
	-30°C/Normal Voltage	-0.00258	-0.01870	2.5	PASS
	-20°C/Normal Voltage	-0.00261	-0.01069	2.5	PASS
	-10°C/Normal Voltage	-0.00302	-0.01623	2.5	PASS
	0°C/Normal Voltage	-0.00081	-0.00377	2.5	PASS
	10°C/Normal Voltage	-0.00209	-0.01283	2.5	PASS
	20°C/Normal Voltage	-0.00219	-0.01866	2.5	PASS
	30°C/Normal Voltage	-0.00185	-0.02007	2.5	PASS
	40°C/Normal Voltage	-0.00112	-0.01834	2.5	PASS
	50°C/Normal Voltage	0.00104	-0.01458	2.5	PASS
	60°C/Normal Voltage	-0.00322	-0.01830	2.5	PASS
	70°C/Normal Voltage	-0.00081	-0.01652	2.5	PASS
	80°C/Normal Voltage	-0.00292	-0.01957	2.5	PASS
	85°C/Normal Voltage	-0.00253	-0.01998	2.5	PASS
	20°C/Minimum Voltage	-0.00082	-0.02011	2.5	PASS
20°C/Maximum Voltage	-0.00062	-0.01874	2.5	PASS	
5MHz	-40°C/Normal Voltage	-0.00377	-0.01621	2.5	PASS
	-30°C/Normal Voltage	-0.00441	-0.01817	2.5	PASS
	-20°C/Normal Voltage	-0.00294	-0.01724	2.5	PASS
	-10°C/Normal Voltage	-0.00087	-0.01276	2.5	PASS
	0°C/Normal Voltage	-0.00381	-0.02108	2.5	PASS
	10°C/Normal Voltage	-0.00455	-0.01305	2.5	PASS
	20°C/Normal Voltage	-0.00348	-0.00441	2.5	PASS
	30°C/Normal Voltage	-0.00316	-0.00631	2.5	PASS
	40°C/Normal Voltage	-0.00092	-0.00910	2.5	PASS
	50°C/Normal Voltage	0.00149	-0.00814	2.5	PASS
	60°C/Normal Voltage	0.00143	-0.00483	2.5	PASS
	70°C/Normal Voltage	-0.00383	-0.00781	2.5	PASS
	80°C/Normal Voltage	-0.00246	-0.00750	2.5	PASS
	85°C/Normal Voltage	0.00236	-0.01982	2.5	PASS



	20°C/Minimum Voltage	-0.00310	-0.01586	2.5	PASS
	20°C/Maximum Voltage	0.00005	-0.01339	2.5	PASS
10MHz	-40°C/Normal Voltage	0.00022	0.00374	2.5	PASS
	-30°C/Normal Voltage	-0.00258	0.00269	2.5	PASS
	-20°C/Normal Voltage	-0.00281	-0.00081	2.5	PASS
	-10°C/Normal Voltage	-0.00347	-0.00122	2.5	PASS
	0°C/Normal Voltage	-0.00201	-0.00212	2.5	PASS
	10°C/Normal Voltage	-0.00300	-0.00171	2.5	PASS
	20°C/Normal Voltage	-0.00126	-0.00060	2.5	PASS
	30°C/Normal Voltage	-0.00228	-0.00116	2.5	PASS
	40°C/Normal Voltage	-0.00081	0.00389	2.5	PASS
	50°C/Normal Voltage	0.00237	0.00440	2.5	PASS
	60°C/Normal Voltage	-0.00122	0.00307	2.5	PASS
	70°C/Normal Voltage	-0.00100	0.00085	2.5	PASS
	80°C/Normal Voltage	-0.00336	-0.00016	2.5	PASS
	85°C/Normal Voltage	-0.00024	0.00495	2.5	PASS
	20°C/Minimum Voltage	-0.00279	0.00288	2.5	PASS
	20°C/Maximum Voltage	-0.00112	0.00154	2.5	PASS
15MHz	-40°C/Normal Voltage	-0.00257	-0.01834	2.5	PASS
	-30°C/Normal Voltage	-0.00241	0.00308	2.5	PASS
	-20°C/Normal Voltage	-0.00202	0.03394	2.5	PASS
	-10°C/Normal Voltage	-0.00255	0.04132	2.5	PASS
	0°C/Normal Voltage	-0.00128	-0.02313	2.5	PASS
	10°C/Normal Voltage	-0.00300	0.03032	2.5	PASS
	20°C/Normal Voltage	-0.00127	0.03543	2.5	PASS
	30°C/Normal Voltage	-0.00165	0.03247	2.5	PASS
	40°C/Normal Voltage	-0.00200	0.03540	2.5	PASS
	50°C/Normal Voltage	-0.00130	0.03388	2.5	PASS
	60°C/Normal Voltage	-0.00353	0.03145	2.5	PASS
	70°C/Normal Voltage	-0.00329	0.04016	2.5	PASS
	80°C/Normal Voltage	-0.00313	0.04157	2.5	PASS
	85°C/Normal Voltage	-0.00331	0.03741	2.5	PASS
	20°C/Minimum Voltage	-0.00288	0.03040	2.5	PASS
	20°C/Maximum Voltage	-0.00172	0.02449	2.5	PASS

5.7. Spurious Emissions at Antenna Terminals

Ambient condition

Temperature	Relative humidity	Pressure
23°C ~25°C	45%~50%	101.5kPa

Method of Measurement

The EUT was connected to Spectrum Analyzer and Base Station Simulator via power Splitter. The measurement is carried out using a spectrum analyzer. The spectrum analyzer scans from 9kHz to the 10th harmonic of the carrier. The peak detector is used. RBW are set to 100 kHz and VBW are set to 300 kHz for below 1G, RBW are set to 1MHz and VBW are set to 3MHz for above 1G, Sweep is set to ATUO.

Test setup

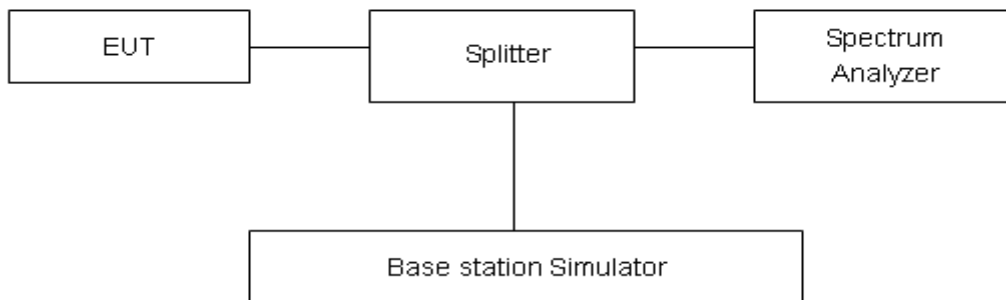

Limits

Rule Part 22.917(a) specifies that “The power of any emission outside of the authorized operating frequency ranges must be attenuated below the transmitting power (P) by a factor of at least 43 + 10 log (P) dB.”

Limit	-13 dBm
-------	---------

Measurement Uncertainty

The assessed measurement uncertainty to ensure 99.75% confidence level for the normal distribution is with the coverage factor $k = 1.96$.

Frequency	Uncertainty
100kHz-2GHz	0.684 dB
2GHz-12.75GHz	1.407 dB

Test Result

Sweep from 9 kHz to 30MHz, and the emissions more than 20 dB below the permissible value are not reported.

If disturbances were found more than 20dB below limit line, the mark is not required for the EUT.
The signal beyond the limit is carrier.

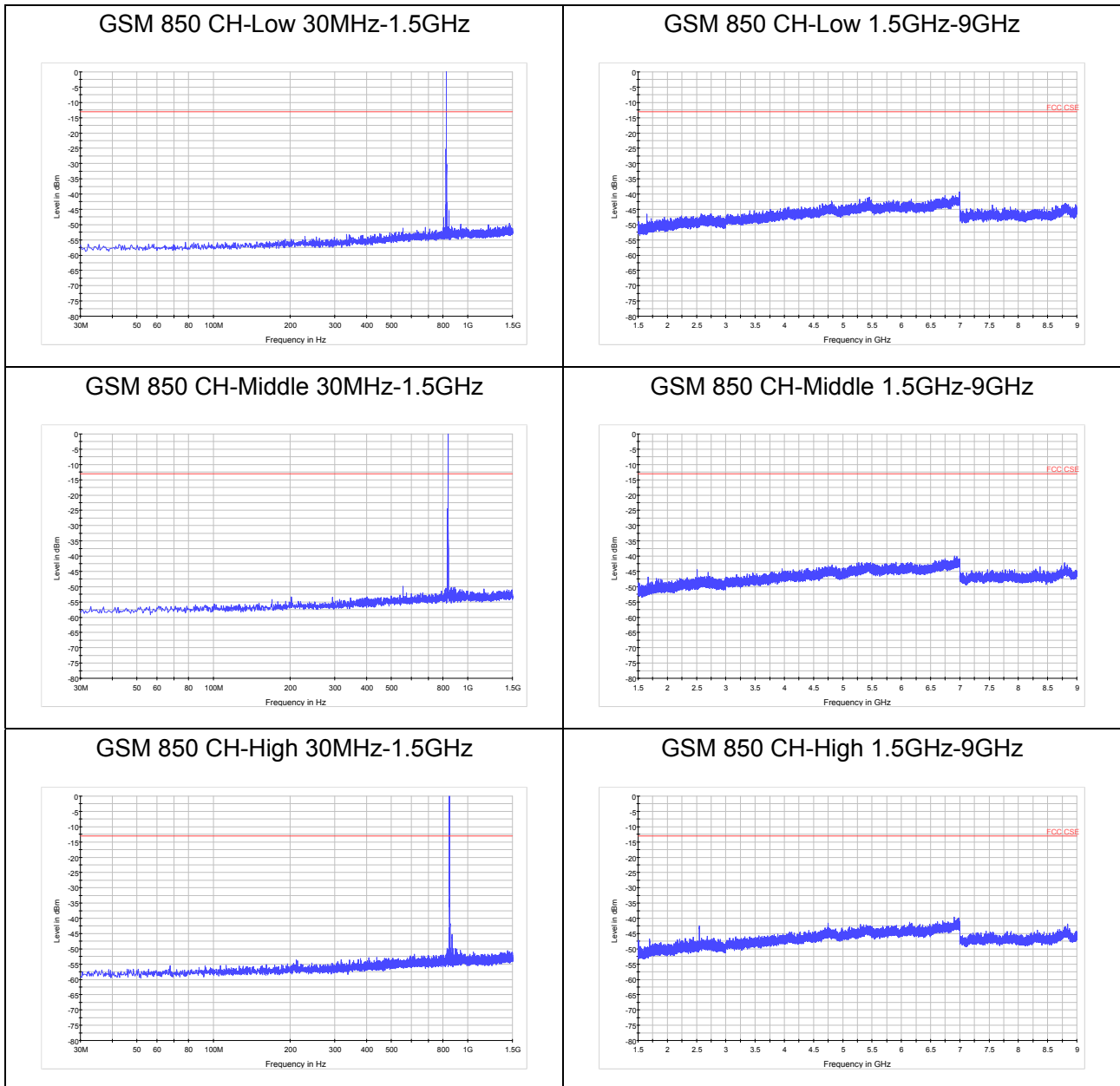



LTE Band 5 1.4MHz CH-Low 30MHz-1.5GHz

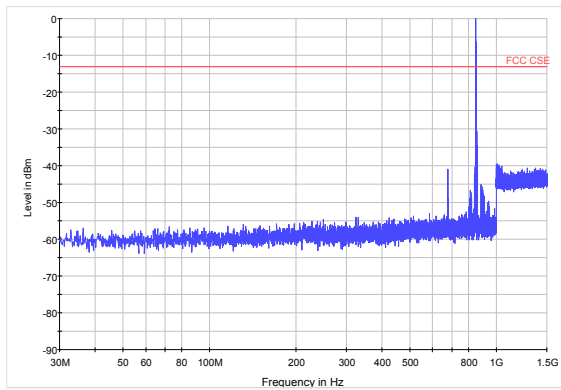

LTE Band 5 1.4MHz CH-Low 1.5GHz-9GHz

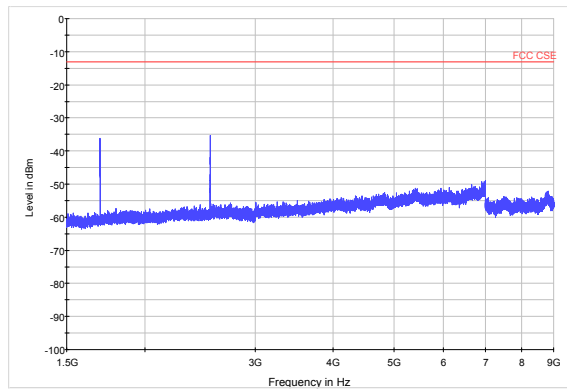

LTE Band 5 1.4MHz CH-Middle 30MHz-1.5GHz

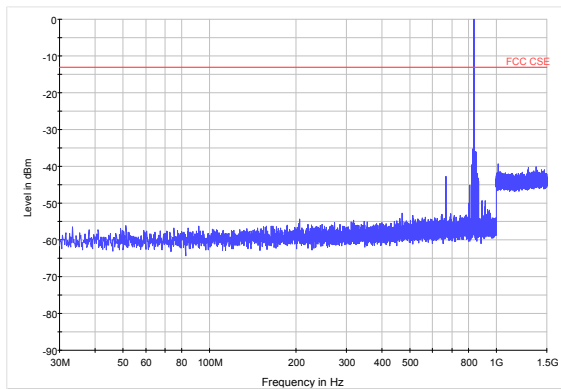

LTE Band 5 1.4MHz CH-Middle 1.5GHz-9GHz

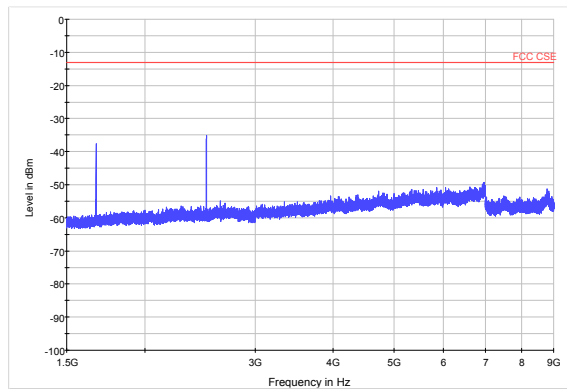

LTE Band 5 1.4MHz CH-High 30MHz-1.5GHz

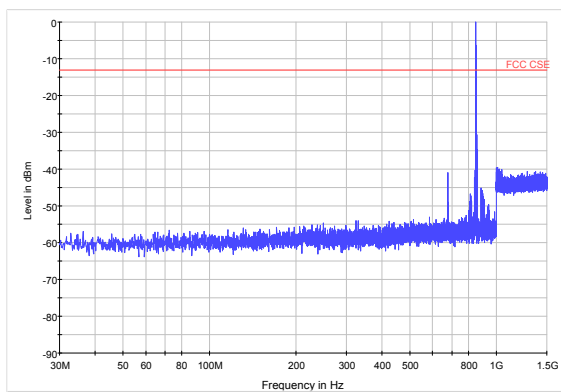

LTE Band 5 1.4MHz CH-High 1.5GHz-9GHz z

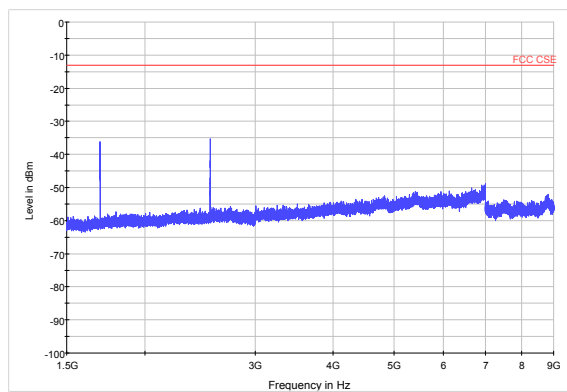



LTE Band 5 3MHz CH-Low 30MHz-1.5GHz

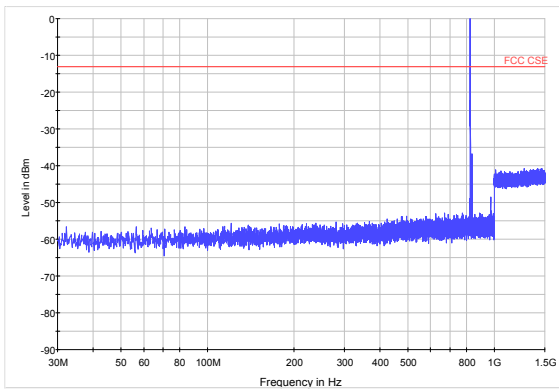

LTE Band 5 3MHz CH-Low 1.5GHz-9GHz z

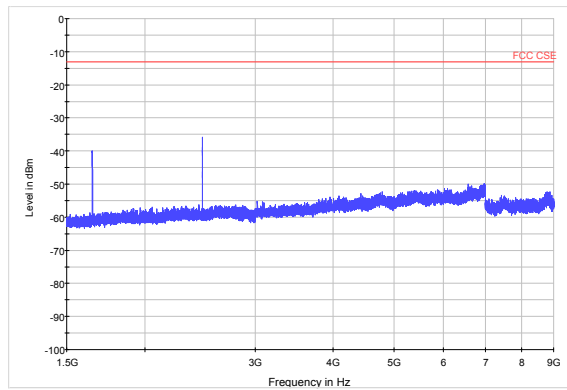

LTE Band 5 3MHz CH-Middle 30MHz-1.5GHz

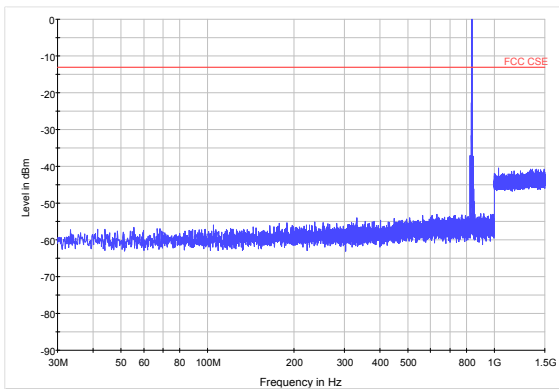

LTE Band 5 3MHz CH-Middle 1.5GHz-9GHz

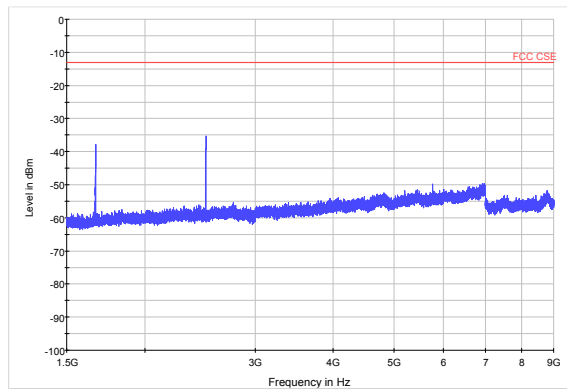

LTE Band 5 3MHz CH-High 30MHz-1.5GHz

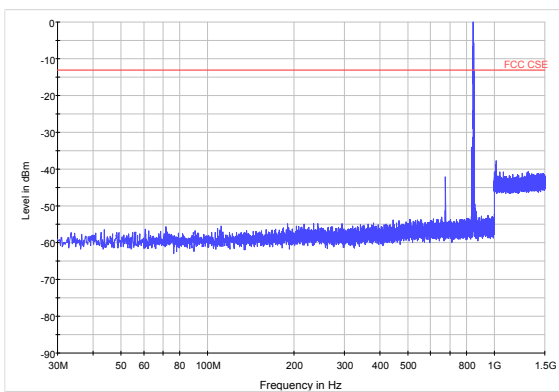

LTE Band 5 3MHz CH-High 1.5GHz-9GHz

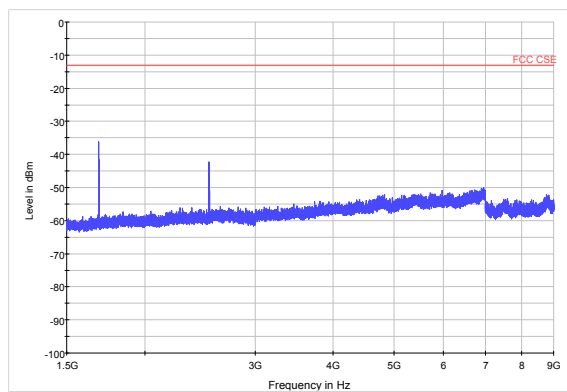



LTE Band 5 5MHz CH-Low 30MHz-1.5GHz

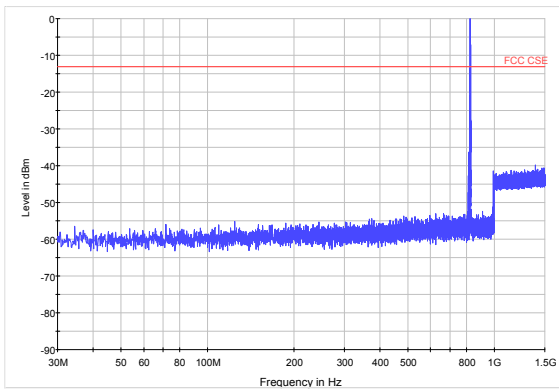

LTE Band 5 5MHz CH-Low 1.5GHz-9GHz

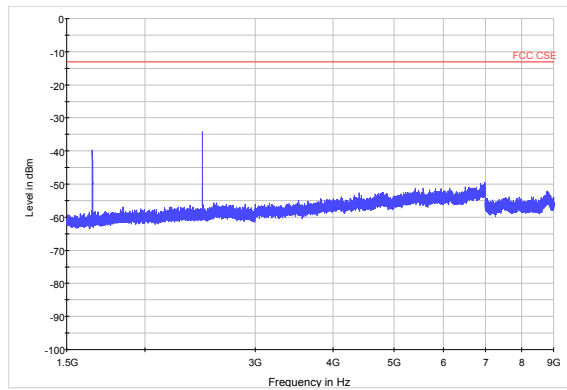

LTE Band 5 5MHz CH-Middle 30MHz-1.5GHz

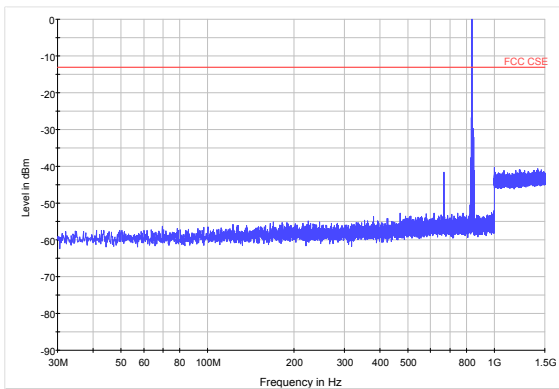

LTE Band 5 5MHz CH-Middle 1.5GHz-9GHz

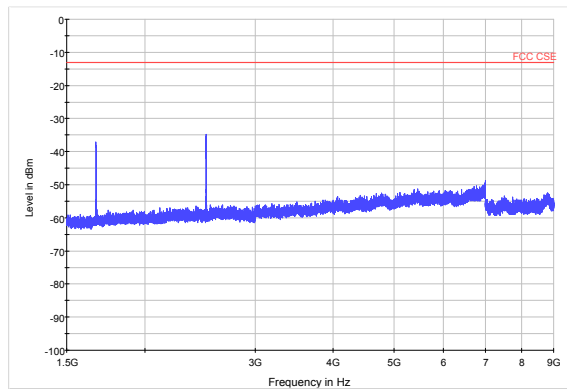

LTE Band 5 5MHz CH-High 30MHz-1.5GHz

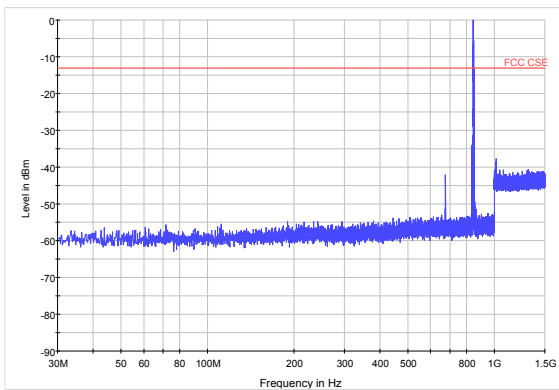

LTE Band 5 5MHz CH-High 1.5GHz-9GHz

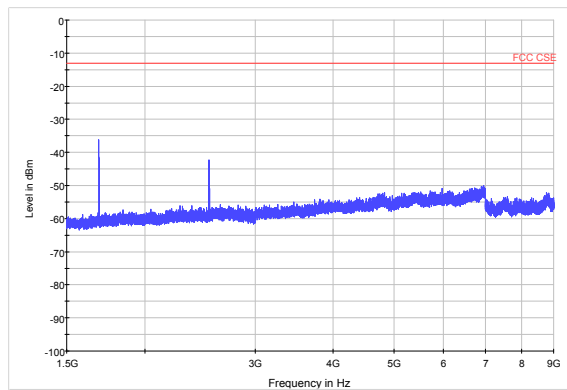



LTE Band 5 10MHz CH-Low 30MHz-1.5GHz

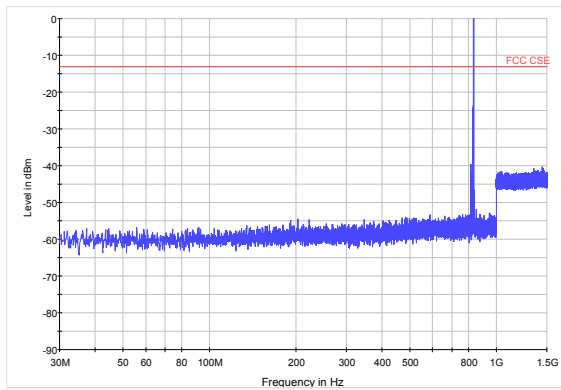

LTE Band 5 10MHz CH-Low 1.5GHz-9GHz

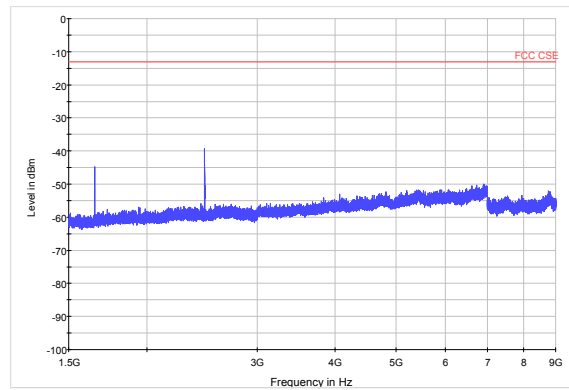

LTE Band 5 10MHz CH-Middle 30MHz-1.5GHz

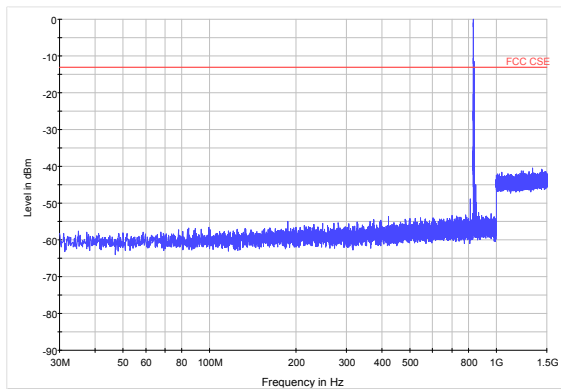

LTE Band 5 10MHz CH-Middle 1.5GHz-9GHz

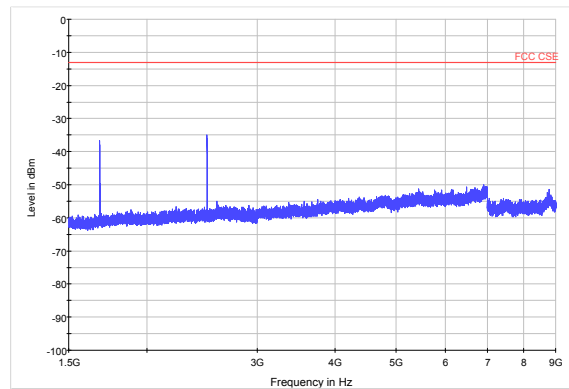

LTE Band 5 10MHz CH-High 30MHz-1.5GHz

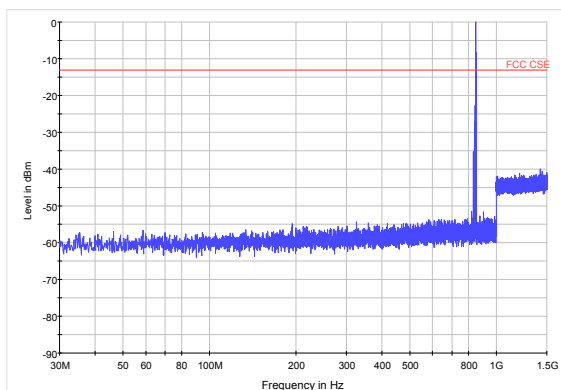

LTE Band 5 10MHz CH-High 1.5GHz-9GHz

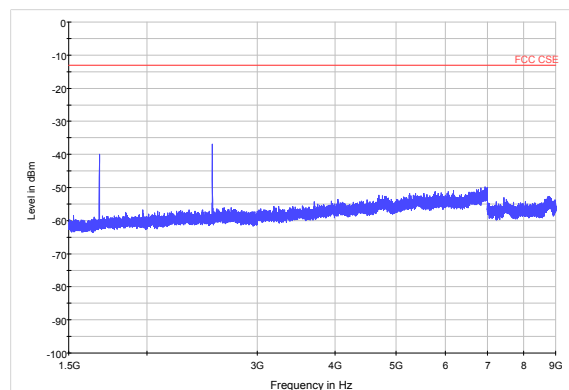



LTE Band 26 1.4MHz CH-Low 1.5MHz~3GHz

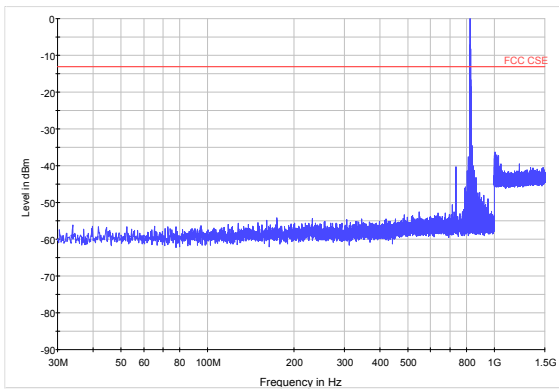

LTE Band 26 1.4MHz CH-Low 1.5GHz~9GHz

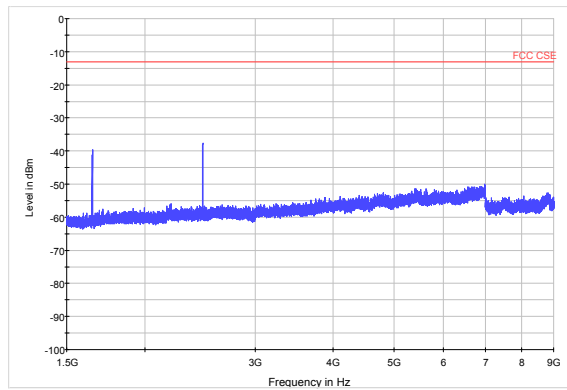

LTE Band 26 1.4MHz CH-Middle 1.5MHz~3GHz

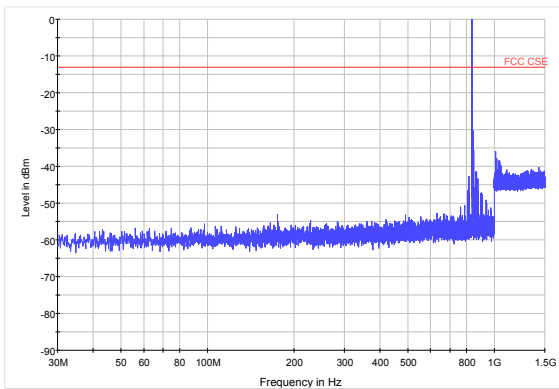

LTE Band 26 1.4MHz CH-Middle 1.5GHz~9GHz

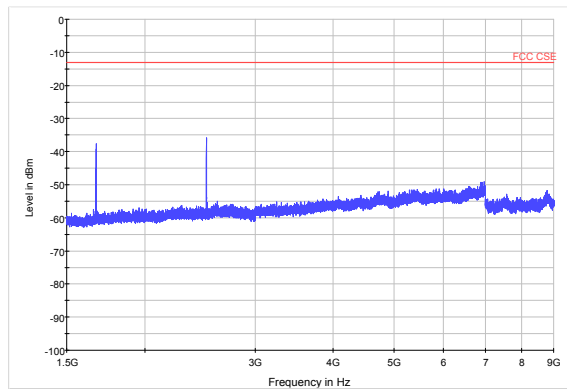

LTE Band 26 1.4MHz CH-High 1.5MHz~3GHz

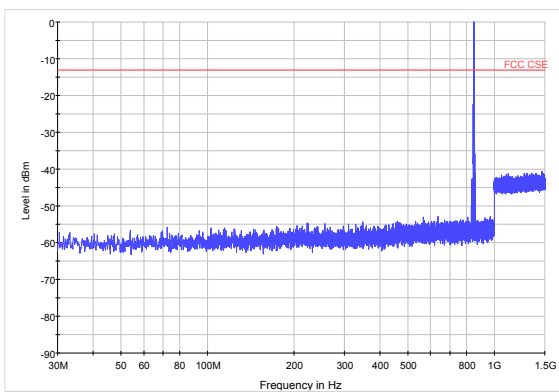

LTE Band 26 1.4MHz CH-High 1.5GHz~9GHz

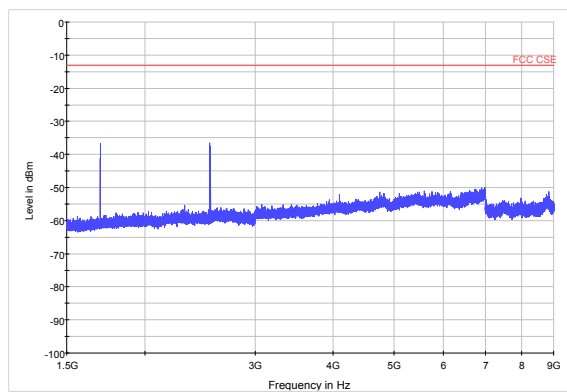



LTE Band 26 3MHz CH-Low 1.5MHz~3GHz

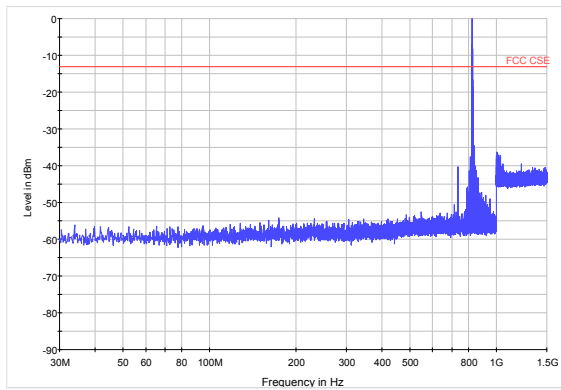

LTE Band 26 3MHz CH-Low 1.5GHz~9GHz

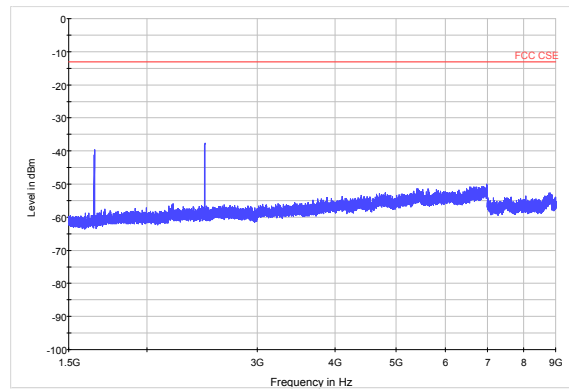

LTE Band 26 3MHz CH-Middle 1.5MHz~3GHz

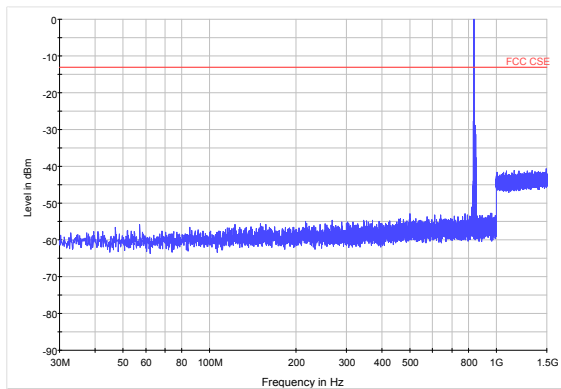

LTE Band 26 3MHz CH-Middle 1.5GHz~9GHz

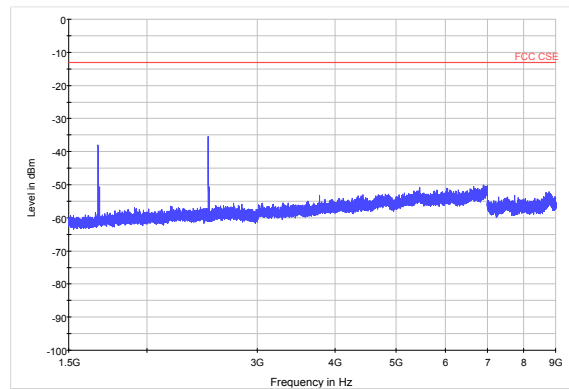

LTE Band 26 3MHz CH-High 1.5MHz~3GHz

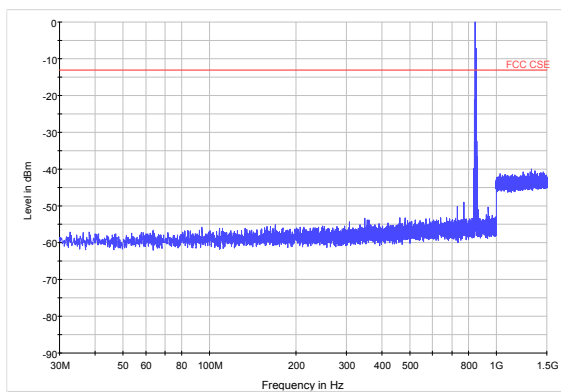

LTE Band 26 3MHz CH-High 1.5GHz~9GHz

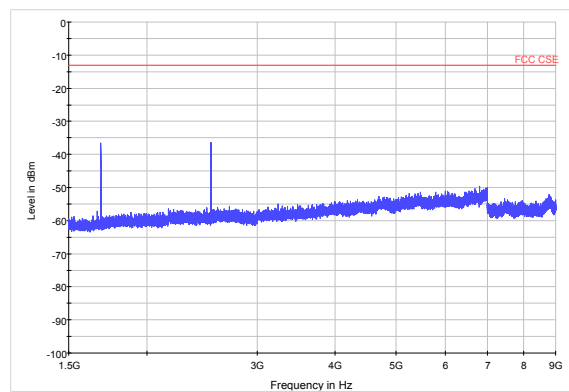



LTE Band 26 5MHz CH-Low 1.5MHz~3GHz

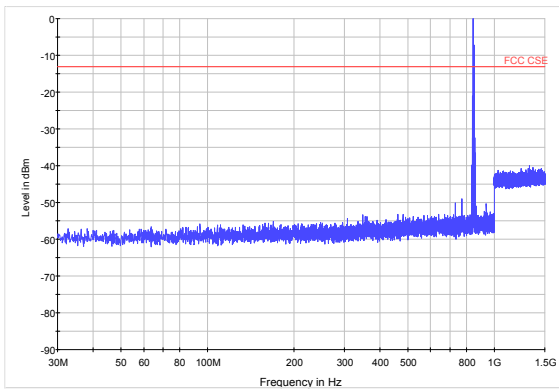

LTE Band 26 5MHz CH-Low 1.5GHz~9GHz

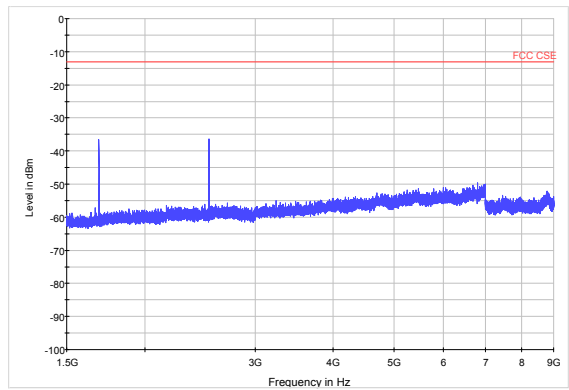

LTE Band 26 5MHz CH-Middle 1.5MHz~3GHz

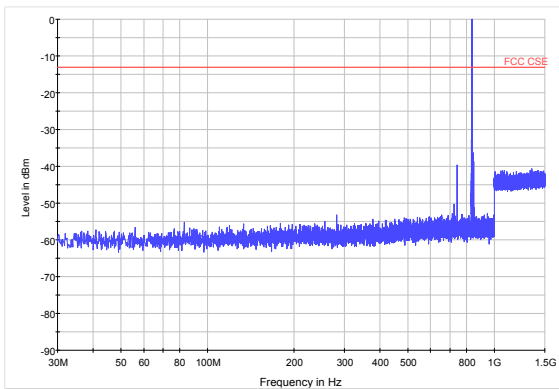

LTE Band 26 5MHz CH-Middle 1.5GHz~9GHz

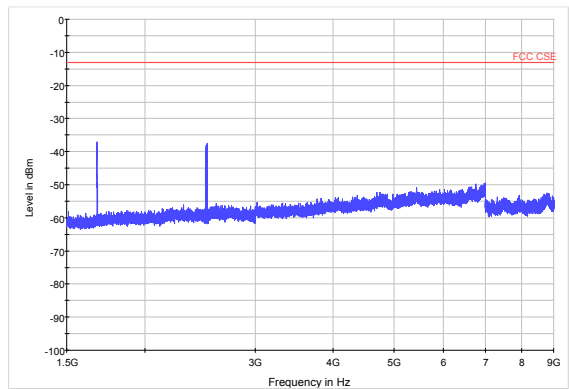

LTE Band 26 10MHz CH-Low 1.5MHz~3GHz

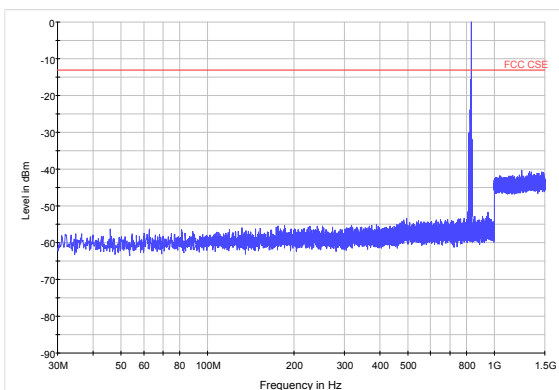

LTE Band 26 10MHz CH-Low 1.5GHz~9GHz

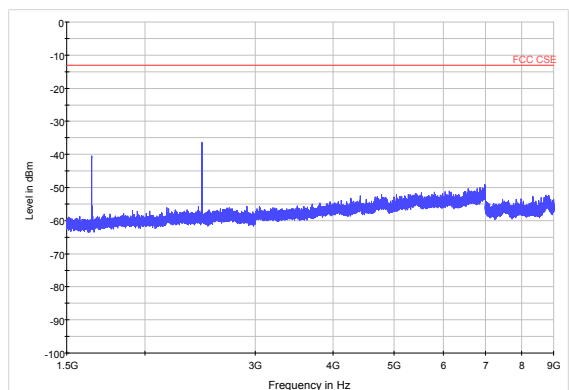



LTE Band 26 10MHz CH-Middle 1.5MHz~3GHz

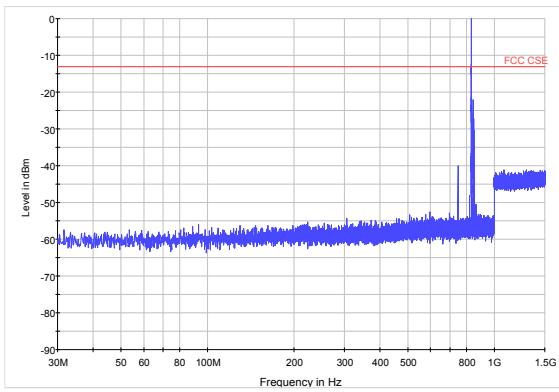

LTE Band 26 10MHz CH-Middle 1.5GHz~9GHz

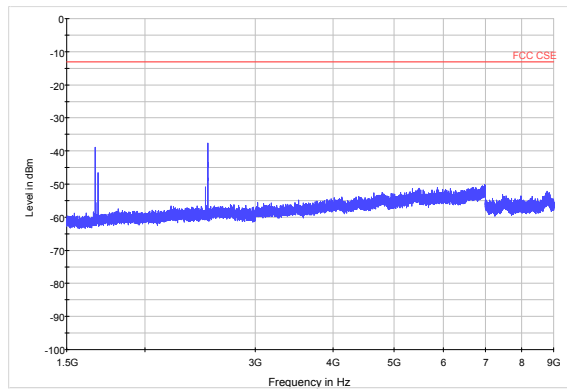

LTE Band 26 10MHz CH-High 1.5MHz~3GHz

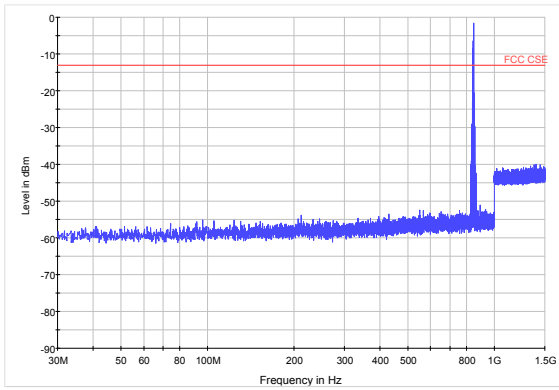

LTE Band 26 10MHz CH-High 1.5GHz~9GHz

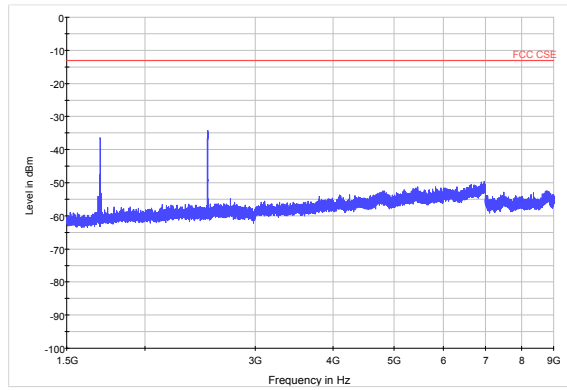

5.8. Radiates Spurious Emission

Ambient condition

Temperature	Relative humidity	Pressure
23°C ~25°C	45%~50%	101.5kPa

Method of Measurement

1. The testing follows ANSI C63.26 (2015) Section 5.5.2.3.
2. Above 30MHz: The EUT is placed on a turntable 0.8 meters above the ground in the chamber, 3 meter away from the antenna. The maximal emission value is acquired by adjusting the antenna height, polarisation and turntable azimuth. Normally, the height range of antenna is 1 m to 4 m, the azimuth range of turntable is 0° to 360°, and the receive antenna has two polarizations Vertical (V) and Horizontal (H). Above 1GHz: (Note: the FCC's permission to use 1.5m as an alternative per TCBC Conf call of Dec. 2, 2014.) The EUT is placed on a turntable 1.5 meters above the ground in the chamber, 3 meter away from the antenna. The maximal emission value is acquired by adjusting the antenna height, polarisation and turntable azimuth. Normally, the height range of antenna is 1 m to 4 m, the azimuth range of turntable is 0° to 360°, and the receive antenna has two polarizations Vertical (V) and Horizontal (H).
3. A log-periodic antenna or double-ridged waveguide horn antenna shall be substituted in place of the EUT. The log-periodic antenna will be driven by a signal generator and the level will be adjusted till the same power value on the spectrum analyzer or receiver. The level of the spurious emissions can be calculated through the level of the signal generator, cable loss, the gain of the substitution antenna and the reading of the spectrum analyzer or receiver.
4. The EUT is then put into continuously transmitting mode at its maximum power level during the test. Set Test Receiver or Spectrum RBW=1MHz, VBW=3MHz for above 1GHz and RBW=100kHz, VBW=300kHz for 30MHz to 1GHz, And the maximum value of the receiver should be recorded as (Pr).
5. The EUT shall be replaced by a substitution antenna. In the chamber, an substitution antenna for the frequency band of interest is placed at the reference point of the chamber. An RF Signal source for the frequency band of interest is connected to the substitution antenna with a cable that has been constructed to not interfere with the radiation pattern of the antenna. A power (PMea) is applied to the input of the substitution antenna, and adjust the level of the signal generator output until the value of the receiver reach the previously recorded (Pr). The power of signal source (PMea) is recorded. The test should be performed by rotating the test item and adjusting the receiving antenna polarization.
6. A amplifier should be connected to the Signal Source output port. And the cable should be connect between the Amplifier and the Substitution Antenna. The cable loss (Pcl) ,the Substitution Antenna Gain (Ga) and the Amplifier Gain (PAg) should be recorded after test.
7. The measurement results are obtained as described below:
Power(EIRP)=PMea- PAg - Pcl + Ga
The measurement results are amend as described below:
Power(EIRP)=PMea- Pcl + Ga
8. This value is EIRP since the measurement is calibrated using an antenna of known gain (2.15 dBi)

and known input power. ERP can be calculated from EIRP by subtracting the gain of the dipole, $ERP = EIRP - 2.15\text{dBi}$.

Test setup

30MHz~~~ 1GHz

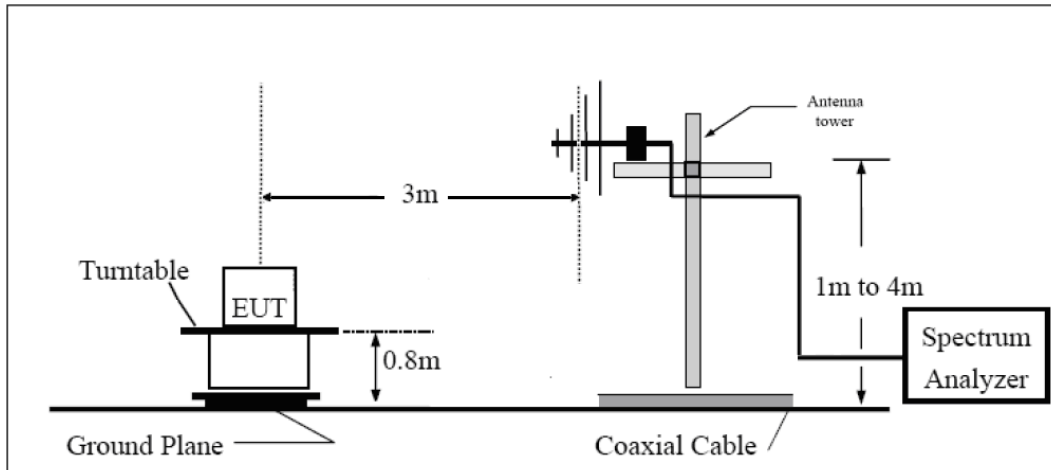

Above 1GHz

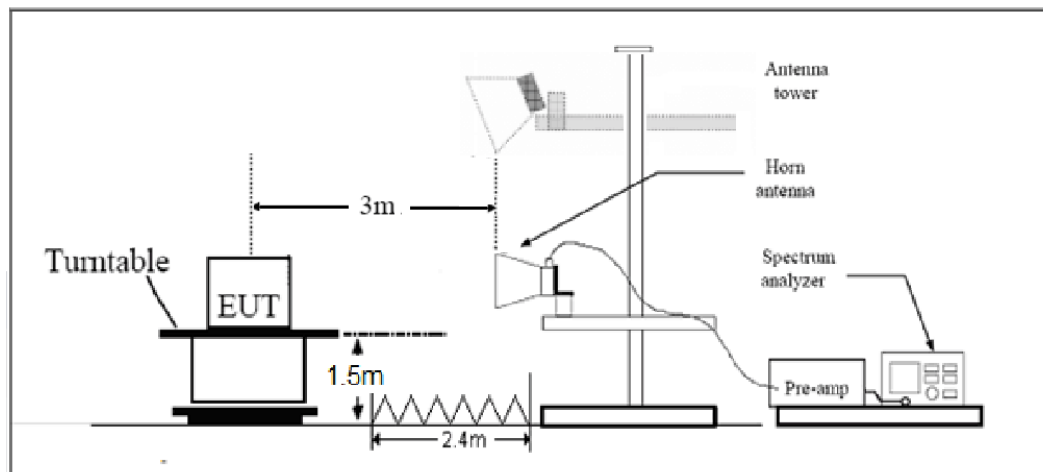

Note: Area side: 2.4mX3.6m

The radiated emission was measured in the following position: EUT lie-down position (Z axis), stand-up position (X, Y axis). The worst emission was found in lie-down position (Z axis) and the worst case was recorded.

Limits

Rule Part 22.917(a) specifies that “The power of any emission outside of the authorized operating frequency ranges must be attenuated below the transmitting power (P) by a factor of at least $43 + 10 \log (P)$ dB.”

Limit	-13 dBm
-------	---------

Measurement Uncertainty

The assessed measurement uncertainty to ensure 95% confidence level for the normal distribution is with the coverage factor $k = 1.96$, $U = 3.55$ dB.

**Test Result**

GSM 850 CH-Low

Harmonic	Frequency (MHz)	SG (dBm)	Cable Loss (dB)	Gain (dBi)	Antenna Polarization	ERP Level (dBm)	Limit (dBm)	Margin (dB)	Azimuth (deg)
2	1648	-56.00	2	10.15	Vertical	-50.0	-13.0	37.0	45
3	2473	-56.69	2.51	11.35	Vertical	-50.0	-13.0	37.0	180
4	3297	-54.60	4.2	10.85	Vertical	-50.1	-13.0	37.1	180
5	4121	-53.30	5.2	11.35	Vertical	-49.3	-13.0	36.3	225
6	4945	-52.00	5.5	11.95	Vertical	-47.7	-13.0	34.7	135
7	5769	-52.30	5.7	13.55	Vertical	-46.6	-13.0	33.6	135
8	6594	-48.40	6.3	13.75	Vertical	-43.1	-13.0	30.1	45
9	7418	-46.30	6.8	13.85	Vertical	-41.4	-13.0	28.4	180
10	8242	-46.40	6.9	14.25	Vertical	-41.2	-13.0	28.2	270

Note: 1.The other Spurious RF Radiated emissions level is no more than noise floor.
2.The worst emission was found in the antenna is vertical position.

GSM 850 CH-Middle

Harmonic	Frequency (MHz)	SG (dBm)	Cable Loss (dB)	Gain (dBi)	Antenna Polarization	ERP Level (dBm)	Limit (dBm)	Margin (dB)	Azimuth (deg)
2	1673	-53.6	2	10.75	Vertical	-47.0	-13.0	34.0	225
3	2498	-55.49	2.51	11.05	Vertical	-49.1	-13.0	36.1	135
4	3346	-56.6	4.2	11.15	Vertical	-51.8	-13.0	38.8	135
5	4183	-53	5.2	11.15	Vertical	-49.2	-13.0	36.2	45
6	5020	-50.4	5.5	11.95	Vertical	-46.1	-13.0	33.1	270
7	5856	-51	5.7	13.55	Vertical	-45.3	-13.0	32.3	180
8	6693	-49.6	6.3	13.75	Vertical	-44.3	-13.0	31.3	270
9	7529	-46.9	6.8	13.85	Vertical	-42.0	-13.0	29.0	135
10	8366	-47	6.9	14.25	Vertical	-41.8	-13.0	28.8	45

Note: 1.The other Spurious RF Radiated emissions level is no more than noise floor.
2.The worst emission was found in the antenna is vertical position.



GSM 850 CH-High

Harmonic	Frequency (MHz)	SG (dBm)	Cable Loss (dB)	Gain (dBi)	Antenna Polarization	ERP Level (dBm)	Limit (dBm)	Margin (dB)	Azimuth (deg)
2	1698	-58.4	2	10.15	Vertical	-52.4	-13.0	39.4	90
3	2546	-57.49	2.51	11.05	Vertical	-51.1	-13.0	38.1	45
4	3395	-57.7	4.2	11.15	Vertical	-52.9	-13.0	39.9	180
5	4244	-53.7	5.2	11.15	Vertical	-49.9	-13.0	36.9	270
6	5093	-50.7	5.5	11.95	Vertical	-46.4	-13.0	33.4	135
7	5942	-51.6	5.7	13.55	Vertical	-45.9	-13.0	32.9	45
8	6790	-49.6	6.3	13.75	Vertical	-44.3	-13.0	31.3	270
9	7639	-46.9	6.8	13.85	Vertical	-42.0	-13.0	29.0	180
10	8488	-46.4	6.9	14.25	Vertical	-41.2	-13.0	28.2	270

Note: 1.The other Spurious RF Radiated emissions level is no more than noise floor.

2.The worst emission was found in the antenna is vertical position.

LTE Band 5 1.4MHz CH-Low

Harmonic	Frequency (MHz)	SG (dBm)	Cable Loss (dB)	Gain (dBi)	Antenna Polarization	ERP Level (dBm)	Limit (dBm)	Margin (dB)	Azimuth (deg)
2	1649.4	-51.4	2.00	10.75	vertical	-44.8	-13.0	31.8	0
3	2474.1	-50.19	2.51	11.05	vertical	-43.8	-13.0	30.8	135
4	3298.8	-54.02	4.20	11.15	vertical	-49.22	-13.0	36.2	225
5	4123.5	-52.28	5.20	11.15	vertical	-48.48	-13.0	35.5	90
6	4948.2	-51.49	5.50	11.95	vertical	-47.19	-13.0	34.2	45
7	5772.9	-53.53	5.70	13.55	vertical	-47.83	-13.0	34.8	180
8	6597.6	-49	6.30	13.75	vertical	-43.70	-13.0	30.7	45
9	7422.3	-45.85	6.80	13.85	vertical	-40.95	-13.0	27.9	0
10	8247.0	-46.71	6.90	14.25	vertical	-41.51	-13.0	28.5	135

Note: 1.The other Spurious RF Radiated emissions level is no more than noise floor.

2.The worst emission was found in the antenna is vertical position.

LTE Band 5 1.4MHz CH-Middle

Harmonic	Frequency (MHz)	SG (dBm)	Cable Loss (dB)	Gain (dBi)	Antenna Polarization	ERP Level (dBm)	Limit (dBm)	Margin (dB)	Azimuth (deg)
2	1673.0	-50.4	2.00	10.75	vertical	-43.8	-13.0	30.8	225
3	2509.5	-54.09	2.51	11.05	vertical	-47.7	-13.0	34.7	315
4	3346.0	-54.15	4.20	11.15	vertical	-49.35	-13.0	36.3	45
5	4182.5	-52.83	5.20	11.15	vertical	-49.03	-13.0	36.0	0
6	5019.0	-52.27	5.50	11.95	vertical	-47.97	-13.0	35.0	135
7	5855.5	-51.23	5.70	13.55	vertical	-45.53	-13.0	32.5	225
8	6692.0	-51.64	6.30	13.75	vertical	-46.34	-13.0	33.3	90
9	7528.5	-46.57	6.80	13.85	vertical	-41.67	-13.0	28.7	45
10	8365.0	-48.16	6.90	14.25	vertical	-42.96	-13.0	30.0	180

Note: 1.The other Spurious RF Radiated emissions level is no more than noise floor.
 2.The worst emission was found in the antenna is vertical position.

LTE Band 5 1.4MHz CH-High

Harmonic	Frequency (MHz)	SG (dBm)	Cable Loss (dB)	Gain (dBi)	Antenna Polarization	ERP Level (dBm)	Limit (dBm)	Margin (dB)	Azimuth (deg)
2	1696.6	-46.4	2.00	10.75	vertical	-39.8	-13.0	26.8	45
3	2544.9	-53.39	2.51	11.05	vertical	-47.0	-13.0	34.0	0
4	3393.2	-53.33	4.20	11.15	vertical	-48.53	-13.0	35.5	135
5	4241.5	-51.5	5.20	11.15	vertical	-47.70	-13.0	34.7	225
6	5089.8	-49.5	5.50	11.95	vertical	-45.20	-13.0	32.2	315
7	5938.1	-51.84	5.70	13.55	vertical	-46.14	-13.0	33.1	45
8	6786.4	-49.44	6.30	13.75	vertical	-44.14	-13.0	31.1	0
9	7634.7	-47.51	6.80	13.85	vertical	-42.61	-13.0	29.6	135
10	8483.0	-47.72	6.90	14.25	vertical	-42.52	-13.0	29.5	225

Note: 1.The other Spurious RF Radiated emissions level is no more than noise floor.
 2.The worst emission was found in the antenna is vertical position.

LTE Band 5 3MHz CH-Low

Harmonic	Frequency (MHz)	SG (dBm)	Cable Loss (dB)	Gain (dBi)	Antenna Polarization	ERP Level (dBm)	Limit (dBm)	Margin (dB)	Azimuth (deg)
2	1648.3	-50.9	2.00	10.75	vertical	-44.3	-13.0	31.3	90
3	2476.5	-51.59	2.51	11.05	vertical	-45.2	-13.0	32.2	45
4	3302.0	-54.1	4.20	11.15	vertical	-49.3	-13.0	36.3	180
5	4127.5	-53	5.20	11.15	vertical	-49.2	-13.0	36.2	45
6	4953.0	-51.5	5.50	11.95	vertical	-47.2	-13.0	34.2	0
7	5778.5	-52.6	5.70	13.55	vertical	-46.9	-13.0	33.9	135
8	6604.0	-50.7	6.30	13.75	vertical	-45.4	-13.0	32.4	225
9	7429.5	-46.5	6.80	13.85	vertical	-41.6	-13.0	28.6	315
10	8255.0	-46.7	6.90	14.25	vertical	-41.5	-13.0	28.5	45

Note: 1.The other Spurious RF Radiated emissions level is no more than noise floor.

2.The worst emission was found in the antenna is vertical position.

LTE Band 5 3MHz CH-Middle

Harmonic	Frequency (MHz)	SG (dBm)	Cable Loss (dB)	Gain (dBi)	Antenna Polarization	ERP Level (dBm)	Limit (dBm)	Margin (dB)	Azimuth (deg)
2	1670.3	-50.3	2.00	10.75	vertical	-43.7	-13.0	30.7	0
3	2509.5	-54.09	2.51	11.05	vertical	-47.7	-13.0	34.7	135
4	3346.0	-54.5	4.20	11.15	vertical	-49.7	-13.0	36.7	225
5	4182.5	-53.4	5.20	11.15	vertical	-49.6	-13.0	36.6	90
6	5019.0	-51	5.50	11.95	vertical	-46.7	-13.0	33.7	45
7	5855.5	-51.7	5.70	13.55	vertical	-46.0	-13.0	33.0	180
8	6692.0	-51	6.30	13.75	vertical	-45.7	-13.0	32.7	45
9	7528.5	-47.3	6.80	13.85	vertical	-42.4	-13.0	29.4	0
10	8365.0	-48.3	6.90	14.25	vertical	-43.1	-13.0	30.1	45

Note: 1.The other Spurious RF Radiated emissions level is no more than noise floor.

2.The worst emission was found in the antenna is vertical position.



LTE Band 5 3MHz CH-High

Harmonic	Frequency (MHz)	SG (dBm)	Cable Loss (dB)	Gain (dBi)	Antenna Polarization	ERP Level (dBm)	Limit (dBm)	Margin (dB)	Azimuth (deg)
2	1692.5	-47.2	2.00	10.75	vertical	-40.6	-13.0	27.6	0
3	2542.5	-54.39	2.51	11.05	vertical	-48.0	-13.0	35.0	135
4	3390.0	-55.1	4.20	11.15	vertical	-50.3	-13.0	37.3	225
5	4237.5	-52.5	5.20	11.15	vertical	-48.7	-13.0	35.7	90
6	5085.0	-50.2	5.50	11.95	vertical	-45.9	-13.0	32.9	45
7	5932.5	-51.9	5.70	13.55	vertical	-46.2	-13.0	33.2	180
8	6780.0	-49.7	6.30	13.75	vertical	-44.4	-13.0	31.4	45
9	7627.5	-48.9	6.80	13.85	vertical	-44.0	-13.0	31.0	0
10	8475.0	-48	6.90	14.25	vertical	-42.8	-13.0	29.8	135

Note: 1.The other Spurious RF Radiated emissions level is no more than noise floor.

2.The worst emission was found in the antenna is vertical position.

LTE Band 5 5MHz CH-Low

Harmonic	Frequency (MHz)	SG (dBm)	Cable Loss (dB)	Gain (dBi)	Antenna Polarization	ERP Level (dBm)	Limit (dBm)	Margin (dB)	Azimuth (deg)
2	1649.6	-50.4	2.00	10.75	vertical	-43.8	-13.0	30.8	45
3	2479.5	-49.59	2.51	11.05	vertical	-43.2	-13.0	30.2	0
4	3306.0	-52.3	4.20	11.15	vertical	-47.5	-13.0	34.5	135
5	4132.5	-53.6	5.20	11.15	vertical	-49.8	-13.0	36.8	225
6	4959.0	-52.2	5.50	11.95	vertical	-47.9	-13.0	34.9	90
7	5785.5	-51.6	5.70	13.55	vertical	-45.9	-13.0	32.9	45
8	6612.0	-49.8	6.30	13.75	vertical	-44.5	-13.0	31.5	180
9	7438.5	-45.7	6.80	13.85	vertical	-40.8	-13.0	27.8	45
10	8265.0	-48.4	6.90	14.25	vertical	-43.2	-13.0	30.2	0

Note: 1.The other Spurious RF Radiated emissions level is no more than noise floor.

2.The worst emission was found in the antenna is vertical position.



LTE Band 5 5MHz CH-Middle

Harmonic	Frequency (MHz)	SG (dBm)	Cable Loss (dB)	Gain (dBi)	Antenna Polarization	ERP Level (dBm)	Limit (dBm)	Margin (dB)	Azimuth (deg)
2	1673.0	-50.2	2.00	10.75	vertical	-43.6	-13.0	30.6	135
3	2509.5	-53.99	2.51	11.05	vertical	-47.6	-13.0	34.6	225
4	3346.0	-54.2	4.20	11.15	vertical	-49.4	-13.0	36.4	90
5	4182.5	-52.3	5.20	11.15	vertical	-48.5	-13.0	35.5	45
6	5019.0	-50	5.50	11.95	vertical	-45.7	-13.0	32.7	180
7	5855.5	-51.9	5.70	13.55	vertical	-46.2	-13.0	33.2	45
8	6692.0	-49.9	6.30	13.75	vertical	-44.6	-13.0	31.6	0
9	7528.5	-45.3	6.80	13.85	vertical	-40.4	-13.0	27.4	45
10	8365.0	-47.3	6.90	14.25	vertical	-42.1	-13.0	29.1	0

Note: 1.The other Spurious RF Radiated emissions level is no more than noise floor.
2.The worst emission was found in the antenna is vertical position.

LTE Band 5 5MHz CH-High

Harmonic	Frequency (MHz)	SG (dBm)	Cable Loss (dB)	Gain (dBi)	Antenna Polarization	ERP Level (dBm)	Limit (dBm)	Margin (dB)	Azimuth (deg)
2	1693.0	-46	2.00	10.75	vertical	-39.4	-13.0	26.4	135
3	2539.5	-55.09	2.51	11.05	vertical	-48.7	-13.0	35.7	225
4	3386.0	-54.8	4.20	11.15	vertical	-50.0	-13.0	37.0	90
5	4232.5	-53.5	5.20	11.15	vertical	-49.7	-13.0	36.7	45
6	5079.0	-49	5.50	11.95	vertical	-44.7	-13.0	31.7	180
7	5925.5	-52.5	5.70	13.55	vertical	-46.8	-13.0	33.8	45
8	6772.0	-50.5	6.30	13.75	vertical	-45.2	-13.0	32.2	0
9	7618.5	-45	6.80	13.85	vertical	-40.1	-13.0	27.1	45
10	8465.0	-47.2	6.90	14.25	vertical	-42.0	-13.0	29.0	0

Note: 1.The other Spurious RF Radiated emissions level is no more than noise floor.
2.The worst emission was found in the antenna is vertical position.



LTE Band 5 10MHz CH-Low

Harmonic	Frequency (MHz)	SG (dBm)	Cable Loss (dB)	Gain (dBi)	Antenna Polarization	ERP Level (dBm)	Limit (dBm)	Margin (dB)	Azimuth (deg)
2	1658.0	-51.4	2.00	10.75	vertical	-44.8	-13.0	31.8	135
3	2487.0	-50.89	2.51	11.05	vertical	-44.5	-13.0	31.5	225
4	3316.0	-53.7	4.20	11.15	vertical	-48.9	-13.0	35.9	90
5	4145.0	-52.7	5.20	11.15	vertical	-48.9	-13.0	35.9	45
6	4974.0	-51.9	5.50	11.95	vertical	-47.6	-13.0	34.6	180
7	5803.0	-50.2	5.70	13.55	vertical	-44.5	-13.0	31.5	45
8	6632.0	-48.9	6.30	13.75	vertical	-43.6	-13.0	30.6	0
9	7461.0	-47.3	6.80	13.85	vertical	-42.4	-13.0	29.4	135
10	8290.0	-47.8	6.90	14.25	vertical	-42.6	-13.0	29.6	45

Note: 1.The other Spurious RF Radiated emissions level is no more than noise floor.
2.The worst emission was found in the antenna is vertical position.

LTE Band 5 10MHz CH-Middle

Harmonic	Frequency (MHz)	SG (dBm)	Cable Loss (dB)	Gain (dBi)	Antenna Polarization	ERP Level (dBm)	Limit (dBm)	Margin (dB)	Azimuth (deg)
2	1673.0	-51.1	2.00	10.75	vertical	-44.5	-13.0	31.5	0
3	2509.5	-54.39	2.51	11.05	vertical	-48.0	-13.0	35.0	135
4	3346.0	-53.8	4.20	11.15	vertical	-49.0	-13.0	36.0	225
5	4182.5	-52.4	5.20	11.15	vertical	-48.6	-13.0	35.6	90
6	5019.0	-49.7	5.50	11.95	vertical	-45.4	-13.0	32.4	45
7	5855.5	-51.3	5.70	13.55	vertical	-45.6	-13.0	32.6	180
8	6692.0	-48.5	6.30	13.75	vertical	-43.2	-13.0	30.2	45
9	7528.5	-46.4	6.80	13.85	vertical	-41.5	-13.0	28.5	0
10	8365.0	-48	6.90	14.25	vertical	-42.8	-13.0	29.8	45

Note: 1.The other Spurious RF Radiated emissions level is no more than noise floor.
2.The worst emission was found in the antenna is vertical position.

LTE Band 5 10MHz CH-High

Harmonic	Frequency (MHz)	SG (dBm)	Cable Loss (dB)	Gain (dBi)	Antenna Polarization	ERP Level (dBm)	Limit (dBm)	Margin (dB)	Azimuth (deg)
2	1688.0	-47.7	2.00	10.75	vertical	-41.1	-13.0	28.1	0
3	2532.0	-52.79	2.51	11.05	vertical	-46.4	-13.0	33.4	135
4	3376.0	-52.4	4.20	11.15	vertical	-47.6	-13.0	34.6	225
5	4220.0	-52.1	5.20	11.15	vertical	-48.3	-13.0	35.3	90
6	5064.0	-49.9	5.50	11.95	vertical	-45.6	-13.0	32.6	45
7	5908.0	-51.5	5.70	13.55	vertical	-45.8	-13.0	32.8	180
8	6752.0	-49.2	6.30	13.75	vertical	-43.9	-13.0	30.9	45
9	7596.0	-46.9	6.80	13.85	vertical	-42.0	-13.0	29.0	0
10	8440.0	-48.2	6.90	14.25	vertical	-43.0	-13.0	30.0	135

Note: 1.The other Spurious RF Radiated emissions level is no more than noise floor.

2.The worst emission was found in the antenna is vertical position.

LTE Band 26 1.4MHz CH-Low

Harmonic	Frequency (MHz)	SG (dBm)	Cable Loss (dB)	Gain (dBi)	Antenna Polarization	ERP Level (dBm)	Limit (dBm)	Margin (dB)	Azimuth (deg)
2	1629.40	-51.5	2.00	10.75	vertical	-44.9	-13.0	31.9	90
3	2444.10	-50.89	2.51	11.05	vertical	-44.5	-13.0	31.5	45
4	3258.80	-56	4.20	11.15	vertical	-51.2	-13.0	38.2	180
5	4073.50	-52.5	5.20	11.15	vertical	-48.7	-13.0	35.7	225
6	4888.20	-51.1	5.50	11.95	vertical	-46.8	-13.0	33.8	135
7	5702.90	-51.9	5.70	13.55	vertical	-46.2	-13.0	33.2	90
8	6517.60	-50	6.30	13.75	vertical	-44.7	-13.0	31.7	45
9	7332.30	-45.8	6.80	13.85	vertical	-40.9	-13.0	27.9	180
10	8147.00	-46.5	6.90	14.25	vertical	-41.3	-13.0	28.3	225

Note: 1.The other Spurious RF Radiated emissions level is no more than noise floor.

2.The worst emission was found in the antenna is vertical position.



LTE Band 26 1.4MHz CH-Middle

Harmonic	Frequency (MHz)	SG (dBm)	Cable Loss (dB)	Gain (dBi)	Antenna Polarization	ERP Level (dBm)	Limit (dBm)	Margin (dB)	Azimuth (deg)
2	1663.00	-49.6	2.00	10.75	vertical	-43.0	-13.0	30.0	135
3	2494.50	-54.19	2.51	11.05	vertical	-47.8	-13.0	34.8	90
4	3326.00	-55.4	4.20	11.15	vertical	-50.6	-13.0	37.6	45
5	4157.50	-52.8	5.20	11.15	vertical	-49.0	-13.0	36.0	180
6	4989.00	-49.6	5.50	11.95	vertical	-45.3	-13.0	32.3	225
7	5820.50	-51.8	5.70	13.55	vertical	-46.1	-13.0	33.1	135
8	6652.00	-48.9	6.30	13.75	vertical	-43.6	-13.0	30.6	90
9	7483.50	-46.4	6.80	13.85	vertical	-41.5	-13.0	28.5	45
10	8315.00	-46.6	6.90	14.25	vertical	-41.4	-13.0	28.4	180

Note: 1.The other Spurious RF Radiated emissions level is no more than noise floor.
2.The worst emission was found in the antenna is vertical position.

LTE Band 26 1.4MHz CH-High

Harmonic	Frequency (MHz)	SG (dBm)	Cable Loss (dB)	Gain (dBi)	Antenna Polarization	ERP Level (dBm)	Limit (dBm)	Margin (dB)	Azimuth (deg)
2	1696.60	-47.4	2.00	10.75	vertical	-40.8	-13.0	27.8	225
3	2544.90	-53.69	2.51	11.05	vertical	-47.3	-13.0	34.3	135
4	3393.20	-56.3	4.20	11.15	vertical	-51.5	-13.0	38.5	90
5	4241.50	-52.1	5.20	11.15	vertical	-48.3	-13.0	35.3	45
6	5089.80	-50.5	5.50	11.95	vertical	-46.2	-13.0	33.2	180
7	5938.10	-51.3	5.70	13.55	vertical	-45.6	-13.0	32.6	225
8	6786.40	-49.4	6.30	13.75	vertical	-44.1	-13.0	31.1	135
9	7634.70	-46.7	6.80	13.85	vertical	-41.8	-13.0	28.8	90
10	8483.00	-47.4	6.90	14.25	vertical	-42.2	-13.0	29.2	45

Note: 1.The other Spurious RF Radiated emissions level is no more than noise floor.
2.The worst emission was found in the antenna is vertical position.



LTE Band 26 3MHz CH-Low

Harmonic	Frequency (MHz)	SG (dBm)	Cable Loss (dB)	Gain (dBi)	Antenna Polarization	ERP Level (dBm)	Limit (dBm)	Margin (dB)	Azimuth (deg)
2	1631.00	-50.4	2.00	10.75	vertical	-43.8	-13.0	30.8	180
3	2446.50	-50.59	2.51	11.05	vertical	-44.2	-13.0	31.2	225
4	3262.00	-56.3	4.20	11.15	vertical	-51.5	-13.0	38.5	135
5	4077.50	-52.5	5.20	11.15	vertical	-48.7	-13.0	35.7	90
6	4893.00	-51	5.50	11.95	vertical	-46.7	-13.0	33.7	45
7	5708.50	-52.2	5.70	13.55	vertical	-46.5	-13.0	33.5	180
8	6524.00	-50	6.30	13.75	vertical	-44.7	-13.0	31.7	225
9	7339.50	-45.3	6.80	13.85	vertical	-40.4	-13.0	27.4	135
10	8155.00	-47	6.90	14.25	vertical	-41.8	-13.0	28.8	90

Note: 1.The other Spurious RF Radiated emissions level is no more than noise floor.
2.The worst emission was found in the antenna is vertical position.

LTE Band 26 3MHz CH-Middle

Harmonic	Frequency (MHz)	SG (dBm)	Cable Loss (dB)	Gain (dBi)	Antenna Polarization	ERP Level (dBm)	Limit (dBm)	Margin (dB)	Azimuth (deg)
2	1663.00	-50.5	2.00	10.75	vertical	-43.9	-13.0	30.9	45
3	2494.50	-53.09	2.51	11.05	vertical	-46.7	-13.0	33.7	180
4	3326.00	-56.4	4.20	11.15	vertical	-51.6	-13.0	38.6	225
5	4157.50	-52.6	5.20	11.15	vertical	-48.8	-13.0	35.8	135
6	4989.00	-49.7	5.50	11.95	vertical	-45.4	-13.0	32.4	90
7	5820.50	-52.5	5.70	13.55	vertical	-46.8	-13.0	33.8	45
8	6652.00	-48.9	6.30	13.75	vertical	-43.6	-13.0	30.6	180
9	7483.50	-46.4	6.80	13.85	vertical	-41.5	-13.0	28.5	225
10	8315.00	-46.8	6.90	14.25	vertical	-41.6	-13.0	28.6	135

Note: 1.The other Spurious RF Radiated emissions level is no more than noise floor.
2.The worst emission was found in the antenna is vertical position.

LTE Band 26 3MHz CH-High

Harmonic	Frequency (MHz)	SG (dBm)	Cable Loss (dB)	Gain (dBi)	Antenna Polarization	ERP Level (dBm)	Limit (dBm)	Margin (dB)	Azimuth (deg)
2	1695.00	-46.4	2.00	10.75	vertical	-39.8	-13.0	26.8	90
3	2542.50	-53.79	2.51	11.05	vertical	-47.4	-13.0	34.4	45
4	3390.00	-56.3	4.20	11.15	vertical	-51.5	-13.0	38.5	180
5	4237.50	-52.5	5.20	11.15	vertical	-48.7	-13.0	35.7	225
6	5085.00	-50.5	5.50	11.95	vertical	-46.2	-13.0	33.2	135
7	5932.50	-51.5	5.70	13.55	vertical	-45.8	-13.0	32.8	90
8	6780.00	-48.4	6.30	13.75	vertical	-43.1	-13.0	30.1	45
9	7627.50	-46.1	6.80	13.85	vertical	-41.2	-13.0	28.2	180
10	8475.00	-47.4	6.90	14.25	vertical	-42.2	-13.0	29.2	225

Note: 1.The other Spurious RF Radiated emissions level is no more than noise floor.

2.The worst emission was found in the antenna is vertical position.

LTE Band 26 5MHz CH-Low

Harmonic	Frequency (MHz)	SG (dBm)	Cable Loss (dB)	Gain (dBi)	Antenna Polarization	ERP Level (dBm)	Limit (dBm)	Margin (dB)	Azimuth (deg)
2	1633.00	-50.5	2.00	10.75	vertical	-43.9	-13.0	30.9	135
3	2449.50	-49.59	2.51	11.05	vertical	-43.2	-13.0	30.2	90
4	3266.00	-55.9	4.20	11.15	vertical	-51.1	-13.0	38.1	45
5	4082.50	-52.4	5.20	11.15	vertical	-48.6	-13.0	35.6	180
6	4899.00	-51	5.50	11.95	vertical	-46.7	-13.0	33.7	225
7	5715.50	-52.3	5.70	13.55	vertical	-46.6	-13.0	33.6	135
8	6532.00	-50	6.30	13.75	vertical	-44.7	-13.0	31.7	90
9	7348.50	-46.3	6.80	13.85	vertical	-41.4	-13.0	28.4	45
10	8165.00	-46.4	6.90	14.25	vertical	-41.2	-13.0	28.2	180

Note: 1.The other Spurious RF Radiated emissions level is no more than noise floor.

2.The worst emission was found in the antenna is vertical position.



LTE Band 26 5MHz CH-Middle

Harmonic	Frequency (MHz)	SG (dBm)	Cable Loss (dB)	Gain (dBi)	Antenna Polarization	ERP Level (dBm)	Limit (dBm)	Margin (dB)	Azimuth (deg)
2	1663.00	-50.3	2.00	10.75	vertical	-43.7	-13.0	30.7	225
3	2494.50	-53.59	2.51	11.05	vertical	-47.2	-13.0	34.2	135
4	3326.00	-55.9	4.20	11.15	vertical	-51.1	-13.0	38.1	90
5	4157.50	-52.2	5.20	11.15	vertical	-48.4	-13.0	35.4	45
6	4989.00	-50.7	5.50	11.95	vertical	-46.4	-13.0	33.4	180
7	5820.50	-52.5	5.70	13.55	vertical	-46.8	-13.0	33.8	225
8	6652.00	-48.4	6.30	13.75	vertical	-43.1	-13.0	30.1	135
9	7483.50	-46.4	6.80	13.85	vertical	-41.5	-13.0	28.5	90
10	8315.00	-46.3	6.90	14.25	vertical	-41.1	-13.0	28.1	45

Note: 1.The other Spurious RF Radiated emissions level is no more than noise floor.

2.The worst emission was found in the antenna is vertical position.

LTE Band 26 5MHz CH-High

Harmonic	Frequency (MHz)	SG (dBm)	Cable Loss (dB)	Gain (dBi)	Antenna Polarization	ERP Level (dBm)	Limit (dBm)	Margin (dB)	Azimuth (deg)
2	1693.00	-46.7	2.00	10.75	vertical	-40.1	-13.0	27.1	180
3	2539.50	-53.09	2.51	11.05	vertical	-46.7	-13.0	33.7	225
4	3386.00	-56.6	4.20	11.15	vertical	-51.8	-13.0	38.8	135
5	4232.50	-52.5	5.20	11.15	vertical	-48.7	-13.0	35.7	90
6	5079.00	-50.5	5.50	11.95	vertical	-46.2	-13.0	33.2	45
7	5925.50	-51	5.70	13.55	vertical	-45.3	-13.0	32.3	180
8	6772.00	-48.4	6.30	13.75	vertical	-43.1	-13.0	30.1	225
9	7618.50	-46.7	6.80	13.85	vertical	-41.8	-13.0	28.8	135
10	8465.00	-47.4	6.90	14.25	vertical	-42.2	-13.0	29.2	90

Note: 1.The other Spurious RF Radiated emissions level is no more than noise floor.

2.The worst emission was found in the antenna is vertical position.

LTE Band 26 10MHz CH-Low

Harmonic	Frequency (MHz)	SG (dBm)	Cable Loss (dB)	Gain (dBi)	Antenna Polarization	ERP Level (dBm)	Limit (dBm)	Margin (dB)	Azimuth (deg)
2	1640.00	-51.7	2.00	10.75	vertical	-45.1	-13.0	32.1	45
3	2460.00	-52.09	2.51	11.05	vertical	-45.7	-13.0	32.7	180
4	3280.00	-56.3	4.20	11.15	vertical	-51.5	-13.0	38.5	225
5	4100.00	-52	5.20	11.15	vertical	-48.2	-13.0	35.2	135
6	4920.00	-50.8	5.50	11.95	vertical	-46.5	-13.0	33.5	90
7	5740.00	-50.8	5.70	13.55	vertical	-45.1	-13.0	32.1	45
8	6560.00	-50	6.30	13.75	vertical	-44.7	-13.0	31.7	180
9	7380.00	-45.3	6.80	13.85	vertical	-40.4	-13.0	27.4	225
10	8200.00	-47	6.90	14.25	vertical	-41.8	-13.0	28.8	135

Note: 1.The other Spurious RF Radiated emissions level is no more than noise floor.

2.The worst emission was found in the antenna is vertical position.

LTE Band 26 10MHz CH-Middle

Harmonic	Frequency (MHz)	SG (dBm)	Cable Loss (dB)	Gain (dBi)	Antenna Polarization	ERP Level (dBm)	Limit (dBm)	Margin (dB)	Azimuth (deg)
2	1663.00	-52.2	2.00	10.75	vertical	-45.6	-13.0	32.6	90
3	2494.50	-55.39	2.51	11.05	vertical	-49.0	-13.0	36.0	45
4	3326.00	-55.4	4.20	11.15	vertical	-50.6	-13.0	37.6	180
5	4157.50	-52.8	5.20	11.15	vertical	-49.0	-13.0	36.0	225
6	4989.00	-50	5.50	11.95	vertical	-45.7	-13.0	32.7	135
7	5820.50	-51.8	5.70	13.55	vertical	-46.1	-13.0	33.1	90
8	6652.00	-48.9	6.30	13.75	vertical	-43.6	-13.0	30.6	45
9	7483.50	-46.3	6.80	13.85	vertical	-41.4	-13.0	28.4	180
10	8315.00	-46.6	6.90	14.25	vertical	-41.4	-13.0	28.4	225

Note: 1.The other Spurious RF Radiated emissions level is no more than noise floor.

2.The worst emission was found in the antenna is vertical position.



LTE Band 26 10MHz CH-High

Harmonic	Frequency (MHz)	SG (dBm)	Cable Loss (dB)	Gain (dBi)	Antenna Polarization	ERP Level (dBm)	Limit (dBm)	Margin (dB)	Azimuth (deg)
2	1688.00	-48.8	2.00	10.75	vertical	-42.2	-13.0	29.2	135
3	2532.00	-54.19	2.51	11.05	vertical	-47.8	-13.0	34.8	90
4	3376.00	-56	4.20	11.15	vertical	-51.2	-13.0	38.2	45
5	4220.00	-52.5	5.20	11.15	vertical	-48.7	-13.0	35.7	180
6	5064.00	-50.5	5.50	11.95	vertical	-46.2	-13.0	33.2	225
7	5908.00	-51	5.70	13.55	vertical	-45.3	-13.0	32.3	135
8	6752.00	-49.2	6.30	13.75	vertical	-43.9	-13.0	30.9	90
9	7596.00	-46.7	6.80	13.85	vertical	-41.8	-13.0	28.8	45
10	8440.00	-46.4	6.90	14.25	vertical	-41.2	-13.0	28.2	180

Note: 1.The other Spurious RF Radiated emissions level is no more than noise floor.
2.The worst emission was found in the antenna is vertical position.

LTE Band 26 15MHz CH-Low

Harmonic	Frequency (MHz)	SG (dBm)	Cable Loss (dB)	Gain (dBi)	Antenna Polarization	ERP Level (dBm)	Limit (dBm)	Margin (dB)	Azimuth (deg)
2	1645.00	-52.1	2.00	10.75	vertical	-45.5	-13.0	32.5	225
3	2467.50	-49.99	2.51	11.05	vertical	-43.6	-13.0	30.6	135
4	3290.00	-56.7	4.20	11.15	vertical	-51.9	-13.0	38.9	90
5	4112.50	-52	5.20	11.15	vertical	-48.2	-13.0	35.2	45
6	4935.00	-50.8	5.50	11.95	vertical	-46.5	-13.0	33.5	180
7	5757.50	-51.4	5.70	13.55	vertical	-45.7	-13.0	32.7	225
8	6580.00	-50	6.30	13.75	vertical	-44.7	-13.0	31.7	135
9	7402.50	-46.3	6.80	13.85	vertical	-41.4	-13.0	28.4	90
10	8225.00	-46	6.90	14.25	vertical	-40.8	-13.0	27.8	45

Note: 1.The other Spurious RF Radiated emissions level is no more than noise floor.
2.The worst emission was found in the antenna is vertical position.

LTE Band 26 10MHz CH-Middle

Harmonic	Frequency (MHz)	SG (dBm)	Cable Loss (dB)	Gain (dBi)	Antenna Polarization	ERP Level (dBm)	Limit (dBm)	Margin (dB)	Azimuth (deg)
2	1663.00	-51.7	2.00	10.75	vertical	-45.1	-13.0	32.1	180
3	2494.50	-53.79	2.51	11.05	vertical	-47.4	-13.0	34.4	225
4	3326.00	-56.4	4.20	11.15	vertical	-51.6	-13.0	38.6	135
5	4157.50	-52.8	5.20	11.15	vertical	-49.0	-13.0	36.0	90
6	4989.00	-49.6	5.50	11.95	vertical	-45.3	-13.0	32.3	45
7	5820.50	-52.5	5.70	13.55	vertical	-46.8	-13.0	33.8	180
8	6652.00	-48.9	6.30	13.75	vertical	-43.6	-13.0	30.6	225
9	7483.50	-47.3	6.80	13.85	vertical	-42.4	-13.0	29.4	135
10	8315.00	-46.6	6.90	14.25	vertical	-41.4	-13.0	28.4	90

Note: 1.The other Spurious RF Radiated emissions level is no more than noise floor.

2.The worst emission was found in the antenna is vertical position.

LTE Band 26 15MHz CH-High

Harmonic	Frequency (MHz)	SG (dBm)	Cable Loss (dB)	Gain (dBi)	Antenna Polarization	ERP Level (dBm)	Limit (dBm)	Margin (dB)	Azimuth (deg)
2	1683.00	-50	2.00	10.75	vertical	-43.4	-13.0	30.4	45
3	2524.50	-55.89	2.51	11.05	vertical	-49.5	-13.0	36.5	180
4	3366.00	-56.4	4.20	11.15	vertical	-51.6	-13.0	38.6	225
5	4207.50	-52.5	5.20	11.15	vertical	-48.7	-13.0	35.7	135
6	5049.00	-50.9	5.50	11.95	vertical	-46.6	-13.0	33.6	90
7	5890.50	-51	5.70	13.55	vertical	-45.3	-13.0	32.3	45
8	6732.00	-48.6	6.30	13.75	vertical	-43.3	-13.0	30.3	180
9	7573.50	-46.7	6.80	13.85	vertical	-41.8	-13.0	28.8	225
10	8415.00	-45.4	6.90	14.25	vertical	-40.2	-13.0	27.2	135

Note: 1.The other Spurious RF Radiated emissions level is no more than noise floor.

2.The worst emission was found in the antenna is vertical position.

6. Main Test Instruments

Name	Manufacturer	Type	Serial Number	Calibration Date	Expiration Time
Base Station Simulator	R&S	CMW500	150415	2017-05-14	2018-05-13
Power Splitter	Hua Xiang	SHX-GF2-2-13	10120101	2017-05-14	2018-05-13
Spectrum Analyzer	Agilent	N9010A	MY47191109	2017-05-20	2018-05-19
Universal Radio Communication Tester	Agilent	E5515C	MY48367192	2017-05-20	2018-05-19
Signal Analyzer	R&S	FSV30	100815	2016-12-16	2017-12-15
EMI Test Receiver	R&S	ESCI	100948	2017-05-20	2018-05-19
Signal generator	R&S	SMB 100A	102594	2017-05-14	2018-05-13
Signal generator	R&S	SMR27	100365	2017-05-14	2018-05-13
Trilog Antenna	SCHWARZBECK	VUBL 9163	9163-201	2014-12-06	2017-12-05
Horn Antenna	R&S	HF907	100126	2014-12-06	2017-12-05
Horn Antenna	ETS-Lindgren	3160-09	00102644	2015-01-30	2018-01-29
Climatic Chamber	Re Ce	PT-30B	20101891	2015-07-18	2018-07-17
RF Cable	Agilent	SMA 15cm	0001	2017-02-06	2017-08-05
Preamplifier	R&S	SCU18	102327	2017-06-18	2018-06-17

*****END OF REPORT *****

ANNEX A: EUT Appearance and Test Setup

A.1 EUT Appearance

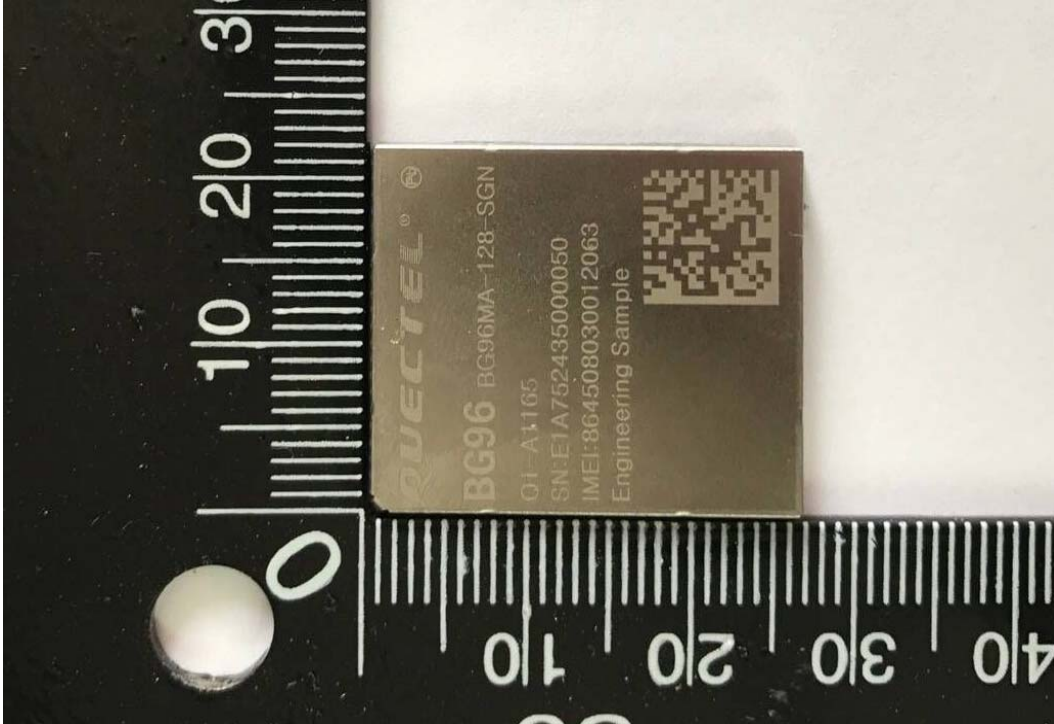

sheilding

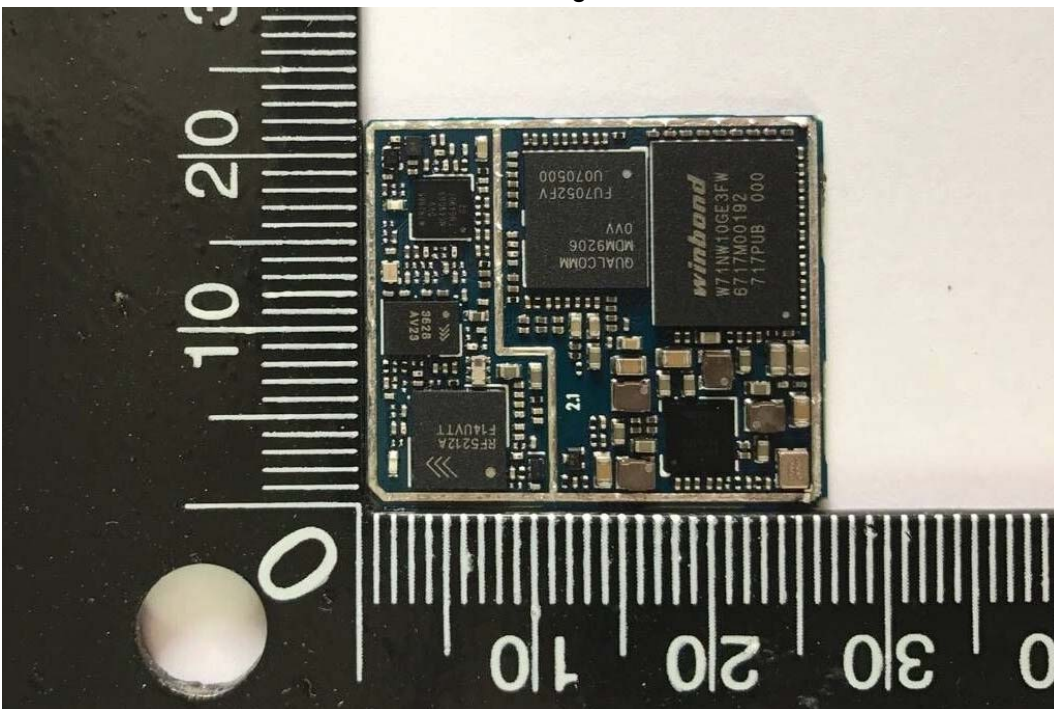

No sheilding
Front Side

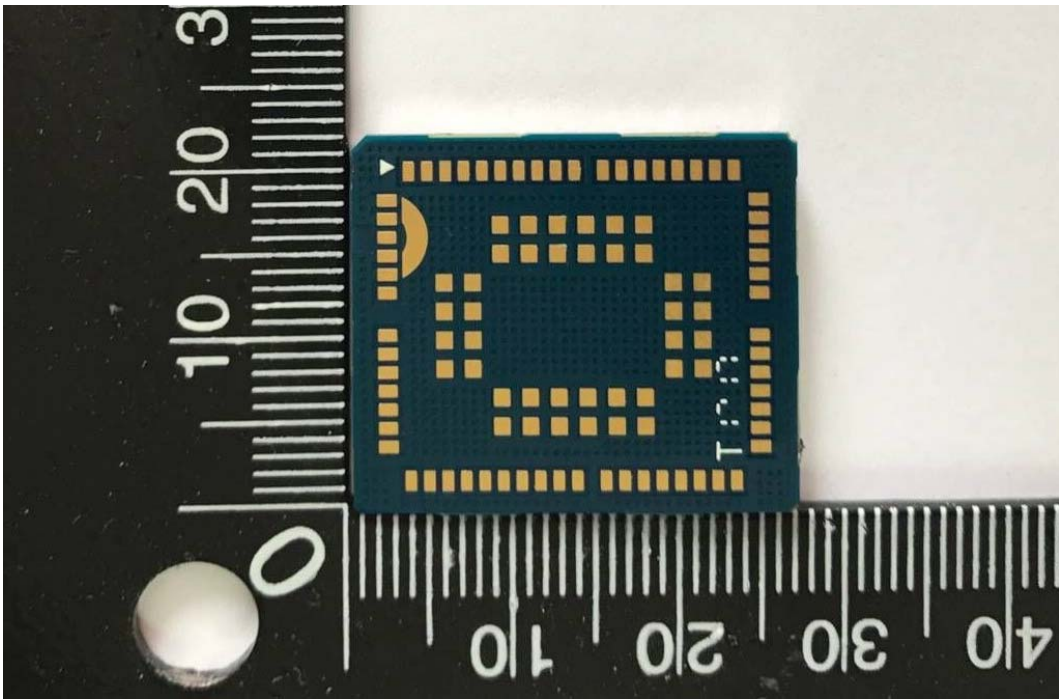

Back Side
a: EUT

A.2 Test Setup

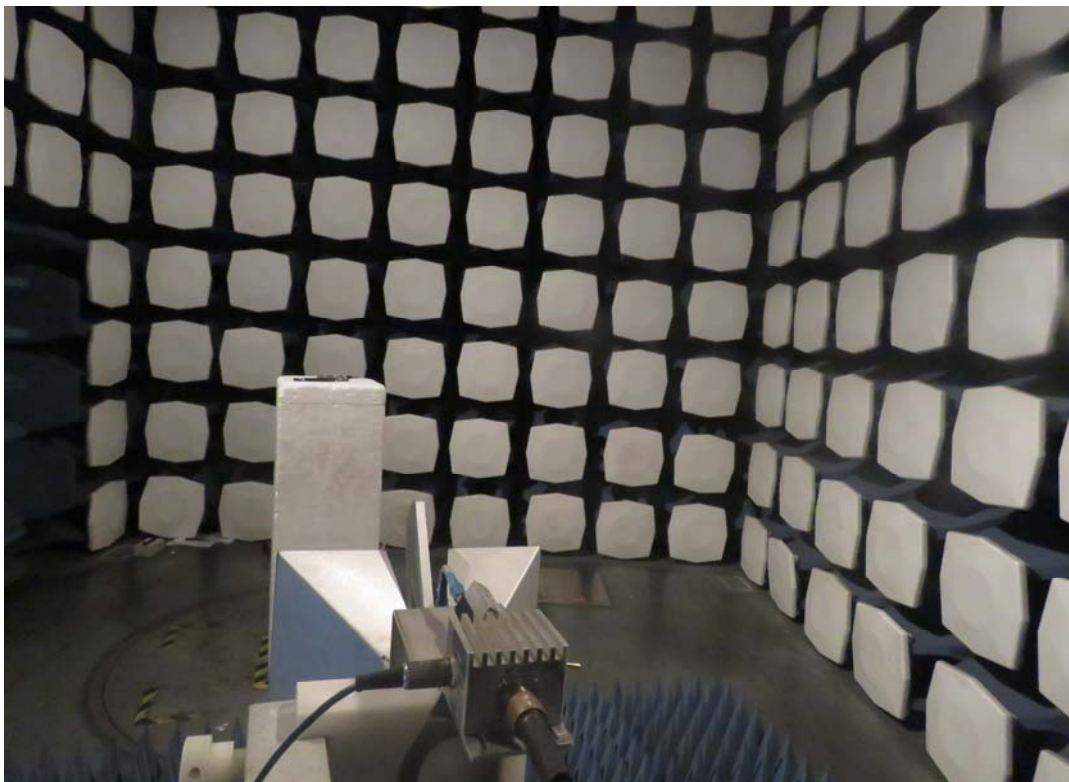
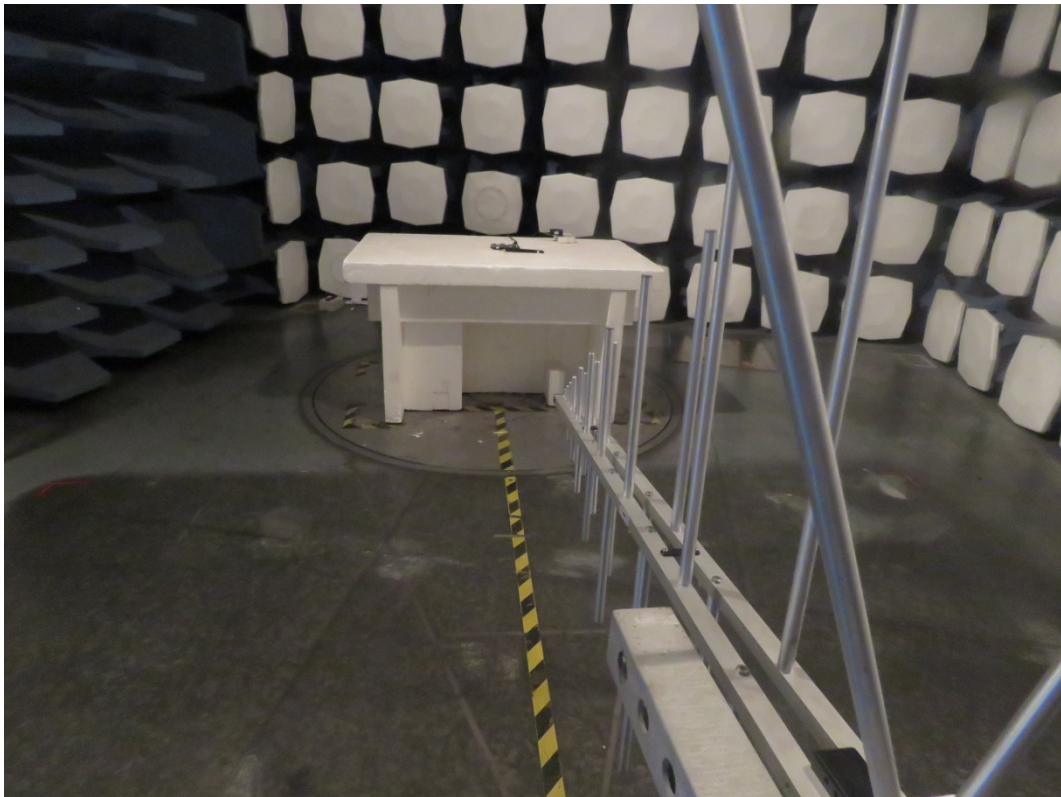

Picture 2: Radiated Spurious Emissions Test setup