



BUREAU VERITAS

Test Report No.: RF190701W004-2



ACCREDITED
Certificate # 3939.01

FCC TEST REPORT (PART 24)



Applicant:	ThingsMatrix Inc.
Address:	9442 North Capital of Texas Hwy, Plaza One, Suite 500, Austin, TX 78759

Manufacturer or Supplier:	ThingsMatrix Inc.
Address:	9442 North Capital of Texas Hwy, Plaza One, Suite 500, Austin, TX 78759
Product:	IoT Wireless Device
Brand Name:	ThingsMatrix
Model Name:	TMX08
FCC ID:	2ATV9TMX08
Date of tests:	Jul. 02, 2019 ~ Jul. 22, 2019

The tests have been carried out according to the requirements of the following standard:

- FCC PART 24, Subpart E ANSI C63.26-2015
- ANSI/TIA/EIA-603-D ANSI/TIA/EIA-603-E

CONCLUSION: The submitted sample was found to COMPLY with the test requirement

Prepared by Alex Chen Engineer / Mobile Department	Approved by Luke Lu Manager / Mobile Department
 Date: Jul. 24, 2019	 Date: Jul. 24, 2019

This report is governed by, and incorporates by reference, CPS Conditions of Service as posted at the date of issuance of this report at <http://www.bureauveritas.com/home/about-us/our-business/cps/about-us/terms-conditions> and is intended for your exclusive use. Any copying or replication of this report to or for any other person or entity, or use of our name or trademark, is permitted only with our prior written permission. This report sets forth our findings solely with respect to the test samples identified herein. The results set forth in this report are not indicative or representative of the quality or characteristics of the lot from which a test sample was taken or any similar or identical product unless specifically and expressly noted. Our report includes all of the tests requested by you and the results thereof based upon the information that you provided to us. Measurement uncertainty is only provided upon request for accredited tests. You have 60 days from date of issuance of this report to notify us of any material error or omission caused by our negligence or if you require measurement uncertainty; provided, however, that such notice shall be in writing and shall specifically address the issue you wish to raise. A failure to raise such issue within the prescribed time shall constitute your unqualified acceptance of the completeness of this report, the tests conducted and the correctness of the report contents.



TABLE OF CONTENTS

RELEASE CONTROL RECORD 4

1 SUMMARY OF TEST RESULTS 5

1.1 MEASUREMENT UNCERTAINTY 5

1.2 TEST SITE AND INSTRUMENTS 6

2 GENERAL INFORMATION 7

2.1 GENERAL DESCRIPTION OF EUT 7

2.2 CONFIGURATION OF SYSTEM UNDER TEST 9

2.4 TEST ITEM AND TEST CONFIGURATION 10

2.5 EUT OPERATING CONDITIONS 12

2.6 GENERAL DESCRIPTION OF APPLIED STANDARDS 12

3 TEST TYPES AND RESULTS 13

3.1 OUTPUT POWER MEASUREMENT 13

3.1.1 LIMITS OF OUTPUT POWER MEASUREMENT 13

3.1.2 TEST PROCEDURES 13

3.1.3 TEST SETUP 14

3.1.4 TEST RESULTS 15

3.2 FREQUENCY STABILITY MEASUREMENT 21

3.2.1 LIMITS OF FREQUENCY STABILITY MEASUREMENT 21

3.2.2 TEST PROCEDURE 21

3.2.3 TEST SETUP 21

3.2.4 TEST RESULTS 21

3.3 OCCUPIED BANDWIDTH MEASUREMENT 22

3.3.1 TEST PROCEDURES 22

3.3.2 TEST SETUP 22

3.3.3 TEST RESULTS 22

3.4 BAND EDGE MEASUREMENT 23

3.4.1 LIMITS OF BAND EDGE MEASUREMENT 23

3.4.2 TEST SETUP 23

3.4.3 TEST PROCEDURES 24

3.4.4 TEST RESULTS 24

3.5 CONDUCTED SPURIOUS EMISSIONS 25

3.5.1 LIMITS OF CONDUCTED SPURIOUS EMISSIONS MEASUREMENT 25

3.5.2 TEST PROCEDURE 25

3.5.3 TEST SETUP 25

3.5.4 TEST RESULTS 25

3.6 RADIATED EMISSION MEASUREMENT 26

3.6.1 LIMITS OF RADIATED EMISSION MEASUREMENT 26

3.6.2 TEST PROCEDURES 26

3.6.3 DEVIATION FROM TEST STANDARD 26

3.6.4 TEST SETUP 27

3.6.5 TEST RESULTS 28

3.7 PEAK TO AVERAGE RATIO 46

3.7.1 LIMITS OF PEAK TO AVERAGE RATIO MEASUREMENT 46

3.7.2 TEST SETUP 46

3.7.3 TEST PROCEDURES 46

3.7.4 TEST RESULTS 46

4 INFORMATION ON THE TESTING LABORATORIES 47



Test Report No.: RF190701W004-2

5 APPENDIX A – MODIFICATIONS RECORDERS FOR ENGINEERING CHANGES TO THE EUT BY THE LAB 48



BUREAU
VERITAS

Test Report No.: RF190701W004-2

RELEASE CONTROL RECORD

ISSUE NO.	REASON FOR CHANGE	DATE ISSUED
RF190701W004-2	Original release	Jul. 24, 2019



1 SUMMARY OF TEST RESULTS

The EUT has been tested according to the following specifications:

APPLIED STANDARD: FCC Part 24 & Part 2			
STANDARD SECTION	TEST TYPE	RESULT	REMARK
2.1046 24.232	Equivalent Isotropic Radiated Power	PASS	See Note
2.1055 24.235	Frequency Stability	N/A	See Note
2.1049 24.238(b)	Occupied Bandwidth	N/A	See Note
24.232(d)	Peak to average ratio	N/A	See Note
24.238(b)	Band Edge Measurements	N/A	See Note
2.1051 24.238	Conducted Spurious Emissions	N/A	See Note
2.1053 24.238	Radiated Spurious Emissions	PASS	Meet the requirement of limit. Minimum passing margin is -13.58dB at 90.250MHz.

Note: These items please refer to the LTE module report RXA1706-0199RF01R1 which The FCC ID is XMR201707BG96, and the LTE module has been certified by TA Technology(shanghai)Co.,Ltd on 09/12/2017.

1.1 MEASUREMENT UNCERTAINTY

Where relevant, the following measurement uncertainty levels have been estimated for tests performed on the EUT as specified in CISPR 16-4-2:

MEASUREMENT	UNCERTAINTY
Effective Radiated Power	±4.48dB
Frequency Stability	± 39.27Hz
Radiated emissions	±4.48dB
Conducted emissions	±2 dB
Occupied Channel Bandwidth	±21.7KHz
Band Edge Measurements	±4.48dB
Peak to average ratio	±0.76dB

This uncertainty represents an expanded uncertainty expressed at approximately the 95% confidence level using a coverage factor of k=2.



1.2 TEST SITE AND INSTRUMENTS

Equipment	Manufacturer	Model No.	Serial No.	Last Cal.	Next Cal.
MXE EMI Receiver	KEYSIGHT	N9038A-544	MY54450026	Feb. 26,19	Feb. 25,20
EXA Signal Analyzer	KEYSIGHT	N9010A-526	MY54510322	Feb. 26,19	Feb. 25,20
Bilog Antenna 1	ETS-LINDGREN	3143B	00161964	Feb. 26,19	Feb. 25,20
Bilog Antenna 2	ETS-LINDGREN	3143B	00161965	Feb. 26,19	Feb. 25,20
Horn Antenna 1	ETS-LINDGREN	3117	00168728	Feb. 26,19	Feb. 25,20
Horn Antenna 2	ETS-LINDGREN	3117	00168692	Nov. 30, 18	Nov. 29, 19
Horn Antenna (18GHz-40GHz)	N/A	QWH-SL-18-40-K-SG/QMS-00361	15433	Nov. 21, 18	Nov. 20, 19
Radio Communication Analyzer	ANRITSU	MT8820C	6201465426	Feb. 26,19	Feb. 25,20
Signal Pre-Amplifier	EMSI	EMC 9135	980249	Jun. 24,19	Jun. 23,20
Signal Pre-Amplifier	EMSI	EMC 012645B	980257	Jun. 24,19	Jun. 23,20
Signal Pre-Amplifier	EMSI	EMC 184045B	980259	Jun. 24,19	Jun. 23,20
3m Semi-anechoic Chamber	ETS-LINDGREN	9m*6m*6m	Euroshieldpn-CT0001143-1216	Feb. 26,19	Feb. 25,20
Test Software	E3	V 9.160323	N/A	N/A	N/A
Test Software	ADT	ADT_Radiated_V7.6.15.9.2	N/A	N/A	N/A
10dB Attenuator	JFW/USA	50HF-010-SM A	1505	Jun. 24,19	Jun. 23,20
Power Meter	Anritsu	ML2495A	1506002	Feb. 26,19	Feb. 25,20
Power Sensor	Anritsu	MA2411B	1339352	Feb. 26,19	Feb. 25,20
Humid & Temp Programmable Tester	Juyi	ITH-120-45-CP-AR	IAA1504-001	Jun. 24,19	Jun. 23,20
MXG Analog Microvave Signal Generator	KEYSIGHT	N5183A	MY50143024	Feb. 26,19	Feb. 25,20

- NOTE:**
1. The calibration interval of the above test instruments is 12 months or 24 months and the calibrations are traceable to CEPREI/CHINA, GRGT/CHINA and NIM/CHINA.
 2. The test was performed in 3m Semi-anechoic Chamber and RF Oven Room.
 3. The horn antenna is used only for the measurement of emission frequency above 1GHz if tested.
 4. The FCC Site Registration No. is 525120; The Designation No. is CN1171.



2 GENERAL INFORMATION

2.1 GENERAL DESCRIPTION OF EUT

PRODUCT	IoT Wireless Device	
MODEL NAME	TMX08	
POWER SUPPLY	12Vdc (adapter or host equipment) 3.7Vdc (Li-ion, battery)	
MODULATION TYPE	LTE Band 2: QPSK, 16QAM	
FREQUENCY RANGE	LTE Band 2 Channel Bandwidth: 1.4MHz	1850.7MHz ~ 1909.3MHz
	LTE Band 2 Channel Bandwidth: 3MHz	1851.5MHz ~ 1908.5MHz
	LTE Band 2 Channel Bandwidth: 5MHz	1852.5MHz ~ 1907.5MHz
	LTE Band 2 Channel Bandwidth: 10MHz	1855.0MHz ~ 1905.0MHz
	LTE Band 2 Channel Bandwidth: 15MHz	1857.5MHz ~ 1902.5MHz
	LTE Band 2 Channel Bandwidth: 20MHz	1860.0MHz ~ 1900.0MHz
MAX. EIRP POWER	LTE Band 2 Channel Bandwidth: 1.4MHz	123mW
	LTE Band 2 Channel Bandwidth: 3MHz	122mW
	LTE Band 2 Channel Bandwidth: 5MHz	123mW
	LTE Band 2 Channel Bandwidth: 10MHz	125 mW
	LTE Band 2 Channel Bandwidth: 15MHz	123mW
	LTE Band 2 Channel Bandwidth: 20MHz	111mW
ANTENNA TYPE	External antenna with 2.5dBi gain	
HW VERSION	BJ51AV01	
SW VERSION	BJ51V01	
I/O PORTS	Refer to user's manual	
CABLE SUPPLIED	N/A	



NOTE:

1. For a more detailed features description, please refer to the manufacturer's specifications or the user's manual.
2. For the test results, the EUT had been tested with all conditions. But only the worst case was shown in test report.

List of Accessories:

ACCESSORIES	MODEL	SPECIFICATION
Power supply adapter	TDX-1201000	I/P:100~240VAC O/P:12VDC/1A
Battery	Li-ion Polymer Battery	DC 3.7V, 3000mAh, 11.1Wh
Sensor 1	Ultrasonic&Temperature sensor	-
Sensor 2	Ultrasonic sensor	-
Current draw sensor	Current draw sensor	-
Cellular Antenna	Cellular Antenna	-
GPS Antenna	GPS Antenna	-



2.2 CONFIGURATION OF SYSTEM UNDER TEST

FOR RADIATION EMISSION TEST

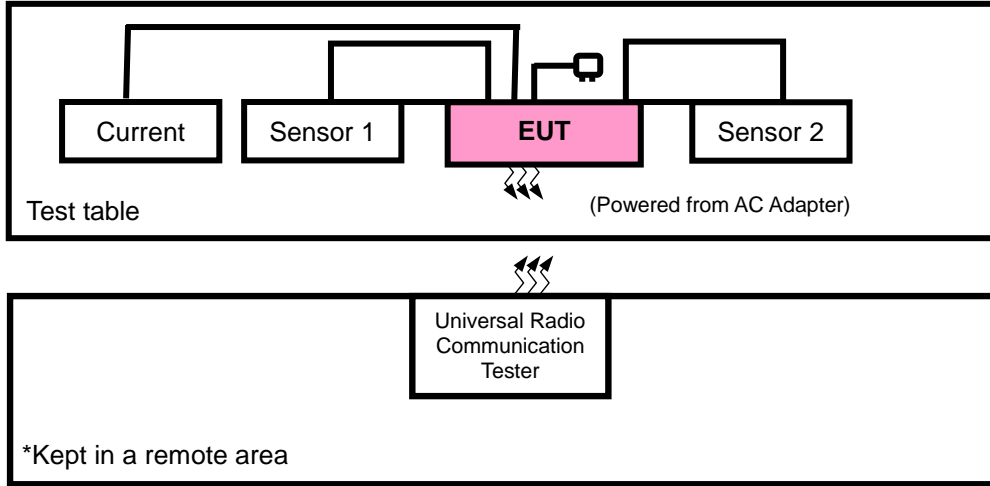

FOR CONDUCTED & E.I.R.P. TEST

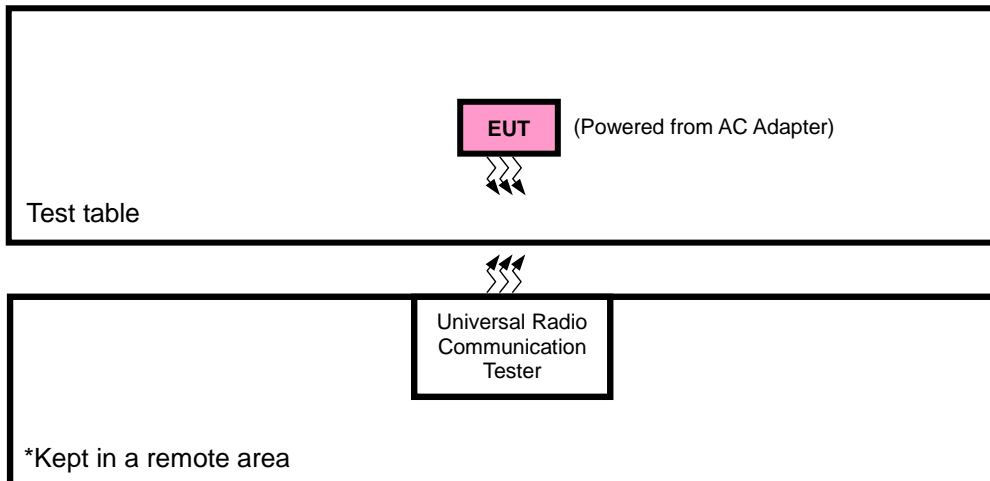



2.4 TEST ITEM AND TEST CONFIGURATION

Pre-Scan has been conducted to determine the worst-case mode from all possible combinations between available modulations, data rates, XYZ axis and antenna ports

The worst case in EIRP and radiated emission was found when positioned on X-plane for LTE. Following channel(s) was (were) selected for the final test as listed below:

EUT CONFIGURE MODE	DESCRIPTION
-	EUT + Adapter with LTE link



LTE BAND 2

EUT CONFIGURE MODE	TEST ITEM	AVAILABLE CHANNEL	TESTED CHANNEL	CHANNEL BANDWIDTH	MODULATION	MODE
-	EIRP	18607 to 19193	18607, 18900, 19193	1.4MHz	QPSK,16QAM	1 RB / 0 RB Offset
		18615 to 19185	18615, 18900, 19185	3MHz	QPSK,16QAM	1 RB / 0 RB Offset
		18625 to 19175	18625, 18900, 19175	5MHz	QPSK,16QAM	1 RB / 0 RB Offset
		18650 to 19150	18650, 18900, 19150	10MHz	QPSK,16QAM	1 RB / 0 RB Offset
		18675 to 19125	18675, 18900, 19125	15MHz	QPSK,16QAM	1 RB / 0 RB Offset
		18700 to 19100	18700, 18900, 19100	20MHz	QPSK,16QAM	1 RB / 0 RB Offset
-	RADIATED EMISSION	18607 to 19193	18900	1.4MHz	QPSK	1 RB / 0 RB Offset
		18615 to 19185	18900	3MHz	QPSK	1 RB / 0 RB Offset
		18625 to 19175	18625, 18900, 19175	5MHz	QPSK	1 RB / 0 RB Offset
		18650 to 19150	18900	10MHz	QPSK	1 RB / 0 RB Offset
		18675 to 19125	18900	15MHz	QPSK	1 RB / 0 RB Offset
		18700 to 19100	18900	20MHz	QPSK	1 RB / 0 RB Offset

TEST CONDITION:

TEST ITEM	ENVIRONMENTAL CONDITIONS	INPUT POWER	TESTED BY
EIRP	25deg. C, 57%RH	3.7Vdc from Battery	Star Le
RADIATED EMISSION	23deg. C, 70%RH	12Vdc from adapter	Star Le



2.5 EUT OPERATING CONDITIONS

The EUT makes a call to the communication simulator. The communication simulator station system controlled a EUT to export maximum output power under transmission mode and specific channel frequency

2.6 GENERAL DESCRIPTION OF APPLIED STANDARDS

The EUT is a RF product. According to the specifications of the manufacturer, it must comply with the requirements of the following standards:

FCC 47 CFR Part 2

FCC 47 CFR Part 24

KDB 971168 D01 Power Meas License Digital Systems v03r01

ANSI/TIA/EIA-603-D

ANSI/TIA/EIA-603-E

ANSI C63.26-2015

NOTE: All test items have been performed and recorded as per the above standards.



3 TEST TYPES AND RESULTS

3.1 OUTPUT POWER MEASUREMENT

3.1.1 LIMITS OF OUTPUT POWER MEASUREMENT

Mobile and portable stations are limited to 2 watts EIRP.

3.1.2 TEST PROCEDURES

EIRP MEASUREMENT:

- a. All measurements were done at low, middle and high operational frequency range. RBW and VBW is 5MHz for WCDMA mode and 10MHz for LTE mode.
- b. Substitution method is used for E.I.R.P measurement. In the semi-anechoic chamber, EUT placed on the 0.8m height of Turn Table, rotated the table around 360 degrees to search the maximum radiation power and receiver antenna shall be rotated vertical and horizontal polarization and moved height from 1m to 4m to find the maximum polar radiated power. The “Read Value” is the spectrum reading the maximum power value.
- c. The substitution horn antenna is substituted for EUT at the same position and signals generator export the CW signal to the substitution antenna via a tx cable. Rotated the Turn Table and moved receiving antenna to find the maximum radiation power. Adjust output power level of S.G to get a Value of spectrum reading equal to “Read Value “ of step b. Record the power level of S.G
- d. $EIRP = \text{Output power level of S.G} - \text{TX cable loss} + \text{Antenna gain of substitution horn.}$

CONDUCTED POWER MEASUREMENT:

The EUT was set up for the maximum power with WCDMA link data modulation and link up with simulator. Set the EUT to transmit under low, middle and high channel and record the power level shown on simulator.



3.1.3 TEST SETUP

EIRP / ERP Measurement:

<Radiated Emission below or equal 1 GHz>

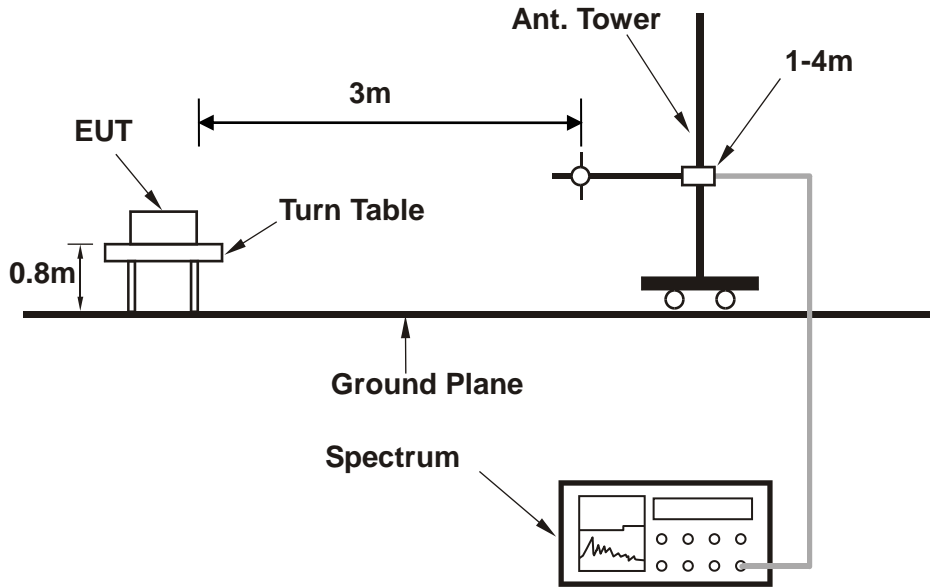

<Radiated Emission above 1 GHz>

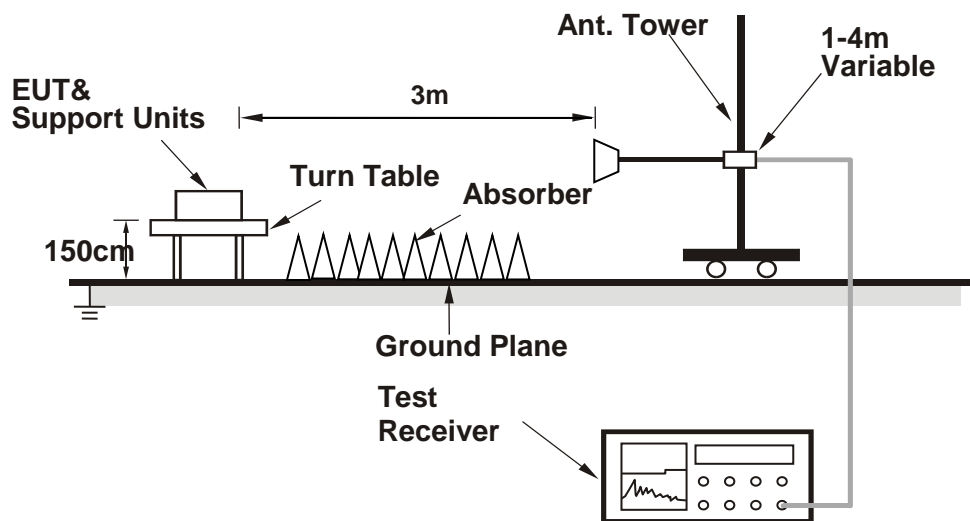

For the actual test configuration, please refer to the attached file (Test Setup Photo).

CONDUCTED POWER MEASUREMENT:

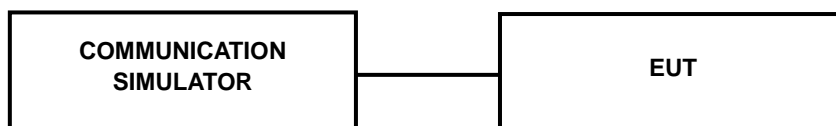



3.1.4 TEST RESULTS

CONDUCTED OUTPUT POWER (dBm)

Base on verify the Conducted Power is the same with module test report (RXA1706-0199RF02R1) by lab, the test results please refer the module Report No.: RXA1706-0199RF02R1, and the pre-scan data as below.

LTE BAND 2

LTE Band 2							
BW	Modulation	RB Size	RB Offset	Low CH 18607	Mid CH 18900	High CH 19193	MPR
				Frequency 1850.7 MHz	Frequency 1880 MHz	Frequency 1909.3 MHz	
1.4	QPSK	1	0	22.57	23.06	23.66	0
		1	3	22.85	22.97	23.31	0
		1	5	22.75	23.05	23.11	0
		3	0	22.94	23.07	23.22	0
		3	2	22.87	23.01	23.25	0
		3	3	22.78	22.90	23.03	0
		6	0	22.36	23.15	22.80	0
	16QAM	1	0	22.95	22.59	23.40	0
		1	3	23.70	22.79	23.45	0
		1	5	23.72	22.84	23.22	0
		3	0	23.33	22.94	23.23	0
		3	2	23.28	22.70	23.08	0
		3	3	23.37	22.86	23.21	0
		6	0	22.75	22.95	23.02	0



EIRP POWER (dBm)

LTE BAND 2

CHANNEL BANDWIDTH: 1.4MHz QPSK

Channel	Frequency (MHz)	SPA LVL (dBm)	Correction Factor(dB)	EIRP(dBm)	EIRP(mW)	Polarization (H/V)	LIMIT (W)
18607	1850.7	-29.77	43.83	14.06	25.49	H	2
18900	1880.0	-30.28	43.57	13.29	21.33	H	2
19193	1908.3	-30.74	44.32	13.58	22.80	H	2
18607	1850.7	-25.71	46.41	20.70	117.52	V	2
18900	1880.0	-26.16	47.07	20.91	123.31	V	2
19193	1908.3	-26.06	45.88	19.82	96.03	V	2

CHANNEL BANDWIDTH: 1.4MHz 16QAM

Channel	Frequency (MHz)	SPA LVL (dBm)	Correction Factor(dB)	EIRP(dBm)	EIRP(mW)	Polarization (H/V)	LIMIT (W)
18607	1850.7	-30.64	43.83	13.19	20.86	H	2
18900	1880.0	-31.21	43.57	12.36	17.22	H	2
19193	1908.3	-31.70	44.32	12.62	18.28	H	2
18607	1850.7	-26.58	46.41	19.83	96.18	V	2
18900	1880.0	-27.09	47.07	19.98	99.54	V	2
19193	1908.3	-27.02	45.88	18.86	76.98	V	2



CHANNEL BANDWIDTH: 3MHz QPSK

Channel	Frequency (MHz)	SPA LVL (dBm)	Correction Factor(dB)	EIRP(dBm)	EIRP(mW)	Polarization (H/V)	LIMIT (W)
18615	1851.5	-29.75	43.82	14.07	25.54	H	2
18900	1880.0	-30.34	43.57	13.23	21.04	H	2
19185	1908.5	-30.69	44.38	13.69	23.37	H	2
18615	1851.5	-25.69	46.45	20.76	119.15	V	2
18900	1880.0	-26.22	47.07	20.85	121.62	V	2
19185	1908.5	-26.01	45.88	19.87	97.05	V	2

CHANNEL BANDWIDTH: 3MHz 16QAM

Channel	Frequency (MHz)	SPA LVL (dBm)	Correction Factor(dB)	EIRP(dBm)	EIRP(mW)	Polarization (H/V)	LIMIT (W)
18615	1851.5	-30.82	43.82	13.00	19.96	H	2
18900	1880.0	-31.23	43.57	12.34	17.14	H	2
19185	1908.5	-31.68	44.38	12.70	18.60	H	2
18615	1851.5	-26.76	46.45	19.69	93.13	V	2
18900	1880.0	-27.11	47.07	19.96	99.08	V	2
19185	1908.5	-27.00	45.88	18.88	77.27	V	2

CHANNEL BANDWIDTH: 5MHz QPSK

Channel	Frequency (MHz)	SPA LVL (dBm)	Correction Factor(dB)	EIRP(dBm)	EIRP(mW)	Polarization (H/V)	LIMIT (W)
18625	1852.5	-29.81	43.83	14.02	25.22	H	2
18900	1880.0	-30.29	43.57	13.28	21.28	H	2
19175	1907.5	-30.64	44.19	13.55	22.64	H	2
18625	1852.5	-25.75	46.46	20.71	117.84	V	2
18900	1880.0	-26.17	47.07	20.90	123.03	V	2
19175	1907.5	-25.96	45.89	19.93	98.42	V	2



CHANNEL BANDWIDTH: 5MHz 16QAM

Channel	Frequency (MHz)	SPA LVL (dBm)	Correction Factor(dB)	EIRP(dBm)	EIRP(mW)	Polarization (H/V)	LIMIT (W)
18625	1852.5	-30.64	43.83	13.19	20.84	H	2
18900	1880.0	-31.31	43.57	12.26	16.83	H	2
19175	1907.5	-31.74	44.19	12.45	17.57	H	2
18625	1852.5	-26.58	46.46	19.88	97.34	V	2
18900	1880.0	-27.19	47.07	19.88	97.27	V	2
19175	1907.5	-27.06	45.89	18.83	76.40	V	2

CHANNEL BANDWIDTH: 10MHz QPSK

Channel	Frequency (MHz)	SPA LVL (dBm)	Correction Factor(dB)	EIRP(dBm)	EIRP(mW)	Polarization (H/V)	LIMIT (W)
18650	1855.0	-29.62	43.86	14.24	26.55	H	2
18900	1880.0	-30.23	43.57	13.34	21.58	H	2
19150	1905.0	-30.51	43.99	13.48	22.30	H	2
18650	1855.0	-25.56	46.28	20.72	117.98	V	2
18900	1880.0	-26.11	47.07	20.96	124.74	V	2
19150	1905.0	-25.83	45.92	20.09	102.14	V	2

CHANNEL BANDWIDTH: 10MHz 16QAM

Channel	Frequency (MHz)	SPA LVL (dBm)	Correction Factor(dB)	EIRP(dBm)	EIRP(mW)	Polarization (H/V)	LIMIT (W)
18650	1855.0	-30.77	43.86	13.09	20.38	H	2
18900	1880.0	-31.33	43.57	12.24	16.75	H	2
19150	1905.0	-31.67	43.99	12.32	17.08	H	2
18650	1855.0	-26.71	46.28	19.57	90.53	V	2
18900	1880.0	-27.21	47.07	19.86	96.83	V	2
19150	1905.0	-26.99	45.92	18.93	78.20	V	2



CHANNEL BANDWIDTH: 15MHz QPSK

Channel	Frequency (MHz)	SPA LVL (dBm)	Correction Factor(dB)	EIRP(dBm)	EIRP(mW)	Polarization (H/V)	LIMIT (W)
18675	1857.5	-29.63	43.99	14.36	27.30	H	2
18900	1880.0	-30.30	43.57	13.27	21.23	H	2
19125	1902.5	-30.58	43.66	13.08	20.30	H	2
18675	1857.5	-25.57	45.93	20.36	108.57	V	2
18900	1880.0	-26.18	47.07	20.89	122.74	V	2
19125	1902.5	-25.90	46.20	20.30	107.20	V	2

CHANNEL BANDWIDTH: 15MHz 16QAM

Channel	Frequency (MHz)	SPA LVL (dBm)	Correction Factor(dB)	EIRP(dBm)	EIRP(mW)	Polarization (H/V)	LIMIT (W)
18675	1857.5	-30.49	43.99	13.50	22.40	H	2
18900	1880.0	-31.17	43.57	12.40	17.38	H	2
19125	1902.5	-31.43	43.66	12.23	16.69	H	2
18675	1857.5	-26.43	45.93	19.50	89.06	V	2
18900	1880.0	-27.05	47.07	20.02	100.46	V	2
19125	1902.5	-26.75	46.20	19.45	88.15	V	2

CHANNEL BANDWIDTH: 20MHz QPSK

Channel	Frequency (MHz)	SPA LVL (dBm)	Correction Factor(dB)	EIRP(dBm)	EIRP(mW)	Polarization (H/V)	LIMIT (W)
18700	1860.0	-30.21	43.50	13.29	21.33	H	2
18900	1880.0	-30.75	43.57	12.82	19.14	H	2
19100	1900.0	-31.16	43.62	12.46	17.60	H	2
18700	1860.0	-26.15	45.57	19.42	87.50	V	2
18900	1880.0	-26.63	47.07	20.44	110.66	V	2
19100	1900.0	-26.48	46.26	19.78	95.08	V	2



CHANNEL BANDWIDTH: 20MHz 16QAM

Channel	Frequency (MHz)	SPA LVL (dBm)	Correction Factor(dB)	EIRP(dBm)	EIRP(mW)	Polarization (H/V)	LIMIT (W)
18700	1860.0	-31.14	43.50	12.36	17.21	H	2
18900	1880.0	-31.82	43.57	11.75	14.96	H	2
19100	1900.0	-31.99	43.62	11.63	14.54	H	2
18700	1860.0	-27.08	45.57	18.49	70.63	V	2
18900	1880.0	-27.70	47.07	19.37	86.50	V	2
19100	1900.0	-27.31	46.26	18.95	78.54	V	2

REMARKS: 1. EIRP Output Power (dBm) = SPA LVL (dBm) + Correction Factor (dB).

2. Correction factor (dB) = Free Space Loss + Antenna Factor + Cable Loss



3.2 FREQUENCY STABILITY MEASUREMENT

3.2.1 LIMITS OF FREQUENCY STABILITY MEASUREMENT

The frequency stability shall be sufficient to ensure that the fundamental emission stays within the authorized frequency block.

3.2.2 TEST PROCEDURE

- a. Device is placed at the oven room. The oven room could control the temperatures and humidity. Power warm up is at least 15 min and power applied should perform before recording frequency error.
- b. EUT is connected the external power supply to control the DC input power. The test voltage range is from minimum to maximum working voltage. Each step shall be record the frequency error rate.
- c. The temperature range step is 10 degrees in this test items. All temperature levels shall be hold the $\pm 0.5^{\circ}\text{C}$ during the measurement testing. The each temperature step shall be at least 0.5 hours, consider the EUT could be test under the stability condition.

NOTE: The frequency error was recorded frequency error from the communication simulator.

3.2.3 TEST SETUP

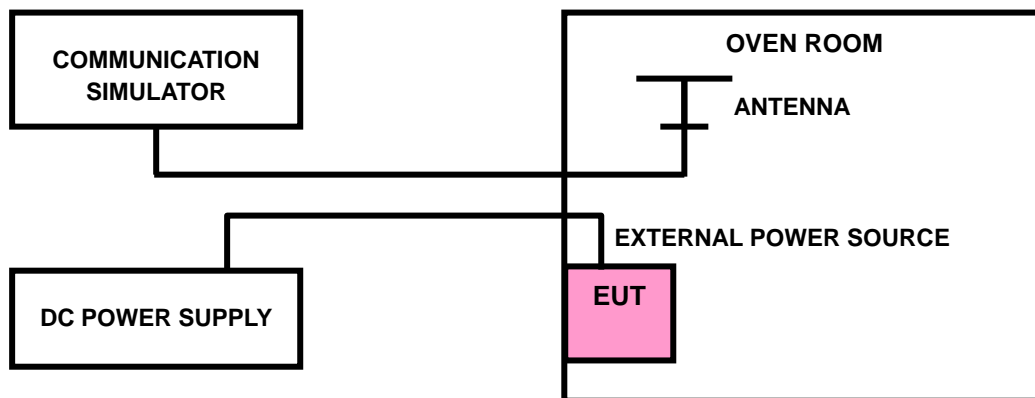

3.2.4 TEST RESULTS

The test results was recorded in Report No.: RXA1706-0199RF02R1.



3.3 OCCUPIED BANDWIDTH MEASUREMENT

3.3.1 TEST PROCEDURES

The EUT makes a call to the communication simulator. All measurements were done at low, middle and high operational frequency range. The communication simulator station system controlled a EUT to export maximum output power under transmission mode and specific channel frequency. Use OBW measurement function of Spectrum analyzer to measure 99 % occupied bandwidth.

3.3.2 TEST SETUP

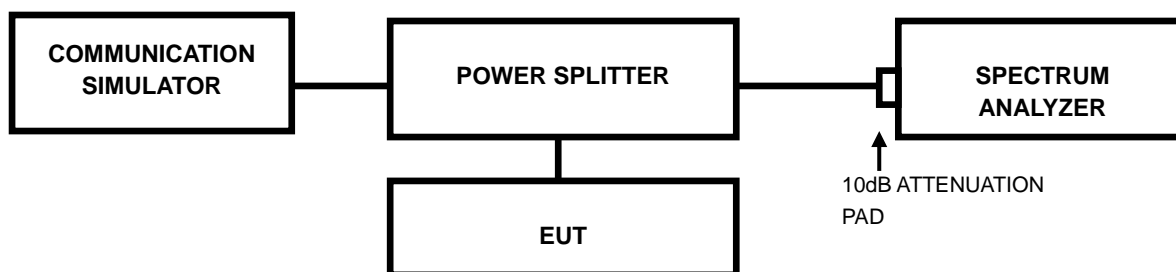

3.3.3 TEST RESULTS

The test results was recorded in Report No.: RXA1706-0199RF02R1.



3.4 BAND EDGE MEASUREMENT

3.4.1 LIMITS OF BAND EDGE MEASUREMENT

Power of any emission outside of the authorized operating frequency ranges must be attenuated below the transmitting power (P) by a factor of at least $43 + 10 \log(P)$ dB. In the 1 MHz bands immediately outside and adjacent to the frequency block a resolution bandwidth of at least one percent of the emission bandwidth of the fundamental emission of the transmitter may be employed.

3.4.2 TEST SETUP

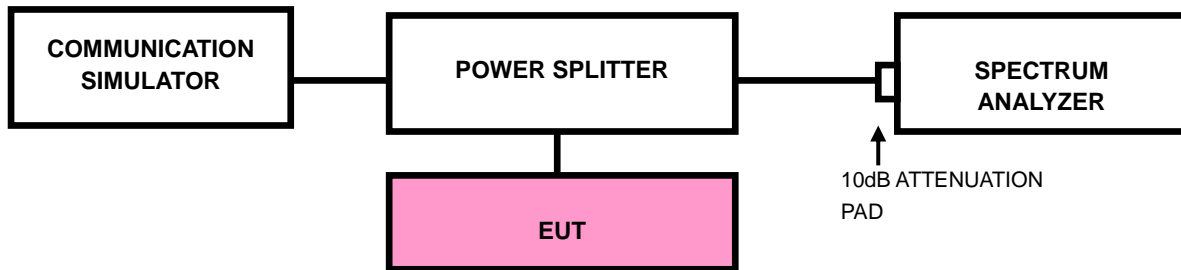



3.4.3 TEST PROCEDURES

- a. All measurements were done at low and high operational frequency range.
- b. The center frequency of spectrum is the band edge frequency and span is 1~5 MHz. RBW of the spectrum is 20kHz and VBW of the spectrum is 100 kHz. (LTE bandwidth 1.4MHz)
- c. The center frequency of spectrum is the band edge frequency and span is 1~5 MHz. RBW of the spectrum is 30kHz and VBW of the spectrum is 100kHz. (LTE bandwidth 3MHz)
- d. The center frequency of spectrum is the band edge frequency and span is 1~5 MHz. RBW of the spectrum is 50kHz and VBW of the spectrum is 200kHz. (LTE bandwidth 5MHz)
- e. The center frequency of spectrum is the band edge frequency and span is 1~5 MHz. RBW of the spectrum is 100kHz and VBW of the spectrum is 300kHz. (LTE bandwidth 10MHz)
- f. The center frequency of spectrum is the band edge frequency and span is 1~5 MHz. RBW of the spectrum is 200kHz and VBW of the spectrum is 1MHz. (LTE bandwidth 15MHz)
- g. The center frequency of spectrum is the band edge frequency and span is 1~5 MHz. RBW of the spectrum is 200kHz and VBW of the spectrum is 1MHz. (LTE bandwidth 20MHz)
- h. Record the max trace plot into the test report.

3.4.4. TEST RESULTS

The test results was recorded in Report No.: RXA1706-0199RF02R1.



3.5 CONDUCTED SPURIOUS EMISSIONS

3.5.1 LIMITS OF CONDUCTED SPURIOUS EMISSIONS MEASUREMENT

The power of any emission outside of the authorized operating frequency ranges must be attenuated below the transmitting power (P) by a factor of at least $43 + 10 \log(P)$ dB. The emission limit equal to -13dBm .

3.5.2 TEST PROCEDURE

- a. The EUT makes a phone call to the communication simulator. All measurements were done at low, middle and high operational frequency range.
- b. Measuring frequency range is from 9 kHz to 19.1GHz. 10dB attenuation pad is connected with spectrum. RBW=1MHz and VBW=3MHz is used for conducted emission measurement.

3.5.3 TEST SETUP

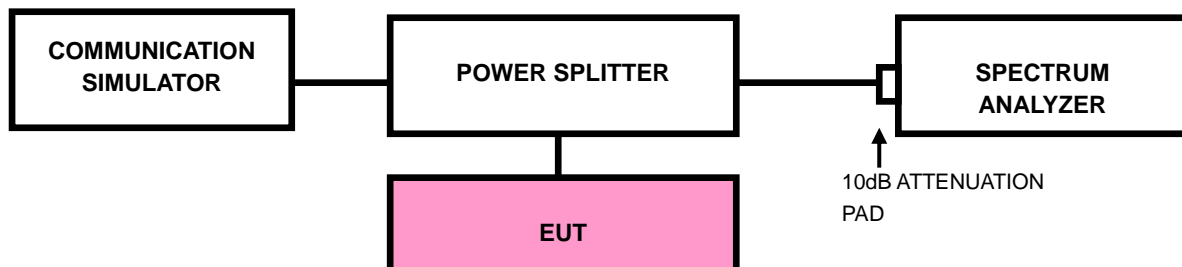

3.5.4 TEST RESULTS

The test results was recorded in Report No.: RXA1706-0199RF02R1.



3.6 RADIATED EMISSION MEASUREMENT

3.6.1 LIMITS OF RADIATED EMISSION MEASUREMENT

The power of any emission outside of the authorized operating frequency ranges must be attenuated below the transmitting power (P) by a factor of at least $43 + 10 \log(P)$ dB. The emission limit equal to -13dBm .

3.6.2 TEST PROCEDURES

- a. Substitution method is used for E.I.R.P measurement. In the semi-anechoic chamber, EUT placed on the 0.8m height of Turn Table, rotated the table around 360 degrees to search the maximum radiation power and receiver antenna shall be rotated vertical and horizontal polarization and moved height from 1m to 4m to find the maximum polar radiated power. The “Read Value” is the spectrum reading the maximum power value.
- b. The substitution horn antenna is substituted for EUT at the same position and signals generator export the CW signal to the substitution antenna via a TX cable. Rotated the Turn Table and moved receiving antenna to find the maximum radiation power. Adjust output power level of S.G to get a Value of spectrum reading equal to “Read Value “ of step a. Record the power level of S.G
- c. $\text{EIRP} = \text{Output power level of S.G} - \text{TX cable loss} + \text{Antenna gain of substitution horn}$.

NOTE: The resolution bandwidth and video bandwidth of test receiver/spectrum analyzer is 1MHz/3MHz.

3.6.3 DEVIATION FROM TEST STANDARD

No deviation



3.6.4 TEST SETUP

< Frequency Range 30MHz~1GHz >

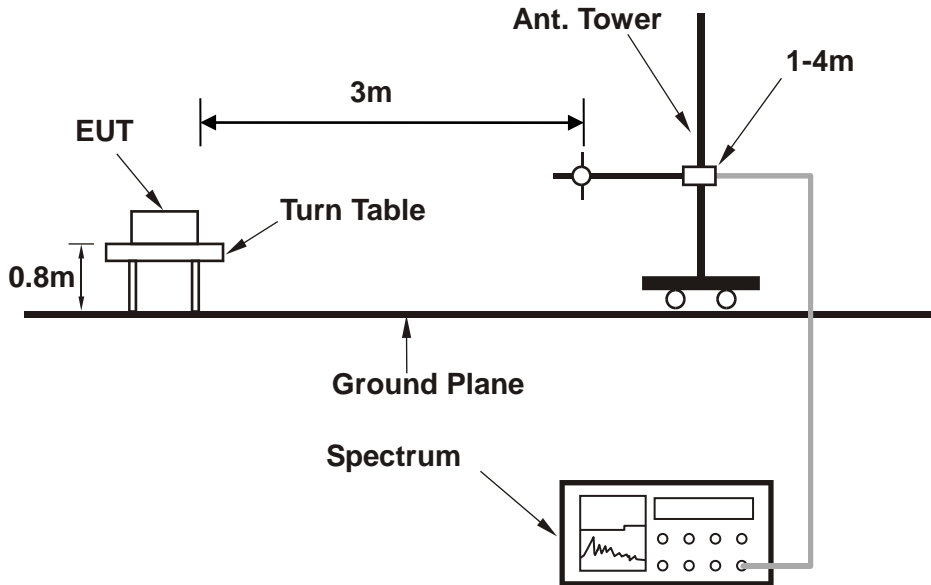

< Frequency Range above 1GHz >

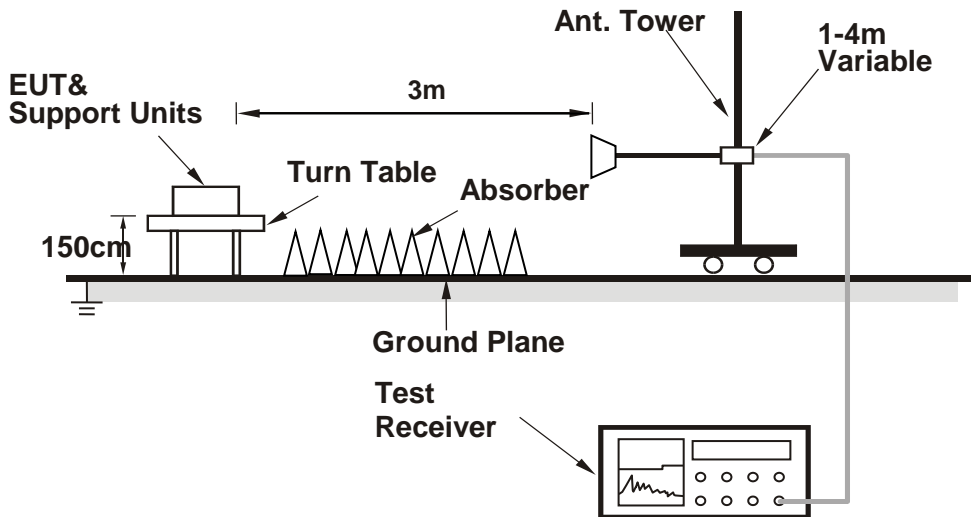

For the actual test configuration, please refer to the attached file (Test Setup Photo).



3.6.5 TEST RESULTS

BELOW 1GHz WORST-CASE DATA

30 MHz – 1GHz data:

LTE Band 2:

CHANNEL BANDWIDTH: 5MHz / QPSK

MODE	TX channel 18900	FREQUENCY RANGE	Below 1000MHz
ENVIRONMENTAL CONDITIONS	23deg. C, 70%RH	INPUT POWER	DC 12V from adapter
TESTED BY	Star Le		
ANTENNA POLARITY & TEST DISTANCE: HORIZONTAL AT 3 M			

	Freq	Level	Read Level	Limit Line	Over Limit	Factor	Remark	Pol/Phase
	MHz	dBm/m	dBm	dBm/m	dB	dB/m		
1	PP	42.580	-27.86	-38.26	-13.00	-14.86	10.40 Peak	Horizontal
2		89.650	-29.64	-38.13	-13.00	-16.64	8.49 Peak	Horizontal
3		145.230	-38.97	-48.24	-13.00	-25.97	9.27 Peak	Horizontal
4		185.640	-34.82	-45.26	-13.00	-21.82	10.44 Peak	Horizontal
5		245.310	-29.36	-42.15	-13.00	-16.36	12.79 Peak	Horizontal
6		325.640	-36.34	-51.23	-13.00	-23.34	14.89 Peak	Horizontal

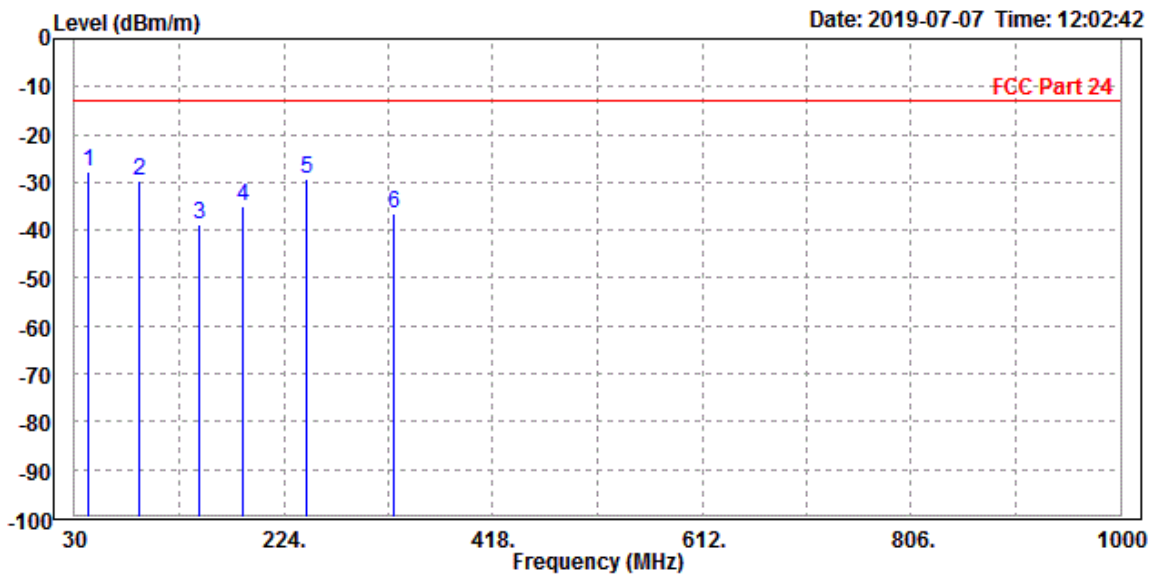



BUREAU VERITAS

Test Report No.: RF190701W004-2

MODE	TX channel 18900	FREQUENCY RANGE	Below 1000MHz
ENVIRONMENTAL CONDITIONS	23deg. C, 70%RH	INPUT POWER	DC 12V from adapter
TESTED BY	Star Le		
ANTENNA POLARITY & TEST DISTANCE: VERTICAL AT 3 M			

	Freq	Level	Read Level	Limit Line	Over Limit	Factor	Remark	Pol/Phase
	MHz	dBm/m	dBm	dBm/m	dB	dB/m		
1	48.670	-29.30	-36.75	-13.00	-16.30	7.45	Peak	Vertical
2 PP	90.250	-26.58	-35.21	-13.00	-13.58	8.63	Peak	Vertical
3	152.360	-32.61	-42.48	-13.00	-19.61	9.87	Peak	Vertical
4	211.350	-34.27	-45.61	-13.00	-21.27	11.34	Peak	Vertical
5	325.680	-37.31	-52.31	-13.00	-24.31	15.00	Peak	Vertical
6	455.210	-38.25	-56.32	-13.00	-25.25	18.07	Peak	Vertical

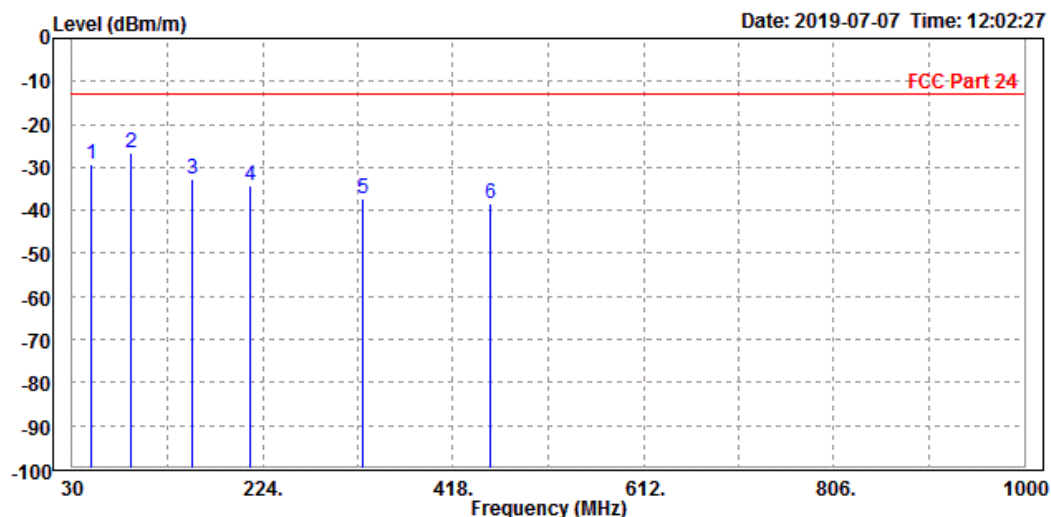



ABOVE 1GHz DATA

Note: For higher frequency, the emission is too low to be detected.

LTE Band 2

CHANNEL BANDWIDTH: 1.4MHz / QPSK

MODE	TX channel 18900	FREQUENCY RANGE	Above 1000MHz
ENVIRONMENTAL CONDITIONS	23deg. C, 70%RH	INPUT POWER	DC 12V from adapter
TESTED BY	Star Le		
ANTENNA POLARITY & TEST DISTANCE: HORIZONTAL AT 3 M			

	Freq	Level	Read Level	Limit Line	Over Limit	Factor	Remark	Pol/Phase
	MHz	dBm/m	dBm	dBm/m	dB	dB/m		
1	3755.000	-56.32	-59.71	-13.00	-43.32	3.39	Peak	Horizontal
2 PP	5640.000	-53.23	-62.35	-13.00	-40.23	9.12	Peak	Horizontal

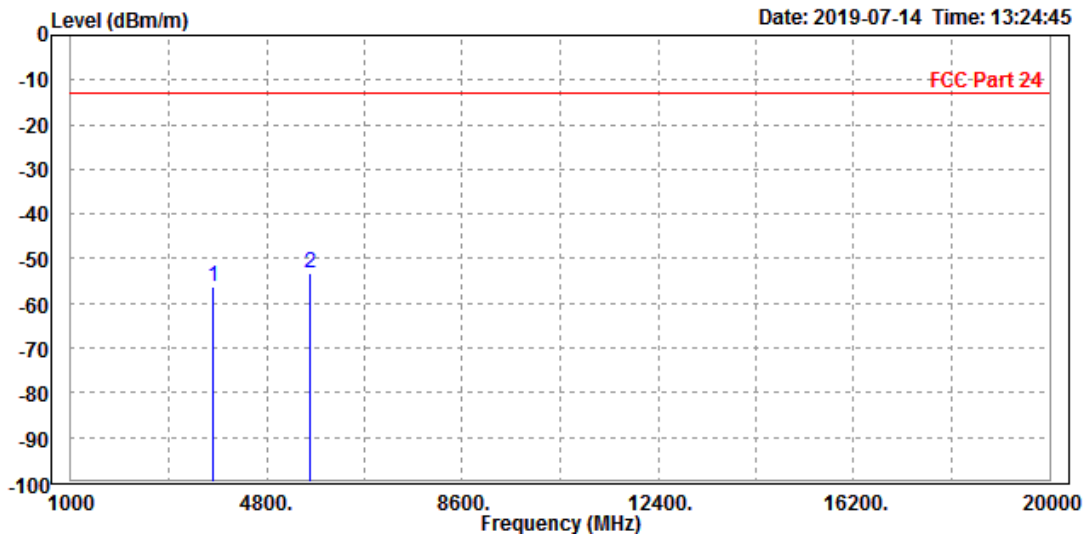



**BUREAU
VERITAS**

Test Report No.: RF190701W004-2

MODE	TX channel 18900	FREQUENCY RANGE	Above 1000MHz
ENVIRONMENTAL CONDITIONS	23deg. C, 70%RH	INPUT POWER	DC 12V from adapter
TESTED BY	Star Le		
ANTENNA POLARITY & TEST DISTANCE: VERTICAL AT 3 M			

	Freq	Level	Read Level	Limit Line	Over Limit	Factor	Remark	Pol/Phase
	MHz	dBm/m	dBm	dBm/m	dB	dB/m		
1	3755.000	-55.77	-59.62	-13.00	-42.77	3.85	Peak	Vertical
2	PP 5640.000	-54.95	-63.21	-13.00	-41.95	8.26	Peak	Vertical

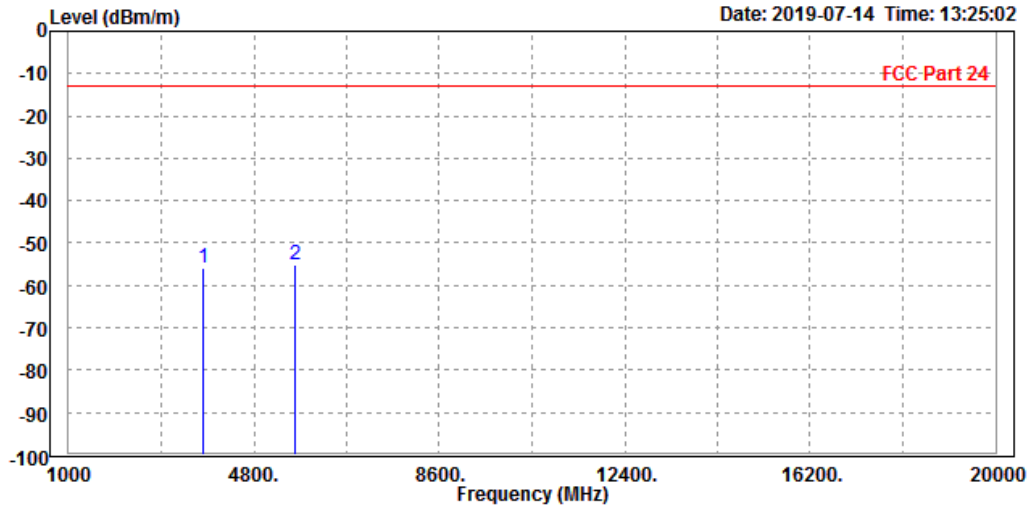



CHANNEL BANDWIDTH: 3MHz / QPSK

MODE	TX channel 18900	FREQUENCY RANGE	Above 1000MHz
ENVIRONMENTAL CONDITIONS	23deg. C, 70%RH	INPUT POWER	DC 12V from adapter
TESTED BY	Star Le		
ANTENNA POLARITY & TEST DISTANCE: HORIZONTAL AT 3 M			

	Freq	Level	Read Level	Limit Line	Over Limit	Factor	Remark	Pol/Phase
	MHz	dBm/m	dBm	dBm/m	dB	dB/m		
1	3755.000	-56.03	-59.42	-13.00	-43.03	3.39	Peak	Horizontal
2 PP	5640.000	-53.11	-62.23	-13.00	-40.11	9.12	Peak	Horizontal

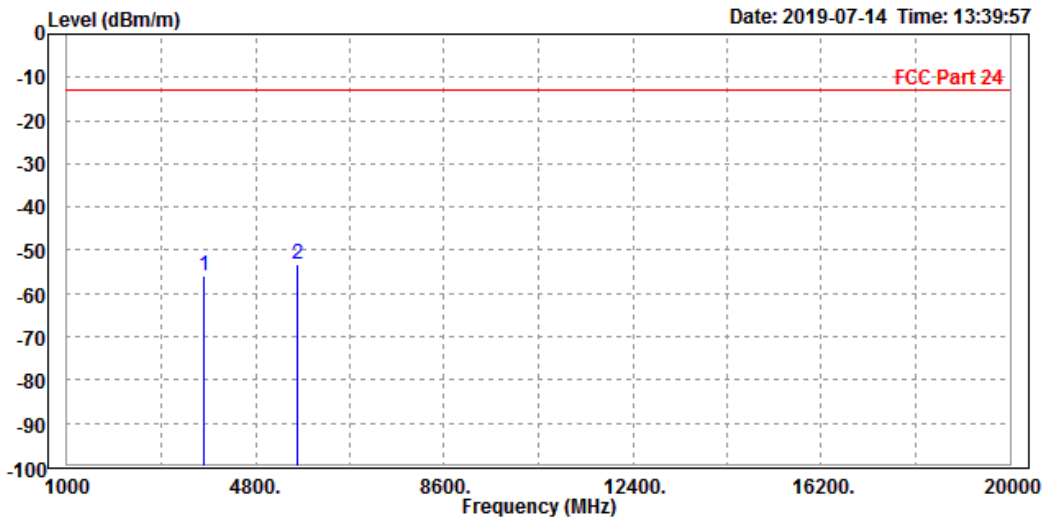



MODE	TX channel 18900	FREQUENCY RANGE	Above 1000MHz
ENVIRONMENTAL CONDITIONS	23deg. C, 70%RH	INPUT POWER	DC 12V from adapter
TESTED BY	Star Le		
ANTENNA POLARITY & TEST DISTANCE: VERTICAL AT 3 M			

	Freq	Level	Read Level	Limit Line	Over Limit	Factor	Remark	Pol/Phase
	MHz	dBm/m	dBm	dBm/m	dB	dB/m		
1	3755.000	-54.82	-58.67	-13.00	-41.82	3.85	Peak	Vertical
2 PP	5640.000	-53.89	-62.15	-13.00	-40.89	8.26	Peak	Vertical

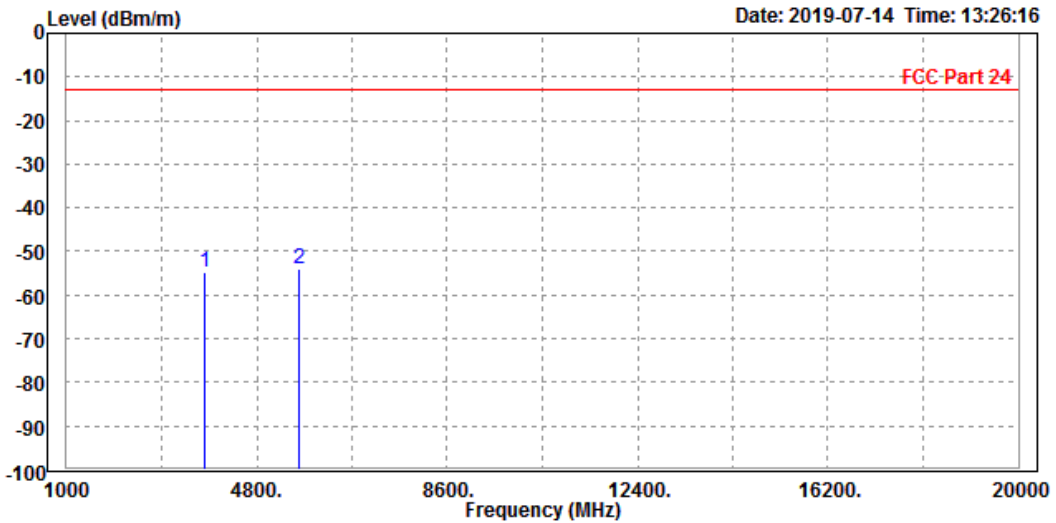



CHANNEL BANDWIDTH: 5MHz / QPSK

CH 18625

MODE	TX channel 18625	FREQUENCY RANGE	Above 1000MHz
ENVIRONMENTAL CONDITIONS	23deg. C, 70%RH	INPUT POWER	DC 12V from adapter
TESTED BY	Star Le		
ANTENNA POLARITY & TEST DISTANCE: HORIZONTAL AT 3 M			

	Freq	Level	Read Level	Limit Line	Over Limit	Factor	Remark	Pol/Phase
	MHz	dBm/m	dBm	dBm/m	dB	dB/m		
1	3705.000	-56.01	-59.16	-13.00	-43.01	3.15	Peak	Horizontal
2 PP	5556.000	-53.32	-62.35	-13.00	-40.32	9.03	Peak	Horizontal

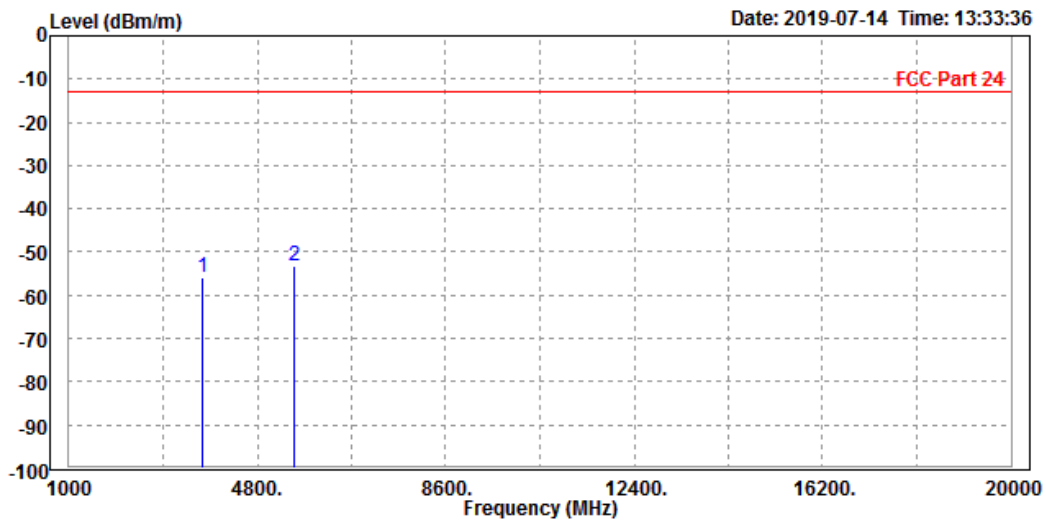



BUREAU VERITAS

Test Report No.: RF190701W004-2

MODE	TX channel 18625	FREQUENCY RANGE	Above 1000MHz
ENVIRONMENTAL CONDITIONS	23deg. C, 70%RH	INPUT POWER	DC 12V from adapter
TESTED BY	Star Le		
ANTENNA POLARITY & TEST DISTANCE: VERTICAL AT 3 M			

	Freq	Level	Read Level	Limit Line	Over Limit	Factor	Remark	Pol/Phase
	MHz	dBm/m	dBm	dBm/m	dB	dB/m		
1	3705.000	-56.04	-59.64	-13.00	-43.04	3.60	Peak	Vertical
2 PP	5556.000	-54.26	-62.34	-13.00	-41.26	8.08	Peak	Vertical

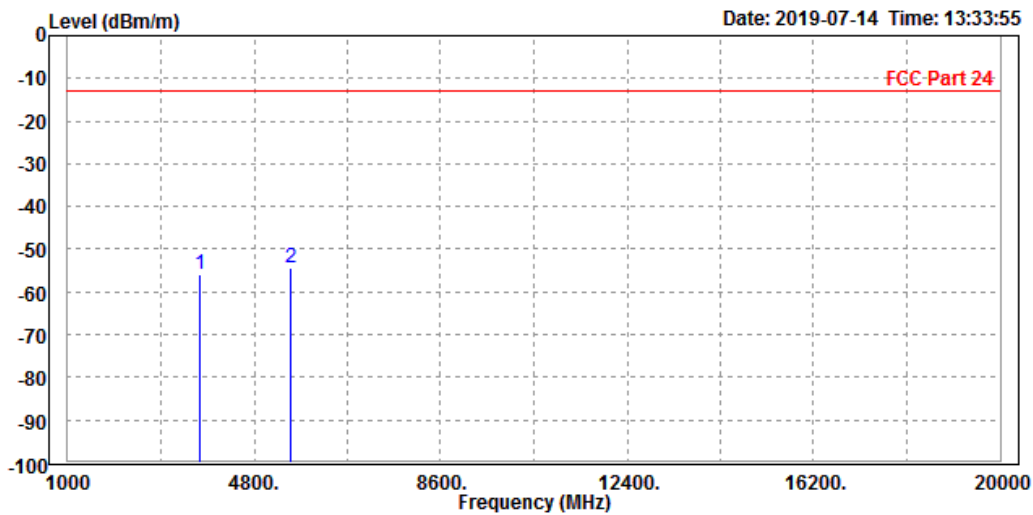



BUREAU VERITAS

Test Report No.: RF190701W004-2

CH 18900

MODE	TX channel 18900	FREQUENCY RANGE	Above 1000MHz
ENVIRONMENTAL CONDITIONS	23deg. C, 70%RH	INPUT POWER	DC 12V from adapter
TESTED BY	Star Le		
ANTENNA POLARITY & TEST DISTANCE: HORIZONTAL AT 3 M			

	Freq	Level	Read Level	Limit Line	Over Limit	Factor	Remark	Pol/Phase
	MHz	dBm/m	dBm	dBm/m	dB	dB/m		
1	3755.000	-56.47	-59.86	-13.00	-43.47	3.39	Peak	Horizontal
2 PP	5640.000	-53.24	-62.36	-13.00	-40.24	9.12	Peak	Horizontal

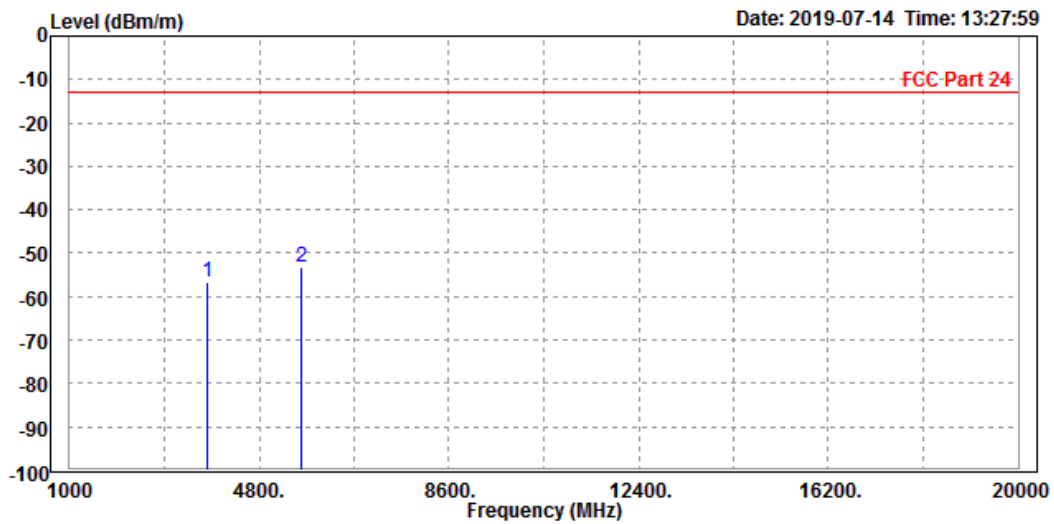



**BUREAU
VERITAS**

Test Report No.: RF190701W004-2

MODE	TX channel 18900	FREQUENCY RANGE	Above 1000MHz
ENVIRONMENTAL CONDITIONS	23deg. C, 70%RH	INPUT POWER	DC 12V from adapter
TESTED BY	Star Le		
ANTENNA POLARITY & TEST DISTANCE: VERTICAL AT 3 M			

	Freq	Level	Read Level	Limit Line	Over Limit	Factor	Remark	Pol/Phase
	MHz	dBm/m	dBm	dBm/m	dB	dB/m		
1	3755.000	-54.82	-58.67	-13.00	-41.82	3.85		Vertical
2 PP	5640.000	-50.99	-59.25	-13.00	-37.99	8.26		Vertical

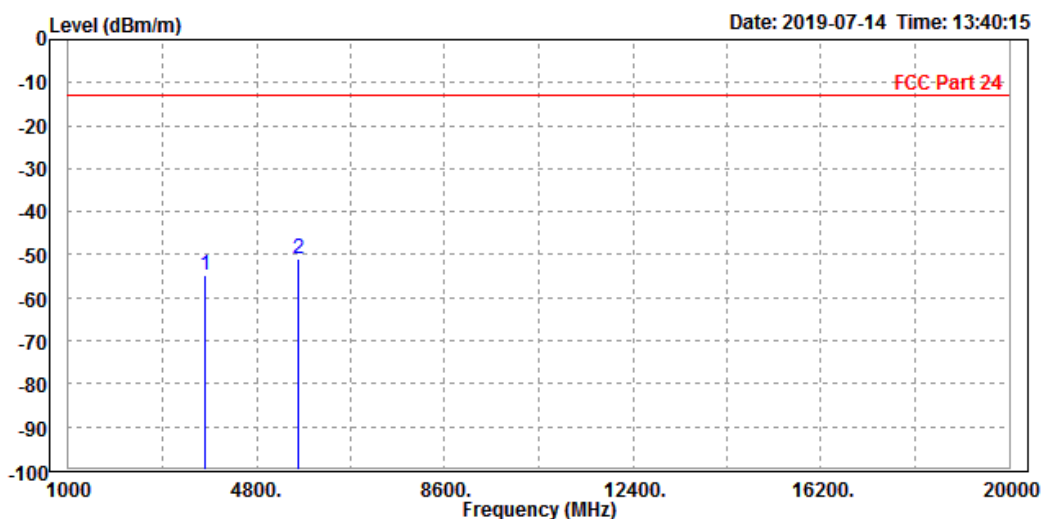



BUREAU VERITAS

Test Report No.: RF190701W004-2

CH 19175

MODE	TX channel 19175	FREQUENCY RANGE	Above 1000MHz
ENVIRONMENTAL CONDITIONS	23deg. C, 70%RH	INPUT POWER	DC 12V from adapter
TESTED BY	Star Le		
ANTENNA POLARITY & TEST DISTANCE: HORIZONTAL AT 3 M			

	Freq	Level	Read Level	Limit Line	Over Limit	Factor	Remark	Pol/Phase
	MHz	dBm/m	dBm	dBm/m	dB	dB/m		
1	3815.000	-55.80	-59.48	-13.00	-42.80	3.68	Peak	Horizontal
2 PP	5725.000	-53.40	-62.62	-13.00	-40.40	9.22	Peak	Horizontal

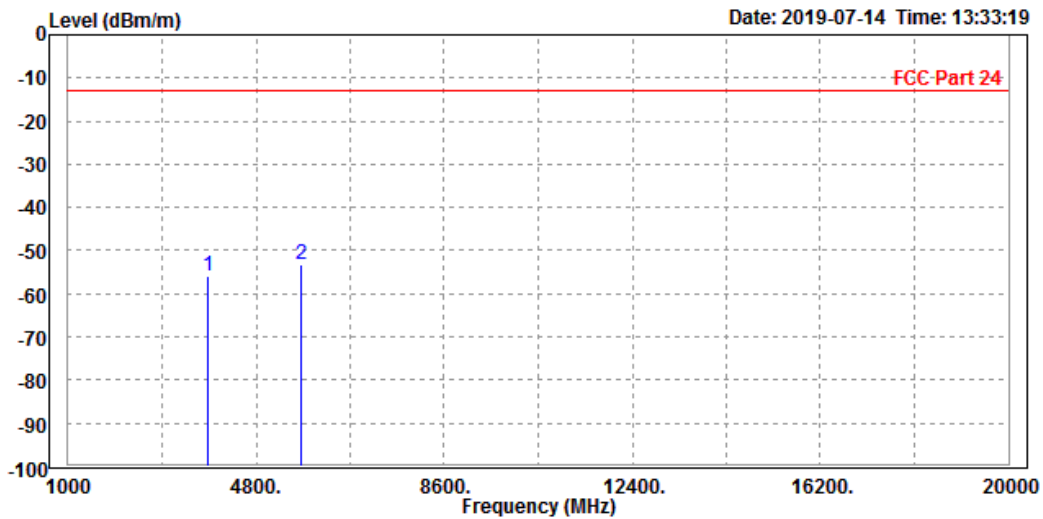



**BUREAU
VERITAS**

Test Report No.: RF190701W004-2

MODE	TX channel 19175	FREQUENCY RANGE	Above 1000MHz
ENVIRONMENTAL CONDITIONS	23deg. C, 70%RH	INPUT POWER	DC 12V from adapter
TESTED BY	Star Le		
ANTENNA POLARITY & TEST DISTANCE: VERTICAL AT 3 M			

	Freq	Level	Read Level	Limit Line	Over Limit	Factor	Remark	Pol/Phase
	MHz	dBm/m	dBm	dBm/m	dB	dB/m		
1	3815.000	-55.48	-59.64	-13.00	-42.48	4.16	Peak	Vertical
2 PP	5725.000	-52.82	-61.25	-13.00	-39.82	8.43	Peak	Vertical

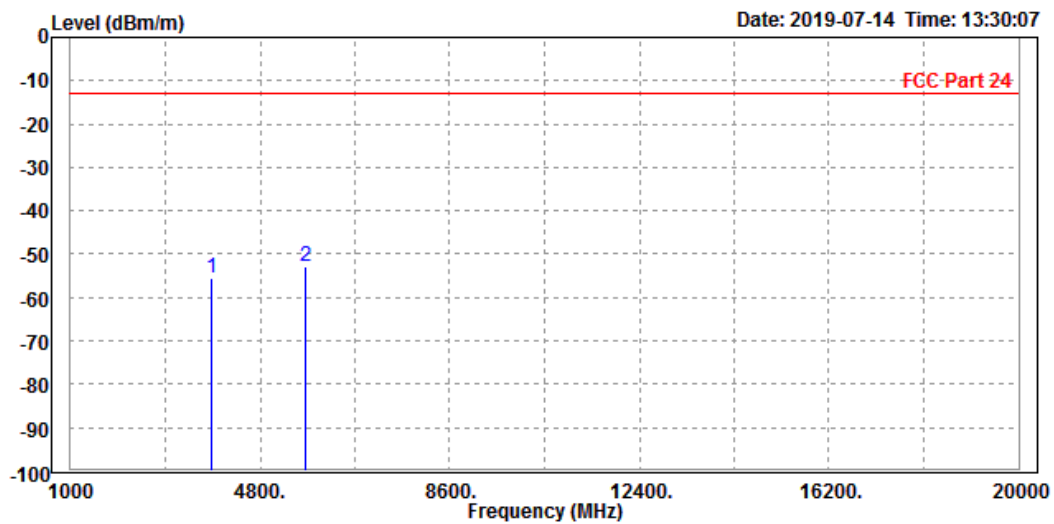



BUREAU VERITAS

Test Report No.: RF190701W004-2

CHANNEL BANDWIDTH: 10MHz / QPSK

MODE	TX channel 18900	FREQUENCY RANGE	Above 1000MHz
ENVIRONMENTAL CONDITIONS	23deg. C, 70%RH	INPUT POWER	DC 12V from adapter
TESTED BY	Star Le		
ANTENNA POLARITY & TEST DISTANCE: HORIZONTAL AT 3 M			

	Freq	Level	Read Level	Limit Line	Over Limit	Factor	Remark	Pol/Phase
	MHz	dBm/m	dBm	dBm/m	dB	dB/m		
1	3755.000	-56.47	-59.86	-13.00	-43.47	3.39	Peak	Horizontal
2 PP	5640.000	-53.19	-62.31	-13.00	-40.19	9.12	Peak	Horizontal

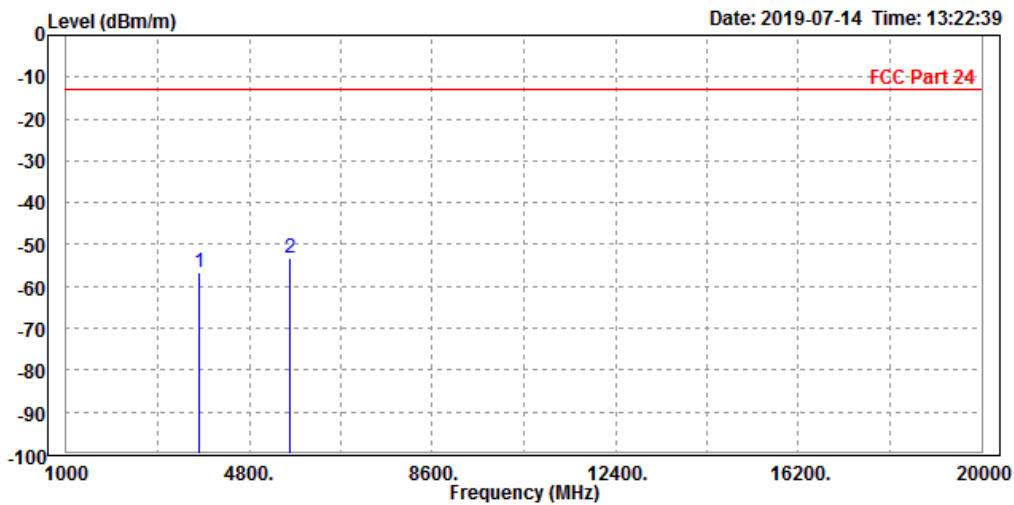



BUREAU VERITAS

Test Report No.: RF190701W004-2

MODE	TX channel 18900	FREQUENCY RANGE	Above 1000MHz
ENVIRONMENTAL CONDITIONS	23deg. C, 70%RH	INPUT POWER	DC 12V from adapter
TESTED BY	Star Le		
ANTENNA POLARITY & TEST DISTANCE: VERTICAL AT 3 M			

	Freq	Level	Read Level	Limit Line	Over Limit	Factor	Remark	Pol/Phase
	MHz	dBm/m	dBm	dBm/m	dB	dB/m		
1	3755.000	-55.11	-58.96	-13.00	-42.11	3.85	Peak	Vertical
2 PP	5640.000	-51.25	-59.51	-13.00	-38.25	8.26	Peak	Vertical

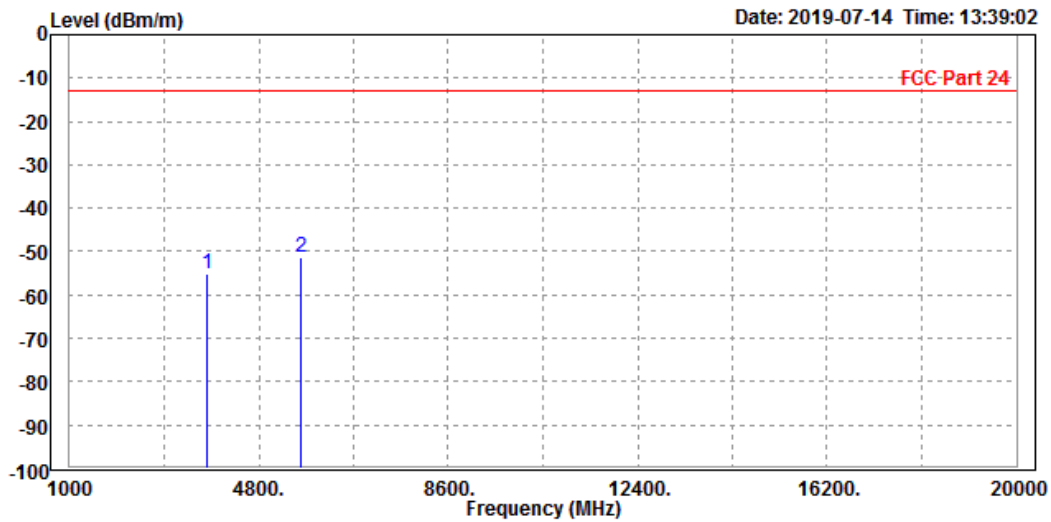



BUREAU VERITAS

Test Report No.: RF190701W004-2

CHANNEL BANDWIDTH: 15MHz / QPSK

MODE	TX channel 18900	FREQUENCY RANGE	Above 1000MHz
ENVIRONMENTAL CONDITIONS	23deg. C, 70%RH	INPUT POWER	DC 12V from adapter
TESTED BY	Star Le		
ANTENNA POLARITY & TEST DISTANCE: HORIZONTAL AT 3 M			

	Freq	Level	Read Level	Limit Line	Over Limit	Factor	Remark	Pol/Phase
	MHz	dBm/m	dBm	dBm/m	dB	dB/m		
1	3755.000	-55.87	-59.26	-13.00	-42.87	3.39	Peak	Horizontal
2 PP	5640.000	-53.46	-62.58	-13.00	-40.46	9.12	Peak	Horizontal

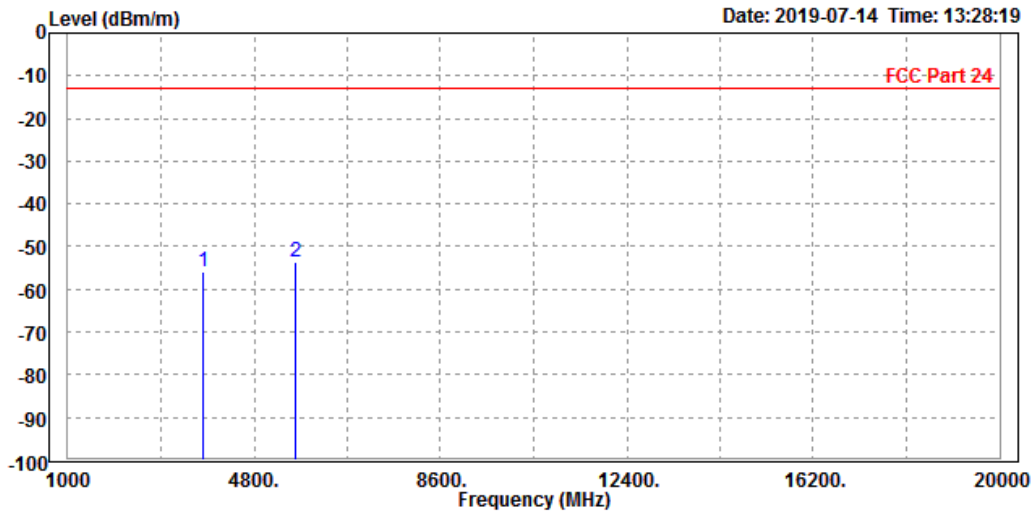



BUREAU VERITAS

Test Report No.: RF190701W004-2

MODE	TX channel 18900	FREQUENCY RANGE	Above 1000MHz
ENVIRONMENTAL CONDITIONS	23deg. C, 70%RH	INPUT POWER	DC 12V from adapter
TESTED BY	Star Le		
ANTENNA POLARITY & TEST DISTANCE: VERTICAL AT 3 M			

	Freq	Level	Read Level	Limit Line	Over Limit	Factor	Remark	Pol/Phase
	MHz	dBm/m	dBm	dBm/m	dB	dB/m		
1	3755.000	-54.79	-58.64	-13.00	-41.79	3.85	Peak	Vertical
2 PP	5640.000	-54.19	-62.45	-13.00	-41.19	8.26	Peak	Vertical

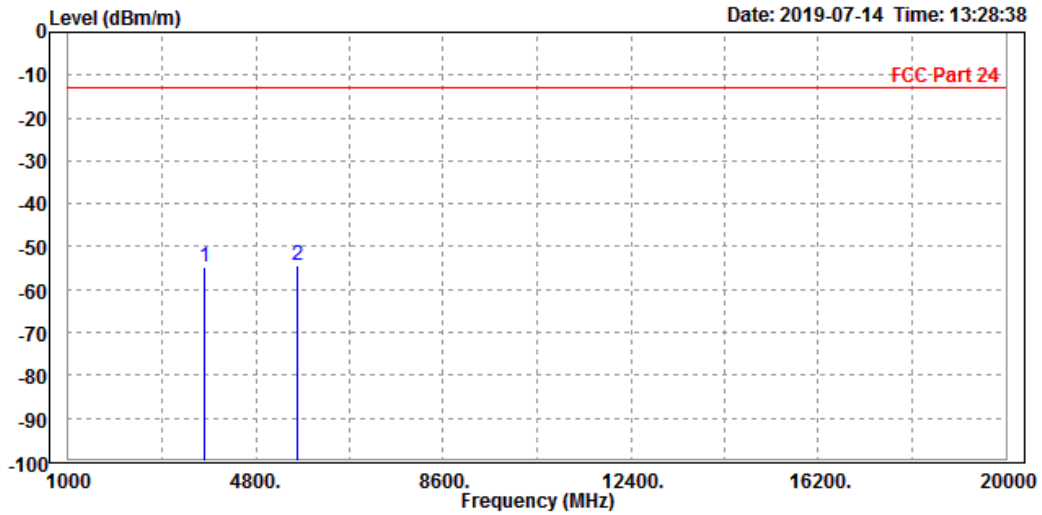



CHANNEL BANDWIDTH: 20MHz / QPSK

MODE	TX channel 18900	FREQUENCY RANGE	Above 1000MHz
ENVIRONMENTAL CONDITIONS	23deg. C, 70%RH	INPUT POWER	DC 12V from adapter
TESTED BY	Star Le		
ANTENNA POLARITY & TEST DISTANCE: HORIZONTAL AT 3 M			

	Freq	Level	Read Level	Limit Line	Over Limit	Factor	Remark	Pol/Phase
	MHz	dBm/m	dBm	dBm/m	dB	dB/m		
1	3755.000	-55.37	-58.76	-13.00	-42.37	3.39	Peak	Horizontal
2 PP	5640.000	-53.23	-62.35	-13.00	-40.23	9.12	Peak	Horizontal

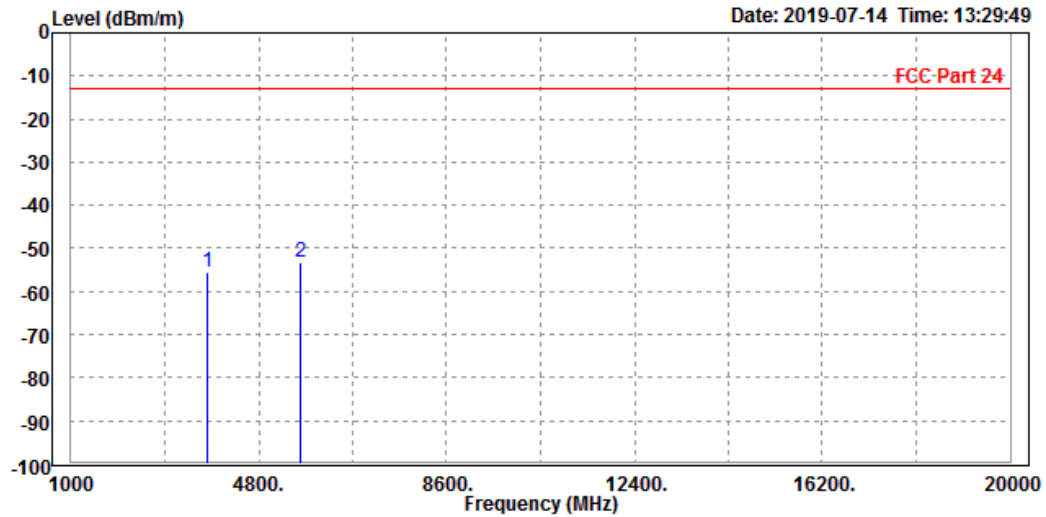



MODE	TX channel 18900	FREQUENCY RANGE	Above 1000MHz
ENVIRONMENTAL CONDITIONS	23deg. C, 70%RH	INPUT POWER	DC 12V from adapter
TESTED BY	Star Le		
ANTENNA POLARITY & TEST DISTANCE: VERTICAL AT 3 M			

	Freq	Level	Read Level	Limit Line	Over Limit	Factor	Remark	Pol/Phase
	MHz	dBm/m	dBm	dBm/m	dB	dB/m		
1	3755.000	-55.84	-59.69	-13.00	-42.84	3.85	Peak	Vertical
2	PP 5640.000	-54.05	-62.31	-13.00	-41.05	8.26	Peak	Vertical

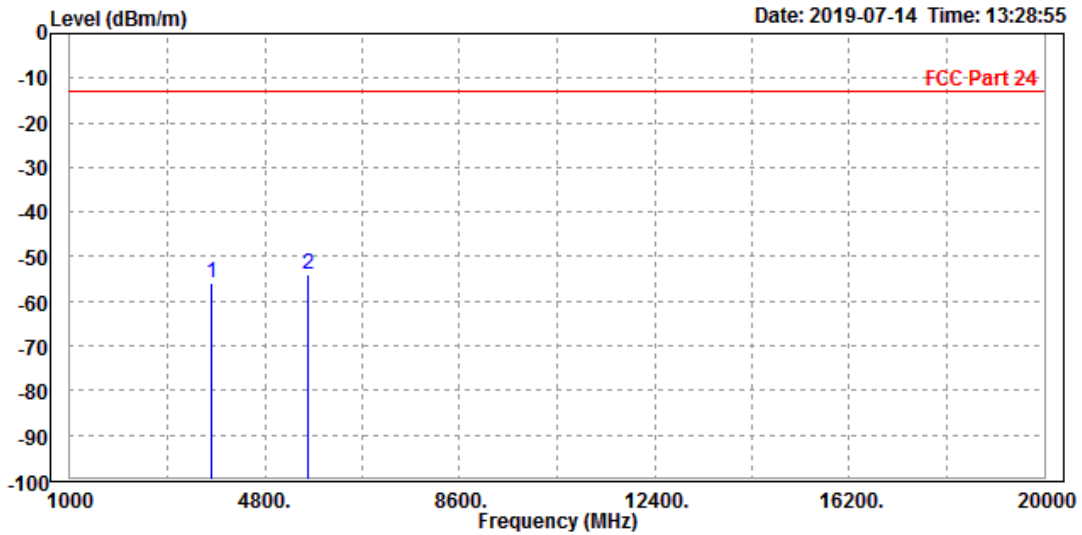



3.7 PEAK TO AVERAGE RATIO

3.7.1 LIMITS OF peak to average ratio MEASUREMENT

In measuring transmissions in this band using an average power technique, the peak to-average ratio (PAR) of the transmission may not exceed 13 dB

3.7.2 TEST SETUP

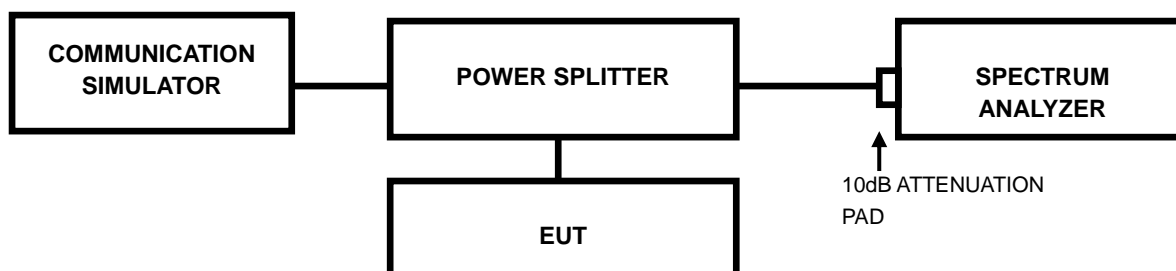

3.7.3 TEST PROCEDURES

1. Set resolution/measurement bandwidth \geq signal's occupied bandwidth;
2. Set the number of counts to a value that stabilizes the measured CCDF curve;
3. Record the maximum PAPR level associated with a probability of 0.1%.

3.7.4 TEST RESULTS

The test results was recorded in Report No.: RXA1706-0199RF02R1.



BUREAU VERITAS Test Report No.: RF190701W004-2

4 INFORMATION ON THE TESTING LABORATORIES

We, BV 7LAYERS COMMUNICATIONS TECHNOLOGY (SHENZHEN) CO. LTD., were founded in 2015 to provide our best service in EMC, Radio, Telecom and Safety consultation. Our laboratories are accredited and approved according to ISO/IEC 17025.

If you have any comments, please feel free to contact us at the following:

Shenzhen EMC/RF Lab:

Tel: +86-755-88696566

Fax: +86-755-88696577

Email: customerservice.dg@cn.bureauveritas.com

Web Site: www.adt.com.tw

The address and road map of all our labs can be found in our web site also.



BUREAU Test Report No.: RF190701W004-2
VERITAS

5 APPENDIX A – MODIFICATIONS RECORDERS FOR ENGINEERING CHANGES TO THE EUT BY THE LAB

No any modifications are made to the EUT by the lab during the test.

---END---