

User Manual

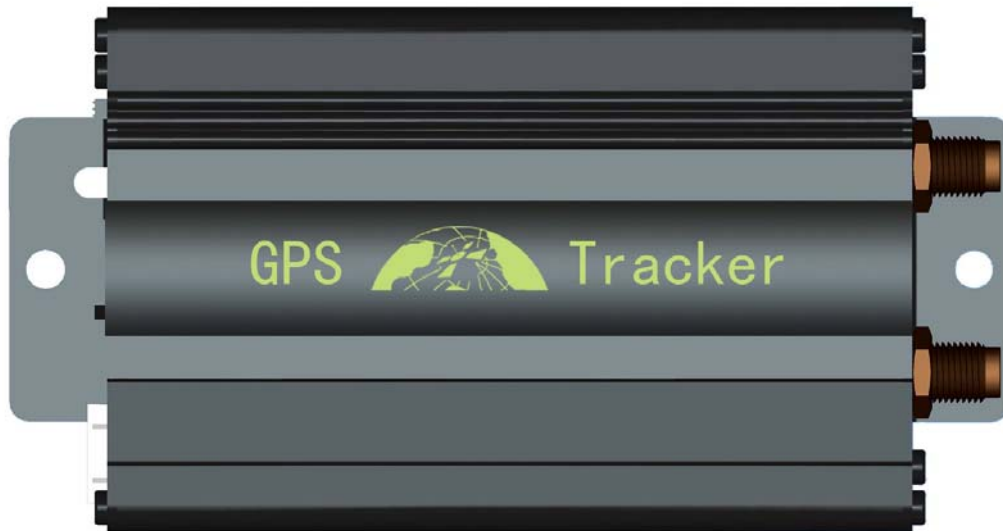

Preface

Thank you for purchasing the tracker. This manual shows how to operate the device smoothly and correctly. Make sure to read this manual carefully before using this product. Please note that specification and information are subject to changes without prior notice in this manual. Any change will be integrated in the latest release. The manufacturer assumes no responsibility for any errors or omissions in this document.

Contents

1.	Function Introduction.....	4
2.	Applications	4
3.	Hardware Description	4
4.	Accessories	5
5.	Specifications.....	6
6.	Operating Instructions.....	6
6.1	Terminal Installation	6
6.2	SIM CARD Installations.....	7
6.3	Turn on the Tracker Device	8
6.4	WCDMA/GSM/GPS LED Indicator	8
6.5	Initialization	8
6.6	Change Password.....	8
6.7	Authorization	9
6.8	Single Locating	9
6.9	Auto track continuously	10
6.9.1	Track with limited times upon time interval.....	10
6.9.2	Track with unlimited times upon time interval.....	10
6.9.3	Smart track upon time and distance interval.....	10
6.10	Turning points update automatically.....	10
6.11	GPS drift suppression	11
6.12	Exact street address.....	11
6.13	Location based service (LBS) / Cell-ID Locating	11
6.14	Monitor	11
6.15	Data logging.....	12
6.16	Data Load.....	12
6.17	Forward the third parties' message	12
6.18	SIM card Balance Inquiry	12
6.19	ACC working alarm.....	13
6.20	Cut off the Oil and Power System	13
6.21	Calibration of fuel sensor.....	14
6.22	Function of Remote Controller (Option, for model B ONLY)	14
6.23	Arm	14
6.24	Disarm.....	15
6.25	Silent Mode.....	15
6.26	Decide how many times of alarm message.....	15
6.27	Alarms.....	16
6.27.1	Low battery alarm.....	16
6.27.2	Power off alarm.....	16
6.27.3	GPS blind Spot alert.....	16
6.27.4	SOS	16
6.27.5	Geo-fence.....	16

6.27.6	Multi-area management	17
6.27.7	Movement alarm	17
6.27.8	Over speed alarm	18
6.27.9	Fuel alarm	18
6.28	Alarms under Arm State.....	18
6.28.1	Door open alarm	18
6.28.2	ACC Alarm	18
6.28.3	External Shock Sensor alarm(Optional)	18
6.28.4	Built in Acceleration Sensor Alarm	19
6.28.5	Alarm without WCDMA/GSM network service	19
6.29	Sleep Mode	19
6.30	Check the Vehicle State.....	20
6.31	Check IMEI.....	20
6.32	Terminal (local) Time Setting	21
6.33	Reset Hardware	21
6.34	Configure parameters by USB	21
6.35	GPRS Setting	21
6.36	Activate "Fuel" value in GPRS data	22
6.37	Instructions for web platform and mobile APP.....	22
7.	Cautions	28
8.	Faults & the Solutions.....	29

1. Function Introduction

1.1. This tracker is a new product based on the WCDMA/GSM/GPRS network and GPS satellite positioning system, which set multiple functions of security, positioning, monitoring surveillance, emergency alarms and tracking in its entirety. It can track and monitor remote target by SMS or internet.

1.2. Features

- 1.2.1 Support both GPS & LBS (Location based service).
- 1.2.2 Support SMS/GPRS/Internet Network data transmission
- 1.2.3 Support reconnected automatically by the internet of WCDMA/GSM/GPRS
- 1.2.4 Support SMS / internet(GPRS) dual-mode switching
- 1.2.5 Support configuration by remote terminal.
- 1.2.6 Support for point-to-point, point to group, group-to-group monitoring.
- 1.2.7 Set multiple functions of security, positioning, monitoring surveillance, emergency alarms and tracking in its entirety.

2. Applications

Used widely for vehicle and other moving objects tracking.

3. Hardware Description

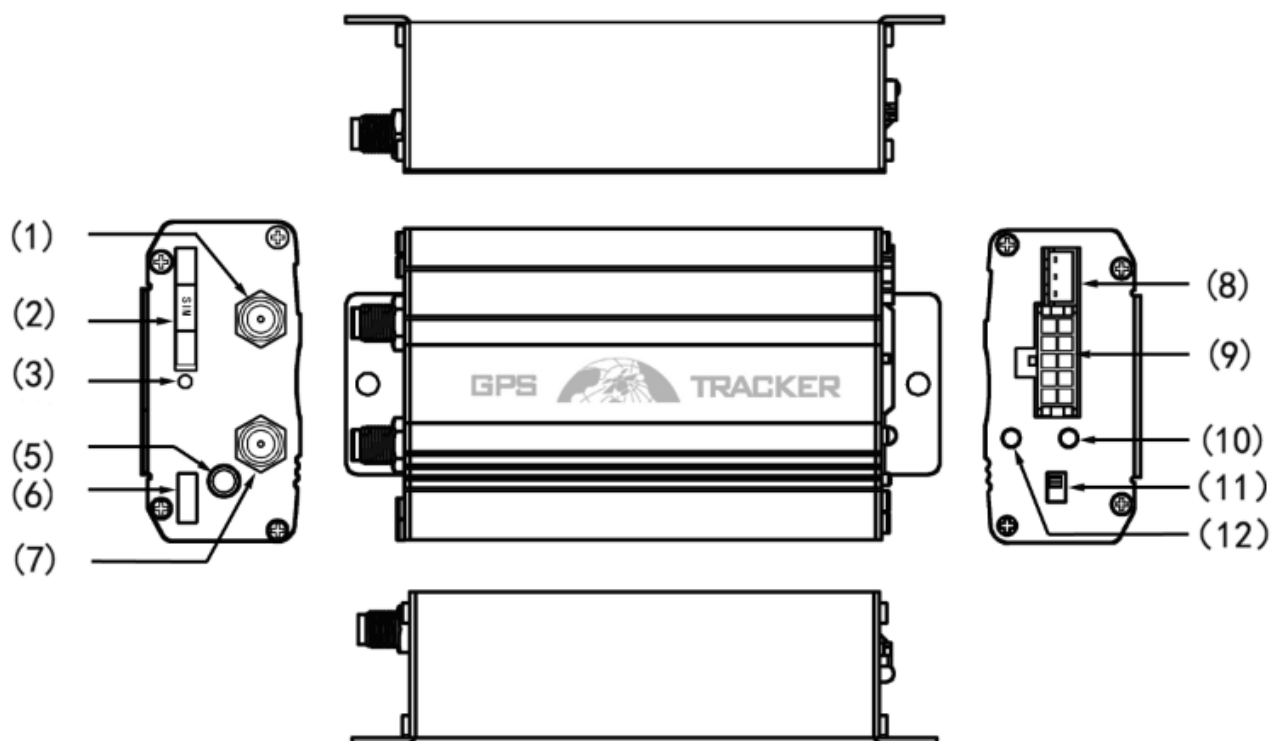

- | | |
|---------------------------------|---------------------------|
| (1) WCDMA/GSM Antenna connector | (7) GPS Antenna connector |
| (2) SIM card slot | (8) Shock sensor port |
| (3) SIM card slot Pop-up switch | (9) Harness Port |

- (5) Microphone jack
- (6) Micro USB
- (12) Remote controller antenna(Optional for Model B only)
- (10) WCDMA/GSM/GPS LED
- (11) Back-up battery switch

4. Accessories

No.	photoes	NAME	note
1		GPS Antenna	2 meters
2		WCDMA/GSM Antenna	2 meters
3		Microphone	1.5 meters
4		Harness	10PIN
5		Relay	12V/40A to 24V/40A according to vehicles
6		Shock sensor	Option for both model A and B
7		Siren	Option for both model A and B
8		Remote controller	Option for model B ONLY

9		Fuel Sensor	Option for both model A and B
---	---	-------------	-------------------------------

5. Specifications

Content	specifications
DIM.	83*54*26mm
Weight	120g
Network	WCDMA/GSM/GPRS
Band	WCDMA (3G): 850MHz/1900MHz/2100(only for CE)
	GSM (2G): 850/900/1800/1900MHz
GPS Sensitivity	-159dBm
GPS Accuracy	5m
GPS Start time	Cold status 45s
	Warm status 35s
	Hot status 1s
Voltage	12 V-24V DC
Backup battery	Chargeable 3.7V 350mAh Polymer Li-Battery
Storage Temp.	-40°C to +85°C
Operation Temp.	-20°C to +65°C
Humidity	5%--95% non-condensing

6. Operating Instructions

6.1 Terminal Installation

6.1.1 Please ask the qualified engineers to install it.

6.1.2 Do not install it in an environment which is over WCDMA/GSM performance index, and please pay attention to fix the antennas in an appropriate position with good signals.

6.1.3 Pay attention to make installation location preventing water and dust.

6.1.4 Find the 10 PIN harness and insert it into the corresponding holes of the products, and connect the wires with the original car circuit showing below:

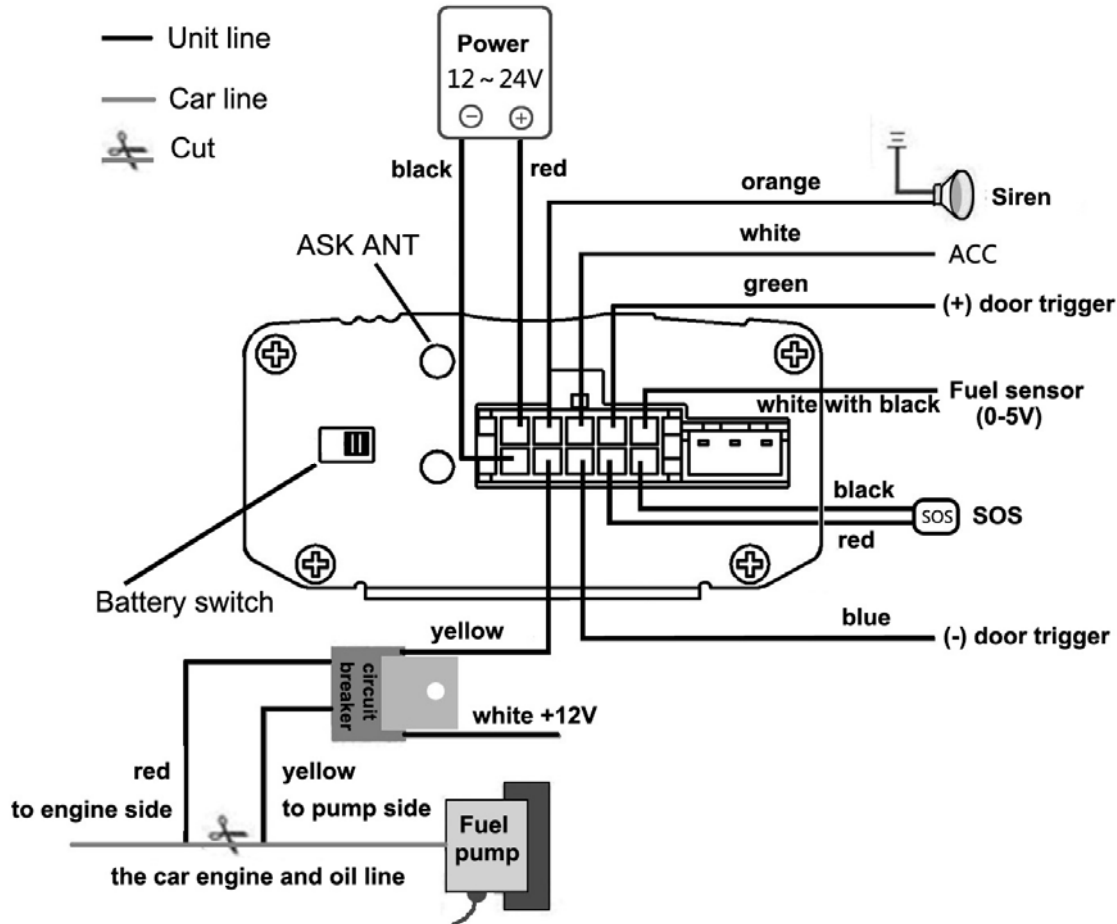

Wiring diagram

6.1.5 Note: The orange wire can be connected to the original car horn; it can also be connected to the siren you buy with the tracker. (Siren is Option)

6.1.6 Knowing about the type of the door trigger is positive or negative trigger. Please connect the green wire to the door control circuit if it is positive, and connect blue wire if it is negative.

6.1.7 Please put SOS button at the place driver can touch.

6.1.8 Insert the external shock sensor plug into the sensor jack. (External shock sensor is Option)

6.1.9 Insert the external monitor Microphone into the monitor jack.

6.1.10 Connect the GPS and WCDMA/GSM antenna to the right connector, and find an appropriate place to fix the antennas to make sure it receives signals well.

6.2 SIM CARD Installations

6.2.1 Use a tweezers or a sharp thing to touch the SIM CARD popup switch, the SIM CARD slot will pop up, take out the SIM card slot and put SIM card in it. And then put the SIM card slot back to its original position after confirm the SIM card in the right place.

6.2.2 Please make sure the SIM card is for WCDMA/GSM network and able to execute the function of incoming calls display, no calls can be diverted and the PIN code is

locked. The SMS format must be TXT format, and can't recognize the PDU format.

6.3 Turn on the Tracker Device

Connect the positive and negative wire, red and black ones, with 12V or 24V car power system, wait for 1 minute after connecting power to wait tracker works normal, and then turn on the backup battery switch.

6.4 WCDMA/GSM/GPS LED Indicator

LED Indicator Type	Behavior	Meaning
Red LED	ON	No WCDMA/GSM signal
	Flash quickly, 1 time per second	SMS mode with good reception
	Flash slowly, 1 time per 3 seconds	Internet (GPRS) mode
Green LED	ON	Fix to satellites
	OFF	Lost fix to satellites

6.5 Initialization

Send SMS "begin+password" to the unit, it will reply "begin ok" and initialize all the settings to default factory settings. (default password: 123456)

For example: send SMS "begin123456", it will reply "begin ok". (No quotation marks"" when sending all the SMS)

6.6 Change Password

6.6.1 Send SMS " password+old password+space+new password" to the unit to change the password.

For example: send SMS "password123456 888888" to the unit. If succeeded, "password ok" will reply to your cell phone from the device tracker.

6.6.2 Be sure to keep the new password in mind, you have to upload the software to restore the original setting in case of losing the new password.

6.6.3 Attention: Make sure the new password is in 6 digits Arabic numbers, or else the tracker cannot recognize the password.

6.6.4 When reading this user manual, you will notice that we have used "+" and "space" between some words;"+" between two words means they should be written together as one word and "space" between two words means you should leave one character space

between two words.

6.7 Authorization

- 6.7.1 You must setup the authorized phone number before using SOS, geo-fence alarm, etc. Up to 5 numbers can be authorized.
- 6.7.2 Call the tracker for 10 times continuously and get its position, then it will save the cell phone number as the authorized number automatically. and reply “add master ok”.
- 6.7.3 Authorization: Send SMS “admin+password+space+cell phone number” to set up an authorized number, the other authorized numbers should be set by the first authorized number, if the number is successfully authorized, the unit will reply “ admin OK” by SMS.
- 6.7.4 Delete authorization: Send SMS “noadmin+password+space+authorized number” to delete the authorized number.
- 6.7.5 If you want to track the target when it enters into another country, you must add the country code before the cell phone number. You should authorize your number in international format as follows: “admin123456 008613322221111” to tracker to set 13322221111 as an authorized number.

6.8 Single Locating

- 6.8.1 If there aren't any authorized number set-up, it will reply all calls with a location report; if there are authorized numbers set-up, then it will not respond when an unauthorized number calls it.
- 6.8.2 If you call it from authorized phone number, it will hang up and report a real-time location as below:



- 6.8.3 When lost fix to satellites, the message will includes the last known GPS position and the LAC code of current position as well.

6.9 Auto track continuously

6.9.1 Track with limited times upon time interval

Send SMS command “fix030s005n +password” to the tracker device, it will report the latitude & longitude at intervals of 30 seconds for 5 times. (s:second, m:minute, h:hour). This command set must be in 3 digits Arabic numbers and the maximum value is 255.

e.g. fix030s005n123456

6.9.2 Track with unlimited times upon time interval

Send SMS “fix030s030m***n+password” to the tracker. Tracker will report a real-time location every 30 seconds when ACC is ON, and report every 30 minutes when ACC is OFF.

Note: The interval must not less than 10s.

6.9.3 Smart track upon time and distance interval

6.9.3.1 Please set "track with unlimited times upon time interval" before this function, and send "distance+password+space+distance", tracker will reply "Distance ok", and then tracker will locate upon both the pre-set time and distance.

e.g. Send "distance123456 0050", it means distance is 50 meters; the number must be 4 digits Arabic numbers.

6.9.3.2 Set this function on web platform: Set time interval first and then distance interval, tracker will locate upon the time and distance.

6.9.3.3 Cancel: Send SMS “nofix+password” to the tracker device to cancel the “auto track”.
e.g. nofix123456

6.10 Turning points update automatically

6.10.1 The tracker will update the positions automatically to web platform once the vehicle changing driving direction over pre set angle value to form a smooth trajectory consistent with the actual road, this function is only effective in GPRS mode.

6.10.2 Send "angle+password+space+angle" to tracker, it will reply" angle ok". e.g. angle123456 040

6.10.3 The angle must be 3 digits Arabic numbers, default angle value is 30 degree.

6.11 GPS drift suppression

- 6.11.1 This function is deactivated by default, to activate this function, send SMS "suppress+password" to tracker, it will reply "suppress drift ok". The GPS data stop updating if vehicle is not driving (ACC is OFF) and latitude and longitude always keep same, and GPS data updates automatically when vehicle is moving.
- 6.11.2 Cancel: send "nosuppress+password" to tracker, it will reply "nosuppress ok".

6.12 Exact street address

- 6.12.1 You must set up the APN of your local WCDMA/GSM network for the SIM card in tracker first before using this function, if there is user name and password for GPRS login, Please refer to 6.35 section of this manual to configure the APN, user name and password for GPRS login.
- 6.12.2 After configure the APN, send "address+password" to device, it will reply SMS including real street/address name. For example: No.113, Guankou 2nd Rd, Nantou, Nanshan district, Shenzhen, Guangdong, china.

6.13 Location based service (LBS) / Cell-ID Locating

If the tracker cannot establish a solid GPS Fix, it will calculate its location using Cell-ID GSM locating, Location reports will include the GPS coordinates of the last known positions as well as a LAC code, You can send command "address+password" to the tracker to request exact address in SMS mode, tracker will automatically switch to tracking by LBS in GPRS mode and showing its position on the map with LBS mark. Accuracy of LBS depends on the distance to the nearest WCDMA/GSM Network Cell Tower or Base Station.

Note: This feature can be used normally in most areas according to the signal of WCDMA/GSM network. It may not be available in some areas.

6.14 Monitor

- 6.14.1 The command to switch between Tracker mode and Monitor mode are "tracker" and "monitor".The default mode is "tracker" (Tracker mode).
- 6.14.2 Send SMS "monitor+password" to the unit, and it will reply "monitor ok!" and switch to "monitor" mode.
- 6.14.3 Send SMS "tracker+password" to the unit, and it will reply "tracker ok!" and switch to "tracker" mode.

6.15 Data logging

- 6.15.1 Auto logging: When the tracker device lost GSM signals or GPRS disconnected, tracker will log the tracking position and alerts automatically on the basis of the pre-set condition, when GSM signals get back, all the data will be auto-sent to the authorized numbers or web platform (server).
- 6.15.2 Logging upon times: Send SMS: "save030s005n+password" to the tracker unit, it will reply "save ok", and will log the Latitude and longitude locations every 30 seconds for 5 times. (S: second, m: minute; h: hour).
- 6.15.3 Multi-logging: Send SMS:"save030s***n+password" to tracker device, it will reply "save ok".
- 6.15.4 Cancel logging: Send SMS "nosave+password", e.g. nosave123456
- 6.15.5 Logging Clearance: send SMS: "clear+password" to tracker device, it will reply "clear ok".
- 6.15.6 Logging Volume: 1.7G internal memory.
- 6.15.7 Note: It won't save in GPRS mode if configured auto track intervals because it will track according to the intervals in real time, data will be saved in other situation, and the saved data will be sent to server automatically when GPRS back.

6.16 Data Load

The positions during the time of GSM signal lost will be sent to server automatically when GSM signals recover.

6.17 Forward the third parties' message

- 6.17.1 Send SMS "forward+password+space+third parties phone number" from authorized phone number, tracker will reply"forward ok", and supports 1 third parties phone numbers at most.
For example, set the phone number of the service provider of the SIM card in the tracker, when charge remind message coming in, tracker will forward it to authorized phone number.
- 6.17.2 Cancel: Send SMS command "noforward+password".

6.18 SIM card Balance Inquiry

- 6.18.1 Send SMS command "balance+password+space+carrier's phone number+space+code" to tracker, it will forward the code to carrier's phone number and return the balance message received from carrier's phone number.

6.18.2 How it works: After accept balance command, tracker will remember the “mobile phone number”, carrier’s phone number and the code;

6.18.3 And then send the code to carrier’s phone number, and forward the message from carrier to mobile phone number.

Take china mobile for example, mobile users can send “ye” to china mobile number 10086, and 10086 will send user’s balance message to tracker, and then tracker forward the balance message to mobile phone number , following is an illustration how this function works.

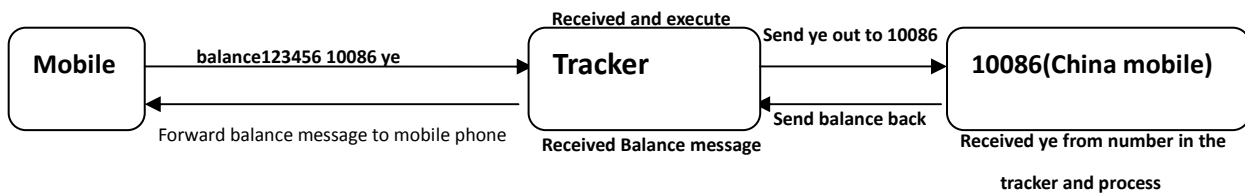

6.19 ACC working alarm

6.19.1 This function is deactivated by default. To active this functions, send "ACC+password" to tracker, it will reply "ACC ok". And tracker will send "ACC on+latitude & longitude" to authorized numbers when detect ignition on, that means the vehicle has been started; and tracker will send “ACC off+latitude & longitude" to authorized numbers when ignition off and ACC is off, that means vehicles has been stopped.

6.19.2 Send "noACC+password" to deactivate this function, tracker will reply "noACC ok".

6.19.3 This configuration can only activate and deactivate the alarm to authorized numbers; it will send to web platform automatically in GPRS mode and can't be deactivated.

6.20 Cut off the Oil and Power System

6.20.1 Send command “stop+password” to tracker, tracker will execute it and reply “Stop engine Succeed”. And it will remain immobile state until next command to resume.

6.20.2 Stop mode

Execute immediately: Send command “quickstop+password” to tracker, it will reply “quickstop OK”. Then tracker will stop the car immediately after “stop+password” command.

Execute depends on speed(Default mode): Send command “noquickstop+password” to tracker, It will reply “noquickstop OK”, Then the tracker won't stop the car immediately after “stop” command, instead, it will reply “it will be executed after speed

less than 20KM/H”, and stop the car when the speed is less than 20KM/H.

6.20.3 Resume the Oil and Power System

Send “resume+password” to tracker, it will reply "Resume engine succeed", it means the oil supply is resumed .







6.21 Calibration of fuel sensor

6.21.1 Due to the different height of fuel tank and fuel level sensor specifications, tracker need to set an appropriate zero value and full range value to detect the precise fuel percentage.

6.21.2 Zero calibration: Send “ oilzero+password “ to tracker when the fuel tank is empty , tracker will adjust to zero and reply “ oilzero ok!” . The fuel value is 0%.

6.21.3 Full calibration: Send “oilfull+password “ to tracker when the fuel tank is full , then tracker will adjust to full range and reply “ oilfull ok! “ . The fuel value is 100%.

6.22 Function of Remote Controller (Option, for model B ONLY)

Button	Function	Descriptions
	ARM	Press for 0.5 second, the siren will beep one time.
	DISARM	Press for 0.5 second, the siren will beep two times.
	ARM & Silent mode	Press for 0.5 second when it is in disarm state, the siren will beep one times. No voice from siren when alarm triggered and quit from silent mode automatically when disarm.
	SOS	Press for 3 seconds, Tracker will send SOS alert to authorized phone numbers without voice.
	Deterrence/ car search	Press for 0.5 second when it is in arm state, siren will beep 10 seconds, press disarm button  to quit.

6.23 Arm

6.23.1 Set up arm by SMS

Send SMS command “arm+password” to the tracker device in the vehicle. It will reply “Tracker is activated” in both armed and disarmed state, and the SMS command will make the tracker device enter into armed state if the unit currently disarmed.

User must stop the engine, (that is ACC is lower voltage).Sending SMS “arm+password” when close the door and left. You will set up arm status fail if the engine is turned on (the ACC is high voltage), it will reply “set up fail! pls turn off ACC”

6.23.2 Set up arm by remote controller (Option, for model B ONLY)

Press  button on the remote controller for 0.5 seconds, the car enters into armed state and the siren will beep one time, no SMS reply.

6.24 Disarm

6.24.1 Disarm by SMS

Send SMS command "disarm + password" to the tracker device in the vehicle, It will reply "Tracker is deactivated" in both armed and disarmed state, and the SMS command will make the tracker device enter into disarmed state if the unit currently armed. It won't alarm if the door is open and sensor is vibrated and the engine is started when arm function is deactivated .

6.24.2 Disarm by remote controller (Option, for model B ONLY)

Press  button on the remote controller, the car enters into disarm state, and the siren will beep two times, no SMS sent.

6.25 Silent Mode

6.25.1 Set up silent mode by SMS

Send SMS "silent+password" to tracker device, it will reply "silent ok!". It means tracker device enters into silent mode, siren won't be sound after alarm is triggered, but tracker will send alarm SMS to authorized number.

Send disarm command "disarm+password" to quit silent mode .

6.25.2 Set up silent mode by remote controller (Option, for model B ONLY)

Press  in disarm state for 0.5 second, the siren will beep one time, Tracker device enters into silent mode, siren won't be sound after alarm is triggered, but tracker will send alarm SMS to authorized numbers.

Press  to quit silent mode.

6.26 Decide how many times of alarm message

You can decide how many times of the alarm message to be sent, For those alarm message sent in cycle, you can limit the times the alarm message to be sent. send SMS " xtime+password+005 " to tracker, alarm message will be sent 5 times once alarms are triggered .

Alarm SMS will be sent 5 times by default.

6.27 Alarms

6.27.1 Low battery alarm

- 6.27.1.1 Send SMS “lowbattery+password+space+on”, it will send SMS “low battery+latitude/longitude” to authorized numbers 2 times in total **in 15 minutes interval** when voltage of battery is going to be about 3.55V.
- 6.27.1.2 This function activates by default, send SMS “lowbattery+password+space+off” to deactivate.

6.27.2 Power off alarm

- 6.27.2.1 Send “ extpower+password+space+on” to activate, it will send SMS “power alarm+latitude/longitude” to authorized numbers every 3 minutes when external power is cut off.
- 6.27.2.2 This function activates by default.
Cancel: Send SMS “ extpower+password+space+off” to deactivate it.

6.27.3 GPS blind Spot alert

- 6.27.3.1 This function deactivates by default, send SMS “gpssignal+password+space+on”, it will send alert SMS “no gps+last valid latitude/longitude before lost signal”
- 6.27.3.2 Send SMS “gpssignal+password+space+off” to deactivate.

6.27.4 SOS

Long Press the SOS button for 3 seconds (For model B, press  button on remote controller for 3 seconds), the tracker device will send SMS “help me!+lat./long.” to all the authorized numbers at interval of 3 minutes. It will stop sending such a SMS when any authorized number reply SMS “help me!” to the tracker.

6.27.5 Geo-fence

- 6.27.5.1 Set up a geo-fence for the tracker device to restrict its movements within a district. The unit will send SMS to the authorized numbers when it goes out of this district.
- 6.27.5.2 Set up: When the unit stays immobile in a place for 3-10 minutes, the user can send

SMS“stockade+password+space+latitude,longitude;latitude,longitude” to unit to set the restricted district. In case of breach, it will send SMS “stockade!+ latitude & longitude” to the authorized numbers.

Remark: The first latitude & longitude is coordinate of the top left corner of the Geo-fence, while the second latitude & longitude is the coordinate of the bottom right corner, it will send alarm SMS at interval of 3 minutes once beyond the restricted district.

6.27.5.3 Cancel: Send SMS “nostockade+password” to deactivate this function.

6.27.6 Multi-area management

6.27.6.1 Set Area

Send SMS command

"area+password+space+latitude,longitude+space+areaname,distanceM" to tracker(distance unit: M for meter, K for kilometer), it will reply "area01 ok".

Example: Send "area123456 22.353648,113.543678 school,800M".

Note: 5 areas at most and the distance between two points can't be less than the total distance in the 2 commands, and different areas can't cover each other.

6.27.6.2 Delete areas

Send SMS command:"noarea+password+space+area name", tracker will reply:"noarea ok".

6.27.6.3 Rename and set distance

Send SMS command "rename+password+space+old name;new name,distanceM" to tracker, if name is not repeated and area doesn't cover others, it will reply "rename ok!" for successful configuration.

Example: Send"rename123456 area01;school,800M", it means the new area name is "school", and covers area of a radius of 800 meters.

6.27.6.4 Activate multi-area management

Send SMS command "area+password+space+on" to tracker, it will reply "Area on ok!", when tracker enter the pre set area, it will send SMS "area name+latitude & longitude" to all the authorized phone number, and send same SMS when goes out of the area.

6.27.6.5 Deactivate Multi-area management

Send SMS command "area+password+space+off" to tracker, it will reply"area off ok!"

6.27.7 Movement alarm

6.27.7.1 Set up: when the unit stays immobile in a place for 3-10 minutes with GPS signal reception, the user can send SMS“move+password+space+0200” to the tracker (Suppose area of a radius of 200 meters, it supports 4 digits at most. Unit: Meter). It will reply “move OK”. In case of such a movement (the default distance is 200m), it will send SMS “Move+ latitude & longitude” to the authorized numbers at interval of 3 minutes.

6.27.7.2 Cancel: Send SMS “nomove+password” to deactivate the movement alarm.

6.27.8 Over speed alarm

6.27.8.1 Set up: Send SMS “speed+password+space+080” to the unit (suppose the speed is 80km/h), and it will reply “speed OK!”. When the target moves exceeding 80km/h, the unit will send SMS “speed+080!+ latitude & longitude” to the authorized numbers ,it will only send one SMS in 3 minutes in SMS mode when overspeed ; the siren will beep 1 time when overspeed 1 time.

6.27.8.2 Cancel: Send SMS “nospeed+password” to deactivate the overspeed alarm.

Remark: The recommended speed should be not less than 30km/h. For below that rate, it will be effected the accuracy by GPS signals drift etc.

6.27.9 Fuel alarm

6.27.9.1 When the fuel consumption exceeds the normal standards during driving, or oil theft/leakage when the vehicle is stopped, the tracker will send "oil: xx% + Geo-info" to the authorized number at interval of 3 minutes. The horn beeps 20S.

6.27.9.2 Cancel: Send SMS command “ nooil+password” to tracker.

6.28 Alarms under Arm State

6.28.1 Door open alarm

The unit will send SMS “Door alarm+lat/long” to the authorized number at interval of 3 minutes when the door of the car opens in arm status. Siren will be sound for 20 seconds, and repeat sound at interval of 20 seconds minutes if the door is always open. Disarm to stop this alarm

6.28.2 ACC Alarm

The unit will send SMS “ACC alarm+lat/long” to the authorized number at interval of 3 minutes when the engine of the car is turned on, that is the key is rotated to “ACC ON” position to start the car in arm state; Siren will be sound for 20 seconds, and repeat again at interval of 20 seconds if the ACC always keep ON.

Disarm to stop this alarm

6.28.3 External Shock Sensor alarm(Optional)

The unit will send only one alarm SMS “Sensor alarm+lat/long” to the authorized

number in 3 minutes when the sensor is triggered in arm status. Within 3 minutes, the alarm siren sound for 5 seconds when the vibration is detected in the first time and second time. The alarm siren sound for 10 seconds when vibration again. If you disarm the tracker, the times will reset.

Disarm to stop this alarm.

6.28.4 Built in Acceleration Sensor Alarm

The tracker is built in three axis acceleration sensor, the tracker can detect it in arm state when the vehicle move, tilt or shock. The alarm way is same as the external shock sensor alarm.

Disarm to stop this alarm.

Built in Shock sensor sensitivity configuration

The sensitivity of the built-in shock sensor has three different level:

First level: Alarm will be triggered after detect slight vibration, send command "sensitivity+password+space+1" .

Second level: Alarm will be triggered after detect 8 times vibration in 2 seconds, send command "sensitivity+password+space+2".

Third level: Alarm will be triggered after detect 25 times vibration in 5 seconds, send command "sensitivity+password+space+3".

6.28.5 Alarm without WCDMA/GSM network service

When the car is in the place without WCDMA/GSM network service, siren will be sound under non-silent mode if alarm is triggered (door, sensor, ACC), but no SMS alarm will send to authorized number.

6.29 Sleep Mode

	SMS Mode	GPRS Mode	Set Less GPRS Traffic in GPRS Mode
No Sleep	Work	Online	ACC Off. No Calling, SMS and any triggered alarm, GPRS disconnect and switch to SMS mode, sleep. ACC on or Calling, SMS and any triggered alarm can awake it, and GPRS connect
Sleep	ACC off. No Calling, SMS and any triggered alarm, go to sleep, GPS module shut off, WCDMA/GSM	Online	ACC Off. No Calling, SMS and any triggered alarm, GPRS disconnect and switch to SMS mode, go to sleep. ACC on or Calling, SMS and any triggered alarm can awake it, and GPRS connect.

	module work in low power consumption. ACC On or Calling, SMS and any triggered alarm can awake it.		
--	--	--	--

6.29.1 This function is deactivated by default, send “sleep+password+space+on”, tracker will reply “sleep on ok”. When vehicle is not driving (ACC is OFF), WCDMA/GSM module fall asleep; GPS module shut off; and tracker works in low power consumption. Calling, SMS command and any triggered alarm can awake it.

And less gprs traffic function will be activated by default in sleep mode.

GPRS disconnected and will be connected again when there is alarm event or when you start to drive the car.

6.29.2 Cancel: Send “sleep+password+space+off”, tracker will reply “sleep off ok”, tracker won't sleep, WCDMA/GSM and GPS works all the time.

6.30 Check the Vehicle State

Send SMS command “check+password” to the tracker device in the vehicle, It will reply the status of the power, battery, GPS, ACC, door, WCDMA/GSM signal, GPRS status ,oil, APN, UP, IP and Port.

For example: Send SMS “check123456” to the tracker device in the vehicle, It will reply following SMS.

Power: ON/OFF

Bat: 100%

GPRS: ON/OFF

GPS: ON/NO GPS

ACC: OFF/ON

Door: OFF/ON

WCDMA/GSM Signal: 1-32 The higher, the better.

Oil: 100%

APN: cmnet,;

IP: 104.250.138.146/dns:9000

Arm: OFF/ON

6.31 Check IMEI

Send SMS command "imei+password" to the device. E.g: Send SMS command "imei123456" to the tracker device, it will reply an IMEI number in 15 digits to your cell phone.

6.32 Terminal (local) Time Setting

6.32.1 Send SMS command “time+space+zone+password+space+time” to the device, If succeed, it will reply “time OK”

6.32.2 For example: Send SMS “time zone123456 8”, 8 is Chinese time zone, If your country time zone is minus, send SMS “time zone123456 -8”.

6.33 Reset Hardware

Send SMS “reset+password” to tracker device to reset the WCDMA/GSM module and GPS module of the tracker device, it will reply “reset ok”.

6.34 Configure parameters by USB

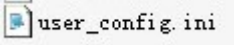
Connect tracker to computer with the optional USB cable, open the memory of the tracker, find the initial configuration file, copy to your PC and open it with notepad , then operate according to the instructions and save it, copy back to memory to overwrite it and it will take effect immediately.

Note: Correct password is needed every time you configure the tracker.

6.35 GPRS Setting

User must send SMS via cell phone to set up APN, IP and port before starting tracking by GPRS.

6.35.1 Configure APN

APN standards for Access Point Name of WCDMA/GSM network, it differs from country to country. For more information about your local APN, please inquire with your local GPRS network operator.

Send a SMS command to tracker “APN+password + Space + your local APN” via a cell phone and if succeeded, the tracker will reply “APN OK”.

For example: Send SMS command “APN123456 CMNET”. If succeeded, the tracker will reply “APN OK”.

Notes: 123456 refer to password of tracker and CMNET is the APN of one of china GPRS Network Operator (China mobile).

6.35.2 GPRS User Name and password Setup

6.35.2.1 In most countries, the user name and password involving GPRS login are not compulsorily necessary, therefore, the entry can be skipped. As for those countries require user name and password, please configure as following:

6.35.2.2 Send SMS “up+password+space+user+space+password” If succeeded, the tracker will reply “user, password ok!”

6.35.2.3 For instance, send SMS “up123456 web webgprs” to the tracker, and if succeeded, tracker will reply “user, password OK”

Note: 123456 is password for the tracker, web is the user name for GPRS login, webgprs is the password for GPRS login.

6.35.3 IP and Port Setup

6.35.3.1 Send SMS as below via a cell phone: “adminip+password+Space+IP (or DNS) Address+Space+Port Number”. If succeeded, tracker will reply “adminip OK”.

6.35.3.2 For example: Send SMS command “adminip123456 04.gpstrackerxy.com 9000” to the tracker, If succeeded, it will reply “adminip OK”. (123456 is default password, 04.gpstrackerxy.com is DNS, 9000 is port).

6.35.4 Switch to GPRS mode

6.35.4.1 The default mode is “SMS”, Send SMS “GPRS+password” to the tracker, and it will reply “GPRS ok!” it means the tracker has switched to “GPRS” mode.

6.35.4.2 TCP and UDP switch

Command: "gprs+password,0,0" switch to TCP mode, this is the default mode.

Command:"gprs+password,1,1" switch to UDP mode.

6.35.4.3 Send SMS “SMS+password” to the tracker, and it will reply “SMS ok!” and restore to “SMS” mode.

6.36 Activate "Fuel" value in GPRS data

The default format of GPRS data doesn't include "Fuel" value, if you need "Fuel" value, please send “protocol+password 18” to tracker, if succeed, it will reply "protocol 18 ok"; send “protocol+password 12” to change back to default mode, if succeed, it will reply "protocol 12 ok".

6.37 Instructions for web platform and mobile APP

Users need to register an account on www.gpstrackerxy.com before use web or APP platform, account name and password is the same on web/APP platform

6.37.1 register an account

SERVER 1
IP: 202.104.150.75 PORT: 9000

SERVER 2
IP: 202.104.149.227 PORT: 9000

SERVER 3
IP: 104.250.138.146 PORT: 9000

SERVER 4
IP: 67.229.77.202 PORT: 9000

Please input IMEI to verify.

For IOS
Search "TrackerHome" in App Store.

For Android
For Android, pls click "download" or scan the QR code to download the APK file to android phone to install it.

1、choose the right server to login in

Validate your IMEI is valid or not

Download Download

SERVER 3
IP: 104.250.138.146 PORT: 9000

User ID:

Password:

Password Confirmation:

Terminal IMEI:

Remember my user ID and password

3、Click "register". Pop-up a dialog box, register an account

6.37.2 Login

SERVER 3
IP: 104.250.138.146 PORT: 9000

4、Input the newly registered user ID and password,

User ID

Password

Remember my user ID and password

6.37.3 Add a terminal

TrackerHome [English]

Terminal List Terminal Control Route Repeat Manual Track Reports System Settings Notice Quit System

Terminal Management 2:31

- Group Management
- Account Management
- Change Password

5. add terminal

Name	Date & Time	Description	Speed	Altitude	Oil1	Oil2	°C	ACC	Door	LBS	Latitude	Longitude
Demo	2015-04-16 08:27:01	Position info	0km/h	0.0m	0.0%	0.0%	0	Off	Close	No	22.586680	113.907718
Demo	2015-04-16 08:28:56	Geo fence had been clear.	0km/h	0.0m	0.0%	0.0%	0	Off	Close	No	22.586225	113.907945
Demo	2015-04-16 08:20:56	Position info	0km/h	0.0m	0.0%	0.0%	0	Off	Close	No	22.586225	113.907945
Demo	2015-04-16 08:20:37	Position info	0km/h	0.0m	0.0%	0.0%	0	Off	Close	No	22.586225	113.907945

6. add terminal

Expiry Date From 1900-01-01 To 9998-12-31 IMEI NO. Keyword: Search Add Delete Quit

IMEI NO.	Name	Icon	Model	Group Name	Expiry Date
		Car	All Functions		

7. enter IMEI

8. name

9. choose location icon

10. save

Terminal List Terminal Control

Terminal List

(Online:0 Offline:1)

demo

11. the newly registered device is offline in grey color

6.37.4 Configure your tracker to web platform to track it online

step 1: set APN, refer to 6.35.1

Step 2: set GPRS user name and password, refer to 6.35.2

Step 3: set IP and port, please use the corresponding IP and port of the server you choose, refer to 6.35.3

Step 4: switch to GPRS mode, refer to 6.35.4

Terminal List Terminal Control

Terminal List

(Online:1 Offline:0)

demo

12. After receiving GPRS OK, wait about one minute, tracker will be online in green color, you can operate the tracker,

1.37. If the tracker is always offline (grey color), make sure the SIM card subscribe the GPRS service, and have money to surf the Internet, you can use phone to test the sim card can surf the Internet or not please check the APN, user name, password, IP, port settings are correct, refer to 6.30.

2.37. IOS & Android mobile APP

6.38.6.1 Download and install the mobile APP software

According to your phone type, download and install mobile app below the home page on web tracking platform

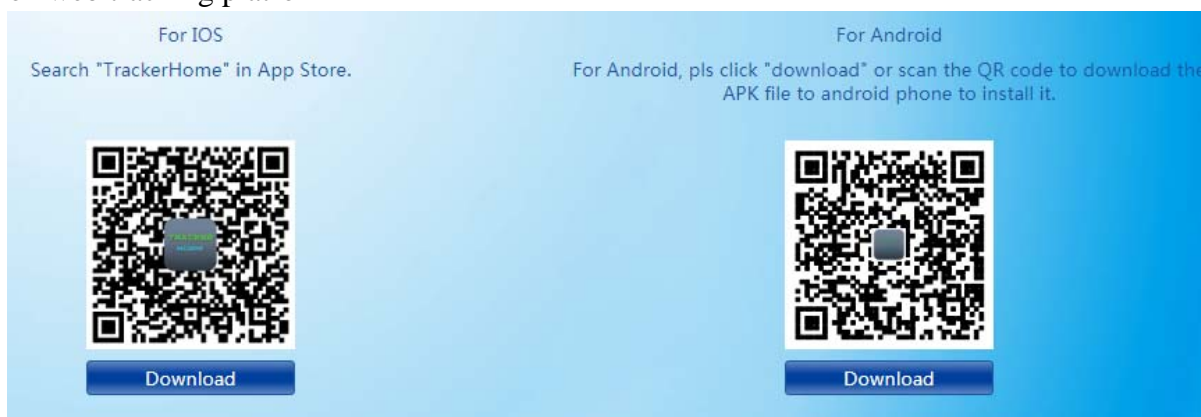

6.38.6.2 Login in and use the mobile APP under GPRS version

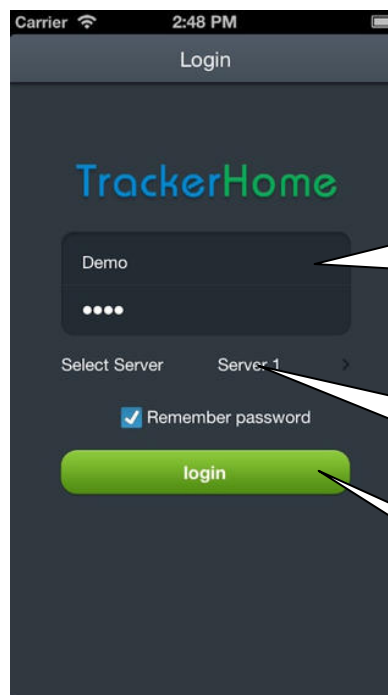
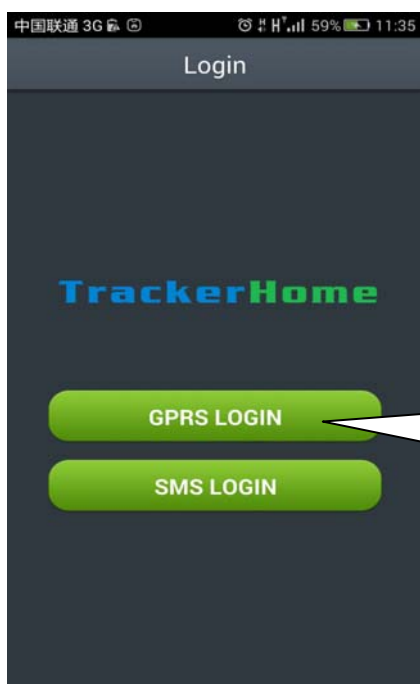



6.38.6.3 login in and use the mobile APP under SMS version

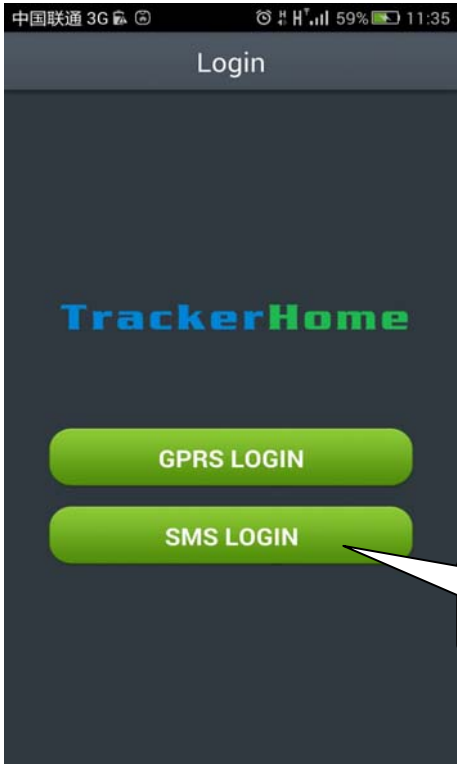

1. Choose SMS LOGIN



2. Use "mc" as the initial user ID, password is 8888, change the user name and password after entry

3. Click "login"

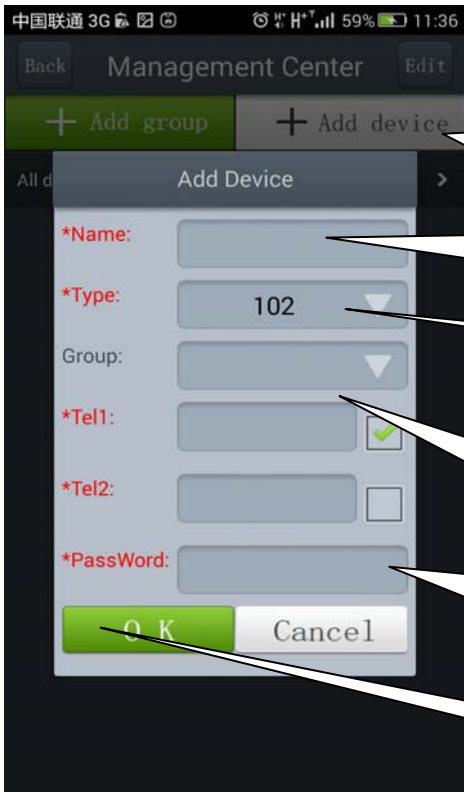

4. Choose "add device"

5. Filling the device name

6. Choose the type

7. Filling the phone number of device

8. Filling the tracker's password

9. Click "ok"

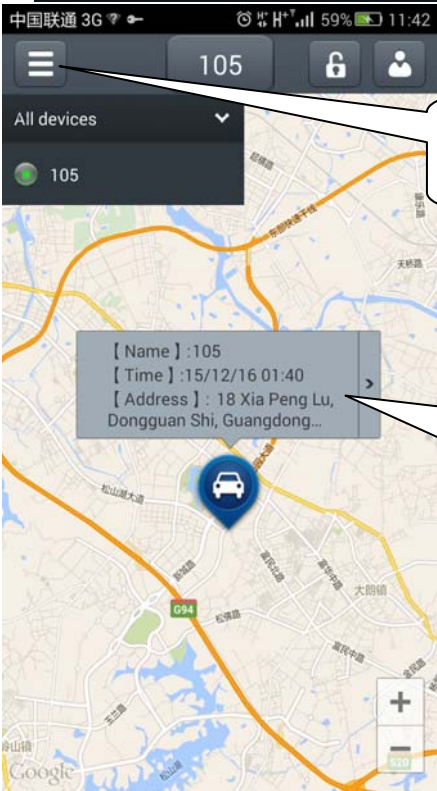

10. Click the icon, and display the list

11. Click here to operate the device

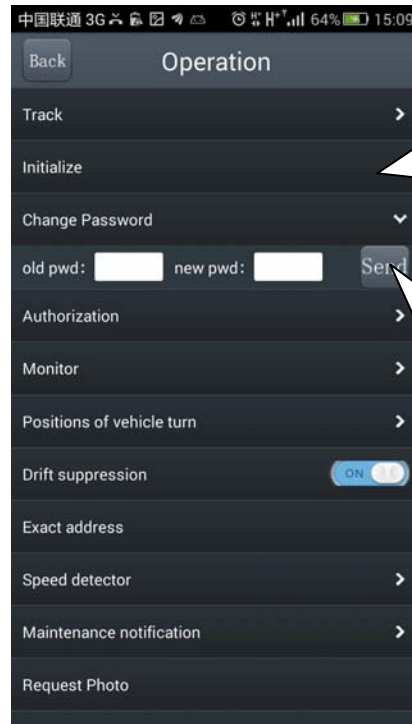
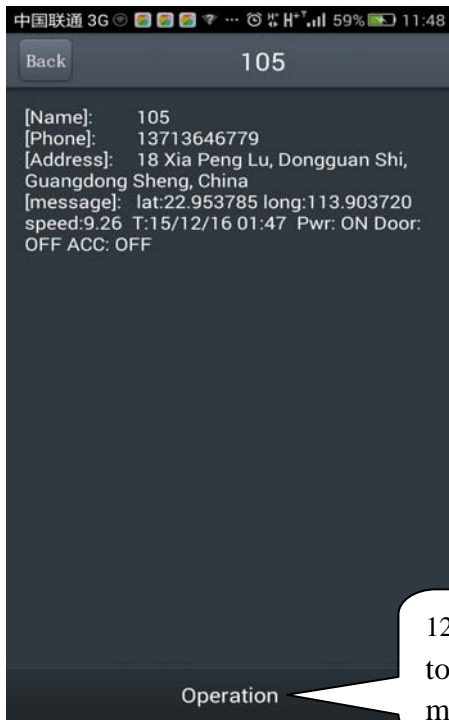

Remarks: "SMS login" version on Android phone can track the positions and show alarm on the map; but "SMS login" version on IOS can only send commands due to the confined policy, it cannot track the positions and show alarm on the map.

7. Cautions

Please comply with the instructions to extend the unit life:

1. Keep the unit dry. Any liquid, i.e. rain, moisture, may destroy or damage the inside circuitry.
2. Don't use & store the unit in dusty places.
3. Don't put the unit in overheated or overcooled places.
4. Handle carefully. Don't vibrate or shake it violently.
5. Clear the unit with a piece of dry cloth. Don't clean in chemicals, detergent.
6. Don't paint the unit, this may cause some foreign materials left in between the parts.
7. Don't disassemble or refit the unit.
8. Please read the user manual carefully before installation and operation, learn something more about the voltage range. Otherwise, it won't work properly or destroy the product.

8. Faults & the Solutions

Faults	Solution
Fail to turn it on	Please check if built-in battery is charged, and power wires connected well.
No WCDMA / GSM signal	<ul style="list-style-type: none">● Please check if SIM card installed correctly.● Please check if SIM card is WCDMA/GSM network.● Don't turn on the PIN code● no calls can be diverted● Please check if voltage of the power is normal
No GPS	Please check if GPS antenna connected well, and recommend GPS antenna be installed near the window glass, no metal parts can cover it to make sure better GPS signal reception.
No reply to SMS command	Password wrong or the format is wrong.
No reply to calling	Authorized / admin phone number is incorrect
No alarm message	Authorized / admin phone number has not setup

FCC STATEMENT

This device complies with Part 15 of the FCC Rules. Operation is subject to the condition that this device does not cause harmful interference.

This equipment has been tested and found to comply with the limits for a Class B digital device, pursuant to part 15 of the FCC Rules. These limits are designed to provide reasonable protection against harmful interference in a residential installation. This equipment generates, uses and can radiate radio frequency energy and, if not installed and used in accordance with the instructions, may cause harmful interference to radio communications. However, there is no guarantee that interference will not occur in a particular installation. If this equipment does cause harmful interference to radio or television reception, which can be determined by turning the equipment off and on, the user is encouraged to try to correct the interference by one or more of the following measures:

- Reorient or relocate the receiving antenna.
- Increase the separation between the equipment and receiver.
- Connect the equipment into an outlet on a circuit different from that to which the receiver is connected.
- Consult the dealer or an experienced radio/ TV technician for help.

FCC Radiation Exposure Statement:

This equipment complies with FCC radiation exposure limits set forth for an uncontrolled environment. In order to avoid the possibility of exceeding the FCC radio frequency exposure limits, Human proximity to the antenna shall not be less than 20cm (8 inches) during normal operation